

Chapter 1

METHODS AND TECHNIQUES OF COMPLEX SYSTEMS SCIENCE: AN OVERVIEW

Cosma Rohilla Shalizi

Center for the Study of Complex Systems, University of Michigan, Ann Arbor, MI 48109 USA

cshalizi@umich.edu

Abstract In this chapter, I review the main methods and techniques of complex systems science. As a first step, I distinguish among the broad patterns which recur across complex systems, the topics complex systems science commonly studies, the tools employed, and the foundational science of complex systems. The focus of this chapter is overwhelmingly on the third heading, that of tools. These in turn divide, roughly, into tools for analyzing data, tools for constructing and evaluating models, and tools for measuring complexity. I discuss the principles of statistical learning and model selection; time series analysis; cellular automata; agent-based models; the evaluation of complex-systems models; information theory; and ways of measuring complexity. Throughout, I give only rough outlines of techniques, so that readers, confronted with new problems, will have a sense of which ones might be suitable, and which ones definitely are not.

1. Introduction

A complex system, roughly speaking, is one with many parts, whose behaviors are both highly variable and strongly dependent on the behavior of the other parts. Clearly, this includes a large fraction of the universe! Nonetheless, it is not vacuously all-embracing: it excludes both systems whose parts just cannot do very much, and those whose parts are really independent of each other. “Complex systems science” is the field whose ambition is to understand complex systems. Of course, this is a broad endeavor, overlapping with many even larger, better-established scientific fields. Having been asked by the editors to describe its meth-

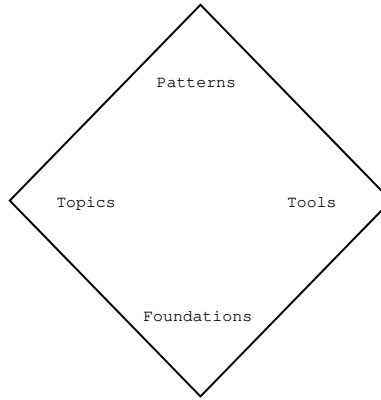

Figure 1.1. The quadrangle of complex systems. See text.

ods and techniques, I begin by explaining what I feel does *not* fall within my charge, as indicated by Figure 1.1.

At the top of Figure 1.1 I have put “patterns”. By this I mean more or less what people in software engineering do [1]: a pattern is a recurring theme in the analysis of many different systems, a cross-systemic regularity. For instance: bacterial chemotaxis can be thought of as a way of resolving the tension between the exploitation of known resources, and costly exploration for new, potentially more valuable, resources (Figure 1.2). This same tension is present in a vast range of adaptive systems. Whether the exploration-exploitation trade-off arises among artificial agents, human decision-makers or colonial organisms, many of the issues are the same as in chemotaxis, and solutions and methods of investigation that apply in one case can profitably be tried in another [2, 3]. The pattern “trade-off between exploitation and exploration” thus serves to orient us to broad features of novel situations. There are many other such patterns in complex systems science: “stability through hierarchically structured interactions” [4], “positive feedback leading to highly skewed outcomes” [5], “local inhibition and long-rate activation create spatial patterns” [6], and so forth.

At the bottom of the quadrangle is “foundations”, meaning attempts to build a basic, mathematical science concerned with such topics as the measurement of complexity [10], the nature of organization [11], the relationship between physical processes and information and computation [12] and the origins of complexity in nature and its increase (or decrease) over time. There is dispute whether such a science is possible, if so whether it would be profitable. I think it is both possible and use-

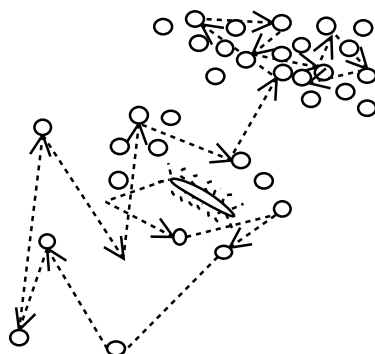

Figure 1.2. Bacterial chemotaxis. Should the bacterium (center) exploit the currently-available patch of food, or explore, in hopes of finding richer patches elsewhere (e.g. at right)? Many species solve this problem by performing a random walk (jagged line), tumbling randomly every so often. The frequency of tumbling increases when the concentration of nutrients is high, making the bacterium take long steps in resource-poor regions, and persist in resource-rich ones [7–9].

ful, but most of what has been done in this area is very far from being applicable to *biomedical* research. Accordingly, I shall pass it over, with the exception of a brief discussion of some work on measuring complexity and organization which is especially closely tied to data analysis.

“Topics” go in the left-hand corner. Here are what one might call the “canonical complex systems”, the particular systems, natural, artificial and fictional, which complex systems science has traditionally and habitually sought to understand. Here we find networks (Wuchty, Ravasz and Barabási, this volume), turbulence [13], physio-chemical pattern formation and biological morphogenesis [14, 15], genetic algorithms [16, 17], evolutionary dynamics [18, 19], spin glasses [20, 21], neuronal networks (see Part III, 4, this book), the immune system (see Part III, 5, this book), social insects, ant-like robotic systems, the evolution of cooperation, evolutionary economics, etc.¹ These topics all fall within our initial definition of “complexity”, though whether they are studied together because of deep connections, or because of historical accidents and tradition, is a difficult question. In any event, this chapter will *not* describe the facts and particular models relevant to these topics.

Instead, this chapter is about the right-hand corner, “tools”. Some are procedures for analyzing data, some are for constructing and evaluating models, and some are for measuring the complexity of data or models. In this chapter I will restrict myself to methods which are generally accepted as valid (if not always widely applied), *and* seem promising for

biomedical research. These still demand a book, if not an encyclopedia, rather than a mere chapter! Accordingly, I will merely try to convey the essentials of the methods, with pointers to references for details. The goal is for you to have a sense of which methods would be good things to try on your problem, rather than to tell you everything you need to know to implement them.

1.1 Outline of This Chapter

As mentioned above, the techniques of complex systems science can, for our purposes, be divided into three parts: those for analyzing data (perhaps without reference to a particular model), those for building and understanding models (often without data), and those for measuring complexity as such. This chapter will examine them in that order.

The first part, on **data**, opens with the general ideas of **statistical learning and data mining** (§1.2), namely developments in statistics and machine learning theory that extend statistical methods beyond their traditional domain of low-dimensional, independent data. We then turn to **time series analysis** (§1.3), where there are two important streams of work, inspired by statistics and nonlinear dynamics.

The second part, on **modeling**, considers the most important and distinctive classes of models in complex systems. On the vital area of **nonlinear dynamics**, let the reader consult Socoloar (this volume). **Cellular automata** (§1.4) allow us to represent spatial dynamics in a way which is particularly suited to capturing strong local interactions, spatial heterogeneity, and large-scale aggregate patterns. Complementary to cellular automata are **agent-based models** (§1.5), perhaps the most distinctive and most famous kind of model in complex systems science. A general section (1.6) on **evaluating complex models**, including analytical methods, various sorts of simulation, and testing, closes this part of the chapter.

The third part of the chapter considers ways of measuring complexity. As a necessary preliminary, §1.7 introduces the concepts of **information theory**, with some remarks on its application to biological systems. Then §1.8 treats **complexity measures**, describing the main kinds of complexity measure, their relationships, and their applicability to empirical questions.

The chapter ends with a guide to further reading, organized by section. These emphasize readable and thorough introductions and surveys over more advanced or historically important contributions.

2. Statistical Learning and Data-Mining

Complex systems, we said, are those with many strongly interdependent parts. Thanks to comparatively recent developments in statistics and machine learning, it is now possible to infer reliable, predictive models from data, even when the data concern thousands of strongly dependent variables. Such **data mining** is now a routine part of many industries, and is increasingly important in research. While not, of course, a substitute for devising valid theoretical models, data mining *can* tell us what kinds of patterns are in the data, and so guide our model-building.

2.1 Prediction and Model Selection

The basic goal of any kind of data mining is prediction: some variables, let us call them X , are our inputs. The output is another variable or variables Y . We wish to use X to predict Y , or, more exactly, we wish to build a machine which will do the prediction for us: we will put in X at one end, and get a prediction for Y out at the other.²

“Prediction” here covers a lot of ground. If Y are simply other variables like X , we sometimes call the problem **regression**. If they are X at another time, we have **forecasting**, or prediction in a strict sense of the word. If Y indicates membership in some set of discrete categories, we have **classification**. Similarly, our predictions for Y can take the form of distinct, particular values (**point predictions**), of ranges or intervals we believe Y will fall into, or of entire probability distributions for Y , i.e., guesses as to the conditional distribution $\Pr(Y|X)$. One can get a point prediction from a distribution by finding its mean or mode, so distribution predictions are in a sense more complete, but they are also more computationally expensive to make, and harder to make successfully.

Whatever kind of prediction problem we are attempting, and with whatever kind of guesses we want our machine to make, we must be able to say whether or not they are good guesses; in fact we must be able to say just how much bad guesses cost us. That is, we need a **loss function** for predictions³. We suppose that our machine has a number of knobs and dials we can adjust, and we refer to these parameters, collectively, as θ . The predictions we make, with inputs X and parameters θ , are $f(X, \theta)$, and the loss from the error in these predictions, when the actual outputs are Y , is $L(Y, f(X, \theta))$. Given *particular* values y and x , we have the empirical loss $L(y, f(x, \theta))$, or $\hat{L}(\theta)$ for short⁴.

Now, a natural impulse at this point is to twist the knobs to make the loss small: that is, to select the θ which minimizes $\hat{L}(\theta)$; let’s write this $\hat{\theta} = \operatorname{argmin}_{\theta} \hat{L}(\theta)$. This procedure is sometimes called **empirical**

risk minimization, or ERM. (Of course, doing that minimization can itself be a tricky nonlinear problem, but I will not cover optimization methods here.) The problem with ERM is that the $\hat{\theta}$ we get from *this* data will almost surely not be the same as the one we'd get from the *next* set of data. What we really care about, if we think it through, is not the error on any particular set of data, but the error we can *expect* on new data, $\mathbf{E}[L(\theta)]$. The former, $\hat{L}(\theta)$, is called the **training** or **in-sample** or **empirical** error; the latter, $\mathbf{E}[L(\theta)]$, the **generalization** or **out-of-sample** or **true** error. The difference between in-sample and out-of-sample errors is due to sampling noise, the fact that our data are not *perfectly* representative of the system we're studying. There will be quirks in our data which are just due to chance, but if we minimize \hat{L} blindly, if we try to reproduce every feature of the data, we will be making a machine which reproduces the random quirks, which do not generalize, along with the predictive features. Think of the empirical error $\hat{L}(\theta)$ as the generalization error, $\mathbf{E}[L(\theta)]$, plus a sampling fluctuation, ϵ . If we look at machines with low empirical errors, we will pick out ones with low true errors, which is good, but we will also pick out ones with large negative sampling fluctuations, which is not good. Even if the sampling noise ϵ is very small, $\hat{\theta}$ can be very different from θ_{min} . We have what optimization theory calls an **ill-posed problem** [22].

Having a higher-than-optimal generalization error because we paid too much attention to our data is called **over-fitting**. Just as we are often better off if we tactfully ignore our friends' and neighbors' little faults, we want to ignore the unrepresentative blemishes of our sample. Much of the theory of data mining is about avoiding over-fitting. Three of the commonest forms of tact it has developed are, in order of sophistication, **cross-validation**, **regularization** (or **penalties**) and **capacity control**.

2.1.1 Validation. We would never over-fit if we *knew* how well our machine's predictions would generalize to new data. Since our data is never perfectly representative, we always have to estimate the generalization performance. The empirical error provides one estimate, but it's biased towards saying that the machine will do well (since we built it to do well on that data). If we had a second, independent set of data, we could evaluate our machine's predictions on it, and that would give us an unbiased estimate of its generalization. One way to do this is to take our original data and divide it, at random, into two parts, the **training set** and the **test set** or **validation set**. We then use the training set to fit the machine, and evaluate its performance on the test set. (This is an instance of **resampling** our data, which is a useful trick

in many contexts.) Because we’ve made sure the test set is independent of the training set, we get an unbiased estimate of the out-of-sample performance.

In **cross-validation**, we divide our data into random training and test sets many different ways, fit a different machine for each training set, and compare their performances on their test sets, taking the one with the best test-set performance. This re-introduces some bias — it could happen by chance that one test set reproduces the sampling quirks of its training set, favoring the model fit to the latter. But cross-validation generally *reduces* over-fitting, compared to simply minimizing the empirical error; it makes more *efficient* use of the data, though it cannot get rid of sampling noise altogether.

2.1.2 Regularization or Penalization. I said that the problem of minimizing the error is **ill-posed**, meaning that small changes in the errors can lead to big changes in the optimal parameters. A standard approach to ill-posed problems in optimization theory is called **regularization**. Rather than trying to minimize $\hat{L}(\theta)$ alone, we minimize

$$\hat{L}(\theta) + \lambda d(\theta) , \tag{1.1}$$

where $d(\theta)$ is a **regularizing** or **penalty** function. Remember that $\hat{L}(\theta) = \mathbf{E}[L(\theta)] + \epsilon$, where ϵ is the sampling noise. If the penalty term is well-designed, then the θ which minimizes

$$\mathbf{E}[L(\theta)] + \epsilon + \lambda d(\theta) \tag{1.2}$$

will be close to the θ which minimizes $\mathbf{E}[L(\theta)]$ — it will cancel out the effects of favorable fluctuations. As we acquire more and more data, $\epsilon \rightarrow 0$, so λ , too, goes to zero at an appropriate pace, the penalized solution will converge on the machine with the best possible generalization error.

How then should we design penalty functions? The more knobs and dials there are on our machine, the more opportunities we have to get into mischief by matching chance quirks in the data. If one machine with fifty knobs, and another fits the data just as well but has only a single knob, we should (the story goes) chose the latter — because it’s *less* flexible, the fact that it does well is a good indication that it will still do well in the future. There are thus many regularization methods which add a penalty proportional to the number of knobs, or, more formally, the number of parameters. These include the Akaike information criterion or AIC [23] and the Bayesian information criterion or BIC [24, 25]. Other methods penalized the “roughness” of a model, i.e., some measure of how much the prediction shifts with a small change

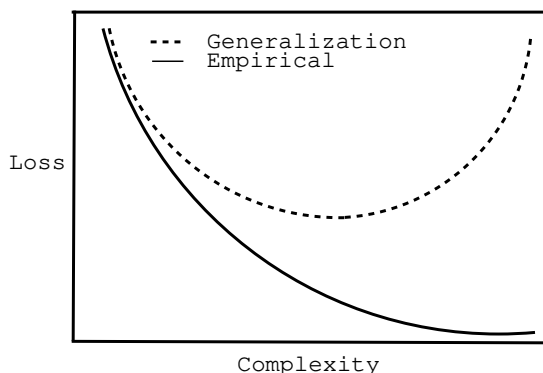

Figure 1.3. Empirical loss and generalization loss as a function of model complexity.

in either the input or the parameters [26, ch. 10]. A smooth function is less flexible, and so has less ability to match meaningless wiggles in the data. Another popular penalty method, the **minimum description length** principle of Rissanen, will be dealt with in §1.8.3 below.

Usually, regularization methods are justified by the idea that models can be more or less complex, and more complex ones are more liable to over-fit, all else being equal, so penalty terms should reflect complexity (Figure 1.3). There’s something to this idea, but the usual way of putting it does not really work; see §1.2.3 below.

2.1.3 Capacity Control. Empirical risk minimization, we said, is apt to over-fit because we do not know the generalization errors, just the empirical errors. This would not be such a problem if we could *guarantee* that the in-sample performance was close to the out-of-sample performance. Even if the exact machine we got this way was not particularly close to the optimal machine, we’d then be guaranteed that our *predictions* were nearly optimal. We do not even need to guarantee that *all* the empirical errors are close to their true values, just that the *smallest* empirical error is close to the smallest generalization error.

Recall that $\hat{L}(\theta) = \mathbf{E}[L(\theta)] + \epsilon$. It is natural to assume that as our sample size N becomes larger, our sampling error ϵ will approach zero. (We will return to this assumption below.) Suppose we could find a function $\eta(N)$ to bound our sampling error, such that $|\epsilon| \leq \eta(N)$. Then we could guarantee that our choice of model was **approximately correct**; if we wanted to be sure that our prediction errors were within

ϵ of the best possible, we would merely need to have $N(\epsilon) = \eta^{-1}(\epsilon)$ data-points.

It should not be surprising to learn that we cannot, generally, make approximately correct guarantees. As the eminent forensic statistician C. Chan remarked, “Improbable events permit themselves the luxury of occurring” [27], and one of these indulgences could make the discrepancy between $\hat{L}(\theta)$ and $\mathbf{E}[L(\theta)]$ very large. But if something like the law of large numbers holds, or the ergodic theorem (§1.3.2), then for every choice of θ ,

$$\Pr\left(\left|\hat{L}(\theta) - \mathbf{E}[L(\theta)]\right| > \epsilon\right) \rightarrow 0, \quad (1.3)$$

for every positive ϵ .⁵ We should be able to find some function δ such that

$$\Pr\left(\left|\hat{L}(\theta) - \mathbf{E}[L(\theta)]\right| > \epsilon\right) \leq \delta(N, \epsilon, \theta), \quad (1.4)$$

with $\lim_N \delta(N, \epsilon, \theta) = 0$. Then, for any particular θ , we could give **probably approximately correct** [28] guarantees, and say that, e.g., to have a 95% confidence that the true error is within 0.001 of the empirical error requires at least 144,000 samples (or whatever the precise numbers may be). If we can give probably approximately correct (PAC) guarantees on the performance of one machine, we can give them for any *finite* collection of machines. But if we have infinitely many possible machines, might not there always be *some* of them which are misbehaving? Can we still give PAC guarantees when θ is continuous?

The answer to this question depends on how flexible the set of machines is — its **capacity**. We need to know how easy it is to find a θ such that $f(X, \theta)$ will accommodate itself to any Y . This is measured by a quantity called the Vapnik-Chervonenkis (VC) dimension [22]⁶. If the VC dimension d of a class of machines is finite, one can make a PAC guarantee which applies to *all* machines in the class simultaneously:

$$\Pr\left(\max_{\theta} \left|\hat{L}(\theta) - \mathbf{E}[L(\theta)]\right| \geq \eta(N, d, \delta)\right) \leq \delta \quad (1.5)$$

where the function $\eta(N, d, \delta)$ expresses the rate of convergence. It depends on the particular kind of loss function involved. For example, for binary classification, if the loss function is the fraction of inputs misclassified,

$$\eta(N, d, \delta) = \frac{1}{\sqrt{N}} \sqrt{\left(d\left(1 + \ln \frac{2N}{d}\right) + \ln \frac{4}{\delta}\right)} \quad (1.6)$$

Notice that θ is not an argument to η , and does not appear in (1.6). The rate of convergence is the same across all machines; this kind of result is thus called a **uniform law of large numbers**. The really remarkable thing about (1.5) is that it holds no matter what the sampling distribution is, so long as samples are independent; it is a **distribution-free** result.

The VC bounds lead to a very nice learning scheme: simply apply empirical risk minimization, for a fixed class of machines, and then give a PAC guarantee that the one picked is, with high reliability, very close to the actual optimal machine. The VC bounds also lead an appealing penalization scheme, where the penalty is equal to our bound on the over-fitting, η . Specifically, we set the $\lambda d(\theta)$ term in (1.1) equal to the η in (1.5), ensuring, with high probability, that the ϵ and $\lambda d(\theta)$ terms in (1.2) cancel each other. This is **structural risk minimization** (SRM).

It's important to realize that the VC dimension is not the same as the number of parameters. For some classes of functions, it is much *lower* than the number of parameters, and for others it's much *higher*. (There are examples of one-parameter classes of functions with infinite VC dimension.) Determining the VC dimension often involves subtle combinatorial arguments, but many results are now available in the literature, and more are appearing all the time. There are even schemes for experimentally estimating the VC dimension [29].

Two caveats are in order. First, because the VC bounds are distribution-free, they are really about the rate of convergence under the worst possible distribution, the one a malicious Adversary out to foil our data mining would choose. This means that in practice, convergence is often much faster than (1.5) would indicate. Second, the usual proofs of the VC bounds all assume independent, identically-distributed samples, though the relationship between X and Y can involve arbitrarily complicated dependencies⁷. Recently, there has been much progress in proving uniform laws of large numbers for dependent sequences of samples, and structural risk minimization has been extended to what are called “mixing” processes [30], in effect including an extra term in the *eta* function appearing in (1.5) which discounts the number of observations by their degree of mutual dependence.

2.2 Choice of Architecture

The basic idea of data mining is to fit a model to data with minimal assumptions about what the correct model should be, or how the variables in the data are related. (This differs from such classical statistical questions as testing *specific* hypotheses about specific models,

such as the presence of interactions between certain variables.) This is facilitated by the development of extremely flexible classes of models, which are sometimes, misleadingly, called **non-parametric**; a better name would be **megaparametric**. The idea behind megaparametric models is that they should be capable of approximating any function, at least any well-behaved function, to any desired accuracy, given enough capacity.

The polynomials are a familiar example of a class of functions which can perform such universal approximation. Given any smooth function f , we can represent it by taking the Taylor series around our favorite point x_0 . Truncating that series gives an approximation to f :

$$f(x) = f(x_0) + \sum_{k=1}^{\infty} \frac{(x-x_0)^k}{k!} \left. \frac{d^k f}{dx^k} \right|_{x_0} \quad (1.7)$$

$$\approx f(x_0) + \sum_{k=1}^n \frac{(x-x_0)^k}{k!} \left. \frac{d^k f}{dx^k} \right|_{x_0} \quad (1.8)$$

$$= \sum_{k=0}^n a_k \frac{(x-x_0)^k}{k!} \quad (1.9)$$

In fact, if f is an n^{th} order polynomial, the truncated series is exact, not an approximation.

To see why this is *not* a reason to use only polynomial models, think about what would happen if $f(x) = \sin x$. We would need an *infinite* order polynomial to completely represent f , and the generalization properties of finite-order approximations would generally be lousy: for one thing, f is bounded between -1 and 1 everywhere, but any finite-order polynomial will start to zoom off to ∞ or $-\infty$ outside some range. Of course, this f would be really easy to approximate as a superposition of sines and cosines, which is another class of functions which is capable of universal approximation (better known, perhaps, as Fourier analysis). What one wants, naturally, is to choose a model class which gives a good approximation of the function at hand, *at low order*. We want low order functions, both because computational demands rise with model order, *and* because higher order models are more prone to over-fitting (VC dimension generally rises with model order).

To adequately describe all of the *common* model classes, or **model architectures**, used in the data mining literature would require another chapter. ([31] and [32] are good for this.) Instead, I will merely name a few.

- **Splines** are piecewise polynomials, good for regression on bounded domains; there is a very elegant theory for their estimation [33].

- **Neural networks** or **multilayer perceptrons** have a devoted following, both for regression and classification [32]. The application of VC theory to them is quite well-advanced [34, 35], but there are many other approaches, including ones based on statistical mechanics [36]. It is notoriously hard to understand *why* they make the predictions they do.

- **Classification and regression trees** (CART), introduced in the book of that name [37], recursively sub-divide the input space, rather like the game of “twenty questions” (“Is the temperature above 20 centigrade? If so, is the glucose concentration above one millimole?”, etc.); each question is a branch of the tree. All the cases at the end of one branch of the tree are treated equivalently. The resulting decision trees are easy to understand, and often similar to human decision heuristics [38].

- **Kernel machines** [22, 39] apply nonlinear transformations to the input, mapping it to a much higher dimensional “feature space”, where they apply linear prediction methods. The trick works because the VC dimension of linear methods is low, even in high-dimensional spaces. Kernel methods come in many flavors, of which the most popular, currently, are **support vector machines** [40].

2.2.1 Predictive versus Causal Models. Predictive and descriptive models both are not necessarily causal. PAC-type results give us reliable prediction, *assuming* future data will come from the *same* distribution as the past. In a causal model, however, we want to know how *changes* will propagate through the system. One difficulty is that these relationships are one-way, whereas prediction is two-way (one can predict genetic variants from metabolic rates, but one cannot change genes by changing metabolism). The other is that it is hard (if not impossible) to tell if the predictive relationships we have found are **confounded** by the influence of other variables and other relationships we have neglected. Despite these difficulties, the subject of **causal inference** from data is currently a very active area of research, and many methods have been proposed, generally under assumptions about the absence of feedback [41–43]. When we have a causal or generative model, we can use very well-established techniques to infer the values of the hidden or latent variables in the model from the values of their observed effects [41, 44].

2.3 Occam's Razor and Complexity in Prediction

Often, regularization methods are thought to be penalizing the *complexity* of the model, and so implementing some version of Occam's Razor. Just as Occam said "entities are not to be multiplied beyond necessity"⁸, we say "parameters should not be multiplied beyond necessity", or, "the model should be no rougher than necessary". This takes complexity to be a property of an *individual* model, and the hope is that a simple model which can predict the training data will also be able to predict new data. Now, under many circumstances, one can prove that, as the size of the sample approaches infinity, regularization will converge on the correct model, the one with the best generalization performance [26]. But one can often prove exactly the same thing about ERM without any regularization or penalization at all; this is what the VC bounds (1.5) accomplish. While regularization methods often do well in practice, so, too, does straight ERM. If we compare the performance of regularization methods to straight empirical error minimization on artificial examples, where we can calculate the generalization performance exactly, regularization conveys *no clear advantage at all* [45].

Contrast this with what happens in structural risk minimization. There our complexity penalty depends solely on the VC dimension of the *class* of models we're using. A simple, inflexible model which we find only because we're looking at a complex, flexible class is penalized just as much as the most wiggly member of that class. Experimentally, SRM *does* work better than simple ERM, or than traditional penalization methods.

A simple example may help illuminate why this is so. Suppose we're interested in binary classification, and we find a machine θ which correctly classifies a million independent data points. If the real error rate (= generalization error) for θ was one in a hundred thousand, the chance that it would correctly classify a million data points would be $(0.99999)^{10^6} \approx 4.5 \cdot 10^{-5}$. If θ was the very first parameter setting we checked, we could be quite confident that its true error rate was much less than 10^{-5} , no matter how complicated the function $f(X, \theta)$ looked. But if we've looked at ten million parameter settings before finding θ , then the odds are quite good that, among the machines with an error rate of 10^{-5} , we'd find several which correctly classify all the points in the training set, so the fact that θ does is not good evidence that it's the best machine⁹. What matters is not how much algebra is involved in making the predictions once we've chosen θ , but how many alternatives to θ we've tried out and rejected. The VC dimension lets us apply this

kind of reasoning rigorously and without needing to know the details of the process by which we generate and evaluate models.

The upshot is that the kind of complexity which matters for learning, and so for Occam’s Razor, is the complexity of *classes of models*, not of individual models nor of the system being modeled. It is important to keep this point in mind when we try to measure the complexity of systems (§1.8).

2.4 Relation of Complex Systems Science to Statistics

Complex systems scientists often regard the field of statistics as irrelevant to understanding such systems. This is understandable, since the exposure most scientists have to statistics (e.g., the “research methods” courses traditional in the life and social sciences) typically deal with systems with only a few variables and with explicit assumptions of independence, or only very weak dependence. The kind of modern methods we have just seen, amenable to large systems and strong dependence, are rarely taught in such courses, or even mentioned. Considering the shaky grasp many students have on even the basic principles of statistical inference, this is perhaps wise. Still, it leads to even quite eminent researchers in complexity making disparaging remarks about statistics (e.g., “statistical hypothesis testing, that substitute for thought”), while actually re-inventing tools and concepts which have long been familiar to statisticians.

For their part, many statisticians tend to overlook the very *existence* of complex systems science as a separate discipline. One may hope that the increasing interest from both fields on topics such as bioinformatics and networks will lead to greater mutual appreciation.

3. Time Series Analysis

There are two main schools of time series analysis. The older one, which has a long pedigree in applied statistics [46], and is prevalent among statisticians, social scientists (especially econometricians) and engineers. The younger school, developed essentially since the 1970s, comes out of physics and nonlinear dynamics. The first views time series as samples from a stochastic process, and applies a mixture of traditional statistical tools and assumptions (linear regression, the properties of Gaussian distributions) and the analysis of the Fourier spectrum. The second school views time series as distorted or noisy measurements of an underlying dynamical system, which it aims to reconstruct.

The separation between the two schools is in part due to the fact that, when statistical methods for time series analysis were first being formalized, in the 1920s and 1930s, dynamical systems theory was literally just beginning. The real development of nonlinear dynamics into a powerful discipline has mostly taken place since the 1960s, by which point the statistical theory had acquired a research agenda with a lot of momentum. In turn, many of the physicists involved in experimental nonlinear dynamics in the 1980s and early 1990s were fairly cavalier about statistical issues, and some happily reported results which should have been left in their file-drawers.

There are welcome signs, however, that the two streams of thought are coalescing. Since the 1960s, statisticians have increasingly come to realize the virtues of what they call “state-space models”, which are just what the physicists have in mind with their dynamical systems. The physicists, in turn, have become more sensitive to statistical issues, and there is even now some cross-disciplinary work. In this section, I will try, so far as possible, to use the state-space idea as a common framework to present both sets of methods.

3.1 The State-Space Picture

A vector-valued function of time, x_t , the **state**. In discrete time, this evolves according to some map,

$$x_{t+1} \equiv F(x_t, t, \epsilon_t) \quad (1.10)$$

where the map F is allowed to depend on time t and a sequence of independent random variables ϵ_t . In continuous time, we do not specify the evolution of the state directly, but rather the rates of change of the components of the state,

$$\frac{dx}{dt} \equiv F(x, t, \epsilon_t) \quad (1.11)$$

Since our data are generally taken in discrete time, I will restrict myself to considering that case from now on; almost everything carries over to continuous time naturally. The evolution of x is so to speak, self-contained, or more precisely Markovian: all the information needed to determine the future is contained in the *present* state x_t , and earlier states are irrelevant. (This is basically how physicists *define* “state” [47].) Indeed, it is often reasonable to assume that F is independent of time, so that the dynamics are **autonomous** (in the terminology of dynamics) or **homogeneous** (in that of statistics). If we could look at the series of states, then, we would find it had many properties which made it very convenient to analyze.

Sadly, however, we do not observe the state x ; what we observe or measure is y , which is generally a noisy, nonlinear function of the state: $y_t = h(x_t, \eta_t)$, where η_t is measurement noise. Whether y , too, has the convenient properties depends on h , and usually y is *not* convenient. Matters are made more complicated by the fact that we do not, in typical cases, know the observation function h , nor the state-dynamics F , nor even, really, what space x lives in. The goal of time-series methods is to make educated guess about all these things, so as to better predict and understand the evolution of temporal data.

In the ideal case, simply from a knowledge of y , we would be able to identify the state space, the dynamics, and the observation function. As a matter of pure mathematical possibility, this can be done for essentially arbitrary time-series [48, 49]. Nobody, however, knows how to do this with complete generality in practice. Rather, one makes certain assumptions about, say, the state space, which are strong enough that the remaining details can be filled in using y . Then one checks the result for accuracy and plausibility, i.e., for the kinds of errors which would result from breaking those assumptions [50].

Subsequent parts of this section describe classes of such methods. First, however, I describe some of the general properties of time series, and general measurements which can be made upon them.

Notation. There is no completely uniform notation for time-series. Since it will be convenient to refer to sequences of consecutive values. I will write all the measurements starting at s and ending at t as y_s^t . Further, I will abbreviate the set of all measurements up to time t , $y_{-\infty}^t$, as y_t^- , and the future starting from t , y_{t+1}^∞ , as y_t^+ .

3.2 General Properties of Time Series

One of the most commonly assumed properties of a time-series is **stationarity**, which comes in two forms: **strong** or **strict** stationarity, and **weak, wide-sense** or *second-order* stationarity. Strong stationarity is the property that the probability distribution of sequences of observations does not change over time. That is,

$$\Pr(Y_t^{t+h}) = \Pr(Y_{t+\tau}^{t+\tau+h}) \quad (1.12)$$

for all lengths of time h and all shifts forwards or backwards in time τ . When a series is described as “stationary” without qualification, it depends on context whether strong or weak stationarity is meant.

Weak stationarity, on the other hand, is the property that the first and second moments of the distribution do not change over time.

$$\mathbf{E}[Y_t] = \mathbf{E}[Y_{t+\tau}] \quad (1.13)$$

$$\mathbf{E}[Y_t Y_{t+h}] = \mathbf{E}[Y_{t+\tau} Y_{t+\tau+h}] \quad (1.14)$$

If Y is a Gaussian process, then the two senses of stationarity are equivalent. Note that both sorts of stationarity are statements about the true distribution, and so cannot be simply read off from measurements.

Strong stationarity implies a property called **ergodicity**, which is much more generally applicable. Roughly speaking, a series is ergodic if any sufficiently long sample is representative of the entire process. More exactly, consider the **time-average** of a well-behaved function f of Y ,

$$\langle f \rangle_{t_1}^{t_2} \equiv \frac{1}{t_2 - t_1} \sum_{t=t_1}^{t=t_2} f(Y_t) . \quad (1.15)$$

This is generally a random quantity, since it depends on where the trajectory started at t_1 , and any random motion which may have taken place between then and t_2 . Its distribution generally depends on the precise values of t_1 and t_2 . The series Y is ergodic if almost all time-averages converge eventually, i.e., if

$$\lim_{T \rightarrow \infty} \langle f \rangle_t^{t+T} = \bar{f} \quad (1.16)$$

for some constant \bar{f} independent of the starting time t , the starting point Y_t , or the trajectory Y_t^∞ . **Ergodic theorems** specify conditions under which ergodicity holds; surprisingly, even completely deterministic dynamical systems can be ergodic.

Ergodicity is such an important property because it means that statistical methods are very directly applicable. Simply by waiting long enough, one can obtain an estimate of any desired property which will be closely representative of the future of the process. Statistical inference *is* possible for non-ergodic processes, but it is considerably more difficult, and often requires multiple time-series [51, 52].

One of the most basic means of studying a time series is to compute the **autocorrelation function** (ACF), which measures the linear dependence between the values of the series at different points in time. This starts with the **autocovariance function**:

$$C(s, t) \equiv \mathbf{E}[(y_s - \mathbf{E}[y_s])(y_t - \mathbf{E}[y_t])] . \quad (1.17)$$

(Statistical physicists, unlike anyone else, call *this* the “correlation function”.) The autocorrelation itself is the autocovariance, normalized by

the variability of the series:

$$\rho(s, t) \equiv \frac{C(s, t)}{\sqrt{C(s, s)C(t, t)}} \quad (1.18)$$

ρ is ± 1 when y_s is a linear function of y_t . Note that the definition is symmetric, so $\rho(s, t) = \rho(t, s)$. For stationary or weakly-stationary processes, one can show that ρ depends only on the difference between τ and s . In this case one just writes $\rho(\tau)$, with one argument. $\rho(0) = 1$, always. The time t_c such that $\rho(t_c) = 1/e$ is called the **(auto)correlation time** of the series.

The correlation function is a **time-domain** property, since it is basically about the series considered as a sequence of values at distinct times. There are also **frequency-domain** properties, which depend on re-expressing the series as a sum of sines and cosines with definite frequencies. A function of time y has a Fourier transform which is a function of frequency, \tilde{y} .

$$\tilde{y} \equiv \mathcal{F}y \quad (1.19)$$

$$\tilde{y}_\nu = \sum_{t=1}^T e^{-i\frac{2\pi\nu t}{T}} y_t, \quad (1.20)$$

assuming the time series runs from $t = 1$ to $t = T$. (Rather than separating out the sine and cosine terms, it is easier to use the complex-number representation, via $e^{i\theta} = \cos \theta + i \sin \theta$.) The inverse Fourier transform recovers the original function:

$$y = \mathcal{F}^{-1}\tilde{y} \quad (1.21)$$

$$y_t = \frac{1}{T} \sum_{\nu=0}^{T-1} e^{i\frac{2\pi\nu t}{T}} \tilde{y}_\nu \quad (1.22)$$

The Fourier transform is a linear operator, in the sense that $\mathcal{F}(x + y) = \mathcal{F}x + \mathcal{F}y$. Moreover, it represents series we are interested in as a sum of trigonometric functions, which are themselves solutions to linear differential equations. These facts lead to extremely powerful frequency-domain techniques for studying linear systems. Of course, the Fourier transform is always *valid*, whether the system concerned is linear or not, and it may well be useful, though that is not guaranteed.

The squared absolute value of the Fourier transform, $f(\nu) = |\tilde{y}_\nu|^2$, is called the **spectral density** or **power spectrum**. For stationary processes, the power spectrum $f(\nu)$ is the Fourier transform of the auto-covariance function $C(\tau)$ (a result called the Wiener-Khinchin theorem).

An important consequence is that a Gaussian process is completely specified by its power spectrum. In particular, consider a sequence of independent Gaussian variables, each with variance σ^2 . Because they are perfectly uncorrelated, $C(0) = \sigma^2$, and $C(\tau) = 0$ for any $\tau \neq 0$. The Fourier transform of such a $C(\tau)$ is just $f(\nu) = \sigma^2$, independent of ν — every frequency has just as much power. Because white light has equal power in every color of the spectrum, such a process is called **white noise**. Correlated processes, with uneven power spectra, are sometimes called **colored noise**, and there is an elaborate terminology of red, pink, brown, etc. noises [53, ch. 3].

The easiest way to estimate the power spectrum is simply to take the Fourier transform of the time series, using, e.g., the fast Fourier transform algorithm [54]. Equivalently, one might calculate the autocovariance and Fourier transform that. Either way, one has an estimate of the spectrum which is called the **periodogram**. It is unbiased, in that the expected value of the periodogram at a given frequency is the true power at that frequency. Unfortunately, it is not consistent — the variance around the true value does not shrink as the series grows. The easiest way to overcome this is to apply any of several well-known smoothing functions to the periodogram, a procedure called **windowing** [55]. (Standard software packages will accomplish this automatically.)

The Fourier transform takes the original series and decomposes it into a sum of sines and cosines. This is possible because *any* reasonable function can be represented in this way. The trigonometric functions are thus a **basis** for the space of functions. There are many other possible bases, and one can equally well perform the same kind of decomposition in any other basis. The trigonometric basis is particularly useful for stationary time series because the basis functions are themselves evenly spread over all times [56, ch. 2]. Other bases, localized in time, are more convenient for non-stationary situations. The most well-known of these alternate bases, currently, are wavelets [57], but there is, literally, no counting the other possibilities.

3.3 The Traditional Statistical Approach

The traditional statistical approach to time series is to represent them through linear models of the kind familiar from applied statistics.

The most basic kind of model is that of a **moving average**, which is especially appropriate if x is highly correlated up to some lag, say q , after which the ACF decays rapidly. The moving average model represents x as the result of smoothing $q + 1$ independent random variables.

Specifically, the MA(q) model of a weakly stationary series is

$$y_t = \mu + w_t + \sum_{k=1}^q \theta_k w_{t-k} \quad (1.23)$$

where μ is the mean of y , the θ_i are constants and the w_t are white noise variables. q is called the **order** of the model. Note that there is no direct dependence between successive values of y ; they are all functions of the white noise series w . Note also that y_t and y_{t+q+1} are completely independent; after q time-steps, the effects of what happened at time t disappear.

Another basic model is that of an **autoregressive process**, where the next value of y is a linear combination of the preceding values of y . Specifically, an AR(p) model is

$$y_t = \alpha + \sum_{k=1}^p \phi_k y_{t-k} + w_t \quad (1.24)$$

where ϕ_i are constants and $\alpha = \mu(1 - \sum_{k=1}^p \phi_k)$. The order of the model, again is p . This is the multiple regression of applied statistics transposed directly on to time series, and is surprisingly effective. Here, unlike the moving average case, effects propagate indefinitely — changing y_t can affect all subsequent values of y . The remote past only becomes irrelevant if one controls for the last p values of the series. If the noise term w_t were absent, an AR(p) model would be a p^{th} order linear difference equation, the solution to which would be some combination of exponential growth, exponential decay and harmonic oscillation. With noise, they become oscillators under stochastic forcing [58].

The natural combination of the two types of model is the **autoregressive moving average model**, ARMA(p, q):

$$y_t = \alpha + \sum_{k=1}^p \phi_k y_{t-k} + w_t + \sum_{k=1}^q \theta_k w_{t-k} \quad (1.25)$$

This combines the oscillations of the AR models with the correlated driving noise of the MA models. An AR(p) model is the same as an ARMA($p, 0$) model, and likewise an MA(q) model is an ARMA($0, q$) model.

It is convenient, at this point in our exposition, to introduce the notion of the **back-shift operator** B ,

$$By_t = y_{t-1}, \quad (1.26)$$

and the **AR and MA polynomials**,

$$\phi(z) = 1 - \sum_{k=1}^p \phi_k z^k, \quad (1.27)$$

$$\theta(z) = 1 + \sum_{k=1}^q \theta_k z^k, \quad (1.28)$$

respectively. Then, formally speaking, in an ARMA process is

$$\phi(B)y_t = \theta(B)w_t. \quad (1.29)$$

The advantage of doing this is that one can determine many properties of an ARMA process by algebra on the polynomials. For instance, two important properties we want a model to have are **invertibility** and **causality**. We say that the model is invertible if the sequence of noise variables w_t can be determined uniquely from the observations y_t ; in this case we can write it as an MA(∞) model. This is possible just when $\theta(z)$ has no roots inside the unit circle. Similarly, we say the model is causal if it can be written as an AR(∞) model, without reference to any *future* values. When this is true, $\phi(z)$ also has no roots inside the unit circle.

If we have a causal, invertible ARMA model, with known parameters, we can work out the sequence of noise terms, or **innovations** w_t associated with our measured values y_t . Then, if we want to forecast what happens past the end of our series, we can simply extrapolate forward, getting predictions $\hat{y}_{T+1}, \hat{y}_{T+2}$, etc. Conversely, if we knew the innovation sequence, we could determine the parameters ϕ and θ . When both are unknown, as is the case when we want to fit a model, we need to determine them jointly [55]. In particular, a common procedure is to work forward through the data, trying to predict the value at each time on the basis of the past of the series; the sum of the squared differences between these predicted values \hat{y}_t and the actual ones y_t forms the empirical loss:

$$L = \sum_{i=1}^T (y_t - \hat{y}_t)^2 \quad (1.30)$$

For this loss function, in particular, there are very fast standard algorithms, and the estimates of ϕ and θ converge on their true values, provided one has the right model order.

This leads naturally to the question of how one determines the order of ARMA model to use, i.e., how one picks p and q . This is precisely a model selection task, as discussed in §1.2. All methods described there are potentially applicable; cross-validation and regularization are

more commonly used than capacity control. Many software packages will easily implement selection according to the AIC, for instance.

The power spectrum of an ARMA(p, q) process can be given in closed form:

$$f(\nu) = \frac{\sigma^2 (1 + \sum_{k=1}^q \theta_k e^{-i\nu k})^2}{2\pi (1 - \sum_{k=1}^p \phi_k e^{-i\nu k})^2} . \quad (1.31)$$

Thus, the parameters of an ARMA process can be estimated directly from the power spectrum, if you have a reliable estimate of the spectrum. Conversely, different hypotheses about the parameters can be checked from spectral data.

All ARMA models are weakly stationary; to apply them to non-stationary data one must transform the data so as to make it stationary. A common transformation is **differencing**, i.e., applying operations of the form

$$\nabla y_t = y_t - y_{t-1} , \quad (1.32)$$

which tends to eliminate regular trends. In terms of the back-shift operator,

$$\nabla y_t = (1 - B)y_t , \quad (1.33)$$

and higher-order differences are

$$\nabla^d y_t = (1 - B)^d y_t . \quad (1.34)$$

Having differenced the data to our satisfaction, say d times, we then fit an ARMA model to it. The result is an **autoregressive integrated moving average** model, ARIMA(p, d, q) [59], given by

$$\phi(B)(1 - B)^d y_t = \theta(B)w_t , \quad (1.35)$$

As mentioned above (§1.3.1), ARMA and ARIMA models can be recast in state space terms, so that our y is a noisy measurement of a hidden x [60]. For these models, both the dynamics and the observation functions are linear, that is, $x_{t+1} = \mathbf{A}x_t + \epsilon_t$ and $y_t = \mathbf{B}x_t + \eta_t$, for some matrices \mathbf{A} and \mathbf{B} . The matrices can be determined from the θ and ϕ parameters, though the relation is a bit too involved to give here.

3.3.1 Applicability of Linear Statistical Models. It is often possible to describe a nonlinear dynamical system through an effective linear statistical model, provided the nonlinearities are cooperative enough to appear as noise [61]. It is an under-appreciated fact that this

is at least sometimes true even of turbulent flows [62, 63]; the generality of such an approach is not known. Certainly, if you care only about predicting a time series, and not about its structure, it is always a good idea to try a linear model first, even if you *know* that the real dynamics are highly nonlinear.

3.3.2 Extensions. While standard linear models are more flexible than one might think, they do have their limits, and recognition of this has spurred work on many extensions and variants. Here I briefly discuss a few of these.

Long Memory. The correlations of standard ARMA and ARIMA models decay fairly rapidly, in general exponentially; $\rho(t) \propto e^{-t/\tau_c}$, where τ_c is the correlation time. For some series, however, τ_c is effectively infinite, and $\rho(t) \propto t^{-\alpha}$ for some exponent α . These are called **long-memory processes**, because they remain substantially correlated over very long times. These can still be accommodated within the ARIMA framework, formally, by introducing the idea of *fractional* differencing, or, in continuous time, fractional derivatives [64, 53]. Often long-memory processes are self-similar, which can simplify their statistical estimation [65].

Volatility. All ARMA and even ARIMA models assume constant variance. If the variance is itself variable, it can be worthwhile to model it. **Autoregressive conditionally heteroscedastic** (ARCH) models assume a fixed mean value for y_t , but a variance which is an autoregression on y_t^2 . **Generalized ARCH** (GARCH) models expand the regression to include the (unobserved) earlier variances. ARCH and GARCH models are especially suitable for processes which display **clustered volatility**, periods of extreme fluctuation separated by stretches of comparative calm.

Nonlinear and Nonparametric Models. Nonlinear models are obviously appealing, and when a particular parametric form of model is available, reasonably straight-forward modifications of the linear machinery can be used to fit, evaluate and forecast the model [55, §4.9]. However, it is often impractical to settle on a good parametric form beforehand. In these cases, one must turn to nonparametric models, as discussed in §1.2.2; neural networks are a particular favorite here [35]. The so-called **kernel smoothing methods** are also particularly well-developed for time series, and often perform almost as well as parametric models [66]. Finally, information theory provides **universal prediction**

methods, which promise to asymptotically approach the best possible prediction, starting from exactly no background knowledge. This power is paid for by demanding a long initial training phase used to infer the structure of the process, when predictions are much worse than many other methods could deliver [67].

3.4 The Nonlinear Dynamics Approach

The younger approach to the analysis of time series comes from nonlinear dynamics, and is intimately bound up with the state-space approach described in §1.3.1 above. The idea is that the dynamics on the state space can be determined *directly* from observations, at least if certain conditions are met.

The central result here is the Takens Embedding Theorem [68]; a simplified, slightly inaccurate version is as follows. Suppose the d -dimensional state vector x_t evolves according to an unknown but continuous and (crucially) deterministic dynamic. Suppose, too, that the one-dimensional observable y is a smooth function of x , and “coupled” to all the components of x . Now at any time we can look not just at the present measurement $y(t)$, but also at observations made at times removed from us by multiples of some lag τ : $y_{t-\tau}$, $y_{t-2\tau}$, etc. If we use k lags, we have a k -dimensional vector. One might expect that, as the number of lags is increased, the motion in the lagged space will become more and more predictable, and perhaps in the limit $k \rightarrow \infty$ would become deterministic. In fact, the dynamics of the lagged vectors become deterministic at a finite dimension; not only that, but the deterministic dynamics are completely equivalent to those of the original state space! (More exactly, they are related by a smooth, invertible change of coordinates, or **diffeomorphism**.) The magic **embedding dimension** k is at most $2d + 1$, and often less.

Given an appropriate reconstruction via embedding, one can investigate many aspects of the dynamics. Because the reconstructed space is related to the original state space by a smooth change of coordinates, any geometric property which survives such treatment is the same for both spaces. These include the dimension of the attractor, the Lyapunov exponents (which measure the degree of sensitivity to initial conditions) and certain qualitative properties of the autocorrelation function and power spectrum (“correlation dimension”). Also preserved is the relation of “closeness” among trajectories — two trajectories which are close in the state space will be close in the embedding space, and vice versa. This leads to a popular and robust scheme for nonlinear prediction, the **method of analogs**: when one wants to predict the next step of the

series, take the current point in the embedding space, find a similar one with a known successor, and predict that the current point will do the analogous thing. Many refinements are possible, such as taking a weighted average of nearest neighbors, or selecting an analog at random, with a probability decreasing rapidly with distance. Alternately, one can simply fit non-parametric predictors on the embedding space. (See [69] for a review.) Closely related is the idea of **noise reduction**, using the structure of the embedding-space to filter out some of the effects of measurement noise. This can work even when the statistical character of the noise is unknown (see [69] again).

Determining the number of lags, and the lag itself, is a problem of model selection, just as in §1.2, and can be approached in that spirit. An obvious approach is to minimize the in-sample forecasting error, as with ARMA models; recent work along these lines [70, 71] uses the minimum description length principle (described in §1.8.3.1 below) to control over-fitting. A more common procedure for determining the embedding dimension, however, is the **false nearest neighbor method** [72]. The idea is that if the current embedding dimension k is sufficient to resolve the dynamics, $k + 1$ would be too, and the reconstructed state space will not change very much. In particular, points which were close together in the dimension- k embedding should remain close in the dimension- $k + 1$ embedding. Conversely, if the embedding dimension is too small, points which are really far apart will be brought artificially close together (just as projecting a sphere on to a disk brings together points on the opposite side of a sphere). The particular algorithm of Kennel et al., which has proved very practical, is to take each point in the k -dimensional embedding, find its nearest neighbor in that embedding, and then calculate the distance between them. One then calculates how much further apart they would be if one used a $k + 1$ -dimensional embedding. If this extra distance is more than a certain fixed multiple of the original distance, they are said to be “false nearest neighbors”. (Ratios of 2 to 15 are common, but the precise value does not seem to matter very much.) One then repeats the process at dimension $k + 1$, stopping when the proportion of false nearest neighbors becomes zero, or at any rate sufficiently small. Here, the loss function used to guide model selection is the number of false nearest neighbors, and the standard prescriptions amount to empirical risk minimization. One reason simple ERM works well here is that the problem is intrinsically finite-dimensional (via the Takens result).

Unfortunately, the data required for calculations of quantities like dimensions and exponents to be reliable can be quite voluminous. Approximately $10^{2+0.4D}$ data-points are necessary to adequately reconstruct an

attractor of dimension D [73, pp. 317–319]. (Even this is more optimistic than the widely-quoted, if apparently pessimistic, calculation of [74], that attractor reconstruction with an *embedding* dimension of k needs 42^k data-points!) In the early days of the application of embedding methods to experimental data, these limitations were not well appreciated, leading to many calculations of low-dimensional deterministic chaos in EEG and EKG series, economic time series, etc., which did not stand up to further scrutiny. This in turn brought some discredit on the methods themselves, which was not really fair. More positively, it also led to the development of ideas such as **surrogate-data methods**. Suppose you have found what seems like a good embedding, and it appears that your series was produced by an underlying deterministic attractor of dimension D . One way to test this hypothesis would be to see what kind of results your embedding method would give if applied to similar but *non*-deterministic data. Concretely, you find a stochastic model with similar statistical properties (e.g., an ARMA model with the same power spectrum), and simulate many time-series from this model. You apply your embedding method to each of these **surrogate data** series, getting the approximate distribution of apparent “attractor” dimensions when there really is no attractor. If the dimension measured from the original data is not significantly different from what one would expect under this null hypothesis, the evidence for an attractor (at least from this source) is weak. To apply surrogate data tests well, one must be very careful in constructing the null model, as it is easy to use over-simple null models, biasing the test towards apparent determinism.

A few further cautions on embedding methods are in order. While *in principle* any lag τ is suitable, in practice very long or very short lags both lead to pathologies. A common practice is to set the lag to the autocorrelation time (see above), or the first minimum of the mutual information function (see §1.7 below), the notion being that this most nearly achieves a genuinely “new” measurement [75]. There is some evidence that the mutual information method works better [76]. Again, while in principle almost any smooth observation function will do, given enough data, in practice some make it much easier to reconstruct the dynamics; several **indices of observability** try to quantify this [77]. Finally, it strictly applies only to deterministic observations of deterministic systems. Embedding approaches are reasonably robust to a degree of noise in the observations. They do not cope at all well, however, to noise in the dynamics itself. To anthropomorphize a little, when confronted by apparent non-determinism, they respond by adding more dimensions, and so distinguishing apparently similar cases. Thus, when confronted with data which really are stochastic, they will infer an

infinite number of dimensions, which is correct in a way, but definitely not helpful.

These remarks should not be taken to belittle the very real power of nonlinear dynamics methods. Applied skillfully, they are powerful tools for understanding the behavior of complex systems, especially for probing aspects of their structure which are not directly accessible.

3.5 Filtering and State Estimation

Suppose we have a state-space model for our time series, and some observations y , can we find the state x ? This is the problem of **filtering** or **state estimation**. Clearly, it is not the same as the problem of finding a model in the first place, but it is closely related, and also a problem in statistical inference.

In this context, a **filter** is a function which provides an estimate \hat{x}_t of x_t on the basis of observations up to and including¹⁰ time t : $\hat{x}_t = f(y_0^t)$. A filter is **recursive**¹¹ if it estimates the state at t on the basis of its estimate at $t - 1$ and the new observation: $\hat{x}_t = f(\hat{x}_{t-1}, y_t)$. Recursive filters are especially suited to on-line use, since one does not need to retain the complete sequence of previous observations, merely the most recent estimate of the state. As with prediction in general, filters can be designed to provide either point estimates of the state, or distributional estimates. Ideally, in the latter case, we would get the conditional distribution, $\Pr(X_t = x | Y_1^t = y_1^t)$, and in the former case the conditional expectation, $\int_x x \Pr(X_t = x | Y_1^t = y_1^t) dx$.

Given the frequency with which the problem of state estimation shows up in different disciplines, and its general importance when it does appear, much thought has been devoted to it over many years. The problem of optimal *linear* filters for stationary processes was solved independently by two of the “grandfathers” of complex systems science, Norbert Wiener and A. N. Kolmogorov, during the Second World War [78, 79]. In the 1960s, Kalman and Bucy [80–82] solved the problem of optimal recursive filtering, assuming linear dynamics, linear observations and additive noise. In the resulting **Kalman filter**, the new estimate of the state is a weighted combination of the old state, extrapolated forward, and the state which would be inferred from the new observation alone. The requirement of linear dynamics can be relaxed slightly with what’s called the “extended Kalman filter”, essentially by linearizing the dynamics around the current estimated state.

Nonlinear solutions go back to pioneering work of Stratonovich [83] and Kushner [84] in the later 1960s, who gave optimal, recursive solutions. Unlike the Wiener or Kalman filters, which give point estimates,

the Stratonovich-Kushner approach calculates the complete conditional distribution of the state; point estimates take the form of the mean or the most probable state [85]. In most circumstances, the strictly optimal filter is hopelessly impractical numerically. Modern developments, however, have opened up some very important lines of approach to practical nonlinear filters [86], including approaches which exploit the geometry of the nonlinear dynamics [87, 88], as well as more mundane methods which yield tractable numerical approximations to the optimal filters [89, 90]. Noise reduction methods (§1.3.4) and hidden Markov models (§1.3.6) can also be regarded as nonlinear filters.

3.6 Symbolic or Categorical Time Series

The methods we have considered so far are intended for time-series taking continuous values. An alternative is to break the range of the time-series into discrete categories (generally only finitely many of them); these categories are sometimes called **symbols**, and the study of these time-series **symbolic dynamics**. Modeling and prediction then reduces to a (perhaps more tractable) problem in discrete probability, and many methods can be used which are simply inapplicable to continuous-valued series [10]. Of course, if a bad discretization is chosen, the results of such methods are pretty well meaningless, but sometimes one gets data which is already nicely discrete — human languages, the sequences of bio-polymers, neuronal spike trains, etc. We shall return to the issue of discretization below, but for the moment, we will simply consider the applicable methods for discrete-valued, discrete-time series, however obtained.

Formally, we take a continuous variable z and **partition** its range into a number of discrete **cells**, each labeled by a different symbol from some **alphabet**; the partition gives us a discrete variable $y = \phi(z)$. A **word** or **string** is just a sequence of symbols, $y_0 y_1 \dots y_n$. A time series z_0^n naturally generates a string $\phi(z_0^n) \equiv \phi(z_0)\phi(z_1)\dots\phi(z_n)$. In general, not every possible string can actually be generated by the dynamics of the system we're considering. The set of allowed sequences is called the **language**. A sequence which is never generated is said to be **forbidden**. In a slightly inconsistent metaphor, the rules which specify the allowed words of a language are called its **grammar**. To each grammar there corresponds an abstract machine or **automaton** which can determine whether a given word belongs to the language, or, equivalently, generate all and only the allowed words of the language. The generative versions of these automata are stochastic, i.e., they generate different words with different probabilities, matching the statistics of $\phi(z)$.

By imposing restrictions on the forms the grammatical rules can take, or, equivalently, on the memory available to the automaton, we can divide all languages into four nested classes, a hierarchical classification due to Chomsky [91]. At the bottom are the members of the weakest, most restricted class, the **regular languages** generated by automata within only a fixed, finite memory for past symbols (**finite state machines**). Above them are the **context free** languages, whose grammars do not depend on context; the corresponding machines are **stack automata**, which can store an unlimited number of symbols in their memory, but on a strictly first-in, first-out basis. Then come the **context-sensitive** languages; and at the very top, the unrestricted languages, generated by universal computers. Each stage in the hierarchy can simulate all those beneath it.

We may seem to have departed very far from dynamics, but actually this is not so. Because different languages classes are distinguished by different kinds of memories, they have very different correlation properties (§1.3.2), mutual information functions (§1.7), and so forth — see [10] for details. Moreover, it is often easier to determine these properties from a system’s grammar than from direct examination of sequence statistics, especially since specialized techniques are available for grammatical inference [92, 93].

3.6.1 Hidden Markov Models. The most important special case of this general picture is that of regular languages. These, we said, are generated by machines with only a finite memory. More exactly, there is a finite set of states x , with two properties:

- 1 The distribution of y_t depends solely on x_t , and
- 2 The distribution of x_{t+1} depends solely on x_t .

That is, the x sequence is a Markov chain, and the observed y sequence is noisy function of that chain. Such models are very familiar in signal processing [94], bioinformatics [95] and elsewhere, under the name of **hidden Markov models** (HMMs). They can be thought of as a generalization of ordinary Markov chains to the state-space picture described in §1.3.1. HMMs are particularly useful in filtering applications, since very efficient algorithms exist for determining the most probable values of x from the observed sequence y . The **expectation-maximization** (EM) algorithm [96] even allows us to simultaneously infer the most probable hidden states and the most probable parameters for the model.

3.6.2 Variable-Length Markov Models. The main limitation of ordinary HMMs methods, even the EM algorithm, is that they

assume a fixed **architecture** for the states, and a fixed relationship between the states and the observations. That is to say, they are not geared towards inferring the structure of the model. One could apply the model-selection techniques of §1.2, but methods of direct inference have also been developed. A popular one relies on **variable-length Markov models**, also called **context trees** or **probabilistic suffix trees** [97–100].

A suffix here is the string at the end of the y time series at a given time, so e.g. the binary series *abbabbabb* has suffixes *b*, *bb*, *abb*, *babb*, etc., but not *bab*. A suffix is a **context** if the future of the series is independent of its past, given the suffix. Context-tree algorithms try to identify contexts by iteratively considering longer and longer suffixes, until they find one which seems to be a context. For instance, in a binary series, such an algorithm would first try whether the suffices a and b are contexts, i.e., whether the conditional distribution $\Pr(Y_{t+1}|Y_t = a)$ can be distinguished from $\Pr(Y_{t+1}|Y_t = a, Y_{t-1}^-)$, and likewise for $Y_t = b$. It could happen that a is a context but b is not, in which case the algorithm will try ab and bb , and so on. If one sets x_t equal to the context at time t , x_t is a Markov chain. This is called a *variable-length* Markov model because the contexts can be of different lengths.

Once a set of contexts has been found, they can be used for prediction. Each context corresponds to a different distribution for one-step-ahead predictions, and so one just needs to find the context of the current time series. One could apply state-estimation techniques to find the context, but an easier solution is to use the construction process of the contexts to build a decision tree (§1.2.2), where the first level looks at Y_t , the second at Y_{t-1} , and so forth.

Variable-length Markov models are conceptually simple, flexible, fast, and frequently more accurate than other ways of approaching the symbolic dynamics of experimental systems [101]. However, not every regular language can be represented by a finite number of contexts. This weakness can be remedied by moving to a more powerful class of models, discussed next.

3.6.3 Causal-State Models, Observable-Operator Models, and Predictive-State Representations.

In discussing the state-space picture in §1.3.1 above, we saw that the state of a system is basically defined by specifying its future time-evolution, to the extent that it can be specified. Viewed in this way, a state X_t corresponds to a distribution over future observables Y_{t+1}^+ . One natural way of finding such distributions is to look at the *conditional* distribution of the future observations, given the previous history, i.e., $\Pr(Y_{t+1}^+|Y_t^- = y_t^-)$. For a given

stochastic process or dynamical system, there will be a certain characteristic family of such conditional distributions. One can then consider the distribution-valued process generated by the original, observed process. It turns out that the former has is always a Markov process, and that the original process can be expressed as a function of this Markov process plus noise. In fact, the distribution-valued process has all the properties one would want of a state-space model of the observations. The conditional distributions, then, can be treated as states.

This remarkable fact has led to techniques for modeling discrete-valued time series, all of which attempt to capture the conditional-distribution states, and all of which are strictly more powerful than VLMMs. There are at least three: the **causal-state models** or **causal-state machines** (CSMs)¹² introduced by Crutchfield and Young [102], the **observable operator models** (OOMs) introduced by Jaeger [103], and the **predictive state representations** (PSRs) introduced by Littman, Sutton and Singh [104]. The simplest way of thinking of such objects is that they are VLMMs where a context or state can contain more than one suffix, adding expressive power and allowing them to give compact representations of a wider range of processes. (See [105] for more on this point, with examples.)

All three techniques — CSMs, OOMs and PSRs — are basically equivalent, though they differ in their formalisms and their emphases. CSMs focus on representing states as classes of histories with the same conditional distributions, i.e., as suffixes sharing a single context. (They also feature in the “statistical forecasting” approach to measuring complexity, discussed in §1.8.3.2 below.) OOMs are named after the operators which update the state; there is one such operator for each possible observation. PSRs, finally, emphasize the fact that one does not actually need to know the probability of every possible string of future observations, but just a restricted sub-set of key trajectories, called “tests”. In point of fact, all of them can be regarded as special cases of more general prior constructions due to Salmon (“statistical relevance basis”) [106, 107] and Knight (“measure-theoretic prediction process”) [48, 49], which were themselves independent. (This area of the literature is more than usually tangled.)

Efficient **reconstruction algorithms** or **discovery procedures** exist for building CSMs [105] and OOMs [103] directly from data. (There is currently no such discovery procedure for PSRs, though there are parameter-estimation algorithms [108].) These algorithms are reliable, in the sense that, given enough data, the probability that they build the wrong set of states becomes arbitrarily small. Experimentally, selecting

an HMM architecture through cross-validation never does better than reconstruction, and often much worse [105].

While these models are more powerful than VLMs, there are still many stochastic processes which cannot be represented in this form; or, rather, their representation requires an infinite number of states [109, 110]. This is mathematically unproblematic, though reconstruction will then become much harder. (For technical reasons, it seems likely to be easier to carry through for OOMs or PSRs than for CSMs.) In fact, one can show that these techniques would work straight-forwardly on continuous-valued, continuous-time processes, if only we knew the necessary conditional distributions [48, 111]. Devising a reconstruction algorithm suitable for this setting is an extremely challenging and completely unsolved problem; even parameter estimation is difficult, and currently only possible under quite restrictive assumptions [112].

3.6.4 Generating Partitions. So far, everything has assumed that we are either observing truly discrete quantities, or that we have a fixed discretization of our continuous observations. In the latter case, it is natural to wonder how much difference the discretization makes. The answer, it turns out, is *quite a lot*; changing the partition can lead to completely different symbolic dynamics [113–115]. How then might we choose a *good* partition?

Nonlinear dynamics provides an answer, at least for deterministic systems, in the idea of a **generating partition** [10, 116]. Suppose we have a continuous state x and a deterministic map on the state F , as in §1.3.1. Under a partitioning ϕ , each point x in the state space will generate an infinite sequence of symbols, $\Phi(x)$, as follows: $\phi(x), \phi(F(x)), \phi(F^2(x)), \dots$. The partition ϕ is generating if each point x corresponds to a *unique* symbol sequence, i.e., if Φ is invertible. Thus, no information is lost in going from the continuous state to the discrete symbol sequence¹³. While one must know the continuous map F to determine exact generating partitions, there are reasonable algorithms for approximating them from data, particularly in combination with embedding methods [75, 117, 118]. When the underlying dynamics are stochastic, however, the situation is much more complicated [119].

4. Cellular Automata

Cellular automata are one of the more popular and distinctive classes of models of complex systems. Originally introduced by von Neumann as a way of studying the possibility of mechanical self-reproduction, they have established niches for themselves in foundational questions relating physics to computation in statistical mechanics, fluid dynamics,

and pattern formation. Within that last, perhaps the most relevant to the present purpose, they have been extensively and successfully applied to physical and chemical pattern formation, and, somewhat more speculatively, to biological development and to ecological dynamics. Interesting attempts to apply them to questions like the development of cities and regional economies lie outside the scope of this chapter.

4.1 A Basic Explanation of CA

Take a board, and divide it up into squares, like a chess-board or checker-board. These are the cells. Each cell has one of a finite number of distinct colors — red and black, say, or (to be patriotic) red, white and blue. (We do not allow continuous shading, and every cell has just one color.) Now we come to the “automaton” part. Sitting somewhere to one side of the board is a clock, and every time the clock ticks the colors of the cells change. Each cell looks at the colors of the nearby cells, and its own color, and then applies a definite rule, the **transition rule**, specified in advance, to decide its color in the next clock-tick; and all the cells change at the same time. (The rule can say “Stay the same.”) Each cell is a sort of very stupid computer — in the jargon, a **finite-state automaton** — and so the whole board is called a **cellular automaton**, or CA. To run it, you color the cells in your favorite pattern, start the clock, and stand back.

Let us follow this concrete picture with one more technical and abstract. The cells do not have to be colored, of course; all that’s important is that each cell is in one of a finite number of states at any given time. By custom they’re written as the integers, starting from 0, but any “finite alphabet” will do. Usually the number of states is small, under ten, but in principle any finite number is allowed. What counts as the “nearby cells”, the **neighborhood**, varies from automaton to automaton; sometimes just the four cells on the principle directions, sometimes the corner cells, sometimes a block or diamond of larger size; in principle any arbitrary shape. You do not need to stick to a chess-board; you can use any regular pattern of cells which will fill the plane (or “tessellate” it; an old name for cellular automata is **tessellation structures**). And you do not have to stick to the plane; any number of dimensions is allowed. There are various tricks for handling the edges of the space; the one which has “all the advantages of theft over honest toil” is to assume an infinite board.

Cellular Automata as Parallel Computers. CA are synchronous massively parallel computers, with each cell being a finite state transducer, taking input from its neighbors and making its own

state available as output. From this perspective, the remarkable thing about CA is that they are computationally universal, able to calculate any (classically) computable function; one can use finite-state machines, the least powerful kind of computer, to build devices equivalent to Turing machines, the most powerful kind of computer. The computational power of different physically-motivated CA is an important topic in complex systems [120, 121], though it must be confessed that CA with very different computational powers can have very similar behavior in most respects.

Cellular Automata as Discrete Field Theories. From the perspective of physics, a CA is a “digitized” classical field theory, in which space, time and the field (state) are all discrete. Thus fluid mechanics, continuum mechanics, and electromagnetism can all be simulated by CA¹⁴ typically, however, the physical relevance of a CA comes not from accurately simulating some field theory at the microscopic level, but from the large-scale phenomena they generate.

Take, for example, simulating fluid mechanics, where CA are also called **lattice gases** or **lattice fluids**. In the “HPP” [122] rule, a typical lattice gas with a square grid, there are four species of “fluid particle”, which travel along the four principal directions. If two cells moving in opposite directions try to occupy the same location at the same time, they collide, and move off at right angles to their original axis (Figure 1.4). Each cell thus contains only an integer number of particles, and only a discrete number of values of momentum are possible. If one takes averages over reasonably large regions, however, then density and momentum approximately obey the equations of continuous fluid mechanics. Numerical experiments show that this rule reproduces many fluid phenomena, such as diffusion, sound, shock-waves, etc. However, with this rule, the agreement with fluid mechanics is only approximate. In particular, the square lattice makes the large-scale dynamics anisotropic, which is unphysical. This in turn can be overcome in several ways — for instance, by using a hexagonal lattice [123]. The principle here — get the key parts of the small-scale “microphysics” right, and the interesting “macrophysics” will take care of itself — is extensively applied in studying pattern formation, including such biologically-relevant phenomena as phase separation [124], excitable media [125], and the self-assembly of micelles [126, 127].

5. Agent-Based Models

If there is any *one* technique associated with complex systems science, it is agent-based modeling. An agent-based model is a computational

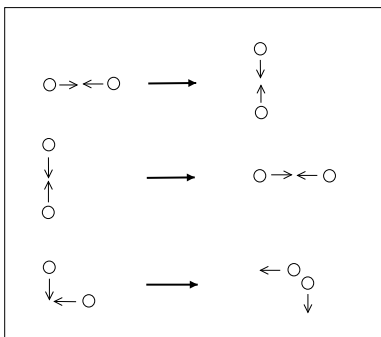

Figure 1.4. Collisions in the HPP lattice gas rule. Horizontal collisions produce vertically-moving particles (top) and vice versa (middle). Particles moving at right angles pass by each other unchanged (bottom, omitting the reflections and rotations of this figure).

model which represents individual agents and their collective behavior. What, exactly, do we mean by “agent”? Stuart Kauffman has offered¹⁵ the following apt definition: “An agent is a thing which does things to things”. That is, an agent is a persistent thing which has some *state* we find worth representing, and which interacts with other agents, mutually modifying each others’ states. The components of an agent-based model are a collection of agents and their states, the rules governing the interactions of the agents, and the environment within which they live. (The environment need not be represented in the model if its effects are constant.) The state of an agent can be arbitrarily simple, say just position, or the color of a cell in a CA. (At this end, agent-based models blend with traditional stochastic models.) States can also be extremely complicated, including, possibly, sophisticated internal models of the agent’s world.

Here is an example to make this concrete. In epidemiology, there is a classic kind of model of the spread of a disease through a population called an “SIR” model [128, §4.4]. It has three classes of people — the susceptible, who have yet to be exposed to the disease; the infected, who have it and can pass it on; and the resistant or recovered, who have survived the disease and cannot be re-infected. A traditional approach to an SIR model would have three variables, namely the number of people in each of the three categories, $S(t), I(t), R(t)$, and would have some deterministic or stochastic dynamics in terms of those variables.

For instance, in a deterministic SIR model, one might have

$$S(t+1) - S(t) = -a \left(\frac{I(t)}{S(t) + I(t) + R(t)} \right) S(t) \quad (1.36)$$

$$I(t+1) - I(t) = \left[a \frac{S(t)}{S(t) + I(t) + R(t)} - b - c \right] I(t) \quad (1.37)$$

$$R(t+1) - R(t) = bI(t) \quad (1.38)$$

which we could interpret by saying that (i) the probability of a susceptible person being infected is proportional to the fraction of the population which is already infected, (ii) infected people get better at a rate b and (iii) infected people die at a rate c . (This is not a particularly *realistic* SIR model.) In a stochastic model, we would treat the right hand sides of (1.36)–(1.38) as the mean changes in the three variables, with (say) Poisson-distributed fluctuations, taking care that, e.g., the fluctuation in the $a \frac{I}{R+S+I}$ term in (1.36) is the same as that in (1.37). The thing to note is that, whether deterministic or stochastic, the whole model is cast in terms of the aggregate quantities S , I and R , and those aggregate variables are what we would represent computationally.

In an agent-based model of the same dynamics, we would represent *each* individual in the population as a distinct agent, which could be in one of three states, S, I and R. A simple interaction rule would be that at each time-step, each agent selects another from the population entirely at random. If a susceptible agent (i.e., one in state S) picks an infectious agent (i.e., one in state I), it becomes infected with probability a . Infectious agents die with probability b and recover with probability c ; recovered agents never change their state.

So far, we have merely reproduced the stochastic version of (1.36)–(1.38), while using many more variables. The power of agent-based modeling only reveals itself when we implement more interesting interaction rules. For instance, it would be easy to assign each agent a position, and make two agents more likely to interact if they are close. We could add visible symptoms which are imperfectly associated with the disease, and a tendency not to interact with symptomatic individuals. We could make the degree of aversion to symptomatic agents part of the agents' state. All of this is easy to implement in the model, even in combination, but *not* easy to do in a more traditional, aggregated model. Sometimes it would be all but impossible; an excellent case in point is the highly sophisticated model of HIV epidemiology produced by Jacquez, Koopman, Simon and collaborators [129, 130], incorporating multiple routes of transmission, highly non-random mixing of types, and time-varying infectiousness.

Agent-based models steer you towards representing individuals, their behaviors and their interactions, rather than aggregates and their dynamics. Whether this is a good thing depends, of course, on what you know, and what you hope to learn. If you know a lot about individuals, agent-based models can help you leverage that knowledge into information about collective dynamics. This is particularly helpful if the population is heterogeneous, since you can represent the different types of individuals in the population by different states for agents. This requires a bit of effort on your part, but often not nearly so much as it would to represent the heterogeneity in an aggregated model. Conversely, if you think you have the collective dynamics down, an ABM will let you check whether a candidate for an individual-level mechanism really will produce them. (But see §1.6, below.)

Ideally, there are no “mass nouns” in an ABM, nothing represented by a smeared-out “how much”: everything should be represented by some definite number of distinctly-located agents. At most, some aggregate variables may be stuffed into the environment part of the model, but only simple and homogeneous ones. Of course, the *level* of disaggregation at which it is useful to call something an agent is a matter for particular applications, and need not be the same for every agent in a model. (E.g., one might want to model an entire organ as a single agent, while another, more interesting organ is broken up into multiple interacting agents, along anatomical or functional lines.) Sometimes it’s just not practical to represent everything which we know is an individual thing by its own agent: imagine trying to do chemical thermodynamics by tracking the interactions of a mole of molecules. Such cases demand either giving up on agent-based modeling (fortunately, the law of mass action works pretty well in chemistry), or using fictitious agents that represent substantial, but not too large, collections of individuals.

Models describing the collective dynamics of aggregate variables are sometimes called “equation-based models”, in contrast to agent-based models. This is sloppy, however: it is always possible, though generally tedious and unilluminating, to write down a set of equations which describe the dynamics of an agent-based model. Rather than drawing a false contrast between agents and equations, it would be better to compare ABMs to “aggregate models”, “collective models” or perhaps “factor models”.

5.1 Computational Implementation: Agents are Objects

The nicest way to computationally implement the commitment of distinctly representing each agent, is to make agents **objects**, which are, to over-simplify slightly, data structures which have internal states, and interact with each other by passing messages. While objects are not necessary for agent-based models, they do make programming them *much* easier, especially if the agents have much more state than, say, just a position and a type. If you try to implement models with sophisticated agents without using objects, the odds are good that you will find yourself re-inventing well-known features of object-oriented programming. (Historically, object-oriented programming *began* with languages for simulation modeling [131].) You might as well save your time, and do those things *right*, by using objects in the first place.

Generally speaking, computational implementations of ABMs contain many non-agent objects, engaged in various housekeeping tasks, or implementing the functions agents are supposed to perform. For instance, an agent, say a rat, might be supposed to memorize a sequence, say of turns in a maze. One way of implementing this would be to use a linked list, which is an object itself. Such objects do not represent actual features of the *model*, and it should be possible to vary them without interfering with the model's behavior. Which objects are picked out as agents is to some degree a matter of convenience and taste. It is common, for instance, to have mobile agents interacting on a static environment. If the environment is an object, modelers may or may not speak of it as an "environment agent," and little seems to hinge on whether or not they do.

There are several programming environments designed to facilitate agent-based modeling. Perhaps the best known of these is SWARM (www.swarm.org), which works very flexibly with several languages, is extensively documented, and has a large user community, though it presently (2004) lacks an institutional home. REPAST, while conceptually similar, is open-source (repast.sourceforge.net) and is associated with the University of Chicago. STARLOGO, and its successor, NETLOGO (ccl.sesp.northwestern.edu/netlogo), are extensions of the popular LOGO language to handle multiple interacting "turtles", i.e., agents. Like Logo, children can learn to use them [132], but they are fairly easy for adults, too, and certainly give a feel for working with ABMs.

5.2 Three Things Which Are Not Agent-Based Models

Not everything which involves the word “agent” is connected to agent-based modeling.

Representative agent models are not ABMs. In these models, the response of a population to environment conditions is found by picking out a *single* typical or representative agent, determining their behavior, and assuming that everyone else does likewise. This is sometimes reasonable, but it’s clearly diametrically opposed to what an ABM is supposed to be.

Software agents are not ABMs. Software agents are a very useful and rapidly developing technology [133, chapter 2]; an agent, here, is roughly a piece of code which interacts with other software and with pieces of the real world autonomously. Agents index the Web for search engines, engage in automated trading, and help manage parts of the North American electrical power grid, among other things. Some agent software systems are *inspired* by ABMs [134]. When one wants to model their behavior, an ABM is a natural tool (but not the only one by any means: see [135]). But a set of software agents running the Michigan power grid is not a *model* of anything, it’s *doing* something.

Finally, **multi-agent systems** [136] and **rational agents** [137] in artificial intelligence are not ABMs. The interest of this work is in understanding, and especially *designing*, systems capable of sophisticated, autonomous cognitive behavior; many people in this field would restrict the word “agent” to apply only to things capable, in some sense, of having “beliefs, desires and intentions”. While these are certainly complex systems, they are not usually intended to be *models* of anything else. One can, of course, press them into service as models [138], but generally this will be no more than a heuristic device.

5.3 The Simplicity of Complex Systems Models

One striking feature of agent-based models, and indeed of complex systems models in general, is how *simple* they are. Often, agents have only a few possible states, and only a handful of kinds of interaction. This practice has three motivations. (i) A model as detailed as the system being studied would be as hard to understand as that system. (ii) Many people working in complex systems science want to show that a certain set of mechanisms are sufficient to generate some phenomenon, like cooperation among unrelated organisms, or the formation of striped patterns. Hence using simple models, which contain only those mechanisms, makes the case. (iii) Statistical physicists, in particular, have

a long tradition of using highly simplified models as caricatures of real systems.

All three motives are appropriate, in their place. (i) is completely unexceptionable; abstracting away from irrelevant detail is always worthwhile, so long as it really is irrelevant. (ii) is also fair enough, though one should be careful that the mechanisms in one's model can still generate the phenomenon when they interact with *other* effects as well. (iii) works very nicely in statistical physics itself, where there are powerful mathematical results relating to the renormalization group [139] and bifurcation theory [14] which allow one to extract certain kinds of *quantitative* results from simplified models which share certain *qualitative* characteristics with real systems. (We have seen a related principle when discussing cellular automata models above.) There is, however, little reason to think that these universality results apply to most complex systems, let alone ones with adaptive agents!

6. Evaluating Models of Complex Systems

We do not build models for their own sake; we want to see what they do, and we want to compare what they do both to reality and to other models. This kind of evaluation of models is a problem for all areas of science, and as such little useful general advice can be given. However, there are some issues which are peculiar to models of complex systems, or especially acute for them, and I will try to provide some guidance here, moving from figuring out just what your model does, to comparing your model to data, to comparing it to other models.

6.1 Simulation

The most basic way to see what your model does is to run it; to do a simulation. Even though a model is entirely a human construct, every aspect of its behavior following logically from its premises and initial conditions, the frailty of human nature is such that we generally cannot perceive those consequences, not with any accuracy. If the model involves a large number of components which interact strongly with each other — if, that is to say, it's a good model of a complex system — our powers of deduction are generally overwhelmed by the mass of relevant, interconnected detail. Computer simulation then comes to our aid, because computers have no trouble remembering large quantities of detail, nor in following instructions.

6.1.1 Direct Simulation. Direct simulation — simply starting the model and letting it go — has two main uses. One is to get a sense

of the typical behavior, or of the range of behavior. The other, more quantitative, use is to determine the distribution of important quantities, including time series. If one randomizes initial conditions, and collects data over multiple runs, one can estimate the distribution of desired quantities with great accuracy. This is exploited in the time series method of surrogate data (above), but the idea applies quite generally.

Individual simulation runs for models of complex systems can be reasonably expensive in terms of time and computing power; large numbers of runs, which are really needed to have confidence in the results, are correspondingly more costly. Few things are more dispiriting than to expend such quantities of time and care, only to end up with ambiguous results. It is almost always worthwhile, therefore, to carefully think through what you want to measure, and why, before running anything. In particular, if you are trying to judge the merits of competing models, effort put into figuring out how and where they are *most* different will generally be well-rewarded. The theory of experimental design offers extensive guidance on how to devise informative series of experiments, both for model comparison and for other purposes, and by and large the principles apply to simulations as well as to real experiments.

6.1.2 Monte Carlo Methods. **Monte Carlo** is the name of a broad, slightly indistinct family for using random processes to estimate deterministic quantities, especially the properties of probability distributions. A classic example will serve to illustrate the basic idea, on which there are many, many refinements.

Consider the problem of determining the area A under a curve given by a known but irregular function $f(x)$. In principle, you could integrate f to find this area, but suppose that numerical integration is infeasible for some reason. (We will come back to this point presently.) A Monte Carlo solution to this problem is as follows: pick points at random, uniformly over the square. The probability p that a point falls in the shaded region is equal to the fraction of the square occupied by the shading: $p = A/s^2$. If we pick n points independently, and x of them fall in the shaded region, then $x/n \rightarrow p$ (by the law of large numbers), and $s^2x/n \rightarrow A$. s^2x/n provides us with a stochastic estimate of the integral. Moreover, this is a probably approximately correct (§1.2.1.3) estimate, and we can expect, from basic probability theory, that the standard deviation of the estimate around its true value will be proportional to $n^{-1/2}$, which is not bad¹⁶. However, when faced with such a claim, one should always ask what the proportionality constant is, and whether it is the best achievable. Here it is not: the equally simple, if less visual,

scheme of just picking values of x uniformly and averaging the resulting values of $f(x)$ always has a smaller standard deviation [140, chapter 5].

This example, while time-honored and visually clear, does not show Monte Carlo to its best advantage; there are few one-dimensional integrals which cannot be done better by ordinary, non-stochastic numerical methods. But numerical integration becomes computationally intractable when the domain of integration has a large number of dimensions, where “large” begins somewhere between four and ten. Monte Carlo is much more indifferent to the dimensionality of the space: we could replicate our example with a 999-dimensional hyper-surface in a 1000-dimensional space, and we’d still get estimates that converged like $n^{-1/2}$, so achieving an accuracy of $\pm\epsilon$ will require evaluating the function f only $O(\epsilon^{-2})$ times.

Our example was artificially simple in another way, in that we used a uniform distribution over the entire space. Often, what we want is to compute the expectation of some function $f(x)$ with a non-uniform probability $p(x)$. This is just an integral, $\int f(x)p(x)dx$, so we could sample points uniformly and compute $f(x)p(x)$ for each one. But if some points have very low probability, so they only make a small contribution to the integral, spending time evaluating the function there is a bit of a waste. A better strategy would be to pick points according to the actual probability distribution. This can sometimes be done directly, especially if $p(x)$ is of a particularly nice form. A very general and clever indirect scheme is as follows [141]. We want a whole sequence of points, x_1, x_2, \dots, x_n . We pick the first one however we like, and after that we pick successive points according to some Markov chain: that is, the distribution of x_{i+1} depends only on x_i , according to some fixed function $q(x_i, x_{i+1})$. Under some mild conditions¹⁷, the distribution of x_t approaches a stationary distribution $q^*(x)$ at large times t . If we could ensure that $q^*(x) = p(x)$, we know that the Markov chain was converging to our distribution, and then, by the ergodic theorem, averaging $f(x)$ along a trajectory would give the expected value of $f(x)$. One way to ensure this is to use the “detailed balance” condition of the invariant distribution, that the total probability of going from x to y must equal the total probability of going the other way:

$$p(x)q(x, y) = p(y)q(y, x) \tag{1.39}$$

$$\frac{q(x, y)}{q(y, x)} = \frac{p(y)}{p(x)} \equiv h(x, y) \tag{1.40}$$

So now we just need to make sure that (1.40) is satisfied. One way to do this is to set $q(x, y) = \min(1, h(x, y))$; this was the original proposal of Metropolis *et al.* Another is $q(x, y) = \frac{h(x, y)}{1+h(x, y)}$. This method

is what physicists usually mean by “Monte Carlo”, but statisticians call it **Markov chain Monte Carlo**, or “MCMC”. While we can now estimate the properties of basically arbitrary distributions, we no longer have independent samples, so evaluating the accuracy of our estimates is no longer a matter of *trivial* probability¹⁸. An immense range of refinements have been developed over the last fifty years, addressing these and other points; see the further reading section for details.

Keep in mind that Monte Carlo is a stochastic simulation method only in a special sense — it simulates the probability distribution $p(x)$, *not* the mechanism which generated that distribution. The dynamics of Markov chain Monte Carlo, in particular, often bear no resemblance whatsoever to those of the real system¹⁹. Since the point of Monte Carlo is to tell us about the properties of $p(x)$ (what is the expectation value of this function? what is the probability of configurations with this property? etc.), the actual trajectory of the Markov chain is of no interest. This point sometimes confuses those more used to direct simulation methods.

6.2 Analytical Techniques

Naturally enough, analytical techniques are not among the tools which first come to mind for dealing with complex systems; in fact, they often do not come to mind at all. This is unfortunate, because a lot of intelligence has been devoted to devising approximate analytical techniques for classes of models which include many of those commonly used for complex systems. A general advantage of analytical techniques is that they are often fairly insensitive to many details of the model. Since any model we construct of a complex system is almost certainly much simpler than the system itself, a great many of its details are just wrong. If we can extract non-trivial results which are insensitive to those details, we have less reason to worry about this.

One particularly useful, yet neglected, body of approximate analytical techniques relies on the fact that many complex systems models are Markovian. In an agent-based model, for instance, the next state of an agent generally depends only on its present state, and the present states of the agents it interacts with. If there is a fixed interaction graph, the agents form a Markov random field on that graph. There are now very powerful and computationally efficient methods for evaluating many properties of Markov chains [58, 142], Markov random fields [143], and (closely related) graphical models [144] *without* simulation. The recent books of Peyton Young [145] and Sutton [146] provide nice instances of using analytical results about Markov processes to solve models of complex social systems, without impractical numerical experiments.

6.3 Comparisons with Data

6.3.1 General issues. We can only compare particular aspects of a model of a system to particular kinds of data about that system. The most any experimental test can tell us, therefore, is how similar the model is to the system *in that respect*. One may think of an experimental comparison as a test for a *particular* kind of *error*, one of the infinite number of mistakes which we could make in building a model. A good test is one which is very likely to alert us to an error, if we have made it, but not otherwise [50].

These ought to be things every school-child knows about testing hypotheses. It is very easy, however, to blithely ignore these truisms when confronted with, on the one hand, a system with many strongly interdependent parts, and, on the other hand, a model which tries to mirror that complexity. We must decide which features of the model *ought* to be similar to the system, and how similar. It is important not only that our model be able to adequately reproduce those phenomena, but that it not entail badly distorted or non-existent phenomena in other respects.

6.3.2 Two Stories and Some Morals. Let me give two examples from very early in the study of complex systems, which nicely illustrate some fundamental points.

The first has to do with pattern formation in chemical oscillators [147]. Certain mixtures of chemicals in aqueous solution, mostly famously the Belusov-Zhabotinsky reagent, can not only undergo cyclic chemical reactions, but will form rotating spiral waves, starting from an initial featureless state. This is a visually compelling example of self-organization, and much effort has been devoted to understanding it. One of the more popular early models was the “Brusselator” advanced by Prigogine and his colleagues at the Free University of Brussels; many similarly-named variants developed. Brusselator-type models correctly predicted that these media would support spiral waves. They all, further, predicted that the spirals would form only when the homogeneous configuration was unstable, and that then they would form spontaneously. It proved very easy, however, to prepare the Belusov-Zhabotinsky reagent in such a way that it was “perfectly stable in its uniform quiescence”, yet still able to produce spiral waves if excited (e.g., by being touched with a hot wire) [148]. The Brusselator and its variants were simply unable to accommodate these phenomena, and had to be discarded in favor of other models. The fact that these were qualitative results, rather than quantitative ones, if anything made it more imperative to get rid of the Brusselator.

The second story concerns the work of Varela and Maturana on “autopoiesis”. In a famous paper [149], they claimed to exhibit a computational model of a simple artificial chemistry where membranes not only formed spontaneously, but a kind of metabolism self-organized to sustain the membranes. This work influenced not just complex systems science but theoretical biology, psychology, and even sociology [150]. When, in the 1990s, McMullin made the first serious effort to reproduce the results, based on the description of the model in the paper, that description proved *not* to match the published simulation results. The discrepancy was only resolved by the fortuitous rediscovery of a mass of papers, including Fortran code, that Varela had left behind in Chile when forced into exile by the fascist regime. These revealed a crucial change in one particular reaction made all the difference between successful autopoiesis and its absence. (For the full story, see [151, 152].) Many similar stories could be told of other models in complex systems [153]; this one is distinguished by McMullin’s unusual tenacity in trying to replicate the results, Varela’s admirable willingness to assist him, and the happy ending.

The story of autopoiesis is especially rich in morals. (1) Replication is essential. (2) It is a good idea to share not just data but programs. (3) *Always* test the robustness of your model to changes in its parameters. (This is fairly common.) (4) *Always* test your model for robustness to small changes in qualitative assumptions. If your model calls for a given effect, there are usually several mechanisms which could accomplish it. If it does not matter which mechanism you actually use, the result is that much more robust. Conversely, if it does matter, the over-all adequacy of the model can be tested by checking whether *that* mechanism is actually present in the system. Altogether too few people perform such tests.

6.3.3 Comparing Macro-data and Micro-models. Data are often available only about large aggregates, while models, especially agent-based models, are about individual behavior. One way of comparing such models to data is to compute the necessary aggregates, from direct simulation, Monte Carlo, etc. The problem is that many different models can give the same aggregated behavior, so this does not provide a powerful test between different models. Ideally, we’d work back from aggregate data to individual behaviors, which is known, somewhat confusingly, as **ecological inference**. In general, the ecological inference problem itself does not have a unique solution. But the aggregate data, if used intelligently, can often put fairly tight constraints on the individual behaviors, and micro-scale can be directly checked against those constraints. Much of the work here has been done by social scientists, es-

pecially American political scientists concerned with issues arising from the Voting Rights Act [154], but the methods they have developed are very general, and could profitably be applied to agent-based models in the biological sciences, though, to my knowledge, they have yet to be.

6.4 Comparison to Other Models

Are there other ways of generating the data? There generally are, at least if “the data” are some very gross, highly-summarized pattern. This makes it important to look for differential signatures, places where discrepancies between different generative mechanisms give one some *leverage*. Given two mechanisms which can both account for our phenomenon, we should look for some *other* quantity whose behavior will be different under the two hypotheses. Ideally, in fact, we would look for the statistic on which the two kinds of model are *most* divergent. The literature on experimental design is relevant here again, since it considers such problems under the heading of **model discrimination**, seeking to maximize the power of experiments (or simulations) to distinguish between different classes of models [155, 156].

Perhaps no aspect of methodology is more neglected in complex systems science than this one. While it is always perfectly legitimate to announce a new mechanism as *a* way of generating a phenomenon, it is far too common for it to be called *the* way to do it, and vanishingly rare to find an examination of how it *differs* from previously-proposed mechanisms. Newman and Palmer’s work on extinction models [157] stands out in this regard for its painstaking examination of the ways of discriminating between the various proposals in the literature.

7. Information Theory

Information theory began as a branch of communications engineering, quantifying the length of codes needed to represent randomly-varying signals, and the rate at which data can be transmitted over noisy channels. The concepts needed to solve these problems turn out to be quite fundamental measures of the uncertainty, variability, and the interdependence of different variables. Information theory thus is an important tool for studying complex systems, and in addition is indispensable for understanding complexity measures (§1.8).

7.1 Basic Definitions

Our notation and terminology follows that of Cover and Thomas’s standard textbook [158].

Given a random variable X taking values in a discrete set \mathcal{A} , the **entropy** or **information content** $H[X]$ of X is

$$H[X] \equiv - \sum_{a \in \mathcal{A}} \Pr(X = a) \log_2 \Pr(X = a) . \quad (1.41)$$

$H[X]$ is the expectation value of $-\log_2 \Pr(X)$. It represents the uncertainty in X , interpreted as the mean number of binary distinctions (bits) needed to identify the value of X . Alternately, it is the minimum number of bits needed to encode or describe X . Note that $H[X] = 0$ if and only if X is (almost surely) constant.

The **joint entropy** $H[X, Y]$ of two variables X and Y is the entropy of their joint distribution:

$$H[X, Y] \equiv - \sum_{a \in \mathcal{A}, b \in \mathcal{B}} \Pr(X = a, Y = b) \log_2 \Pr(X = a, Y = b) \quad (1.42)$$

The **conditional entropy** of X given Y is

$$H[X|Y] \equiv H[X, Y] - H[Y] . \quad (1.43)$$

$H[X|Y]$ is the average uncertainty remaining in X , given a knowledge of Y .

The **mutual information** $I[X; Y]$ between X and Y is

$$I[X; Y] \equiv H[X] - H[X|Y] . \quad (1.44)$$

It gives the reduction in X 's uncertainty due to knowledge of Y and is symmetric in X and Y . We can also define higher-order mutual informations, such as the third-order information $I[X; Y; Z]$,

$$I[X; Y; Z] \equiv H[X] + H[Y] + H[Z] - H[X, Y, Z] \quad (1.45)$$

and so on for higher orders. These functions reflect the joint dependence among the variables.

Mutual information is a special case of the **relative entropy**, also called the **Kullback-Leibler divergence** (or **distance**). Given two *distributions* (not variables), P and Q , the entropy of Q relative to P is

$$D(P||Q) \equiv \sum_x P(x) \log \frac{P(x)}{Q(x)} \quad (1.46)$$

D measures how far apart the two distributions are, since $D(P||Q) \geq 0$, and $D(P||Q) = 0$ implies the two distributions are equal almost everywhere. The divergence can be interpreted either in terms of codes (see below), or in terms of statistical tests [159]. Roughly speaking, given n

samples drawn from the distribution P , the probability of our accepting the false hypothesis that the distribution is Q can go down no faster than $2^{-nD(P\|Q)}$. The mutual information $I[X; Y]$ is the divergence between the joint distribution $\Pr(X, Y)$, and the product of the marginal distributions, $\Pr(X)\Pr(Y)$, and so measures the departure from independence.

Some extra information-theoretic quantities make sense for time series and stochastic processes. Supposing we have a process $\bar{X} = \dots, X_{-2}, X_{-1}, X_0, X_1, X_2, \dots$, we can define its **mutual information function** by analogy with the autocovariance function (see §1.3.2),

$$I_{\bar{X}}(s, t) = I[X_s; X_t] \quad (1.47)$$

$$I_{\bar{X}}(\tau) = I[X_t; X_{t+\tau}] \quad (1.48)$$

where the second form is valid only for strictly stationary processes. The mutual information function measures the degree to which different parts of the series are dependent on each other.

The **entropy rate** h of a stochastic process

$$h \equiv \lim_{L \rightarrow \infty} H[X_0 | X_{-L}^{-1}] \quad (1.49)$$

$$= H[X_0 | X_{-\infty}^{-1}] . \quad (1.50)$$

(The limit always exists for stationary processes.) h measures the process's unpredictability, in the sense that it is the uncertainty which remains in the next measurement even given complete knowledge of its past. In nonlinear dynamics, h is called the **Kolmogorov-Sinai (KS) entropy**.

For continuous variables, one can define the entropy via an integral,

$$H[X] \equiv - \int p(x) \log p(x) dx , \quad (1.51)$$

with the subtlety that the continuous entropy not only can be negative, but depends on the coordinate system used for x . The relative entropy also has the obvious definition,

$$D(P\|Q) \equiv \int p(x) \log \frac{p(x)}{q(x)} dx \quad (1.52)$$

but is coordinate-independent and non-negative. So, hence, is the mutual information.

Optimal Coding. One of the basic results of information theory concerns codes, or schemes for representing random variables by bit

strings. That is, we want a scheme which associates each value of a random variable X with a bit string. Clearly, if we want to keep the average length of our code-words small, we should give shorter codes to the more common values of X . It turns out that the average code-length is minimized if we use $-\log \Pr(x)$ bits to encode x , and it is always possible to come within one bit of this. Then, on average, we will use $\mathbf{E}[-\log \Pr(x)] = H[X]$ bits.

This presumes we know the true probabilities. If we think the true distribution is Q when it is really P , we will, on average, use $\mathbf{E}[-\log Q(x)] \geq H[X]$. This quantity is called the **cross-entropy** or **inaccuracy**, and is equal to $H[X] + D(P\|Q)$. Thus, finding the correct probability distribution is equivalent to minimizing the cross-entropy, or the relative entropy [160].

The Khinchin Axioms and Rényi Information. In 1953, A. I. Khinchin published a list of four reasonable-looking axioms for a measure of the information $H[X]$ associated with a random variable X [161]. He then proved that the Shannon information was the unique functional satisfying the axioms, up to an over-all multiplicative constant. (The choice of this constant is equivalent to the choice of the base for logarithms.) The axioms were as follows.

- The information is a functional of the probability distribution of X , and not on any of its other properties. In particular, if f is any invertible function, $H[X] = H[f(X)]$.
- The information is maximal for the uniform distribution, where all events are equally probable.
- The information is unchanged by enlarging the probability space with events of zero probability.
- If the probability space is divided into two sub-spaces, so that X is split into two variables Y and Z , the total information is equal to the information content of the marginal distribution of one sub-space, plus the mean information of the conditional distribution of the other sub-space: $H[X] = H[Y] + \mathbf{E}[H(Z|Y)]$.

A similar axiomatic treatment can be given for the mutual information and the relative entropy.

While the first three of Khinchin's axioms are all highly plausible, the fourth is somewhat awkward. It is intuitively more plausible to merely require that, if Y and Z are independent, then $H[Y, Z] = H[Y] + H[Z]$. If the fourth axiom is weakened in this way, however, there is no longer

only a single functional satisfying the axioms. Instead, any of the infinite family of entropies introduced by Rényi satisfies the axioms. The **Rényi entropy** of order α , with α any non-negative real number, is

$$H_\alpha[X] \equiv \frac{1}{1-\alpha} \log \sum_{i:p_i>0} p_i^\alpha \quad (1.53)$$

in the discrete case, and the corresponding integral in the continuous case. The parameter α can be thought of as gauging how strongly the entropy is biased towards low-probability events. As $\alpha \rightarrow 0$, low-probability events count more, until at $\alpha = 0$, all possible events receive equal weight. (This is sometimes called the **topological entropy**.) As $\alpha \rightarrow \infty$, only the highest-probability event contributes to the sum. One can show that, as $\alpha \rightarrow 1$, $H_\alpha[X] \rightarrow H[X]$, i.e., one recovers the ordinary Shannon entropy in the limit. There are entropy rates corresponding to all the Rényi entropies, defined just like the ordinary entropy rate. For dynamical systems, these are related to the fractal dimensions of the attractor [162, 163].

The **Rényi divergences** bear the same relation to the Rényi entropies as the Kullback-Leibler divergence does to the Shannon entropy. The defining formula is

$$D_\alpha(P||Q) \equiv \frac{1}{\alpha-1} \log \sum q_i \left(\frac{p_i}{q_i} \right)^\alpha \quad (1.54)$$

and similarly for the continuous case. Once again, $\lim_{\alpha \rightarrow 1} D_\alpha(P||Q) = D(P||Q)$. For all $\alpha > 0$, $D_\alpha(P||Q) \geq 0$, and is equal to zero if and only if P and Q are the same. (If $\alpha = 0$, then a vanishing Rényi divergence only means that the supports of the two distributions are the same.) The Rényi entropy $H_\alpha[X]$ is non-increasing as α grows, whereas the Rényi divergence $D_\alpha(P||Q)$ is non-decreasing.

Estimation of Information-Theoretic Quantities. In applications, we will often want to estimate information-theoretic quantities, such as the Shannon entropy or the mutual information, from empirical or simulation data. Restricting our attention, for the moment, to the case of discrete-valued variables, the empirical distribution will generally converge on the true distribution, and so the entropy (say) of the empirical distribution (“sample entropy”) will also converge on the true entropy. However, it is not the case that the sample entropy is an *unbiased* estimate of the true entropy. The Shannon (and Rényi) entropies are measures of variation, like the variance, and sampling tends to reduce variation. Just as the sample variance is a negatively biased estimate of the true variance, sample entropy is a negatively-biased estimate of the

true entropy, and so sample mutual information is a positively-biased estimate of true information. Understanding and controlling the bias, as well as the sampling fluctuations, can be very important.

Victor [164] has given an elegant method for calculating the bias of the sample entropy; remarkably, the leading-order term depends only on the alphabet size k and the number of samples N , and is $(k - 1)/2N$. Higher-order terms, however, depend on the true distribution. Recently, Kraskov et al. [165] have published an adaptive algorithm for estimating mutual information, which has very good properties in terms of both bias and variance. Finally, the estimation of entropy *rates* is a somewhat tricky matter. The best practices are to either use an algorithm of the type given by [166], or to fit a properly dynamical model. (For discrete data, variable-length Markov chains, discussed in §1.3.6.2 above, generally work very well, and the entropy rate can be calculated from them very simply.) Another popular approach is to run one's time series through a standard compression algorithm, such as `gzip`, dividing the size in bits of the output by the number of symbols in the input [167]. This is an absolutely horrible idea; even under the circumstances under which it gives a consistent estimate of the entropy rate, it converges much more slowly, and runs more slowly, than employing either of the two techniques just mentioned [168, 169].²⁰

7.2 Applications of Information Theory

Beyond its original home in communications engineering, information theory has found a multitude of applications in statistics [159, 160] and learning theory [144, 170]. Scientifically, it is very natural to consider some biological systems as communications channels, and so analyze their information content; this has been particularly successful for biopolymer sequences [171] and especially for neural systems, where the analysis of neural codes depends vitally on information theory [172, 173]. However, there is nothing prohibiting the application of information theory to systems which are not designed to function as communications devices; the concepts involved require only well-defined probability distributions. For instance, in nonlinear dynamics [174, 175] information-theoretic notions are very important in characterizing different kinds of dynamical system (see also §1.3.6). Even more closely tied to complex systems science is the literature on “physics and information” or “physics and computation”, which investigates the relationships between the mechanical principles of physics and information theory, e.g., Landauer's principle, that erasing (but not storing) a bit of information at tem-

perature T produces $k_B T \ln 2$ joules of heat, where k_B is Boltzmann’s constant.

8. Complexity Measures

We have already given some thought to complexity, both in our initial rough definition of “complex system” and in our consideration of machine learning and Occam’s Razor. In the latter, we saw that the relevant sense of “complexity” has to do with families of models: a model class is complex if it requires large amounts of data to reliably find the best model in the class. On the other hand, we initially said that a complex system is one with many highly variable, strongly interdependent parts. Here, we will consider various proposals for putting some mathematical spine into that notion of a system’s complexity, as well as the relationship to the notion of complexity of learning.

Most measures of complexity for systems formalize the intuition that something is complex if it is difficult to describe adequately. The first mathematical theory based on this idea was proposed by Kolmogorov; while it is *not* good for analyzing empirical complex systems, it was very important historically, and makes a good point of entry into the field.

8.1 Algorithmic Complexity

Consider a collection of measured data-values, stored in digitized form on a computer. We would like to say that they are complex if they are hard to describe, and measure their complexity by the difficulty of describing them. The central idea of Kolmogorov complexity (proposed independently by Solomonoff [176] and Chaitin) is that one can describe the data set by writing a program which will reproduce the data. The difficulty of description is then measured by the length of the program. Anyone with much experience of other people’s code will appreciate that it is always possible to write a longer, slower program to do a given job, so what we are really interested in is the shortest program that can exactly replicate the data.

To introduce some symbols, let x be the data, and $|x|$ their size in bits. The Kolmogorov or algorithmic complexity of x , $K(x)$, is the length of the shortest program that will output x and then stop²¹. Clearly, there is always some program which will output x and then stop, for instance, “`print(x); end`”. Thus $K(x) \leq |x| + c$, where c is the length of the print and end instructions. This is what one might call a literal description of the data. If one cannot do better than this — if $K(x) \approx |x|$ — then x is highly complex. Some data, however, is highly compressible. For

instance, if x consists of the second quadrillion digits of π , a very short program suffices to generate it²².

As you may already suspect, the number of simple data sets is quite limited. Suppose we have a data set of size n bits, and we want to compress it by k bits, i.e., find a program for it which is $n - k$ bits long. There are at most 2^{n-k} programs of that length, so of all the 2^n data sets of size n , the fraction which can be compressed by k bits is at most 2^{-k} . The precise degree of compression does not matter — when we look at large data sets, almost all of them are highly complex. If we pick a large data set *at random*, then the odds are very good that it will be complex. We can state this more exactly if we think about our data as consisting of the first n measurements from some sequence, and let n grow. That is, $x = x_1^n$, and we are interested in the asymptotic behavior of $K(x_1^n)$. If the measurements x_i are independent and identically distributed (IID), then $K(x_1^n)/|x| \rightarrow 1$ almost surely; IID sequences are **incompressible**. If x is a realization of a stationary (but not necessarily IID) random process \bar{X} , then [177, 10]

$$\lim_{n \rightarrow \infty} \mathbf{E} \left[\frac{K(X_1^n)}{n} \right] = h(\bar{X}), \quad (1.55)$$

the entropy rate (§1.7) of \bar{X} . Thus, random data has high complexity, and the complexity of a random process grows at a rate which just measures its unpredictability.

This observation goes the other way: complex data looks random. The heuristic idea is that if there were any regularities in the data, we could use them to shave at least a little bit off the length of the minimal program. What one can show formally is that incompressible sequences have *all* the properties of IID sequences — they obey the law of large numbers and the central limit theorem, pass all statistical tests for randomness, etc. In fact, this possibility, of defining “random” as “incompressible”, is what originally motivated Kolmogorov’s work [107, chapter 3].

Kolmogorov complexity is thus a very important notion for the foundations of probability theory, and it has extensive applications in theoretical computer science [177] and even some aspects of statistical physics [178]. Unfortunately, it is quite useless as a measure of the complexity of natural systems. This is for two reasons. First, as we have just seen, it is maximized by *independent* random variables; we want *strong dependence*. Second, and perhaps more fundamental, it is simply not possible to calculate Kolmogorov complexity. For deep reasons related to Gödel’s Theorem, there cannot be any procedure for calculating $K(x)$, nor are there any accurate approximation procedures [177].

Many scientists are strangely in denial about the Kolmogorov complexity, in that they think they can calculate it. Apparently unaware of the mathematical results, but aware of the relationship between Kolmogorov complexity and data compression, they reason that file compression utilities should provide an estimate of the algorithmic information content. Thus one finds many papers which might be titled “`gzip` as a measure of complexity”²³, and the practice is even recommended by some otherwise-reliable sources (e.g., [73]). However, this is simply a confused idea, with absolutely nothing to be said in its defense.

8.2 Refinements of Algorithmic Complexity

We saw just now that algorithmic information is really a measure of randomness, and that it is maximized by collections of independent random variables. Since complex systems have many strongly dependent variables, it follows that the Kolmogorov notion is not the one we really want to measure. It has long been recognized that we really want something which is small both for systems which are strongly ordered (i.e., have only a small range of allowable behavior) and for those which are strongly disordered (i.e., have independent parts). Many ways of modifying the algorithmic information to achieve this have been proposed; two of them are especially noteworthy.

8.2.1 Logical Depth. Bennett [179–181] proposed the notion of the **logical depth** of data as a measure of its complexity. Roughly speaking, the logical depth $L(x)$ of x is the number of computational steps the minimal program for x must execute. For incompressible data, the minimal program is `print(x)`, so $L(x) \approx |x|$. For periodic data, the minimal program cycles over printing out one period over and over, so $L(x) \approx |x|$ again. For some compressible data, however, the minimal program must do non-trivial computations, which are time-consuming. Thus, to produce the second quadrillion digits of π , the minimal program is one which *calculates* the digits, and this takes considerably more time than reading them out of a list. Thus, π is deep, while random or periodic data are shallow.

While logical depth is a clever and appealing idea, it suffers from a number of drawbacks. First, real data are not, so far as we know, actually produced by running their minimal programs²⁴, and the run-time of that program has no known *physical* significance, and that’s not for lack of attempts to find one [182]. Second, and perhaps more decisively, there is still no procedure for finding the minimal program.

8.2.2 Algorithmic Statistics. Perhaps the most important modification of the Kolmogorov complexity is that proposed by Gács, Tromp and Vitanyi [183], under the label of “algorithmic statistics”. Observe that, when speaking of the minimal program for x , I said nothing about the inputs to the program; these are to be built in to the code. It is this which accounts for the length of the programs needed to generate random sequences: almost all of the length of `print(x)` comes from x , not `print()`. This suggests splitting the minimal program into two components, a “model” part, the program properly speaking, and an “data” part, the inputs to the program. We want to put all the regularities in x into the model, and all the arbitrary, noisy parts of x into the inputs. Just as in probability theory a “statistic” is a function of the data which summarizes the information they convey, Gács *et al.* regard the model part of the program as an **algorithmic statistic**, summarizing its regularities. To avoid the trivial regularity of `print()` when possible, they define a notion of a **sufficient** algorithmic statistic, based on the idea that x should be in some sense a typical output of the model (see their paper for details). They then define the complexity of x , or, as they prefer to call it, the **sophistication**, as the length of the shortest sufficient algorithmic statistic.

Like logical depth, sophistication is supposed to discount the purely random part of algorithmic complexity. Unlike logical depth, it stays within the confines of description in doing so; programs, here, are just a particular, mathematically tractable, kind of description. Unfortunately, the sophistication is still uncomputable, so there is no real way of applying algorithmic statistics.

8.3 Statistical Measures of Complexity

The basic problem with algorithmic complexity and its extensions is that they are all about finding the shortest way of exactly describing a single configuration. Even if we could compute these measures, we might suspect, on the basis of our discussion of over-fitting in §1.2 above, that this is not what we want. Many of the details of any particular set of data are just noise, and will not generalize to other data sets obtained from the same system. If we want to characterize the complexity of the system, it is precisely the generalizations that we want, and not the noisy particulars. Looking at the sophistication, we saw the idea of picking out, from the overall description, the part which describes the regularities of the data. This idea becomes useful and operational when we abandon the goal of *exact* description, and allow ourselves to recognize that the

world is full of noise, which is easy to describe statistically; we want a statistical, and not an algorithmic, measure of complexity.

I will begin with what is undoubtedly the most widely-used statistical measure of complexity, Rissanen’s **stochastic complexity**, which can also be considered a method of model selection. Then I will look at three attempts to isolate the complexity of the system as such, by considering how much information would be required to predict its behavior, *if* we had an optimal statistical model of the system.

8.3.1 Stochastic Complexity and the Minimum Description Length.

Suppose we have a statistical model with some parameter θ , and we observe the data x . The model assigns a certain likelihood to the data, $\Pr_\theta(X = x)$. One can make this into a loss function by taking its negative logarithm: $L(\theta, x) = -\log \Pr_\theta(X = x)$. Maximum likelihood estimation minimizes this loss function. We also learned, in §1.7, that if \Pr_θ is the correct probability distribution, the optimal coding scheme will use $-\log \Pr_\theta(X = x)$ bits to encode x . Thus, maximizing the likelihood can also be thought of as minimizing the encoded length of the data.

However, we do not yet have a complete description: we have an encoded version of the data, but we have not said what the encoding scheme, i.e., the model, is. Thus, the total description length has two parts:

$$C(x, \theta, \Theta) = L(x, \theta) + D(\theta, \Theta) \quad (1.56)$$

where $D(\theta, \Theta)$ is the number of bits we need to specify θ from among the set of all our models Θ . $L(x, \theta)$ represents the “noisy” or arbitrary part of the description, the one which will not generalize; the model represents the part which does generalize. If $D(\theta, \Theta)$ gives short codes to simple models, we have the desired kind of trade-off, where we can reduce the part of the data which looks like noise only by using a more elaborate model. The **minimum description length principle** [184, 185] enjoins us to pick the model which minimizes the description length, and the **stochastic complexity** of the data is that minimized description-length:

$$\theta_{\text{MDL}} = \operatorname{argmin}_\theta C(x, \theta, \Theta) \quad (1.57)$$

$$C_{\text{SC}}(x, \Theta) = \min_\theta C(x, \theta, \Theta) \quad (1.58)$$

Under not-too-onerous conditions on the underlying data-generating process and the model class Θ [185, chapter 3], as we provide more data θ_{MDL} will converge on the model in Θ which minimizes the generalization error, which here is just the same as minimizing the Kullback-Leibler divergence from the true distribution²⁵.

Regarded as a principle of model selection, MDL has proved very successful in many applications, even when dealing with quite intricate, hierarchically-layered model classes. ([186] is a nice recent application to a biomedical complex system; see §1.3.4 for applications to state-space reconstruction.) It is important to recognize, however, that most of this success comes from carefully tuning the model-coding term $D(\theta, \Theta)$ so that models which do not generalize well turn out to have long encodings. This is perfectly legitimate, but it relies on the tact and judgment of the scientist, and often, in dealing with a complex system, we have no idea, or at least no *good* idea, what generalizes and what does not. If we were malicious, or short-sighted, we can always insure that the particular data we got have a stochastic complexity of just one bit²⁶. The model which gives us this complexity will then have absolutely horrible generalization properties²⁷.

Whatever its merits as a model selection method, stochastic complexity does not make a good measure of the complexity of natural systems. There are at least three reasons for this.

- 1 The dependence on the model-encoding scheme, already discussed.
- 2 The log-likelihood term, $L(x, \theta)$ in C_{SC} can be decomposed into two parts, one of which is related to the entropy rate of the data-generating process, and so reflects its intrinsic unpredictability. The other, however, indicates the degree to which even the most accurate model in Θ is misspecified. Thus it reflects our ineptness as modelers, rather than any characteristic of the process.
- 3 Finally, the stochastic complexity reflects the need to specify some particular model, and to represent this specification. While this is necessarily a part of the modeling process for us, it seems to have no *physical* significance; the system does not need to *represent* its organization, it just *has* it.

8.3.2 Complexity via Prediction.

Forecast Complexity and Predictive Information. Motivated in part by concerns such as these, Grassberger [187] suggested a new and highly satisfactory approach to system complexity: complexity is the amount of information required for optimal prediction. Let us first see why this idea is plausible, and then see how it can be implemented in practice. (My argument does not follow that of Grassberger particularly closely. Also, while I confine myself to time series, for clarity, the argument generalizes to any kind of prediction [188].)

We have seen that there is a limit on the accuracy of any prediction of a given system, set by the characteristics of the system itself (limited precision of measurement, sensitive dependence on initial conditions, etc.). Suppose we had a model which was maximally predictive, i.e., its predictions were at this limit of accuracy. Prediction, as I said, is always a matter of mapping inputs to outputs; here the inputs are the previous values of the time series. However, not all aspects of the entire past are relevant. In the extreme case of independent, identically-distributed values, *no* aspects of the past are relevant. In the case of periodic sequences with period p , one only needs to know which of the p phases the sequence is in. If we ask how *much* information about the past is relevant in these two cases, the answers are clearly 0 and $\log p$, respectively. If one is dealing with a Markov chain, only the present state is relevant, so the amount of information needed for optimal prediction is just equal to the amount of information needed to specify the current state. One thus has the nice feeling that both highly random (IID) and highly ordered (low-period deterministic) sequences are of low complexity, and more interesting cases can get high scores.

More formally, any predictor f will translate the past of the sequence x^- into an effective state, $s = f(x^-)$, and then make its prediction on the basis of s . (This is true whether f is formally a state-space model or not.) The amount of information required to specify the state is $H[S]$. We can take this to be the complexity of f . Now, if we confine our attention to the set \mathcal{M} of maximally predictive models, we can define what Grassberger called the “true measure complexity” or “forecast complexity” of the process as the minimal amount of information needed for optimal prediction:

$$C = \min_{f \in \mathcal{M}} H[f(X^-)] \quad (1.59)$$

Grassberger did not provide a procedure for finding the maximally predictive models, nor for minimizing the information required among them. He did, however, make the following observation. A basic result of information theory, called the **data-processing inequality**, says that $I[A; B] \geq I[f(A); B]$, for any variables A and B — we cannot get more information out of data by processing it than was in there to begin with. Since the state of the predictor is a function of the past, it follows that $I[X^-; X^+] \geq I[f(X^-); X^+]$. Presumably, for optimal predictors, the two informations are equal — the predictor’s state is just as informative as the original data. (Otherwise, the model would be missing some potential predictive power.) But another basic inequality is that $H[A] \geq I[A; B]$ — no variable contains more information about another than it does about itself. So, for optimal models, $H[f(X^-)] \geq I[X^-; X^+]$.

The latter quantity, which Grassberger called the **effective measure complexity**, can be estimated purely from data, without intervening models. This quantity — the mutual information between the past and the future — has been rediscovered many times, in many contexts, and called **excess entropy** (in statistical mechanics), **stored information** [189], **complexity** [190–192] or **predictive information** [193]; the last name is perhaps the clearest. Since it quantifies the degree of statistical dependence between the past and the future, it is clearly appealing as a measure of complexity.

The Grassberger-Crutchfield-Young Statistical Complexity.

The forecasting complexity notion was made fully operational by Crutchfield and Young [102, 194], who provided an effective procedure for finding the minimal maximally predictive model and its states. They began by defining the **causal states** of a process, as follows. For each history x^- , there is some conditional distribution of future observations, $\Pr(X^+|x^-)$. Two histories x_1^- and x_2^- are equivalent if $\Pr(X^+|x_1^-) = \Pr(X^+|x_2^-)$. Write the set of all histories equivalent to x^- as $[x^-]$. Now we have a function ϵ which maps each history into its equivalence class: $\epsilon(x^-) = [x^-]$. Clearly, $\Pr(X^+|\epsilon(x^-)) = \Pr(X^+|x^-)$. Crutchfield and Young accordingly proposed to forget the particular history and retain only its equivalence class, which they claimed would involve no loss of predictive power; this was later proved to be correct [195, theorem 1]. They called the equivalence classes the “causal states” of the process, and claimed that these were the simplest states with maximal predictive power; this is also was right [195, theorem 2]. Finally, one can show that the causal states are the *unique* optimal states [195, theorem 3]; any other optimal predictor is really a disguised version of the causal states. Accordingly, they defined the **statistical complexity** of a process C as the information content of its causal states.

Because the causal states are purely an objective property of the process being considered, C is too; it does not depend at all on our modeling or means of description. It is equal to the length of the shortest description of the past which is *relevant* to the actual dynamics of the system. As we argued should be the case above, for IID sequences it is exactly 0, and for periodic sequences it is $\log p$. One can show [195, theorems 5 and 6] that the statistical complexity is always at least as large as the predictive information, and generally that it measures how far the system departs from statistical independence.

The causal states have, from a statistical point of view, quite a number of desirable properties. The maximal prediction property corresponds exactly to that of being a sufficient statistic [159]; in fact they are mini-

mal sufficient statistics [159, 195]. The sequence of states of the process form a Markov chain. Referring back to our discussion of filtering and state estimation (§1.3.5), one can design a recursive filter which will eventually estimate the causal state without any error at all; moreover, it is always clear whether the filter has “locked on” to the correct state or not.

All of these properties of the causal states and the statistical complexity extend naturally to spatially-extended systems, including, but not limited to, cellular automata [196, 197]. Each point in space then has its own set of causal states, which form not a Markov chain but a Markov field, and the local causal state is the minimal sufficient statistic for predicting the future of that point. The recursion properties carry over, not just temporally but spatially: the state at one point, at one time, helps determine not only the state at that same point at later times, but also the state at neighboring points at the same time. The statistical complexity, in these spatial systems, becomes the amount of information needed about the past of a given point in order to optimally predict its future. Systems with a high degree of local statistical complexity are ones with intricate spatio-temporal organization, and, experimentally, increasing statistical complexity gives a precise formalization of intuitive notions of self-organization [197].

Crutchfield and Young were inspired by analogies to the theory of abstract automata, which led them to call their theory, somewhat confusingly, **computational mechanics**. Their specific initial claims for the causal states were based on a procedure for deriving the minimal automaton capable of producing a given family of sequences²⁸ known as Nerode equivalence classing [198]. In addition to the theoretical development, the analogy to Nerode equivalence-classing led them to describe a procedure [102] for estimating the causal states and the ϵ -machine from empirical data, at least in the case of discrete sequences. This Crutchfield-Young algorithm has actually been successfully used to analyze empirical data, for instance, geomagnetic fluctuations [199]. The algorithm has, however, been superseded by a newer algorithm which uses the known properties of the causal states to guide the model discovery process [105] (see §1.3.6.3 above).

Let me sum up. The Grassberger-Crutchfield-Young statistical complexity is an objective property of the system being studied. It reflects the *intrinsic* difficulty of predicting it, namely the amount of information which is actually relevant to the system’s dynamics. It is low both for highly disordered and trivially-ordered systems. Above all, it is calculable, and has actually been calculated for a range of natural and mathematical systems. While the initial formulation was entirely in terms

of discrete time series, the theory can be extended straightforwardly to spatially-extended dynamical systems [196], where it quantifies self-organization [197], to controlled dynamical systems and transducers, and to prediction problems generally [188].

8.4 Power Law Distributions

Over the last decade or so, it has become reasonably common to see people (especially physicists) claiming that some system or other is complex, because it exhibits a power law distribution of event sizes. Despite its popularity, this is simply a fallacy. No one has demonstrated any relation between power laws and any kind of formal complexity measure. Nor is there any link tying power laws to our intuitive idea of complex systems as ones with strongly interdependent parts.

It is true that, *in equilibrium statistical mechanics*, one does not find power laws *except* near phase transitions [200], when the system *is* complex by our standard. This has encouraged physicists to equate power laws as such with complexity. Despite this, it has been known for half a century [5] that there are many, many ways of generating power laws, just as there are many mechanisms which can produce Poisson distributions, or Gaussians. Perhaps the simplest one is that recently demonstrated by Reed and Hughes [201], namely exponential growth coupled with random observation times. The observation of power laws alone thus says nothing about complexity (except in thermodynamic equilibrium!), and certainly is not a reliable sign of some specific favored mechanism, such as self-organized criticality [202, 203] or highly-optimized tolerance [204–206].

8.4.1 Statistical Issues Relating to Power Laws. The statistics of power laws are poorly understood within the field of complex systems, to a degree which is quite surprising considering how much attention has been paid to them. To be quite honest, there is little reason to think that many of the things claimed to be power laws actually *are* such, as opposed to some other kind of heavy-tailed distribution. This brief section will attempt to inoculate the reader against some common mistakes, most of which are related to the fact that a power law makes a straight line on a log-log plot. Since it would be impractical to cite all papers which commit these mistakes, and unfair to cite only some of them I will omit references here; interested readers will be able to assemble collections of their own very rapidly.

Parameter Estimation. Presuming that something is a power law, a natural way of estimating its exponent is to use linear regression

to find the line of best fit to the points on the log-log plot. This is actually a consistent estimator, if the data really do come from a power law. However, the loss function used in linear regression is the sum of the squared distances between the line and the points (“least squares”). In general, the line minimizing the sum of squared errors is *not* a valid probability distribution, and so this is simply not a reliable way to estimate the *distribution*.

One is much better off using maximum likelihood to estimate the parameter. With a discrete variable, the probability function is $\Pr(X = x) = x^{-\alpha}/\zeta(\alpha)$, where $\zeta(\alpha) = \sum_{k=1}^{\infty} k^{-\alpha}$ is the Riemann zeta function, which ensures that the probability is normalized. Thus the maximum likelihood estimate of the exponent is obtained by minimizing the negative log-likelihood, $L(\alpha) = \sum_i \alpha \log x_i + \log \zeta(\alpha)$, i.e., $L(\alpha)$ is our loss function. In the continuous case, the probability density is $(\alpha - 1)c^{\alpha-1}/x^\alpha$, with $x \geq c > 0$.

Error Estimation. Most programs to do linear regression also provide an estimate of the standard error in the estimated slope, and one sometimes sees this reported as the uncertainty in the power law. This is an entirely unacceptable procedure. Those calculations of the standard error assume that measured values having Gaussian fluctuations around their true means. Here that would mean that the log of the empirical relative frequency is equal to the log of the probability plus Gaussian noise. However, by the central limit theorem, one knows that the relative frequency is equal to the probability plus Gaussian noise, so the former condition does not hold. Notice that one can obtain asymptotically reliable standard errors from maximum likelihood estimation.

Validation; R^2 . Perhaps the most pernicious error is that of trying to validate the assumption of a power law distribution by either eyeballing the fit to a straight line, or evaluating it using the R^2 statistic, i.e., the fraction of the variance accounted for by the least-squares regression line. Unfortunately, while these procedures are good at confirming that something is a power law, if it really is (low Type I error, or high statistical significance), they are very bad at alerting you to things that are *not* power laws (they have a very high rate of Type II error, or low statistical power). The basic problem here is that *any* smooth curve looks like a straight line, if you confine your attention to a sufficiently small region — and for some non-power-law distributions, such “sufficiently small” regions can extend over multiple orders of magnitude.

To illustrate this last point, consider Figure 1.5, made by generating 10,000 random numbers according to a log-normal distribution, with a

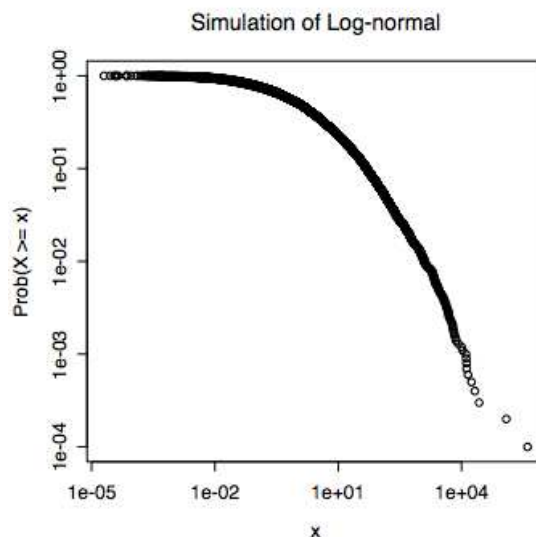

Figure 1.5. Distribution of 10,000 random numbers, generated according to a log-normal distribution with $\mathbf{E}[\log X] = 0$ and $\sigma(\log X) = 3$.

mean log of 0 and a standard deviation in the log of 3. Restricting attention to the “tail” of random numbers ≥ 1 , and doing a usual least-squares fit, gives the line shown in Figure 1.6. One might hope that it would be easy to tell that this data does not come from a power law, since there are a rather large number of observations (5,112), extending over a wide domain (more than four orders of magnitude). Nonetheless, R^2 is 0.962. This, in and of itself, constitutes a demonstration that getting a high R^2 is not a reliable indicator that one’s data was generated by a power law.²⁹

An Illustration: Blogging. An amusing empirical illustration of the difficulty of distinguishing between power laws and other heavy-tailed distributions is provided by political weblogs, or “blogs” — websites run by individuals or small groups providing links and commentary on news, political events, and the writings of other blogs. A rough indication of the prominence of a blog is provided by the number of other blogs linking to it — its **in-degree**. (For more on network terminology, see Wuchty, Ravasz and Barabási, this volume.) A widely-read essay by Shirky claimed that the distribution of in-degree follows a power law, and used that fact, and the literature on the growth of scale-free net-

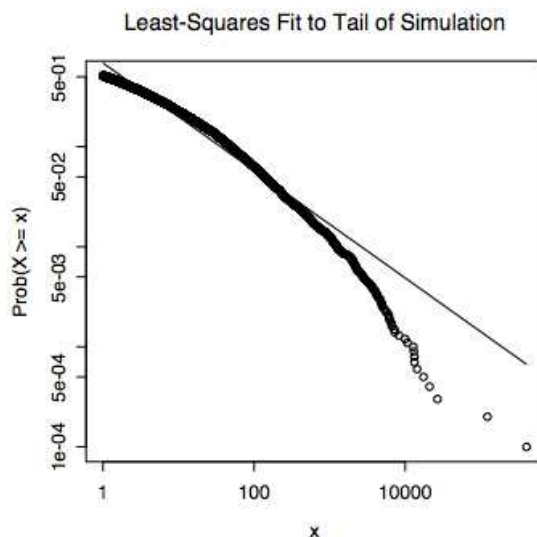

Figure 1.6. Inability of linear regression on log-log plots to correctly identify power law distributions. Simulation data (circles) and resulting least-squares fit (line) for the 5,112 points in Figure 1.5 for which $x \geq 1$. The R^2 of the regression line is 0.962.

works, to draw a number of conclusions about the social organization of the blogging community [207]. A more recent paper by Drenzer and Farrell [208], in the course of studying the role played by blogs in general political debate, re-examined the supposed power-law distribution.³⁰ Using a large population of inter-connected blogs, they found a definitely heavy-tailed distribution which, on a log-log plot, was quite noticeably concave (1.7); nonetheless, R^2 for the conventional regression line was 0.898.

Maximum likelihood fitting of a power law distribution gave $\alpha = -1.30 \pm 0.006$, with a negative log-likelihood of 18481.51. Similarly fitting a log-normal distribution gave $\mathbf{E}[\log X] = 2.60 \pm 0.02$ and $\sigma(\log X) = 1.48 \pm 0.02$, with a negative log-likelihood of 17,218.22. As one can see from Figure 1.8, the log-normal provides a very good fit to almost all of the data, whereas even the best fitting power-law distribution is not very good at all.³¹

A rigorous application of the logic of error testing [50] would now consider the probability of getting at least this good a fit to a log-normal if the data were actually generated by a power law. However, since in this case the data were $e^{18481.51 - 17218.22} \approx 13$ million times more likely

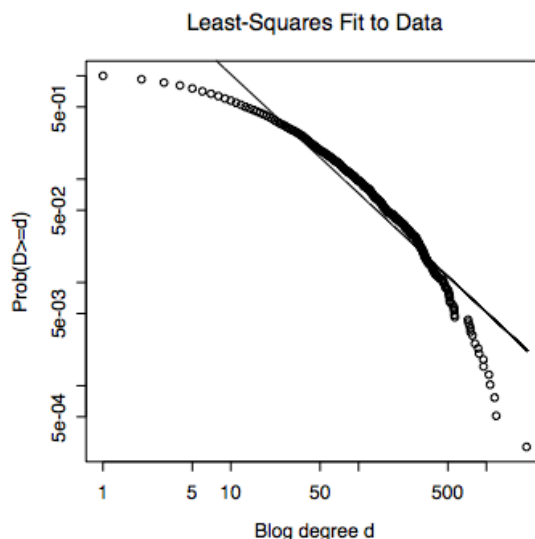

Figure 1.7. Empirical distribution of the in-degrees of political weblogs (“blogs”). Horizontal axis: number of incoming links d ; vertical axis: fraction of all blogs with at least that many links, $\Pr(D \geq d)$; both axes are on a log-log scale. Circles show the actual distribution; the straight line is a least-squares fit to these values. This does not produce a properly normalized probability distribution but it does have an R^2 of 0.898, despite the clear concavity of the curve.

under the log-normal distribution, any sane test would reject the power-law hypothesis.

8.5 Other Measures of Complexity

Considerations of space preclude an adequate discussion of further complexity measures. It will have to suffice to point to some of the leading ones. The **thermodynamic depth** of Lloyd and Pagels [182] measures the amount of information required to specify a trajectory leading to a final state, and is related both to departure from thermodynamic equilibrium and to retrodiction [209]. Huberman and Hogg [210], and later Wolpert and Macready [211] proposed to measure complexity as the *dissimilarity* between different levels of a given system, on the grounds that self-similar structures are actually very easy to describe. (Say what one level looks like, and then add that all the rest are the same!) Wolpert and Macready’s measure of self-dissimilarity is, in turn, closely related to a complexity measure proposed by Sporns, Tononi and

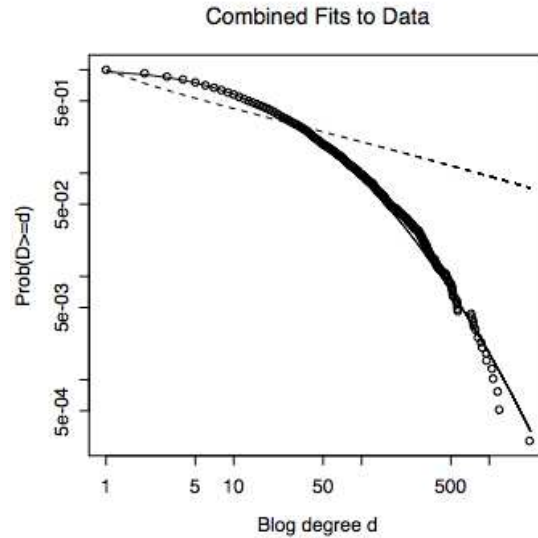

Figure 1.8. Maximum likelihood fits of log-normal (solid line) and power law (dashed line) distributions to the data from Figure 1.7 (circles); axes as in that figure. Note the extremely tight fit of the log-normal over the whole range of the curve, and the general failure of the power-law distribution.

Edelman [212–214] for biological networks, which is roughly the amount of information present in higher-order interactions between nodes which is not accounted for by the lower-order interactions. Badii and Politi [10] propose a number of further **hierarchical scaling complexities**, including one which measures how slowly predictions converge as more information about the past becomes available. Other interesting approaches include the **information fluctuation** measure of Bates and Shepard [215], and the predictability indices of the “school of Rome” [216].

8.6 Relevance of Complexity Measures

Why measure complexity at all? Suppose you are interested in the patterns of gene expressions in tumor cells and how they differ from those of normal cells. Why should you care if I analyze your data and declare that (say) healthy cells have a more complex expression pattern? Assuming you are not a numerologist, the only reason you *should* care is if you can learn something from that number — if the complexity I report tells you something about the thermodynamics of the system,

how it responds to fluctuations, how easy it is to control, etc. A good complexity measure, in other words, is one which is *relevant* to many other aspects of the system measured. A bad complexity measure lacks such relevance; a really bad complexity measure would be positively misleading, lumping together things with no real connection or similarity just because they get the same score. My survey here has focused on complexity measures which have some claim to relevance, deliberately avoiding the large number of other measures which lack it [217].

9. Guide to Further Reading

9.1 General

There is no systematic or academically-detailed survey of the “patterns” of complex systems, but there are several sound informal discussions: Axelrod and Cohen [218], Flake [219], Holland [220] and Simon [221]. The book by Simon, in particular, repays careful study.

On the “topics”, the only books I can recommend are the ones by Boccaro [222] and Flake [219]. The former emphasizes topics from physics, chemistry, population ecology and epidemiology, along with analytical methods, especially from nonlinear dynamics. Some sections will be easier to understand if one is familiar with statistical mechanics at the level of, e.g., [200], but this is not essential. It does not, however, describe any models of adaptation, learning, evolution, etc. Many of those topics are covered in Flake’s book, which however is written at a much lower level of mathematical sophistication.

On foundational issues about complexity, the best available surveys [10, 195] both neglect the more biological aspects of the area, and assume advanced knowledge of statistical mechanics on the part of their readers.

9.2 Data Mining and Statistical Learning

There are now two excellent introductions to statistical learning and data mining, [223] and [31]. The former is more interested in computational issues and the initial treatment of data; the latter gives more emphasis to pure statistical aspects. Both are recommended unreservedly. Baldi and Brunak [95] introduces machine learning via its applications to bioinformatics, and so may be especially suitable for readers of this book.

For readers seriously interested in understanding the theoretical basis of machine learning, [224] is a good starting point. The work of Vapnik [22, 225, 226] is fundamental; the presentation in his [22] is enlivened by many strong and idiosyncratic opinions, pungently expressed. [40] de-

scribes the very useful class of models called “support vector machines”, as well as giving an extremely clear exposition of key aspects of statistical learning theory. Those interested in going further will find that most of the relevant literature is still in the form of journals — *Machine Learning*, *Journal of Machine Learning Research* (free on-line at www.jmlr.org), *Neural Computation* — and especially annual conference proceedings — Computational Learning Theory (COLT), International Conference on Machine Learning (ICML), Uncertainty in Artificial Intelligence (UAI), Knowledge Discovery in Databases (KDD), Neural Information Processing Systems (NIPS), and the regional versions of them (EuroCOLT, Pacific KDD, etc.).

Much of what has been said about model selection could equally well have been said about what engineers call **system identification**, and in fact *is* said in good modern treatments of that area, of which [227] may be particularly recommended.

In many respects, data mining is an extension of exploratory data analysis; the classic work by Tukey [228] is still worth reading. No discussion of drawing inferences from data would be complete without mentioning the beautiful books by Tufte [229–231].

9.3 Time Series

Perhaps the best all-around references for the nonlinear dynamics approach are [69] and [232]. The former, in particular, succeeds in integrating standard principles of statistical inference into the nonlinear dynamics method. [73], while less advanced than those two books, is a model of clarity, and contains an integrated primer on chaotic dynamics besides. Ruelle’s little book [162] is *much* more subtle than it looks, full of deep insights. The SFI proceedings volumes [233, 234] are very worthwhile. The journals *Physica D*, *Physical Review E* and *Chaos* often have new developments.

From the statistical wing, one of the best recent textbooks is [55]; there are many, many others. That by Durbin and Koopman [60] is particularly strong on the state-space point of view. The one by [235] Azencott and Dacunha-Castelle is admirably clear on both the aims of time series analysis, and the statistical theory underlying classical methods; unfortunately its typography is less easy to read than it should be. [236] provides a comprehensive and up-to-date view of the statistical theory for modern models, including strongly non-linear and non-Gaussian models. While many of the results are directly useful in application, the proofs rely on advanced theoretical statistics, in particular the geometric approach pioneered by the Japanese school of Amari *et al.* [237], This

information geometry has itself been applied by Ay to the study of complex systems [238, 239].

At the interface between the statistical and the dynamical points of view, there is an interesting conference proceedings [240] and a useful book by Tong [241]. Pearson's book [242] on discrete-time models is very good on many important issues related to model selection, and exemplifies the habit of control theorists of cheerful stealing whatever seems helpful.

Filtering. Linear filters are well-described by many textbooks in control theory (e.g. [243]), signal processing, time series analysis (e.g. [55]) and stochastic dynamics (e.g. [58]).

[89] provides a readable introduction to optimal nonlinear estimation, draws interesting analogies to non-equilibrium statistical mechanics and turbulence, *and* describes a reasonable approximation scheme. [90] is an up-to-date textbook, covering both linear and nonlinear methods, and including a concise exposition of the essential parts of stochastic calculus. The website run by R. W. R. Darling, www.nonlinearfiltering.webhop.net, provides a good overview and extensive pointers to the literature.

Symbolic Dynamics and Hidden Markov Models. On symbolic dynamics, formal languages and hidden Markov models generally, see [10]. [198] is a good first course on formal languages and automata theory. Charniak is a very readable introduction to grammatical inference. [244] is an advanced treatment of symbolic dynamics emphasizing applications; by contrast, [116] focuses on algebraic, pure-mathematical aspects of the subject. [163] is good on the stochastic properties of symbolic-dynamical representations. Gershenfeld [245] gives a good motivating discussion of hidden Markov models, as does Baldi and Brunak [95], while [94] describes advanced methods related to statistical signal processing. Open-source code for reconstructing causal-state models from state is available from <http://bactra.org/CSSR>.

9.4 Cellular Automata

General. There is unfortunately no completely satisfactory unified treatment of cellular automata above the recreational. Ilachinski [246] attempts a general survey aimed at readers in the physical sciences, and is fairly satisfactory on purely mathematical aspects, but is more out of date than its year of publication suggests. Chopard and Droz [247] has good material on models of pattern formation missing from Ilachinski, but the English is often choppy. Toffoli and Margolus [248] is inspiring and sound, though cast on a piece of hardware and a programming

environment which are sadly no longer supported. Much useful material on CA modeling has appeared in conference proceedings [249–251].

CA as Self-Reproducing Machines. The evolution of CA begins in [252], continues in [253], and is brought up to the modern era in [254]; the last is a beautiful, thought-provoking and modest book, sadly out of print. The modern era itself opens with [255].

Mathematical and Automata-Theoretic Aspects. Many of the papers in [256] are interesting. Ilachinski [246], as mentioned, provides a good survey. The Gutowitz volume [250] has good material on this topic, too. [257] is up-to-date.

Lattice gases. [124] is a good introduction, [258] somewhat more advanced. The pair of proceedings edited by Doolen [259, 260] describe many interesting applications, and contain useful survey and pedagogical articles. (There is little overlap between the two volumes.)

9.5 Agent-Based Modeling

There do not seem to be any useful textbooks or monographs on agent-based modeling. The *Artificial Life* conference proceedings, starting with [255], were a prime source of inspiration for agent-based modeling, along with the work of Axelrod [261]. [262] is also worth reading. The journal *Artificial Life* continues to be relevant, along with the *From Animals to Animats* conference series. Epstein and Axtell’s book [263] is in many ways the flagship of the “minimalist” approach to ABMs; while the arguments in its favor (e.g., [264, 265]) are often framed in terms of social science, many apply with equal force to biology³². [266] illustrates how ABMs can be combined with extensive real-world data. Other notable publications on agent-based models include [267], spanning social science and evolutionary biology; [268] on agent-based models of morphogenesis; and [269] on biological self-organization.

[131] introduces object-oriented programming and the popular Java programming language at the same time; it also discusses the roots of object-orientation in computer simulation. There are many, many other books on object-oriented programming.

9.6 Evaluating Models of Complex Systems

Honerkamp [58] is great, but curiously almost unknown. Gershenfeld [245] is an extraordinary readable encyclopedia of applied mathematics,

especially methods which can be used on real data. Gardiner [270] is also useful.

Monte Carlo. The old book by Hammersley and Handscomb [140] is concise, clear, and has no particular prerequisites beyond a working knowledge of calculus and probability. [271] and [272] are both good introductions for readers with some grasp of statistical mechanics. There are also very nice discussions in [58, 31, 142]. Beckerman [143] makes Monte Carlo methods the starting point for a fascinating and highly unconventional exploration of statistical mechanics, Markov random fields, synchronization and cooperative computation in neural and perceptual systems.

Experimental design. Bypass the cookbook texts on standard designs, and consult Atkinson and Donev [155] directly.

Ecological inference. [273] is at once a good introduction, and the source of important and practical new methods.

9.7 Information Theory

Information theory appeared in essentially its modern form with Shannon's classic paper [274], though there had been predecessors in both communications [275] and statistics, notably Fisher (see Kullback [159] for an exposition of these notions), and similar ideas were developed by Wiener and von Neumann, more or less independently of Shannon [56]. Cover and Thomas [158] is, deservedly, the standard modern textbook and reference; it is highly suitable as an introduction, and handles almost every question most users will, in practice, want to ask. [276] is a more mathematically rigorous treatment, now free on-line. On neural information theory, [172] is seminal, well-written, still very valuable, and largely self-contained. On the relationship between physics and information, the best reference is still the volume edited by Zurek [12], and the thought-provoking paper by Margolus.

9.8 Complexity Measures

The best available survey of complexity measures is that by Badii and Politi [10]; the volume edited by Peliti and Vulpiani [277], while dated, is still valuable. Edmonds [278] is an online bibliography, fairly comprehensive through 1997. [195] has an extensive literature review.

On Kolmogorov complexity, see Li and Vitanyi [177]. While the idea of measuring complexity by the length of descriptions is usually cred-

ited to the trio of Kolmogorov, Solomonoff and Chaitin, it is implicit in von Neumann’s 1949 lectures on the “Theory and Organization of Complicated Automata” [252, Part I, especially pp. 42–56].

On MDL, see Rissanen’s book [185], and Grünwald’s lecture notes [279]. Vapnik [22] argues that when MDL converges on the optimal model, SRM will too, but he assumes independent data.

On statistical complexity and causal states, see [195] for a self-contained treatment, and [188] for extensions of the theory.

Acknowledgments

This work has been supported by a grant from the James S. McDonnell Foundation, and was finished while enjoying the hospitality of the Institut des Systèmes Complexes, the Laboratoire de l’Informatique du Parallélisme and the Exsistence Thematic Institute on Discrete and Computational Aspects of Complex Systems at the École Normale Supérieure de Lyon. I am grateful to Michel Morvan and Cris Moore, organizers of the “Science et Gastronomie 2003” workshop, for allowing me to present some of this material there, and to my fellow participants for their critical comments. It is a pleasure to acknowledge discussions with Dave Albers, Satinder Singh Baveja, Philippe Binder, Sven Bruckener, Sandra Chapman, Markus Christen, Michael Cohen, Jim Crutchfield, Gunther Eble, Dave Feldman, Walter Fontana, Peter Grassberger, Rob Haslinger, John Holland, Herbert Jaeger, Jürgen Jost, Michael Lachmann, Alex Lancaster, Norm Margolus, Cris Moore, Mark Newman, Scott Page, Mitchell Porter, Kristina Shalizi, Carl Simon, Eric Smith, Ricard Solé, Bill Tozier, Erik van Nimwegen and Nick Watkins. Special thanks to Prof. Cohen for permission to take a triangle he drew and add a corner to it; to Profs. Drenzer and Farrell for permission to use their data on weblogs; to Bill Tozier for suggesting that the leitmotifs of complex systems are analysis patterns, and for advice on agents; to Kara Kedi for daily validation of von Neumann’s remarks on the complexity of cats; to Mathew Dafilis and Nigel Phillips for spotting misprints; to Kristina Shalizi for assistance on linear models of time series and for careful reading of a draft; and to Kristina and Rob for resisting the idea that there *is* such a thing as complex systems science. Finally, I wish to acknowledge the patience of the editors.

Notes

1. Several books pretend to give a unified presentation of the topics. To date, the only one worth reading is [222], which however omits all models of adaptive systems.
2. Not all data mining is strictly for predictive models. One can also mine for purely descriptive models, which try to, say, cluster the data points so that more similar ones are closer

together, or just assign an over-all likelihood score. These, too, can be regarded as minimizing a cost function (e.g., the dis-similarity within clusters plus the similarity across clusters). The important point is that good descriptions, in this sense, are implicitly predictive, either about other aspects of the data or about further data from the same source.

3. A subtle issue can arise here, in that not all errors need be equally bad for us. In scientific applications, we normally aim at accuracy as such, and so all errors *are* equally bad. But in other applications, we might care very much about otherwise small inaccuracies in some circumstances, and shrug off large inaccuracies in others. A well-designed loss function will represent these desires. This does not change the basic principles of learning, but it can matter a great deal for the final machine [280].

4. Here and throughout, I try to follow the standard notation of probability theory, so capital letters (X, Y , etc.) denote random variables, and lower-case ones particular values or realizations — so X = the role of a die, whereas $x = 5$ (say).

5. This is called the **convergence in probability** of $\hat{L}(\theta)$ to its mean value. For a practical introduction to such convergence properties, the necessary and sufficient conditions for them to obtain, and some thoughts about what one can do, statistically, when they do not, see [51].

6. The precise definition of the VC dimension is somewhat involved, and omitted here for brevity's sake. See [224, 40] for clear discussions.

7. For instance, one can apply the independent-sample theory to learning feedback control systems [281].

8. Actually, the principle goes back to Aristotle at least, and while Occam used it often, he never used exactly those words [282, translator's introduction].

9. This is very close to the notion of the power of a statistical hypothesis test [283], and almost exactly the same as the severity of such a test [50].

10. One could, of course, build a filter which uses later y values as well; this is a **non-causal** or **smoothing** filter. This is clearly not suitable for estimating the state in real time, but often gives more accurate estimates when it is applicable. The discussion in the text generally applies to smoothing filters, at some cost in extra notation.

11. Equivalent terms are **future-resolving** or **right-resolving** (from nonlinear dynamics) and **deterministic** (the highly confusing contribution of automata theory).

12. Early publications on this work started with the assumption that the discrete values were obtained by dividing continuous measurements into bins of width ϵ , and so called the resulting models “ ϵ -machines”. This name is unfortunate: that is usually a bad way of discretizing data (§1.3.6.4), the quantity ϵ plays no role in the actual theory, and the name is more than usually impenetrable to outsiders. While I have used it extensively myself, it should probably be avoided.

13. An alternate definition [10] looks at the entropy rate (§1.7) of the symbol sequences: a generating partition is one which maximizes the entropy rate, which is the same as maximizing the extra information about the initial condition x provided by each symbol of the sequence $\Phi(x)$.

14. Quantum versions of CA are an active topic of investigation, but unlikely to be of biological relevance [246].

15. In a talk at the Santa Fe Institute, summer of 2000; the formula does not seem to have been published.

16. A simple argument just invokes the central limit theorem. The number of points falling within the shaded region has a binomial distribution, with success parameter p , so asymptotically x/n has a Gaussian distribution with mean p and standard deviation $\sqrt{p(1-p)/n}$. A non-asymptotic result comes from Chernoff's inequality [281], which tells us that, for all n , $\Pr(|x/n - p| \geq \epsilon) < 2e^{-2n\epsilon^2}$.

17. The chain needs to be irreducible, meaning one can go from any point to any other point, and positive recurrent, meaning that there's a positive probability of returning to any point infinitely often.

18. Unless our choices for the transition probabilities are fairly perverse, the central limit theorem still holds, so asymptotically our estimate still has a Gaussian distribution around

the true value, and still converges as $N^{-1/2}$ for large enough N , but determining what’s “large enough” is trickier.

19. An important exception is the case of equilibrium statistical mechanics, where the dynamics under the Metropolis algorithm *are* like the real dynamics.

20. For a pedagogical discussion, with examples, of how compression algorithms may be misused, see <http://bactra.org/notebooks/cep-gzip.html>.

21. The issue of what language to write the program in is secondary; writing a program to convert from one language to another just adds on a constant to the length of the over-all program, and we will shortly see why additive constants are not important here.

22. Very short programs can calculate π to arbitrary accuracy, and the length of these programs does not grow as the number of digits calculated does. So one could run one of these programs until it had produced the first two quadrillion digits, and then erase the first half of the output, and stop.

23. [167] is perhaps the most notorious; see [168] and especially [169] for critiques.

24. It is certainly legitimate to regard any dynamical process as also a computational process, [284–286, 195], so one could argue that the data *is* produced by some kind of program. But even so, this computational process generally does not resemble that of the minimal, Kolmogorov program at all.

25. It is important to note [185, chapter 3] that if we allowed any possible model in Θ , find the minimum would, once again, be incomputable. This restriction to a definite, perhaps hierarchically organized, class of models is vitally important.

26. Take our favorite class of models, and add on deterministic models which produce particular fixed blocks of data with probability 1. For any of these models θ , $L(x, \theta)$ is either 0 (if x is what that model happens to generate) or ∞ . Then, once we have our data, and find a θ which generates that and nothing but that, re-arrange the coding scheme so that $D(\theta, \Theta) = 1$; this is always possible. Thus, $C_{SC}(x, \Theta) = 1$ bit.

27. This does not contradict the convergence result of the last paragraph; one of the not-too-onerous conditions mentioned in the previous paragraph is that the coding scheme remain fixed, and we’re violating that.

28. Technically, a given regular language (§1.3.6).

29. If I replace the random data by the *exact* log-normal probability distribution over the same range, and do a least-squares fit to that, the R^2 actually increases, to 0.994.

30. Profs. Drenzer and Farrell kindly shared their data with me, but the figures and analysis that follow are my own.

31. Note that the log-normal curve fitted to the *whole* data continues to match the data well even in the tail. For further discussion, omitted here for reasons of space, see <http://bactra.org/weblog/232.html>.

32. In reading this literature, it may be helpful to bear in mind that by “methodological individualism”, social scientists mean roughly what biologists do by “reductionism”.

References

- [1] Erich Gamma, Richard Helm, Ralph Johnson, and John Vlissides. *Design Patterns: Elements of Reusable Object-Oriented Software*. Addison-Wesley, Reading, Massachusetts, 1995.
- [2] Russell W. Anderson. Random-walk learning: A neurobiological correlate to trial-and-error. In O. M. Omidvar and J. Dayhoff, editors, *Progress in Neural Networks*, pages 221–244. Academic Press, Boston, 1988.
- [3] S. Mueller, J. Marchettod, S. Airaghi, and P. Koumoutsakos. Optimization based on bacterial chemotaxis. *IEEE Transactions on*

Evolutionary Computation, 6:16–29, 2002.

- [4] Herbert A. Simon. The architecture of complexity: Hierarchic systems. *Proceedings of the American Philosophical Society*, 106:467–482, 1962. Reprinted as chapter 8 of [221].
- [5] Herbert A. Simon. On a class of skew distribution functions. *Biometrika*, 42:425–440, 1955.
- [6] Alan Turing. The chemical basis of morphogenesis. *Philosophical Transactions of the Royal Society B*, 237:37–72, 1952.
- [7] S. P. Strong, B. Freedman, William Bialek, and R. Koberle. Adaptation and optimal chemotactic strategy for *e. coli*. *Physical Review E*, 57:4604–4617, 1998. <http://arxiv.org/abs/adap-org/9706001>.
- [8] U. Alon, M. G. Surette, N. Barkai, and S. Leibler. Robustness in bacterial chemotaxis. *Nature*, 397:168–171, 1999.
- [9] Tau-Mu Yi, Yun Huang, Melvin I. Simon, and John Doyle. Robust perfect adaptation in bacterial chemotaxis through integral feedback control. *Proceedings of the National Academy of Sciences*, 97:4649–4653, 2000.
- [10] Remo Badii and Antonio Politi. *Complexity: Hierarchical Structures and Scaling in Physics*. Cambridge University Press, Cambridge, 1997.
- [11] Walter Fontana and Leo W. Buss. “The Arrival of the Fittest”: Towards a theory of biological organization. *Bulletin of Mathematical Biology*, 56:1–64, 1994. <http://www.santafe.edu/~walter/Papers/arrival.US.ps.gz>.
- [12] Wojciech H. Zurek, editor. *Complexity, Entropy, and the Physics of Information*, Reading, Massachusetts, 1990. Addison-Wesley.
- [13] Uriel Frisch. *Turbulence: The Legacy of A. N. Kolmogorov*. Cambridge University Press, Cambridge, England, 1995.
- [14] Mark C. Cross and Pierre Hohenberg. Pattern formation out of equilibrium. *Reviews of Modern Physics*, 65:851–1112, 1993.
- [15] Philip Ball. *The Self-Made Tapestry: Pattern Formation in Nature*. Oxford University Press, Oxford, 1999.
- [16] John H. Holland. *Adaptation in Natural and Artificial Systems: An Introductory Analysis with Applications to Biology, Control, and Artificial Intelligence*. MIT Press, Cambridge, Massachusetts, 2nd edition, 1992. First edition, Ann Arbor, Michigan: University of Michigan Press, 1975.

- [17] Melanie Mitchell. *An Introduction to Genetic Algorithms*. MIT Press, Cambridge, Massachusetts, 1996.
- [18] Herbert Gintis. *Game Theory Evolving: A Problem-Centered Introduction to Modeling Strategic Interaction*. Princeton University Press, Princeton, 2000.
- [19] Josef Hofbauer and Karl Sigmund. *The Theory of Evolution and Dynamical Systems: Mathematical Aspects of Selection*. Cambridge University Press, Cambridge, England, 1988.
- [20] K. H. Fischer and J. A. Hertz. *Spin Glasses*. Cambridge Studies in Magnetism. Cambridge University Press, Cambridge, 1988.
- [21] Daniel L. Stein. Spin glasses: Still complex after all these years? In T. Elze, editor, *Quantum Decoherence and Entropy in Complex Systems*, Berlin, 2003. Springer-Verlag.
- [22] Vladimir N. Vapnik. *The Nature of Statistical Learning Theory*. Springer-Verlag, Berlin, 2nd edition, 2000.
- [23] Hirotugu Akaike. Information theory and an extension of the maximum likelihood principle. In B. N. Petrov and F. Caski, editors, *Proceedings of the Second International Symposium on Information Theory*, pages 267–281, Budapest, 1973. Akademiai Kiado. Reprinted in [287, pp. 199–213].
- [24] Hirotugu Akaike. On entropy maximization principle. In P. R. Krishnaiah, editor, *Applications of Statistics*, pages 27–41, Amsterdam, 1977. North-Holland.
- [25] G. Schwarz. Estimating the dimension of a model. *The Annals of Statistics*, 6:461–464, 1978.
- [26] Sara van de Geer. *Empirical Processes in M-Estimation*. Cambridge University Press, Cambridge, England, 2000.
- [27] Earl Derr Biggers. *Behind That Curtain*. Grosset and Dunlap, New York, 1928.
- [28] Leslie G. Valiant. A theory of the learnable. *Communications of the Association for Computing Machinery*, 27:1134–1142, 1984.
- [29] Xuhui Shao, Vladimir Cherkassky, and William Li. Measuring the VC-dimension using optimized experimental design. *Neural Computation*, 12:1969–1986, 2000.
- [30] Ron Meir. Nonparametric time series prediction through adaptive model selection. *Machine Learning*, 39:5–34, 2000.
- [31] Trevor Hastie, Robert Tibshirani, and Jerome Friedman. *The Elements of Statistical Learning: Data Mining, Inference, and Prediction*. Springer-Verlag, New York, 2001.

- [32] Brian D. Ripley. *Pattern Recognition and Neural Networks*. Cambridge University Press, Cambridge, England, 1996.
- [33] Grace Wahba. *Spline Models for Observational Data*. Society for Industrial and Applied Mathematics, Philadelphia, 1990.
- [34] Martin Anthony and Peter L. Bartlett. *Neural Network Learning: Theoretical Foundations*. Cambridge University Press, Cambridge, England, 1999.
- [35] Achilleas Zapranis and Apostolos-Paul Refenes. *Principles of Neural Model Identification, Selection and Adequacy: With Applications to Financial Econometrics*. Springer-Verlag, London, 1999.
- [36] A. Engel and C. Van den Broeck. *Statistical Mechanics of Learning*. Cambridge University Press, Cambridge, England, 2001.
- [37] Leo Breiman, Jerome Friedman, R. Olshen, and C. Stone. *Classification and Regression Trees*. Wadsworth, Belmont, California, 1984.
- [38] Gerd Gigerenzer, Peter M. Todd, and the ABC Research Group. *Simple Heuristics That Make Us Smart*. Oxford University Press, Oxford, 1999.
- [39] Ralf Herbrich. *Learning Kernel Classifiers: Theory and Algorithms*. MIT Press, Cambridge, Massachusetts, 2002.
- [40] Nello Cristianini and John Shawe-Taylor. *An Introduction to Support Vector Machines: And Other Kernel-Based Learning Methods*. Cambridge University Press, Cambridge, England, 2000.
- [41] Judea Pearl. *Causality: Models, Reasoning, and Inference*. Cambridge University Press, Cambridge, England, 2000.
- [42] Glenn Shafer. *The Art of Causal Conjecture*. MIT Press, Cambridge, Massachusetts, 1996.
- [43] Peter Spirtes, Clark Glymour, and Richard Scheines. *Causation, Prediction, and Search*. MIT Press, Cambridge, Massachusetts, 2nd edition, 2001.
- [44] Peter Dayan, Geoffrey E. Hinton, Radford M. Neal, and Richard S. Zemel. The Helmholtz machine. *Neural Computation*, 7:889–904, 1995. <http://www.cs.utoronto.ca/~hinton/absps/helmholtz.htm>.
- [45] Pedro Domingos. The role of Occam’s Razor in knowledge discovery. *Data Mining and Knowledge Discovery*, 3:409–425, 1999. <http://www.cs.washington.edu/home/pedrod/dmkd99.pz.gz>.
- [46] Judy L. Klein. *Statistical Visions in Time: A History of Time Series Analysis, 1662–1938*. Cambridge University Press, Cambridge, England, 1997.

- [47] P. A. M. Dirac. *Principles of Quantum Mechanics*. Clarendon Press, Oxford, 1935.
- [48] Frank B. Knight. A predictive view of continuous time processes. *The Annals of Probability*, 3:573–596, 1975.
- [49] Frank B. Knight. *Foundations of the Prediction Process*, volume 1 of *Oxford Studies in Probability*. Clarendon Press, Oxford, 1992.
- [50] Deborah G. Mayo. *Error and the Growth of Experimental Knowledge*. University of Chicago Press, Chicago, 1996.
- [51] Robert M. Gray. *Probability, Random Processes, and Ergodic Properties*. Springer-Verlag, New York, 1988. <http://ee-www.stanford.edu/~gray/arp.html>.
- [52] Ishwar V. Basawa and David John Scott. *Asymptotic Optimal Inference for Non-Ergodic Models*. Springer-Verlag, Berlin, 1983.
- [53] Bruce J. West and Bill Deering. *The Lure of Modern Science: Fractal Thinking*. World Scientific, Singapore, 1995.
- [54] William H. Press, Saul A. Teukolsky, William T. Vetterling, and Brian P. Flannery. *Numerical Recipes in C: The Art of Scientific Computing*. Cambridge University Press, Cambridge, England, 2nd edition, 1992.
- [55] Robert H. Shumway and David S. Stoffer. *Time Series Analysis and Its Applications*. Springer Texts in Statistics. Springer-Verlag, New York, 2000.
- [56] Norbert Wiener. *Cybernetics: Or, Control and Communication in the Animal and the Machine*. MIT Press, Cambridge, Massachusetts, 2nd edition, 1961. First edition New York: Wiley, 1948.
- [57] Barbara B. Hubbard. *The World According to Wavelets: The story of a mathematical technique in the making*. A. K. Peters, Wellesley, Massachusetts, 1996.
- [58] Josef Honerkamp. *Stochastic Dynamical Systems: Concepts, Numerical Methods, Data Analysis*. VCH, New York, 1994. Translated by Katja Lindenberg.
- [59] G. E. P. Box and G. M. Jenkins. *Time Series Analysis, Forecasting, and Control*. Holden-Day, Oakland, California, 1970.
- [60] James Durbin and Siem Jam Koopman. *Time Series Analysis by State Space Methods*. Oxford University Press, Oxford, 2001.
- [61] Gregory L. Eyink. Linear stochastic models of nonlinear dynamical systems. *Physical Review E*, 58:6975–6991, 1998.
- [62] O. E. Barndorff-Nielsen, J. L. Jensen, and M. Sorensen. Parametric modelling of turbulence. *Philosophical Transactions of the Royal Society A*, 332:439–455, 1990.

- [63] Gregory L. Eyink and Francis J. Alexander. Predictive turbulence modeling by variational closure. *Journal of Statistical Physics*, 91:221–283, 1998.
- [64] Jan Beran. *Statistics for Long-Memory Processes*. Chapman and Hall, New York, 1994.
- [65] Paul Embrechts and Makoto Maejima. *Selfsimilar processes*. Princeton University Press, Princeton, New Jersey, 2002.
- [66] Denis Bosq. *Nonparametric Statistics for Stochastic Processes: Estimation and Prediction*. Springer-Verlag, Berlin, 2nd edition, 1998.
- [67] Paul Algoet. Universal schemes for prediction, gambling and portfolio selection. *The Annals of Probability*, 20:901–941, 1992. See also an important Correction, *The Annals of Probability*, **23** (1995): 474–478.
- [68] Floris Takens. Detecting strange attractors in fluid turbulence. In D. A. Rand and L. S. Young, editors, *Symposium on Dynamical Systems and Turbulence*, pages 366–381, Berlin, 1981. Springer-Verlag.
- [69] Holger Kantz and Thomas Schreiber. *Nonlinear Time Series Analysis*. Cambridge University Press, Cambridge, England, 1997.
- [70] Kevin Judd and Alistair Mees. Embedding as a modeling problem. *Physica D*, 120:273–286, 1998.
- [71] Michael Small and C. K. Tse. Optimal embedding parameters: A modelling paradigm. *Physica D*, 194:283–296, 2004. <http://arxiv.org/abs/physics/0308114>.
- [72] Matthew B. Kennel, R. Brown, and Henry D. I. Abarbanel. Determining minimum embedding dimension using a geometric construction. *Physical Review A*, 45:3403–3411, 1992.
- [73] Julien Clinton Sprott. *Chaos and Time-Series Analysis*. Oxford University Press, Oxford, 2003.
- [74] L. A. Smith. Intrinsic limits on dimension calculations. *Physics Letters A*, 133:283–288, 1988.
- [75] Andrew M. Fraser and Harry L. Swinney. Independent coordinates for strange attractors from mutual information. *Physical Review A*, 33:1134–1140, 1986.
- [76] Christopher J. Cellucci, Alfonso M. Albano, and P. E. Rapp. Comparative study of embedding methods. *Physical Review E*, 67:062210, 2003.

- [77] Christophe Letellier and Luis A. Aguirre. Investigating nonlinear dynamics from time series: The influence of symmetries and the choice of observables. *Chaos*, 12:549–558, 2002.
- [78] Norbert Wiener. *Extrapolation, Interpolation, and Smoothing of Stationary Time Series: With Engineering Applications*. The Technology Press of the Massachusetts Institute of Technology, Cambridge, Massachusetts, 1949.
- [79] Andrei N. Kolmogorov. Interpolation und extrapolation von stationären zufälligen folgen. *Bulletin of the Academy Sciences, USSR, Math.*, 3:3–14, 1941. In Russian with German summary.
- [80] R. E. Kalman. A new approach to linear filtering and prediction problems. *ASME Transactions, Journal of Basic Engineering*, 82D:35–50, 1960.
- [81] R. E. Kalman and R. S. Bucy. New results in linear filtering and prediction. *ASME Transactions, Journal of Basic Engineering*, 83D:95–108, 1961.
- [82] Richard S. Bucy. *Lectures on Discrete Time Filtering*. Springer-Verlag, Berlin, 1994.
- [83] R. L. Stratonovich. *Conditional Markov Processes and Their Application to the Theory of Optimal Control*. American Elsevier, New York, second edition, 1968. Translated by R. N. and N. B. McDonough. Preface by Richard Bellman. Revised by the author. First edition, *Uslovnnyye markovskiye protessy i ikh primeneiye k teorri optimal'nogo upravleniya*, Msocow: Moscow University Press, 1966.
- [84] Harold J. Kushner. Dynamical equations for optimal nonlinear filtering. *Journal of Differential Equations*, 3:179–190, 1967.
- [85] Robert S. Lipster and Albert N. Shiryaev. *Statistics of Random Processes*. Springer-Verlag, Berlin, second edition, 2001. Two volumes. Trans. A. B. Aries. First English edition 1977–1978. First published as *Statistika sluchainykh protessov*, Moscow: Nauka, 1974.
- [86] Hisashi Tanizaki. *Nonlinear Filters: Estimation and Applications*. Springer-Verlag, Berlin, second edition, 1996.
- [87] R. W. R. Darling. Geometrically intrinsic nonlinear recursive filters I: Algorithms. Technical Report 494, Statistics Department, University of California-Berkeley, 1998. <http://www.stat.berkeley.edu/tech-reports/494.abstract>.
- [88] R. W. R. Darling. Geometrically intrinsic nonlinear recursive filters II: Foundations. Technical Report 512,

- Statistics Department, University of California-Berkeley, 1998. <http://www.stat.berkeley.edu/tech-reports/512.abstract>.
- [89] Gregory L. Eyink. A variational formulation of optimal nonlinear estimation. *Methodology and Computing in Applied Probability*, submitted, 2000. <http://arxiv.org/abs/physics/0011049>.
- [90] N. U. Ahmed. *Linear and Nonlinear Filtering for Scientists and Engineers*. World Scientific, Singapore, 1998.
- [91] Noam Chomsky. Three models for the description of language. *IRE Transactions on Information Theory*, 2:113–124, 1956.
- [92] Eugene Charniak. *Statistical Language Learning*. MIT Press, Cambridge, Massachusetts, 1993.
- [93] Christopher D. Manning and Hinrich Schütze. *Foundations of Statistical Natural Language Processing*. MIT Press, Cambridge, Massachusetts, 1999.
- [94] Robert J. Elliott, Lakhdar Aggoun, and John B. Moore. *Hidden Markov Models: Estimation and Control*, volume 29 of *Applications of Mathematics: Stochastic Modelling and Applied Probability*. Springer-Verlag, New York, 1995.
- [95] Pierre Baldi and Søren Brunak. *Bioinformatics: The Machine Learning Approach*. MIT Press, Cambridge, Massachusetts, second edition, 2001.
- [96] Radford M. Neal and Geoffrey E. Hinton. A view of the EM algorithm that justifies incremental, sparse, and other variants. In Jordan [144], pages 355–368.
- [97] Jorma Rissanen. A universal data compression system. *IEEE Transactions on Information Theory*, 29:656–664, 1983.
- [98] Frans Willems, Yuri Shtarkov, and Tjalling Tjalkens. The context-tree weighting method: Basic properties. *IEEE Transactions on Information Theory*, 41:653–664, 1995.
- [99] Dana Ron, Yoram Singer, and Naftali Tishby. The power of amnesia: Learning probabilistic automata with variable memory length. *Machine Learning*, 25:117–149, 1996.
- [100] Peter Bühlmann and Abraham J. Wyner. Variable length Markov chains. *The Annals of Statistics*, 27:480–513, 1999. <http://www.stat.berkeley.edu/tech-reports/479.abstract1>.
- [101] Matthew B. Kennel and Alistair I. Mees. Context-tree modeling of observed symbolic dynamics. *Physical Review E*, 66:056209, 2002.
- [102] James P. Crutchfield and Karl Young. Inferring statistical complexity. *Physical Review Letters*, 63:105–108, 1989.

- [103] Herbert Jaeger. Observable operator models for discrete stochastic time series. *Neural Computation*, 12:1371–1398, 2000. http://www.faculty.iu-bremen.de/hjaeger/pubs/oom_neco00.pdf.
- [104] Michael L. Littman, Richard S. Sutton, and Satinder Singh. Predictive representations of state. In Thomas G. Dietterich, Suzanna Becker, and Zoubin Ghahramani, editors, *Advances in Neural Information Processing Systems 14*, pages 1555–1561, Cambridge, Massachusetts, 2002. MIT Press. <http://www.eecs.umich.edu/~baveja/Papers/psr.pdf>.
- [105] Cosma Rohilla Shalizi and Kristina Lisa Shalizi. Blind construction of optimal nonlinear recursive predictors for discrete sequences. In Max Chickering and Joseph Halpern, editors, *Uncertainty in Artificial Intelligence: Proceedings of the Twentieth Conference*, pages 504–511, Arlington, Virginia, 2004. AUAI Press. <http://arxiv.org/abs/cs.LG/0406011>.
- [106] Wesley C. Salmon. *Statistical Explanation and Statistical Relevance*. University of Pittsburgh Press, Pittsburgh, 1971. With contributions by Richard C. Jeffrey and James G. Greeno.
- [107] Wesley C. Salmon. *Scientific Explanation and the Causal Structure of the World*. Princeton University Press, Princeton, 1984.
- [108] Satinder Singh, Michael L. Littman, Nicholas K. Jong, David Pardoe, and Peter Stone. Learning predictive state representations. In Tom Fawcett and Nina Mishra, editors, *Proceedings of the Twentieth International Conference on Machine Learning (ICML-2003)*, pages 712–719. AAAI Press, 2003. <http://www.eecs.umich.edu/~baveja/Papers/ICMLfinal.ps.gz>.
- [109] Daniel R. Upper. *Theory and Algorithms for Hidden Markov Models and Generalized Hidden Markov Models*. PhD thesis, University of California, Berkeley, 1997. <http://www.santafe.edu/projects/CompMech/papers/TAHMMGHMM.html>.
- [110] P. Dupont, F. Denis, and Y. Esposito. Links between probabilistic automata and hidden Markov models: Probability distributions, learning models and induction algorithms. *Pattern Recognition*, forthcoming, 2004. http://www.info.ucl.ac.be/people/pdupont/pdupont/postscript/Links_PA_HMM_preprint.ps.gz.
- [111] Herbert Jaeger. Characterizing distributions of stochastic processes by linear operators. Technical Report 62,

German National Center for Information Technology, 1999. http://www.faculty.iu-bremen.de/hjaeger/pubs/oom_distributionsTechRep.pdf.

- [112] Herbert Jaeger. Modeling and learning continuous-valued stochastic processes with ooms. Technical Report 102, German National Center for Information Technology, 2000. <http://www.faculty.iu-bremen.de/hjaeger/pubs/jaeger.00.tr.contoom.pdf>.
- [113] James P. Crutchfield. Unreconstructible at any radius. *Physics Letters A*, 171:52–60, 1992.
- [114] Erik M. Bollt, Theodore Stanford, Ying-Cheng Lai, and Karol Zyczkowski. Validity of threshold-crossing analysis of symbolic dynamics from chaotic time series. *Physical Review Letters*, 85:3524–3527, 2000.
- [115] Erik M. Bollt, Theodore Stanford, Ying-Cheng Lai, and Karol Zyczkowski. What symbolic dynamics do we get with a misplaced partition? On the validity of threshold crossing analysis of chaotic time-series. *Physica D*, 154:259–286, 2001.
- [116] Bruce P. Kitchens. *Symbolic Dynamics: One-sided, Two-sided and Countable State Markov Shifts*. Springer-Verlag, Berlin, 1998.
- [117] Matthew B. Kennel and Michael Buhl. Estimating good discrete partitions from observed data: symbolic false nearest neighbors. *Physical Review Letters*, 91:084102, 2003. <http://arxiv.org/abs/nlin.CD/0304054>.
- [118] Yoshito Hirata, Kevin Judd, and Devin Kilminster. Estimating a generating partition from observed time series: Symbolic shadowing. *Physical Review E*, 70:016215, 2004.
- [119] James P. Crutchfield and Norman H. Packard. Symbolic dynamics of noisy chaos. *Physica D*, 7:201–223, 1983.
- [120] Cristopher Moore. Majority-vote cellular automata, Ising dynamics, and P-completeness. *Journal of Statistical Physics*, 88:795–805, 1997. <http://arxiv.org/abs/cond-mat/9701118>.
- [121] Cristopher Moore and Mats G. Nordahl. Lattice gas prediction is P-complete. Electronic preprint, 1997. <http://arxiv.org/abs/nlin.CG/9704001>.
- [122] J. Hardy, Y. Pomeau, and O. de Pazzis. Molecular dynamics of a classical lattice gas: Transport properties and time correlation functions. *Physical Review A*, 13:1949–1960, 1976.

- [123] Uriel Frisch, Boris Hasslacher, and Yves Pomeau. Lattice-gas automata for the Navier-Stokes equation. *Physical Review Letters*, 56:1505–1508, 1986.
- [124] Daniel H. Rothman and Stéphane Zaleski. *Lattice-Gas Cellular Automata: Simple Models of Complex Hydrodynamics*. Cambridge University Press, Cambridge, England, 1997.
- [125] Robert Fisch, Janko Gravner, and David Griffeath. Threshold-range scaling of excitable cellular automata. *Statistics and Computing*, 1:23–39, 1991. <http://psoup.math.wisc.edu/papers/tr.zip>.
- [126] Martin Nilsson, Steen Rasmussen, B. Mayer, and D. Whitten. Constructive molecular dynamics (MD) lattice gases: 3-D molecular self-assembly. In Griffeath and Moore [257], pages 275–290.
- [127] Martin Nilsson and Steen Rasmussen. Cellular automata for simulating molecular self-assembly. *Discrete Mathematics and Theoretical Computer Science*, AB(DMCS):31–42, 2003. <http://dmtcs.loria.fr/proceedings/html/dmAB0103.abs.html>.
- [128] M. S. Bartlett. *An Introduction to Stochastic Processes, with Special Reference to Methods and Applications*. Cambridge University Press, Cambridge, England, 1955.
- [129] John A. Jacquez, James S. Koopman, Carl P. Simon, and Ira M. Longini. The role of the primary infection in epidemics of HIV-infection in gay cohorts. *Journal of Acquired Immune Deficiency Syndromes and Human Retrovirology*, 7:1169–1184, 1994.
- [130] James Koopman, John Jacquez, Carl Simon, B. Foxman, S. Pollock, D. Barth-Jones, A. Adams, G. Welch, and K. Lange. The role of primary HIV infection in the spread of HIV through populations. *Journal of AIDS*, 14:249–258, 1997.
- [131] Timothy Budd. *Understanding Object-Oriented Programming with Java*. Addison-Wesley, Reading, Massachusetts, second edition, 2000.
- [132] Mitchel Resnick. *Turtles, Termites and Traffic Jams: Explorations in Massively Parallel Microworlds*. MIT Press, Cambridge, Massachusetts, 1994.
- [133] John Seely Brown and Paul Duguid. *The Social Life of Information*. Harvard Business School Press, Boston, Massachusetts, 2000.

- [134] Eric Bonabeau, Marco Dorigo, and Guy Theraulaz. *Swarm Intelligence: From Natural to Artificial Systems*. Oxford University Press, Oxford, 1999.
- [135] Kristina Lerman. Design and mathematical analysis of agent-based systems. E-print, Information Sciences Institute, University of Southern California, 2000. http://www.isi.edu/~lerman/papers/fmw00_abstract.html.
- [136] Sascha Ossowski. *Co-ordination in Artificial Agent Societies: Social Structure and Its Implications for Autonomous Problem-Solving Agents*. Springer-Verlag, Berlin, 2000.
- [137] Michael Wooldridge. *Reasoning about Rational Agents*. MIT Press, Cambridge, Massachusetts, 2000.
- [138] Catholijn M. Jonker, Jacky L. Snoep, Jan Treur, Hans V. Westerhoff, and Wouter C. A. Wijngaards. Putting intentions into cell biochemistry: An artificial intelligence perspective. *Journal of Theoretical Biology*, 214:105–134, 2002.
- [139] Paul M. Chaikin and T. C. Lubensky. *Principles of Condensed Matter Physics*. Cambridge University Press, Cambridge, England, 1995.
- [140] J. M. Hammersley and D. C. Handscomb. *Monte Carlo Methods*. Chapman and Hall, London, 1964.
- [141] N. Metropolis, A. W. Rosenbluth, M. N. Rosenbluth, A. H. Teller, and E. Teller. Equations of state calculations by fast computing machines. *Journal of Chemical Physics*, 21:1087–1092, 1953.
- [142] Pierre Brémaud. *Markov Chains: Gibbs Fields, Monte Carlo Simulation, and Queues*. Springer-Verlag, Berlin, 1999.
- [143] Martin Beckerman. *Adaptive Cooperative Systems*. Wiley, New York, 1997.
- [144] Michael I. Jordan, editor. *Learning in Graphical Models*, Dordrecht, 1998. Kluwer Academic.
- [145] H. Peyton Young. *Individual Strategy and Social Structure: An Evolutionary Theory of Institutions*. Princeton University Press, Princeton, 1998.
- [146] John Sutton. *Technology and Market Structure: Theory and History*. MIT Press, Cambridge, Massachusetts, 1998.
- [147] Irving R. Epstein and John A. Pojman. *An Introduction to Non-linear Chemical Dynamics: Oscillations, Waves, Patterns, and Chaos*. Oxford University Press, Oxford, 1998.

- [148] Arthur T. Winfree. *When Time Breaks Down: The Three-Dimensional Dynamics of Electrochemical Waves and Cardiac Arrhythmias*. Princeton University Press, Princeton, 1987.
- [149] Francisco J. Varela, Humberto R. Maturana, and R. Uribe. Autopoiesis: The organization of living systems, its characterization and a model. *BioSystems*, 5:187–196, 1974.
- [150] Niklas Luhmann. *Social Systems*. Stanford University Press, Stanford, 1984/1995. Translated by John Bednarz, Jr., with Dirk Baecker. Foreword by Eva M. Knodt. First published as *Soziale Systeme: Grundriss einer allgemeinen Theorie*, Frankfurt am Main: Suhrkamp-Verlag.
- [151] Barry McMullin. The case of the independent test. *Santa Fe Institute Bulletin*, 12(2), 1997.
- [152] Barry McMullin and Francisco J. Varela. Rediscovering computational autopoiesis. Technical Report 97-02-012, Santa Fe Institute, 1997. <http://www.santafe.edu/research/publications/wpabstract/199702012>.
- [153] Melanie Mitchell, Peter T. Hraber, and James P. Crutchfield. Revisiting the edge of chaos: Evolving cellular automata to perform computations. *Complex Systems*, 7:89–130, 1993. <http://www.cse.ogi.edu/~mm/rev-edge.pdf>.
- [154] Alexander A. Schuessler. Ecological inference. *Proceedings of the National Academy of Sciences*, 96:10578–10581, 1999.
- [155] A. C. Atkinson and A. N. Donev. *Optimum Experimental Designs*. Clarendon Press, Oxford, 1992.
- [156] Dale S. Borowiak. *Model Discrimination for Nonlinear Regression Models*. Marcel Dekker, New York, 1989.
- [157] Mark E. J. Newman and Richard G. Palmer. *Modeling Extinction*. Oxford University Press, Oxford, 2003. <http://arxiv.org/abs/adap-org/9908002>.
- [158] Thomas M. Cover and Joy A. Thomas. *Elements of Information Theory*. Wiley, New York, 1991.
- [159] Solomon Kullback. *Information Theory and Statistics*. Dover Books, New York, 2nd edition, 1968.
- [160] Rudolf Kulhavy. *Recursive Nonlinear Estimation: A Geometric Approach*. Springer-Verlag, Berlin, 1996.
- [161] Aleksandr Iakovlevich Khinchin. *Mathematical Foundations of Information Theory*. Dover, New York, 1957. Translated by R. A. Silverman and M. D. Friedman from two Russian articles in *Uspekhi Matematicheskikh Nauk*, **7** (1953): 3–20 and **9** (1956): 17–75.

- [162] David Ruelle. *Chaotic Evolution and Strange Attractors: The Statistical Analysis of Time Series for Deterministic Nonlinear Systems*. Cambridge University Press, Cambridge, England, 1989. Notes prepared by Stefano Isola.
- [163] Christian Beck and Friedrich Schlögl. *Thermodynamics of Chaotic Systems: An Introduction*. Cambridge University Press, Cambridge, England, 1993.
- [164] Jonathan D. Victor. Asymptotic bias in information estimates and the exponential (Bell) polynomials. *Neural Computation*, 12:2797–2804, 2000.
- [165] Alexander Kraskov, Harald Stögbauer, and Peter Grassberger. Estimating mutual information. *Physical Review E*, submitted, 2003. <http://arxiv.org/abs/cond-mat/0305641>.
- [166] I. Kontoyiannis, P. H. Algoet, Yu. M. Suhov, and A. J. Wyner. Nonparametric entropy estimation for stationary processes and random fields, with applications to english text. *IEEE Transactions on Information Theory*, 44:1319–1327, 1998. <http://www.dam.brown.edu/people/yiannis/PAPERS/suhov2.pdf>.
- [167] Dario Benedetto, Emanuele Caglioti, and Vittorio Loreto. Language trees and zipping. *Physical Review Letters*, 88:048702, 2002. <http://arxiv.org/abs/cond-mat/0108530>.
- [168] Dmitry V. Khmelev and William J. Teahan. Comment on “Language trees and zipping”. *Physical Review Letters*, 90:089803, 2003. <http://arxiv.org/abs/cond-mat/0205521>.
- [169] Joshua Goodman. Extended comment on “Language trees and zipping”. Electronic pre-print, 2002. <http://arxiv.org/abs/cond-mat/0202383>.
- [170] David J. C. MacKay. *Information Theory, Inference, and Learning Algorithms*. Cambridge University Press, Cambridge, England, 2003. <http://www.inference.phy.cam.ac.uk/mackay/itprnn/book.html>.
- [171] Richard Durbin, Sean Eddy, Anders Krogh, and Graeme Mitchison. *Biological Sequence Analysis: Probabilistic Models of Proteins and Nucleic Acids*. Cambridge University Press, Cambridge, England, 1998.
- [172] Fred Rieke, David Warland, Rob de Ruyter van Steveninck, and William Bialek. *Spikes: Exploring the Neural Code*. MIT Press, Cambridge, Massachusetts, 1997.

- [173] Laurence F. Abbott and Terrence J. Sejnowski, editors. *Neural Codes and Distributed Representations: Foundations of Neural Computation*, Cambridge, Massachusetts, 1998. MIT Press.
- [174] Patrick Billingsley. *Ergodic Theory and Information*. Wiley, New York, 1965.
- [175] Anatole B. Katok and Boris Hasselblatt. *Introduction to the Modern Theory of Dynamical Systems*. Cambridge University Press, Cambridge, England, 1995.
- [176] Raymond J. Solomonoff. A formal theory of inductive inference. *Information and Control*, 7:1–22 and 224–254, 1964. <http://world.std.com/~rjs/pubs.html>.
- [177] Ming Li and Paul M. B. Vitanyi. *An Introduction to Kolmogorov Complexity and Its Applications*. Springer-Verlag, New York, 1993.
- [178] Wojciech H. Zurek. Algorithmic randomness, physical entropy, measurements, and the demon of choice. E-print, arxiv.org, 1998. <http://arxiv.org/abs/quant-ph/9807007>.
- [179] Charles H. Bennett. Dissipation, information, computational complexity and the definition of organization. In David Pines, editor, *Emerging Syntheses in Science*, pages 215–234, Santa Fe, New Mexico, 1985. Santa Fe Institute.
- [180] Charles H. Bennett. On the nature and origin of complexity in discrete, homogeneous locally-interacting systems. *Foundations of Physics*, 16:585–592, 1986.
- [181] Charles H. Bennett. How to define complexity in physics, and why. In Zurek [12], pages 137–148.
- [182] Seth Lloyd and Heinz Pagels. Complexity as thermodynamic depth. *Annals of Physics*, 188:186–213, 1988.
- [183] Péter Gács, John T. Tromp, and Paul M. B. Vitanyi. Algorithmic statistics. *IEEE Transactions on Information Theory*, 47:2443–2463, 2001. <http://arxiv.org/abs/math.PR/0006233>.
- [184] Jorma Rissanen. Modeling by shortest data description. *Automatica*, 14:465–471, 1978.
- [185] Jorma Rissanen. *Stochastic Complexity in Statistical Inquiry*. World Scientific, Singapore, 1989.
- [186] Peter T. Hraber, Bette T. Korber, Steven Wolinsky, Henry Erlich, and Elizabeth Trachtenberg. HLA and HIV infection progression: Application of the minimum description length principle to statistical genetics. Technical Report 03-04-23, Santa Fe Institute, 2003. <http://www.santafe.edu/research/publications/wpabstract/200304023>.

- [187] Peter Grassberger. Toward a quantitative theory of self-generated complexity. *International Journal of Theoretical Physics*, 25:907–938, 1986.
- [188] Cosma Rohilla Shalizi. *Causal Architecture, Complexity and Self-Organization in Time Series and Cellular Automata*. PhD thesis, University of Wisconsin-Madison, 2001. <http://bactra.org/thesis/>.
- [189] Robert Shaw. *The Dripping Faucet as a Model Chaotic System*. Aerial Press, Santa Cruz, California, 1984.
- [190] Kristian Lindgren and Mats G. Nordahl. Complexity measures and cellular automata. *Complex Systems*, 2:409–440, 1988.
- [191] Wentien Li. On the relationship between complexity and entropy for Markov chains and regular languages. *Complex Systems*, 5:381–399, 1991.
- [192] Dirk Arnold. Information-theoretic analysis of phase transitions. *Complex Systems*, 10:143–155, 1996.
- [193] William Bialek, Ilya Nemenman, and Naftali Tishby. Predictability, complexity and learning. *Neural Computation*, 13:2409–2463, 2001. <http://arxiv.org/abs/physics/0007070>.
- [194] James P. Crutchfield and Karl Young. Computation at the onset of chaos. In Zurek [12], pages 223–269.
- [195] Cosma Rohilla Shalizi and James P. Crutchfield. Computational mechanics: Pattern and prediction, structure and simplicity. *Journal of Statistical Physics*, 104:817–879, 2001. <http://arxiv.org/abs/cond-mat/9907176>.
- [196] Cosma Rohilla Shalizi. Optimal nonlinear prediction of random fields on networks. *Discrete Mathematics and Theoretical Computer Science*, AB(DMCS):11–30, 2003. <http://arxiv.org/abs/math.PR/0305160>.
- [197] Cosma Rohilla Shalizi, Kristina Lisa Shalizi, and Robert Haslinger. Quantifying self-organization with optimal predictors. *Physical Review Letters*, 93:118701, 2004. <http://arxiv.org/abs/nlin.A0/0409024>.
- [198] Harry R. Lewis and Christos H. Papadimitriou. *Elements of the Theory of Computation*. Prentice-Hall, Upper Saddle River, New Jersey, second edition, 1998.
- [199] Richard W. Clarke, Mervyn P. Freeman, and Nicholas W. Watkins. Application of computational mechanics to the analysis of natural data: An example in geomagnetism. *Physical Review E*, 67:0126203, 2003. <http://arxiv.org/abs/cond-mat/0110228>.

- [200] David Chandler. *Introduction to Modern Statistical Mechanics*. Oxford University Press, Oxford, 1987.
- [201] William J. Reed and Barry D. Hughes. From gene families and genera to incomes and Internet file sizes: Why power laws are so common in nature. *Physical Review E*, 66:067103, 2002.
- [202] Per Bak, C. Tang, and Kurt Wiesenfeld. Self-organized criticality: An explanation of $1/f$ noise. *Physical Review Letters*, 59:381–384, 1987.
- [203] Henrik J. Jensen. *Self-Organized Criticality: Emergent Complex Behavior in Physical and Biological Systems*. Cambridge University Press, Cambridge, England, 1998.
- [204] Jean M. Carlson and John Doyle. Highly optimized tolerance: A mechanism for power laws in designed systems. *Physical Review E*, 60:1412–1427, 1999.
- [205] Jean M. Carlson and John Doyle. Highly optimized tolerance: Robustness and design in complex systems. *Physical Review Letters*, 84:2529–2532, 2000.
- [206] Mark E. J. Newman, Michelle Girvan, and J. Doyne Farmer. Optimal design, robustness, and risk aversion. *Physical Review Letters*, 89:028301, 2002. <http://arxiv.org/abs/cond-mat/0202330>.
- [207] Clay Shirky. Power laws, weblogs, and inequality. In Mitch Ratcliffe and Jon Lebkowsky, editors, *Extreme Democracy*, forthcoming. First published online, February 2003, http://www.shirky.com/writings/powerlaw_weblog.html.
- [208] Daniel Drenzer and Henry Farrell. The power and politics of blogs. *Perspectives on Politics*, submitted, 2004. <http://www.utsc.utoronto.ca/~farrell/blogpaperfinal.pdf>.
- [209] James P. Crutchfield and Cosma Rohilla Shalizi. Thermodynamic depth of causal states: Objective complexity via minimal representations. *Physical Review E*, 59:275–283, 1999. <http://arxiv.org/abs/cond-mat/9808147>.
- [210] Bernardo A. Huberman and T. Hogg. Complexity and adaptation. *Physica D*, 22:376–384, 1986.
- [211] David H. Wolpert and William G. Macready. Self-dissimilarity: An empirically observable measure of complexity. In Yaneer Bar-Yam, editor, *Unifying Themes in Complex Systems*. Perseus Books, Boston, 2000. <http://www.santafe.edu/research/publications/wpabstract/199712087>.

- [212] Olaf Sporns, Giulio Tononi, and Gerald M. Edelman. Connectivity and complexity: the relationship between neuroanatomy and brain dynamics. *Neural Networks*, 13:909–992, 2000. <http://php.indiana.edu/~osporns/nn.connectivity.pdf>.
- [213] Olaf Sporns, Giulio Tononi, and Gerald M. Edelman. Theoretical neuroanatomy: Relating anatomical and functional connectivity in graphs and cortical connection matrices. *Cerebral Cortex*, 10:127–141, 2000.
- [214] Olaf Sporns and Giulio Tononi. Classes of network connectivity and dynamics. *Complexity*, 7:28–38, 2002. http://php.indiana.edu/~osporns/complexity_2002.pdf.
- [215] John Bates and Harvey Shepard. Measuring complexity using information fluctuation. *Physics Letters A*, 172:416–425, 1993. http://physics.unh.edu/people/profiles/bates_shepard.pdf.
- [216] G. Boffetta, Massimo Cencini, Massimo Falcioni, and Angelo Vulpiani. Predictability: A way to characterize complexity. *Physics Reports*, 356:367–474, 2002. <http://arxiv.org/abs/nlin.CD/0101029>.
- [217] David P. Feldman and James P. Crutchfield. Measures of statistical complexity: Why? *Physics Letters A*, 238:244–252, 1998. <http://hornacek.coa.edu/dave/Publications/MSCW.html>.
- [218] Robert Axelrod and Michael D. Cohen. *Harnessing Complexity: Organizational Implications of a Scientific Frontier*. Free Press, New York, 1999.
- [219] Gary William Flake. *The Computational Beauty of Nature: Computer Explorations of Fractals, Chaos, Complex Systems and Adaptation*. MIT Press, Cambridge, Massachusetts, 1998.
- [220] John H. Holland. *Emergence: From Chaos to Order*. Addison-Wesley, Reading, Massachusetts, 1998.
- [221] Herbert A. Simon. *The Sciences of the Artificial*. MIT Press, Cambridge, Massachusetts, third edition, 1996. First edition 1969.
- [222] Nino Boccara. *Modeling Complex Systems*. Springer-Verlag, Berlin, 2004.
- [223] David Hand, Heikki Mannila, and Padhraic Smyth. *Principles of Data Mining*. MIT Press, Cambridge, Massachusetts, 2001.
- [224] Michael J. Kearns and Umesh V. Vazirani. *An Introduction to Computational Learning Theory*. MIT Press, Cambridge, Massachusetts, 1994.

- [225] Vladimir N. Vapnik. *Estimation of Dependencies Based on Empirical Data*. Springer-Verlag, Berlin, 1979/1982. Translated by Samuel Kotz from *Vosstanovlyeniye Zavicimostei po Émpiricheckim Dannim* (Moscow: Nauka).
- [226] Vladimir N. Vapnik. *Statistical Learning Theory*. Wiley, New York, 1998.
- [227] Oliver Nelles. *Nonlinear System Identification: From Classical Approaches to Neural Networks and Fuzzy Models*. Springer-Verlag, Berlin, 2001.
- [228] John W. Tukey. *Exploratory Data Analysis*. Addison-Wesley, Reading, Massachusetts, 1977.
- [229] Edward R. Tufte. *The Visual Display of Quantitative Information*. Graphics Press, Cheshire, Connecticut, 1983.
- [230] Edward R. Tufte. *Envisioning Information*. Graphics Press, Cheshire, Connecticut, 1990.
- [231] Edward R. Tufte. *Visual Explanations: Images and Quantities, Evidence and Narrative*. Graphics Press, Cheshire, Connecticut, 1997.
- [232] Henry D. I. Abarbanel. *Analysis of Observed Chaotic Data*. Springer-Verlag, 1996.
- [233] Martin Casdagli and Stephen Eubank, editors. *Nonlinear Modeling and Forecasting*, Reading, Massachusetts, 1992. Addison-Wesley.
- [234] A. S. Weigend and N. A. Gershenfeld, editors. *Time Series Prediction: Forecasting the Future and Understanding the Past*, Reading, Massachusetts, 1993. Addison-Wesley.
- [235] Robert Azencott and Didier Dacunha-Castelle. *Series of Irregular Observations: Forecasting and Model Building*. Springer-Verlag, Berlin, 1984/1986. First published as *Series d'Observations irregulieres*, Paris: Masson.
- [236] Masanobu Taniguchi and Yoshihide Kakizawa. *Asymptotic Theory of Statistical Inference for Time Series*. Springer-Verlag, Berlin, 2000.
- [237] Shun-ichi Amari and Hiroshi Nagaoka. *Methods of Information Geometry*. American Mathematical Society, Providence, Rhode Island, 1993/2000. Translated by Daishi Harada. As *Joho Kika no Hoho*, Tokyo: Iwanami Shoten Publishers.
- [238] Nihat Ay. An information-geometric approach to a theory of pragmatic structuring. *The Annals of Probability*,

- 30:416–436, 2002. <http://www.mis.mpg.de/preprints/2000/prepr5200-abstr.html>.
- [239] Nihat Ay. Information geometry on complexity and stochastic interaction. Technical Report 95-2001, Max Planck Institute for Mathematics in the Sciences, 2001. <http://www.mis.mpg.de/preprints/2001/prepr9501-abstr.html>.
- [240] Colleen D. Cutler and Daniel T. Kaplan, editors. *Nonlinear Dynamics and Time Series: Building a Bridge between the Natural and Statistical Sciences*, Providence, Rhode Island, 1997. American Mathematical Society.
- [241] Howell Tong. *Non-Linear Time Series: A Dynamical Systems Approach*. Oxford University Press, 1990.
- [242] Ronald K. Pearson. *Discrete-Time Dynamic Models*. Oxford University Press, New York, 1999.
- [243] Robert F. Stengel. *Optimal Control and Estimation*. Dover, New York, 1994. As *Stochastic Optimal Control: Theory and Application*, New York: Wiley, 1986.
- [244] Douglas Lind and Brian Marcus. *An Introduction to Symbolic Dynamics and Coding*. Cambridge University Press, Cambridge, England, 1995.
- [245] Neil Gershenfeld. *The Nature of Mathematical Modeling*. Cambridge University Press, Cambridge, England, 1999.
- [246] Andrew Ilachinski. *Cellular Automata: A Discrete Universe*. World Scientific, Singapore, 2001.
- [247] Bastien Chopard and Michel Droz. *Cellular Automata Modeling of Physical Systems*. Cambridge University Press, Cambridge, England, 1998.
- [248] Tommaso Toffoli and Norman Margolus. *Cellular Automata Machines: A New Environment for Modeling*. MIT Press, Cambridge, Massachusetts, 1987.
- [249] J. Doyne Farmer, Tommaso Toffoli, and Stephen Wolfram, editors. *Cellular Automata: Proceedings of an Interdisciplinary Workshop, Los Alamos, New Mexico 87545, USA, March 7–11, 1983*, Amsterdam, 1984. North-Holland. Also published as *Physica D* **10**, nos. 1–2.
- [250] Howard Gutowitz, editor. *Cellular Automata: Theory and Experiment*, Cambridge, Massachusetts, 1991. MIT Press. Also published as *Physica D* **45** (1990), nos. 1–3.

- [251] Paul Manneville, Nino Boccara, Gérard Y. Vichniac, and R. Bidaux, editors. *Cellular Automata and Modeling of Complex Systems: Proceedings of the Winter School, Les Houches, France, February 21–28, 1989*, Berlin, 1990. Springer-Verlag.
- [252] John von Neumann. *Theory of Self-Reproducing Automata*. University of Illinois Press, Urbana, 1966. Edited and completed by Arthur W. Burks.
- [253] Arthur W. Burks, editor. *Essays on Cellular Automata*, Urbana, 1970. University of Illinois Press.
- [254] William Poundstone. *The Recursive Universe: Cosmic Complexity and the Limits of Scientific Knowledge*. William Morrow, New York, 1984.
- [255] Christopher G. Langton, editor. *Artificial Life*, Addison-Reading, Massachusetts, 1988. Addison-Wesley.
- [256] Stephen Wolfram. *Cellular Automata and Complexity: Collected Papers*. Addison-Wesley, Reading, Massachusetts, 1994. <http://www.stephenwolfram.com/publications/books/ca-reprint/>.
- [257] David Griffeth and Cristopher Moore, editors. *New Constructions in Cellular Automata*, Oxford, 2003. Oxford University Press.
- [258] Jean-Pierre Rivet and Jean-Pierre Boon. *Lattice Gas Hydrodynamics*. Cambridge University Press, Cambridge, England, 2001.
- [259] Gary D. Doolen, editor. *Lattice Gas Methods for Partial Differential Equations: A Volume of Lattice Gas Reprints and Articles*, Reading, Massachusetts, 1989. Addison-Wesley.
- [260] Gary D. Doolen, editor. *Lattice Gas Methods: Theory, Applications, and Hardware*, Cambridge, Massachusetts, 1991. MIT Press. Also published as *Physica D* **47** (1–2), 1991.
- [261] Robert Axelrod. *The Evolution of Cooperation*. Basic Books, New York, 1984.
- [262] Francisco J. Varela and Paul Bourguine, editors. *Toward a Practice of Autonomous Systems: Proceedings of the First European Conference on Artificial Life*, Cambridge, Massachusetts, 1992. MIT Press.
- [263] Joshua M. Epstein and Robert Axtell. *Growing Artificial Societies: Social Science from the Bottom Up*. MIT Press, Cambridge, Massachusetts, 1996.
- [264] Joshua M. Epstein. Agent-based computational models and generative social science. *Complexity*, 4(5):41–60, 1999.

- [265] Michael W. Macy and Robert Willer. From factors to actors: Computational sociology and agent-based modeling. *Annual Review of Sociology*, 28:143–66, 2002.
- [266] Randy Gimblett, editor. *Integrating Geographic Information Systems and Agent-Based Modeling Techniques for Understanding Social and Ecological Processes*. Oxford University Press, Oxford, 2001.
- [267] Timothy A. Kohler and George J. Gumerman, editors. *Dynamics in Human and Primate Societies: Agent-Based Modeling of Social and Spatial Processes*, Santa Fe Institute Studies in the Sciences of Complexity, Oxford, 2000. Oxford University Press.
- [268] Eric Bonabeau. From classical models of morphogenesis to agent-based models of pattern formation. *Artificial Life*, 3:191–211, 1997.
- [269] Scott Camazine, Jean-Louis Deneubourg, Nigel R. Franks, James Sneyd, Guy Theraulaz, and Eric Bonabeau. *Self-Organization in Biological Systems*. Princeton University Press, Princeton, New Jersey, 2001.
- [270] C. W. Gardiner. *Handbook of Stochastic Methods for Physics, Chemistry, and the Natural Sciences*. Springer-Verlag, Berlin, 2nd edition, 1990.
- [271] Mark E. J. Newman and G. T. Barkema. *Monte Carlo Methods in Statistical Physics*. Clarendon Press, Oxford, 1999.
- [272] P. Kevin MacKeown. *Stochastic Simulation in Physics*. Springer-Verlag, Singapore, 1997.
- [273] Gary King. *A Solution to the Ecological Inference Problem: Reconstructing Individual Behavior from Aggregate Data*. Princeton University Press, Princeton, New Jersey, 1997.
- [274] Claude E. Shannon. A mathematical theory of communication. *Bell System Technical Journal*, 27:379–423, 1948. Reprinted in [288]. <http://cm.bell-labs.com/cm/ms/what/shannonday/paper.html>.
- [275] R. V. L. Hartley. Transmission of information. *Bell System Technical Journal*, pages 535–563, 1928.
- [276] Robert M. Gray. *Entropy and Information Theory*. Springer-Verlag, New York, 1990. <http://www-ee.stanford.edu/~gray/it.html>.
- [277] Luca Peliti and Angelo Vulpiani, editors. *Measures of Complexity: Proceedings of a Conference Held in Rome, September 30–October 2, 1987*. Springer-Verlag, Berlin, 1988.

- [278] Bruce H. Edmonds. Hypertext bibliography of measures of complexity, 1997. <http://www.cpm.mmu.ac.uk/~bruce/combib/>.
- [279] Peter Grünwald. A tutorial introduction to the minimum description length principle. In P. Grünwald, I. J. Myung, and M. Pitt, editors, *Advances in Minimum Description Length: Theory and Applications*, Cambridge, Massachusetts, 2005. MIT Press. <http://arxiv.org/abs/math.ST/0406077>.
- [280] Spyros Skouras. Decisionmetrics: A decision-based approach to econometric modeling. Technical Report 01-11-064, Santa Fe Institute, 2001. <http://www.santafe.edu/research/publications/wpabstract/200111064>.
- [281] Mathukumalli Vidyasagar. *A Theory of Learning and Generalization: With Applications to Neural Networks and Control Systems*. Springer-Verlag, Berlin, 1997.
- [282] William of Ockham. *Philosophical Writings: A Selection, Translated, with an Introduction, by Philotheus Boehner, O.F.M., Late Professor of Philosophy, The Franciscan Institute*. Bobbs-Merrill, Indianapolis, 1964. first pub. various European cities, early 1300s.
- [283] E. L. Lehmann. *Testing Statistical Hypotheses*. Springer Texts in Statistics. Springer-Verlag, Berlin, 2nd edition, 1997.
- [284] Patricia S. Churchland and Terrence J. Sejnowski. *The Computational Brain*. MIT Press, Cambridge, Massachusetts, 1992.
- [285] Marco Giunti. *Computation, Dynamics, and Cognition*. Oxford University Press, Oxford, 1997.
- [286] Norman Margolus. Crystalline computation. In Anthony J. G. Hey, editor, *Feynman and Computation: Exploring the Limits of Computers*, pages 267–305. Perseus Books, Reading, Massachusetts, 1999. <http://arxiv.org/abs/nlin.CG/9811002>.
- [287] Hirotugu Akaike. *Selected Papers of Hirotugu Akaike*. Springer-Verlag, Berlin, 1998. Edited by Emanuel Parzen, Kunio Tanabe and Genshiro Kitagawa.
- [288] Claude E. Shannon and Warren Weaver. *The Mathematical Theory of Communication*. University of Illinois Press, Urbana, Illinois, 1963.