

# Convergence of Perturbation Expansions in Fermionic Models

## Part 2: Overlapping Loops

Joel Feldman

Department of Mathematics  
University of British Columbia  
Vancouver, B.C.

CANADA V6T 1Z2

feldman@math.ubc.ca

<http://www.math.ubc.ca/~feldman/>

Horst Knorrer, Eugene Tsubowitz

Mathematik

ETH-Zentrum

CH-8092 Zurich

SWITZERLAND

knoerr@math.ethz.ch, tsub@math.ethz.ch

<http://www.math.ethz.ch/~knoerr/>

**Abstract.** We improve on the abstract estimate obtained in Part 1 by assuming that there are constraints imposed by 'overlapping momentum loops'. These constraints are active in a two dimensional, weakly coupled fermion gas with a strictly convex Fermi curve. The improved estimate is used in another paper to control everything but the sum of all ladder contributions to the thermodynamic Green's functions.

## Table of Contents

xV Introduction	p 1
xV I Overlapping Loops	p 2
Norms	p 2
Ladders	p 5
Overlapping loops for the Schwinger functional	p 7
Configurations of Norms with Improved Power Counting	p 11
xV II Finding Overlapping Loops	p 15
Overlapping loops created by the operator $R_{K,C}$	p 15
Tails	p 22
xV III The Enlarged Algebra	p 32
Definition of the enlarged algebra	p 34
Norm estimates for the enlarged algebra	p 36
Schwinger Functionals over the Extended Algebra	p 37
A second proof of Theorem IV.1	p 39
The Operator $Q$	p 41
xIX Overlapping Loops created by the second Covariance	p 44
Implementing Overlapping Loops	p 44
Tails	p 52
Proof of Theorem VI.10 in the general case	p 60
xx Example: A Vector Model	p 71
Appendices	
xC Ladders expressed in terms of kernels	p 79
References	p 83
Notation	p 84

## V . Introduction to Part 2

In the perturbative analysis of many fermion systems with weak short-range interaction in two or more space dimensions, the presence of an overlapping loop in a Feynman diagram introduces a volume effect in momentum space that leads to an improvement to "naive power counting". For a detailed discussion of this effect and its consequences, see [ST1-4]. For a short description, see subsection 4 of [KTF,xII]. In [KTo3], we use non-perturbative bounds for systems, in two space dimensions, that are based on the cancellation scheme between diagrams developed in part 1 of this paper. In this second part, we modify the construction so that we can exploit enough overlapping loops to get improved power counting for the two point function and the non-ladder part of the four point function. As in part 1, the treatment is in an abstract setting, formulated using systems of semigroups. The postulated volume improvement effects are expressed in terms of these semigroups (Definition VI.1). The main result for the renormalization group map is Theorem VI.6. It follows from Theorem VI.10, which is the main result on the Schwinger functional.

The discussion of the renormalization group map in the first part of the paper is based on the representation developed in [KT1] (which in turn evolved out of the representation developed in [MRT]). The representation of [KT1] decomposes Feynman diagrams into annuli. The first annulus consists of all interaction vertices directly connected to the external vertices. The second annulus consists of all interaction vertices directly connected to the first annulus but not to the external vertices. And so on. See the introduction to [KT1]. Overlapping loops that only involve vertices of neighbouring annuli are relatively easy to exploit. It turns out, that for the analysis of the two point function and the non-ladder part of the four point function, it suffices to use overlapping loops that involve only vertices of at most three adjacent annuli. A special case of Theorem VI.10, for which this combinatorial fact is easier to see, is proven at the end of xV II. After some preparation in xV III, the general case is proven at the end of xIX . In xX , we apply Theorem VI.6 to a simple vector model. We also describe, by drawing an analogy with the vector model, how sectors can be used to nonperturbatively implement overlapping loops for many fermion systems. A notation table is provided at the end of the paper.

# V I. 0 verlapping Loops

## V I.1 Norm s

Again, let  $A$  be a graded superalgebra and  $A^0 = \int_A V^0$  the Grassmann algebra in the variable  $\psi$  over  $A$ . Also fix two covariances  $C$  and  $D$  on  $V$ .

**Definition V I.1** Let  $k$  and  $k_{\text{impr}}$  be two families of symmetric seminorms on the spaces  $A_m \otimes V^n$  such that  $k \leq k_{\text{impr}}$  and  $k f k_{\text{impr}} = 0$  if  $f \in A_m \otimes V^n$  with  $m \geq 1$ . We say that  $(C; D)$  have improved integration constants  $c \in \mathbb{N}_d; b; J \in \mathbb{R}_+$  for the families  $k$  and  $k_{\text{impr}}$  of seminorms if  $c$  is a contraction bound for the covariance  $C$  for both seminorms  $k$  and  $k_{\text{impr}}$ ,  $b$  is an integral bound for  $C$  and  $D$  for both seminorms and the following triple contraction estimate holds:

Let  $n; n^0 \geq 3; 1 \leq i_1; i_2; i_3 \leq n$  and  $1 \leq j_1; j_2; j_3 \leq n^0$  with  $i_1; i_2; i_3$  all different and  $j_1; j_2; j_3$  all different. Also let the covariances  $C_1; C_2; C_3$  each be either  $C$  or  $D$  with at least one of these covariances equal to  $C$ . Then for  $f \in A_0 \otimes V^n; f^0 \in A_0 \otimes V^{n^0}$

$$\text{Con}_{C_1}^{i_1! j_1} \text{Con}_{C_2}^{i_2! j_2} \text{Con}_{C_3}^{i_3! j_3} (f f^0)_{\text{impr}} \leq J b^4 c k f k f^0 k$$

Observe that  $\text{Con}_{C_1}^{i_1! j_1} \text{Con}_{C_2}^{i_2! j_2} \text{Con}_{C_3}^{i_3! j_3} (f f^0) \in A_0 \otimes V^{(n+n^0-6)}$ .

**Lemma V I.2** Assume that  $(C; D)$  have improved integration constants  $c; b; J$  for the families  $k$  and  $k_{\text{impr}}$  of seminorms. Let  $n_1; \dots; n_{r+1}; n \geq 0$ , let

$$f_1 \in A_0^{(1); \dots; (r)} [n_1; \dots; n_r];$$

$$f_2 \in A_0^{(r+1); \dots; (r+s)} [n_{r+1}; \dots; n_r]$$

and let  $i_1; i_2; i_3 \in \{1; \dots; r\}$  and  $j_1; j_2; j_3 \in \{r+1; \dots; r+s\}$ . Also let the covariances  $C_1; C_2; C_3$  each be either  $C$  or  $D$  with at least one of these covariances is equal to  $C$ . Then

$$\text{Con}_{C_1}^{(i_1)! (j_1)} \text{Con}_{C_2}^{(i_2)! (j_2)} \text{Con}_{C_3}^{(i_3)! (j_3)} (f_1 f_2)_{\text{impr}} \leq J n_{j_1} n_{j_2} n_{j_3} b^4 c k f_1 k k f_2 k$$

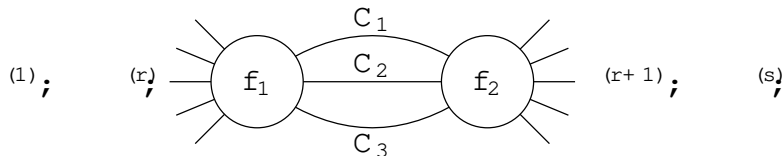

**Proof:** The proof is analogous to that of Lemma II.29. ■

We define, for a Grassmann function  $f$  the improved norm  $N_{\text{impr}}(f)$  as in Definition II.23. That is,

$$N_{\text{impr}}(f; \mathbf{a}) = \frac{c}{b^2} \sum_{n_1; \dots; r; n_0} \prod_{j=1}^n b^{j n_j} k_{f_0, n_1; \dots; r} k_{\text{impr}}$$

An abstract example of such norms is described at the end of this Section, and this abstract example is made concrete in §X.

Definition V I.3 Let  $f(\mathbf{a}^{(1)}; \dots; \mathbf{a}^{(r)})$  be a Grassmann function and  $I = \{1; \dots; r\}$ . We say that  $f$  has degree  $d$  in the variables  $\mathbf{a}^{(i)}; i \in I$  if

$$f \in \sum_{\substack{m; n_1; \dots; r; n \\ \sum_{i \in I} n_i = d}} A_m[\mathbf{a}^{(1)}; \dots; \mathbf{a}^{(r)}]$$

where  $A_m[\mathbf{a}^{(1)}; \dots; \mathbf{a}^{(r)}]$  was defined in Definition II.21. We say that  $f$  has degree at least  $d$  in the variables  $\mathbf{a}^{(i)}; i \in I$  if  $f = \sum_{d^0 \leq d} f_{d^0}$  where each  $f_{d^0}$  has degree  $d^0$  in the variables  $\mathbf{a}^{(i)}; i \in I$ . Similarly we say that  $f$  has degree at most  $d$  in the variables  $\mathbf{a}^{(i)}; i \in I$  if  $f = \sum_{d^0 \leq d} f_{d^0}$  where each  $f_{d^0}$  has degree  $d^0$  in the variables  $\mathbf{a}^{(i)}; i \in I$ .

Proposition V I.4 Let  $(C; D)$  have improved integration constants  $c; b; J$ . Let  $r \leq s \leq 1$ , and let  $f_1(\mathbf{a}^{(1)}; \dots; \mathbf{a}^{(s)}; \mathbf{a}^{(s+1)}; \dots; \mathbf{a}^{(t)}; \mathbf{a}^{(t+1)}; \dots; \mathbf{a}^{(r)})$  and  $f_2(\mathbf{a}^{(1)}; \dots; \mathbf{a}^{(r)})$  be Grassmann functions. Set

$$g(\mathbf{a}^{(t+1)}; \dots; \mathbf{a}^{(r)}) = \int_C \int_D f_1(\mathbf{a}^{(1)}; \dots; \mathbf{a}^{(s)}; \mathbf{a}^{(s+1)}; \dots; \mathbf{a}^{(t)}; \mathbf{a}^{(t+1)}; \dots; \mathbf{a}^{(r)}) \cdot \int_C \int_D f_2(\mathbf{a}^{(1)}; \dots; \mathbf{a}^{(r)})$$

If  $f_1$  has degree at least one in the variables  $\mathbf{a}^{(1)}; \dots; \mathbf{a}^{(s)}$  and degree at least three in the variables  $\mathbf{a}^{(1)}; \dots; \mathbf{a}^{(t)}$ , then

$$N_{\text{impr}}(g; \mathbf{a}) \leq 27 \frac{J}{6} N(f_1; \mathbf{a}) N(f_2; \mathbf{a})$$

for  $\mathbf{a} \geq 2$ .

Proof: Set  $\mathbf{f}_i = \int_C \int_D f_i(\mathbf{a}^{(1)}; \dots; \mathbf{a}^{(s)}; \mathbf{a}^{(s+1)}; \dots; \mathbf{a}^{(t)}; \mathbf{a}^{(t+1)}; \dots; \mathbf{a}^{(r)})$ . We first prove the statement in the case that  $f_1$  and  $f_2$  are both homogeneous, that is

$$f_1 \in A_0[\mathbf{a}^{(1)}; \dots; \mathbf{a}^{(s)}; \mathbf{a}^{(s+1)}; \dots; \mathbf{a}^{(t)}; \mathbf{a}^{(t+1)}; \dots; \mathbf{a}^{(r)}]$$

$$f_2 \in A_0[\mathbf{a}^{(1)}; \dots; \mathbf{a}^{(r)}]$$

Then  $g = 0$  unless  $n_i = n_i^0$  for  $1 \leq i \leq t$ , and  $g \in A_0[n_{t+1} + n_{t+1}^0; r; n_r^0]$ . By hypothesis  $n_1 + \dots + n_t = n$  and  $n_1 + \dots + n_t = n - 3$ . Therefore it is possible to choose  $i_1 \in \{1, \dots, t\}$  with  $n_{i_1} = 1$ , and to choose  $i_2, i_3 \in \{1, \dots, t\}$  such that

$$\begin{aligned} n_{i_2} &= \begin{cases} 1 & \text{if } i_2 \notin \{i_1\} \\ 2 & \text{if } i_2 = i_1 \end{cases} \\ n_{i_3} &= \begin{cases} 1 & \text{if } i_3 \notin \{i_1, i_2\} \\ 2 & \text{if } i_3 \in \{i_1, i_2\} \text{ but } i_1 \neq i_2 \\ 3 & \text{if } i_3 = i_2 = i_1 \end{cases} \end{aligned}$$

Set

$$C^0 = \begin{cases} C & \text{if } 1 \leq i \leq s \\ D & \text{if } s+1 \leq i \leq t \end{cases}$$

Clearly,  $C_1^0 = C$ . Also set  $C_{(i)} = C_{(i)} \otimes C_{(i)}$  and

$$\begin{aligned} g^0((1); (r); (1); (r)) &= C_{(1)} \otimes C_{(2)} \otimes C_{(3)} f_1((1); (r)) f_2((1); (r)) \\ g^0((1); (r); (1); (r)) &= C_{(1)} \otimes C_{(2)} \otimes C_{(3)} \tilde{f}_1((1); (r)) \tilde{f}_2((1); (r)) \end{aligned}$$

Observe that

$$\begin{aligned} g^0 \in A_0[n_1 + (n_{i_1} + n_{i_2} + n_{i_3}); r; n_r] \\ n_1^0 + (n_{i_1} + n_{i_2} + n_{i_3})^0; r; n_r] \end{aligned}$$

and

$$g^0((1); (r); (1); (r)) = :g^0((1); (r); (1); (r)) :_{(1); (r); (1); (r)}^{(1); (r); (1); (r)} :_{(1); (r); (1); (r)}^{(s+1); (r); (s+1); (r)}$$

by Remark II.12. By Lemma II.13

$$g = \sum_{i=1}^Z \sum_{j=s+1}^Z g^0((1); (r); (1); (r)) \otimes d_C^{(i)} \otimes d_D^{(j)}$$

By Lemma II.29 and Lemma VI.2

$$\|g\|_{\text{im pr}} \leq b^{2(n_1 + \dots + n_t)} \|g^0\|_{\text{im pr}} \leq J \frac{n_{i_1} n_{i_2} n_{i_3} C}{b^2} b^{2(n_1 + \dots + n_t)} \|f_1\| \|f_2\| \quad (\text{VI.1})$$

Therefore

$$\begin{aligned} N_{\text{im pr}}(g) &= \frac{C}{b^2} n_{t+1} + \dots + n_{t+1}^0 + \frac{J}{b^2} n_{t+1} + \dots + n_{t+1}^0 + \frac{J}{b^2} \|g\|_{\text{im pr}} \\ &\leq \frac{n_{i_1} n_{i_2} n_{i_3} J C^2}{2(n_1 + \dots + n_t) b^4} b^{n_1 + \dots + n_t} \|f_1\| \|f_2\| \\ &\leq J \frac{n_{i_1} n_{i_2} n_{i_3} C}{2(n_1 + \dots + n_t)} N(f_1) N(f_2) \\ &\leq 27 \frac{J}{6} N(f_1) N(f_2) \end{aligned}$$

The general case now follows by decomposing  $f_1$  and  $f_2$  into homogeneous pieces. ■

## VI.2 Ladders

Theorem VI.6, below, which is the main result of this paper, shows that under appropriate assumptions on an effective interaction  $W(\cdot)$ , the two point and non{ladder four point parts of the effective interaction  $\mathcal{W}^0(\cdot) : \mathcal{D} = \mathcal{C} \mathcal{W} : \mathcal{C} + \mathcal{D}$ , constructed using the Grassmann Gaussian integral with covariance  $C$ , obeys estimates that are better by a factor  $J$  than those one would expect from Theorem IV.1. To formulate this precisely, we first give the Definition of ladders.



In a ladder, neighbouring four legged vertices are connected by two covariances. Since ladders result from integrating with covariance  $C$ , at least one of the connecting covariances is equal to  $C$ . The other connecting covariance may be  $C$  or  $D$ .

In the rest of the paper, we will systematically use  $;\ ^0; \ ^0;$  for elds associated to the covariance  $C$ . We will use  $;\ ^0; \ ^0;$  for elds associated to the covariance  $D$  and for the external elds.

Definition VI.5

(i) A rung is a Grassmann function

$$(\ ; \ ; \ ^0; \ ^0) \in \mathcal{A} [0;2;0;2] \ \mathcal{A} [1;1;0;2] \ \mathcal{A} [0;2;1;1] \ \mathcal{A} [1;1;1;1]$$

We think of  $;\$  as the  $D$  resp.  $C$  elds on the left side of the rung and of  $;\ ^0; \ ^0$  as the  $D$  resp.  $C$  elds on the right side of the rung.

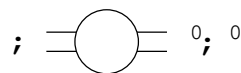

An end is a Grassmann function

$$E(\ ; \ ; ) \in \mathcal{A} [2;0;2] \ \mathcal{A} [2;1;1]$$

We think of  $\ \$  as the external elds at the end of the ladder and of  $;\$  as the  $D$  resp.  $C$  elds going into the ladder.

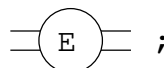





Theorem V I.6 Let  $W(\cdot)$  be an even Grassmann function with coefficients in  $A$ . Assume that  $N(W;64)_0 < \frac{1}{8}$ , and that  $\delta \geq 8$ . Set

$$:W^0(\cdot):_{;D} = c :W(\cdot):_{;C+D}$$

If  $(C;D)$  have improved integration constants  $c;b;J$ , then

(i)

$$\begin{aligned} N(W^0;W) &= \frac{1}{2^{-2}} \frac{N(W;32)^2}{1 - \frac{1}{2}N(W;32)} \\ N_{\text{impr}}(W^0;W) &= \frac{1}{2^{-2}} \frac{N(W;32)^2}{1 - \frac{1}{2}N(W;32)} \end{aligned}$$

(ii) Write  $W(\cdot) = \prod_{m;n} W_{m;n}(\cdot)$ ,  $W^0(\cdot) = \prod_{m;n} W_{m;n}^0(\cdot)$  with  $W_{m;n};W_{m;n}^0 \in A_m^0[n]$ . If  $W_{0;2} = 0$ , then

$$\begin{aligned} N_{\text{impr}}(W_{0;2}^0;W_{0;2}) &= \frac{2^{10}J}{6} \frac{N(W;64)^2}{1 - \frac{\delta}{2}N(W;64)} \\ N_{\text{impr}}(W_{0;4}^0;W_{0;4}) &= \frac{1}{2} \sum_{r=1}^4 L_r(W_{0;4}); \quad \frac{2^{10}J}{6} \frac{N(W;64)^2}{1 - \frac{\delta}{2}N(W;64)} \end{aligned}$$

Remark V I.7

i) Part (i) of the Theorem follows directly from Theorem IV 1. For the proof of part (ii) one can replace the algebra  $A$  by  $A_0$ , since  $W_{0;2}^0;W_{0;2}^0$  and  $L_r(W_{0;4})$  depend only on  $\prod_{n=0}^1 W_{0;n}$ .

ii) The hypothesis that  $W_{0;2} = 0$  in part (ii) of Theorem V I.6 prevents strings of two-legged vertices from appearing in diagrammatic expansions. The expansion used in the proof of part (ii) cannot detect certain overlapping loops containing such strings. In practice a nonzero  $W_{0;2}$  can be absorbed in the propagator.

The proof of part (ii) of Theorem V I.6 is based on an analysis of

### V I.3 Overlapping loops for the Schwinger functional

We first generalise the concept of a ladder.

If  $U(\cdot; \cdot)$  is a Grassmann function we write

$$U(\cdot + \cdot^0; \cdot + \cdot^0) = \sum_{\substack{p_1;p_2 \\ n_0;n_1;n_2}}^X U_{n_0;p_1;p_2;n_1;n_2}(\cdot; \cdot^0; \cdot; \cdot^0)$$

with  $U_{n_0;p_1;p_2;n_1;n_2} \in A[n_0;p_1;p_2;n_1;n_2]$ .



The main estimate on the Schwinger functional is:

Theorem VI.10 Let  $A$  be a superalgebra, with all elements having degree zero (that is  $A = A_0$ ),  $k$  and  $k_{\text{im pr}}$  be two families of symmetric seminorms on the spaces  $A_m \subset V^n$  and let  $(C; D)$  have improved integration constants  $c; b; J$ . Let  $\hat{U}(\cdot; \cdot); \hat{f}(\cdot; \cdot)$  be Grassmann functions with coefficients in  $A$  of degree at least four and  $\hat{U}$  even. Set

$$U(\cdot; \cdot) = : \hat{U}(\cdot; \cdot) :_{;C}^{;D}$$

$$f(\cdot; \cdot) = : \hat{f}(\cdot; \cdot) :_{;C}^{;D}$$

Assume that  $\delta$  and  $N(\hat{U}; 32)_0 < \frac{1}{8}$ . By Proposition III.10

$$: f^0(\cdot) :_{;D} = S_{U;C}(f)$$

exists. Write

$$\hat{f}(\cdot; \cdot) = \sum_{n_0; n_1}^P \hat{f}_{n_0; n_1}(\cdot; \cdot) \quad ; \quad f^0(\cdot) = \sum_n^P f_n^0(\cdot)$$

with  $\hat{f}_{n_0; n_1} \in A[n_0; n_1]; f_n^0 \in A[n]$ . Then

$$N_{\text{im pr}}(f^0; \cdot) \leq \frac{2^{10} J}{6} \frac{N(\hat{U}; 32)}{1 - \frac{\delta}{8} N(\hat{U}; 32)} N(\hat{f}; 32)$$

and there exists a Grassmann function  $g(\cdot)$  such that

$$f_4^0 = \hat{f}_{4;0} + \sum_{\nu=1}^P T_\nu(\hat{U}) \mathbb{T}_1(\hat{f}) + \frac{1}{2} \sum_{\nu; \nu_0=1}^P T_\nu(\hat{U}) \text{Rung} \hat{f} \mathbb{T}_0(\hat{U}) + g$$

and

$$N_{\text{im pr}}(g; \cdot) \leq \frac{2^{10} J}{6} \frac{N(\hat{U}; 32)}{1 - \frac{\delta}{8} N(\hat{U}; 32)} N(\hat{f}; 32)$$

In the case  $D = 0$  this Theorem is proven in Section VI; in the general case it is proven in Section VIII.

Proof that Theorem VI.10 implies Theorem VI.6: By part (i) of Remark VI.7 we may assume that  $A = A_0$ . We write  $W_n$  for  $W_{0;n}$  and  $W_n^0$  for  $W_{0;n}^0$ . Set

$$\hat{U}(\cdot; \cdot) = W(\cdot + \cdot) \hat{\quad}_{A^0} V$$

$$U(\cdot; \cdot) = : \hat{U}(\cdot; \cdot) :_{;C}^{;D}$$

$$: U_t^0(\cdot) :_{;D} = S_{tU;C}(U)$$

By Remark II.24,  $N(\hat{U}; 2) = N(W; 2)$ . As in the proof of Theorem II.28

$$W^0(\cdot) : \mathbb{D} \rightarrow \mathbb{D} \quad W(\cdot) : \mathbb{D} \rightarrow \mathbb{D} = \int_0^{Z-1} U_t^0(\cdot) : \mathbb{D} \quad \hat{U}(\cdot; 0) : \mathbb{D} \quad dt \quad \text{mod } A_0$$

so

$$W^0(\cdot) - W(\cdot) = \int_0^{Z-1} U_t^0(\cdot) - \hat{U}(\cdot; 0) \quad dt \quad \text{mod } A_0$$

In particular, for  $n = 2; 4$

$$W_n^0 - W_n = \int_0^{Z-1} U_{t;n}^0 - \hat{U}_{n;0} \quad dt$$

Therefore, by Theorem VI.10

$$\begin{aligned} N_{\text{impr}}(W_2^0) &= \max_{0 \leq t \leq 1} N_{\text{impr}} U_{t;2}^0 \\ &= \frac{2^{10} J}{6} \frac{N(\hat{U}; 32)}{1 - \frac{2}{3} N(\hat{U}; 32)} N(\hat{U}; 32) \\ &= \frac{2^{10} J}{6} \frac{N(W; 64)^2}{1 - \frac{2}{3} N(W; 64)} \end{aligned}$$

Observe that

$$\begin{aligned} \text{Rung}(\hat{U}) &= (W_4) \\ T(\hat{U}) &= E(W_4) \quad (W_4) \quad (4)(W) \end{aligned}$$

with 1 copies of  $(W_4)$ . Therefore

$$\begin{aligned} T(t\hat{U}) - T_1(\hat{U}) &= t'L_1(W_4) \\ T(t\hat{U}) - \text{Rung}(\hat{U}) - T_0(\hat{U}) &= t'^+{}^0 L_{1+0}(W_4) \end{aligned}$$

Hence, by Theorem VI.10

$$W_4^0 = W_4 + \int_{r=1}^P \int_0^{Z-1} t'L_1(W_4) \quad dt + \frac{1}{2} \int_{r=0}^P \int_0^{Z-1} t'^+{}^0 L_{1+0}(W_4) \quad dt + g$$

with

$$N_{\text{impr}}(g) = \frac{2^{10} J}{6} \frac{N(\hat{U}; 32)}{1 - \frac{2}{3} N(\hat{U}; 32)} N(\hat{U}; 32) - \frac{2^{10} J}{6} \frac{N(W; 64)^2}{1 - \frac{2}{3} N(W; 64)}$$

Now

$$\begin{aligned} \int_{r=1}^P \int_0^{Z-1} t'L_1(W_4) \quad dt + \frac{1}{2} \int_{r=0}^P \int_0^{Z-1} t'^+{}^0 L_{1+0}(W_4) \quad dt &= \frac{1}{2} \int_{r=1}^P \int_0^{Z-1} (r+1) t^r L_r(W_4) \quad dt \\ &= \frac{1}{2} \int_{r=1}^P L_r(W_4) \end{aligned}$$

■

## V I.4 C on gurations of N orm s w ith Im proved P ower C ounting

D e nition V I.11 Let  $q$  be an even natural number. For  $p = 1; 2; 3; \dots; q$ , let  $k_p$  be a system of symmetric seminorms on the spaces  $A_m \subset V^n$ . We say that  $(C; D)$  have integration constants  $c; b$  for the configuration  $k_1, k_2, \dots, k_q$  of seminorms if the following estimates hold:

Let  $m; m^0 \geq 0$  and  $1 \leq i \leq n; 1 \leq j \leq n^0$ . Also let  $f \in A_m \subset V^n, f^0 \in A_{m^0} \subset V^{n^0}$ . Then for all natural numbers  $p \leq q$  the simple contraction estimate

$$\text{Con}_C (f, f^0)_p \leq c \sum_{\substack{p_1+p_2=p+1 \\ \text{at least} \\ \text{one odd}}}^P kfk_{p_1} kfk_{p_2}^0$$

holds.

Furthermore, if  $C_2; C_3 \in C; D$ ,  $m = m^0 = 0, 1 \leq i_1; i_2; i_3 \leq n$  with  $i_1; i_2; i_3$  all different and  $1 \leq j_1; j_2; j_3 \leq n^0$  with  $j_1; j_2; j_3$  all different, the improved contraction estimate

$$\text{Con}_C \text{Con}_{C_2} \text{Con}_{C_3} (f, f^0)_p \leq b^4 c \sum_{\substack{p_1+p_2=p+3 \\ \text{at least} \\ \text{one odd}}}^P kfk_{p_1} kfk_{p_2}^0$$

holds for  $p \leq q - 2$ .

For every  $f \in A_m \subset V^n$  and every  $n^0 \leq n$  the modified integral bound

$$\int_C \text{Ant}_{n^0}(f) d_C \leq \int_D \text{Ant}_{n^0}(f) d_D \leq \frac{1}{2} (b=2)^{n^0} kfk_p + kfk_p (1)^p \quad (\text{VI:2})$$

holds. The partial antisymmetrization  $\text{Ant}_{n^0}$  was defined in Definition II.25.ii.

Lem m a V I.12 Let  $q$  be an even natural number. Assume that  $(C; D)$  have integration constants  $c; b$  for the configuration  $k_1, k_2, \dots, k_q$  of seminorms and let  $J > 0$ . For  $f \in A_m \subset V^n$ , set

$$\begin{aligned} kfk &= \sum_{p=1}^q \int^{[(p-1)=2]} kfk_p = kfk_1 + kfk_2 + \frac{1}{J} kfk_3 + \frac{1}{J} kfk_4 + \dots + \frac{1}{J^{(q-2)/2}} kfk_q \\ kfk_{\text{in } p} &\geq \sum_{p=1}^q \int^{[(p-1)=2]} kfk_p \quad \text{if } m = 0 \\ &\geq 0 \quad \text{if } m \neq 0 \end{aligned}$$

Here  $[(p-1)=2]$  is the integer part of  $\frac{p-2}{2}$ . Then  $(C; D)$  have improved integration constants  $c; b; J$  for the families  $k_1, k_2$  and  $k_{\text{in } p}$  of seminorms.

Proof: Clearly  $\|k\|_{\text{pr}} = \|k\|$ . To verify that  $c$  is a contraction bound for  $C$  let  $f \in A_m \subset V^n$ ,  $f^0 \in A_{m^0} \subset V^{n^0}$  and  $1 \leq i \leq n; 1 \leq j \leq n^0$ . Observe that if  $p_1 + p_2 = p + 1$  with at least one of  $p_1$  and  $p_2$  odd, then

$$\frac{1}{J^{[(p_1-1)=2]}} \frac{1}{J^{[(p_2-1)=2]}} = \frac{1}{J^{[(p_1+p_2-2)=2]}} = \frac{1}{J^{[(p-1)=2]}}$$

Consequently,

$$\begin{aligned} \text{Conc}_C (f - f^0)_{i!n+j} &= \sum_{p=1}^P J^{[(p-1)=2]} \| \text{Conc}_C f - f^0 \|_{i!n+j}^p \\ &\leq \sum_{p=1}^P C^p J^{[(p-1)=2]} \|k\|_{p_1}^{p_1} \|k\|_{p_2}^{p_2} \\ &\quad \text{with } p_1 + p_2 = p + 1 \text{ at least one odd} \\ &\leq \sum_{p=1}^P C^p J^{[(p_1-1)=2]} \|k\|_{p_1}^{p_1} J^{[(p_2-1)=2]} \|k\|_{p_2}^{p_2} \\ &\quad \text{with } p_1 + p_2 = p + 1 \\ &= c \|k\|_{\text{pr}} \|k\|_{\text{pr}}^0 \end{aligned}$$

Replacing  $q$  by  $q - 2$  gives the corresponding bound for  $\|k\|_{\text{pr}}$ . To verify the triple contraction estimate of Definition VI.1, let  $C_2; C_3 \in \mathcal{F}C; D, g, m = m^0 = 0, 1 \leq i_1; i_2; i_3 \leq n$  with  $i_1; i_2; i_3$  all different and  $1 \leq j_1; j_2; j_3 \leq n^0$  with  $j_1; j_2; j_3$  all different. Then

$$\begin{aligned} \text{Conc}_C \text{Conc}_{C_2} \text{Conc}_{C_3} (f - f^0)_{i_1!n+j_1, i_2!n+j_2, i_3!n+j_3} \| \text{pr} &= \sum_{p=1}^P J^{[\frac{p-1}{2}]} \text{Conc}_C \text{Conc}_{C_2} \text{Conc}_{C_3} (f - f^0)_p \\ &\leq J b^4 \sum_{p=1}^P C^2 J^{[(p+1)=2]} \|k\|_{p_1}^{p_1} \|k\|_{p_2}^{p_2} \\ &\quad \text{with } p_1 + p_2 = p + 3 \text{ at least one odd} \\ &\leq J b^4 \sum_{p_1+p_2=1}^P J^{[(p_1-1)=2]} \|k\|_{p_1}^{p_1} J^{[(p_2-1)=2]} \|k\|_{p_2}^{p_2} \\ &= J b^4 c \|k\|_{\text{pr}} \|k\|_{\text{pr}}^0 \end{aligned}$$

We verify that  $b$  is an integral bound for  $C$  for the norm  $\|k\|$ . The other cases are similar. Let  $f \in A_m \subset V^n$  and  $n^0 \leq n$ . Then

$$\begin{aligned} \sum_{n^0} \text{Ant}_{n^0}(f) d_C &= \sum_{p=1}^P J^{[(p-1)=2]} \sum_{n^0} \text{Ant}_{n^0}(f) d_C^p \\ &= \frac{1}{2} (b=2)^{n^0} \sum_{p=1}^P J^{[(p-1)=2]} \|k\|_p^h + \|k\|_{(p-1)}^i \quad \text{(VI.3)} \\ &= (b=2)^{n^0} \|k\| \end{aligned}$$

■

In our main application, we use a special case of Definition VI.11 in which only norms  $k_{\mathbb{K}}$ , with  $p$  odd, appear.

Definition VI.13 Let  $q$  be an odd natural number. For  $p = 1; 3; 5; \dots; q$ , let  $k_p$  be a system of symmetric seminorms on the spaces  $A_m \subset V^n$ . We say that  $(C; D)$  have integration constants  $c; b$  for the configuration  $k_{\mathbb{K}}, k_{\mathbb{K}}, \dots, k_q$  of seminorms if  $b$  is an integral bound for both  $C$  and  $D$  and all of the seminorms  $k_{\mathbb{K}}$  (see Definition II.25.ii) and the following contraction estimates hold:

Let  $m; m^0 \geq 0$  and  $1 \leq i \leq n; 1 \leq j \leq n^0$ . Also let  $f \in A_m \subset V^n, f^0 \in A_{m^0} \subset V^{n^0}$ . Then for all odd natural numbers  $p \leq q$

$$\text{Con}_C (f, f^0)_p \leq c \sum_{\substack{p_1 + p_2 = p + 1 \\ p_1, p_2 \text{ odd}}}^P k f k_{p_1} k f^0 k_{p_2}$$

Furthermore, if  $C_2; C_3 \in FC; Dg, m = m^0 = 0, 1 \leq i_1; i_2; i_3 \leq n$  with  $i_1; i_2; i_3$  all different and  $1 \leq j_1; j_2; j_3 \leq n^0$  with  $j_1; j_2; j_3$  all different, then, for all odd  $p \leq q \leq 2$ ,

$$\text{Con}_C \text{Con}_{C_2} \text{Con}_{C_3} (f, f^0)_p \leq b^4 c \sum_{\substack{p_1 + p_2 = p + 3 \\ p_1, p_2 \text{ odd}}}^P k f k_{p_1} k f^0 k_{p_2}$$

Remark VI.14 If, in the setting of Definition VI.13, the norm  $k_{\mathbb{K}}$  is defined to be zero for all even  $p$ , then the conditions of Definition VI.11 are fulfilled, except that the factor of  $\frac{1}{2}$  in (VI.2) does not appear in the Definition II.25.ii of integral bound.

Lemma VI.15 Let  $q$  be an odd natural number. Assume that  $(C; D)$  have integration constants  $c; b$  for the configuration  $k_{\mathbb{K}}, k_{\mathbb{K}}, \dots, k_q$  of seminorms and let  $J > 0$ . For  $f \in A_m \subset V^n$ , set

$$k f k = \sum_{\substack{p=1 \\ p \text{ odd}}}^P J^{(1-p)/2} k f k_p$$

$$k f k_{\text{impr}} = \begin{cases} \sum_{\substack{p=1 \\ p \text{ odd}}}^P J^{(1-p)/2} k f k_p & \text{if } m = 0 \\ 0 & \text{if } m \neq 0 \end{cases}$$

Then  $(C; D)$  have improved integration constants  $c; b; J$  for the families  $k_{\mathbb{K}}$  and  $k_{\text{impr}}$  of seminorms.

Proof: By Remark VI.14, Lemma VI.12 implies all of the conditions of Definition VI.1, except that  $b$  be an integral bound for  $C$  and  $D$  for both seminorms. However, the proof of this condition is virtually identical to (VI.3). ■

Remark VI.16 Lemma VI.15 holds for all  $J > 0$ . In applications,  $J$  is chosen so that

$$\|f\|_p \leq \text{const} J^{(p-1)/2} \|f\|_1 \quad (\text{VI.4})$$

for all  $f$  of interest. If  $J$  satisfying (VI.4) can be chosen sufficiently small, Lemma VI.15 can be used in conjunction with Proposition VI.4 to obtain improved bounds, as the following example illustrates.

For simplicity, we assume that  $q = 3$ . Let  $f^{(1)};^{(2)} \in A_0[n_1; n_2]$  with  $n_2 \geq 3$  and set

$$g^{(1)} = \sum_{(2), C} f^{(1)};^{(2)} d_C^{(2)}$$

The standard bound, without improvement, follows from (II.4) in the proof of Proposition II.33:

$$\|g\|_1 \leq n_2 c b^{2(n_2-1)} \|f\|_1^2$$

On the other hand, by (VI.1), in the proof of Proposition VI.4,

$$\|g\|_1 = \|g\|_{\text{impr}} \leq n_2^3 J c b^{2(n_2-1)} \|f\|^2 = n_2^3 J c b^{2(n_2-1)} \|f\|_1 + \frac{1}{J} \|f\|_3^2$$

If  $\|f\|_3 \leq \text{const} J \|f\|_1$ ,

$$\|g\|_1 \leq \text{const} n_2^3 J c b^{2(n_2-1)} \|f\|_1^2$$



## V II. Finding Overlapping Loops

In this chapter, we give the proof of Theorem VI.10 in the case  $D = 0$ , using the representation  $S_{U;C} = \frac{1}{\mathbb{1} R_{U;C}} d_C$  of Theorem III.2. We assume that the coefficient algebra  $A$  contains only elements of degree zero, that is  $A = A_0$ . Let  $k_k$  and  $k_{k_{pr}}$  be two families of symmetric seminorms on the spaces  $A_m \subset V^n$  such that  $(C;0)$  has improved integration constants  $c; b; J$  for these families of seminorms.

Recall from Remark III.6 that the operator  $R_{K;C}$  is written as a sum of operators  $R_C(K_1; \dots; K_n)$  with even Grassmann functions  $K_1(\dots; \dots); \dots; K_n(\dots; \dots)$ . If one of these Grassmann functions, say  $K_1$  has degree at least three in the variables  $\dots$ ; then, for any Grassmann function  $f(\dots)$ , there is a pair of overlapping loops in each Feynman diagram contributing to  $R_C(K_1; \dots; K_n; f)$ . The way these overlapping loops can occur is indicated in the figures below.

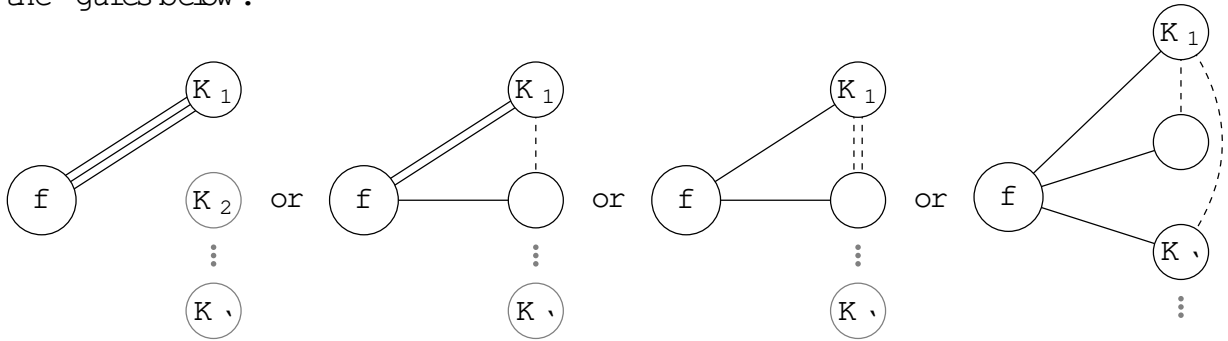

### V II.1 Overlapping loops created by the operator $R_{K;C}$

In this subsection, we suppress the external fields by working in the Grassmann algebra  $V_{A^0} V$  with coefficients in the algebra  $A^0 = V_A V$  generated by the fields. This algebra was defined in subsection III.2. Recall that  $k_k$  and  $k_{k_{pr}}$  induce a family of symmetric seminorms on the spaces  $A_m^0 \subset V^n$ , which we here denote by the same symbols.

We split up the operators  $R_C(K_1; \dots; K_n)$  of (III.2) in order to exhibit possible overlapping loops. For Grassmann functions  $K_2(\dots; \dots); \dots; K_n(\dots; \dots)$  and  $f(\dots)$  we define

$$R_C(K_2; \dots; K_n; f) = \sum_{i=2}^n \sum_{j=0}^{\infty} K_i(\dots; \dots + \dots; \dots)_j :_0 f(\dots + \dots) d_C(\dots) d_C(\dots) \quad (V II.1)$$

This is a Grassmann function of  $\dots; \dots$ ; that is schematically represented in the figure below.

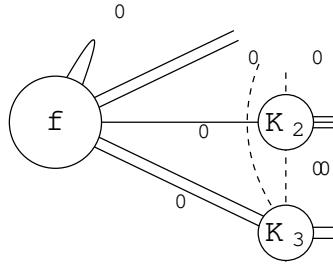

Proposition VII.1 For even Grassmann functions  $K_1(\xi; \xi^0); \dots; K_i(\xi; \xi^0)$  and  $f(\xi)$

$$R_C(K_1; \dots; K_i) = \int_{\mathbb{Z}} K_1(\xi; \xi^0); \dots; R_C(K_2; \dots; K_i)(\xi; \xi^0); d_C(\xi^0) d_C(\xi)$$

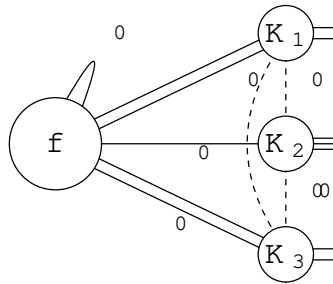

Proof: If

$$f^0 = R_C(K_1; \dots; K_i)$$

then by part (iii) of Proposition A.2 (applied to the variable  $\xi^0$ ) and Lemma A.5 (applied to the variable  $\xi$ )

$$\begin{aligned} f^0 &= \int_{\mathbb{Z}} K_1(\xi; \xi^0); \dots; \int_{\mathbb{Z}} K_i(\xi; \xi^0); \dots; f(\xi) d_C(\xi^0) d_C(\xi) \\ &= \int_{\mathbb{Z}} K_1(\xi; \xi^0); \dots; \int_{\mathbb{Z}} K_i(\xi; \xi^0 + \xi^0); \dots; f(\xi) d_C(\xi^0) d_C(\xi) \\ &= \int_{\mathbb{Z}} K_1(\xi; \xi^0); \dots; \int_{\mathbb{Z}} K_i(\xi; \xi^0 + \xi^0); \dots; f(\xi + \xi^0) d_C(\xi^0) d_C(\xi) \\ &= \int_{\mathbb{Z}} K_1(\xi; \xi^0); \dots; R_C(K_2; \dots; K_i)(\xi; \xi^0); d_C(\xi^0) d_C(\xi) \end{aligned}$$



Remark V II.2 Set

$$\hat{K}^{(i)}(\dots) = K^{(i)}(\dots) \\ \hat{f}(\dots) = f(\dots)$$

Then the map  $f: \mathcal{R}_C(K; \dots) \rightarrow \mathcal{R}_C(\hat{K}; \dots)$  over the algebra  $A^0$  agrees with the map  $f: \mathcal{R}_C(\hat{K}; \dots) \rightarrow \mathcal{R}_C(K; \dots)$  of (III.2) over the algebra  $\tilde{A}$  of Grassmann functions in the variables  $\dots$  with coefficients in  $A^0$ . Therefore we can use the results of XIII to obtain estimates on  $\mathcal{R}_C$ .

Lemma V II.3 Let  $K(\dots)$  be an even Grassmann function with  $K(\dots; 0) = 0$ . Decompose

$$K(\dots) = K^0(\dots) + K^{\infty}(\dots)$$

where  $K^0$  has degree at most two in the variables  $\dots$  and  $K^{\infty}$  has degree at least three in the variables  $\dots$ . Let each of the functions  $K^{(1)}, \dots, K^{(j)}$  be one of  $K^0, K^{\infty}$  or  $K$ , and assume that at least one of them is equal to  $K^{\infty}$ . Let  $f(\dots) \in A^0 V$ , and set

$$\frac{1}{j!} \mathcal{R}_C(K^{(1)}, \dots, K^{(j)})(f) = f^0(\dots)$$

Then, if  $j \geq 2$

$$N_{\text{im pr}}(f^0; \dots) \leq \frac{2^j j}{j+5} N(f; 2) N(K; 2)^j$$

Proof: We may assume that  $K^{(1)} = K^{\infty}$ . Set

$$g(\dots) = \mathcal{R}_C(K^{(2)}, \dots, K^{(j)})(f)$$

By Remark V II.2, in the algebra  $\tilde{A}$

$$g(\dots) = \mathcal{R}_C(\hat{K}^{(2)}, \dots, \hat{K}^{(j)})(\hat{f})$$

Therefore, by part (ii) of Proposition III.7 and Remark II.24

$$\frac{1}{(j-1)!} N(g) \leq \frac{1}{(j-1)!} N(\hat{f}) \prod_{i=2}^j N(\hat{K}^{(i)}) \\ \leq \frac{1}{(j-1)!} N(f; 2) \prod_{i=2}^j N(K^{(i)}; 2) \\ \leq \frac{1}{(j-1)!} N(f; 2) N(K; 2)^{j-1}$$

By Proposition V II.1

$$f^0(\dots) = \frac{1}{j!} \sum_{\dots} K^{\infty}(\dots); \dots, g(\dots); \dots, d_C(\dots) d_C(\dots)$$

Proposition V I.4 implies that

$$N_{\text{im pr}}(f^0; \dots) \leq \frac{2^j j}{j!} N(K^{\infty}; \dots) N(g; \dots) \\ \leq \frac{2^j j}{j+5} N(f; 2) N(K; 2)^{j-1}$$



Proposition VII.4 Let  $K(\cdot; \cdot)$  be an even Grassmann function. Decompose

$$K(\cdot; \cdot) = K^0(\cdot; \cdot) + K^{\infty}(\cdot; \cdot)$$

where  $K^0$  has degree at most two in the variables  $\cdot$  and  $K^{\infty}$  has degree at least three in the variables  $\cdot$ . Let  $f(\cdot) \in \mathbb{V}_{A^0} \mathbb{V}$ , and set

$$g(\cdot) := R_{K;C}(f) \quad g^0(\cdot) := R_{K^0;C}(f)$$

Then, if  $\epsilon > 2$  and  $N(K; 2)_0$

$$N_{\text{imp}}(g; g^0) \leq \frac{2^5 J}{\epsilon} N(f; 2) \frac{N(K; 2)}{1 - N(K; 2)}$$

Proof: By Remark III.6

$$g = \sum_{\nu=1}^{\mathbb{P}} g_{\nu}, \quad g^0 = \sum_{\nu=1}^{\mathbb{P}} g_{\nu}^0$$

where

$$g_{\nu} := \frac{1}{\nu!} R_C(K; \cdot; K)(f) \\ g_{\nu}^0 := \frac{1}{\nu!} R_C(K^0; \cdot; K^0)(f)$$

Since

$$\begin{aligned} R_C(K; \cdot; K) &\subset \mathbb{R}^0; \cdot; K \\ &= R_C(K; K^0; K; \cdot; K) \cup \mathbb{R}^0; K; K^0; K; \cdot; K + \mathbb{C}(\mathbb{R}^0; \cdot; K; K^0) \\ &= R_C(K^0; K; \cdot; K) \cup \mathbb{R}^0; K^0; K; \cdot; K + \mathbb{C}(\mathbb{R}^0; \cdot; \mathbb{R}^0) \end{aligned}$$

it follows from Lemma VII.3 that

$$N_{\text{imp}}(g_{\nu}; g_{\nu}^0) \leq \frac{2^5 J}{\nu+5} N(f; 2) N(K; 2)^{\nu}$$

Therefore

$$N_{\text{imp}}(g; g^0) \leq \sum_{\nu=1}^{\mathbb{P}} N_{\text{imp}}(g_{\nu}; g_{\nu}^0) \leq \frac{2^5 J}{\epsilon} N(f; 2) \frac{N(K; 2)}{1 - N(K; 2)}$$

■

Corollary VII.5 Under the hypotheses of Proposition VII.4, set

$$h := \frac{1}{1 - R_{K;C}}(f) - \frac{1}{1 - R_{K^0;C}}(f)$$

If  $N(K; 2)_0 < \frac{\epsilon}{6}$ , then

$$N_{\text{imp}}(h; \cdot) \leq \frac{2^5 J}{\epsilon} \frac{N(K; 2)}{1 - N(K; 2)} N(f; 2)$$

Proof: Since

$$h = \mathbb{1} R_{K;C}^{-1} R_{K;C} R_{K^0;C} \mathbb{1} R_{K^0;C}^{-1} (f)$$

it follows from Corollary III.9, with  $N_{\text{im pr}}$  in place of  $N$ , and Proposition VII.4 that

$$\begin{aligned} N_{\text{im pr}}(h) &= 1 + \frac{2}{2} \frac{N_{\text{im pr}}(K)}{1 - \frac{4}{2} N_{\text{im pr}}(K)} N_{\text{im pr}} R_{K;C} R_{K^0;C} \mathbb{1} R_{K^0;C}^{-1} (f) \\ &= 1 + \frac{2}{2} \frac{N_{\text{im pr}}(K)}{1 - \frac{4}{2} N_{\text{im pr}}(K)} \frac{2^5 J}{6} \frac{N(K;2)}{1 - \frac{1}{2} N(K;2)} N \mathbb{1} R_{K^0;C}^{-1} (f); 2 \end{aligned}$$

By Definition VI.1 and Remark II.24,  $N_{\text{im pr}}(K) = N(K) = N(K;2)$  so that Corollary III.9 implies

$$\begin{aligned} N_{\text{im pr}}(h) &= 1 + \frac{2}{2} \frac{N(K;2)}{1 - \frac{4}{2} N(K;2)} \frac{2^5 J}{6} \frac{N(K;2)}{1 - \frac{1}{2} N(K;2)} \left( 1 + \frac{1}{2} \frac{N(K^0;2)}{1 - \frac{1}{2} N(K^0;2)} N(f;2) \right) \\ &= \frac{2^5 J}{6} \frac{1 - \frac{2}{2} N(K;2)}{1 - \frac{4}{2} N(K;2)} \frac{N(K;2)}{1 - \frac{1}{2} N(K;2)} \frac{1 - \frac{1}{2} N(K;2)}{1 - \frac{1}{2} N(K;2)} N(f;2) \\ &= \frac{2^5 J}{6} \frac{1}{1 - \frac{4}{2} N(K;2)} \frac{N(K;2)}{1 - \frac{1}{2} N(K;2)} \frac{1}{1 - \frac{1}{2} N(K;2)} N(f;2) \\ &= \frac{2^5 J}{6} \frac{N(K;2)}{[1 - \frac{4}{2} N(K;2)]^3} N(f;2) \\ &= \frac{2^5 J}{6} \frac{N(K;2)}{1 - \frac{6}{2} N(K;2)} N(f;2) \end{aligned}$$

since, for  $X \in \mathbb{N}_d$ ,

$$\frac{1}{[1 - X]^3} = \sum_{r=0}^{\infty} \binom{3}{r} (-X)^r = \sum_{r=0}^{\infty} \frac{3 \cdot 4 \cdot 5 \cdots (3+r-1)}{r!} X^r = \sum_{r=0}^{\infty} \binom{3+r-1}{r} (-X)^r = \frac{1}{1 - 3X}$$

■

Proposition VII.4 exploits overlapping loops that are created by one application of the operator  $R_{K;C}$ . There are additional overlapping loops created by the composite operator  $R_{K;C} R_{K;C}$  which we shall exploit now.

Lemma VII.6 Let  $B(\cdot; \cdot) \in A^0[1;1]$  and let  $H(\cdot; \cdot); K(\cdot; \cdot)$  be even Grassmann functions that vanish for  $\cdot = 0$ . Assume that  $H$  or  $K$  has degree at least two in the variables  $\cdot$ . Let  $f(\cdot) \in A^0 V$  and set

$$\begin{aligned} g(\cdot) &= \sum_{i \in \mathbb{Z}} h_{ZZZ} B(\cdot; \cdot) H(\cdot + \cdot; \cdot); \cdot; \cdot K(\cdot + \cdot; \cdot); \cdot; \cdot d_C(\cdot; \cdot; \cdot) \cdot \\ &= f(\cdot); d_C(\cdot) \end{aligned}$$

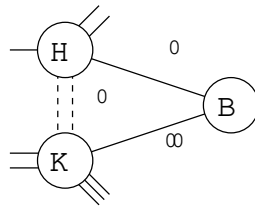

Then, if  $\geq 2$

$$N_{\text{im pr}}(g; \mathbb{Z}) = \frac{2^5 J}{10} N(f; 2) N(H; 2) N(K; 2) N(B; \mathbb{Z})$$

Proof: We may assume that  $K$  has degree at least two in the variables  $\mathbb{Z}$ . Set

$$h(\mathbb{Z}; \mathbb{Z}; \mathbb{Z}; \mathbb{Z}) = \sum_{\mathbb{Z}} B(\mathbb{Z}; \mathbb{Z}) \cdot H(\mathbb{Z}; \mathbb{Z}; \mathbb{Z}; \mathbb{Z}) \cdot f(\mathbb{Z}; \mathbb{Z}) \cdot d_c(\mathbb{Z}) d_c(\mathbb{Z})$$

By Lemma A.5, applied to the variable

$$g(\mathbb{Z}) = \sum_{\mathbb{Z}} B(\mathbb{Z}; \mathbb{Z}) \cdot H(\mathbb{Z}; \mathbb{Z}; \mathbb{Z}; \mathbb{Z}) \cdot K(\mathbb{Z}; \mathbb{Z}; \mathbb{Z}; \mathbb{Z}) \cdot f(\mathbb{Z}; \mathbb{Z}) \cdot d_c(\mathbb{Z}; \mathbb{Z}; \mathbb{Z}; \mathbb{Z})$$

$$= \sum_{\mathbb{Z}} h(\mathbb{Z}; \mathbb{Z}; \mathbb{Z}; \mathbb{Z}) \cdot K(\mathbb{Z}; \mathbb{Z}; \mathbb{Z}; \mathbb{Z}) \cdot d_c(\mathbb{Z}; \mathbb{Z}; \mathbb{Z})$$

Since  $B$  is of degree one in  $\mathbb{Z}$  and  $H$  is of degree at least one in  $\mathbb{Z}$ , iterated application of Proposition II.33 and Remark II.24 yields

$$N(h) = \frac{1}{4} N(B) N(H; 2) N(f; 2)$$

Since  $h$  is of degree one in  $\mathbb{Z}$ , only the part of  $K$  that is of degree at least three in the variables  $\mathbb{Z}; \mathbb{Z}$  can contribute. Hence Proposition V I.4 implies that

$$N_{\text{im pr}}(g) = \frac{27J}{6} N(h) N(K; 2)$$

$$= \frac{2^5 J}{10} N(B) N(H; 2) N(f; 2) N(K; 2)$$

■

Proposition V II.7 Let  $K(\mathbb{Z}; \mathbb{Z}; \mathbb{Z})$  be a Grassmann function of degree at most two in the variables  $\mathbb{Z}$  and of degree at least one in  $\mathbb{Z}$ . Write

$$K(\mathbb{Z}; \mathbb{Z}; \mathbb{Z}) = \sum_{n_1, n_2, n_3} X_{n_1, n_2, n_3} K_{n_1, n_2, n_3}(\mathbb{Z}; \mathbb{Z}; \mathbb{Z}) \quad \text{with} \quad K_{n_1, n_2, n_3} \in \mathbb{A}^0[n_1; n_2; n_3]$$

Also set  $K_{m_2, m_3} = \sum_{n_1}^P K_{n_1, m_2, m_3}$ . Furthermore let  $T \in A^0[\mathbb{Z}]$  and write

$$T(+^0) = T(\cdot) + T(\cdot^0) + T_{mix}(\cdot;^0)$$

with  $T_{mix} \in A^0[\mathbb{Z}; 1]$ . Set

$$K(\cdot;^0) = \sum_{\mathbb{Z}} T(\cdot^0) \circ K(+^0;^0) \circ d_C(\cdot^0)$$

$$\hat{K}(\cdot;^0) = \sum_{\mathbb{Z}} T_{mix}(\cdot^0;^\infty) \circ K_{;0;1}(+^0;^0) \circ K_{;0;1}(+^\infty;^0) \circ d_C(\cdot^0;^\infty)$$

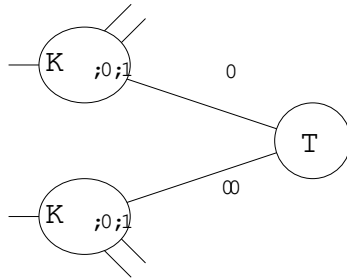
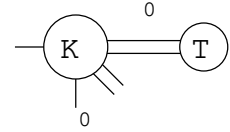

Observe that  $\hat{K}$  is independent of  $\cdot^0$ . Finally let  $f \in A^0 V$  and set

$$f^0(\cdot) = R_C(T) R_C(K;K)(\cdot f)$$

$$\cdot f(\cdot) = 2 R_C(K;K)(\cdot f)$$

$$\cdot \hat{f}(\cdot) = R_C(\hat{K})(\cdot f)$$

Then

$$N_{\text{in pr}}(f^0(\cdot f + \hat{f});) = \frac{2^6 J}{10} N(f;2) N(K;2)^2 N(T;2)$$

Proof: By definition

$$f^0(\cdot) = \sum_{\mathbb{Z}} T(\cdot^0) \circ R_C(K;K)(\cdot f) \circ (+^0) d_C(\cdot^0)$$

Consequently, by part (ii) of Proposition A.2 and Lemma A.7, in the variable  $\cdot^0$ ,

$$f^0(\cdot) = \sum_{\mathbb{Z}} T(\cdot^0) \circ R_C(K;K)(\cdot f) \circ (+^0) d_C(\cdot^0)$$

$$= \sum_{\mathbb{Z}} T(\cdot^0) \circ \sum_{\mathbb{Z}} K(+^0;^0) \circ K(+^0;^0) \circ \sum_{\mathbb{Z}} \cdot f(\cdot) \circ d_C(\cdot^0;^0)$$

$$= 2 \sum_{\mathbb{Z}} \sum_{\mathbb{Z}} T(\cdot^0) \circ K(+^0;^0) \circ d_C(\cdot^0) \circ \sum_{\mathbb{Z}} K(\cdot;^0) \circ \sum_{\mathbb{Z}} \cdot f(\cdot) \circ d_C(\cdot^0;^0)$$

$$+ \sum_{\mathbb{Z}} \sum_{\mathbb{Z}} T_{mix}(\cdot^0;^\infty) \circ K(+^0;^0) \circ K(+^\infty;^0) \circ d_C(\cdot^0;^\infty) \circ \sum_{\mathbb{Z}} \cdot f(\cdot) \circ d_C(\cdot)$$

$$\begin{aligned}
& \int \mathbb{K}(\cdot; \cdot^0) : \circ \mathbb{K}(\cdot; \cdot^0) : \circ \int \mathbb{f}(\cdot) : d_C(\cdot^0) \\
& + \int \mathbb{K}^\wedge(\cdot; \cdot^0) : \circ \int \mathbb{f}(\cdot) : d_C(\cdot^0) \\
& + \int_{\mathbb{H}^Z} \mathbb{T}_{\text{mix}}(\cdot^0; \cdot^\infty) \mathbb{K}(\cdot + \cdot^0; \cdot^0) : \circ \circ \mathbb{K}(\cdot + \cdot^\infty; \cdot^0) : \circ \circ \int \mathbb{K}_{;0;1}(\cdot + \cdot^0; \cdot^0) : \circ \circ \mathbb{K}_{;0;1}(\cdot + \cdot^\infty; \cdot^0) : \circ \circ d_C(\cdot^0; \cdot^0; \cdot^\infty) : \\
& \qquad \qquad \qquad \int \mathbb{f}(\cdot) : d_C(\cdot) \\
& = \mathbb{f}(\cdot) + \hat{\mathbb{f}}(\cdot) + \mathbb{g}^0(\cdot) + \mathbb{g}^\infty(\cdot)
\end{aligned}$$

with

$$\begin{aligned}
\mathbb{g}^0(\cdot) &= \int_{\mathbb{H}^Z} \mathbb{T}_{\text{mix}}(\cdot^0; \cdot^\infty) \mathbb{H}(\cdot + \cdot^0; \cdot^0) : \circ \circ \mathbb{K}(\cdot + \cdot^\infty; \cdot^0) : \circ \circ d_C(\cdot^0; \cdot^0; \cdot^\infty) : \\
& \qquad \qquad \qquad \int \mathbb{f}(\cdot) : d_C(\cdot) \\
\mathbb{g}^\infty(\cdot) &= \int_{\mathbb{H}^Z} \mathbb{T}_{\text{mix}}(\cdot^0; \cdot^\infty) \mathbb{K}_{;0;1}(\cdot + \cdot^0; \cdot^0) : \circ \circ \mathbb{H}(\cdot + \cdot^\infty; \cdot^0) : \circ \circ d_C(\cdot^0; \cdot^0; \cdot^\infty) : \\
& \qquad \qquad \qquad \int \mathbb{f}(\cdot) : d_C(\cdot)
\end{aligned}$$

where  $\mathbb{H} = \mathbb{K} \mathbb{K}_{;0;1}$ . In the last equality, we used the fact that  $\mathbb{K}_{;0;1}(\cdot + \cdot^0; \cdot^0)$  and hence  $\mathbb{K}^\wedge$  is independent of  $\cdot^0$ , so that we are free to drop the Wick ordering with respect to  $\cdot^0$  in the expression yielding  $\hat{\mathbb{f}}(\cdot)$ . By Lemma VII.6 and the observations that

$$\begin{aligned}
& N(\mathbb{K}_{;0;1}; 2) ; N(\mathbb{K} \mathbb{K}_{;0;1}; 2) = N(\mathbb{K}; 2) \\
& N(\mathbb{T}_{\text{mix}}; \cdot) = N(\mathbb{T}(\cdot + \cdot^0); \cdot) = N(\mathbb{T}; 2)
\end{aligned}$$

we have

$$N_{\text{im pr}}(\mathbb{f}^0 \mathbb{f} \hat{\mathbb{f}}) = N_{\text{im pr}}(\mathbb{g}^0 + \mathbb{g}^\infty) = \frac{2^6 J}{10} N(\mathbb{f}; 2) N(\mathbb{K}; 2)^2 N(\mathbb{T}; 2)$$



### VII.2 Tails

In this subsection let  $\mathbb{K}(\cdot; \cdot; \cdot^0)$  be an even Grassmann function with coefficients in  $A$  that has degree at least four in the variables  $\cdot; \cdot; \cdot^0$  and degree at least one in the variable  $\cdot$ . We always write

$$\mathbb{K} = \sum_{n_0; \dots; n_3} \mathbb{K}_{n_0; n_1; n_2; n_3} \quad \text{with} \quad \mathbb{K}_{n_0; n_1; n_2; n_3} \in A[n_0; n_1; n_2; n_3]$$

For  $\mathbb{f}(\cdot; \cdot) \in \mathbb{V}_A(\mathbb{V}^0 \mathbb{V})$  we are interested in the two and four legged contributions to  $\frac{1}{11 R_{K;C}}(\mathbb{f}; \cdot)$ . Therefore we make the following



Definition V II.8 The projection

$$P : \hat{A}(V^0 \vee V) \rightarrow \hat{A}V^0$$

$$:f(\cdot; \cdot) := 7! f_{4;0}(\cdot; 0) + f_{2;0}(\cdot; 0)$$

where  $f(\cdot; \cdot) = \sum_{n_0, m_1}^P f_{n_0, m_1}(\cdot; \cdot)$  with  $f_{n_0, m_1} \in A[n_0; n_1]$ .

Definition V II.9

(i) An  $n$ -legged tail is a Grassmann function  $T(\cdot; \cdot) \in \mathcal{L}_d A[d; n]$ . We say that an  $n$ -legged tail  $T$  has at least  $d$  external legs if  $T \in \mathcal{L}_{d^0} A[d^0; n]$ .

(ii) If  $T$  is a two-legged tail we define the two-legged tail  $T \circ K$  by

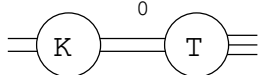
$$(T \circ K)(\cdot; \cdot) = \sum T(\cdot; \cdot^0) \circ K_{0;2;0;2}(\cdot; \cdot^0; \cdot^0) \circ d_c(\cdot^0)$$

Observe that  $T \circ K$  depends only on the part of  $K$  that has degree at most two in the variables  $\cdot^0$ .

Remark V II.10 A two-legged tail with two external legs is an end in the sense of Definition VI.5.i. If  $K(\cdot; \cdot; \cdot^0) = U(\cdot; \cdot^0 + \cdot) \circ U(\cdot; \cdot^0)$  for some even Grassmann function  $U(\cdot; \cdot)$  then  $T \circ K$  agrees with  $T \circ \text{Rung}(U)$  of Definition VI.5.iii.

Lemma V II.11 Assume that  $K$  has degree at most two in the variables  $\cdot^0$ . Let  $T$  be a two-legged tail. Then there exists a one-legged tail  $t_1$  with at least three external legs and a two-legged tail  $t_2$  with at least three external legs such that for any  $f(\cdot; \cdot) \in \hat{A}(V^0 \vee V)$  the following holds:

Set

$$f^0(\cdot) = \sum_{h,i} P R_C(T) R_{K;C}(\cdot; f) \circ R_C(T \circ K)(\cdot; f) \circ R_C(T \circ K; K_{2;0;0;2})(\cdot; f) \circ R_C(t_1 + t_2)(\cdot; f)$$

where  $\cdot; f$  is shorthand for  $\cdot; f$ . Then

$$N_{\text{impr}}(f^0; \cdot) = \frac{2^6 J}{10} N(f; 2) N(K; 2)^2 N(T; 2)$$

If  $T$  has at least three external legs then

$$P R_C(T) R_{K;C}(\cdot; f) = P R_C(T \circ K)(\cdot; f) + P R_C(t_1 + t_2)(\cdot; f)$$

Proof: By assumption,  $K(\cdot; \cdot; \cdot)$  is of degree at least two in  $\cdot$ , so  $R_C(K; \cdot; K)(\cdot; \cdot)$  (with  $\cdot$   $K$ 's) is of degree at least  $2$  in  $\cdot$ . Since  $T$  is two-legged,  $R_C(T)R_C(K; \cdot; K)(\cdot; \cdot)$  is of degree at least  $2 + 2 = 4$  (with the last  $+2$  coming from the  $d = 2$  external legs of  $T$ ) in  $\cdot$  and is independent of  $\cdot$ . So, by Remark III.6

$$P_{R_C(T)R_{K;C}}(\cdot; \cdot) = P_{R_C(T)R_C(K)}(\cdot; \cdot) + \frac{1}{2}P_{R_C(T)R_C(K;K)}(\cdot; \cdot)$$

Set

$$t_{11}(\cdot; \cdot) = \int_Z \mathbb{T}(\cdot; \cdot) : \circ K_{;2;0;1}(\cdot; \cdot; \cdot) : \circ d_C(\cdot)$$

$$t_{21}(\cdot; \cdot) = \int_Z \mathbb{T}(\cdot; \cdot) : \circ K_{;2;0;2}(\cdot; \cdot; \cdot) : \circ K_{0;2;0;2}(\cdot; \cdot; \cdot) : \circ d_C(\cdot)$$

Since  $K$  has degree at least four overall and  $T$  has degree at least two in  $\cdot$ ,  $t_{11}$  is a one-legged tail and  $t_{21}$  is a two-legged tail, both having at least three external legs. As  $K$  has degree at most two in the variables  $\cdot$  and degree at least one in  $\cdot$  and  $T$  has degree two in  $\cdot$  and the definition of  $R_C(K)$  Wick orders  $K$  with respect to  $\cdot$ ,

$$P_{R_C(T)R_C(K)}(\cdot; \cdot) = P_{R_C(T)R_C(K_{;2;0;1})}(\cdot; \cdot) + P_{R_C(T)R_C(K_{;2;0;2})}(\cdot; \cdot)$$

$$= P_{R_C(t_{11} + t_{21})}(\cdot; \cdot) + P_{R_C(T;K)}(\cdot; \cdot)$$

Define the projection

$$P^0 : \hat{V}_A^0 \rightarrow \hat{V}_A^0$$

$$f(\cdot; \cdot) \mapsto f_{4;0}(\cdot; 0) + f_{2;0}(\cdot; 0)$$

As  $P$  and  $P^0$  only differ by Wick ordering in the  $\cdot$  argument,

$$P_{R_C(T)R_C(K;K)}(\cdot; \cdot) = P^0_{R_C(T)R_C(K;K)}(\cdot; \cdot)$$

$$= P^0_{R_C(T)R_C(K;K)}(\cdot; \cdot)(\cdot; 0; 0; \cdot)$$

so that we can apply Proposition VII.7. Modulo a term whose improved norm  $N_{\text{impr}}$  is bounded by  $\frac{2^6 J}{10} N(f; 2) N(K; 2)^2 N(T; 2)$

$$P^0_{R_C(T)R_C(K;K)}(\cdot; \cdot)(\cdot; 0; 0; \cdot) = 2P_{R_C(K;K)}(\cdot; \cdot) + P_{R_C(\hat{K})}(\cdot; \cdot)$$

with

$$K(\cdot; \cdot; \cdot) = \int_Z \mathbb{T}(\cdot; \cdot) : \circ K(\cdot; \cdot; \cdot) : \circ d_C(\cdot)$$

$$\hat{K}(\cdot; \cdot; \cdot) = \int_Z \text{Mix}(\cdot; \cdot; \cdot) : \circ K_{;1;0;1}(\cdot; \cdot; \cdot) : \circ K_{;1;0;1}(\cdot; \cdot; \cdot) : \circ d_C(\cdot)$$

Here we have used the projection  $P$  to set  $\epsilon = 0$  and we used that  $T_{mix}(\epsilon; \epsilon; \epsilon)$  is of degree one in  $\epsilon$  and in  $\epsilon$ . Again, since  $K$  has degree at least four overall and  $T$  is of degree at least two in  $\epsilon$ , the tail  $\hat{K}$  has at least six external legs, so that  $P R_C(\hat{K})(\epsilon) = 0$ . Finally, since

$P$  sets the  $\epsilon$ 's in the argument  $K$  of  $P R_C(K; K)(\epsilon)$  to zero.

$K$  is of degree at least two in

$K_{;0;0;1}$  is of degree at least three in

$K$  is of degree at most two in  $\epsilon$ ; and degree at least one in  $\epsilon$ .

we have

$$\begin{aligned} P R_C(K; K)(\epsilon) &= P R_C(K_{;0;0;1}; K_{;0;0;1})(\epsilon) + P R_C(K_{;0;0;1}; K_{;0;0;1})(\epsilon) \\ &= P R_C(K_{;0;0;1}; K_{;0;0;1})(\epsilon) + P R_C(K_{;0;0;1}; K_{;0;0;1})(\epsilon) \end{aligned}$$

and since

$K$  is of degree at least four overall and  $K$  is of degree at least two in

we have

$$\begin{aligned} P R_C(K; K)(\epsilon) &= P R_C(K_{2;0;0;0}; K_{2;0;0;2})(\epsilon) + P R_C(K_{2;0;0;1}; K_{2;0;0;1})(\epsilon) \\ &= P R_C(K_{2;0;0;2}; K_{2;0;0;2})(\epsilon) + P R_C(K_{2;0;0;1}; K_{2;0;0;1})(\epsilon) \\ &= P R_C(T_{2;0;0;0}; K_{2;0;0;2})(\epsilon) + P R_C(t_{22})(\epsilon) \end{aligned}$$

where

$$t_{22}(\epsilon) = K_{2;0;0;1}(\epsilon; \epsilon; \epsilon) K_{2;0;0;1}(\epsilon; \epsilon; \epsilon) d_c(\epsilon)$$

is a two-legged tail with at least four external legs.

Setting  $t_1 = t_{11}$  and  $t_2 = t_{21} + 2t_{22}$  yields the main result. If  $T$  has at least three external legs, then  $R_C(T)R_C(K; K)(\epsilon)$  (with  $K$ 's) is of degree at least  $2 + 2 + 3 = 2 + 1$ , so

$$P R_C(T)R_{K;C}(\epsilon) = P R_C(T)R_C(K)(\epsilon) = P R_C(t_{11} + t_{21})(\epsilon) + P R_C(T; K)(\epsilon)$$

■

**Lemma VII.12** Assume that  $K$  has degree at most two in the variables  $\epsilon$ . Let  $T_1; T_2$  be two-legged tails. Then there exists a one-legged tail  $t_1$  and a two-legged tail  $t_2$ , each with at least four external legs, such that for any  $f(\epsilon) \in \mathcal{V}_A(\mathbb{V}^0; \mathbb{V})$  the following holds:

Set

$$f^0(\epsilon) = P R_C(T_1; T_2)R_{K;C}(\epsilon) R_C(T_1; K; T_2; K)(\epsilon) R_C(t_1 + t_2)(\epsilon)$$

Then, if  $\epsilon \in \mathbb{V}$

$$N_{\text{impr}}(f^0; \epsilon) \leq \frac{2^6 J}{12} N(f; 2) N(K; 2)^2 N(T_1; 2) N(T_2; 2)$$

Proof: Again, since  $K$  has degree at most two in the variables  $z_i$  and degree at least four in all variables

$$P R_C(T_1; T_2) R_{K; C}(\mathbf{f}; \mathbf{z}) = P R_C(T_1; T_2) R_C(K)(\mathbf{f}; \mathbf{z}) + \frac{1}{2} P R_C(T_1; T_2) R_C(K; K)(\mathbf{f}; \mathbf{z})$$

and

$$\begin{aligned} P R_C(T_1; T_2) R_C(K)(\mathbf{f}; \mathbf{z}) &= P R_C(T_1; T_2) R_C(K_{0;4;0;0})(\mathbf{f}; \mathbf{z}) \\ &= P R_C(t_{11} + t_{21})(\mathbf{f}; \mathbf{z}) \end{aligned}$$

where

$$\begin{aligned} t_{11}(\mathbf{z}) &= \int_Z T_1(\mathbf{z}; z^0) T_2(\mathbf{z}; z^0) \circ K_{0;4;0;1}(\mathbf{z}; z^0; z^0) d_C(z^0) \\ t_{21}(\mathbf{z}) &= \int_Z T_1(\mathbf{z}; z^0) T_2(\mathbf{z}; z^0) \circ K_{0;4;0;2}(\mathbf{z}; z^0; z^0) d_C(z^0) \end{aligned}$$

are one (resp. two) legged tails with at least four external legs.

Similarly

$$\begin{aligned} P R_C(T_1; T_2) R_C(K; K)(\mathbf{f}; \mathbf{z}) \\ = P R_C(T_1; T_2) R_C(K_{0;2;0;2}; K_{0;2;0;2})(\mathbf{f}; \mathbf{z}) + P R_C(T_1; T_2) R_C(K_{0;2;1;1}; K_{0;2;1;1})(\mathbf{f}; \mathbf{z}) \end{aligned}$$

The second term is  $P R_C(t_{22})(\mathbf{f}; \mathbf{z})$  where

$$t_{22}(\mathbf{z}) = \int_Z T_1(\mathbf{z}; z^0) T_2(\mathbf{z}; z^0) \circ K_{0;2;1;1}(\mathbf{z}; z^0; z^0) \circ K_{0;2;1;1}(\mathbf{z}; z^0; z^0) \circ d_C(z^0)$$

is a two legged tail with at least four external legs. To deal with the first term we use Proposition VII.1 to see that

$$R_C(T_1; T_2) R_C(K_{0;2;0;2}; K_{0;2;0;2})(\mathbf{f}; \mathbf{z}) = \int_Z T_1(\mathbf{z}; z^0) \circ \mathfrak{g}(\mathbf{z}; z^0) \circ d_C(z^0)$$

where

$$\mathfrak{g}(\mathbf{z}; \mathbf{z}) = R_C(T_2) R_C(K_{0;2;0;2}; K_{0;2;0;2})(\mathbf{f}; \mathbf{z})$$

By Proposition VII.7,  $\mathfrak{g}(\mathbf{z}; \mathbf{z})$  is { modulo terms whose improved norm can be bounded by  $\frac{2^6 J}{10} N(\mathbf{f}; 2) N(\mathbf{K}; 2)^2 N(T_2; 2)$  } equal to  $2 R_C(K_{0;2;0;2}; T_2 - K)(\mathbf{f}; \mathbf{z})$ . Therefore by Proposition II.33, modulo terms whose improved norm can be bounded by  $\frac{2^6 J}{12} N(\mathbf{f}; 2) N(\mathbf{K}; 2)^2 N_{\text{im pr}}(T_1; \mathbf{z}) N(T_2; 2)$

$$\begin{aligned} \frac{1}{2} P R_C(T_1; T_2) R_C(K_{0;2;0;2}; K_{0;2;0;2})(\mathbf{f}; \mathbf{z}) \\ = P \int_Z T_1(\mathbf{z}; z^0) \circ R_C(K_{0;2;0;2}; T_2 - K)(\mathbf{f}; \mathbf{z})(z^0) d_C(z^0) \\ = P R_C(T_1 - K; T_2 - K)(\mathbf{f}; \mathbf{z}) \end{aligned}$$

Since  $N_{\text{im pr}}(T_1; \mathbf{z}) = N(T_1; \mathbf{z}) - N(T_1; 2)$ , the Lemma follows. ■

Lemma VII.13 Assume that  $K$  has degree at most two in the variables  $0; \dots$ . Let  $T$  be a one-legged tail with at least three external legs. Then there is a two-legged tail  $t_2$  with at least four external legs such that for all  $f(\dots) \in \mathcal{A}(V^0, V)$

$$P R_C(T) R_{K;C}(\mathbb{f}) = P R_C(t_2)(\mathbb{f})$$

Proof: Since  $T$  is one-legged and  $K$  has degree at least four

$$\begin{aligned} P R_C(T) R_{K;C} &= P R_C(T) R_C(K) \\ &= P R_C(T) R_C \left( \sum_{d=2}^P K_{d;1;0;1} + \sum_{d=1}^P K_{d;1;0;2} \right) \\ &= P R_C(T) R_C(K_{1;1;0;2}) = P R_C(t_2) \end{aligned}$$

with

$$t_2(\dots) = T(\dots; 0) K_{1;1;0;2}(\dots; 0; 0; 0) d_C(0)$$

■

Definition VII.14 The two-legged tails  $T_\backslash(K)$  are recursively defined by

$$\begin{aligned} T_1(K)(\dots) &= K_{2;0;0;2}(\dots; 0; 0; 0) \\ T_{\backslash+1}(K) &= T_\backslash(K) \quad \text{for } \backslash \geq 1 \end{aligned}$$

Remark VII.15

(i) Clearly  $T_\backslash(K)$  has two external legs. Using Proposition II.33 one proves by induction that for  $\backslash \geq 2$

$$N(T_\backslash(K)) = \frac{1}{2^{\backslash-2}} N(K)$$

(ii) If  $K(\dots; 0; 0; 0) = U(\dots; 0; \dots) U(\dots; 0)$  for some even Grassmann function  $U(\dots)$  then, by Remark VII.10,  $T_\backslash(K) = T_\backslash(U)$ , where  $T_\backslash(U)$  was defined in Definition VI.8.ii.

(iii)  $T_\backslash(K)$  depends only on the part of  $K$  that has degree at most two in the variables  $0; \dots$ .

Proposition VII.16 Assume that  $K$  has degree at most two in the variables  $0; \dots$ . For each  $\backslash \geq 1$  there exists a one-legged tail  $t_1$  and a two-legged tail  $t_2$ , each with at least three external legs such that for any  $f(\dots) \in \mathcal{A}(V^0, V)$  the following holds: Set

$$f^0(\dots) = P R_{K;C}(\mathbb{f}) R_C(T_\backslash(K))(\mathbb{f}) = \frac{1}{2} \sum_{\substack{0 \leq g \leq \backslash \\ \max\{0, \backslash-g\}}} P R_C(T_\backslash(K); T_\backslash(K))(\mathbb{f}) R_C(t_1 + t_2)(\mathbb{f})$$

Then, if  $\backslash \geq 2$  and  $N(K; 2)_0 < 2$

$$N_{\text{imp}}(f^0; \dots) \leq \frac{2^{\backslash-6}}{2^{\backslash-6}} N(f; 2) \frac{N(K; 2)^{\backslash+1}}{1 - \frac{1}{2} N(K; 2)}$$

Proof by induction on  $\ell$ : Set  $N_K = N(K; 2)$ . Since  $K$  has degree at most two in the variables  $z_i$  and degree at least four overall, for  $\ell = 1$

$$\begin{aligned} P_{R_{K;C}} &= P_{R_C}(K_{3;0;0;2} + K_{3;0;0;1}) + \frac{1}{2} P_{R_C}(K_{2;0;1;1}; K_{2;0;1;1}) + \frac{1}{2} P_{R_C}(K_{2;0;0;2}; K_{2;0;0;2}) \\ &= P_{R_C}(T_1(K)) + P_{R_C}(t_1 + t_2) + \frac{1}{2} P_{R_C}(T_1(K); T_1(K)) \end{aligned}$$

with

$$\begin{aligned} t_1 &= K_{3;0;0;1} + K_{4;0;0;1} \\ t_2 &= K_{3;0;0;2} + K_{4;0;0;2} + \frac{1}{2} \int_{\mathbb{Z}} K_{2;0;1;1}(z; z; 0) K_{2;0;1;1}(z; z; 0) d_C(z) \end{aligned}$$

Now assume that the statement of the Lemma is true for  $\ell$ . By the induction hypothesis there exist a one-legged tail  $t_1$  and a two-legged tail  $t_2$ , each with at least three external legs, such that

$$P_{R_{K;C}}^{\ell+1}(\mathfrak{f};) = P_{R_{K;C}}^{\ell} R_{K;C}(\mathfrak{f};)$$

differs from

$$\begin{aligned} &P_{R_C}(T_{\ell}(K)) R_{K;C}(\mathfrak{f};) + \frac{1}{2} \int_{\max\{f_0, f_{00}\}}^{\infty} P_{R_C}(T_{\ell}(K); T_{\ell}(K)) R_{K;C}(\mathfrak{f};) \\ &+ R_C(t_1 + t_2) R_{K;C}(\mathfrak{f};) \end{aligned} \quad \text{i}$$

by a function  $g_0(z)$  with

$$\begin{aligned} N_{\text{impr}}(g_0) &= \frac{2^7}{2^{\ell+6}} \int \frac{N_K^{\ell+1}}{1 - \frac{1}{2} N_K} N_{\mathfrak{f};2} \\ &= \frac{2^7}{2^{\ell+6}} \int \frac{N_K^{\ell+1}}{1 - \frac{1}{2} N_K} \frac{1}{2} \frac{1}{2} \frac{N_K}{1 - \frac{1}{2} N_K} N_{\mathfrak{f};2} \\ &= \frac{2^6}{2^{\ell+8}} \int \frac{N_K^{\ell+2}}{1 - \frac{1}{2} N_K} N_{\mathfrak{f};2} \end{aligned}$$

where  $\mathfrak{f}; = R_{K;C}(\mathfrak{f};)$ . Here, we used Lemma III.8, with  $\ell$  replaced by  $\ell$ , to estimate  $N_{\mathfrak{f};2}$ .

By Lemma VII.11, there exists a one-legged tail  $t_{11}$  and a two-legged tail  $t_{21}$ , with at least three external legs each, such that

$$\begin{aligned} &P_{R_C}(T_{\ell}(K)) R_{K;C}(\mathfrak{f};) = P_{R_C}(T_{\ell+1}(K))(\mathfrak{f};) + P_{R_C}(T_{\ell+1}(K); T_1(K))(\mathfrak{f};) \\ &+ P_{R_C}(t_{11} + t_{21})(\mathfrak{f};) + g_1(z) \\ &= P_{R_C}(T_{\ell+1}(K))(\mathfrak{f};) + \frac{1}{2} P_{R_C}(T_{\ell+1}(K); T_1(K))(\mathfrak{f};) \\ &+ \frac{1}{2} P_{R_C}(T_1(K); T_{\ell+1}(K))(\mathfrak{f};) + P_{R_C}(t_{11} + t_{21})(\mathfrak{f};) + g_1(z) \end{aligned}$$

with

$$N_{\text{in pr}}(g_1) = \frac{2^6 J}{10} N(f; 2) N_K^2 N(T \setminus (K); 2) \\ - \frac{2^6 J}{2^{v+8}} N(f; 2) N_K^{v+2}$$

Here, we used Remark VII.15 to bound  $N(T \setminus (K); 2)$  by  $\frac{1}{2^{v+2}} N_K^v$ .

Similarly, for  $v_0, v_{00} \geq 1$  with  $\max\{v_0, v_{00}\} = v$ , by Lemma VII.12, there exists a one-legged tail  $t_{12}^{(v_0, v_{00})}$  and a two-legged tail  $t_{22}^{(v_0, v_{00})}$  with at least three external legs such that

$$P_{R_C}(T^{v_0}(K); T^{v_{00}}(K))_{R_{K;C}}(\mathfrak{f}; \cdot) = P_{R_C}(T^{v_0+1}(K); T^{v_{00}+1}(K))(\mathfrak{f}; \cdot) \\ + P_{R_C}(t_{12}^{(v_0, v_{00})} + t_{22}^{(v_0, v_{00})})(\mathfrak{f}; \cdot) + g_{2; v_0, v_{00}}(\cdot)$$

with

$$N_{\text{in pr}}(g_{2; v_0, v_{00}}) = \frac{2^6 J}{12} N(f; 2) N_K^2 N(T^{v_0}(K); 2) N(T^{v_{00}}(K); 2) \\ J \frac{2^6}{2^{(v_0+v_{00})+8}} N(f; 2) N_K^{v_0+v_{00}+2}$$

By Lemma VII.13, there exists a two-legged tail  $t_{23}$  with at least four external legs such that

$$P_{R_C}(t_1)_{R_{K;C}}(\mathfrak{f}; \cdot) = P_{R_C}(t_{23})(\mathfrak{f}; \cdot)$$

Finally, by Lemma VII.11

$$P_{R_C}(t_2)_{R_{K;C}}(\mathfrak{f}; \cdot) = P_{R_C}(t_2 \setminus K + t_{24} + t_{24})(\mathfrak{f}; \cdot)$$

where  $t_{14}; t_{24}$  are one- resp. two-legged tails with at least three external legs.

Combining the results above, we see that

$$P_{R_{K;C}}^{v+1}(\mathfrak{f}; \cdot) = f_{v+1}^0(\cdot) \\ + P_{R_C}(T^{v+1}(K))(\mathfrak{f}; \cdot) + \frac{1}{2} P_{\max\{v_0, v_{00}\}=v+1}^{v_0, v_{00}} R_C(T^{v_0}(K); T^{v_{00}}(K))(\mathfrak{f}; \cdot) + R_C(t_1^0 + t_2^0)(\mathfrak{f}; \cdot)$$

with one- resp. two-legged tails  $t_1^0; t_2^0$  with at least three external legs, and

$$f_{v+1}^0 = g_0 + g_1 + \frac{1}{2} P_{\max\{v_0, v_{00}\}=v}^{v_0, v_{00}} g_{2; v_0, v_{00}}$$

By the triangle inequality

$$N_{\text{in pr}}(f_{v+1}^0) \leq N_{\text{in pr}}(g_0) + N_{\text{in pr}}(g_1) + \frac{1}{2} P_{\max\{v_0, v_{00}\}=v}^{v_0, v_{00}} N_{\text{in pr}}(g_{2; v_0, v_{00}}) \\ - \frac{2^6}{2^{v+8}} J N(f; 2) N_K^{v+2} \frac{1}{1 - \frac{1}{2} N_K} + 1 + P_{v=1}^{v_0} \frac{N_K^{v_0}}{2^{v_0}} \\ - \frac{2^6}{2^{v+8}} J N(f; 2) N_K^{v+2} \frac{1}{1 - \frac{1}{2} N_K} + P_{v=0}^{v_0} \frac{N_K^{v_0}}{2^{v_0}} \\ - \frac{2^7}{2^{v+8}} J N(f; 2) \frac{N_K^{v+2}}{1 - \frac{1}{2} N_K}$$



Corollary V II.17 Let  $K(\cdot; \cdot; \cdot^0; \cdot)$  be an even Grassmann function that has degree at most two in the variables  $\cdot^0; \cdot$ , degree at least one in  $\cdot$  and degree at least four in the variables  $\cdot; \cdot^0$ . Furthermore let  $f(\cdot; \cdot)$  be a Grassmann function of degree at least four in the variables  $\cdot; \cdot$ . Set

$$h(\cdot) = \mathbb{P} \frac{1}{\mathbb{1}_{R_{K;C}}} (\cdot; \cdot) \mathbb{P}_{\cdot=0} R_{C, T, (K)} (\cdot; \cdot) \frac{1}{2} \mathbb{P}_{\cdot^0; \cdot^0} R_{C, T, (K); T, \infty (K)} (\cdot; \cdot)^i$$

If  $\cdot \geq 2$  and  $N(K; 2)_0 < \frac{2}{2}$ , then

$$N_{\text{im pr}}(h) = \frac{2^7 J}{8} N(f; 2) \frac{N(K; 2)^2}{1 - \frac{2}{2} N(K; 2)}$$

Proof: By Proposition V II.16,

$$\begin{aligned} N_{\text{im pr}}(h) &= \mathbb{P}_{\cdot=1} N_{\text{im pr}}(f^0) \\ &= \frac{2^7 J}{8} N(f; 2) N(K; 2)^2 \mathbb{P}_{\cdot=1} \frac{1}{2} \frac{N(K; 2)}{1 - \frac{2}{2} N(K; 2)} \quad i, 1 \\ &= \frac{2^7 J}{8} N(f; 2) N(K; 2)^2 \mathbb{P}_{\cdot=1} \frac{1}{2} \frac{N(K; 2)}{1 - \frac{2}{2} N(K; 2)} \quad i, 1 \\ &= \frac{2^7 J}{8} N(f; 2) N(K; 2)^2 \frac{1 - \frac{2}{2} N(K; 2)}{1 - \frac{2}{2} N(K; 2)} \\ &= \frac{2^7 J}{8} N(f; 2) \frac{N(K; 2)^2}{1 - \frac{2}{2} N(K; 2)} \end{aligned}$$

■

Proof of Theorem V I.10 in the case  $D = 0$

Set  $K(\cdot; \cdot; \cdot^0; \cdot) = \hat{U}(\cdot; \cdot + \cdot^0; \cdot) \hat{U}(\cdot; \cdot + \cdot^0)$ . By Theorem III.2 and Proposition III.5

$$\mathbb{P} f^0 = \mathbb{P}_{S_{U;C}} (\cdot; \hat{f}) = \mathbb{P} \frac{1}{\mathbb{1}_{R_{K;C}}} (\cdot; \hat{f})^i$$

Observe that  $K$  has degree at least one in  $\cdot$  and four overall and that, by part i of Remark II.24 (twice)

$$N(K; 2)_0 = N(\hat{U}(\cdot; \cdot + \cdot^0; \cdot); 2)_0 = N(\hat{U}(\cdot; \cdot); 8)_0 < \frac{7}{8}$$

Decompose

$$K(\cdot; \cdot; \cdot^0; \cdot) = K^0(\cdot; \cdot; \cdot^0; \cdot) + K^{\infty}(\cdot; \cdot; \cdot^0; \cdot)$$



where  $K^0$  has degree at most two in the variables  $0; \quad$  and  $K^{00}$  has degree at least three in the variables  $0; \quad$ . By Corollary V II.5 and Corollary V II.17 there exists a Grassmann function  $g(\quad)$  with

$$\begin{aligned} N_{\text{im pr}}(g) &= \frac{2^5 J}{6} N(\hat{f}; 2) N(K; 2) \frac{h}{1 - \frac{6}{N}(K; 2)} + \frac{\frac{4}{2} N(K; 2)}{1 - \frac{2}{2} N(K; 2)} \frac{i}{1 - \frac{2}{2} N(K; 2)} \\ &= \frac{2^5 J}{6} N(\hat{f}; 2) N(K; 2) \frac{1 + \frac{2}{N}(K; 2)}{1 - \frac{6}{N}(K; 2)} \\ &= \frac{2^5 J}{6} N(\hat{f}; 2) N(K; 2) \frac{1}{1 - \frac{6}{N}(K; 2)} \frac{1}{1 - \frac{2}{N}(K; 2)} \\ &= \frac{2^5 J}{6} N(\hat{f}; 2) N(K; 2) \frac{1}{1 - \frac{8}{N}(K; 2)} \\ &= \frac{2^5 J}{6} N(\hat{f}; 2) \frac{N(\hat{U}; 8)}{1 - \frac{2}{N}(\hat{U}; 8)} \end{aligned}$$

and

$$P f^0 = P \hat{f}(\quad; 0) + \sum_{i=1}^h R_{C, T, (K)}(\hat{f}; \cdot) + \frac{1}{2} \sum_{i=0}^P R_{C, T, (K); T_0(K)}(\hat{f}; \cdot) + g$$

We have used that  $P \hat{f}(\quad; \cdot) := P \hat{f}(\quad; 0)$  and  $T, (K^0) = T, (K)$ . Since  $\hat{f}$  and  $K$  have degree at least four overall,

$$P R_{C, T, (K)}(\hat{f}; \cdot) = T, (K) \quad \mathbb{T}_1(\hat{f})$$

(where the composition was defined in Definition V I.5.ii) and by Remark V I.9

$$P R_{C, T, (K); T_0(K)}(\hat{f}; \cdot) = T, (K) \quad \text{Rung}(\hat{f}) \quad T_0(K)$$

Furthermore, by part (ii) of Remark V II.15,  $T, (K) = T, (\hat{U})$ . Thus

$$P f^0 = P \hat{f}(\quad; 0) + \sum_{i=1}^h T, (\hat{U}) \quad \mathbb{T}_1(\hat{f}) + \frac{1}{2} \sum_{i=0}^P T, (\hat{U}) \quad \text{Rung}(\hat{f}) \quad T_0(\hat{U}) + g$$

■

### V III. The Enlarged Algebra

The estimate of Theorem IV.1 on  $W^0(\cdot)$ , defined by

$$\|W^0(\cdot)\|_{;D} = \|c(\mathcal{W};_{;C+D})\|$$

was proven in the following way. We applied the results of Theorem II.28, combined with the estimates on Wick ordering (Corollary II.32) to get estimates on

$$W^{\infty}(\cdot) = \|c(\mathcal{W};_{;C+D})\| = \|c(\cdot; \mathcal{W};_{;D};_{;C})\|$$

in terms of the norm of  $W$ . Then we used Corollary II.32 again to estimate the norm of  $W^0$  in terms of the norm of  $W^{\infty}$ . The transition from  $W^{\infty}$  to  $W^0 = \mathcal{W}^{\infty};_{;D}$  creates new two and four legged vertices, whose improved norm cannot be estimated by the technique of Section VI. This transition also creates new ladder diagrams.

The same difficulty would occur if we tried to reduce the general case of Theorem VI.10 to the special case  $D = 0$  by Wick ordering  $S_{U,C}(f)$  at the end of the construction. Therefore we monitor the Wick ordering with respect to  $D$  throughout the construction. To do this we introduce fields  $\psi;^0;'$  for these Wick contractions and use an analogue of the operator  $R_{K,C}$  of Definition III.4.

Definition V III.1

(i) Let  $K_1(\psi;^0;'; \psi;^0;); K_2(\psi;^0;'; \psi;^0;)$  be even Grassmann functions with  $K_1(\psi;^0;'; \psi;^0;0) = 0$ . For a Grassmann function  $g(\psi;^0;')$  we define

$$Q(K_1; K_2)(g)(\psi;^0;') = \sum_{i=1}^Q \|K_i(\psi;^0;'; \psi;^0;)\|_{;D}^{0;D} \|g(\psi;^0;')\|_{;D} d_D(\psi;^0;') d_C(\psi;^0;') \|;_{;C}$$

The structure of  $Q$  is illustrated in the figure

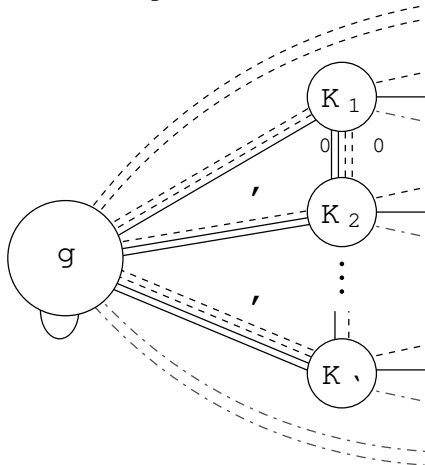



by Remark II.24. In iterated applications of  $Q_K$  this deterioration in the norm would build up excessively. For this reason, we avoid Wick contractions at most steps of the construction and perform them only before and during steps in which overlapping loops are exploited. For bookkeeping of the partially Wick ordered fields in intermediate steps we introduce an enlarged algebra.

### V III.1 Definition of the enlarged algebra

#### Definition V III.2

(i) A  $\mathbb{Z}_2$ -graded vector space is a complex vector space  $E$ , together with a decomposition  $E = E_+ \oplus E_-$ . The elements of  $E_+$  are called even, the elements of  $E_-$  odd. A graded vector space is a complex vector space  $E$ , together with a decomposition  $E = \bigoplus_{m=0}^{\infty} E_m$ . Every graded vector space is considered as a  $\mathbb{Z}_2$ -graded vector space with

$$E_+ = \bigoplus_{r \text{ even}} E_{2r} \quad E_- = \bigoplus_{r \text{ odd}} E_{2r-1}$$

(ii) If  $E$  is a  $(\mathbb{Z}_2)$ -graded vector space, the tensor algebra  $T(E)$  has a natural  $(\mathbb{Z}_2)$ -grading. The symmetric superalgebra over  $E$  is denoted  $S(E)$  and is defined as the quotient of  $T(E)$  by the two-sided ideal  $I(E)$  generated by

$$a b - b a \quad \text{with } a, b \in E_+ \text{ or } a, b \in E_- \\ a b + b a \quad \text{with } a \in E_+, b \in E_-$$

It is a superalgebra, and it is a graded superalgebra if  $E$  is a graded vector space (see [BS]).

Example V III.3 Let  $E$  be a complex vector space. Setting  $E_+ = \{0\}$ ;  $E_- = E$ , we give  $E$  the structure of a  $\mathbb{Z}_2$ -graded vector space in which all elements are odd. Then the symmetric superalgebra over  $E$  is the Grassmann algebra  $\bigwedge E$  over  $E$ . Setting  $E_+ = E$ ;  $E_- = \{0\}$ ,  $S(E)$  is the classical symmetric algebra  $S(E)$  over  $E$ .

Remark V III.4 There is a natural isomorphism between  $S(E)$  and the algebra  $S(E_+)$   $\bigwedge E_-$ , constructed in the following way:

Observe that

$$T(E) = \bigoplus_{\substack{m_1, n_1; \\ n_1, m_2; \\ \dots; \\ r, n_1, m_r, \dots}} E_+^{m_1} \otimes E_-^{n_1} \otimes \dots \otimes E_+^{m_r} \otimes E_-^{n_r}$$

Define the algebra homomorphism  $\phi^0 : T(E) \rightarrow S(E_+)$  by

$$\phi^0(v_1^+ \cdots v_r^+) = v_1^+ \cdots v_r^+ \quad \text{for } v_i^+ \in E_+.$$

Clearly  $I(E)$  lies in the kernel of  $\phi^0$ , so  $\phi^0$  induces an algebra homomorphism  $\phi : S(E) \rightarrow S(E_+)$ . One can check that  $\phi$  is an isomorphism. As  $S(E)$  and  $E$  are subalgebras of the tensor algebra  $T(E)$ ,  $S(E)$  can also be viewed as a subalgebra of  $T(E)$ .  $T(E) = T(E)$ .

Definition V III.5

(i) Let  $E$  be a complex vector space. The symmetric superalgebra  $S(V)$  over  $V$  (considered as a graded vector space) is called the enlarged algebra  $E$  over  $E$ . It is a graded superalgebra.

(ii) Multiplication

$$f_1 \cdots f_r \cdot g_1 \cdots g_s = f_1 \cdots f_r g_1 \cdots g_s$$

defines an algebra homomorphism from the tensor algebra  $T(V)$  to  $S(V)$ . The ideal  $I(V)$  of part (ii) of Definition V III.2 lies in the kernel of this homomorphism. Therefore it induces an algebra homomorphism

$$Ev : E \rightarrow \hat{E}$$

called the evaluation map. It is graded, that is

$$Ev(x) \in E_m \quad \text{when } x \in E_m$$

(ii) If  $A$  is a superalgebra, we define the enlarged algebra over  $E$  with coefficients in  $A$  as the tensor product

$${}_A E = A \otimes E$$

in the sense of Definition II.1.iv. The evaluation map extends by  $A$ -linearity to an algebra homomorphism

$$Ev : {}_A E \rightarrow \hat{{}_A E}$$

Remark V III.6

(i)  $S(V)$  is identified with the subspace  $(S(V))_1$  of  $S(V)$ .

(ii)  $Ev(x \cdot y) = Ev(x) \cdot Ev(y) = Ev(Ev(x) \cdot y)$  for all  $x, y \in S(V)$ .

(iii) By Remark V III.4, there is a natural inclusion of  $E = S^{\vee} E$  as a graded subalgebra of  $T^{\vee} E = T^{\vee}(T(E)) = T^{\vee}(E)$ .

### V III.2 Norm estimates for the enlarged algebra

As in subsection III.3, let  $A^0 = \bigvee_A V^0$  be the Grassmann algebra in the variables  $i$  with coefficients in  $A$ . Furthermore let  $E$  be a copy of  $V$  with generators  $i$  corresponding to the fields  $i$ . We will use the enlarged algebra

$$A = \bigvee_{A^0} E$$

over  $E$  with coefficients in  $A^0$ . Elements of  $A$  will be written as Grassmann functions  $f(\cdot; \sim)$ . They are linear combinations of monomials of the form

$$i_1 \dots i_n \binom{j_1^{(1)} \dots j_{p_1}^{(1)}}{j_1^{(2)} \dots j_{p_2}^{(2)}} \dots \binom{j_1^{(r)} \dots j_{p_r}^{(r)}}{j_1^{(r)} \dots j_{p_r}^{(r)}}$$

The evaluation map  $Ev : A \rightarrow \bigvee_{A^0} E = \bigvee_A (V \otimes E)$  maps such a monomial to  $i_1 \dots i_n \binom{j_1^{(1)} \dots j_{p_1}^{(1)}}{j_1^{(2)} \dots j_{p_2}^{(2)}} \dots \binom{j_1^{(r)} \dots j_{p_r}^{(r)}}{j_1^{(r)} \dots j_{p_r}^{(r)}}$ . As in Remark V III.6, the Grassmann algebra  $\bigvee_{A^0} E$  of Grassmann functions  $g(\cdot; \cdot)$  is viewed as a subspace of  $A$ .

The evaluation map  $Ev : A \rightarrow \bigvee_{A^0} E = \bigvee_A (V \otimes E)$  extends to a map  $Ev : \hat{\bigvee}_A (V^{(1)} \otimes \dots \otimes V^{(r)}) \rightarrow \hat{\bigvee}_{A^0} (E \otimes V^{(1)} \otimes \dots \otimes V^{(r)}) = \hat{\bigvee}_A (V \otimes E \otimes V^{(1)} \otimes \dots \otimes V^{(r)})$

where  $V^{(j)}$ ;  $j = 1, \dots, r$  are copies of  $V$  with generators  $i^{(j)}$ .

**Definition V III.7** By Remark V III.6.iii,  $A$  can be viewed as a graded subalgebra of  $A^0 \otimes T(E) = A^0 \otimes T(V)$ . Therefore the family  $\{k_m\}$  of seminorms on the spaces  $A_m^0 \otimes V^n$ , introduced in subsection III.3, induces a family of symmetric seminorms on the spaces  $A_m^0 \otimes V^n$ , which we again denote by  $\{k_m\}$ . This Definition extends the Definition of  $\{k_m\}$  given in subsection III.3. Also,  $c$  is a contraction bound and  $b$  an integral bound for the covariance  $C$  with respect to these norms.

**Lemma V III.8** Let  $f \in \bigvee_A (V_1 \otimes \dots \otimes V_r)$ . Then

$$\|N^0 Ev(f)\| \leq \|N^0(f; \cdot)\|$$

**Proof:**  $Ev(f)$  is obtained from  $f$  by antisymmetrization. ■

### V III.3 Schwinger Functionals over the Extended Algebra

Recall that for any even  $U(\psi) \in \mathcal{V}_{A^0}^V$ , the Schwinger functional with respect to  $U$  and  $C$  is the map from  $\mathcal{V}_{A^0}^V$  to  $A^0$  given by

$$S_{U;C}(f)(\psi) = \frac{1}{Z} \int_{\mathcal{C}} e^{U(\psi)} f(\psi) d_{\mathcal{C}}(\psi) \quad Z = \int_{\mathcal{C}} e^{U(\psi)} d_{\mathcal{C}}(\psi)$$

Also recall that for an even Grassmann function  $K(\tilde{\psi}; \psi^0)$  in the variables  $\psi^0$  over the extended algebra  $A$  and any Grassmann function  $f(\tilde{\psi}) \in \mathcal{V}_A^V$

$$R_{K;C}(f) = \int_{\mathcal{C}} \int_{\mathcal{D}} e^{K(\tilde{\psi}; \psi^0)} \int_{\mathcal{C}} f(\tilde{\psi}) d_{\mathcal{C}}(\psi^0) d_{\mathcal{C}}(\psi) d_{\mathcal{D}}(\psi)$$

Proposition V III.9 Let

$$U(\psi) = \int_{\mathcal{D}} \hat{U}(\psi) d_{\mathcal{D}}(\psi)$$

be even and set

$$K(\tilde{\psi}; \psi; \psi^0) = \int_{\mathcal{D}} \hat{U}(\tilde{\psi} + \psi + \psi^0) d_{\mathcal{D}}(\tilde{\psi} + \psi + \psi^0)$$

Let  $f(\tilde{\psi}) \in \mathcal{V}_{A^0}^V$  and set  $\tilde{f}(\tilde{\psi}; \psi) = \int_{\mathcal{D}} f(\tilde{\psi} + \psi) d_{\mathcal{D}}(\tilde{\psi} + \psi) \in \mathcal{V}_A^V$ . Then

$$S_{U;C} \int_{\mathcal{D}} \tilde{f}(\tilde{\psi}; \psi) d_{\mathcal{D}}(\psi) = \int_{\mathcal{E}V} \frac{1}{\mathbb{1}_{R_{K;C}}} \tilde{f} d_{\mathcal{C}}(\psi) d_{\mathcal{D}}(\psi) d_{\mathcal{D}}(\psi)$$

Observe that  $\frac{1}{\mathbb{1}_{R_{K;C}}}(\tilde{f}) \in \mathcal{V}_A^V$ , so that  $\int_{\mathcal{E}V} \frac{1}{\mathbb{1}_{R_{K;C}}}(\tilde{f}) d_{\mathcal{C}}(\psi) \in A$ .

For the proof of this Proposition we use

Lemma V III.10 Let  $f(\tilde{\psi})$  be a Grassmann function and set

$$\tilde{f}(\tilde{\psi}; \psi) = \int_{\mathcal{D}} f(\tilde{\psi} + \psi) d_{\mathcal{D}}(\tilde{\psi} + \psi)$$

Furthermore, let  $n \geq 1$ .

(i) Let  $\psi_1, \dots, \psi_n, \psi^0$  and let

$$\hat{K}_{ji}(\tilde{\psi}; \psi; \psi^0); \quad j=1, \dots, n; \quad i=1, \dots, n; \quad \psi^0$$

be even Grassmann functions with coefficients in  $A$ . Let

$$K_{ji}(\tilde{\psi}; \psi; \psi^0) = \int_{\mathcal{D}} \hat{K}_{ji}(\tilde{\psi} + \psi; \psi; \psi^0) d_{\mathcal{D}}(\tilde{\psi} + \psi)$$

considered as Grassmann functions in the variables  $x_j^0$ ; with coefficients in the enlarged algebra  $A$ . Then

$$\begin{aligned} \mathbb{Q} \int_{j=1}^{\infty} R_C \hat{K}_{j1} : \mathcal{D} ; \quad \hat{K}_{j_1 j_2} : \mathcal{D} \quad \mathcal{F} : \mathcal{D} \\ = \int_{j=1}^{\infty} \text{Ev} \int_{j=1}^{\infty} R_C K_{j1} ; \quad \int_{j_1 j_2}^{\infty} K (f) d_D ( ) : \mathcal{D} \end{aligned}$$

On the left hand side of the equation above, the operator  $R_C$  (defined in III.2) is considered over the algebra  $A^0$ , while on the right hand side it is considered over the extended algebra  $A$ .

(ii) Let  $\hat{K} ( ; ; ;^0 )$  be an even Grassmann function and

$$K ( ; ; ;^0 ) = \hat{K} ( + ; ; ;^0 ) : \mathcal{D}$$

Then

$$R_{\hat{K} : \mathcal{D} ; \mathcal{C}}^n \mathcal{F} : \mathcal{D} = \int_{j=1}^{\infty} \text{Ev} R_{\hat{K} : \mathcal{C}}^n (f) d_D ( ) : \mathcal{D}$$

Proof: (i) Let

$$h ( ; ) = \mathcal{G} ( ; ) : \mathcal{D} = \int_{j=1}^{\infty} R_C \hat{K}_{j1} : \mathcal{D} ; \quad \hat{K}_{j_1 j_2} : \mathcal{D} \quad \mathcal{F} : \mathcal{D}$$

By part (ii) of Proposition A.2, in the Grassmann algebra over  $A$  with variables  $x_j ; ; ;^0$

$$h ( + ; ) = \mathcal{G} ( + ; ) : \mathcal{D} = \int_{j=1}^{\infty} R_C K_{j1} ; \quad \int_{j_1 j_2}^{\infty} K \quad \mathcal{F} : \mathcal{D}$$

Hence, by the construction of  $A$  and  $\text{Ev}$ ,

$$h ( + ; ) = \mathcal{G} ( + ; ) : \mathcal{D} = \text{Ev} \int_{j=1}^{\infty} R_C K_{j1} ; \quad \int_{j_1 j_2}^{\infty} K \quad \mathcal{F} : \mathcal{D}$$

Therefore

$$\begin{aligned} \mathcal{G} ( ; ) &= \int_{j=1}^{\infty} \mathcal{G} ( + ; ) : \mathcal{D} d_D ( ) \\ &= \int_{j=1}^{\infty} \text{Ev} \int_{j=1}^{\infty} R_C K_{j1} ; \quad \int_{j_1 j_2}^{\infty} K (f) d_D ( ) \end{aligned}$$

(ii) follows from part (i) and Remark III.6. ■



Proof of Proposition V III.9: Set

$$\hat{K}(\cdot; \cdot; 0):_{\mathcal{D}} = \hat{U}(\cdot; +^0 + \cdot):_{\mathcal{D}} \quad \hat{U}(\cdot; +^0):_{\mathcal{D}}$$

By Proposition III.5, with  $\hat{U}(\cdot)$  replaced by  $\hat{U}(\cdot):_{\mathcal{D}}$  and  $K(\cdot; 0)$  replaced by  $\hat{K}(\cdot; \cdot; 0):_{\mathcal{D}}$ , and part ii of Lemma V III.10

$$\begin{aligned} R_{U;C}^n \mathbf{f}:_{\mathcal{D}} &= R_{Z^{\hat{K}}:_{\mathcal{D}};C}^n \mathbf{f}:_{\mathcal{D}} \\ &= \int \text{Ev } R_{K;C}^n(\mathbf{f}) d_D(\cdot):_{\mathcal{D}} \end{aligned}$$

By Theorem III.2

$$\begin{aligned} S_{U;C} \mathbf{f}:_{\mathcal{D}}(\cdot) &= \int_{Z^0}^Z \int_{Z^0}^P R_{U;C}^n \mathbf{f}:_{\mathcal{D}} d_C(\cdot) \\ &= \int_{Z^0}^Z \text{Ev} \int_{Z^0}^P R_{K;C}^n(\mathbf{f}) d_C(\cdot) d_D(\cdot):_{\mathcal{D}} \\ &= \int_{Z^0}^Z \text{Ev} \frac{1}{\mathbb{1}_{R_{K;C}}} \mathbf{f} d_C(\cdot) d_D(\cdot):_{\mathcal{D}} \end{aligned}$$

■

We use the extended algebra to give

#### V III.4 A second proof of Theorem IV .1

Proposition V III.11 Let  $\hat{U}(\cdot; \cdot); \hat{f}(\cdot; \cdot) \in \mathcal{V}_{A^0}^V$  with  $\hat{U}$  even. Set

$$\begin{aligned} U(\cdot; \cdot) &= \hat{U}(\cdot; \cdot):_{\mathcal{D};C} \\ f(\cdot; \cdot) &= \hat{f}(\cdot; \cdot):_{\mathcal{D};C} \end{aligned}$$

Assume that  $c$  is a contraction bound for the covariance  $C$  and  $b$  is an integral bound for  $C$  and for  $D$  and that  $N(\hat{U}; 8)_0 < \frac{2}{4}$ . Then  $S_{U;C}(f)$  exists. If

$$S_{U;C}(f) = \mathbf{f}^0(\cdot):_{\mathcal{D}}$$

then

$$N(\mathbf{f}^0(\cdot); \hat{f}(\cdot; 0); \frac{2}{2} N(\hat{f}; 4)) \frac{N(\hat{U}; 8)}{1 - \frac{4}{2} N(\hat{U}; 8)}$$

Proof: As above, set

$$K(\cdot; \cdot; \cdot; \cdot; 0) = \hat{U}(\cdot; \cdot; \cdot; 0) :_{\mathcal{D}} \quad \hat{U}(\cdot; \cdot; \cdot; 0) :_{\mathcal{D}}$$

$$f(\cdot; \cdot; \cdot) = \hat{f}(\cdot; \cdot) :_{\mathcal{D}}$$

By Remark II.24 and Corollary II.32

$$N(K) = N(\hat{U}; 8)$$

$$N(f) = N(\hat{f}; 4)$$

By Corollary III.9, applied with  $A$  replaced by  $A$

$$\frac{1}{\mathbb{1}_{R_{K;C}}} (f :_{\mathcal{C}}) \quad f :_{\mathcal{C}} = g(\cdot; \cdot; \cdot) :_{\mathcal{C}}$$

with

$$N^0(g) = \frac{2}{2} N^0(f) \frac{N^0(K)}{1 - \frac{4}{2} N^0(K)} = \frac{2}{2} N(f) \frac{N(K)}{1 - \frac{4}{2} N(K)} = \frac{2}{2} N(\hat{f}; 4) \frac{N(\hat{U}; 8)}{1 - \frac{4}{2} N(\hat{U}; 8)}$$

Consequently, by Lemma II.31,

$$N^0 \int_{\mathbb{1}_{R_{K;C}}} (f :_{\mathcal{C}}) \quad f :_{\mathcal{C}} d_{\mathcal{C}}(\cdot) = N^0 \int_{\mathbb{1}_{R_{K;C}}} g(\cdot; \cdot; \cdot) :_{\mathcal{C}} d_{\mathcal{C}}(\cdot)$$

$$N^0 g(\cdot; \cdot; \cdot)$$

$$\frac{2}{2} N(\hat{f}; 4) \frac{N(\hat{U}; 8)}{1 - \frac{4}{2} N(\hat{U}; 8)}$$

Observe that

$$\int_{\mathbb{1}_{R_{K;C}}} f :_{\mathcal{C}} d_{\mathcal{C}}(\cdot) = f(\cdot; \cdot; 0) = \hat{f}(\cdot; \cdot; 0) :_{\mathcal{D}}$$

Hence, by Proposition V III.9, with  $f(\cdot; \cdot)$  replaced by  $\hat{f}(\cdot; \cdot) :_{\mathcal{C}}$ , Lemma II.31 and Lemma V III.8

$$N f^0 \hat{f}(\cdot; 0) = N^0 \int_{\mathbb{1}_{R_{K;C}}} \hat{f}(\cdot; 0)$$

$$= N^0 \int_{\mathbb{1}_{R_{K;C}}} \frac{1}{\mathbb{1}_{R_{K;C}}} (f :_{\mathcal{C}}) d_{\mathcal{C}}(\cdot) \quad \hat{f}(\cdot; 0) :_{\mathcal{D}} d_{\mathcal{D}}(\cdot)$$

$$N^0 \int_{\mathbb{1}_{R_{K;C}}} \frac{1}{\mathbb{1}_{R_{K;C}}} (f :_{\mathcal{C}}) d_{\mathcal{C}}(\cdot) \quad \hat{f}(\cdot; 0) :_{\mathcal{D}}$$

$$N^0 \int_{\mathbb{1}_{R_{K;C}}} (f :_{\mathcal{C}}) \quad f :_{\mathcal{C}} d_{\mathcal{C}}(\cdot)$$

$$\frac{2}{2} N(\hat{f}; 4) \frac{N(\hat{U}; 8)}{1 - \frac{4}{2} N(\hat{U}; 8)}$$

■

Proof of Theorem IV.1, again: By Remark III.11, with  $W$  replaced by  $\mathcal{W} : \mathbb{C} + D$

$$\begin{aligned} \mathcal{W}^0( ; ) : \mathcal{P}_D = & \int_{Z_1}^{\mathbb{C}(\mathcal{W} : \mathbb{C} + D)} ( ; ) \mathcal{W} ( ; ) : \mathcal{P}_D \\ = & \int_0^1 S_{t\mathbb{U};\mathbb{C}} (\mathbb{U}) \mathcal{W} ( ; ) : \mathcal{P}_D dt \pmod{A_0} \end{aligned}$$

where

$$U( ; ) = \mathcal{W}( + ) : \mathcal{P}_{\mathbb{C}}^{\mathbb{D}}$$

Define  $f_t^0$  and  $\hat{f}$  by

$$\begin{aligned} \hat{f}( ; ) &= W( + ) \\ \mathcal{f}_t^0( ; ) : \mathcal{P}_D &= S_{t\mathbb{U};\mathbb{C}} (\mathbb{U}) \end{aligned}$$

Then

$$W^0( ; ) : \mathcal{P}_D = \int_0^1 \mathcal{f}_t^0( ; ) \hat{f}( ; 0) dt \pmod{A_0}$$

By Proposition V III.11, with  $\hat{U}_t( ; ) = tW( + )$ ,

$$\begin{aligned} N(W^0 ; ) &= \max_{0 < t < 1} N(\mathcal{f}_t^0( ; ) \hat{f}( ; 0); ) \\ &= \frac{2}{2} \max_{0 < t < 1} N(\hat{f}; 4) \frac{N(\hat{U}_t; 8)}{1 - \frac{4}{2} N(\hat{U}_t; 8)} \\ &= \frac{2}{2} \frac{N(W; 16)^2}{1 - \frac{4}{2} N(W; 16)} \end{aligned}$$

for all  $W$  with  $N(W; 16)_0 < \frac{2}{4}$ . Replacing by 2 gives

$$N(W^0 ; 2) = \frac{1}{2^2} \frac{N(W; 32)^2}{1 - \frac{1}{2} N(W; 32)}$$

for all  $W$  with  $N(W; 32)_0 < 2$ . ■

### V III.5 The Operator $\mathcal{Q}$

Lemma V III.12 Let  $f( ; \tilde{ ; })$  be a Grassmann function over the extended algebra  $A$  and set  $\mathcal{f}^0( ; ; ) : \mathcal{P}_D = \text{Ev}(f)$ .

(i) Let  $K_i( ; ; ;^0 ; ) ; i = 1 ; ; ; \backslash$  be Grassmann functions with  $K_i( ; ; ;^0 ; ) = 0$ . Set

$$K_i( ; ; ;^0 ; \prime ; ;^0 ; ) = K_i( ; +^0 + \prime ; ; ;^0 ; )$$

Then

$$\text{Ev}_{R_{\mathbb{C}}(K_1 ; \mathcal{P}_D ; ; ; K_D)} (f) = \mathcal{Q}(K_1 ; K ; ) (f^0) : \mathcal{P}_D$$

(ii) Let  $K(\cdot; \cdot; \cdot; \cdot; \cdot^0)$  be a Grassmann functions with  $K(\cdot; \cdot; \cdot; \cdot; \cdot^0; 0) = 0$ . Set

$$K(\cdot; \cdot; \cdot; \cdot^0; \cdot; \cdot; \cdot^0) = K(\cdot; \cdot + \cdot^0 + \cdot; \cdot; \cdot^0)$$

Then, when  $R_{\mathbb{K} : \mathbb{D} ; \mathbb{C}}$  is considered as an operator over  $A$ ,

$$\text{Ev } R_{\mathbb{K} : \mathbb{D} ; \mathbb{C}}(f) = :Q_{\mathbb{K}}(f^0) :_{\mathbb{D}}$$

Proof: Applying Remark VIII.6 and Corollary A.3 to the variable  $\tilde{\cdot}$  we see that

$$\begin{aligned} & \text{Ev } \mathbb{K}_1(\cdot; \cdot; \cdot; \cdot^0) :_{\mathbb{D}} \quad \cdot (\mathbb{K} ; \cdot; \cdot; \cdot^0) :_{\mathbb{D}} \quad f(\tilde{\cdot}; \cdot) \\ &= \text{Ev } \mathbb{K}_1 :_{\mathbb{D}} \quad \cdot :_{\mathbb{D}} \mathbb{K} \quad \text{Ev } f(\tilde{\cdot}; \cdot) \\ &= \text{Ev } \mathbb{K}_1 :_{\mathbb{D}} \quad \cdot :_{\mathbb{D}} \mathbb{K} \quad \cdot :_{\mathbb{D}} \\ &= \cdot :_{\mathbb{D}} :_{\mathbb{D}} \prod_{i=1}^{\mathbb{Q}} \mathbb{K}_i(\cdot; \cdot + \cdot^0 + \cdot; \cdot; \cdot^0) :_{\mathbb{D}} \quad \cdot :_{\mathbb{D}} \quad \cdot :_{\mathbb{D}} f^0(\cdot; \cdot + \cdot; \cdot) :_{\mathbb{D}} \quad \cdot :_{\mathbb{D}} d_{\mathbb{D}}(\cdot^0; \cdot) :_{\mathbb{D}} \end{aligned}$$

Applying each of the following operations to both sides of this equation

Wick order each  $\mathbb{K}_i :_{\mathbb{D}}$  with respect to  $\mathbb{C}$  in the  $\cdot^0$  variable.

Wick order the product  $\prod_{i=1}^{\mathbb{Q}} \mathbb{K}_i :_{\mathbb{D}} \cdot :_{\mathbb{D}}$  with respect to  $\mathbb{C}$  in the  $\cdot$  variable.

Integrate using  $d_{\mathbb{C}}(\cdot^0; \cdot)$ .

Wick order the result with respect to  $\mathbb{C}$  in the  $\cdot$  variable.

yields  $\text{Ev } R_{\mathbb{C}}(\mathbb{K}_1 :_{\mathbb{D}} ; \cdot ; \mathbb{K}_{\mathbb{D}})(f)$  on the left and  $:Q(\mathbb{K}_1 ; \mathbb{K}_{\mathbb{D}})(f^0) :_{\mathbb{D}}$  on the right.

(ii) follows from part (i), the definition of  $Q_{\mathbb{K}}$  and Remark III.6. ■

As in subsection VII.1, we define for Grassmann functions  $K_2(\cdot; \cdot; \cdot; \cdot^0; \cdot; \cdot; \cdot^0)$ ,  $\cdot$ ,  $K(\cdot; \cdot; \cdot; \cdot^0; \cdot; \cdot; \cdot^0)$  and  $f(\cdot; \cdot; \cdot)$  the Grassmann function  $Q(\mathbb{K}_2 ; \mathbb{K}_{\mathbb{D}})$  by

$$\begin{aligned} & Q(\mathbb{K}_2 ; \mathbb{K}_{\mathbb{D}})(f)(\cdot; \cdot; \cdot; \cdot^0; \cdot; \cdot; \cdot^0) \\ &= \cdot :_{\mathbb{D}} :_{\mathbb{D}} \prod_{i=2}^{\mathbb{Q}} \mathbb{K}_i(\cdot; \cdot; \cdot^0 + \cdot; \cdot; \cdot^0 + \cdot; \cdot; \cdot^0) :_{\mathbb{D}} \quad \cdot :_{\mathbb{D}} \quad \cdot :_{\mathbb{D}} f(\cdot; \cdot + \cdot + \cdot^0; \cdot + \cdot^0) :_{\mathbb{D}} \quad \cdot :_{\mathbb{D}} d_{\mathbb{D}}(\cdot; \cdot^0) d_{\mathbb{C}}(\cdot^0; \cdot) \end{aligned}$$

We have, as in Proposition VII.1

Proposition VIII.13 Let  $K_1(\cdot; \cdot; \cdot; \cdot^0; \cdot; \cdot; \cdot^0)$ ;  $\mathbb{K}_{\mathbb{D}}(\cdot; \cdot; \cdot; \cdot^0; \cdot; \cdot; \cdot^0)$  be Grassmann functions with  $K_1(\cdot; \cdot; \cdot; \cdot^0; \cdot; \cdot; \cdot^0; 0) = 0$ . Then for any Grassmann function  $f(\cdot; \cdot; \cdot)$

$$\begin{aligned} & Q(\mathbb{K}_1 ; \mathbb{K}_{\mathbb{D}})(f)(\cdot; \cdot; \cdot) \\ &= \cdot :_{\mathbb{D}} :_{\mathbb{D}} \mathbb{K}_1(\cdot; \cdot; \cdot; \cdot^0; \cdot; \cdot; \cdot^0) :_{\mathbb{D}} \quad \cdot :_{\mathbb{D}} \quad \cdot :_{\mathbb{D}} Q(\mathbb{K}_2 ; \mathbb{K}_{\mathbb{D}})(f)(\cdot; \cdot; \cdot; \cdot^0; \cdot; \cdot; \cdot^0) :_{\mathbb{D}} \quad \cdot :_{\mathbb{D}} d_{\mathbb{D}}(\cdot; \cdot^0) d_{\mathbb{C}}(\cdot^0; \cdot) :_{\mathbb{D}} \end{aligned}$$



## IX .0 overlapping Loops created by the second Covariance

In this Section we prove Theorem VI.10 in the general case. We assume that  $A$  is a superalgebra in which all elements have degree zero and that  $k = k$  and  $k_{\text{im pr}}$  are two systems of symmetric seminorms on the spaces  $A = V^n$  such that the covariances  $(C; D)$  have improved integration constants  $c; b; J$  for these families of seminorms.

### IX .1 Implementing Overlapping Loops

Proposition IX .1 Let  $K(\theta; \theta'; \theta; \theta; \theta; \theta)$  be an even Grassmann function such that  $K(\theta; \theta'; \theta; \theta; \theta; 0) = 0$ . Decompose

$$K = K^0 + K^\infty$$

where  $K^0$  has degree at most two in the variables  $\theta; \theta'; \theta$  and  $K^\infty$  has degree at least three in these variables. Let  $f(\theta; \theta; \theta)$  be a Grassmann function, and set

$$g; \theta; \theta; \theta = Q_K(f; \theta; \theta; \theta) \quad g^0; \theta; \theta; \theta = Q_{K^0}(f; \theta; \theta; \theta)$$

Then, if  $\theta \geq 2$  and  $N(K; 2) \geq 0$

$$N_{\text{im pr}}(g; \theta; \theta; \theta) \leq \frac{2^5 J}{6} N(f; 4) \frac{N(K; 2)}{1 - N(K; 2)}$$

The proof is analogous to the proof of Proposition VII.4 and is given following

Lemma IX .2 Let  $K(\theta; \theta'; \theta; \theta; \theta; \theta)$  be an even Grassmann function that satisfies  $K(\theta; \theta'; \theta; \theta; \theta; 0) = 0$ . Decompose

$$K = K^0 + K^\infty$$

where  $K^0$  has degree at most two in the variables  $\theta; \theta'; \theta$  and  $K^\infty$  has degree at least three in these variables. Let each of the functions  $K^{(1)}; \dots; K^{(n)}$  be either  $K^0$  or  $K^\infty$ , and assume that at least one of them is equal to  $K^\infty$ . Let  $f(\theta; \theta; \theta)$  be a Grassmann function, and set

$$\frac{1}{n!} Q(K^{(1)}; \dots; K^{(n)})(f; \theta; \theta; \theta) = f^0(\theta; \theta; \theta); \theta; \theta; \theta$$

where  $f; \theta; \theta; \theta$  is shorthand for  $f(\theta; \theta; \theta); \theta; \theta; \theta$ . Then, if  $\theta \geq 2$

$$N_{\text{im pr}}(f^0; \theta; \theta; \theta) \leq \frac{2^5}{1 + 5} J N(f; 4) N(K; 2)'$$

Proof: We may assume that  $K^{(1)} = K^{(0)}$ . Set

$$g(\lambda; \lambda; \lambda; \lambda; \lambda; \lambda) = Q(K^{(2)}; \lambda; \lambda)(\lambda; \lambda)$$

By Lemma VIII.14

$$\frac{1}{(\lambda-1)!} N(g) = \frac{1}{(\lambda-1)} N(\lambda; 4) N(K; 2)^{\lambda-1}$$

By Proposition VIII.13

$$f^0(\lambda; \lambda) = \frac{1}{\lambda!} \sum_{\lambda \in \mathbb{Z}^2} :K^{(0)}(\lambda; \lambda; \lambda; \lambda; \lambda; \lambda) :_{0; \lambda; \lambda}^{0; \lambda; \lambda} :g(\lambda; \lambda; \lambda; \lambda; \lambda; \lambda) :_{0; \lambda; \lambda}^{0; \lambda; \lambda} d_D(\lambda; \lambda) d_C(\lambda; \lambda)$$

Proposition VI.4 implies that

$$N_{\text{im pr}}(f^0) = \frac{2^7 J}{\lambda!} N(K^{(0)}) N(g) = \frac{2^5}{\lambda+5} J N(\lambda; 4) N(K; 2)^{\lambda}$$



Proof of Proposition IX.1: By Definition VIII.1ii

$$g = \sum_{\lambda=1}^{\infty} g_{\lambda}, \quad g^0 = \sum_{\lambda=1}^{\infty} g_{\lambda}^0$$

where

$$g_{\lambda} := \frac{1}{\lambda!} Q(K; \lambda; \lambda; \lambda; \lambda; \lambda)(\lambda; \lambda)$$

$$g_{\lambda}^0 := \frac{1}{\lambda!} Q(K^{(0)}; \lambda; \lambda; \lambda; \lambda; \lambda)(\lambda; \lambda)$$

Since

$$Q(K; \lambda; \lambda; \lambda; \lambda; \lambda) = Q(K^{(0)}; \lambda; \lambda; \lambda; \lambda; \lambda) + Q(K^{(0)}; \lambda; \lambda; \lambda; \lambda; \lambda) + \dots$$

it follows from Lemma IX.2 that

$$N_{\text{im pr}}(g_{\lambda} - g_{\lambda}^0) = \frac{2^5}{\lambda+5} J N(\lambda; 4) N(K; 2)^{\lambda}$$

Therefore

$$N_{\text{im pr}}(g - g^0) = \sum_{\lambda=1}^{\infty} N_{\text{im pr}}(g_{\lambda} - g_{\lambda}^0) = \frac{2^5 J}{\lambda+5} N(\lambda; 4) \frac{N(K; 2)^{\lambda}}{1 - \frac{1}{N(K; 2)^{\lambda}}}$$



Proposition IX.3 Let  $K(i; i^0; i'; i^0; i^0)$  be an even Grassmann function of degree at most two in the variables  $i^0; i^0; i'$  and of degree at least one in  $i$ . Write

$$K(i; i^0; i'; i^0; i^0) = \sum_{\substack{n_0, n_1, n_2, n_3 \\ p_1, p_2, p_3}} X K_{n_0} \binom{p_1 p_2 p_3}{n_1 n_2 n_3} (i; i^0; i'; i^0; i^0)$$

with  $K_{n_0} \binom{p_1 p_2 p_3}{n_1 n_2 n_3} \in \mathbb{A}[n_0; p_1; p_2; p_3; n_1; n_2; n_3]$ . Let

$$K_{i^0} = \sum_{n_0, n_1, p_1} P K_{n_0} \binom{p_1 0 0}{n_1 0 1}$$

be the part of  $K$  that has degree precisely one in  $i^0; i^0; i'$ .

Furthermore let  $T(i'; i)$  be a Grassmann function that has degree two in the variables  $i'$  and degree at least one in the variable  $i$ . Write  $T = T_{11} + T_{02}$  where  $T_{11}$  has degree one in  $i'$  and  $i$ , and  $T_{02}$  has degree two in  $i$ . Set

$$\begin{aligned} \text{Mix}(i'; i^0; i^0; i^0; i^0) &= T_{11}(i'; i^0; i^0) + T_{11}(i'; i^0; i^0) \\ &+ T_{02}(i; i^0; i^0) + T_{02}(i; i^0; i^0) + T_{02}(i; i^0; i^0) \end{aligned}$$

Furthermore set

$$\begin{aligned} K_1(i; i^0; i'; i^0; i^0) &= \int_{\mathbb{Z}} T(i'; i^0; i^0) :_{0;C} K(i; i^0; i^0; i'; i^0; i^0) :_{0;C} d_D(i^0) d_C(i^0) \\ K_2(i; i^0; i'; i^0; i^0) &= T_{11}(i'; i^0; i^0) :_{0;C} K(i; i^0; i^0; i'; i^0; i^0) :_{0;C} d_C(i^0) \end{aligned}$$

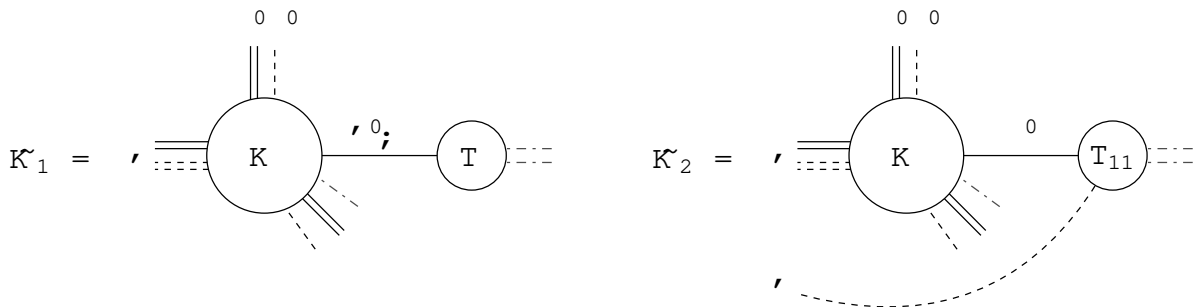

and  $K = K_1 + K_2$ ,

$$\begin{aligned} \hat{K}(i; i'; i; i) &= \int_{\mathbb{Z}} \text{Mix}(i'; i^0; i^0; i^0; i^0) :_{0;C} K_{i^0}(i; i^0; i^0; i'; i^0; i^0) :_{0;C} d_D(i^0) d_C(i^0) \\ &+ :_{0;C} K_{i^0}(i; i^0; i^0; i'; i^0; i^0) :_{0;C} d_D(i^0; i^0; i^0) d_C(i^0; i^0; i^0) \end{aligned}$$



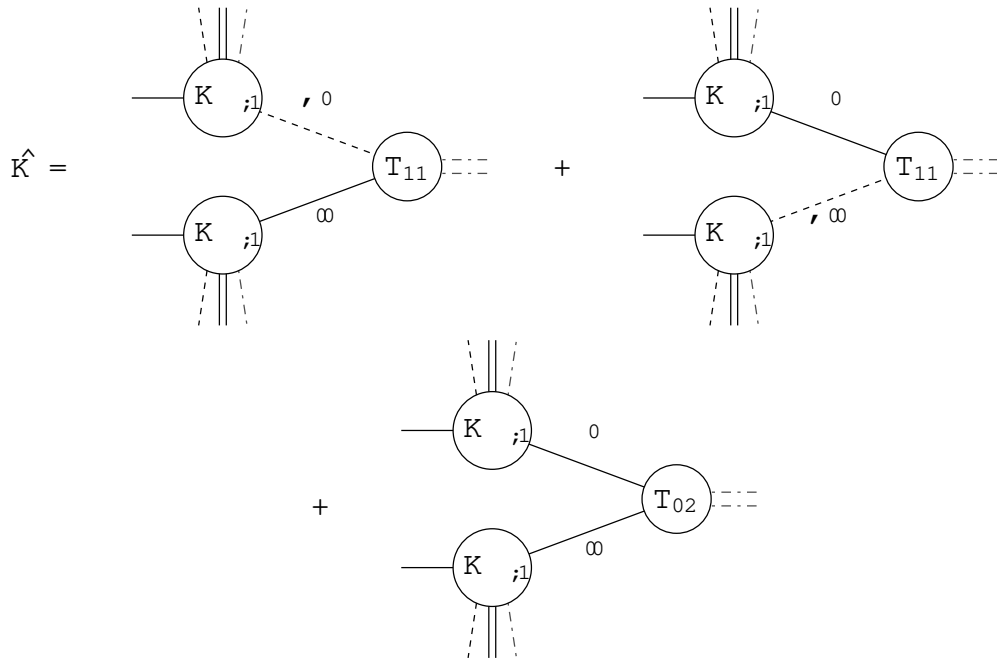

Finally let  $f(\cdot; \cdot; \cdot)$  be a Grassmann function and set

$$\begin{aligned}
 f^0(\cdot; \cdot'; \cdot) &= \mathcal{Q}(T) \mathcal{Q}(K; K)(\mathfrak{f}; \cdot_C)(\cdot; \cdot; 0'; 0; 0; \cdot) \\
 \mathfrak{f}(\cdot; \cdot'; \cdot); \cdot_C &= 2 \mathcal{Q}(K; K)(\mathfrak{f}; \cdot_C)(\cdot; + \cdot'; \cdot) \\
 \hat{\mathfrak{f}}(\cdot; \cdot'; \cdot); \cdot_C &= \mathcal{Q}(\hat{K})(\mathfrak{f}; \cdot_C)(\cdot; + \cdot'; \cdot)
 \end{aligned}$$

Then, if  $\ell \geq 2$ ,

$$N_{\text{im pr}}(f^0(\mathfrak{f} + \hat{\mathfrak{f}}); \cdot) = \frac{2^{\ell} J}{10} N(\mathfrak{f}; 4) N(K; 4)^2 N(T; 2)$$

The proof is similar to the proof of Proposition VII.7 and is given following

**Lemma IX.4** Let  $B(\cdot; \cdot^0; \cdot^{\infty}; \cdot^0; \cdot^{\infty})$  be a Grassmann function that has degree one in the variables  $\cdot^0; \cdot^0$ , degree one in the variables  $\cdot^{\infty}; \cdot^{\infty}$  and degree at least one in the variables  $\cdot^0; \cdot^{\infty}$ . Furthermore let  $H(\cdot; \cdot; \cdot^0; \cdot; \cdot; \cdot^0)$ ,  $K(\cdot; \cdot; \cdot^0; \cdot; \cdot; \cdot^0)$  be even Grassmann functions that vanish for  $\ell = 0$ . Assume that  $H$  or  $K$  has degree at least two in the variables  $\cdot^0; \cdot^0$ . Let  $f(\cdot; \cdot; \cdot)$  be any Grassmann function and set

$$\begin{aligned}
 g(\cdot; \cdot'; \cdot) &= \sum_{\mathbb{Z}^2} \sum_{\mathbb{H}^2} B(\cdot; \cdot^0; \cdot^{\infty}; \cdot^0; \cdot^{\infty}) : H(\cdot; + \cdot' + \cdot^0; \cdot^0; \cdot; + \cdot^0; \cdot^0) :_{\substack{0, \cdot^0, \cdot^{\infty} \\ 0, \cdot^0, \cdot^{\infty}}} : \\
 &\quad : K(\cdot; + \cdot' + \cdot^{\infty}; \cdot^0; \cdot; + \cdot^{\infty}; \cdot^0) :_{\substack{0, \cdot^0, \cdot^{\infty} \\ 0, \cdot^{\infty}, \cdot^0}} d_D(\cdot^0; \cdot^{\infty}; \cdot^0) d_C(\cdot^0; \cdot^{\infty}; \cdot^0) :_{\substack{\cdot^0 \\ \cdot^{\infty} \\ \cdot^0}} :_{\substack{\cdot^{\infty} \\ \cdot^0 \\ \cdot^{\infty}}} \\
 &\quad : f(\cdot; + \cdot' + \cdot; \cdot) :_{\substack{\cdot^0 \\ \cdot^{\infty}}} d_D(\cdot) d_C(\cdot)
 \end{aligned}$$

Then, if  $\alpha \geq 2$

$$N_{\text{im pr}}(g; \alpha) = \frac{2^5 J}{10} N(B; \alpha) N(H; 4) N(K; 4) N(f; 4)$$

Proof: In the proof we suppress the variable  $x$ . We assume that  $K$  has degree at least two in the variables  $y; z$ .

First we discuss the case that  $B$  has degree one in the variable  $x$ . Set

$$\begin{aligned} h(x; y; z; x^0; y^0; z^0) &= B(x^0; y^0; z^0) \cdot H(x + y + y^0; z; z^0 + x^0; y^0) \cdot f(x + y + z^0; z^0) \cdot d_D(x^0; z^0) d_C(x^0; z^0) \\ &= B(x^0; y^0; z^0) \cdot H(x + y + y^0; z; z^0 + x^0; y^0) \cdot f(x + y + z^0; z^0) \cdot d_D(x^0; z^0) d_C(x^0; z^0) \end{aligned}$$

By Lemma A.5, twice

$$\begin{aligned} &= \int \int H(x; y; z) K(x; y; z) \cdot f(x; y; z) \cdot d_C(x; z) d_D(x; z) \\ &= \int \int H(x; y; z) \cdot K(x; y; z) \cdot f(x; y; z) \cdot d_C(x; z) d_D(x; z) \end{aligned} \tag{IX.1}$$

so

$$\begin{aligned} g(x; y; z) &= \int \int h(x; y; z; x^0; y^0; z^0) \cdot K(x + y + y^0; z; z^0 + x^0; y^0) \cdot f(x + y + z^0; z^0) \cdot d_D(x^0; z^0) d_C(x^0; z^0) \\ &= \int \int h(x; y; z; x^0; y^0; z^0) \cdot K(x + y + y^0; z; z^0 + x^0; y^0) \cdot f(x + y + z^0; z^0) \cdot d_D(x^0; z^0) d_C(x^0; z^0) \end{aligned}$$

By iterated application of Lemma II.31 combined with Proposition II.33, first integrating  $\int d_C(x^0; z^0) d_D(x^0; z^0)$  and then integrating  $\int d_C(x^0; z^0) d_D(x^0; z^0)$ , and Remark II.24, several times,

$$\begin{aligned} N(h) &= \frac{1}{4} N(B) N(H(x + y + y^0; z; z^0 + x^0; y^0)) N(f(x + y + z^0; z^0)) \\ &= \frac{1}{4} N(B) N(H(x + y; z; z^0)) N(f(x + y; z^0)) \\ &= \frac{1}{4} N(B) N(H; 4) N(f; 4) \end{aligned}$$

Since  $h$ , through  $B$ , has degree one in  $x^0; z^0$ , only the part of  $K(x + y + y^0; z; z^0 + x^0; y^0)$  that has degree at least one in  $x^0; z^0$  can contribute to  $g(x; y; z)$ . As  $K$  also has degree at least two in the variables  $y; z$  and degree at least one in  $x$ , Proposition VI.4 implies that

$$\begin{aligned} N_{\text{im pr}}(g) &= \frac{27 J}{6} N(h) N(K; 4) \\ &= \frac{2^5 J}{10} N(B) N(H; 4) N(f; 4) N(K; 4) \end{aligned}$$

Next we discuss the situation that  $B$  has degree zero in the variable  $0$ . This implies that  $B$  has degree one in  $'^0$  and degree one in  $^{\infty}$ . Set

$$\begin{aligned}
 h( ;' ; ; ^0 ;' ^0 ; ; ^0 ; ; ^0 ) &= \text{ZZ} :H( + ' + ' ^0 ; ^0 ; ^{\infty} ; + ^0 ; ^0 ; ^{\infty} ) :_{\substack{00;D \\ 00;C}} \\
 & :f( + ' + + ^{\infty} ; + ^{\infty} ) :_{\substack{00;D \\ 00;C}} d_D( ^{\infty} ) d_C( ^{\infty} ) \\
 k( ;' ; ; ^0 ;' ^0 ; ; ^0 ; ; ^0 ) &= \text{ZZ} B( '^0 ;' ^{\infty} ; ^0 ; ^{\infty} ) :K( + ' + ' ^{\infty} ; ^0 ; ; + ^{\infty} ; ^0 ; ) :_{\substack{00;D \\ 00;C}} \\
 & d_D( '^{\infty} ) d_C( ^{\infty} )
 \end{aligned}$$

Again by (IX.1)

$$\begin{aligned}
 g &= \text{ZZ} :h( ;' ; ; ^0 ;' ^0 ; ; ^0 ; ; ^0 ) :_{\substack{0; ^0; ^0; ;D \\ 0; ^0; ;C}} \\
 & :k( ;' ; ; ^0 ;' ^0 ; ; ^0 ; ; ^0 ) :_{\substack{0; ^0; ^0; ;D \\ 0; ^0; ;C}} d_D( '^0 ; ^0 ; ) d_C( ^0 ; ^0 ; )
 \end{aligned}$$

By Lemma II.31, Proposition II.33 and Remark II.24

$$\begin{aligned}
 N(h) &= \frac{1}{2} N(H; 4) N(f; 4) \\
 N(k) &= \frac{1}{2} N(B; ) N(K; 4)
 \end{aligned}$$

Since  $k$  has degree at least one in  $^{\infty}$  and degree at least three in  $'^0 ; ^0 ; ; ^0 ; ^0 ;$  we have

$$N_{\text{impr}}(g) = \frac{27J}{6} N(h) N(k) = \frac{2^5 J}{10} N(H; 4) N(f; 4) N(K; 4) N(B)$$

■

Proof of Proposition IX.3: We again suppress  $^{\infty}$  in the proof. By definition

$$f^0( ;' ; ) = \text{ZZ} :T( '^0 ; ^0 ) :_{0;C} :Q(K; K) ( :f : ) ( + ' + ' ^0 ; + ^0 ) :_{0;D} d_D( '^0 ) d_C( ^0 )$$

so that, by Lemma A.7, recalling that  $T( '^0 ; ^0 )$  is of degree two in  $'^0 ; ^0$ ,

$$\begin{aligned}
 f^0( ;' ; ) &= \text{ZZ} :T( '^0 ; ^0 ) :_{0;C} :Q(K; K) ( :f : ) ( + ' + ' ^0 ; + ^0 ) :_{0;D} d_D( '^0 ) d_C( ^0 ) \\
 &= \text{ZZ} \text{h} \\
 & :T( '^0 ; ^0 ) :_{0;C} : : :K( + ' + ' ^0 ; ^0 ; ; + ^0 ; ^0 ; ) :_{0;D} \\
 & :K( + ' + ' ^0 ; ^0 ; ; + ^0 ; ^0 ; ) :_{0;D} :_{0;C} :_{0;C} \\
 & :f( + ' + ' ^0 ; ; ) :_{0;C} :_{0;D} d_D( '^0 ; ^0 ; ) d_C( ^0 ; ; ^0 )
 \end{aligned}$$

$$\begin{aligned}
&= 2 \int_{\mathbb{Z}^2} \int_{\mathbb{H}^1} \mathbb{T}(\ell^0; 0)_{0;C} \int_{\mathbb{H}^1} \mathbb{K}(\ell^0; 0; \ell^0; 0; \ell^0; 0)_{0;0;0;0} \int_{\mathbb{H}^1} \mathbb{K}(\ell^0; 0; \ell^0; 0; \ell^0; 0)_{0;0;0;0} \\
&\quad \int_{\mathbb{H}^1} \mathbb{K}(\ell^0; 0; \ell^0; 0; \ell^0; 0)_{0;0;0;0} \int_{\mathbb{H}^1} \mathbb{K}(\ell^0; 0; \ell^0; 0; \ell^0; 0)_{0;0;0;0} \\
&\quad \int_{\mathbb{H}^1} \mathbb{f}(\ell^0; 0; \ell^0; 0; \ell^0; 0)_{0;0;0;0} \int_{\mathbb{H}^1} \mathbb{d}_D(\ell^0; 0; \ell^0; 0) \mathbb{d}_C(\ell^0; 0; \ell^0; 0) \\
&+ \int_{\mathbb{Z}^2} \int_{\mathbb{H}^1} \mathbb{T}_{\text{mix}}(\ell^0; \ell^0; 0; 0) \int_{\mathbb{H}^1} \mathbb{K}(\ell^0; 0; \ell^0; 0; \ell^0; 0)_{0;0;0;0} \int_{\mathbb{H}^1} \mathbb{K}(\ell^0; 0; \ell^0; 0; \ell^0; 0)_{0;0;0;0} \\
&\quad \int_{\mathbb{H}^1} \mathbb{K}(\ell^0; 0; \ell^0; 0; \ell^0; 0)_{0;0;0;0} \int_{\mathbb{H}^1} \mathbb{K}(\ell^0; 0; \ell^0; 0; \ell^0; 0)_{0;0;0;0} \\
&\quad \int_{\mathbb{H}^1} \mathbb{f}(\ell^0; 0; \ell^0; 0; \ell^0; 0)_{0;0;0;0} \int_{\mathbb{H}^1} \mathbb{d}_D(\ell^0; \ell^0; 0; 0) \mathbb{d}_C(\ell^0; \ell^0; 0; 0)
\end{aligned} \tag{IX 2}$$

The  $\mathbb{T}_{\text{mix}}$  term in (IX 2) above differs from

$$\int_{\mathbb{Z}^2} \int_{\mathbb{H}^1} \hat{\mathbb{K}}(\ell^0; \ell^0; \ell^0; \ell^0)_{0;0;0;0} \int_{\mathbb{H}^1} \mathbb{f}(\ell^0; 0; \ell^0; 0; \ell^0; 0)_{0;0;0;0} \mathbb{d}_D(\ell^0; \ell^0; 0; 0) \mathbb{d}_C(\ell^0; \ell^0; 0; 0) = \hat{\mathbb{f}}(\ell^0; \ell^0; \ell^0; \ell^0)$$

by

$$\begin{aligned}
&\int_{\mathbb{Z}^2} \int_{\mathbb{H}^1} \mathbb{T}_{\text{mix}}(\ell^0; \ell^0; 0; 0) \int_{\mathbb{H}^1} \mathbb{H}(\ell^0; 0; \ell^0; 0; \ell^0; 0)_{0;0;0;0} \int_{\mathbb{H}^1} \mathbb{H}(\ell^0; 0; \ell^0; 0; \ell^0; 0)_{0;0;0;0} \\
&\quad \int_{\mathbb{H}^1} \mathbb{H}(\ell^0; 0; \ell^0; 0; \ell^0; 0)_{0;0;0;0} \int_{\mathbb{H}^1} \mathbb{H}(\ell^0; 0; \ell^0; 0; \ell^0; 0)_{0;0;0;0} \\
&\quad \int_{\mathbb{H}^1} \mathbb{f}(\ell^0; 0; \ell^0; 0; \ell^0; 0)_{0;0;0;0} \int_{\mathbb{H}^1} \mathbb{d}_D(\ell^0; \ell^0; 0; 0) \mathbb{d}_C(\ell^0; \ell^0; 0; 0) \\
&+ 2 \int_{\mathbb{Z}^2} \int_{\mathbb{H}^1} \mathbb{T}_{\text{mix}}(\ell^0; \ell^0; 0; 0) \int_{\mathbb{H}^1} \mathbb{H}(\ell^0; 0; \ell^0; 0; \ell^0; 0)_{0;0;0;0} \int_{\mathbb{H}^1} \mathbb{K}_{\neq 1}(\ell^0; 0; \ell^0; 0; \ell^0; 0)_{0;0;0;0} \\
&\quad \int_{\mathbb{H}^1} \mathbb{K}_{\neq 1}(\ell^0; 0; \ell^0; 0; \ell^0; 0)_{0;0;0;0} \int_{\mathbb{H}^1} \mathbb{K}_{\neq 1}(\ell^0; 0; \ell^0; 0; \ell^0; 0)_{0;0;0;0} \\
&\quad \int_{\mathbb{H}^1} \mathbb{f}(\ell^0; 0; \ell^0; 0; \ell^0; 0)_{0;0;0;0} \int_{\mathbb{H}^1} \mathbb{d}_D(\ell^0; \ell^0; 0; 0) \mathbb{d}_C(\ell^0; \ell^0; 0; 0)
\end{aligned}$$

where  $\mathbb{K} = \mathbb{K}_{\neq 1} + \mathbb{H}$ . By Lemma IX.4, the improved norm of this difference is bounded by

$$\begin{aligned}
&3 \frac{2^5 J}{10} N(\mathbb{T}_{\text{mix}}; N) N(\mathbb{H}; 4) N(\mathbb{K}; 4) N(\mathbb{f}; 4) \\
&\frac{2^9 J}{10} N(\mathbb{T}; 2) N(\mathbb{K}; 4)^2 N(\mathbb{f}; 4)
\end{aligned}$$

We apply Lemma A.5 to the variable  $\ell^0$  in the  $2 \int_{\mathbb{Z}^2} \int_{\mathbb{H}^1} \mathbb{T}(\ell^0; 0)_{0;C}$  term of (IX 2). We get

$$\begin{aligned}
&2 \int_{\mathbb{Z}^2} \int_{\mathbb{H}^1} \mathbb{T}(\ell^0; \ell^0; 0)_{0;C} \int_{\mathbb{H}^1} \mathbb{K}(\ell^0; 0; \ell^0; 0; \ell^0; 0)_{0;0;0;0} \int_{\mathbb{H}^1} \mathbb{K}(\ell^0; 0; \ell^0; 0; \ell^0; 0)_{0;0;0;0} \\
&\quad \int_{\mathbb{H}^1} \mathbb{K}(\ell^0; 0; \ell^0; 0; \ell^0; 0)_{0;0;0;0} \int_{\mathbb{H}^1} \mathbb{K}(\ell^0; 0; \ell^0; 0; \ell^0; 0)_{0;0;0;0} \\
&\quad \int_{\mathbb{H}^1} \mathbb{f}(\ell^0; 0; \ell^0; 0; \ell^0; 0)_{0;0;0;0} \int_{\mathbb{H}^1} \mathbb{d}_D(\ell^0; \ell^0; 0; 0) \mathbb{d}_C(\ell^0; \ell^0; 0; 0)
\end{aligned}$$

As  $T$  has degree at most one in  $'^0 + '^\infty$ , this is equal to

$$\begin{aligned}
& \int_{\mathbb{Z}^2} 2 \int_{\mathcal{C}} \mathcal{T}('^0; 0) :_{\mathcal{C}} \mathcal{K}(' + ' + ' ; 0; 0; 0; 0) :_{\mathcal{C}}^{0, ' ; 0, \mathcal{D}} \\
& \quad \mathcal{K}(' + ' ; 0; 0; 0; 0) :_{\mathcal{C}}^{0, \mathcal{D}} :_{\mathcal{C}}^{\mathcal{D}} \\
& \quad \mathcal{f}(' + ' + ' ; ) :_{\mathcal{C}}^{\mathcal{D}} \mathcal{d}_{\mathcal{D}}(' ; ' ; 0) \mathcal{d}_{\mathcal{C}}(' ; 0) \\
& + 2 \int_{\mathbb{Z}^2} \mathcal{T}_{11}('^\infty; 0) :_{\mathcal{C}} \int_{\mathcal{C}} \mathcal{K}(' + ' ; 0; 0; 0; 0) :_{\mathcal{C}}^{0, \mathcal{D}} \\
& \quad \mathcal{K}(' + ' ; 0; 0; 0; 0) :_{\mathcal{C}}^{0, \mathcal{D}} :_{\mathcal{C}}^{\mathcal{D}} \\
& \quad \mathcal{f}(' + ' + '^\infty + ' ; ) :_{\mathcal{C}}^{0, \infty ; \mathcal{D}} \mathcal{d}_{\mathcal{D}}(' ; '^\infty ; 0) \mathcal{d}_{\mathcal{C}}(' ; 0)
\end{aligned}$$

Applying Lemma A.5, with  $'$  replaced by  $'^\infty$  and  $0$  replaced by  $'^\infty$ , to the second term, this is equal to

$$\begin{aligned}
& \int_{\mathbb{Z}^2} 2 \int_{\mathcal{C}} \mathcal{T}('^\infty; 0) :_{\mathcal{C}} \mathcal{K}(' + ' + '^\infty ; 0; 0; 0; 0) :_{\mathcal{C}}^{0, '^\infty ; 0, \mathcal{D}} \\
& \quad \mathcal{K}(' + ' ; 0; 0; 0; 0) :_{\mathcal{C}}^{0, \mathcal{D}} :_{\mathcal{C}}^{\mathcal{D}} \\
& \quad \mathcal{f}(' + ' + '^\infty ; ) :_{\mathcal{C}}^{\mathcal{D}} \mathcal{d}_{\mathcal{D}}('^\infty ; '^\infty ; 0) \mathcal{d}_{\mathcal{C}}('^\infty ; 0) \\
& + 2 \int_{\mathbb{Z}^2} \mathcal{T}_{11}('^\infty; 0) \int_{\mathcal{C}} \mathcal{K}(' + ' ; 0; 0; 0; 0) :_{\mathcal{C}}^{0, \mathcal{D}} \\
& \quad \mathcal{K}(' + ' ; 0; 0; 0; 0) :_{\mathcal{C}}^{0, \mathcal{D}} :_{\mathcal{C}}^{\mathcal{D}} \\
& \quad \mathcal{f}(' + ' + '^\infty ; ) :_{\mathcal{C}}^{\mathcal{D}} \mathcal{d}_{\mathcal{D}}('^\infty ; 0) \mathcal{d}_{\mathcal{C}}('^\infty ; 0) \\
& = 2 \int_{\mathbb{Z}^2} \int_{\mathcal{C}} \mathcal{K}_1(' + ' ; 0; 0; 0; 0) :_{\mathcal{C}}^{0, \mathcal{D}} \int_{\mathcal{C}} \mathcal{K}(' + ' ; 0; 0; 0; 0) :_{\mathcal{C}}^{0, \mathcal{D}} :_{\mathcal{C}}^{\mathcal{D}} \\
& \quad \mathcal{f}(' + ' + '^\infty ; ) :_{\mathcal{C}}^{\mathcal{D}} \mathcal{d}_{\mathcal{D}}('^\infty ; 0) \mathcal{d}_{\mathcal{C}}('^\infty ; 0) \\
& + 2 \int_{\mathbb{Z}^2} \int_{\mathcal{C}} \mathcal{K}_2(' + ' ; 0; 0; 0; 0) :_{\mathcal{C}}^{0, \mathcal{D}} \int_{\mathcal{C}} \mathcal{K}(' + ' ; 0; 0; 0; 0) :_{\mathcal{C}}^{0, \mathcal{D}} :_{\mathcal{C}}^{\mathcal{D}} \\
& \quad \mathcal{f}(' + ' + '^\infty ; ) :_{\mathcal{C}}^{\mathcal{D}} \mathcal{d}_{\mathcal{D}}('^\infty ; 0) \mathcal{d}_{\mathcal{C}}('^\infty ; 0)
\end{aligned}$$

So the  $2 \int_{\mathcal{C}} \mathcal{T}('^\infty; 0) :_{\mathcal{C}}$  term of (IX.2) equals

$$f_1('^\infty; 0) + f_2('^\infty; 0)$$

where

$$f_1('^\infty; 0) :_{\mathcal{C}} = 2Q(\mathcal{K}_1; \mathcal{K})(\mathcal{f})('^\infty; 0)$$

$$f_2('^\infty; 0) :_{\mathcal{C}} = 2Q(\mathcal{K}_2; \mathcal{K})(\mathcal{f})('^\infty; 0)$$

As  $f = f_1 + f_2$ , the Proposition follows. ■





P roof: The proof is similar to that of Lemma VII.11. If  $f: \mathcal{C} = Q(T)Q(K; \quad ;K)(f)$ , with  $\backslash K$ 's, then, as  $K$  is of degree at least two in  $\quad ; \quad$ ; and  $T$  is 2-legged with external legs,  $f$  has degree at least  $e + 2 - 2$ . Hence

$$P Q(T)Q_K(f) = P Q(T)Q(K)(f) \quad \text{if } e = 4$$

$$P Q(T)Q_K(f) = P Q(T)Q(K)(f) + \frac{1}{2}P Q(T)Q(K;K)(f) \quad \text{if } e = 2$$

The contribution  $P Q(T)Q_K n_0 \binom{p_1 p_2 p_3}{n_1 n_2 n_3}$  vanishes unless

$p_1 + n_1 = 2$ , since otherwise  $Q(T)Q_K \binom{p_1 p_2 p_3}{n_1 n_2 n_3}$  is of degree at least one in  $\quad$  and  $P$  sets  $\quad$  to zero.

$n_1 \geq 1; 2g$  since these  $\quad$  elds must connect to  $\quad$  elds of  $T$  and  $T$  has degree one or two in  $\quad$

$p_2 = n_2 = 0$  since there is only a single  $K$  in  $P Q(T)Q_K n_0 \binom{p_1 p_2 p_3}{n_1 n_2 n_3}$

$p_3 + n_3 = 2$  because  $K$  is of degree at most two in  $\quad ; \quad ; \quad$ .

$n_3 = 1$  because  $K$  is of degree at least one in  $\quad$ .

$n_0 + n_1 + p_1 + n_3 + p_3 = 4$  because  $K$  is of degree at least four overall.

Hence

$$\begin{aligned} P Q(T)Q(K) &= P Q(T)Q \binom{P}{p_1+n_1=2, p_3+n_3=2} K \binom{p_1 0 p_3}{n_1 0 n_3} + P Q(T)Q \binom{P}{p_3+n_3=2} K \binom{0 0 p_3}{1 0 n_3} \\ &+ P Q(T)Q \binom{P}{p_1+n_1=2} K \binom{p_1 0 0}{n_1 0 1} + P Q(T)Q K \binom{0 0 0}{1 0 1} \\ &= P Q(T K) + Q(k) + Q(t_1 + t_{21} + t_{22}) \end{aligned}$$

where

$$k(\quad ; \quad ; \quad) = \int_{ZZ} T_{11}(\quad ; \quad ; \quad) \int_{n_0-1}^P K_{n_0} \binom{0 0 p_3}{1 0 n_3}(\quad ; 0; 0; \quad ; \quad ; 0; 0; \quad) d_C(\quad)$$

$$t_1(\quad ; \quad ; \quad) = \int_{ZZ} \int_{n_0-1}^P T(\quad ; \quad ; \quad) :_0 \int_{n_0-1}^P K_{n_0} \binom{p_1 0 0}{n_1 0 1}(\quad ; \quad ; 0; 0; \quad ; 0; 0; \quad) d_D(\quad) d_C(\quad)$$

is a one-legged tail with at least  $e + 1$  external legs

$$t_{21}(\quad ; \quad ; \quad) = \int_{ZZ} \int_{n_0-1}^P T(\quad ; \quad ; \quad) :_0 \int_{p_3+n_3=2}^P K_{n_0} \binom{p_1 0 p_3}{n_1 0 n_3}(\quad ; \quad ; 0; 0; \quad ; \quad ; 0; 0; \quad) d_D(\quad) d_C(\quad)$$

is a two-legged tail with at least  $e + 1$  external legs

$$t_{22}(\quad ; \quad ; \quad) = \int_Z T_{11}(\quad ; \quad ; \quad) \int_{n_0-2}^P K_{n_0} \binom{0 0 0}{1 0 1}(\quad ; 0; 0; 0; \quad ; 0; 0; \quad) d_C(\quad)$$

is a two-legged tail with at least  $e + 2$  external legs



If e 4,

$$P Q (k) = P Q (t_1) = P Q (t_{21}) = P Q (t_{22}) = 0$$

If e 2, by Lemma II.31 and Proposition II.33,

$$N (t_1); N (t_{21}); N (t_{22}) = \frac{1}{2} N (T) N (K)$$

Furthermore k has degree at least one in the variable and degree three in the variables ' ; .  
By Lemma IX.2 and Proposition II.33

$$\begin{aligned} N_{\text{in pr}} P Q (k) (f) &= \frac{2^5}{6} J N (k; 2) N (f; 4) \\ &= \frac{2^3}{8} J N (T; 2) N (K; 2) N (f; 4) \end{aligned}$$

We define the projection  $P^0$  by

$$P^0 f ( ; ; ) = f_4 ( ; 0; 0) + f_2 ( ; 0; 0)$$

Observe that

$$\begin{aligned} P Q (T) Q (K; K) (f) &= P^0 Q (T) Q (K; K) (f) ( ; ; 0; 0; ; 0; 0) \\ &= P^0 Q (T) Q (K; K) (f) ( ; 0; 0; 0; 0; 0; 0) \end{aligned}$$

so that we can apply Proposition IX.3. Modulo a term whose improved norm  $N_{\text{in pr}}$  is bounded by  $\frac{2^9}{10} J N (f; 4) N (K; 4)^2 N (T; 2)$

$$\begin{aligned} P^0 Q (T) Q (K; K) (f) ( ; ; 0; 0; 0; 0; ; ) \\ = 2 P Q (K_1; K) (f) + 2 P Q (K_2; K) (f) + P Q (\hat{K}) (f) \end{aligned}$$

where  $K_1; K_2; \hat{K}$  are as in Proposition IX.3. Since  $K_1$  has degree at least three in ; ; , the tail  $\hat{K}$  has at least six external legs, so that  $P Q (\hat{K}) (f) = 0$ . Similarly, as  $K_2$  has degree at least three in ; ; and  $K$  has degree at least two in ; ; ,  $P Q (K_2; K) (f) = 0$ . As  $K_1$  and  $K$  have degree at most two in  $^0; ' ; ^0$  and degree at least four overall,

$$\begin{aligned} P Q (K_1; K) (f) &= P Q (T_1 (K_1); T_1 (K)) (f) + P Q ( ) (f) \\ &= P Q (T_1 (K); T_1 (K)) (f) + P Q ( ) (f) \end{aligned}$$

where

$$\begin{aligned} ( ; ' ; ) &= \sum_{P, Z} \\ P & \\ p_2 + n_2 = 1 & (K_1)_2 \binom{0 \ p_2 \ 0}{0 \ n_2 \ 1} ( ; 0; ^0; 0; 0; ^0; ) K_2 \binom{0 \ p_2 \ 0}{0 \ n_2 \ 1} ( ; 0; ^0; 0; 0; ^0; ) d_D ( ^0) d_C ( ^0) \end{aligned}$$

is a two-legged tail with at least  $e + 2$  external legs and degree two in  $\mathbb{C}$ . By Proposition II.33

$$\begin{aligned} N_{p_2+n_2=1}^P &= \int_{\mathbb{Z}\mathbb{Z}} (\mathcal{K}_1)_2 \binom{0 \ p_2 \ 0}{0 \ n_2 \ 1} (\ ; 0; \ 0; 0; 0; \ 0; ) \\ &= N_{p_2+n_2=1} \int_{\mathbb{C}} \mathcal{T}_{11} (\ ;' \ 0; \ 0; ) :_{\mathbb{C}} \int_{\mathbb{Z}\mathbb{Z}} \mathcal{K}_2 \binom{1 \ p_2 \ 0}{1 \ n_2 \ 1} (\ ;' \ 0; \ 0; 0; 0; \ 0; ) d_D (\ ' \ 0) d_C (\ 0) \\ &= \frac{1}{2} N(\mathcal{T}) N(\mathcal{K}) \end{aligned}$$

Therefore, by Proposition II.33, for any Grassmann function  $h$ ,

$$\begin{aligned} N_{\mathbb{Z}\mathbb{Z}} &= \int_{\mathbb{C}} (\ ;' \ ; ) :_{\mathbb{C}} h (\ ;' \ ; \ ; \ ^{(1)}; \ ; \ ^{(r)}; ) d_C (\ ) \\ &= \frac{4}{4} N_{p_2+n_2=1}^P (\mathcal{K}_1)_2 \binom{0 \ p_2 \ 0}{0 \ n_2 \ 1} (\ ; 0; \ 0; 0; 0; \ 0; ) N(\mathcal{K}) N(h) \\ &= \frac{4}{6} N(\mathcal{T}) N(\mathcal{K})^2 N(h) \end{aligned}$$

Similarly,

$$\begin{aligned} N_{\text{im pr}} &= \int_{\mathbb{C}} (\ ;' \ ; ) :_{\mathbb{C}} h (\ ;' \ ; \ ; \ ^{(1)}; \ ; \ ^{(r)}; ) d_C (\ ) = \frac{4}{6} N_{\text{im pr}}(\mathcal{T}) N_{\text{im pr}}(\mathcal{K})^2 N_{\text{im pr}}(h) \\ &= \frac{4}{6} N(\mathcal{T}) N(\mathcal{K})^2 N_{\text{im pr}}(h) \end{aligned}$$

Therefore

$$N_e (\ ) = \frac{4}{4} N(\mathcal{T}) N(\mathcal{K})^2$$

■

**Lemma IX.11** Assume that  $K (\ ; \ ; \ 0; \ ; \ ; \ 0; )$  has degree at most two in the variables  $\ ;' \ ; \ 0;$ . Let  $\mathcal{T}_1; \mathcal{T}_2$  be two-legged tails. Then there exists a one-legged tail  $t_1$ , a two-legged tail  $t_2$  and a two-legged tail  $( \ ;' \ ; )$  of degree two in  $\mathbb{C}$ , each with at least four external legs, such that for any Grassmann function  $f (\ ; \ ; )$  the following holds:

Set

$$f^0 (\ ) = \int_{\mathbb{C}} \int_{\mathbb{Z}\mathbb{Z}} (\mathcal{T}_1; \mathcal{T}_2) Q_{\mathcal{K}} (\ ; \ ; ) Q (\mathcal{T}_1 \ \mathcal{K} \ ; \ \mathcal{T}_2 \ \mathcal{K} ) (\ ; \ ; ) Q (t_1 + t_2 + \ ) (\ ; \ ; )$$

Then, if  $e \geq 2$

$$N_{\text{im pr}} (f^0) = \frac{2^9 J}{10} N(f; 4) N(\mathcal{T}_1; 2) N(\mathcal{T}_2; 2) N(\mathcal{K}; 4) \left( 1 + \frac{N(\mathcal{K}; 4)}{2} \right)$$

and

$$\begin{aligned} N(t_1) &= \frac{4}{4} N(\mathcal{T}_1) N(\mathcal{T}_2) N(\mathcal{K}) \\ N(t_2) &= \frac{12}{4} N(\mathcal{T}_1) N(\mathcal{T}_2) N(\mathcal{K}) \\ N_e (\ ) &= \frac{8}{6} N(\mathcal{T}_1) N(\mathcal{T}_2) N(\mathcal{K})^2 \end{aligned}$$

Proof: The proof is similar to that of Lemma VII.12. Again, if

$$f : \mathbb{C} = Q(T_1; T_2)Q(K; \quad ; K)(f :)$$

with  $n$   $K$ 's, then, as  $K$  is of degree at least two in  $\quad ; \quad$  and  $T_1; T_2$  are 2-legged with at least two external legs,  $f$  has degree at least  $4 + 2n \geq 4$ . Hence

$$P Q(T_1; T_2)Q_K(f : ) = P Q(T_1; T_2)Q(K)(f : ) + \frac{1}{2} P Q(T_1; T_2)Q(K; K)(f : )$$

The contribution  $P Q(T_1; T_2)Q_{K_{n_0}} \binom{p_1 p_2 p_3}{n_1 n_2 n_3}$  vanishes unless

$n_0 = 0$  because  $T_1$  and  $T_2$  are each of degree at least two in  $\quad$ .

$p_1 + n_1 \geq 4$ , since otherwise  $Q(T_1; T_2)Q_{K_0} \binom{p_1 p_2 p_3}{n_1 n_2 n_3}$  is of degree at least one in  $\quad$  and  $P$  sets it to zero.

$n_1 \geq 2$  since these legs must connect to legs of  $T_1; T_2$  which have combined degree at least two in  $\quad$

$p_2 = n_2 = 0$  since there is only a single  $K$  in  $P Q(T_1; T_2)Q_{K_{n_0}} \binom{p_1 p_2 p_3}{n_1 n_2 n_3}$

$p_3 + n_3 \geq 2$  because  $K$  is of degree at most two in  $\quad ; \quad ; \quad$ .

$n_3 \geq 1$  because  $K$  is of degree at least one in  $\quad$ .

$n_1 + p_1 + n_3 + p_3 \geq 4$  because  $K$  is of degree at least four overall.

Hence

$$P Q(T_1; T_2)Q(K)(f : ) = P Q(t_{11} + t_{21} + t_{22} + t_{23})(f : ) + P Q(k)(f : )$$

where

$$t_{11}(\quad ; \quad ; \quad) = \int_{0;C}^{ZZ} :T_1(\quad ; \quad^0 ; \quad^0)T_2(\quad ; \quad^0 ; \quad^0) :_{0;C}^{0;D} \int_{p_1+n_1=4}^P K_0 \binom{p_1 0 0}{n_1 0 1} (0; \quad^0 ; 0; 0; \quad^0 ; 0; \quad) d_D(\quad^0) d_C(\quad^0)$$

$$t_{21}(\quad ; \quad ; \quad) = \int_{0;C}^{ZZ} :T_1(\quad ; \quad^0 ; \quad^0)T_2(\quad ; \quad^0 ; \quad^0) :_{0;C}^{0;D} \int_{\substack{p_1+n_1=4 \\ p_3+n_3=2}}^P K_0 \binom{p_1 0 p_3}{n_1 0 n_3} (0; \quad^0 ; 0; \quad ; \quad^0 ; 0; \quad) d_D(\quad^0) d_C(\quad^0)$$

$$t_{22}(\quad ; \quad ; \quad) = \int_{0;C}^{ZZ} :T_1(\quad ; \quad ; \quad^0)T_2(\quad ; \quad^0 ; \quad^0) :_{0;C} \int_{p_1+n_1=3}^P K_0 \binom{p_1 0 0}{n_1 0 1} (0; \quad^0 ; 0; \quad ; \quad^0 ; 0; \quad) d_D(\quad^0) d_C(\quad^0)$$

$$t_{23}(\quad ; \quad ; \quad) = \int_{0;C}^{ZZ} :T_1(\quad ; \quad^0 ; \quad^0)T_2(\quad ; \quad ; \quad^0) :_{0;C} \int_{p_1+n_1=3}^P K_0 \binom{p_1 0 0}{n_1 0 1} (0; \quad^0 ; 0; \quad ; \quad^0 ; 0; \quad) d_D(\quad^0) d_C(\quad^0)$$

$$k(\quad ; \quad ; \quad) = \int_{0;C}^{ZZ} :T_1(\quad ; \quad ; \quad^0)T_2(\quad ; \quad ; \quad^0) :_{0;C} \int_{\substack{p_3+n_3=2 \\ n_3 \geq 1}}^P K_0 \binom{0 0 p_3}{2 0 n_3} (0; 0; 0; \quad ; \quad^0 ; 0; \quad) d_C(\quad^0)$$

Here, each  $t_{ij}$  is a i-legged tail with at least four external legs, that, by Lemma II.31 and Proposition II.33, with  $\ell = 2$ , fulfills

$$N(t_{ij}) = \frac{4}{4} N(T_1) N(T_2) N(K)$$

Furthermore  $k$  has degree at least one in the variable  $\ell$  and degree three in the variables  $\ell'$ . By Lemma IX.2 and Proposition II.33 with  $\ell = 2$  and  $\ell$  replaced by  $2\ell$ ,

$$\begin{aligned} N_{\text{impr}} P Q(k)(\ell) &= \frac{2^5}{6} J N(k; 2) N(\ell; 4) \\ &= \frac{2^3}{10} J N(T_1; 2) N(T_2; 2) N(K; 2) N(\ell; 4) \end{aligned}$$

By Proposition V III.13

$$Q(T_1; T_2) Q(K; K)(\ell) = \int_{\mathbb{Z}} \mathcal{T}_1(\ell'; \ell) :_{\mathbb{C}} : g(\ell; 0; 0; \ell'; 0; 0) :_{\mathbb{C}} :_{\mathbb{D}} d_{\mathbb{D}}(\ell') d_{\mathbb{C}}(\ell) :_{\mathbb{C}}$$

where  $g = Q(T_2) Q(K; K)(\ell)$ . In particular

$$P Q(T_1; T_2) Q(K; K)(\ell) = P^0 \int_{\mathbb{Z}} \mathcal{T}_1(\ell'; \ell) :_{\mathbb{C}} : g(\ell; 0; 0; \ell'; 0; 0) :_{\mathbb{C}} :_{\mathbb{D}} d_{\mathbb{D}}(\ell') d_{\mathbb{C}}(\ell)$$

By Proposition IX.3

$$g(\ell; 0; 0; \ell'; 0; 0) = \mathfrak{g}_1(\ell'; \ell) + \mathfrak{g}_2(\ell'; \ell) + \mathfrak{g}(\ell'; \ell) + h(\ell'; \ell)$$

where

$$\mathfrak{g}_1(\ell'; \ell) = 2Q(\tilde{K}_1; K)(\ell)(\ell'; \ell)$$

$$\mathfrak{g}_2(\ell'; \ell) = 2Q(\tilde{K}_2; K)(\ell)(\ell'; \ell)$$

$$\mathfrak{g}(\ell'; \ell) = Q(\hat{K})(\ell)(\ell'; \ell)$$

and

$$N_{\text{impr}}(h) = \frac{2^9}{10} J N(\ell; 4) N(K; 4)^2 N(T_2; 2)$$

By Lemma II.31 and Proposition II.33, the improved norm of

$$\int_{\mathbb{Z}} \mathcal{T}_1(\ell'; \ell) :_{\mathbb{C}} : h(\ell'; \ell) :_{\mathbb{C}} :_{\mathbb{D}} d_{\mathbb{D}}(\ell') d_{\mathbb{C}}(\ell)$$

is bounded by

$$\frac{1}{2} N_{\text{impr}}(T_1) N_{\text{impr}}(h) = \frac{2^9}{12} J N(\ell; 4) N(K; 4)^2 N(T_1; \ell) N(T_2; 2)$$

Observe that  $\mathfrak{g}$  has degree at least six, so that

$$P^0 \int_{\mathbb{Z}\mathbb{Z}} \mathbb{T}_1(\cdot; \cdot; \cdot) :_{;C} \mathfrak{g}(\cdot; \cdot; \cdot) :_{;D} d_D(\cdot) d_C(\cdot) = 0$$

Similarly,  $\mathfrak{g}_2$  has degree at least five, so that

$$P^0 \int_{\mathbb{Z}\mathbb{Z}} \mathbb{T}_1(\cdot; \cdot; \cdot) :_{;C} \mathfrak{g}_2(\cdot; \cdot; \cdot) :_{;D} d_D(\cdot) d_C(\cdot) = 0$$

Finally, the contribution to  $\mathfrak{g}_1$  with {degree two and overall degree four is  $\mathfrak{g}_{11} + \mathfrak{g}_{12}$ , where

$$\mathfrak{g}_{11} = 2Q \int_{\mathbb{Z}\mathbb{Z}} \mathbb{T}_2(K; \cdot) :_{;C} K_0 \binom{P_1 \ 0 \ P_3}{n_1 \ 0 \ n_3}(\cdot; \cdot) :_{;D} d_D(\cdot) d_C(\cdot)$$

$$\mathfrak{g}_{12} = 2Q \int_{\mathbb{Z}\mathbb{Z}} p(\cdot; \cdot; \cdot) :_{;C} K_0 \binom{P_1 \ P_2 \ 0}{n_1 \ n_2 \ 1}(\cdot; \cdot) :_{;D} d_D(\cdot) d_C(\cdot)$$

where

$$p(\cdot; \cdot; \cdot) = \int_{\mathbb{Z}\mathbb{Z}} \mathbb{T}_2(\cdot; \cdot; \cdot) :_{;C} K_0 \binom{P_1 \ P_2 \ 0}{n_1 \ n_2 \ 1}(\cdot; \cdot; \cdot) :_{;D} d_D(\cdot) d_C(\cdot)$$

Then

$$P^0 \int_{\mathbb{Z}\mathbb{Z}} \mathbb{T}_1(\cdot; \cdot; \cdot) :_{;C} \mathfrak{g}_{11}(\cdot; \cdot; \cdot) :_{;D} d_D(\cdot) d_C(\cdot) = 2PQ (\mathbb{T}_1(K; \cdot) :_{;C} \mathbb{T}_2(K; \cdot) :_{;D} d_D(\cdot) d_C(\cdot))$$

while

$$P^0 \int_{\mathbb{Z}\mathbb{Z}} \mathbb{T}_1(\cdot; \cdot; \cdot) :_{;C} \mathfrak{g}_{12}(\cdot; \cdot; \cdot) :_{;D} d_D(\cdot) d_C(\cdot) = PQ(\cdot) :_{;D} d_D(\cdot) d_C(\cdot)$$

with the two-legged tail, with four external legs and degree two in  $\cdot$ ,

$$= 2 \int_{\mathbb{Z}\mathbb{Z}} p(\cdot; \cdot; \cdot) p^0(\cdot; \cdot; \cdot) d_D(\cdot) d_C(\cdot)$$

where  $p$  was defined above and

$$p^0(\cdot; \cdot; \cdot) = \int_{\mathbb{Z}\mathbb{Z}} \mathbb{T}_1(\cdot; \cdot; \cdot) :_{;C} K_0 \binom{P_1 \ P_2 \ 0}{n_1 \ n_2 \ 1}(\cdot; \cdot; \cdot) :_{;D} d_D(\cdot) d_C(\cdot)$$

By Lemma II.31 and Proposition II.33,

$$N(p) = \frac{1}{2} N(\mathbb{T}_2) N(K)$$

$$N(p^0) = \frac{1}{2} N(\mathbb{T}_1) N(K)$$

By Lemma II.31 and Proposition II.33, with  $\ell = 2$ ,

$$N(\cdot; \cdot; \cdot) :_{;C} h(\cdot; \cdot; \cdot) :_{;D} d_D(\cdot) d_C(\cdot) = \frac{8}{4} N(p) N(p^0) N(h) - \frac{8}{8} N(\mathbb{T}_1) N(\mathbb{T}_2) N(K)^2 N(h)$$

for all Grassmann functions  $h$ . A similar estimate applies for the  $N_{\text{in } p, r}$  norm so that

$$N_e(\cdot) = \frac{8}{8} N(\mathbb{T}_1) N(\mathbb{T}_2) N(K)^2$$



Lemma IX.12 Assume that  $K$  has degree at most two in the variables  $0;';0;$ . Let  $T$  be a one-legged tail with at least three external legs. Then there is a two-legged tail  $t_2$  with at least four external legs such that for all Grassmann functions  $f(;;)$

$$P Q (T) Q_K ( :f : ) = P Q (t_2) ( :f : )$$

and

$$N (t_2) = \frac{2}{2} N (T) N (K)$$

Proof: The proof is similar to that of Lemma VII.13. Since  $T$  is one-legged and  $K$  has degree at least four

$$\begin{aligned} P Q (T) Q_K &= P Q (T) Q (K) \\ &= P Q (T) Q \sum_{p_3+n_3=2}^P K_1 \begin{pmatrix} 0 & 0 & p_3 \\ 1 & 0 & n_3 \end{pmatrix} = P Q (t_2) \end{aligned}$$

with

$$t_2 ( ;' ; ) = \sum T ( ;' ;^0 ) K_1 \begin{pmatrix} 0 & 0 & 1 \\ 1 & 0 & 1 \end{pmatrix} ( ;0;0;' ;^0;0; ) + K_1 \begin{pmatrix} 0 & 0 & 0 \\ 1 & 0 & 2 \end{pmatrix} ( ;0;0;0;^0;0; ) d_c (^0)$$

■

Definition IX.13 The two-legged tails  $T_\backslash(K)$  are recursively defined as follows:  $T_1(K)$  was defined in Lemma IX.10, and

$$T_{\backslash+1}(K) = T_\backslash(K) \quad \text{for } \backslash \geq 1$$

Remark IX.14

(i) Clearly  $T_\backslash(K)$  has two external legs. Using Lemma II.31 and Proposition II.33 one proves by induction that for  $\backslash \geq 2$

$$N (T_\backslash(K)) = \frac{1}{2^{\backslash-2}} N (K)$$

(ii) If  $K(;;^0;' ;^0;) = U(+ +^0+' ; +^0+ ) U(+ +^0+' ; +^0)$  for some even Grassmann function  $U(;;)$  then, by Remark IX.6,  $T_\backslash(K) = T_\backslash( U )$ . Recall that  $T_\backslash( U )$  was defined in Definition VI.8.

### IX.3 Proof of Theorem VI.10 in the general case

First, we prove the analog of Proposition VII.16 for the enlarged algebra.

Proposition IX.15 Let  $K(x, y, z, w)$  be an even Grassmann function that vanishes for  $w = 0$  and has degree at least four overall. Set

$$K(x, y, z, w) = K(x + w, y, z, w)$$

Assume that  $n \geq 8$  and  $N(K; 4)_0 < \frac{2}{3}$ . Furthermore let  $f(x, y, z)$  be a Grassmann function. For each  $n \geq 1$  there exists a Grassmann function  $h_n(x, y, z)$ , a one-legged tail  $t_1$ , a two-legged tail  $t_2$ , each with at least three external legs and a two-legged tail  $(x', y')$  with at least four external legs and of degree two in  $x, y, z$  such that

$$\sum_{\mathbb{Z}} \text{EvR}_{\mathbb{K}; D; C}^n(f; D) = \sum_{\mathbb{Z}} \text{EvR}_{\mathbb{K}; D; C}^n(h_n(x, y, z)) + \frac{1}{2} \sum_{\substack{m \geq 0 \\ \text{max } l_i = 0 \\ \sum l_i = n}} \sum_{\mathbb{Z}} \text{EvR}_{\mathbb{K}; D; C}^m(Q_K(x, y, z); T^0(K)(x', y')) + \sum_{\mathbb{Z}} \text{EvR}_{\mathbb{K}; D; C}^m(Q_K(t_1 + t_2 + (x', y'))) + h_n(x, y, z)$$

and

$$\begin{aligned} N(t_1); N(t_2) &= 4 \frac{8}{2} \binom{n-1}{1} \frac{N(K; 4)^n}{1 - \frac{2}{2} N(K; 4)} & N_e(x, y, z) &= \frac{8}{2^n} \frac{N(K; 4)^{n+1}}{1 - \frac{2}{2} N(K; 4)} \\ N_{\text{impr}}(h_n(x, y, z)) &= \frac{2^{10} J}{5} \sum_{m=0}^{n-1} \frac{1}{n-m} \frac{N(K; 4)^{n-m}}{1 - \frac{2}{2} N(K; 4)} & N_{F_m}(x, y, z) &= 4 \end{aligned}$$

where

$$F_m(x, y, z) = \text{EvR}_{\mathbb{K}; D; C}^m(f; D)$$

Proof: Decompose

$$K = K^0 + K^{\infty}$$

where  $K^0$  has degree at most two in the variables  $x, y, z$  and  $K^{\infty}$  has degree at least three in these variables.

We perform induction on  $n$ . For  $n = 1$ , by Lemma VIII.12.ii

$$\text{EvR}_{\mathbb{K}; D; C}^1(f; D) = Q_K(f; C); D$$

and therefore  $\sum_{\mathbb{Z}}$

$$\text{EvR}_{\mathbb{K}; D; C}^1(f; D) = Q_K(f; C)(x, y, z)$$

Set

$$h_1(x, y, z) = P(Q_K(x, y, z))$$

By Proposition IX.1

$$N_{\text{impr}}(h_1(x, y, z)) = \frac{2^5 J}{6} N(f; 4) = \frac{N(K; 2)}{1 - \frac{2}{2} N(K; 2)}$$

Since  $K^0$  has degree at most two in the variables  $0;'; 0;$  and degree at least four overall

$$\begin{aligned} P Q_{K^0} &= P Q_{K^0} ( \begin{smallmatrix} 0 & 0 & 0 \\ 0 & 0 & 1 \end{smallmatrix} ) + K ( \begin{smallmatrix} 0 & 0 & 0 \\ 0 & 0 & 2 \end{smallmatrix} ) + K ( \begin{smallmatrix} 0 & 0 & 1 \\ 0 & 0 & 1 \end{smallmatrix} ) \\ &+ \frac{1}{2} P Q_{K^2} ( \begin{smallmatrix} 0 & 0 & 0 \\ 0 & 1 & 1 \end{smallmatrix} ) + K_2 ( \begin{smallmatrix} 0 & 1 & 0 \\ 0 & 0 & 1 \end{smallmatrix} ); K_2 ( \begin{smallmatrix} 0 & 0 & 0 \\ 0 & 1 & 1 \end{smallmatrix} ) + K_2 ( \begin{smallmatrix} 0 & 1 & 0 \\ 0 & 0 & 1 \end{smallmatrix} ) \\ &+ \frac{1}{2} P Q_{K^2} ( \begin{smallmatrix} 0 & 0 & 0 \\ 0 & 0 & 2 \end{smallmatrix} ) + K_2 ( \begin{smallmatrix} 0 & 0 & 1 \\ 0 & 0 & 1 \end{smallmatrix} ); K_2 ( \begin{smallmatrix} 0 & 0 & 0 \\ 0 & 0 & 2 \end{smallmatrix} ) + K_2 ( \begin{smallmatrix} 0 & 0 & 1 \\ 0 & 0 & 1 \end{smallmatrix} ) \\ &= P Q_{T_1(K)} + P Q_{(t_1 + t_2)} + \frac{1}{2} P Q_{T_1(K)}; T_1(K) \end{aligned}$$

with

$$\begin{aligned} t_1 &= K_3 ( \begin{smallmatrix} 0 & 0 & 0 \\ 0 & 0 & 1 \end{smallmatrix} ) + K_4 ( \begin{smallmatrix} 0 & 0 & 0 \\ 0 & 0 & 1 \end{smallmatrix} ) \\ t_2 &= K_3 ( \begin{smallmatrix} 0 & 0 & 0 \\ 0 & 0 & 2 \end{smallmatrix} ) + K_4 ( \begin{smallmatrix} 0 & 0 & 0 \\ 0 & 0 & 2 \end{smallmatrix} ) + K_3 ( \begin{smallmatrix} 0 & 0 & 1 \\ 0 & 0 & 1 \end{smallmatrix} ) + K_4 ( \begin{smallmatrix} 0 & 0 & 1 \\ 0 & 0 & 1 \end{smallmatrix} ) + \frac{1}{2} K_2 ( \begin{smallmatrix} 0 & 0 & 0 \\ 0 & 1 & 1 \end{smallmatrix} ) K_2 ( \begin{smallmatrix} 0 & 0 & 0 \\ 0 & 1 & 1 \end{smallmatrix} ) d_c ( ) \\ &= \frac{1}{2} K_2 ( \begin{smallmatrix} 0 & 1 & 0 \\ 0 & 0 & 1 \end{smallmatrix} ) K_2 ( \begin{smallmatrix} 0 & 1 & 0 \\ 0 & 0 & 1 \end{smallmatrix} ) d_D ( ) \end{aligned}$$

In particular

$$\begin{aligned} N(t_1) &= N(K) \\ N(t_2) &= N(K) + \frac{1}{2} N(K)^2 \\ N_e( ) &= \frac{1}{2} \frac{4}{2} N(K)^2 \end{aligned}$$

Proposition II.33, with  $\lambda = 1$ , was used to bound the last term of  $t_2$ . Lemma II.31 and Proposition II.33, with  $\lambda = 2$ , were used to bound  $( ; ; ) : ;_C h ; ; ; (1); (r); d_c ( )$  as in Definition IX.8.

Now assume that the statement of the Lemma is true for  $n$ . By Remark V III.6.ii

$$EVR_{K; ;_D; ;_C}^{n+1} (f; ;_C) = EVR_{K; ;_D; ;_C}^n (F_1( ; f); ;_C)$$

By Lemma V III.12.ii

$$F_1( ; f); ;_C = Q_K (f; ;_C)$$

The induction hypothesis therefore implies that

$$\begin{aligned} P EVR_{K; ;_D; ;_C}^{n+1} (f; ;_C) d_D ( ) &= P EVR_{K; ;_D; ;_C}^n (Q_K (f; ;_C); ;_D) d_D ( ) \\ &= h_n ( ; F_1( ; f)) + P Q_{T_n(K)} Q_K (f; ;_C) + \frac{1}{2} P Q_{T_n(K)}; T_n(K) Q_K (f; ;_C) \\ &\quad + P Q_{(t_1 + t_2 + )} Q_K (f; ;_C) \end{aligned}$$

with

$$N(t_1); N(t_2) = 4 \frac{8}{2} n^1 \frac{N(K)^n}{1 - \frac{1}{2} N(K)} \quad N_e( ) = \frac{8}{2n} \frac{N(K)^{n+1}}{1 - \frac{1}{2} N(K)}$$



and

$$N_{\text{impr}} h_n(\cdot; F_1(\cdot; f)) = \frac{2^{10} J}{5} \sum_{m=0}^{P-1} \frac{1}{n-m} \frac{N(K; 4)^{n-m}}{1 - \frac{3}{2} N(K; 4)^{n-m}} N_{F_m}(\cdot; F_1(\cdot; f); 4)$$

By Remark V III.6 ii

$$\begin{aligned} N_{F_m}(\cdot; F_1(\cdot; f)) &= \mathbb{E} \mathbb{V} R_{\mathbb{K}; \mathbb{D}; \mathbb{C}}^m(\cdot; F_1(\cdot; f)) \\ &= \mathbb{E} \mathbb{V} R_{\mathbb{K}; \mathbb{D}; \mathbb{C}}^m(\cdot; f) \\ &= \mathbb{E} \mathbb{V} R_{\mathbb{K}; \mathbb{D}; \mathbb{C}}^{m+1}(\cdot; f) \\ &= N_{F_{m+1}}(\cdot; f) \end{aligned}$$

Therefore

$$N_{\text{impr}} h_n(\cdot; F_1(\cdot; f)) = \frac{2^{10} J}{5} \sum_{m=1}^P \frac{1}{n+1-m} \frac{N(K; 4)^{n+1-m}}{1 - \frac{3}{2} N(K; 4)^{n+1-m}} N_{F_m}(\cdot; f; 4)$$

Let  $g_0$  be the difference between

$$\begin{aligned} & \mathbb{P} Q_{T_n(K)}(f; \mathbb{C}) + \frac{1}{2} \sum_{\substack{m \leq \max\{t_1, t_2\} \\ m \leq n}}^P Q_{T_n(K); T_0(K)}(f; \mathbb{C}) \\ & + Q_{(t_1 + t_2 + \dots)} Q_{\mathbb{K}}(f; \mathbb{C}) \end{aligned} \quad \text{i}$$

and

$$\begin{aligned} & \mathbb{P} Q_{T_n(K)}(f; \mathbb{C}) + \frac{1}{2} \sum_{\substack{m \leq \max\{t_1, t_2\} \\ m \leq n}}^P Q_{T_n(K); T_0(K)}(f; \mathbb{C}) \\ & + Q_{(t_1 + t_2 + \dots)} Q_{\mathbb{K}^0}(f; \mathbb{C}) \end{aligned} \quad \text{i}$$

Let  $f^0; \mathbb{D} = Q_{\mathbb{K}}(f; \mathbb{C}) - Q_{\mathbb{K}^0}(f; \mathbb{C})$ . By Lemma V III.14 and Definition IX.8

$$N_{\text{impr}}(g_0) = \frac{1}{2} N_{\text{impr}}(f^0; \mathbb{D}) + \frac{1}{2} \sum_{\substack{m \leq \max\{t_1, t_2\} \\ m \leq n}}^P N_{T_n(K)} + N_{T_0(K)} + N_{(t_1 + t_2 + \dots)}$$

if  $\epsilon$  is any effective bound for  $\epsilon$ . By Proposition IX.1, Remark IX.14 and the induction hypothesis,

$$\begin{aligned} N_{\text{impr}}(g_0) & \leq \frac{2^5 J}{7} N(f; 4) \frac{N(K; 2)}{1 - \frac{1}{2} N(K; 2)} + \frac{1}{2^{2n-2}} N(K)^n \left( 1 + 2 \sum_{i=1}^P \frac{N(K)^i}{2^i} \right) \\ & + 8 \frac{8}{2} n \frac{1}{1 - \frac{2}{2} N(K)} + \frac{8}{2^n} \frac{N(K)^{n+1}}{1 - \frac{1}{2} N(K)} \end{aligned} \quad \text{i}$$

Since

$$\begin{aligned}
 1 + 2 \frac{P_n}{v=1} \frac{N(K)'}{2^{v-1}} &= 1 + 2 \frac{P_n}{v=1} \frac{N(K)'}{2^v} = 1 + 2 \frac{\frac{1}{2}N(K)}{1 - \frac{1}{2}N(K)} = \frac{1 - \frac{1}{2}N(K) + \frac{2}{4}N(K)}{1 - \frac{1}{2}N(K)} \\
 &= \frac{1 - \frac{1}{8}N(K) + \frac{1}{4}N(K)}{1 - \frac{1}{2}N(K)} = \frac{8 \frac{1 - \frac{1}{8}N(K) + \frac{1}{4}N(K)}{1 - \frac{1}{2}N(K)}}{8 \frac{1}{1 - \frac{1}{2}N(K)} \frac{1}{1 + \frac{1}{8}N(K)} \frac{1}{\frac{1}{4}N(K)}} \\
 &= \frac{8 \frac{1}{1 - \frac{1}{4} + \frac{7}{8}N(K)}}{8 \frac{1}{1 - \frac{1}{2}N(K)}}
 \end{aligned}$$

we have

$$\begin{aligned}
 N_{\text{im pr}}(g_0) &= \frac{2^5 J}{7} N(f; 4) \frac{N(K; 2)^{n+1}}{1 - \frac{1}{2}N(K; 2)} \frac{h}{2^{2n-2}} \frac{1}{1 - \frac{1}{2}N(K)} + 8 \frac{8}{2} \frac{n-1}{1 - \frac{1}{2}N(K)} \frac{1}{1 - \frac{1}{2}N(K)} \\
 &= \frac{2^5 J}{7} N(f; 4) \frac{N(K; 2)^{n+1}}{1 - \frac{1}{2}N(K; 2)} \frac{h}{2^{2n-2}} \frac{1}{1 - \frac{1}{2}N(K)} + 8 \frac{8}{2} \frac{n-1}{1 - \frac{1}{2}N(K)} \frac{1}{1 - \frac{1}{2}N(K)} \\
 &= \frac{2^5 J}{n+6} N(f; 4) \frac{N(K; 2)^{n+1}}{1 - \frac{3}{2}N(K; 2)} [8 + 8] \\
 &= \frac{2^9 J}{n+6} N(f; 4) \frac{N(K; 2)^{n+1}}{1 - \frac{3}{2}N(K; 2)}
 \end{aligned}$$

By Lemma IX.10 and Remark II.24, there exists a one-legged tail  $t_{11}$ , a two-legged tail  $t_{21}$ , each with at least three external legs, and a two-legged tail  $t_1$  with at least four external legs and of degree two in  $\mathcal{K}$  such that

$$\begin{aligned}
 P_Q T_n(K) \circledast_{K^0} (f; c) &= P_Q T_{n+1}(K) \circledast_{K^0} (f; c) + P_Q T_{n+1}(K); T_1(K) \circledast_{K^0} (f; c) \\
 &\quad + P_Q (t_{11} + t_{21} + t_1) \circledast_{K^0} (f; c) + g_1(f; c)
 \end{aligned}$$

with

$$\begin{aligned}
 N_{\text{im pr}}(g_1) &= \frac{2^9 J}{8} N(f; 4) N(T_n(K); 2) N(K; 4) \frac{1}{1 - \frac{1}{2}N(K; 4)} \\
 &\quad - \frac{2^9 J}{2n+6} N(f; 4) N(K; 2)^n \frac{N(K; 4)}{1 - \frac{1}{2}N(K; 4)} \\
 &\quad - \frac{2^9 J}{2n+6} N(f; 4) \frac{N(K; 4)^{n+1}}{1 - \frac{1}{2}N(K; 4)}
 \end{aligned}$$

and

$$\begin{aligned}
 N(t_{11}); N(t_{21}) &= \frac{2}{2} N(T_n(K)) N(K) - \frac{2}{2n} N(K)^{n+1} \\
 N_e(t_1) &= \frac{4}{4} N(T_n(K)) N(K)^2 - \frac{4}{2n+2} N(K)^{n+2}
 \end{aligned}$$

Similarly, for  $1 \leq n$ , by Lemma IX.11, there exists a one-legged tail  $t_{12}^{(1)}$  and a two-legged tail  $t_{22}^{(1)}$ , each with at least three external legs, and a two-legged tail  $t_1^{(1)}$  with at least four external legs and of degree two in  $\mathcal{K}$  such that

$$\begin{aligned}
 P_Q T_n(K); T_n(K) \circledast_{K^0} (f; c) &= P_Q T_{n+1}(K); T_{n+1}(K) \circledast_{K^0} (f; c) \\
 &\quad + P_Q (t_{12}^{(1)} + t_{22}^{(1)} + t_1^{(1)}) \circledast_{K^0} (f; c) + g_2^{(1)}(f; c)
 \end{aligned}$$

with

$$N_{\text{im pr}}(\mathcal{G}_2; \cdot) = \frac{2^9 J}{10} N(f; 4) N(T_n(K); 2) N(T, (K); 2) N(K; 4) \left(1 + \frac{1}{2} N(K; 4)\right) \\ - \frac{2^9 J}{2n+6} N(f; 4) N(K; 2)^n - \frac{1}{2} N(K; 2) \cdot \frac{N(K; 4)}{1 - \frac{1}{2} N(K; 4)} \\ - \frac{2^9 J}{2n+6} N(f; 4) - \frac{1}{2} N(K; 2) \cdot \frac{N(K; 4)^{n+1}}{1 - \frac{1}{2} N(K; 4)}$$

and

$$N_{t_{12}}^{(\cdot)}; N_{t_{22}}^{(\cdot)} = \frac{12}{4} N(K) N(T_n(K)) N(T, (K)) - \frac{12}{2(n+1)} N(K)^{n+1} + 1 \\ N_e^{(\cdot)} = \frac{8}{6} N(K)^2 N(T_n(K)) N(T, (K)) - \frac{8}{2(n+1)+2} N(K)^{n+1} + 2$$

In particular

$$N_{\text{im pr}} \mathcal{G}_1 + \sum_{i=1}^n N_{\text{im pr}} \mathcal{G}_2; \cdot = \frac{2^9 J}{2n+6} N(f; 4) \frac{N(K; 4)^{n+1}}{1 - \frac{1}{2} N(K; 4)} \frac{1}{1 - \frac{1}{2} N(K; 2)} \\ - \frac{2^9 J}{2n+6} N(f; 4) \frac{N(K; 4)^{n+1}}{1 - \frac{1}{2} N(K; 4)} \\ N_{t_{11}} + \sum_{i=1}^n N_{t_{12}}^{(\cdot)}; N_{t_{21}} + \sum_{i=1}^n N_{t_{22}}^{(\cdot)} = \frac{12}{2n} \frac{N(K)^{n+1}}{1 - \frac{1}{2} N(K)} \\ N_e = 1 + \sum_{i=1}^n \frac{1}{2} N_e^{(i)} + \frac{1}{2} N_e^{(n)} = \frac{8}{2n+2} \frac{N(K)^{n+2}}{1 - \frac{1}{2} N(K)}$$

By Lemma IX.12, there exists a two-legged tail  $t_{23}$  with at least four external legs such that

$$\begin{matrix} h & & i & & h & & i \\ P & Q & (t_1) & Q & K^0 & (f; \cdot; c) & = & P & Q & (t_{23}) & (f; \cdot; c) \end{matrix}$$

and, by the induction hypothesis,

$$N(t_{23}) = \frac{2}{2} N(t_1) N(K)$$

Also, by Lemma IX.10

$$\begin{matrix} h & & i & & h & & i \\ P & Q & (t_2) & Q & K^0 & (f; \cdot; c) & = & P & Q & (t_{14} + t_{24} + t_{25}) & (f; \cdot; c) & + & \mathcal{G}_3 \end{matrix}$$

where  $t_{14}; t_{24}$  are one- resp. two-legged tails with at least three external legs, fulfilling

$$N(t_{14}); N(t_{24}) = \frac{2}{2} N(t_2) N(K)$$

$t_{25} = t_2 - K^0$  is a two-legged tail with at least four external legs fulfilling

$$N(t_{25}) = \frac{1}{2} N(t_2) N(K)$$

and the  $g_3$  term obeys

$$\begin{aligned} N_{\text{in pr } g_3} &= \frac{2^9 J}{8} N(f; 4) N(t_2; 2) N(K; 4) \left(1 + \frac{1}{2} N(K; 4)\right) \\ &= \frac{2^9 J}{8} N(f; 4) \left(1 - \frac{2}{2}\right)^{n-1} \frac{N(K; 2)^n}{1 - \frac{1}{2} N(K; 2)} \frac{N(K; 4)}{1 - \frac{1}{2} N(K; 4)} \\ &= \frac{2^{n+10} J}{2^{n+6}} N(f; 4) \frac{N(K; 4)^{n+1}}{1 - \frac{2}{2} N(K; 4)} \end{aligned}$$

Here we have used that  $Q_{t_2}(K; T_1(K))(\mathbf{f}; \cdot)$  has at least two external legs so that

$$P Q_{t_2}(K; T_1(K))(\mathbf{f}; \cdot) = 0$$

For the same reason, the term  $\backslash P Q(\cdot)(\mathbf{f}; \cdot)$  of Lemma IX.10 also vanishes.

Finally, by Lemma IX.10,

$$P Q(\cdot) Q_{K^0}(\mathbf{f}; \cdot) = P Q(t_{26})(\mathbf{f}; \cdot)$$

where  $t_{26} = K^0$  is a two-legged tail with at least four external legs. By Definition IX.8,  $N(t_{26}) = \frac{1}{2} N(K)$  for any effective bound for  $\cdot$ . Hence, by the induction hypothesis

$$N(t_{26}) = \frac{1}{2} \frac{8}{2^n} \frac{N(K)^{n+1}}{1 - \frac{1}{2} N(K)} N(K) = \frac{8}{2^{n+2}} \frac{N(K)^{n+2}}{1 - \frac{1}{2} N(K)}$$

Combining the results above, we see that

$$\begin{aligned} Z &= P \text{ Ev } R_{K; D}^{n+1}(\mathbf{f}; \cdot) = P Q_{T_{n+1}(K)}(\mathbf{f}; \cdot) \\ &+ \frac{1}{2} P_{\text{max } \mathbf{f}; \cdot^0 = n+1} P Q_{T(K); T^0(K)}(\mathbf{f}; \cdot) + P Q(t_1^0 + t_2^0 + \cdot^0)(\mathbf{f}; \cdot) + h_{n+1}(\cdot; \mathbf{f}) \end{aligned}$$

with

$$h_{n+1}(\cdot; \mathbf{f}) = h_n(\cdot; F_1(\cdot; \mathbf{f})) + g_0(\cdot) + g_1(\cdot) + \frac{1}{2} g_{2,m}(\cdot) + \sum_{\nu=1}^{\mathbb{P}^1} g_{2,\nu}(\cdot) + g_3$$

one- resp. two-legged tails with at least three external legs

$$\begin{aligned} t_1^0 &= t_{11} + \frac{1}{2} t_{12}^{(n)} + \sum_{\nu=1}^{\mathbb{P}^1} t_{12}^{(\nu)} + t_{14} \\ t_2^0 &= t_{21} + \frac{1}{2} t_{22}^{(n)} + \sum_{\nu=1}^{\mathbb{P}^1} t_{22}^{(\nu)} + t_{23} + t_{24} + t_{25} + t_{26} \end{aligned}$$

and the two-legged tail with four external legs and degree two in

$$t_0 = t_1 + \frac{1}{2} t_2^{(n)} + \sum_{\nu=1}^{\mathbb{P}^1} t_2^{(\nu)}$$

By the estimates obtained above

$$\begin{aligned}
 N(t_1^0); N(t_2^0) &= \frac{12}{2^n} \frac{N(K)^{n+1}}{1 - \frac{1}{2}N(K)} + \frac{1}{2} N(K) 2N(t_1) + 2N(t_2) + N(t_2) + \frac{8}{2^{n+2}} \frac{N(K)^{n+2}}{1 - \frac{1}{2}N(K)} \\
 &= \frac{12}{2^n} \frac{N(K)^{n+1}}{1 - \frac{1}{2}N(K)} \left( 1 + \frac{2}{3} N(K) + \frac{5}{2} N(K) \right) + \frac{8}{2^{n+2}} \frac{N(K; )^n}{1 - \frac{1}{2}N(K; )} \\
 &= \frac{12}{2^n} \frac{N(K)^{n+1}}{1 - \frac{1}{2}N(K)} + \frac{5}{2} \frac{8}{2^n} \frac{N(K; )^{n+1}}{1 - \frac{1}{2}N(K; )} \\
 &= \frac{12}{8^n} + \frac{5}{2} \frac{8}{2^n} \frac{N(K; )^{n+1}}{1 - \frac{1}{2}N(K; )} \\
 N_e(0) &= \frac{8}{2^{n+2}} \frac{N(K)^{n+2}}{1 - \frac{1}{2}N(K)}
 \end{aligned}$$

and

$$\begin{aligned}
 N_{\text{im pr}}(g_0) + N_{\text{im pr}}(g_1) + \sum_{i=1}^n N_{\text{im pr}}(g_2; \cdot) + N_{\text{im pr}}(g_3) \\
 = \frac{2^9 J}{n+6} N(f; 4) \frac{N(K; 4)^{n+1}}{1 - \frac{3}{2}N(K; 4)} \left( 1 + \frac{1}{n} + \frac{2^{n+1}}{n} \right) \\
 + \frac{2^{10} J}{n+6} N(f; 4) \frac{N(K; 4)^{n+1}}{1 - \frac{3}{2}N(K; 4)}
 \end{aligned}$$

so that

$$\begin{aligned}
 N_{\text{im pr}} h_{n+1}(\cdot; f) \\
 = N_{\text{im pr}} h_n(\cdot; F_1(\cdot; f)) + N_{\text{im pr}}(g_0) + N_{\text{im pr}}(g_1) + \sum_{i=1}^n N_{\text{im pr}}(g_2; \cdot) + N_{\text{im pr}}(g_3) \\
 = \frac{2^{10} J}{5} \sum_{m=1}^n \frac{1}{n+1-m} \frac{N(K; 4)^{n+1-m}}{1 - \frac{3}{2}N(K; 4)} N(F_m(\cdot; f); 4) \\
 + \frac{2^{10} J}{n+6} N(f; 4) \frac{N(K; 4)^{n+1}}{1 - \frac{3}{2}N(K; 4)} \\
 + \frac{2^{10} J}{5} \sum_{m=0}^n \frac{1}{n+1-m} \frac{N(K; 4)^{n+1-m}}{1 - \frac{3}{2}N(K; 4)} N(F_m(\cdot; f); 4)
 \end{aligned}$$

since  $F_0(\cdot; f) = f$ . ■

Corollary IX.16 Let  $K(\cdot; \cdot; \cdot; \cdot; 0)$  be a Grassmann function that vanishes for  $\cdot = 0$  and has degree at least four overall. Furthermore let  $f(\cdot; \cdot; \cdot)$  be a Grassmann function of degree at least four in the variables  $\cdot; \cdot; \cdot$ . Set

$$\begin{aligned}
 h(\cdot) = \int_{\mathbb{P}^1} \frac{1}{\prod_{\mathbb{R}: \cdot, \cdot} \mathbb{R}_{\mathbb{K}: \cdot, \cdot}} (\cdot; \cdot; \cdot; \cdot; \cdot) d_D(\cdot) = \int_{\mathbb{P}^1} \frac{1}{\prod_{\mathbb{R}: \cdot, \cdot} \mathbb{R}_{\mathbb{K}: \cdot, \cdot}} (\cdot; \cdot; \cdot; \cdot; \cdot) d_D(\cdot) \\
 + \int_{\mathbb{P}^1} \frac{1}{\prod_{\mathbb{R}: \cdot, \cdot} \mathbb{R}_{\mathbb{K}: \cdot, \cdot}} (\cdot; \cdot; \cdot; \cdot; \cdot) d_D(\cdot) \\
 + \int_{\mathbb{P}^1} \frac{1}{\prod_{\mathbb{R}: \cdot, \cdot} \mathbb{R}_{\mathbb{K}: \cdot, \cdot}} (\cdot; \cdot; \cdot; \cdot; \cdot) d_D(\cdot)
 \end{aligned}$$

If  $8 \text{ and } N(K; 16)_0 < \frac{1}{3}$ , then

$$N_{\text{impr}}(h) = \frac{2^{10} J}{6} N(f; 16) \frac{N(K; 16)}{1 - \frac{3}{2} N(K; 16)}$$

If  $K(\dots; 0) = \hat{U}(\dots; 0) \hat{U}(\dots; 0)$ ,  $8 \text{ and } N(\hat{U}; 32)_0 < \frac{1}{3}$ , then

$$N_{\text{impr}}(h) = \frac{2^{10} J}{6} N(f; 16) \frac{N(\hat{U}; 16)}{1 - \frac{3}{2} N(\hat{U}; 32)}$$

Proof: By Proposition IX.15

$$\begin{aligned} P \text{ Ev} \frac{1}{\mathbb{1} R_{\mathbb{K}; \mathcal{D}; \mathcal{C}}} (f; \mathcal{C})_{\mathcal{D}} &= P \text{ Ev} R_{\mathbb{K}; \mathcal{D}; \mathcal{C}} (f; \mathcal{C})_{\mathcal{D}} \\ &= \sum_{i=1}^P P Q T(\mathbb{K})(f; \mathcal{C}) + \frac{1}{2} \sum_{i=1}^P P Q T(\mathbb{K}); T^0(\mathbb{K})(f; \mathcal{C}) \\ &\quad + \sum_{i=1}^P h(\dots; f) + P Q (t_1 + t_2)(f; \mathcal{C}) \end{aligned}$$

with a one-legged tail  $t_1$  and a two-legged tail  $t_2$ , each with at least three external legs. As the degree of  $f$  is at least four,  $P Q (t_1 + t_2)(f; \mathcal{C}) = 0$ . Set  $h(\dots) = \sum_{i=1}^P h(\dots; f)$ . Then,

$$N_{\text{impr}}(h) = \frac{2^{10} J}{5} \sum_{m=0}^P \frac{1}{m} \frac{N(\mathbb{K}; 4)^m}{1 - \frac{3}{2} N(\mathbb{K}; 4)} N F_m(\dots; f); 4$$

Define  $F_m(\dots; f)$  by

$$F_m(\dots; f)_{\mathcal{C}} = \text{Ev} R_{\mathbb{K}; \mathcal{D}; \mathcal{C}}^m (f; \mathcal{C})_{\mathcal{D}}$$

Then, by Remark II.24, followed by Lemma V.III.8 and Lemma III.8

$$\begin{aligned} N F_m(\dots; f); 4 &= N F_m(\dots; f); 8 \\ &= \frac{1}{32 \cdot 2} \frac{1}{1 - \frac{3}{2} N(\mathbb{K}; 8)} \frac{N(\mathbb{K}; 8)^m}{1 - \frac{3}{2} N(\mathbb{K}; 8)} N(f; 8) \end{aligned}$$

so that

$$\begin{aligned} N_{\text{impr}}(h) &= \frac{2^{10} J}{5} \sum_{m=0}^P \frac{1}{m} \frac{N(\mathbb{K}; 4)^m}{1 - \frac{3}{2} N(\mathbb{K}; 4)} \frac{1}{1 - \frac{3}{2} N(\mathbb{K}; 8)} \frac{N(\mathbb{K}; 8)^m}{1 - \frac{3}{2} N(\mathbb{K}; 8)} N(f; 16) \\ &= \frac{2^{10} J}{5} \sum_{p=1}^P \sum_{m=0}^p \frac{1}{p} \frac{N(\mathbb{K}; 4)^p}{1 - \frac{3}{2} N(\mathbb{K}; 4)} \frac{1}{1 - \frac{3}{2} N(\mathbb{K}; 8)} \frac{N(\mathbb{K}; 8)^m}{1 - \frac{3}{2} N(\mathbb{K}; 8)} N(f; 16) \\ &= \frac{2^{10} J}{6} \frac{N(\mathbb{K}; 4)}{1 - \frac{3}{2} N(\mathbb{K}; 4)} \frac{1}{1 - \frac{3}{2} N(\mathbb{K}; 4)} \frac{1}{1 - \frac{1}{32 \cdot 2} N(\mathbb{K}; 8)} \frac{1}{1 - \frac{1}{32 \cdot 2} N(\mathbb{K}; 8)} N(f; 16) \\ &= \frac{2^{10} J}{6} \frac{N(\mathbb{K}; 4)}{1 - \frac{3}{2} N(\mathbb{K}; 4)} \frac{1}{1 - \frac{3}{2} N(\mathbb{K}; 4)} \frac{1}{1 - \frac{1}{16 \cdot 2} N(\mathbb{K}; 8)} N(f; 16) \\ &= \frac{2^{10} J}{6} \frac{N(\mathbb{K}; 16)}{1 - \frac{3}{2} N(\mathbb{K}; 16)} \frac{1}{1 - \frac{3}{2} N(\mathbb{K}; 16)} \frac{1}{1 - \frac{1}{16 \cdot 2} N(\mathbb{K}; 16)} N(f; 16) \\ &= \frac{2^{10} J}{6} \frac{N(\mathbb{K}; 16)}{1 - \frac{3}{2} N(\mathbb{K}; 16)} N(f; 16) \end{aligned}$$

If

$$K(\cdot; \cdot; \cdot; \cdot; 0) = \hat{U}(\cdot; \cdot; \cdot; 0) \hat{U}(\cdot; \cdot; \cdot; 0)$$

so that

$$\begin{aligned} K(\cdot; \cdot; \cdot; 0; \cdot; \cdot; \cdot; 0) &= K(\cdot; \cdot; \cdot; 0; \cdot; \cdot; \cdot; 0) \\ &= \hat{U}(\cdot; \cdot; \cdot; 0; \cdot; \cdot; \cdot; 0) \hat{U}(\cdot; \cdot; \cdot; 0; \cdot; \cdot; \cdot; 0) \end{aligned}$$

and

$$\mathbb{K}(\cdot; \cdot; \cdot; 0):_{\mathcal{D}} = \int \hat{U}(\cdot; \cdot; \cdot; 0; \cdot; \cdot; \cdot; 0) \hat{U}(\cdot; \cdot; \cdot; 0; \cdot; \cdot; \cdot; 0) d_{\mathcal{D}}(\cdot)$$

then, by Lemma II.31 and Remark II.24

$$\begin{aligned} N(\mathbb{K}; 4) &= N(\hat{U}; 16) \\ N(\mathbb{K}:_{\mathcal{D}}; 8) &= N(\hat{U}; 32) \end{aligned}$$

Consequently

$$\begin{aligned} N_{\text{im pr}}(h) &= \frac{2^{10} J}{6} \frac{N(\mathbb{K}; 4)}{1 - \frac{1}{N(\mathbb{K}; 4)}} \frac{1}{1 - \frac{3}{2} N(\mathbb{K}; 4)} \frac{1}{1 - \frac{1}{16} N(\mathbb{K}:_{\mathcal{D}}; 8)} N(f; 16) \\ &= \frac{2^{10} J}{6} \frac{N(\hat{U}; 16)}{1 - \frac{1}{N(\hat{U}; 32)}} \frac{1}{1 - \frac{3}{2} N(\hat{U}; 32)} \frac{1}{1 - \frac{1}{16} N(\hat{U}; 32)} N(f; 16) \\ &= \frac{2^{10} J}{6} \frac{N(\hat{U}; 16)}{1 - \frac{3}{N(\hat{U}; 32)}} \end{aligned}$$

■

Proof of Theorem VI.10: Set

$$K(\cdot; \cdot; \cdot; \cdot; 0) = \hat{U}(\cdot; \cdot; \cdot; 0) \hat{U}(\cdot; \cdot; \cdot; 0)$$

and

$$\begin{aligned} K(\cdot; \cdot; \cdot; 0; \cdot; \cdot; \cdot; 0) &= K(\cdot; \cdot; \cdot; 0; \cdot; \cdot; \cdot; 0) \\ &= \hat{U}(\cdot; \cdot; \cdot; 0; \cdot; \cdot; \cdot; 0) \hat{U}(\cdot; \cdot; \cdot; 0; \cdot; \cdot; \cdot; 0) \\ f(\cdot; \cdot) &= \hat{f}(\cdot; \cdot) \end{aligned}$$

By Proposition V.III.9

$$S_{U;C}(f) = S_{U;C}(\hat{f}(\cdot; 0):_{\mathcal{D}}) = \int \mathbb{E}_{\mathbb{R}^{\mathbb{K}:_{\mathcal{D}}; C}} \frac{1}{\mathbb{R}^{\mathbb{K}:_{\mathcal{D}}; C}} (\hat{f}:_{\mathcal{D}}) d_C(\cdot) d_D(\cdot):_{\mathcal{D}}$$

so that

$$P f^0 = P \int \mathbb{E}_{\mathbb{R}^{\mathbb{K}:_{\mathcal{D}}; C}} \frac{1}{\mathbb{R}^{\mathbb{K}:_{\mathcal{D}}; C}} (\hat{f}:_{\mathcal{D}}) d_D(\cdot)$$

Therefore, by Corollary IX.16 and Remark II.24, there is  $g(\cdot)$  with

$$P f^0 = P \hat{f}^h(\cdot; 0) + \sum_{i=1}^P Q_{T, (K)}(\cdot; \mathbb{C}) + \frac{1}{2} \sum_{i=0}^P Q_{T, (K); T_0(K)}(\cdot; \mathbb{C}) + g$$

and

$$N_{\text{im pr}}(g) = \frac{2^{10} J}{6} \frac{N(\hat{U}; 32)}{1 - 2N(\hat{U}; 32)} N_{\hat{f}; 16}$$

$$\frac{2^{10} J}{6} \frac{N(\hat{U}; 32)}{1 - 2N(\hat{U}; 32)} N_{\hat{f}; 32}$$

Since  $\hat{f}$  and  $K$  have degree at least four overall,

$$P Q_{T, (K)}(\cdot; \mathbb{C}) = T, (K) \quad \mathbb{T}_1(\hat{f})$$

and by Remark VI.9

$$P Q_{T, (K); T_0(K)}(\cdot; \mathbb{C}) = T, (K) \quad \text{Rung}(\hat{f}) \quad T_0(K)$$

Furthermore, by part (ii) of Remark IX.14,  $T, (K) = T, (\hat{U})$ . Thus

$$P f^0 = P \hat{f}^h(\cdot; 0) + \sum_{i=1}^P T, (\hat{U}) \quad \mathbb{T}_1(\hat{f}) + \frac{1}{2} \sum_{i=0}^P T, (\hat{U}) \quad \text{Rung}(\hat{f}) \quad T_0(\hat{U}) + g$$

■



## X . Example: A Vector Model

We consider a model, which while simple, still captures the main features of one scale of a many fermion model. Let  $F$  be a finite set of at least two "colours" (Farben) and  $X$  be a finite set of points in  $\mathbb{R}^n$ . Let  $V$  be the complex vector space with basis  $\{c_i; x \in F; x \in X\}$  and  $V^0$  be the complex vector space with basis  $\{c_i; x \in F; x \in X\}$ . Let  $C(x; x^0); x; x^0 \in X$  be a skew symmetric matrix and define the covariance

$$C_{c_i; x; c_j; x^0} = c_j c_i^0 C(x; x^0)$$

An antisymmetric function  $W$  on  $(F \times X)^n$ , with  $n$  even, is said to be colour preserving if it is of the form

$$W(c_1; x_1; \dots; c_n; x_n) = \text{Ant}_{c_1; c_2, \dots, c_n} W(x_1; \dots; x_n) \quad (X.1)$$

where  $\text{Ant}$  means antisymmetrization. An example, with  $n = 2$ , is the function  $c_j c_i^0 C(x; x^0)$ . An even element  $W$  of the Grassmann algebra  $\bigwedge V$  is said to be colour preserving if it is of the form

$$W = \sum_{\substack{n \geq 2 \\ c_1; \dots; c_n \\ x_1; \dots; x_n}} W_n(c_1; x_1; \dots; c_n; x_n)$$

with each coefficient function  $W_n$  colour preserving.

For  $p$  odd, we define the  $(0\text{-dimensional})$  norm  $\| \cdot \|_p$  of a complex valued function  $f$  on  $(F \times X)^n$  by

$$\|f\|_p = \left( \max_{c_1; \dots; c_n} \sup_{x_1; \dots; x_n} |f(c_1; x_1; \dots; c_n; x_n)|^p \right)^{1/p}$$

Also, for a colour preserving function  $W$  on  $(F \times X)^n$ , we define

$$\|W\| = \inf_{c_1; \dots; c_n} \sup_{x_1; \dots; x_n} |W(c_1; x_1; \dots; c_n; x_n)|$$

Then

$$\|W\|_p = \left( \sum_{j=1}^n \|W_j\|^{p-1} \|W_j\| \right)^{1/p} \quad (X.2)$$

In particular, if  $n = 4$ ,

$$\|W\|_1 = \sum_{j=1}^4 \|W_j\|$$

Every element  $f \in V^n$  has a unique representation

$$f = \sum_{x \in X} f(x) \delta_x$$

with  $f$  a complex valued function on  $(\mathbb{F} \setminus X)^n$ . We set

$$\|f\|_p = \|f\|_p$$

Observe that, for each odd  $p$ ,  $\|\cdot\|_p$  is a family of symmetric norms on the spaces  $V^n$ , in the sense of Definition II.18.

Proposition X.1 Suppose that  $X$  is a disjoint union of two subsets  $X_a$  and  $X_c$  such that

$$f(x) = 0 \quad \text{if both } x \in X_a \text{ or both } x \in X_c$$

Assume furthermore that there is a Hilbert space  $H$  and vectors  $w_x \in H$ ;  $x \in X$  such that

$$f(x) = \langle w_x, w_{x^0} \rangle_H \quad \text{for all } x \in X_a; x^0 \in X_c$$

Set

$$b = \sup_{x \in X} \|w_x\|$$

$$c = \sup_{x \in X} |f(x)|$$

Then  $(C; 0)$  has integration constants  $c; b$  for the configuration  $\| \cdot \|$  of seminorms, in the sense of Definition VI.13.

Proof: We first verify that  $b$  is an integral bound for  $C$  with respect to each family  $\| \cdot \|$  of seminorms. Set

$$H^0 = L^2(\mathbb{F}) \otimes H$$

$$w_{c;x}^0 = \delta_c \otimes w_x$$

where  $\delta_c$  is the function on  $\mathbb{F}$  which vanishes except at  $c$  and takes the value one there. Then, for all  $c; c^0 \in \mathbb{F}$ ,

$$C(c; c^0) = 0 \quad \text{if both } c \in X_a \text{ or both } c \in X_c$$

and

$$C(c; c^0) = \langle w_{c;x}^0, w_{c^0;x^0}^0 \rangle_{H^0} = \langle \delta_c \otimes w_x, \delta_{c^0} \otimes w_{x^0} \rangle_{H^0} \quad \text{for all } x \in X_a; x^0 \in X_c$$

Furthermore

$$\|k_{C;X}^0\|_{k_H} = \|k_{X;X}\|_{k_H} = \frac{b}{2}$$

Let  $V_c$  (respectively  $V_a$ ) be the subspace of  $V$  generated by  $\{c; x \mid x \in X_c; c \in F\}$  (respectively  $\{c; x \mid x \in X_a; c \in F\}$ ). By Proposition B.1,

$$\|Z\|_{C;X_1, C_m;X_m} = \|d_C\| = \frac{b}{2}^m$$

As in Example II.26,  $b$  is an integral bound for  $C$  with respect to each family  $\{k\}$  of seminorms.

Also

$$\sup_{\substack{c; c \in F \\ x; x \in X}} C(c; x^0) = \sup_{x; x \in X} \mathcal{J}(x; x^0) = \sup_{x; x \in X} \|k_{X;X}\|_{k_H} = \frac{b^2}{4} \quad (X.3)$$

We now verify the contraction estimates of Definition VI.13. Let

$$f = \mathcal{J}(c_1; x_1); \dots; (c_n; x_n) \in C; c_1 \in F, \dots, c_n \in F, x_1 \in X, \dots, x_n \in X \subset V^n$$

$$f^0 = \mathcal{J}^0(c_1; x_1); \dots; (c_n^0; x_n^0) \in C; c_1 \in F, \dots, c_n^0 \in F, x_1 \in X, \dots, x_n^0 \in X \subset V^{n^0}$$

and, for  $1 \leq k \leq n$  and  $1 \leq k^0 \leq n^0$ ,

$$\|k(c_1; \dots; c_n)\|_{k^0} = \sup_{\substack{x_k \in X \\ \dots \\ x_1 \in X \\ i \in k}} \mathcal{J}(c_1; x_1); \dots; (c_n; x_n)$$

$$\|k^0(c_1^0; \dots; c_n^0)\|_{k^0} = \sup_{\substack{x_k^0 \in X \\ \dots \\ x_1^0 \in X \\ i \in k^0}} \mathcal{J}^0(c_1^0; x_1^0); \dots; (c_n^0; x_n^0)$$

Observe that, for all  $1 \leq k \leq n$ , all  $1 \leq i_1 < \dots < i_p \leq n$  and all  $c_{i_1}; \dots; c_{i_p} \in F$

$$\|k(c_{i_1}; \dots; c_{i_p})\|_{k^0} = \|k^0(c_{i_1}^0; \dots; c_{i_p}^0)\|_{k^0} = \|k\|_{k^0} = \|k^0\|_{k^0}$$

and similarly for  $k^0$ .

For the first contraction estimate of Definition VI.13, let  $1 \leq i \leq n$  and  $1 \leq j \leq n^0$ . By the symmetry of the norms, it suffices to consider  $i = j = 1$ . Set

$$\|(c_2; x_2); \dots; (c_n; x_n); (c_2^0; x_2^0); \dots; (c_n^0; x_n^0)\|_{C; X_1, C^0; X_1^0} = \mathcal{J}(c_1; x_1); \dots; (c_n; x_n) \in C; c_1 \in F, \dots, c_n \in F, x_1 \in X, \dots, x_n \in X$$

$$\mathcal{J}^0(c_1^0; x_1^0); \dots; (c_n^0; x_n^0) \in C^0; c_1^0 \in F, \dots, c_n^0 \in F, x_1^0 \in X, \dots, x_n^0 \in X$$

Then

$$\text{Conc}_{1!n+1}(f, f^0) = \sup_{\substack{c_1; \dots; c_n \\ x_1; \dots; x_n}} \sum_{\substack{c_1; \dots; c_n \\ x_1; \dots; x_n}} (c_1; x_1); \dots; (c_n; x_n) \dots$$

In particular  $\text{Conc}_{1!n+j}(f, f^0)_p = k_{k_p}$ :

Fix any  $1 \leq i_1 < \dots < i_n \leq n+1$  and colours  $c_{i_1}; \dots; c_{i_n}$ . Set  $q = \max\{i_1, \dots, i_n\} - 1$  with the convention that if  $i_1 = \dots = i_n = n$ , then  $q = 0$ . Set  $j_1 = i_1 + 1; \dots; j_q = i_q + 1; j_{q+1} = i_{q+1} - n + 2; \dots; j_p = i_p - n + 2$  and

$$d_j = c_{i_j} = 1; \dots; d_q$$

$$d_{j_0} = c_{i_{q+1}} = 1; \dots; d_p = c_{i_p}$$

Also  $x_1 = k - n + 1$ . First assume that  $k \geq n - 1$ . We have, for all  $c_1; \dots; c_n \in \mathbb{F}^0$

$$\sup_{\substack{x_k \\ x_i; i \in k}} \sum_{\substack{c_1; \dots; c_n \\ x_1; \dots; x_n}} (c_1; x_1); \dots; (c_n; x_n) \dots$$

Now assume that  $q$  is odd. Then  $p - q$  is even and

$$\sup_{\substack{c_1; \dots; c_n \\ x_1; \dots; x_n}} \sum_{\substack{c_1; \dots; c_n \\ x_1; \dots; x_n}} (c_1; x_1); \dots; (c_n; x_n) \dots$$

In the event that  $q$  is even, one obtains in a similar way that

$$\sup_{\substack{c_1; \dots; c_n \\ x_1; \dots; x_n}} \sum_{\substack{c_1; \dots; c_n \\ x_1; \dots; x_n}} (c_1; x_1); \dots; (c_n; x_n) \dots$$

The case that  $k \leq n$  follows by interchanging the roles of  $f$  and  $f^0$ .

For the second contraction estimate of Definition VI.13 it suffices to consider, by the symmetry of the norms,  $\text{Conc}_{1!n+1} \text{Conc}_{2!n+2} \text{Conc}_{3!n+3}(f, f^0)_p$ . Set

$$\sim ((c_4; x_4); \dots; (c_n; x_n)); (c_1; x_1); \dots; (c_3; x_3)$$

$$= \dots ((c_1; x_1); \dots; (c_n; x_n)) \dots$$

Then

$$\frac{\text{Conc}_1 \text{Conc}_2 \text{Conc}_3 (f \ f^0)}{1! \ n+1 \ 2! \ n+2 \ 3! \ n+3} = \sum_{X} \sim ((c_1; x_1); \dots; (c_{n+n^0}; x_{n+n^0})) \ c_1; x_1 \dots c_{n+n^0}; x_{n+n^0}$$

$$\begin{matrix} c_1; & n^2 c_{n^0} & 6^2 F \\ x_1; & n^2 x_{n^0} & 6^2 X \end{matrix}$$

Fix any  $1 \leq i_1 < \dots < i_p \leq n+n^0$  and colours  $c_{i_1}; \dots; c_{i_p}$ . Set  $q = \max\{i_1, \dots, i_p\} + 3$ . Set  $j_1 = i_1 + 3; \dots; j_p = i_p + 3; j_{p+1}^0 = i_{q+1} + n + 6; \dots; j_q^0 = i_q + n + 6$  and

$$d_j = c_{i_j} = 1; \quad j \leq q$$

$$d_{j^0} = c_{i_{q+j}} = 1; \quad j \leq p$$

Also  $x_1 \leq k \leq n+n^0$ . First assume that  $k \leq n+3$ . We have, for all  $c_1; \dots; c_{n+n^0} \in \mathbb{F}^0$

$$\sup_{x_k} \sum_{x_1; i \in k} \sim ((c_1; x_1); \dots; (c_{n+n^0}; x_{n+n^0}))$$

$$\sum_{X} \sum_{d_1; d_2; d_3; c_1; \dots; c_{n+n^0}}^{d_1; d_2; d_3 \in \mathbb{F}^0} (d_1; d_2; d_3; c_1; \dots; c_{n+n^0}) \sup_{y; y^0 \in X} \prod (y; y^0)^j$$

$$b^4 c \sum_{d_1; d_2; d_3 \in \mathbb{F}^0} \sum_{X} \sum_{d_1^0; d_2^0; d_3^0; c_{n+2}; \dots; c_{n+n^0}} (d_1^0; d_2^0; d_3^0; c_{n+2}; \dots; c_{n+n^0})$$

by (X.3). Now assume that  $q$  is odd. Then

$$\sum_{X} \sum_{c_1 \in \mathbb{F}^0; \dots; c_p \in \mathbb{F}^0} \sup_{x_1; i \in k} \sim ((c_1; x_1); \dots; (c_{n+n^0}; x_{n+n^0}))$$

$$b^4 c \sum_{d_j \in \mathbb{F}^0; j \in \{j_1, \dots, j_q\}} \sum_{X} \sum_{d_1^0; d_2^0; d_3^0; d_{j_1^0}; \dots; d_{j_q^0}} (d_1^0; d_2^0; d_3^0; d_{j_1^0}; \dots; d_{j_q^0})$$

$$b^4 c k_f k_q k_f^0 k_p^0 k_{q+3}$$

The remaining cases are similar. ■

Theorem X.2 Let  $W$  be a colour preserving function on  $(\mathbb{F} \times X)^n$  and

$$W = \sum_{X} W(c_1; x_1); \dots; (c_4; x_4) \ c_1; x_1 \dots c_4; x_4$$

$$\begin{matrix} c_1; & 4^2 c_4 \\ x_1; & 4^2 x_4 \end{matrix}$$

be the associated interaction. Let

$$W^0(\cdot) = c \cdot W := \log \frac{1}{Z} e^{W : (\cdot)} d_c(\cdot) \quad \text{where } Z = e^{W : (\cdot)} d_c(\cdot)$$

and  $C$  is the covariance of Proposition X.1. Since  $C$  and  $W$  are colour preserving, we can write

$$W_n^0 = \sum_{c_1, \dots, c_n} \sum_{x_1, \dots, x_n} W_n^0(c_1; x_1); \dots; (c_n; x_n) \quad c_1; x_1 \quad c_n; x_n$$

with colour preserving coefficients  $W_n^0$ . If  $\|W\| \leq \frac{1}{2^{38} b^2 c^2 F^j}$ , then

$$\sum_{n=0}^{\infty} 6^n b^n 6^k W_n^0 k_1 \leq 2^{48} c^2 F^j \|W\|^2$$

with  $0 = \frac{1}{2^{29} b^2 c^2 F^j \|W\|}$ , and

$$W_4^0 = W + \frac{1}{4} \sum_{r=1}^{\infty} (12)^{r+1} W(C; W^r) \leq 2^{61} b^4 c^2 F^j \|W\|^2$$

where  $W(C; W^r)$  is the ladder

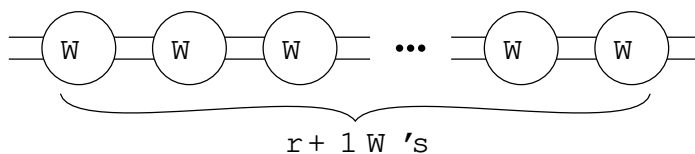

with  $r+1$  rungs  $W$  and propagator  $C$ , defined in Appendix C.

Proof: Set  $J = \frac{1}{F^j}$ . For  $f \in V^n$ , set

$$\|k\| = \|k\|_1 + F^j \|k\|_3 + F^{2j} \|k\|_5$$

$$\|k\|_{in pr} = \|k\|_1 + F^j \|k\|_3$$

By Lemma VI.15,  $(C; 0)$  have improved integration constants  $c; b; J$  for the families  $k$  and  $k_{in pr}$  of seminorms. By (X.2)

$$\|k\| \leq 2 F^j \|W\|$$

Let  $\epsilon = 8$  and  $2 F^j \epsilon > 1/g$ . Then  $\epsilon > 8$  and, using the notation of Definition II.23,

$$N(W; 64) = 2^{24} 4 b^2 c^2 \|k\| \leq 2^{25} 4 b^2 c^2 F^j \|W\| \leq \frac{1}{16}$$

since  $b^2 c^2 F^j \|W\| \leq \frac{1}{2^{38}}$ . Therefore the hypotheses of Theorem VI.6 are fulfilled. By part (i) of Theorem VI.6,

$$N(W^0; W) \leq \frac{1}{2^2} \frac{N(W; 32)^2}{1 - \frac{1}{2} N(W; 32)} \leq 2^{48} 6 b^4 c^2 F^j \|W\|^2$$

In particular

$$\sum_{n=6}^{\infty} \frac{c}{b^2} \sum_{k_1} \dots \sum_{k_n} b^n k_{n-1} \dots k_1 2^{48} b^4 c^2 \mathcal{F}^j \mathcal{W}^j$$

so that

$$\sum_{n=6}^{\infty} b^n \sum_{k_1} \dots \sum_{k_n} k_{n-1} \dots k_1 2^{48} c \mathcal{F}^j \mathcal{W}^j$$

By part (ii) of Theorem VI.6 and Proposition C.4, both  $N_{\text{im pr}} \mathcal{W}_2^0$  and  $N_{\text{im pr}} \mathcal{W}_4^0 = \mathcal{W} + \frac{1}{4} \sum_{r=1}^P (12)^{r+1} \mathcal{W} (C \mathcal{W}^r)$  are bounded by

$$\frac{2^{10} J}{6} \frac{N(\mathcal{W}; 64)^2}{1 - \frac{8}{N(\mathcal{W}; 64)}} 2^{61} b^4 c^2 \mathcal{F}^j \mathcal{W}^j$$

Using (X.2)

$$\mathcal{W}_2^0 \mathcal{W}^j = \sum_{k_{\text{im pr}}} k_{\text{im pr}}^0 = \frac{1}{2} N_{\text{im pr}} \mathcal{W}_2^0; \quad 2^{61} b^4 c^2 \mathcal{F}^j \mathcal{W}^j$$

Similarly, setting  $\mathcal{F} = \mathcal{W}_4^0 = \mathcal{W} + \frac{1}{4} \sum_{r=1}^P (12)^{r+1} \mathcal{W} (C \mathcal{W}^r)$

$$\mathcal{F}^j \mathcal{W}^j = 3k_{\mathcal{F}} k_3 \sum_{k_{\text{im pr}}} k_{\text{im pr}}^3 = \frac{3}{4b^2 c \mathcal{F}^j} N_{\text{im pr}} \mathcal{F}; \quad 2^{63} \frac{1}{2} b^2 c \mathcal{W}^j$$

With  $\epsilon = \frac{1}{8}$ , we get the desired bound. ■

The  $j^{\text{th}}$  shell,  $j \geq 1$ , of the many fermion model of [FKTfl] behaves qualitatively like the vector model that we have just discussed. The covariance for the  $j^{\text{th}}$  shell of that many fermion model is

$$C^{(j)}(k) = \frac{\chi^{(j)}(k)}{\{k_0, e(k)\}}$$

where  $\chi^{(j)}(k)$  is approximately the characteristic function with support

$$S_j = \{k = (k_0; k) \in \mathbb{R}^d \mid \frac{1}{M^j} \leq |k_0 - e(k)| < \frac{1}{M^{j-1}}\}$$

To define seminorms in position space that mimic well, in our context, the supremum in momentum space, we introduce sectorizations. We choose a projection  $\mathbb{1}_{\mathcal{F}}(k)$  onto the Fermi curve  $\mathcal{F}$  and a decomposition of the Fermi curve into disjoint intervals  $I_1; \dots; I_N; I$  each of length  $l$  between  $\frac{1}{M^j}$  and  $\frac{1}{M^{j-2}}$ . The sectorization is the collection of "sectors"  $S_\nu = \mathbb{1}_{\mathcal{F}}^{-1}(I_\nu) \setminus S_j, \nu = 1; \dots; N$ .

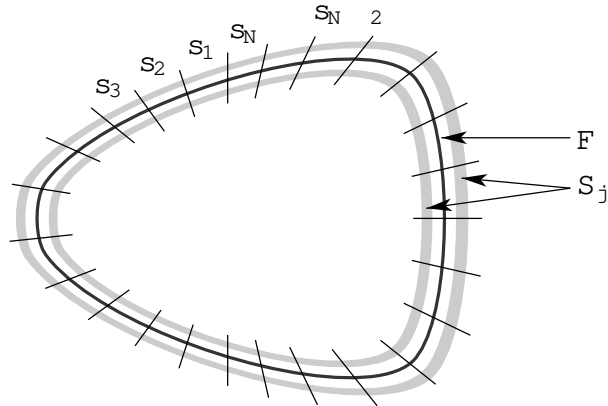

Let \$V\$ be the complex vector space with basis \$s\_{i;x} i, s\_{i;x} s\_2 ; x \in \mathbb{R}^2\$ and define the covariance<sup>(1)</sup>

$$C(s_{i;x} i, s_{i';x'}) = C(s_{i;x} i, s_{i';x'}) = 0 \quad C(s_{i;x} i, s_{i';x'}) = \int_{\mathbb{S}} d^3k e^{ik \cdot x} \tilde{C}^{(j)}(k)$$

The norms on \$V^n\$ are similar to those of the vector model. In this case

$$b^2 = \text{const} \frac{1}{M^j} \quad c = \text{const} M^j \quad J = \frac{1}{j^j} = \text{const} 1$$

and the conclusions of Theorem X.2 become

$$W_4^0 = W + \frac{1}{4} \sum_{r=1}^{\mathbb{P}} (12)^{r+1} W \quad (C(W^5) = \text{const} 1 \sum W^2)$$

for all four-legged interactions \$W\$ whose norm \$\sum W^2\$ is bounded by a sufficiently small, but \$j\$-independent, constant.

<sup>(1)</sup> We are deliberately ignoring many technical details; in particular, we ignore spin, smoothness of partitions of unity, factors of 2.



## Appendix C : Ladders expressed in terms of kernels

Let  $V$  be a complex vector space and  $f_i$  a system of generators for  $V$  that is indexed by  $i$  in a set  $X$ .

Definition C.1

i) Depending on the context, a complex valued function on  $X^4$  is called a four legged kernel over  $X$  or a bubble propagator over  $X$ .

ii) To a four legged kernel  $f$  over  $X$  we associate the Grassmann function

$$\text{Gr}(;f) = \sum_{i_1, i_2, i_3, i_4 \in X} f(i_1; i_2; i_3; i_4) i_1 i_2 i_3 i_4$$

in the complex Grassmann algebra  $\bigwedge V$ .

iii) If  $A$  and  $B$  are covariances on  $V$  then the tensor product

$$A \otimes B(i_1; i_2; i_3; i_4) = A(i_1; i_3)B(i_2; i_4)$$

is a bubble propagator over  $X$ . In particular we shall consider the bubble propagator

$$C = C_1 + C_2 + D_1 + D_2 + C_3$$

where  $C_1$  and  $D_1$  are the covariances of Section V.2.

iv) Let  $f_1$  and  $f_2$  be functions on  $X^4$ . The operator product of  $f_1$  and  $f_2$  is

$$(f_1 \otimes f_2)(i_1; i_2; i_3; i_4) = \sum_{j_1, j_2 \in X} f_1(i_1; i_2; j_1; j_2) f_2(j_1; j_2; i_3; i_4)$$

whenever the sum is well defined.

v) Let  $f$  be a four legged kernel over  $X$ . The antisymmetrization of  $f$  is the four legged kernel

$$\text{Ant}f(i_1; i_2; i_3; i_4) = \frac{1}{4!} \sum_{\sigma \in S_4} \text{sgn}(\sigma) f(i_{\sigma(1)}; i_{\sigma(2)}; i_{\sigma(3)}; i_{\sigma(4)})$$

Clearly  $\text{Gr}(;f) = \text{Gr}(; \text{Ant}f)$ . The kernel  $f$  is called antisymmetric if  $f = \text{Ant}f$ .

Lemma 2.2 Let

$$E = \sum_{i_1, i_2, i_3, i_4 \in X} e_{202}(i_1, i_2, i_3, i_4) \begin{pmatrix} 0 & 0 \\ i_3 & i_4 \end{pmatrix} + 2 \sum_{i_1, i_2, i_3, i_4 \in X} e_{211}(i_1, i_2, i_3, i_4) \begin{pmatrix} 0 & 0 \\ i_3 & i_4 \end{pmatrix}$$

be an end as in Definition VI.5, where  $e_{202}$  and  $e_{211}$  are four-legged kernels over  $X$  that are antisymmetric under permutations of their four arguments.

i) If

$$E^0 = \sum_{i_1, i_2, i_3, i_4 \in X} e_{202}^0(i_1, i_2, i_3, i_4) \begin{pmatrix} 0 & 0 \\ i_3 & i_4 \end{pmatrix} + 2 \sum_{i_1, i_2, i_3, i_4 \in X} e_{211}^0(i_1, i_2, i_3, i_4) \begin{pmatrix} 0 & 0 \\ i_3 & i_4 \end{pmatrix}$$

is another end with antisymmetric four-legged kernels  $e_{202}^0$  and  $e_{211}^0$  then

$$E - E^0 = 2 \text{Gr} ; e_{202} \begin{pmatrix} C & C \end{pmatrix} \begin{pmatrix} 0 \\ 202 \end{pmatrix} + e_{211} \begin{pmatrix} C & D + D & C \end{pmatrix} \begin{pmatrix} 0 \\ 211 \end{pmatrix}$$

ii) If

$$E = \sum_{i_1, i_2, i_3, i_4 \in X} e_{0202}(i_1, i_2, i_3, i_4) \begin{pmatrix} 0 & 0 \\ i_3 & i_4 \end{pmatrix} + 2 \sum_{i_1, i_2, i_3, i_4 \in X} e_{1102}(i_1, i_2, i_3, i_4) \begin{pmatrix} 0 & 0 \\ i_3 & i_4 \end{pmatrix} \\ + 2 \sum_{i_1, i_2, i_3, i_4 \in X} e_{0211}(i_1, i_2, i_3, i_4) \begin{pmatrix} 0 & 0 \\ i_3 & i_4 \end{pmatrix} + 4 \sum_{i_1, i_2, i_3, i_4 \in X} e_{1111}(i_1, i_2, i_3, i_4) \begin{pmatrix} 0 & 0 \\ i_3 & i_4 \end{pmatrix}$$

is a rung with antisymmetric kernels  $e_{0202}; e_{1102}; e_{0211}; e_{1111}$ , then

$$E = 2 \sum_{i_1, i_2, i_3, i_4 \in X} e_{0202}(i_1, i_2, i_3, i_4) \begin{pmatrix} 0 & 0 \\ i_3 & i_4 \end{pmatrix} + 2 \sum_{i_1, i_2, i_3, i_4 \in X} e_{211}(i_1, i_2, i_3, i_4) \begin{pmatrix} 0 & 0 \\ i_3 & i_4 \end{pmatrix}$$

with

$$\begin{aligned} 202 &= e_{202} \begin{pmatrix} C & C \end{pmatrix} \begin{pmatrix} 0 \\ 202 \end{pmatrix} + e_{211} \begin{pmatrix} C & D + D & C \end{pmatrix} \begin{pmatrix} 0 \\ 211 \end{pmatrix} \\ 211 &= e_{202} \begin{pmatrix} C & C \end{pmatrix} \begin{pmatrix} 0 \\ 211 \end{pmatrix} + e_{211} \begin{pmatrix} C & D + D & C \end{pmatrix} \begin{pmatrix} 0 \\ 211 \end{pmatrix} \end{aligned}$$

Proof: i)

$$\begin{aligned}
 E E^0 &= \sum_{i_1, i_2, i_3, i_4} \sum_{\substack{h \\ i_1, i_2, i_3, i_4}} e_{202}(i_1, i_2, i_3, i_4) :_{i_3, i_4} \dot{c} + 2e_{211}(i_1, i_2, i_3, i_4) :_{i_3, i_4} \dot{c} \\
 &= \sum_{i_1, i_2, i_3, i_4} \sum_{\substack{h \\ i_1, i_2, i_3, i_4}} e_{202}^0(i_1, i_2, i_3, i_4) :_{i_1, i_2} \dot{c} + 2e_{211}^0(i_1, i_2, i_3, i_4) :_{i_1, i_2, i_3, i_4} d_C(\cdot) d_D(\cdot) \\
 &= \sum_{i_1, i_2, i_3, i_4} \sum_{\substack{h \\ i_1, i_2, i_3, i_4}} 4e_{211}(i_1, i_2, i_3, i_4) e_{211}^0(i_1, i_2, i_3, i_4) D(i_3, i_3) C(i_4, i_4) \\
 &\quad + e_{202}(i_1, i_2, i_3, i_4) e_{202}^0(i_1, i_2, i_3, i_4) C(i_3, i_3) C(i_4, i_4) C(i_3, i_4) C(i_4, i_3) \\
 &= \sum_{i_1, i_2, i_3, i_4} \sum_{\substack{h \\ i_1, i_2, i_3, i_4}} 4e_{211}(i_1, i_2, j_1, j_2) e_{211}^0(i_1, i_2, k_1, k_2) D(j_1, k_1) C(j_2, k_2) \\
 &\quad + e_{202}(i_1, i_2, j_1, j_2) e_{202}^0(i_1, i_2, k_1, k_2) C(j_1, k_1) C(j_2, k_2) \\
 &\quad + e_{202}(i_1, i_2, j_1, j_2) e_{202}^0(i_1, i_2, k_2, k_1) C(j_1, k_1) C(j_2, k_2) \\
 &= \sum_{i_1, i_2, i_3, i_4} \sum_{\substack{h \\ i_1, i_2, i_3, i_4}} 4e_{211}(i_1, i_2, i_1, i_2) (C, D) \overset{0}{e}_{211}(i_1, i_2, i_1, i_2) \\
 &\quad + 2e_{202}(i_1, i_2, i_1, i_2) (C, C) \overset{0}{e}_{202}(i_1, i_2, i_1, i_2) \\
 &= 2 \sum_{i_1, i_2, i_3, i_4} \sum_{\substack{h \\ i_1, i_2, i_3, i_4}} e_{211}(i_1, i_2, i_3, i_4) (C, D + D, C) \overset{0}{e}_{211}(i_1, i_2, i_3, i_4) \\
 &\quad + e_{202}(i_1, i_2, i_3, i_4) (C, C) \overset{0}{e}_{202}(i_1, i_2, i_3, i_4)
 \end{aligned}$$

For the last two equalities we used the antisymmetry of the kernels.

ii) Similarly,

$$\begin{aligned}
 E &= \sum_{i_1, i_2, i_3, i_4} \sum_{\substack{h \\ i_1, i_2, i_3, i_4}} e_{202}(i_1, i_2, i_3, i_4) :_{i_3, i_4} \dot{c} + 2e_{211}(i_1, i_2, i_3, i_4) :_{i_3, i_4} \dot{c} \\
 &\quad + 2e_{020}(i_1, i_2, i_3, i_4) :_{i_1, i_2} \dot{c} + 2e_{1102}(i_1, i_2, i_3, i_4) :_{i_1, i_2} \overset{0}{c}_3 \overset{0}{c}_4 \\
 &\quad + 2e_{0211}(i_1, i_2, i_3, i_4) :_{i_1, i_2} \dot{c} + 4e_{1111}(i_1, i_2, i_3, i_4) :_{i_1, i_2} \overset{0}{c}_3 \overset{0}{c}_4 d_C(\cdot) d_D(\cdot) \\
 &= 2 \sum_{i_1, i_2, i_3, i_4} \sum_{\substack{h \\ i_1, i_2, i_3, i_4}} e_{211}(i_1, i_2, i_3, i_4) (C, D + D, C) \overset{0}{e}_{211}(i_1, i_2, i_3, i_4) \\
 &\quad + e_{202}(i_1, i_2, i_3, i_4) (C, C) \overset{0}{e}_{202}(i_1, i_2, i_3, i_4) \\
 &\quad + 4 \sum_{i_1, i_2, i_3, i_4} \sum_{\substack{h \\ i_1, i_2, i_3, i_4}} e_{211}(i_1, i_2, i_3, i_4) (C, D + D, C) \overset{0}{e}_{211}(i_1, i_2, i_3, i_4) \\
 &\quad + e_{202}(i_1, i_2, i_3, i_4) (C, C) \overset{0}{e}_{202}(i_1, i_2, i_3, i_4)
 \end{aligned}$$



Lemma C.3 Let  $f$  be an antisymmetric four legged kernel and  $n \geq 0$ . Set  $F = \text{Gr}(f; \cdot)$  and

$$E_n(F) = E(F) \otimes (F) \otimes (F) \otimes (F)$$

with  $n$  copies of  $(F)$ , where  $E(F)$  and  $(F)$  were defined in Definition VI.5.iii. Then

$$E_n(F) = \sum_{i_1, i_2, i_3, i_4} f_n(i_1, i_2, i_3, i_4) \begin{matrix} 0 & 0 \\ i_1 & i_2 \\ i_3 & i_4 \end{matrix} + 2 \sum_{i_1, i_2, i_3, i_4} \begin{matrix} 0 & 0 \\ i_1 & i_2 \\ i_3 & i_4 \end{matrix}$$

with

$$f_n = \frac{(-1)^n}{2} (12)^{n+1} f \quad (C.1)$$

Proof: Observe that

$$\begin{aligned} E(F) &= \sum_{i_1, i_2, i_3, i_4} \begin{matrix} 4 \\ 2 \end{matrix} f(i_1, i_2, i_3, i_4) \begin{matrix} 0 & 0 \\ i_1 & i_2 \\ i_3 & i_4 \end{matrix} + 2 \sum_{i_1, i_2, i_3, i_4} \begin{matrix} 0 & 0 \\ i_1 & i_2 \\ i_3 & i_4 \end{matrix} \\ (F) &= \sum_{i_1, i_2, i_3, i_4} \begin{matrix} 4 \\ 2 \end{matrix} f(i_1, i_2, i_3, i_4) \begin{matrix} 0 & 0 \\ i_1 & i_2 \\ i_3 & i_4 \end{matrix} + 2 \sum_{i_1, i_2, i_3, i_4} \begin{matrix} 0 & 0 \\ i_1 & i_2 \\ i_3 & i_4 \end{matrix} + 2 \sum_{i_1, i_2, i_3, i_4} \begin{matrix} 0 & 0 \\ i_1 & i_2 \\ i_3 & i_4 \end{matrix} + 4 \sum_{i_1, i_2, i_3, i_4} \begin{matrix} 0 & 0 \\ i_1 & i_2 \\ i_3 & i_4 \end{matrix} \end{aligned} \quad (C.1)$$

Since  $E(F) = E_0(F)$ , this proves the case  $n = 0$ . We now perform induction on  $n$ . By Lemma C.2 and the induction hypothesis

$$E_{n+1}(F) = \sum_{i_1, i_2, i_3, i_4} 202(i_1, i_2, i_3, i_4) \begin{matrix} 0 & 0 \\ i_1 & i_2 \\ i_3 & i_4 \end{matrix} + 2 \sum_{i_1, i_2, i_3, i_4} 211(i_1, i_2, i_3, i_4) \begin{matrix} 0 & 0 \\ i_1 & i_2 \\ i_3 & i_4 \end{matrix}$$

with

$$\begin{aligned} 202 &= 211 = 2 \begin{matrix} 4 \\ 2 \end{matrix} f_n \quad (C.1) \quad f + \bar{f} \quad (C.1) \quad D + D \quad (C.1) \quad f \\ &= 12 f_n \quad C \quad f = \bar{f}_{n+1} \end{aligned}$$

■

Proposition C.4 Let  $f$  be an antisymmetric four legged kernel. Set  $F = \text{Gr}(f; \cdot)$  and let  $L_r(F) = E(F) \otimes (F) \otimes \dots \otimes (F) \otimes E(F)$  the ladder of length  $r \geq 1$  with  $r - 1$  rungs  $(F)$ . Then

$$L_r(F) = \frac{(-1)^r}{2} (12)^{r+1} \text{Gr} \ ; \ f \quad (C.1)$$

Proof: By Lemma C.2, Lemma C.3 and (C.1)

$$\begin{aligned} L_r(F) &= E_{r-1}(F) \otimes E(F) \\ &= 2 \begin{matrix} 4 \\ 2 \end{matrix} \text{Gr} \ ; \ f_{r-1} \quad (C.1) \quad f + \bar{f}_{r-1} \quad (C.1) \quad D + D \quad (C.1) \quad f \\ &= 12 \text{Gr} \ ; \ f_{r-1} \quad C \quad f \\ &= \frac{(-1)^r}{2} (12)^{r+1} \text{Gr} \ ; \ f \quad (C.1) \end{aligned}$$

■

## References

- [BS] F. Berezin, M. Shubin: The Schrodinger Equation. Kluwer 1991. Supplement 3: D. Leites, Quantization and supermanifolds.
- [FKLT1] J. Feldman, H. Knorrer, D. Lehmann, E. Trubowitz, Fermi Liquids in Two-Space Dimensions, in Constructive Physics V. Rivasseau ed. Springer Lecture Notes in Physics 446, 267-300 (1995).
- [FKLT2] J. Feldman, H. Knorrer, D. Lehmann, E. Trubowitz, Are There Two Dimensional Fermi Liquids?, in Proceedings of the Xth International Congress of Mathematical Physics, D. Jaghitzler ed., 440-444 (1995).
- [FKT1] J. Feldman, H. Knorrer, E. Trubowitz, A Representation for Fermionic Correlation Functions, Communications in Mathematical Physics 195, 465-493 (1998).
- [FKTfl] J. Feldman, H. Knorrer, E. Trubowitz, A Two Dimensional Fermi Liquid, Part 1: Overview, preprint.
- [FKTo3] J. Feldman, H. Knorrer, E. Trubowitz, Single Scale Analysis of Many Fermion Systems, Part 3: Sectorized Norms, preprint.
- [FMRT] J. Feldman, J. Magnen, V. Rivasseau, E. Trubowitz, An Infinite Volume Expansion for Many Fermion Green's Functions, Helvetica Physica Acta 65, 679-721 (1992).
- [FST1] J. Feldman, M. Salmhofer, E. Trubowitz, Perturbation Theory around Non-nested Fermi Surfaces, I: Keeping the Fermi Surface Fixed, Journal of Statistical Physics 84, 1209-1336 (1996).
- [FST2] J. Feldman, M. Salmhofer, E. Trubowitz, Regularity of the Moving Fermi Surface: RPA Contributions, Communications on Pure and Applied Mathematics, LI 1133-1246 (1998).
- [FST3] J. Feldman, M. Salmhofer, E. Trubowitz, Regularity of Interacting Nonspherical Fermi Surfaces: The Full Self-Energy, Communications on Pure and Applied Mathematics LII, 273-324 (1999).
- [FST4] J. Feldman, M. Salmhofer, and E. Trubowitz, An inversion theorem in Fermi surface theory, Communications on Pure and Applied Mathematics, to appear.

## Notation

Not'n	Description	Reference
$Z_V(f)$	degree zero component of $f$	Definition II.1.iii
$V$	Grassmann algebra over $V$	Example II.2
$V_A$	Grassmann algebra over $V$ with coefficients in $A$	Example II.2
$A_m[n_1; \dots; n_r]$	partially antisymmetric elements of $A_m \otimes V^{(n_1 + \dots + n_r)}$	Definition II.21
$E;_A E$	enlarged algebra	Definition V.III.5
$E_v$	evaluation map	Definition V.III.5
$R_{e^{-i}id_C}()$	$= e^{-1/2 \sum_{i,j} c_{ij}} \int G$ Grassmann Gaussian integral	before Definition II.3
$c(W)()$	$= \log \frac{1}{Z} \int_R e^{W(\cdot)} d_C()$ renormalization group map	Definitions II.3, II.27
$S(f)$	$= \frac{1}{Z(U;C)} \int f(\cdot) e^{U(\cdot)} d_C()$ Schwinger functional	before Remark III.1
$R$	$R$ {operator	before Theorem III.2
$R_C(K_1; \dots; K_r)$	$R$ Taylor coefficient of $R$	(III.2)
$R_{K;C}(f)$	$\int e^{K(\cdot;0)} f(\cdot) d_C(0) d_C()$	Definition III.4
$R_C(K_2; \dots; K_r)(f)$	$\int \int_{i=2}^r K_i(\cdot;0 + \dots; 0) f(\cdot + \dots) d_C(0) d_C(0)$	(V.II.1)
$e^{-i}id_C$	$= e^{-1/2 \sum_{i,j} c_{ij}} e^{-i} Wick ordering$	after Remark II.4
$Con_C; Con_C$	contractions	Definitions II.5, II.9
$N_d$	norm domain	Definition II.14
$c$	contraction bound	Definition II.25.i
$b$	integral bound	Definition II.25.ii
$c; b; J$	improved integration constants	Definition VI.1
$N(f; )$	$\frac{1}{b^2} \int_C \dots \int b^{j_1 j_2} \dots f_{m; n_1; \dots; n_r}$	Definition II.23
$(F)$	rung	Definition VI.5
$E(F)$	end	Definition VI.5
$L_r(F)$	ladder of length $r$	Definition VI.5
$k \int$	conjugation of seminomials	Definition VI.13
$P$	projects $f(\cdot; )$ to $f_{4;0}(\cdot;0) + f_{2;0}(\cdot;0)$	Definition VII.8
$Q(K_1; \dots; K_r)$	enlarged algebra analog of $R_C(K_1; \dots; K_r)$	Definition V.III.1
$Gr(\cdot; f)$	Grassmann function	Definition C.1.ii
	convolution	Definition C.1.iv