

UTTG-11-01
TAUP-2677-01
AEI-2001-104
hep-th/yymmnnn
August 2001

On Heterotic Orbifolds, M Theory and Type I' Brane Engineering^{★†}

ELIE GORBATOV,^a VADIM S. KAPLUNOVSKY,^a
JACOB SONNENSCHNEIN,^b STEFAN THEISEN^c and SHIMON YANKIELOWICZ^b

a Theory Group, Physics Dept., University of Texas, Austin, TX78712, USA.

b School of Physics and Astronomy, Beverly and Raimond Sackler Faculty of Exact Sciences, Tel Aviv University, Tel-Aviv 69978, Israel.

c Planck-Institut für Gravitationsphysik, Albert-Einstein-Institut, Am Mühlenberg 1, D-14476 Golm, Germany.

★ Research supported in part by the US-Israeli Binational Science Foundation, the US National Science Foundation (grant #PHY-00-71512), the Robert A. Welsh Foundation, the German-Israeli Foundation for Scientific Research (GIF), by the EEC (contract #HPRN-CT-2000-00122), by the Israel Science Foundation, and by DFG-SFB-375.

† We advice printing this paper in color

ABSTRACT

Hořava–Witten M theory \leftrightarrow heterotic string duality poses special problems for the twisted sectors of heterotic orbifolds. In our previous paper [3] we explained how in M theory the twisted states couple to gauge fields apparently living on M9 branes at *both* ends of the eleventh dimension *at the same time*. The resolution involves 7D gauge fields which live on fixed planes of the $(T^4/\mathbb{Z}_N) \times (\mathbb{S}^1/\mathbb{Z}_2) \times \mathbb{R}^{5,1}$ orbifold and lock onto the 10D gauge fields along the intersection planes. The physics of such intersection planes does not follow directly from the M theory but there are stringent kinematic constraints due to duality and local consistency, which allowed us to deduce the local fields and the boundary conditions at each intersection.

In this paper we explain various phenomena at the intersection planes in terms of duality between Hořava–Witten and type I' superstring theories. The orbifold fixed planes are dual to stacks of D6 branes, the M9 planes are dual to **O8** orientifold planes accompanied by D8 branes, and the intersections are dual to brane junctions. We engineer several junction types which lead to distinct patterns of 7D/10D gauge field locking, 7D symmetry breaking and/or local 6D fields. Another aspect of brane engineering is putting the junctions together; sometimes, the combined effect is rather spectacular from the HW point of view and the quantum numbers of some twisted states have to ‘bounce’ off both ends of the eleventh dimension before their heterotic identity becomes clear.

Some models involve D6/**O8** junctions where the string coupling diverges towards the orientifold plane. We use the heterotic \leftrightarrow HW \leftrightarrow I' duality to predict what *should* happen at such junctions. For example, pinning down an NS5 half-brane to a definite location on a $\lambda = \infty$ **O8** plane requires precisely four D6 branes.

1. Introduction

It is by now well established that duality symmetries relate all five ten-dimensional perturbative string theories but that they do not constitute a closed set. Rather eleven-dimensional supergravity has to be included as one of the possible effective low-energy descriptions. This implies that the underlying fundamental theory — called M theory — is not simply a theory of strings, but its true nature remains rather M ysterious.

Of particular interest is the Hořava–Witten duality between the heterotic $E_8 \times E_8$ string and the 11D M theory compactified on a finite interval $I = \mathbb{S}^1/\mathbb{Z}_2$, where the gauge degrees of freedom are localized at the two end-of-the-world boundary branes $M9_1$ and $M9_2$,^{*} one E_8 factor on each side [1,2]. This duality was derived in ten flat Minkowski dimensions and should hold in lower dimensions after compactification. In our previous paper [3] we studied the T^4/\mathbb{Z}_N orbifold compactifications of this duality to $d = 6$ in which both E_8 gauge symmetries are broken by the orbifold action, $E_8^{(1)} \times E_8^{(2)} \rightarrow G^{(1)} \times G^{(2)}$ (*cf.* also [4,5] and [6,7,8,9]). In the twisted sectors of such orbifolds, the particles are usually charged under *both* $G^{(1)}$ and $G^{(2)}$, which raises a paradox in the dual 11D M theory description; with the $G^{(1)}$ confined to one end of the world and the $G^{(2)}$ confined to the other end, where in the eleventh dimension do we put the massless twisted states?[†]

We found that the local charges of the troublesome twisted states do not directly belong to $G^{(1)} \times G^{(2)} \subset E_8^{(1)} \times E_8^{(2)}$ but rather to $G_7 \times G^{(2)}$ where G_7 is a non-perturbative 7D gauge symmetry localized on a fixed plane $\mathcal{O}6 = \mathbb{R}^{5,1} \times \mathbb{S}^1/\mathbb{Z}_2 \times a$

* Our notations in this paper follow the D -braned convention in which extended objects — branes or fixed planes — are labelled by their space rather than space-time dimensionalities. Thus, an $M9$ brane has nine space dimensions plus one time, hence it carries an 10D SYM theory on its world-volume; likewise, an $\mathcal{O}6$ plane has six space dimensions and carries a 7D SYM on its world-volume, *etc.*

† We focus on the massless states because their exact masslessness is protected by their chirality and their origin in the dual M theory must therefore be local. The massive states are neither chiral nor BPS (in $d = 6, \mathcal{N} = 1$ SUSY) which leaves a wider choice for their M theory origins. For example, they could become extended objects stretched between $M9_1$ and $M9_2$, hence $G^{(1)} \times G^{(2)}$ charges without a paradox.

fixed point of the orbifold action. The G_7 symmetry mixes with a similar factor of $G^{(1)}$ along the $\mathcal{I}5_1 = M9_1 \cap \mathcal{O}6$ intersection plane. Consequently, the diagonal symmetry *appears* to be a subgroup of $G^{(1)}$ but geometrically it extends beyond the $M9_1$ brane along the $\mathcal{O}6$ fixed-planes towards the other end of the eleventh dimension. On $\mathcal{I}5_2 = M9_2 \cap \mathcal{O}6$ we have both G_7 and $G^{(2)}$ gauge fields and the twisted fields living there acquire both charges in a local fashion. The apparent paradox thus arises from a mis-identification of G_7 as a subgroup of $G^{(1)}$. This is natural in the perturbative heterotic theory but one has to more careful in M theory.

As an example, consider the T^4/\mathbb{Z}_2 orbifold with $G^{(1)} = E_7 \times SU(2)^p$, $G^{(2)} = SO(16)$ and $G_7 = SU(2)^{np}$. According to ref. [3] we have the following picture:

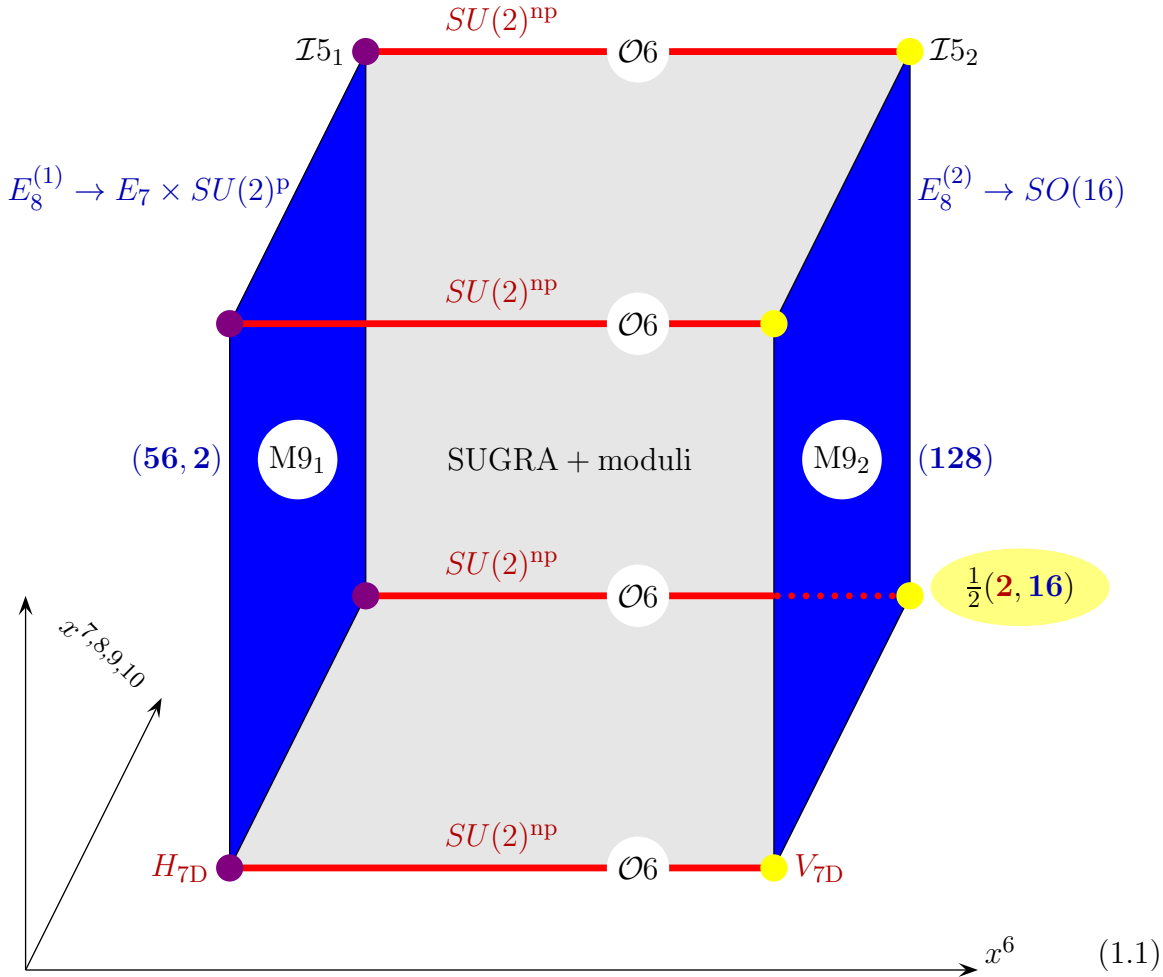

(For simplicity we have depicted only four of the sixteen $\mathcal{O}6$ planes.) At the $\mathcal{I}5_1$

intersections (denoted by purple dots) 7D $SU(2)^{\text{np}}$ gauge fields lock onto $SU(2)^{\text{p}}$ gauge fields,

$$A_\mu(x^6 = 0) = A_\mu^{10\text{D}}(x^{7,8,9,10} = 0) \text{ for same } x^{0,\dots,5}, \mu = 0, \dots, 5. \quad (1.2)$$

By supersymmetry (there are eight unbroken supercharges at $\mathcal{I}5$ intersections) similar Dirichlet-like boundary conditions apply for the fermionic partners of the vector fields. Between the boundaries on $\mathcal{O}6$ there exist 16 supercharges and a 16-SUSY vector multiplet comprises both, a 8-SUSY vector multiplet $V_{7\text{D}}$ and a 8-SUSY hypermultiplet $H_{7\text{D}}$. The $H_{7\text{D}}$ components have Neumann boundary conditions at $\mathcal{I}5_1$. At the other end of the 11th dimension, at $\mathcal{I}5_2$ (yellow dot) it is $H_{7\text{D}}$ which suffers Dirichlet boundary conditions while $V_{7\text{D}}$ enjoys Neumann boundary conditions. Consequently the net gauge symmetry at $\mathcal{I}5_2$ is $SU(2) \times SO(16)$ which allows for local half-hypermultiplets in the $(\mathbf{2}, \mathbf{16})$ representation.

In [3] we gave three lines of evidence for the mixing of M9 and $\mathcal{O}6$ gauge groups: (i) It is the only way to reconcile the massless spectra of heterotic orbifolds with locality in the dual M theory description. (ii) The heterotic gauge coupling, which is known exactly in six dimensions, shows that some gauge groups cannot be of purely M9 origin but must mix with the non-perturbative factors. (iii) Each $\mathcal{I}5$ intersection plane carries a chiral field theory which suffers from local anomalies involving massless particles living on the $\mathcal{I}5$ itself, on M9, on $\mathcal{O}6$ and in the 11D bulk as well as inflow and intersection anomalies due to Chern–Simons terms in M theory. For the local fields and boundary conditions proposed in ref.[3] the anomalies cancel out.

We inferred the boundary conditions for various 7D SYM fields (living on the $\mathcal{O}6$ fixed planes) from kinematic considerations but did not say a word about their dynamical origins, much as Hořava and Witten argued that M9 boundary branes of M theory *must* carry E_8 SYM fields but did not explain *how* such fields actually arise in M theory compactified on $\mathbb{S}^1/\mathbb{Z}_2$. In particular, we did not explain how the two $\mathcal{I}5$ ends of the same $\mathcal{O}6$ fixed plane give rise to different boundary conditions and why only $\mathcal{I}5_2$ has local 6D hypermultiplets.

In this paper we give a dynamical explanation of all the boundary conditions and local fields proposed in [3]. Our main idea is to map the $\mathcal{O}6$ orbifold planes in M theory onto coincident KK magnetic monopoles [10] and hence to coincident D6 branes in the type IIA superstring. Consequently, the Hořava–Witten (HW) theory maps onto the type I' superstring theory and each M9 boundary brane becomes an **O8** orientifold plane accompanied by eight D8 branes. The $\mathcal{I}5$ intersection planes of HW M theory become brane junctions of several distinct types, hence diverse boundary conditions and local 6D fields at different junctions. For example, N D6 branes ending on an **O8** plane give rise to local half-hypermultiplets in the bi-fundamental representation of $G^{(2)} = SO(2k)$ and $G_7 = SU(N)$ broken to $Sp(N/2)$. On the other hand, D6 branes ending on D8 branes in a one-on-one fashion give rise to locking boundary conditions for the gauge fields and consequently mixing of the relevant symmetries. All of this is explained in detail in section 4.

The rest of this paper is organized as follows: Section 2 is a summary of our previous work [3]. We explain the kinematics of HW duals of heterotic orbifolds and provide rules and formulae for checking local anomaly cancellation and correctness of 6D gauge couplings. We also summarize the specific models used later in this paper.

Section 3 is a review of the HW \leftrightarrow I' duality in $d = 9$, which is also relevant to the untwisted sectors of the heterotic orbifolds. We learn how to build type I' duals of $G^{(1)} \times G^{(2)}$ gauge groups of various orbifold models, including the E_n group factors which take us beyond the perturbative type I' regime and recall the rôle played by half D0 branes stuck to an orientifold plane. We also discuss the special case of E_0 factors.

We return to the twisted sectors in section 4 where we introduce the D6 branes and explain the fundamentals of brane engineering the type I' duals of HW orbifolds. As an example, we engineer the duals of the \mathbb{Z}_2 orbifold depicted in fig. (1.1) and show how the boundary conditions and local fields proposed in [3] arise dynamically from the type I' superstring theory.

In section 5 we consider \mathbb{Z}_3 and \mathbb{Z}_4 orbifolds where the 7d/10D gauge symmetry mixing involves a proper subgroup of the non-perturbative 7D symmetry G_7 . We use brane engineering to derive rather complicated boundary conditions for various 8-SUSY hyper and vector multiplet components H_{7D} and V_{7D} of all the 7D, 16-SUSY $SU(N)$ vector multiplets. We also find localized 6D massless states (at both intersection planes) whose local quantum numbers eventually map onto those of the heterotic twisted states, — but the mapping is way too complicated to find without the benefit of a dual type I'/D6 brane model.

Section 6 adds NS5 half-branes stuck at **O8** planes to our brane engineering tool kit. N D6 branes ending on such an NS5 half-brane give rise to 6D hypermultiplets in a $\mathbf{\square}$ tensor representation of the $SU(N)$ gauge symmetry [11]. Many heterotic orbifolds have twisted states with such quantum numbers and we give a simple \mathbb{Z}_6 example.

In section 7 we reverse the flow of the heterotic \leftrightarrow HW \leftrightarrow I' duality and use HW orbifolds to infer the physics of strongly coupled brane junctions. We find that it takes precisely four D6 branes ending on a $\lambda = \infty$ **O8** plane (carrying an extended E_1 symmetry) to somehow pin down a zero-tension NS5 half-brane to the junction; consequently: the local symmetry at the junction is $SU(4) \times (E_1 = SU(2))$ and the local 6D hypermultiplets comprise $\frac{1}{2}(\mathbf{6}, \mathbf{2})$. We also consider N D6 branes ending on ($\lambda = \infty$, charge = -9) **O8*** [12,13] planes and find that somehow such junctions require $N \equiv 0 \pmod{3}$.

Section 8 gives a brief summary of our results and open problems.

Finally, in the Appendix we consider the 6D gauge couplings and the local anomaly cancellation in the new models discussed in sections 6 and 7.

2. Heterotic vs. the Hořava–Witten M theory – a review

We summarize the main points of ref.[3] where we have studied the duality between $\mathcal{N} = 1$ supersymmetric heterotic string compactifications on $\mathbb{R}^{5,1} \otimes (T^4/\mathbb{Z}_N)$ and the Hořava–Witten M theory on $\mathbb{R}^{5,1} \otimes (T^4/\mathbb{Z}_N) \otimes (\mathbb{S}^1/\mathbb{Z}_2)$. The condition of having a supersymmetric compactification restricts $N \in \{2, 3, 4, 6\}$. Some of the models treated in [3] will be reexamined in later sections and we provide the necessary data here. Also, we collect those results of [3] which are needed to check consistency of the construction: the correct heterotic gauge couplings and local anomaly cancellation.

The construction of six-dimensional heterotic orbifolds was reviewed *e.g.* in [14]. It involves the specification of a shift vector δ which realizes the embedding of the \mathbb{Z}_N twist on the gauge degrees of freedom. The compactification breaks the gauge group to $G^{(1,2)} \subset E_8^{(1,2)}$ where $G^{(1,2)}$ depends on the choice of δ . All massless states in the untwisted sector are charged either under $G^{(1)}$ or under $G^{(2)}$ and they live on the corresponding M9. Generically, in the twisted sectors there are states which are charged under both $G^{(1)}$ and $G^{(2)}$. As a specific example consider the \mathbb{Z}_2 orbifold with shift vector $\delta = (\delta_1; \delta_2) = (\frac{1}{2}, \frac{1}{2}, 0, 0, 0, 0, 0, 0; 1, 0, 0, 0, 0, 0, 0, 0)$ and gauge group $G^{(1)} \times G^{(2)} = (E_7 \times SU(2)) \times SO(16)$. The massless matter in the untwisted sector consists of hypermultiplets transforming as $(\mathbf{56}, \mathbf{2}; \mathbf{1})$ and $(\mathbf{1}, \mathbf{1}; \mathbf{128})$ and four neutral moduli hypermultiplets. In the twisted sector there are sixteen half-hypermultiplets — one at each \mathbb{Z}_2 fixed point — transforming as $(\mathbf{1}, \mathbf{2}; \mathbf{16})$.

The basic set-up of the dual M theory includes the following ingredients. We denote by x^0, \dots, x^5 the coordinates of $\mathbb{R}^{5,1}$, $x^6 \in [0, \pi R_{11}]$ is the coordinate along the M theory interval $\mathbb{S}^1/\mathbb{Z}_2$ and x^7, \dots, x^{10} are the coordinates on T^4/\mathbb{Z}_N . There is one M9 brane at each end of the interval and an orbifold fixed plane, denoted by $\mathcal{O}6$, for each of the fixed points of the \mathbb{Z}_N action on T^4 ^{*}. They intersect each M9 in an

* Recall that a $\mathbb{Z}_2(\mathbb{Z}_3)$ orbifold has 16 (9) $\mathbb{Z}_2(\mathbb{Z}_3)$ fixed points. A \mathbb{Z}_4 orbifold has four \mathbb{Z}_4 fixed points and six \mathbb{Z}_2 points. Finally, a \mathbb{Z}_6 orbifold has (1,4,5) $(\mathbb{Z}_6, \mathbb{Z}_3, \mathbb{Z}_2)$ fixed points.

$\mathcal{I}5$, *i.e.* $\mathcal{I}5 = M9 \cap \mathcal{O}6$.[†] Compactification on S^1/\mathbb{Z}_2 leads to the Hořava–Witten theory with an E_8 factor on each end-of-the-world M9. Compactifying further on T^4/\mathbb{Z}_N breaks the gauge group, as in the heterotic case, with $G^{(1)}$ confined to M9₁ and $G^{(2)}$ to M9₂. The charged matter corresponding to the untwisted sector of the dual heterotic theory is localized either on M9₁ or on M9₂, depending on whether they are charged under $G^{(1)}$ or $G^{(2)}$. The twisted matter states are localized on the fixed planes $\mathcal{O}6$ and, since they carry charge, on the end-on-the-world nine-branes, *i.e.* on the $\mathcal{I}5$'s. There seems to be no way to localize those states which are charged under both $G^{(1)}$ and $G^{(2)}$.

The solution of the puzzle involves non-perturbative gauge fields which are localized on the $\mathcal{O}6$ planes. On a $\mathcal{O}6$ plane corresponding to a A_{n-1} singularity one has the gauge group $SU(n)^{\text{np}}$. The states corresponding to the Cartan generators originate from the M theory three-form C and those corresponding to the roots from M2 branes wrapping vanishing cycles. Supersymmetry requires that these states are components of 7D vector multiplets. The presence of boundaries complicates the situation. In particular the boundary conditions of the 7D fields at the ends of the interval have to be specified. Under $\mathbb{Z}_2 : S^1 \rightarrow S^1/\mathbb{Z}_2$ eight supercharges are even and eight are odd and hence supersymmetry is broken 16–SUSY \rightarrow 8–SUSY. The 7D 16–SUSY vector multiplets decompose into a 6D 8–SUSY vector+hypermultiplet (V_{7D} and H_{7D}) with opposite — free *vs.* fixed — boundary conditions. Another constraint is that in the heterotic picture, *i.e.* when we collapse the interval to a point, there should be only the perturbative heterotic states. This means *e.g.* for the \mathbb{Z}_2 model that the 7D fields do not have massless zero-modes in 6D, *i.e.* neither V_{7D} nor H_{7D} has Neumann boundary conditions on both ends.[‡]

Clearly, in the \mathbb{Z}_2 example, since there are no non-perturbative $SO(16)$ gauge

[†] If we want to distinguish the two ends of the interval at $x^6 = 0$ and $x^6 = \pi R_{11}$ we use sub- or superscripts ‘1’ and ‘2’, *e.g.* M9₁, *etc.*

[‡] In section 5 we consider models where some H_{7D} components have zero modes. Nevertheless, the condition that in the heterotic limit there are no additional states must and will be satisfied.

fields at our disposal, we have to place one half-hypermultiplet of the twisted sector on each $\mathcal{I}5_2$. The $SU(2)$ charge it carries must be that of $SU(2)^{\text{np}}$ and it transforms as $(\mathbf{16}, \mathbf{2})$ of $SO(16)^{(\text{p})}|_{\text{M}9_2} \times SU(2)^{(\text{np})}|_{\mathcal{O}6}$. $V_{7\text{D}}$ must have Neumann boundary conditions at $\mathcal{I}5_2$ while at $\mathcal{I}5_1$ the fields in $V_{7\text{D}}$ ‘lock’ to the $SU(2)$ fields on $\text{M}9_1$, *i.e.* they satisfy

$$A_\mu(x^6 = 0) = A_\mu^{10\text{D}}(x^{7,8,9,10} = 0) \quad \text{for same } x^{0,\dots,5}, \mu = 0, \dots, 5 \quad (1.2)$$

and likewise for the gauginos in the 6D vector multiplet. The $SU(2)$ visible in the heterotic description is the diagonal subgroup $SU(2)^{\text{het}} = \text{diag}[SU(2)^{\text{p}} \times (SU(2)^{\text{np}})^{16}]$. The boundary conditions of $H_{7\text{D}}$ are opposite to those of $V_{7\text{D}}$: Neumann on $\mathcal{I}5_1$ and Dirichlet on $\mathcal{I}5_2$. At any given $\mathcal{I}5$ only those 7D fields contribute to the massless spectrum which satisfy Neumann boundary conditions there. The main burden of the analysis of any given model is to determine the correct massless spectrum at the $\mathcal{I}5$ s. We will see that this is a highly non-trivial problem in all but the simplest models. The situation for the \mathbb{Z}_2 model is summarized in fig. (1.1).

Let us now give the evidence for this proposal which we have amassed in [3] and which we had verified for several other models. In addition to reproducing the correct perturbative heterotic spectrum, we showed that the correct heterotic gauge coupling, which can be computed exactly, could be derived from the dual M theory and also that the anomalies on each $\mathcal{I}5$ cancel locally. Both checks rely heavily on the set-up and will now be summarized in turn.

We start with the 6d gauge couplings. The gauge kinetic energy of the six-dimensional low-energy effective $\mathcal{N} = 1$ SYM theory is, in string frame, [15]

$$\mathcal{L} \sim \frac{1}{\alpha'} \sum_{\alpha} (v_{\alpha} e^{-\phi} + \tilde{v}_{\alpha}) \text{tr } F_{\alpha}^2. \quad (2.1)$$

Here ϕ is the heterotic dilaton, $e^{-\phi} = \frac{\text{Vol}(\text{K3})}{\lambda_{\text{het}}^2 \alpha'^2}$, and λ_{het} the heterotic string coupling constant. The sum is over all gauge group factors. v and \tilde{v} are dimensionless constants. For perturbative non-abelian gauge groups, $v = 1$ — it is, in fact, the

level of the Kac-Moody algebra — and \tilde{v} arises at one loop. For non-perturbative gauge groups, on the other hand, $v = 0$ and \tilde{v} is fixed at tree level.

The coefficients v and \tilde{v} are related, via supersymmetry, to the coefficients of the anomaly polynomial which must factorize to allow a Green–Schwarz mechanism to cancel the anomaly. Factorizability of the anomaly polynomial in the form[★]

$$\begin{aligned} \mathcal{A} &\equiv \frac{2}{3} \text{Tr}_{H-V}(\mathcal{F}^4) - \frac{1}{6} \text{tr}(R^2) \times \text{Tr}_{H-V}(\mathcal{F}^2) + (\text{tr}(R^2))^2 \\ &= \left(\sum_i v_i \text{tr}(F_i^2) - \text{tr}(R^2) \right) \times \left(\sum_i \tilde{v}_i \text{tr}(F_i^2) - \text{tr}(R^2) \right). \end{aligned} \quad (2.2)$$

imposes the constraint

$$b_\alpha = 6(v_\alpha + \tilde{v}_\alpha), \quad (2.3)$$

where b_α is the coefficient of the one-loop beta-function of the $d = 4$, $\mathcal{N} = 2$ SYM theory that one obtains upon further compactification on T^2 .

The M9 branes carry magnetic charges under $k_{1,2} = n_{1,2} - 12$ where $n_{1,2}$ are the instanton numbers which satisfy $n_1 + n_2 = 24$. In the orbifold limit the instantons are located at the fixed points and can have fractional instanton number. The relation between k and n follows from the Bianchi identity of the field strength of C . If one integrates the anomaly polynomial of the heterotic theory over a *smooth* K3 one derives $\tilde{v}_{1,2} = \frac{1}{2}k_{1,2}$, *i.e.* $\tilde{v}_1 + \tilde{v}_2 = 0$. In these compactifications there are no non-perturbative gauge fields and we thus conclude that $\tilde{v}^{\text{P}} = \frac{k}{2}$.

This does, however, not hold for the compactification on K3 *orbifolds*. In fact, for the \mathbb{Z}_2 model one finds $k_1 = -4$ and $\tilde{v}(E_7) = -2$, $\tilde{v}(SO(16)) = 2$ but $\tilde{v}(SU(2)) = -2 + 16$. The result for the $SU(2)$ factor indicates that it is indeed the diagonal subgroup of the perturbative $SU(2)$ and 16 non-perturbative $SU(2)$'s on the $\mathcal{O}6$'s. Generally, for those group factors which have a perturbative and a nonperturbative component, $\tilde{v} = \tilde{v}^{\text{P}} + \tilde{v}^{\text{NP}}$.

★ Here we have already used the necessary condition $n_H - n_v = 244$ for the GS mechanism to work.

Even though the non-perturbative fields do not contribute additional degrees of freedom in the heterotic limit, they effect the heterotic gauge coupling via

$$\frac{1}{g_{\text{het}}^2} = \frac{1}{g_{\text{M9}}^2} + \sum_i \frac{1}{g_{\mathcal{O}6}^2}. \quad (2.4)$$

The sum is over all those non-perturbative gauge groups which mix with the perturbative gauge group on M9. Combining this with $\frac{1}{g_{\text{M9}}^2} = \frac{1}{\alpha'} \left(\frac{\text{vol}(\text{K3})}{\lambda_{\text{het}}^2 \alpha'^2} v + \tilde{v}^{\text{P}} \right)$ and $\tilde{v}^{\text{P}} = \frac{k}{2}$ we find for any factor $G \subset E_8$ of the heterotic gauge group which mixes with a non-perturbative gauge group $G \subset SU(n)$ located at a \mathbb{Z}_n fixed plane,

$$\frac{1}{g_G^2} = \frac{v}{g_{E_8}^2} + \frac{\tilde{v}^{\text{NP}}}{g_{SU(n)}^2} + (1 - \text{loop}), \quad (2.5)$$

where the one-loop contribution is $\frac{\tilde{v}^{\text{P}}}{\alpha'} = \frac{k}{2\alpha'}$. Later we will compute $\frac{1}{g_G^2}$ and use eq.(2.5) to determine \tilde{v}^{NP} for various models. The result depends on the details of the mixing of perturbative and non-perturbative gauge groups which will turn out to be highly non-trivial in the presence of $U(1)$ factors. These values have to agree with those derived from (2.2).

The second consistency check is local anomaly cancellation on each $\mathcal{O}6$. In the M theory description of the heterotic orbifold we have allocated all massless fields (perturbative and non-perturbative) to the bulk (gravity and moduli) and the various types of planes (M9, $\mathcal{O}6$ or $\mathcal{I}5$) which are present. The anomalies have to cancel locally, *i.e.* on any such plane separately. In the bulk and on the $\mathcal{O}6$ this is automatic, they are odd-dimensional. On each of the two M9 branes, away from the intersection planes $\mathcal{I}5$, there are 16 supercharges and an entire E_8 gauge group. Anomaly cancellation works in exactly the same way as in the Hořava–Witten theory. The situation on the intersection planes $\mathcal{I}5$, however, involves new features: here supersymmetry is broken further to eight super-charges and the gauge group is broken to a subgroup. The anomaly on the intersection planes gets contributions from three sources: the quantum, inflow and intersection contributions. The total

anomaly polynomial is

$$\mathcal{A} = \mathcal{A}(\text{Quantum}) + \mathcal{A}(\text{inflow}) + \mathcal{A}(\text{intersection}). \quad (2.6)$$

Quantum contributions: they arise from the massless states which are charged under the gauge group $G_{\text{local}}^{6\text{D}}$ operating at a particular $\mathcal{I}5$. Fields residing in the bulk, on the M9 planes, on the $\mathcal{O}6$ plane which is bounded by the $\mathcal{I}5$ plane and the fields confined to $\mathcal{I}5$ contribute. We will denote the multiplet content of the charged M9 fields which contribute to the anomaly by Q_{10} . This splits in hypermultiplets and vector multiplets which contribute with opposite signs. Likewise we introduce the notation Q_7 and Q_6 for the charged fields on $\mathcal{O}6$ and $\mathcal{I}5$ which contribute to the anomaly. We also use $Q = Q_{10} + Q_7 + Q_6$. The net number of fields is denoted by $\dim(Q)$. Q_7 gets contributions from $H_{7\text{D}}$ and $V_{7\text{D}}$. Since the boundary conditions are local and are not communicated across the interval, the contributions of the 7D fields to the anomaly have to be distributed à priori over the two $\mathcal{I}5$ boundaries of $\mathcal{O}6$. However, at each end only the components with Neumann boundary conditions do actually contribute (but with a factor $\frac{1}{2}$). Q_6 consists of all the fields which are localized on the $\mathcal{I}5$ plane. To determine Q_{10} we have to distribute the M9 fields over all $\mathcal{I}5$ s on the same side of the interval. For non-prime orbifolds one has to be careful. *E.g.* for a \mathbb{Z}_4 orbifold we first have to subtract the contribution from the 6 \mathbb{Z}_2 fixed points and then distribute the rest over the four \mathbb{Z}_4 fixed points. Q_{10} can be succinctly written as follows [3]: denote by α the \mathbb{Z}_N generator whose action on E_8 is realized by the shift vector δ . Then for an \mathbb{Z}_N plane $Q_{10} = -T(\alpha)(\mathbf{248})$ where

$$T(x) = \begin{cases} \frac{x}{16}, & N = 2, \\ \frac{x}{9}, & N = 3, \\ \frac{x}{8} + \frac{x^2}{32}, & N = 4, \\ \frac{x}{6} + \frac{x^2}{18} + \frac{x^3}{48}, & N = 6. \end{cases} \quad (2.7)$$

For the \mathbb{Z}_2 model of fig.(1.1) we have

$$G_1^{\text{local}} = E_7^{10\text{D}} \times SU(2)^{\text{diag}}, \quad G_2^{\text{local}} = SO(16)^{10\text{D}} \times SU(2)^{7\text{D}},$$

$$\alpha_1(\mathbf{248}) = (\mathbf{133}, \mathbf{1}) + (\mathbf{1}, \mathbf{3}) - (\mathbf{56}, \mathbf{2}) \quad \text{and} \quad \alpha_2(\mathbf{248}) = (\mathbf{120}) - (\mathbf{128}).$$

The local charged spectra are

$$\begin{aligned} Q_6^{(1)} &= \emptyset, & Q_7^{(2)} &= -\frac{1}{2}(\mathbf{1}, \mathbf{3}), & Q_{10}^{(1)} &= \frac{1}{16}[(\mathbf{56}, \mathbf{2}) - (\mathbf{133}, \mathbf{1}) - (\mathbf{1}, \mathbf{3})], \\ Q_6^{(2)} &= \frac{1}{2}(\mathbf{16}, \mathbf{2}), & Q_7^{(1)} &= \frac{1}{2}(\mathbf{1}, \mathbf{3}), & Q_{10}^{(2)} &= \frac{1}{16}[(\mathbf{128}, \mathbf{1}) - (\mathbf{120}, \mathbf{1})] \end{aligned}$$

from which $\dim(Q)_1 = 0$ and $\dim(Q)_2 = 15$ follows.

The last contribution to the quantum anomaly comes from the bulk fields. They have to be distributed over all fixed planes at both ends of the interval. One has again to be careful for non-prime orbifolds. In particular for the moduli contribution one has to remember that \mathbb{Z}_N orbifolds have four moduli for $N = 2$ and two otherwise.

Combining all contributions one finally obtains the total quantum anomaly on an \mathbb{Z}_N $\mathcal{I}5$ plane of a \mathbb{Z}_N orbifold

$$\begin{aligned} \mathcal{A}(\text{quantum}) &= \frac{2}{3} \text{Tr}_Q F^4 - \frac{1}{6} \text{tr} R^2 \text{Tr}_Q F^2 \\ &+ \frac{1}{360} \left(\dim(Q) - 122T(1) - 2\text{Re}T(e^{2\pi i/N}) \right) \text{tr} R^4 \\ &+ \frac{1}{288} \left(\dim(Q) + 22T(1) - 2\text{Re}T(e^{2\pi i/N}) \right) (\text{tr} R^2)^2. \end{aligned} \quad (2.8)$$

Inflow contributions: they arise from gauge variance of the 11d SUGRA action. There is a contribution from a modified Bianchi identity and contributions arising from Chern–Simons (CS) terms. Explicitly [4,3]

$$\mathcal{A}(\text{inflow}) = -\frac{2g}{3} \left(\frac{1}{8} \text{tr} R^4 - \frac{1}{32} (\text{tr} R^2)^2 \right) - \frac{g}{2} \left(\text{tr} F_{10}^2 - \frac{1}{2} \text{tr} R^2 \right)^2. \quad (2.9)$$

Here F_{10} are the M9 gauge fields and g is the magnetic charge of the $\mathcal{I}5$ -plane under consideration. The charges of all $\mathcal{I}5$ planes on one side of the interval have to satisfy the sum rule $\sum g = k$. For \mathbb{Z}_N orbifolds with N prime all $\mathcal{I}5$ planes on

one side are equivalent and the magnetic charge of each of them is easily determined once k is known. For the \mathbb{Z}_2 model this means that $g_1 = k_1/16 = -1/4 = -g_2$. For $N = 4, 6$ one needs to take into account the magnetic charges of the \mathbb{Z}_2 and (for $N = 6$) \mathbb{Z}_3 fixed planes. Their combined charge has to be subtracted from k and the remainder has to be divided by the number of \mathbb{Z}_N fixed points.

Intersection contributions: they arise from the electric coupling of the $\mathcal{O}6$ to the three form C . This coupling leads to a 7D CS term on each of the $\mathcal{O}6$ planes. One finds [4,3]

$$\mathcal{A}(\text{intersection}) = \left(\text{tr } F_{10}^2 - \frac{1}{2} \text{tr } R^2 \right) \times (T(1) \text{tr } R^2 - \text{tr } F_7^2) . \quad (2.10)$$

Here F_7 are the $\mathcal{O}6$ gauge fields operating on $\mathcal{I}5 = \text{M}9 \cap \mathcal{O}6$.

Anomaly cancellation requires that the coefficients of $\text{tr } R^4$, $(\text{tr } R^2)^2$, $\text{tr } R^2$ and of the term with pure gauge field dependence vanish separately. In particular, absence of the irreducible $\text{tr } R^4$ term implies that

$$\dim(Q \equiv Q_6 + Q_7 + Q_{10}) = 30g + \begin{cases} \frac{15}{2} & \text{for } N = 2, \\ \frac{121}{9} & \text{for } N = 3, \\ 19 & \text{for } N = 4, \\ \frac{535}{18} & \text{for } N = 6. \end{cases} \quad (2.11)$$

Using this, the condition $\mathcal{A} \equiv 0$ reduces to

$$\begin{aligned} \mathcal{A}' &\equiv \frac{2}{3} \text{Tr}_Q(\mathcal{F}^4) - \frac{1}{6} \text{tr}(R^2) \times \text{Tr}_Q(\mathcal{F}^2) + \left(\frac{1}{8}g + \frac{1}{2}T(1)\right)(\text{tr}(R^2))^2 \\ &= \frac{1}{2}g \left(\text{tr}(\mathcal{F}_{10D}^2) - \frac{1}{2} \text{tr}(R^2)\right)^2 \\ &\quad + \left(\text{tr}(\mathcal{F}_{10D}^2) - \frac{1}{2} \text{tr}(R^2)\right) \times \left(\text{tr}(\mathcal{F}_{7D}^2) - T(1) \text{tr}(R^2)\right) . \end{aligned} \quad (2.12)$$

For all models that we will consider we check that (2.11) and (2.12) are satisfied on each $\mathcal{I}5$ plane separately.*

* The relation between tr and Tr in various representations can be found *e.g.* in App. C of [3].

In addition to the \mathbb{Z}_2 model with gauge group $(E_7 \times SU(2)) \times SO(16)$ which has accompanied us through this section, we also considered a \mathbb{Z}_3 , a \mathbb{Z}_4 and a \mathbb{Z}_6 model in [3]. We will reconsider these models in view of the HW \leftrightarrow type I' duality in section 7. Here we collect some basic data. Further details can be found in [3]

\mathbb{Z}_3 – orbifold with gauge group $(E_6 \times SU(3)) \times SU(9)$

$$\text{shift vector: } \delta = \left(-\frac{2}{3}, \frac{1}{3}, \frac{1}{3}, 0, 0, 0, 0, 0; \frac{5}{6}, \frac{1}{6}, \frac{1}{6}, \frac{1}{6}, \frac{1}{6}, \frac{1}{6}, \frac{1}{6}, \frac{1}{6}\right)$$

$$\text{untwisted matter: two moduli } \oplus (\mathbf{27}, \mathbf{3}; \mathbf{1}) \oplus (\mathbf{1}, \mathbf{1}; \mathbf{84})$$

$$\text{twisted matter: } 9 \times (\mathbf{1}, \mathbf{3}; \mathbf{9})$$

$$\tilde{v}_{E_6} = -\frac{3}{2}, \tilde{v}_{SU(3)} = -\frac{3}{2} + 9; \tilde{v}_{SU(9)} = +\frac{3}{2}$$

$$k_1 = -3 = -k_2 \implies g_{I5_1} = -g_{I5_2} = -\frac{1}{3}$$

$$G_1^{\text{local}} = E_6^{10\text{D}} \times SU(3)^{\text{diag}}, G_2^{\text{local}} = SU(9)^{10\text{D}} \times SU(3)^{7\text{D}}$$

$$\begin{aligned} Q_{10}^{(1)} &= \frac{1}{9}[(\mathbf{27}, \mathbf{3}) - (\mathbf{78}, \mathbf{1}) - (\mathbf{1}, \mathbf{8})], & Q_6^{(1)} &= \emptyset, & Q_7^{(1)} &= \frac{1}{2}\mathbf{8} \\ Q_{10}^{(2)} &= \frac{1}{9}[\mathbf{84} - \mathbf{80}], & Q_6^{(2)} &= (\mathbf{9}; \mathbf{3}), & Q_7^{(2)} &= -\frac{1}{2}\mathbf{8} \end{aligned}$$

\mathbb{Z}_4 – orbifold with gauge group $(SO(10) \times SU(4)) \times (SU(8) \times SU(2))$

$$\text{shift vector: } \delta = \left(-\frac{3}{4}, \frac{1}{4}, \frac{1}{4}, \frac{1}{4}, 0, 0, 0, 0; -\frac{7}{8}, \frac{1}{8}, \frac{1}{8}, \frac{1}{8}, \frac{1}{8}, \frac{1}{8}, \frac{1}{8}, \frac{1}{8}\right)$$

$$\text{untwisted matter: two moduli } \oplus (\mathbf{16}, \mathbf{4}; \mathbf{1}, \mathbf{1}) \oplus (\mathbf{1}, \mathbf{1}; \mathbf{28}, \mathbf{2})$$

$$\text{twisted matter: } 4 \times \left[\frac{1}{2}(\mathbf{1}, \mathbf{6}; \mathbf{1}, \mathbf{2}) \oplus (\mathbf{1}, \mathbf{4}; \mathbf{8}, \mathbf{1}) \right] \Big|_{\mathbb{Z}_4} \oplus 6 \times \left[\frac{1}{2}(\mathbf{1}, \mathbf{6}; \mathbf{1}, \mathbf{2}) \oplus \frac{1}{2}(\mathbf{10}, \mathbf{1}; \mathbf{1}, \mathbf{2}) \right] \Big|_{\mathbb{Z}_2}$$

$$\tilde{v}_{SO(10)} = 0, \tilde{v}_{SU(4)} = 0 + 4; \tilde{v}_{SU(8)} = 0, \tilde{v}_{SU(2)} = 0 + 6$$

$$k_1 = k_2 = 0 \implies g_{I5_1} = \frac{1}{4}(0 - 6 \times \frac{1}{4}) = -\frac{3}{8} = -g_{I5_2} \quad (\text{for } \mathbb{Z}_4 \text{ planes})$$

$$G_1^{\text{local}} = SO(10)^{10\text{D}} \times SU(4)^{\text{diag}}, G_2^{\text{local}} = [SU(8) \times SU(2)]^{10\text{D}} \times SU(4)^{7\text{D}}$$

local spectrum at the \mathbb{Z}_4 intersection planes:

$$\begin{aligned}
Q_{10}^{(1)} &= -\frac{5}{32}[(\mathbf{45}, \mathbf{1}) + (\mathbf{1}, \mathbf{15})] + \frac{3}{32}(\mathbf{10}, \mathbf{6}) + \frac{1}{16}(\mathbf{16}, \mathbf{4}) \\
Q_6^{(1)} &= \emptyset, \quad Q_7^{(1)} = \frac{1}{2}\mathbf{15} \\
Q_{10}^{(2)} &= -\frac{5}{32}[(\mathbf{63}, \mathbf{1}) + (\mathbf{1}, \mathbf{3})] + \frac{3}{32}(\mathbf{70}, \mathbf{1}) + \frac{1}{16}(\mathbf{28}, \mathbf{2}) \\
Q_6^{(2)} &= (\mathbf{8}, \mathbf{1}; \mathbf{4}) + \frac{1}{2}(\mathbf{1}, \mathbf{2}; \mathbf{6}), \quad Q_7^{(2)} = -\frac{1}{2}\mathbf{15}
\end{aligned}$$

\mathbb{Z}_6 – orbifold with gauge group $(SU(6) \times SU(3) \times SU(2)) \times SU(9)$

shift vector: $\delta = (-\frac{5}{6}, \frac{1}{6}, \frac{1}{6}, \frac{1}{6}, \frac{1}{6}, \frac{1}{6}, 0, 0; -\frac{5}{6}, \frac{1}{6}, \frac{1}{6}, \frac{1}{6}, \frac{1}{6}, \frac{1}{6}, \frac{1}{6}, \frac{1}{6})$

untwisted matter: two moduli $\oplus (\mathbf{6}, \mathbf{3}; \mathbf{2}, \mathbf{1})$

twisted matter: $[(\mathbf{6}, \mathbf{1}, \mathbf{1}; \bar{\mathbf{9}}) \oplus \frac{1}{2}(\mathbf{20}, \mathbf{1}, \mathbf{1}; \mathbf{1})] \Big|_{\mathbb{Z}_6} \oplus 4 \times (\mathbf{1}, \mathbf{3}, \mathbf{1}; \mathbf{9}) \Big|_{\mathbb{Z}_3}$
 $\oplus 5 \times [\frac{1}{2}(\mathbf{20}, \mathbf{1}, \mathbf{1}; \mathbf{1}) \oplus (\mathbf{6}, \mathbf{3}, \mathbf{1}; \mathbf{1}) \oplus 2(\mathbf{1}, \mathbf{1}, \mathbf{2}; \mathbf{1})] \Big|_{\mathbb{Z}_2}$

$\tilde{v}_{SU(6)} = 1 + 1$, $\tilde{v}_{SU(3)} = 1 + 4$, $\tilde{v}_{SU(2)} = 1$; $\tilde{v}_{SU(9)} = -1$

$k_1 = -k_2 = 2 \implies g_{I5_1} = -g_{I5_2} = -\frac{5}{12}$ (for \mathbb{Z}_6 planes)

$G_1^{\text{local}} = [SU(3) \times SU(2)]^{10D} \times SU(6)^{\text{diag}}$, $G_2^{\text{local}} = SU(9)^{10D} \times SU(6)^{7D}$

local spectrum at the \mathbb{Z}_6 intersection planes:

$$\begin{aligned}
Q_{10}^{(1)} &= -\frac{35}{144}[(\mathbf{35}, \mathbf{1}, \mathbf{1}) + (\mathbf{1}, \mathbf{8}, \mathbf{1}) + (\mathbf{1}, \mathbf{1}, \mathbf{3})] \\
&\quad - \frac{5}{72}(\mathbf{6}, \mathbf{3}, \mathbf{2}) + \frac{13}{72}(\mathbf{15}, \bar{\mathbf{3}}, \mathbf{1}) + \frac{19}{144}(\mathbf{20}, \mathbf{1}, \mathbf{2}) \\
Q_6^{(1)} &= \emptyset, \quad Q_7^{(1)} = \frac{1}{2}\mathbf{35} \\
Q_{10}^{(2)} &= \frac{13}{72}\mathbf{84} - \frac{35}{144}\mathbf{80} \\
Q_6^{(2)} &= (\bar{\mathbf{9}}; \mathbf{6}) + \frac{1}{2}(\mathbf{1}; \mathbf{20}), \quad Q_7^{(2)} = -\frac{1}{2}\mathbf{35}
\end{aligned}$$

3. Explaining E_8 : HW \leftrightarrow I' Duality

Ten-dimensional string theories are connected through a web of perturbative and non-perturbative dualities; for a review, see *e.g.* [16]. One striking feature is that if one studies the strong coupling limit of the type IIA theory, the string coupling constant gets geometrized and parameterizes the size of an additional, eleventh, dimension which is topologically a circle whose radius grows as the type IIA coupling increases. The massless degrees of freedom of the type IIA theory combine into representations of the eleven-dimensional Lorentz-group and their dynamics is governed by eleven-dimensional supergravity. The strong coupling limit of type I string theory is the heterotic $SO(32)$ theory and vice versa; they are S-dual to each other. The type IIB theory, which is of no interest for the discussions in this paper, is self-dual. Finally, the strongly coupled heterotic $E_8 \times E_8$ theory is also an eleven-dimensional theory, with the additional dimension being the interval $I \simeq \mathbb{S}^2/\mathbb{Z}_2$. The gauge degrees of freedom are confined to the two ten-dimensional boundaries, one E_8 factor on each. The original arguments for this strong coupling limit are due to Hořava–Witten [1]. They are of purely kinematical nature and are based on the requirement of local anomaly cancellation on each of the two boundary planes. The theory in the bulk is straightforward — it is simply type IIA string theory. The presence of boundaries has very non-trivial effects the result of which is E_8 SYM theory confined to each of its components. The dynamical origin of the gauge fields, which are not present in the eleven-dimensional supergravity theory stayed, however, mysterious. New insight came from the duality between the HW theory and the type I' theory, which we will now review. It provides an explanation for the E_8 gauge symmetry on the boundaries and also of its regular subgroups some of which occur as gauge groups in T^4/\mathbb{Z}_N orbifold compactifications.

The results in this section are not new but we thought it worthwhile to collect them as they are the basis of the brane constructions in the following sections. We will, however, be brief and qualitative and refer to the cited literature for further details.

The type IIB and type IIA string theories compactified on a circle are related by T-duality [17,18] and so are their orientifolds, called type I and type I', respectively. The latter lives on $R^{8,1} \times \mathbb{S}^1/\mathbb{Z}_2$. There is an orientifold eight-plane **O8** of charge -8 at each end of the interval. In addition, 16 D8 branes are required for charge neutrality. Their positions along the interval are à priori arbitrary: they are T-dual to the 16 Wilson-line moduli of the type I theory on \mathbb{S}^1 . Generically the gauge group is $U(1)^{18}$ where sixteen factors live on the world-volumes of the sixteen D8 branes and the remaining two gauge bosons are the one-form A_μ^{RR} coupling to D0 charge and $B_{9\mu}^{\text{NS}}$ which couples to winding along x^9 .[★]

Clumping branes together one can engineer any regular subgroup of $SO(32)$: a $U(n)$ factor when n D8 branes coincide at a position away from the boundaries[†] and a $SO(2n)$ factor when n of them are located at a boundary. The massless vector bosons (and their partners under supersymmetry) come from open strings of zero length connecting the different branes and also, for branes located on one of the **O8** planes, the branes and their images under the space-time reflection which, together with world-sheet parity reversal, generates the orientifold group. Examples of such brane configurations with $n = 8, 7, 6$ will appear in sections 4,5 and 7, respectively. For instance, the \mathbb{Z}_3 orbifold model of § 5.1 requires the following symmetric brane arrangement to engineer the perturbative gauge group $(SO(14) \times U(1))^{(1)} \times (SO(14) \times U(1))^{(2)}$:

★ In this section x^9 is the compact coordinate along \mathbb{S}^1 and $\mathbb{S}^1/\mathbb{Z}_2$. In the previous and all later sections, where we compactify further on T^4/\mathbb{Z}_N , this coordinate is called x^6 .

† If n_1 branes sit at one position and n_2 at another, the gauge symmetry is $U(1) \times SU(n_1) \times SU(n_2)$, etc..

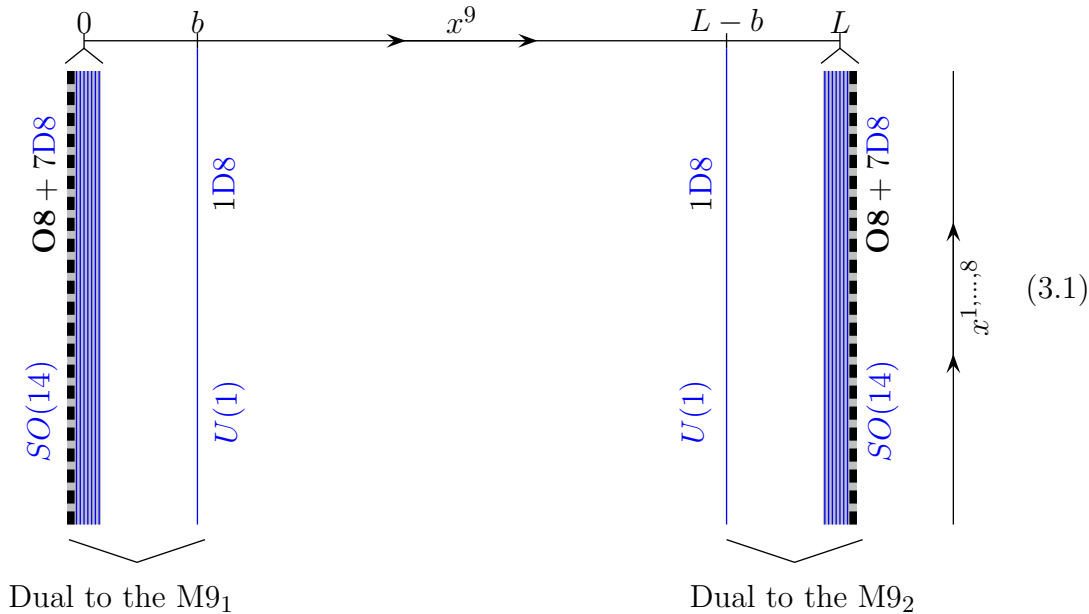

There is one feature of the type I' vacua that we have not yet addressed which is crucial for the heterotic \leftrightarrow type I' duality. In contrast to the type I dilaton, which is constant on \mathbb{S}^1 , the type I' dilaton varies across the interval. The inverse of the type I' coupling constant satisfies the one-dimensional Laplace equation with a source of unit charge at the position of each D8 brane and a source of charge -8 at each end of the interval. As a result it is a piecewise linear function whose gradient jumps upon traversing a D8 brane. We will consider brane arrangements with eight D8 branes sitting in the vicinity of each orientifold brane, say at $x_{1,\dots,8}^9 < b$ and $x_{9,\dots,16}^9 > L - b$. For $b < x^9 < L - b$ the dilaton is constant and if $b/L \ll 1$ it makes sense to speak about the bulk value of the dilaton and the type I' coupling constant.

For generic D8 brane arrangements the coupling constant stays finite everywhere but for particular choices of their positions it diverges at one or both ends of the interval; this will play an important rôle below. The dilaton is constant across the entire interval if and only if eight D8 branes are located at each of the two orientifold planes, *i.e.* if we have local charge neutrality and the (perturbative)

gauge group $SO(16) \times SO(16) \times U(1)^2$.

This can, however, not be the whole story for the following simple reason. The type I' \xleftarrow{T} type I \xleftarrow{S} het. $[SO(32)]$ \xleftarrow{T} het. $[E_8 \times E_8]$ \xleftarrow{S} Hořava–Witten duality chain means that we must be able to find *e.g.* E_8 gauge group factors in type I' . Perturbatively, neither type I nor type I' string theories allow exceptional E_n gauge symmetries, hence we need a non-perturbative gauge group enhancement. Since the duality chain from type I' to het($E_8 \times E_8$) involves an S-duality, we suspect to find E_8 in type I' at strong coupling. This is true, also for various subgroups such as $E_7 \times SU(2)$ which will appear in the examples below.

A vacuum of the type I' theory is specified by the value of the dilaton $\Phi_{I'}^0 \equiv \Phi_{I'}(x^9 = 0)$ at the orientifold plane at $x^9 = 0$, by the positions x_i^9 , $i = 1, \dots, 16$ of the D8 branes and by the size L of the interval. These parameters are mapped under the duality to those characterizing a vacuum of het($SO(32)$) compactified on S^1 : to the (constant) heterotic dilaton Φ_h , the sixteen parameters of the Wilson line on S^1 , $A = (\theta_1, \dots, \theta_{16})$ and to the radius R_h of the S^1 . The precise map of the parameter spaces follows by comparing the low energy effective actions and the masses of perturbative BPS states which are related by the duality. This was first worked out in [19] and extended in [20,21,22,23,24,25]. The explicit relation between the heterotic momentum and winding quantum numbers and the type I' winding and D-particle number was established in [23].

The type I' non-perturbative gauge symmetry enhancement, which should be mapped to the perturbative regime in the heterotic theory, can now be verified. The following qualitative discussion of a particular example shall illustrate this. The precise values of the parameters may be found in the references cited above. Choose the D8 locations such that seven of them are on the **O8**-plane at $x^9 = 0$, one at $x^9 = b$ and, for simplicity, the remaining eight at $x^9 = L$, *i.e.* on top of the second orientifold plane. For this brane arrangement $\Phi_{I'}$ has a constant bulk value Φ_b for $b \leq x^9 \leq L$ and for any such Φ_b there is a range of values for b where the type I' coupling $\lambda_{I'}$ stays small throughout the interval. The

gauge group is $SO(14) \times U(1) \times SO(16) \times U(1)^2$. If, however, we move the single D8 brane away from the orientifold plane at $x^9 = 0$ to a critical position $a(\Phi_b)$, the type I' coupling diverges at $x^9 = 0$ where the gauge theory on the world-volume of the D8 branes becomes strongly coupled. If we now use the parameter map we find that (a, L) map precisely to those values for the heterotic Wilson line and R_h for which perturbative symmetry enhancement $SO(14) \times U(1) \rightarrow E_8$ occurs.* Choosing L appropriately guarantees that the heterotic coupling is small. In the heterotic theory the additional massless states are BPS and carry winding numbers ± 1 and ± 2 . They are mapped [20,21,22,23,24] to type I' D-particles. More precisely, the heterotic states with winding number ± 1 map to states with D-particle number $\pm 1/2$. Such half D-particles necessarily sit at $x^9 = 0$ from where they cannot leave because of the \mathbb{Z}_2 orientifold symmetry. One also finds that they are massless precisely for $b = a$. The fermionic zero modes of the string connecting the half D-particle confined to the orientifold plane and the D8 branes provides the **64** spinor representation of $SO(14)$ and the anti-D-particle the conjugate spinor representation **64'**. Their $U(1)$ quantum numbers are $\pm 1/2$ respectively. The heterotic states with winding 2 map to D-particles with particle number 1. They should be viewed as threshold bound states of two half D0 particles stuck to the orientifold plane. Massless states only arise from the $\mathbf{14} \subset \mathbf{64} \times \mathbf{64}$ of $SO(14)$. The contribution to the massless spectrum from the $\overline{\text{D0}}$ brane is another **14**. The $U(1)$ quantum numbers are ± 1 . Altogether we have thus found those massless states which are needed for the gauge symmetry enhancement.

In the region between $a \leq x^9 \leq L$ the dilaton is constant and the coupling takes on its bulk value. Using the relations [19,1] $\lambda_E \sim L^{3/2}/\lambda_{I'}^{1/2}$ and $R_E \sim \sqrt{L\lambda_{I'}}$ where R_E is the radius of the dual heterotic $E_8 \times E_8$ theory measured in heterotic units $l_{\text{het}} = \sqrt{\alpha'_{\text{het}}}$ (L is measured in type I units) one sees that for $L \rightarrow \infty$ with $\lambda_{I'}$ (the bulk value) fixed, $\lambda_E \rightarrow \infty$ and $R_E \rightarrow \infty$. Since in this limit $a/L \rightarrow 0$, all eight D8 branes sit at the left boundary to which the gauge degrees of freedom are

* Note that the position of the single D8 is frozen and no $U(1)$ factor is associated with it. It has combined with $SO(14)$ in the process of symmetry enhancement.

now confined. If we start with a symmetric (under $x^9 \rightarrow L-x^9$) brane arrangement we get symmetry enhancement at both ends of the interval. *i.e.* if we place seven D8 branes on each orientifold plane, one D8 at $x^9 = a$ and one at $x^9 = L-a$, we get an enhanced $E_8 \times E_8$ symmetry. This is the HW-theory compactified on \mathbb{S}^1 , *i.e.* M theory on $R^9 \times \mathbb{S}^1 \times (\mathbb{S}^1/\mathbb{Z}_2)$. The radius of the first \mathbb{S}^1 is controlled by λ_I via the relation $\lambda_I \sim R^{3/2}$ †.

In section 4 we will study in detail a \mathbb{Z}_2 orbifold model with (perturbative) gauge group $(E_7 \times SU(2)) \times SO(16)$. The required brane configuration is as follows:

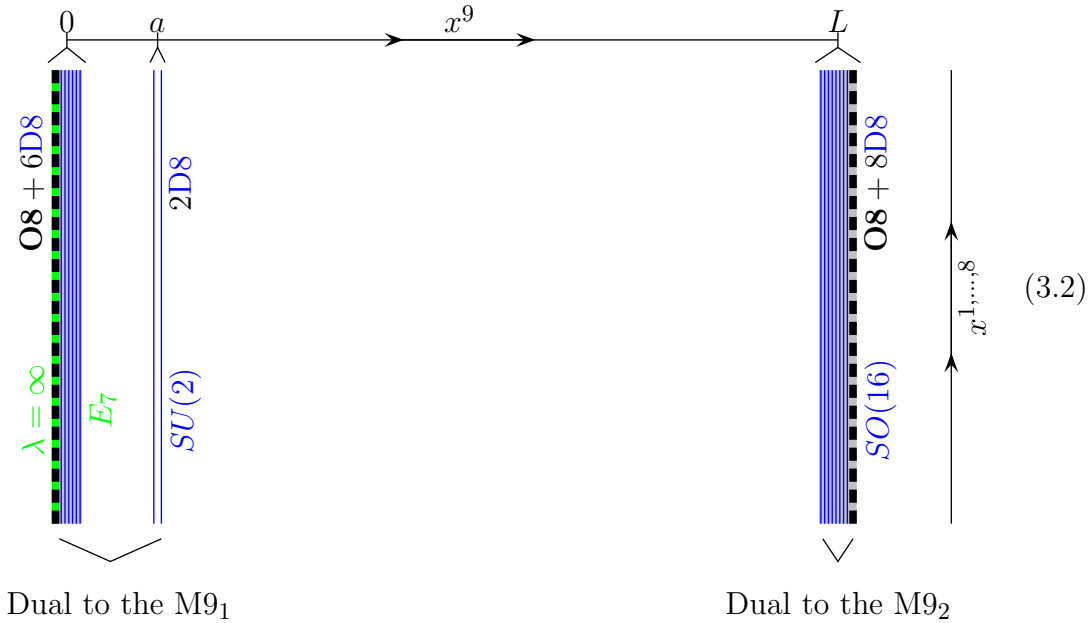

The $SO(16)$ factor is straightforward: place eight D8 branes at $x^9 = L$ with $\Phi_I(L)$ finite. As long as the coupling stays finite everywhere, the branes on the l.h.s. of the interval give $SO(12) \times U(2)$. To get E_7 we need to adjust the positions of the two ‘outlier’ D8 branes such that the coupling becomes infinite at $x^9 = 0$. The fact that two D8 branes must be placed at a critical distance a means that their center-of-mass motion is frozen and the gauge group on their world-volume is

† Similarly, starting with brane arrangements for other gauge groups $G^{(1)} \times G^{(2)} \subset E_8 \times E_8$ and keeping fixed the bulk value λ_I , one finds that in the limit $L \rightarrow \infty$ all branes sit at the boundaries. Their position moduli have become Wilson lines on the \mathbb{S}^1 .

$SU(2)$ rather than $U(2)$. With the help of the map between type I' and heterotic parameters we can again verify that this brane arrangement maps to the critical radius and Wilson line on the heterotic side where states with winding numbers ± 1 and ± 2 become massless. Again this corresponds to a half D0 brane stuck on **O8** whose fermionic zero modes provide the **32** and **32'** of $SO(12)$ with $U(1)$ charges $\pm 1/2$ and the **1** component of D0-D0 and $\overline{D0-D0}$ threshold bound states with $U(1)$ charges ± 1 [23,24]. These states, together with those from the 8-8 strings, provide the adjoint representation of E_7 .

The generalization to gauge groups $E_n \times SU(9 - n)$ is straightforward. They involve the $SO(2n - 2) \times U(1) \rightarrow E_n$ enhancement. For $0 < n < 7$ only winding states with winding number ± 1 become massless in the heterotic dual and consequently only the fermionic zero modes of half D0 and $\overline{D0}$ branes contribute. They provide the two spinor representations of $SO(2n - 2)$ which in all cases are sufficient to complete the adjoint of E_n .

At this point it seems appropriate to comment on the mixing of $U(1)$ factors [24]. As already said, in addition to the perturbative open string gauge group there are two $U(1)$ factors with gauge bosons A_μ^{RR} and $B_{9\mu}^{NS}$ originating from the bulk fields of the type I' theory. As long as the dilaton is constant across the whole interval, these do not mix with the open string gauge group. However, as we move D8 branes into the interval, mixing sets in. *E.g.* the $U(1)$ group associated with a single D8 brane outside an orientifold plane with $SO(14)$ gauge group mixes with the two additional $U(1)$ factors where the mixing depends of the distance a from the orientifold plane. The $U(1)$ which is involved in the $SO(14) \times U(1) \rightarrow E_8$ symmetry enhancement is the $U(1)$ that one gets at a . The mixing is well understood in the dual heterotic theory where it is caused by switching on Wilson lines. So, in principle, one should be able to push it through the duality chain to the type I' theory. However we have not attempted to done so.

In § 7.3. we will reconsider the T^4/\mathbb{Z}_3 model of ref. [3] where the $E_8^{(1)}$ is broken down to $E_6 \times SU(3)$ and the $E_8^{(2)}$ down to $SU(9)$. Given the brane engineering

tools at hand the first factor is straightforward to obtain in type I', but we need to introduce a new tool in order to explain the $SU(9)$ factor. Clearly, we can never get an $SU(9)$ group with eight D8 branes only; *cf.* however the discussion in [24]. To understand how it can arise, we need to elaborate further on the properties of the type I' theory at infinite coupling. In refs.[25,12,13,26] three different arguments are exploited: (i) heterotic \leftrightarrow type I' duality; (ii) the world-volume theory on a D_4 probe in the background of D8 branes and **O8** planes in type I'; (iii) M theory compactification of Calabi-Yau threefolds. Here we will restrict ourselves to a review of (i) since it is closest to the spirit of this paper. Consider the heterotic Wilson line $A = (0^{15}, \theta_{16})$. For a fixed coupling constant the moduli space of the heterotic theory is a strip in the (R_h, θ_{16}) plane bounded by $1 \geq \theta_{16} \geq 0$ and $R_h^2 \geq 2(1 - \theta_{16}^2/2)$. At a generic point on the strip the symmetry is $SO(30) \times U(1)^3$. On the boundaries $\theta_{16} = 0$ and $\theta_{16} = 1$ the gauge symmetry is enhanced to $SO(32) \times U(1)^2$. Along the R_h^2 boundary the generic symmetry is $SO(30) \times SU(2) \times U(1)^2$. However, on the lines $\theta_{16} = 0, 1/2, 1$ the symmetry is enhanced to $SO(32) \times SU(2) \times U(1)$, $SO(30) \times E_2 \times U(1)$ and $SO(34) \times U(1)$, respectively.

In the dual type I' description, the heterotic Wilson line corresponds to having 15 D8 branes at $x^9 = 0$ and one at a position $0 \leq x^9 \leq L$ which is determined by θ_{16} . In particular, $\theta_{16} = 1/2$ maps to $x^9 = L$. Due to the invariance under $\theta_{16} \rightarrow (1 - \theta_{16})$ – they lead to identical brane configurations in the perturbative type I' theory – the domain of the heterotic moduli space which maps to the perturbative type I' theory should be restricted to $R_h^2 \geq 2(1 - \theta_{16}^2/2)$ and $R_h^2 \geq 2(1 - \frac{1}{2}(1 - \theta_{16})^2)$. In particular the point with enhanced $SO(34) \times U(1)$ gauge symmetry where $R_h^2 = 1$ is not mapped to the perturbative type I' theory. In [13] an extension of the type I' description to the non-perturbative regime was proposed whereby a map of the complete heterotic moduli space to a brane configuration was achieved. It assumes that for $\theta_{16} = 1/2$ and infinite coupling at $x^9 = L$ an additional D8 brane can be extracted from the orientifold plane. For $\theta_{16} > 1/2$ the original and the new D8 branes have left the **O8** plane, leaving behind an orientifold plane of charge -9

which we will henceforth refer to as an $\mathbf{O8}^*$ plane. The relative distance between these two planes is controlled by R_h^2 and they coincide for $R_h^2 = 2(1 - \theta_{16}^2/2)$. In particular for $\theta_{16} = 1$ and $R_h^2 = 1$ they have both joined the other 15 D8 branes at $x^9 = 0$ and the gauge symmetry is enhanced to $SO(34) \times U(1)$. In the presence of an \mathbf{O}^* brane and the additional D8 brane the variation of the inverse coupling constant across the interval will change accordingly.

There is no gauge symmetry associated with an \mathbf{O}^* plane. In fact, if we put $(8+1)$ D8 branes at the critical distance from the orientifold plane we realize the $n = 0$ member of the series $E_n \times SU(9 - n)$ where E_0 denotes the trivial symmetry group of the E_n series.

We are now ready to give the dual type I' brane arrangement which reproduces the perturbative gauge group of the T^4/\mathbb{Z}_3 orbifold of [3]:

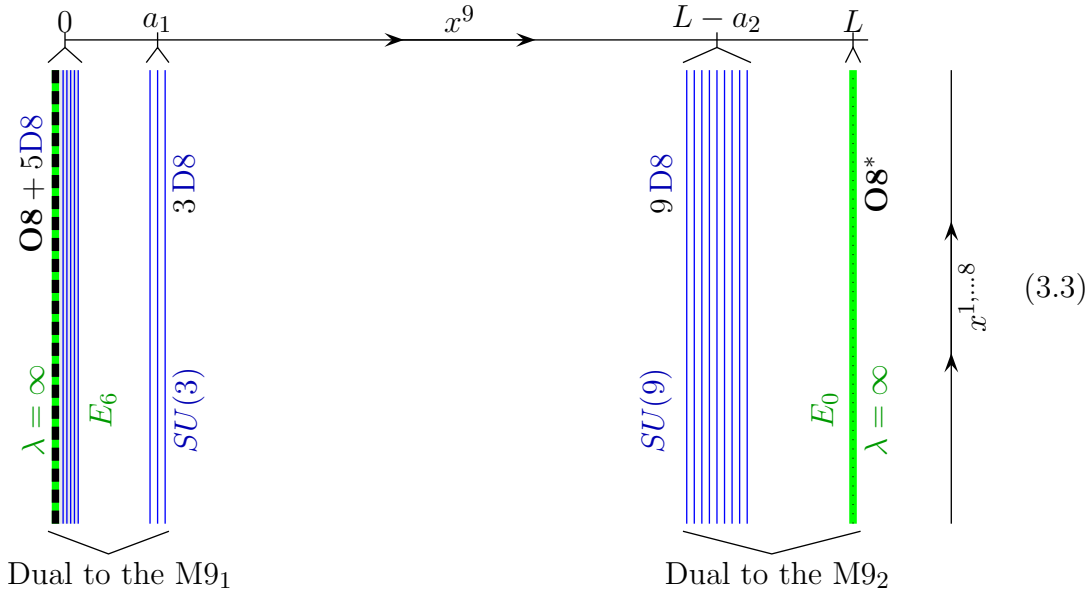

Thanks to the -9 charge of this plane, we put nine rather than eight coincident D8 branes at the critical location $L - a_2$ where they carry an $SU(9)$ SYM on their world-volume.

4. Brane Duals of the HW Orbifolds

All massless charged particles in the *untwisted* sector of a heterotic orbifold are made out of 10D $E_8 \times E_8$ SYM fields. The dynamical origin of these fields in the Hořava–Witten M theory is rather *Mysterious*, but in the previous section we saw an explanation of this *Mystery* in terms of the dual type I' superstring theory. In this section, we address HW *Mysteries* of the *twisted* sectors of heterotic orbifolds; again, our explanation involves HW \leftrightarrow type I' duality. §4.1 below relates the $\mathcal{O}6$ orbifold fixed planes in the 11D bulk of the HW brane world to the D6 branes of the superstring theory; the end-of-the-world M9 branes are addressed in §4.2 and the $\mathcal{O}6$ /M9 intersections in §4.3–4.

4.1 ORBIFOLD PLANES, D6 BRANES AND TAUB–NUTS

Massless states in twisted sectors of a heterotic orbifold live in the immediate vicinity of the appropriate fixed plane and don't care for the overall geometry of the T^4/\mathbb{Z}_N space. As far as these states are concerned, we may replace the toroidal orbifold with the non-compact space $\mathbb{C}^2/\mathbb{Z}_N$ or any other space with a similar orbifold singularity; for supersymmetry's sake, this replacement space should have $SU(2)$ holonomy, but there are no other restrictions. For simplicity, we would like a non-compact replacement space with a simple flat asymptotics; in order to make contact with the type I' theory discussed in the previous section, we choose the $\mathbb{R}^3 \times \mathbb{S}^1$ flat asymptotics [27] instead of the \mathbb{R}^4 .

The $SU(2)$ holonomy and the $\mathbb{R}^3 \times \mathbb{S}^1$ asymptotics immediately lead us to the multi–Taub–NUT geometry of N Kaluza–Klein magnetic monopoles,

$$ds^2 = V(\mathbf{x})d\mathbf{x}^2 + \frac{(dy - \mathbf{A}(x)d\mathbf{x})^2}{V(\mathbf{x})}, \quad (4.1)$$

where $y \equiv y + 2\pi R$ is a periodic coordinate of some radius R ,

$$\nabla \times \mathbf{A}(\mathbf{x}) = \nabla V(\mathbf{x}) \quad \text{and} \quad V(\mathbf{x}) = 1 + \sum_{i=1}^N \frac{(R/2)}{|\mathbf{x} - \mathbf{x}_i|}. \quad (4.2)$$

The multi-Taub-NUT geometry is smooth when all the monopoles are located at distinct points \mathbf{x}_i in the 3D space but develops a $\mathbb{C}^2/\mathbb{Z}_k$ orbifold singularity when k monopoles become coincident. In particular, when all N monopoles sit at the same point, the multi-Taub-NUT geometry is an orbifold of the simple Taub-NUT space,

$$\text{TN}_N = \text{TN}_1/\mathbb{Z}_N \quad \text{for } \mathbb{Z}_N : (\mathbf{x}, y) \mapsto (\mathbf{x}, y + \frac{2\pi R}{N}). \quad (4.3)$$

In the large radius limit $R \rightarrow \infty$ the local curvature of the Taub-NUT becomes negligible and the multi-Taub-NUT geometry approximates the flat orbifold $\text{TN}_N \approx \mathbb{C}^2/\mathbb{Z}_N$.

The main idea of this section is to replace the T^4/\mathbb{Z}_N orbifold with the TN_N geometry and then to make the Kaluza-Klein radius R small rather than large; this is legitimate because the massless twisted spectrum of the orbifold is chiral and hence independent of continuous parameters such as R . In the 11D bulk of the HW brane world, the Kaluza-Klein compactification of the M theory on a circle is dual to the type IIA superstring theory in 10 flat spacetime dimensions; for small R , the superstring is weakly coupled. In the type IIA context, each KK monopole of the multi-Taub-NUT geometry (4.1) becomes a D6 brane [Townsend] located at $(x^7, x^8, x^9) = \mathbf{x}_i$ and spanning x^0, \dots, x^6 . N coincident monopoles of the singular TN_N space become N coincident D6 branes; the open strings beginning and ending on these branes give rise to a $U(N)$ SYM theory in the D6 world volume.

From the dual M theory point of view, an open string connecting two distinct D6 branes (corresponding to an off-diagonal element of the $U(N)$ matrix) is an M2 membrane or anti-membrane wrapped around a 2-cycle of the multi-Taub-NUT geometry whose area (and hence the particle's mass) vanishes when the two KK monopoles coincide in space. The diagonal matrix elements — the open strings beginning and ending on the same D6 brane — give rise to the moduli multiplets associated with locations of the corresponding D6 branes; from the M point of view, they are the location moduli \mathbf{x}_i of the individual KK monopoles. Among these moduli, the positions of the KK monopoles *relative to each other* are moduli

of the resolutions of the \mathbb{C}/\mathbb{Z}_N orbifold singularity, but the overall center-of-mass motion of the singularity is an artifact of the non-compactness of the multi-Taub-NUT geometry. This center-of-mass motion — responsible for the abelian $U(1)$ factor of the $U(N)$ gauge group — has nothing to do with the twisted sector of the orbifold. Indeed, in the compact T^4/\mathbb{Z}_N theory, the moduli responsible for the center-of-mass motions of complete un-resolved singularities belong to the un-twisted sector of the orbifold.

Therefore, on the type IIA side of the duality, the $U(1) \subset U(N)$ associated with the center-of-mass motion of the whole stack of N coincident D6 branes is an artifact of replacing the T^4/\mathbb{Z}_N geometry with TN_N and has nothing to do with the twisted sector of the orbifold. In our subsequent analysis of the twisted sectors and their brane duals, we shall disregard such abelian factors of the D6 gauge groups and focus on the non-abelian $SU(N)$ SYM fields.

4.2 TAUB-NUTS AND BRANES AT THE END OF THE WORLD

In the complete Hořava–Witten context — including both the 11D bulk and the two end-of-the-world boundary M9 branes — the KK reduction leads to type I' rather than type IIA superstring (*cf.* section 3) and the D6 branes dual to the $\mathcal{O}6$ orbifold planes span the finite dimension of the type I' theory. Let us dub this finite dimension x^6 while (x^0, \dots, x^5) denote the 6D Minkowski space. In the HW theory, (x^7, \dots, x^{10}) are coordinates of the T^4/\mathbb{Z}_N orbifold or its TN_N replacement; in the small-radius limit of the multi-Taub-NUT geometry, we lose the $x^{10} = y$ coordinate to the KK reduction and the monopoles become D6 branes located at $(x^7, x^8, x^9) = \mathbf{x}_i = \mathbf{0}$. This naturally raises *The Question*: “*What happens to the D6 branes when they reach the ends of the world at $x^6 = 0$ and $x^6 = L$?*”

Before we answer this question however, we must first clarify what happens at $x^6 = 0, L$ away from the D6 branes. Let us start by considering the effect of orbifolding on the end-of-the-world M9 branes of the Hořava–Witten theory. For the flat toroidal orbifold T^4/\mathbb{Z}_N , at generic points of either M9 brane one has *locally*

unbroken E_8 gauge symmetry and 16 supercharges. Only at the $\mathcal{I}5 = \text{M9} \cap \mathcal{O}6$ intersections with the fixed planes of the orbifold action there is a *local* effect: The gauge symmetry is broken down to the commutant of the $\alpha : \mathbb{Z}_N \mapsto E_8$ twist and SUSY down to 8 supercharges. The multi-Taub-NUT space is not flat (apart from the singularity) but it flattens out at large distances from the coincident monopoles, hence for $|\mathbf{x}| \gg R$ we have effectively unbroken local E_8 symmetry and all 16 supercharges. Or rather, the *local* symmetry on the M9 brane is unbroken E_8 — but the KK reduction of the x^{10} coordinate introduces Wilson lines into the picture. Hence, the effective theory on the 9D boundary brane of the 10D brane world has a reduced gauge symmetry.

In a generic KK compactification on a circle, the Wilson lines would be quite arbitrary, but in the TN_N compactification (4.3) the asymptotic $S\mathcal{I}5^1$ circle at $\mathbf{x} \rightarrow \infty$ is topologically equivalent to the noncontractable loop around the \mathbb{Z}_N orbifold singularity at $\mathbf{x} = \mathbf{0}$. As a stand-in for the T^4/\mathbb{Z}_N orbifold, the TN_N compactification should have $F_{\mu\nu} = 0$ outside the singularity itself, hence topologically equivalent loops have equivalent Wilson lines. Furthermore, the non-trivial \mathbb{Z}_N Wilson line around the singularity is precisely the action of the orbifolding symmetry on the E_8 gauge fields; again, we should copy this action from the particular T^4/\mathbb{Z}_N heterotic orbifold model under consideration. The bottom line of this argument is that the Wilson line around the KK circle should be precisely the $\alpha : \mathbb{Z}_N \mapsto E_8$ twist of the heterotic orbifold; this is not an inherent constraint of the Hořava–Witten theory, but any other choice would spoil the equivalence between the T^4/\mathbb{Z}_N and the TN_N twisted sectors.

In the dual type I' superstring theory [19] the KK Wilson lines manifest themselves as brane arrangements within the $\mathbf{O}8 + 8\mathbf{D}8$ boundary stack at each end of x^6 , *cf.* section 3. From the type I' point of view, such arrangements have absolutely no relation to the D6 branes at $\mathbf{x} = \mathbf{0}$ which are dual to the orbifold fixed plane. However, in order to make use of $\text{HW} \leftrightarrow I'$ duality in the orbifold context, we must *engineer* the specific brane arrangement in which the gauge group of the 9D SYM living on each boundary is precisely the commutant of the \mathbb{Z}_N action in

the appropriate E_8 in the specific heterotic/HW orbifold under consideration. For example, for the T^4/\mathbb{Z}_2 orbifold in which $E_8^{(1)}$ is broken to $E_7 \times SU_2$ and $E_8^{(2)}$ is broken to SO_{16} we should engineer the branes to yield $E_7 \times SU_2$ near $x^6 = 0$ and SO_{16} near $x^6 = L$. As discussed in section 3, this means the following brane layout:

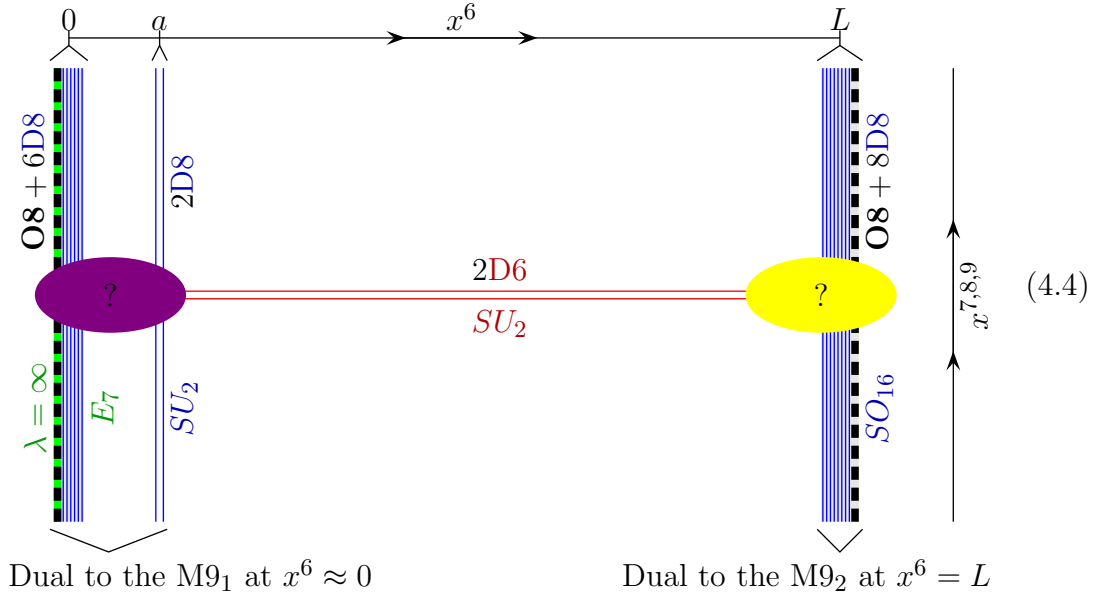

where the location a of the two ‘outlier’ D8 branes at the left end of the world is tuned such that the x^6 -dependent string coupling λ diverges at $x^6 = 0$, hence the gauge symmetry enhancement from $SO(12) \times U(2)$ to $E_7 \times SU(2)$

4.3 ENDS OF D6 BRANES: THE O8 TERMINUS

The two elliptic blots on figure (4.4) denote the two *Mysterious* $\mathcal{I}5$ regions of the HW orbifold where the $\mathcal{O}6$ fixed plane intersects the end-of-the-world M9s. In the dual type I'/D6 picture, these regions contain brane junctions amenable to string-theoretic analysis — which will finally reveal the physical origin of the boundary conditions for the 7D fields discovered in ref. [3]. Let us start with the yellow junction on the right side of fig (4.4) where all 8 D8 branes coincide with the **O8** orientifold plane at $x^6 = L$.

More generally, consider a junction of N D6 branes terminating on an **O8** orientifold plane accompanied by k D8 branes [28]. The orientifold plane acts like a mirror; combining the branes on figure (4.4) with their reflections under $x^6 \rightarrow 2L - x^6$, we have a stack of $2k$ coincident D8 branes at $x^6 = L$ crossed at the right angle with a stack of N coincident D6 branes at $\mathbf{x} = \mathbf{0}$.

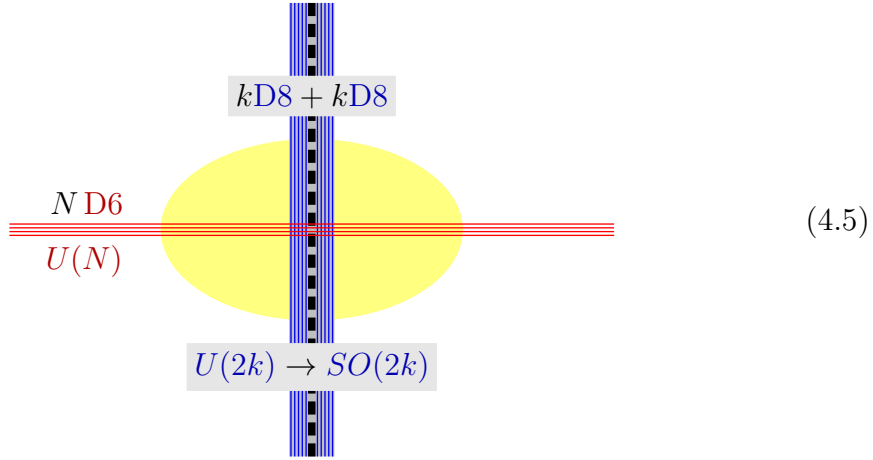

Before the orientifold projection, the open strings connecting these D branes produce the following massless particles: $U(2k)$ gauge bosons and their 9D, 16–SUSY superpartners from the **88** strings; $U(N)$ gauge bosons and their 7D, 16–SUSY superpartners from the **66** strings; 6D, 8–SUSY hypermultiplets in the bi-fundamental $(\mathbf{N}, \mathbf{2k})$ representation of the gauge group from the **68** strings. Note that only 8 out of 32 supercharges of the type II superstring survive at the D8–D6 brane junction.

Locally near $x^6 \approx L$, the **O8** orientifold projection Ω reverses $L - x^6$, transposes the Chan–Patton indices of open strings and breaks half of the supercharges. For the 7D massless modes of the **66** open strings, the three effects are independent, thus $\Omega = \Omega_1 \Omega_2 \Omega_3$ where:

- $\Omega_1 = \pm 1$ is the parity of the spatial wave function, $\psi(x^6 - L) = \Omega_1 \psi(L - x^6)$. In $x^6 \leq L$ terms, this translates into the boundary conditions for the wave functions — and hence for the corresponding fields — at the $x^6 = L$ end of the world: *Neumann BC for the Ω_1 -positive fields and Dirichlet BC for the Ω_1 -negative fields.*

- Ω_2 transposes the D6 Chan–Patton indices; in $N \times N$ matrix terms (for the two D6 indices of a **66** string), the symmetric matrices are Ω_2 –positive and the antisymmetric matrices are Ω_2 –negative.
- Ω_3 is the 6D chirality of the 8–SUSY supermultiplet; for the **O8[−]** orientifold, the vector multiplets are Ω_3 positive and the hypermultiplets are Ω_3 negative.

The states surviving the projection have $\Omega = +1$ and hence $\Omega_1 = \Omega_2\Omega_3$. Thus,

- ★ 7D fields with Neumann (free) boundary conditions at $x^6 = L$ comprise (6D) vector multiplets for the symmetric $N \times N$ matrices and hypermultiplets for the antisymmetric matrices.
- ★ The fields with Dirichlet boundary conditions comprise vector multiplets for the antisymmetric matrices and hypermultiplets for the symmetric matrices.

Note that the local gauge symmetry at $x^6 = L$ must make sense group theoretically, hence the symmetric $N \times N$ matrices must form a closed Lie algebra; such an algebra is called symplectic and denoted $Sp(N/2)$; it exists for even N only. Consequently, *the number N of **D6** branes terminating at the same generic point on an **O8[−]** orientifold plane must be even.*

In the $Sp(N/2)$ terms, the multiplet structure of the 7D fields includes one symmetric tensor multiplet $\mathbf{33}$, one irreducible antisymmetric tensor multiplet $\tilde{\mathbf{6}} = \mathbf{6} - \mathbf{1}$, and one singlet $\mathbf{1}$ — which is responsible for the center-of-mass motion of the **D6** branes and irrelevant for the HW orbifold problem. Thus, as far as the 7D $SU(N)$ SYM fields living on a \mathbb{Z}_N **O6** plane of a HW orbifold are concerned, the type I'/D6 dual theory provides the following boundary conditions:

1. Locally, at $x^6 = L$, the 7D gauge group is partially broken from $SU(N)$ down to $Sp(N/2)$;
2. (6D) vector multiplets in the adjoint $\mathbf{33}$ of the $Sp(N/2)$ and hypermultiplets in the $\tilde{\mathbf{6}}$ have Neumann boundary conditions at $x^6 = L$;
3. the remaining vector multiplets in $\tilde{\mathbf{6}}$ and hypermultiplets in the $\mathbf{33}$ have Dirichlet boundary conditions at $x^6 = L$.

Note that these are precisely the boundary conditions and the local fields we found in ref. [3] to occur at the $\mathcal{I}5_2$ intersection plane of the dual HW orbifold. In the HW theory, this combination of boundary conditions and local fields was a solution of several kinematic constraints but its dynamical origin remained a *Mystery*; this particular *Mystery* is now solved in terms of the dual type I'/D6 superstring model.

4.4 D6 BRANES TERMINATING ON D8 BRANES AND THE DIAGONAL GAUGE GROUPS.

Now consider the other terminus of the D6 branes at the $E_7 \times SU_2$ side of the $N = 2$ model, *cf.* the purple ellipse in fig (4.4). In the HW theory, the $\mathcal{O}6$ plane terminates at the $M9_1$ at $x^6 = 0$, but in the dual type I'/D6 theory this $M9_1$ becomes the whole stack of $\mathbf{O}8 + 8\mathbf{D}8$ branes spanning $0 \leq x^6 \leq a$. Hence, in the type I'/D6 model we have a choice of the allowed left termini for each of the two **D6** branes:

1. A D6 brane may cross (without termination) the two ‘outlier’ D8 branes and terminate on the orientifold plane or one of the six D8 branes at $x^6 = 0$.

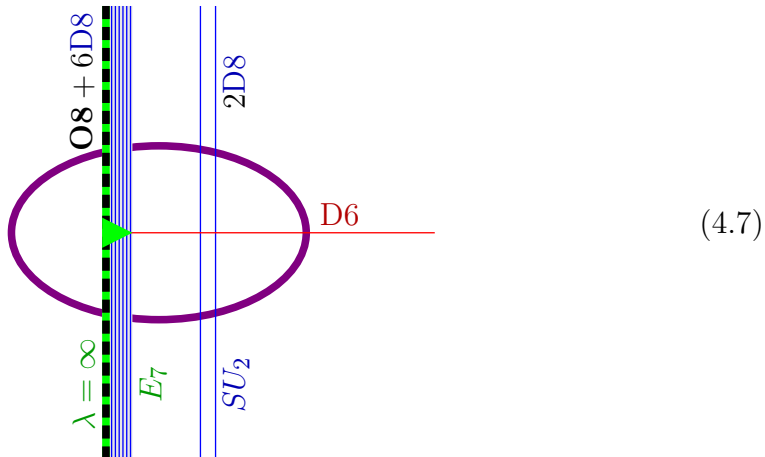

Superficially, the terminus at $x^6 = 0$ is similar to terminus at $x^6 = L$ discussed in the previous subsection, but the divergence of the string coupling at $x^6 = 0$ demands a non-perturbative re-analysis of the resulting boundary

conditions and local 6D fields. As of this writing, the physics of such $\lambda = \infty$ terminal junctions remains somewhat mysterious, but the net effect may be inferred from duality considerations; we shall return to this issue in section 7.

2. Alternatively, a D6 brane may terminate on one of the two outlier D8 branes at $x^6 = a$ without extending all the way to the true ‘end of the world’ at $x^6 = 0$.

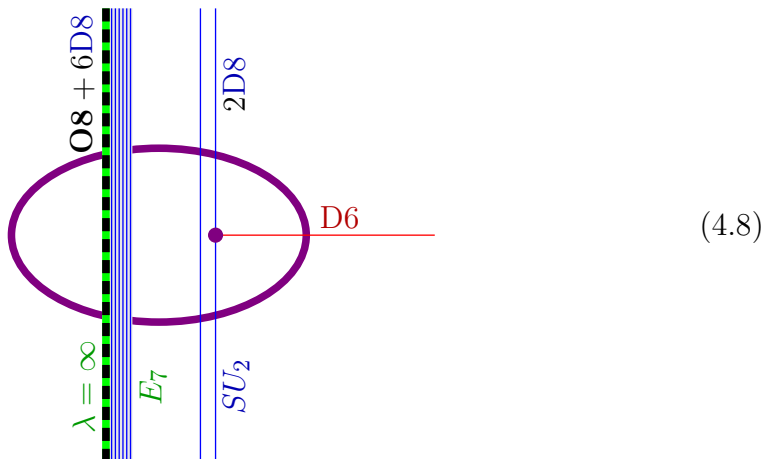

It turns out that both D6 branes of the type $I'/D6$ model dual to the T^4/\mathbb{Z}_2 heterotic orbifold should terminate in this manner at $x^6 = a$.

Indeed, for the heterotic orbifold with $E_8 \times E_8$ broken to $[E_7 \times SU(2)] \times SO(16)$, all massless twisted states are E_7 singlets. In terms of the dual type $I'/D6$ model, this implies spatial segregation between the $D6$ branes and the E_7 gauge fields living at $x^6 = 0$ — in other words, terminating the $D6$ branes at $x^6 = a > 0$. Furthermore, we need to explain the *Mystery* of the locking boundary conditions (1.2) for the $SU(2)$ fields of the HW orbifold; in the dual type $I'/D6$ terms, these boundary conditions become

$$A_\mu^{7D}(x^6 = a) = A_\mu^{9D}(\mathbf{x} = \mathbf{0}). \quad (4.9)$$

We shall see momentarily that such gauge field locking follows from each of the two $D6$ branes at $\mathbf{x} = \mathbf{0}$ terminating on a separate outlier $D8$ brane at $x^6 = a$

according to following figure:

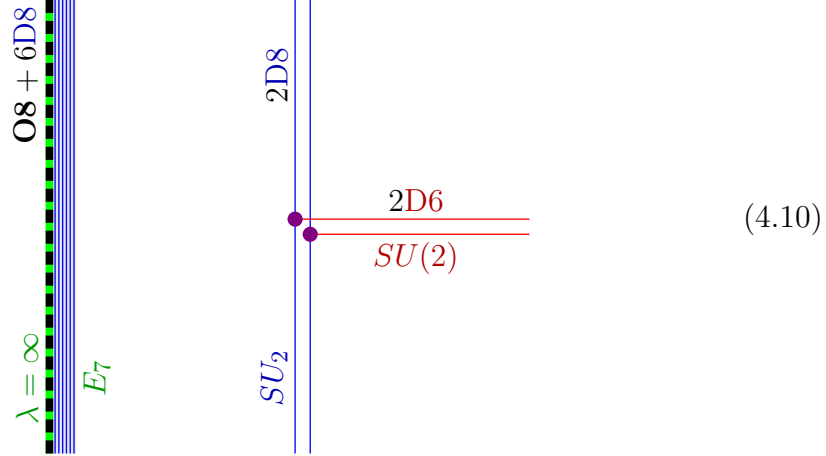

Proper understanding of the **D6–D8** brane junctions (as opposed to simple brane crossings) involves *inter alia* the mechanical tension of the D–branes. A **D6** brane pulls on the **D8** brane on which it ends and bends it out of planarity; consequently, each of the two outlier **D8** branes on figure (4.10) is located at

$$x^6 = a + \frac{\alpha'}{|\mathbf{x}|} \quad (4.11)$$

instead of simply $x^6 \equiv a$. At the junction itself ($\mathbf{x} = \mathbf{0}$) the **D8** branes are singular and the quantum string effects become important.

The simplest way to understand these effects is via T-duality. Let us compactify one of the transverse coordinates of the blue **D8** branes, *e.g.* x^7 on a large circle of radius R_7 , then T-dualize $x^7 \rightarrow \tilde{x}^7$. This duality turns the **D8** branes into **D7** branes spanning x^0, \dots, x^5 and x^8, x^9 with transverse coordinates x^6 and \tilde{x}^7 . Consequently, the co-dimension of the junction in the brane reduces from 3 down to 2, hence the bending of the brane [29] by the sideways pulling force becomes logarithmic,

$$x^6 = a + \frac{\alpha'}{R_7} \log \frac{\alpha'/R_7}{\sqrt{(x^8)^2 + (x^9)^2}} \quad (4.12)$$

instead of the Coulomb shape (4.11). The bend **D7** brane preserves 8 out of 32 supercharges of the (T-dual) type IIB superstring; to make SUSY manifest, it is

convenient to introduce complex coordinates

$$(x^6 - a) + i\tilde{x}^7 = \tilde{R}_7 \times w, \quad x^8 + ix^9 = \tilde{R}_7 \times u, \quad (4.13)$$

where $\tilde{R}_7 = \alpha'/R_7$ is the radius of the T-dual \tilde{x}^7 circle; note that w is a cylindrical coordinate, $w \equiv w + 2\pi i$. In terms of these complex coordinates, the **D7** branes span a holomorphic curve

$$w = \log \frac{1}{u}. \quad (4.14)$$

The **D6** branes at $\mathbf{x} = \mathbf{0}$ are mapped by the T-duality onto **D7'** branes spanning the \tilde{x}^7 coordinate in addition to the x^0, \dots, x^6 ; the x^8, x^9 coordinates remain transverse; in terms of the complex coordinates (4.13), the **D7'** branes are located at $u \equiv 0 \forall w$.

Now consider a single **D6** brane terminating on a single **D8** brane. The T-dual of this picture is a junction between a **D7'** and a **D7** brane. Because of the **D7** brane bending (4.14), this junction is located somewhat to the right of $x^6 = a$, *i.e.* at $\text{Re } w > 0$. Re-writing eq. (4.14) as

$$u = e^{-w}, \quad (4.15)$$

we see that for $\text{Re } w > 0$ the **D7** brane rapidly asymptotes to $u \equiv 0$. Consequently, the **D7** brane *smoothly* connects to the **D7'** brane without any discontinuity. In other words, *the whole complex of the **D8** brane and the **D6** brane terminated on it is T-dual to a single curved **D7** brane spanning* (4.15).

As a corollary, *the complex of two coincident **D6** branes terminated on two coincident **D8** branes in a one-on-one manner depicted on fig (4.10) is T-dual to a single pair of coincident smoothly curved **D7** branes.* The $U(2)$ SYM generated by the **77** open strings of the T-dual theory has exactly one local $U(2)$ gauge symmetry at every point of the **D7** world-volume. By T-duality, this means that the (4.10) complex of 2 **D6** and 2 **D8** branes has exactly one local $U(2)$ gauge

symmetry at every point of the **D6 + D8** world volume, *including the junction point* ($x^6 = a, \mathbf{x} = \mathbf{0}$). Therefore, at the junction point, the $U(2)$ gauge fields living on the **D6** world-volume and the $U(2)$ gauge fields living on the **D8** world-volume must satisfy the locking boundary condition (4.9).

In the type I'/D6 context, the locking boundary conditions (4.9) apply to the $U(2)^{7D} \times U(2)^{9D} \rightarrow U(2)^{\text{diag}}$ gauge theory involved in the brane junctions. From the M theory point of view however, the $U(1)$ center of the 9D $U(2)$ is an artifact of the KK reduction of the HW theory to the type I' superstring and, likewise, the $U(1)$ center of the 7D $U(2)$ is an artifact of the multi-Taub-NUT geometry replacing the T^2/\mathbb{Z}_2 orbifold. Hence in the HW orbifold context, the *Mysterious* locking boundary conditions (1.2) should apply to the simple $SU(2)^{7D} \times SU(2)^{10D} \rightarrow SU(2)^{\text{diag}}$ gauge theories only.

Next, consider the supermultiplet structure of the diagonal $SU(2)$ SYM theory. Locally, at every point of the T-dual **D7** world volume there are 16 unbroken supersymmetries but the dimensional reduction to the effective 6D theory preserves only 8 of the supercharges. Consequently, the 6D vector multiplets and hypermultiplets have different wave functions on the holomorphic curve (4.15). The T-dual wave functions on the **D8-D6** brane junction are governed by the boundary conditions at the junction point. Hence, by T-duality, the hypermultiplets have different boundary conditions than the vector multiplets; specifically, given the Dirichlet-like locking boundary conditions for the vector multiplets, it follows that the hypermultiplets satisfy the free (Neumann) boundary conditions. That is, at the junction point, there are both **9D** and **7D** hypermultiplets (each in the adjoint **3** representation of the diagonal $SU(2)$ gauge group) and both are free to take whatever values they like independently of each other.

Actually, we do not need T-duality to establish the Neumann boundary conditions for the **7D** hypermultiplets at the brane junction. (The **9D** fields are automatically free since they cannot possibly be pinned down at a codimension 3 junction, whatever the junction physics.) All we need to know is that at $x^6 = a$,

each of the two **D6** branes is free to move its attachment point to the **D8** brane in the three transverse dimensions $(x^7, x^8, x^9) = \mathbf{x}$ independently of the other brane. Note that from the 7D world-volume point of view, the transverse coordinates of the two **D6** branes are scalars in the 7D, 16–SUSY vector multiplets in the Cartan $U(1)^2$ subalgebra of the $U(2)$ SYM theory. Therefore, the freedom to move the attachment points of the **D6** branes in the transverse directions implies free (Neumann) boundary condition for the corresponding scalar fields. In the 6D, 8–SUSY terms, these scalars belong to hypermultiplets, hence thanks to SUSY and the non-abelian gauge symmetry, we must have Neumann boundary conditions for the entire hypermultiplets in the adjoint representation of the **7D** gauge group.

Finally, consider the **68** open strings at the **D6–D8** brane junction. In principle, such open strings may have massless modes localized at the 6D junction plane. However, the T-duality shows that this does not happen. Indeed, consider the pair of curved **D7** branes dual to the junction in question. The holomorphic curve (4.15) has an arbitrary scale \tilde{R}_7 which can be made large if desired, hence the **77** opens strings have no inherently stringy 6D massless modes trapped in the junction area. Hence the only possible localized 6D massless fields are the *normalizable* zero modes of the 8D massless fields — the $U(2)$ SYM — but the non-compact curve (4.15) does not have any normalizable zero modes. Altogether, the **77** open strings of the T-dual theory do not have any localized zero modes corresponding to massless 6D fields, and by T-duality, the **68** strings of the type $I'/D6$ model — or for that matter, the **66** or **88** strings — do not produce any massless 6D fields trapped at the junction.

To summarize, the brane junction depicted on fig. (4.10) correctly reproduces the *Mysteries* at the $E_7 \times SU(2)$ terminus of the \mathbb{Z}_2 fixed 7–plane of the HW orbifold: The $SU(2)^{7D} \times SU(2)^{9D}$ gauge symmetry is broken to the diagonal $SU(2)$ by the locking boundary conditions (4.9) while the E_7 gauge fields do not couple to the massless twisted states; the hypermultiplets satisfy the Neumann boundary conditions at the junction; and there are no massless 6D fields localized at this junction.

5. Brane Duals of Orbifolds with Broken 7D Gauge Symmetries

In the previous section we focused on the simplest example of the HW heterotic orbifold, namely the T^4/\mathbb{Z}_2 with $E_8^{(1)}$ broken down to $E_7 \times SU(2)$ and $E_8^{(2)}$ down to $SO(16)$; the type I'/D6 brane dual of this model has D-branes arranged according to

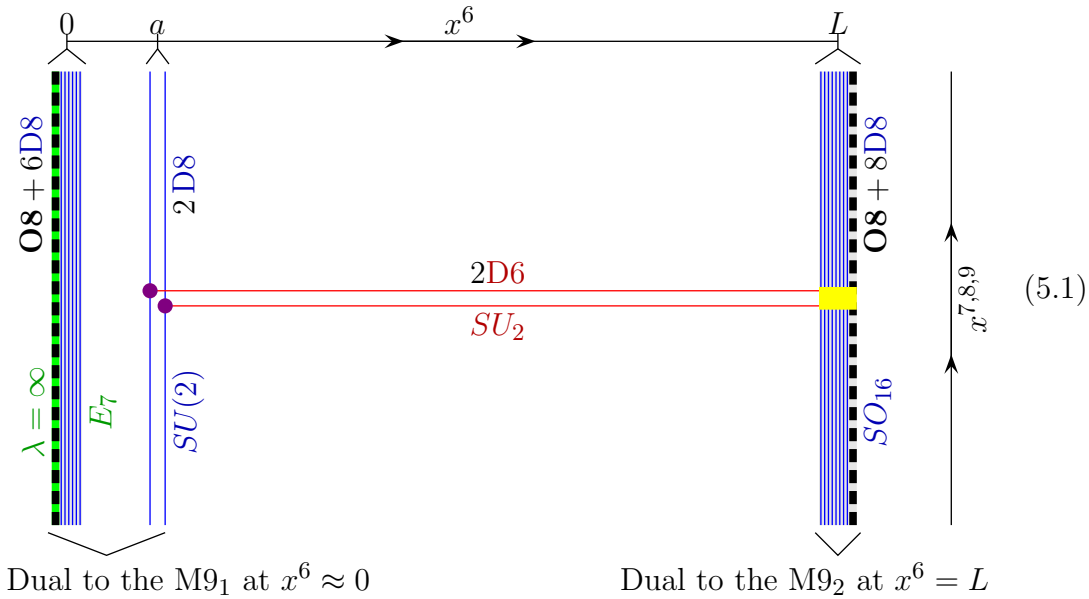

In this section, we shall brane engineer the dual models for more complicated \mathbb{Z}_3 and \mathbb{Z}_4 orbifolds in which massless twisted states are charged under abelian factors of the broken $E_8 \times E_8$ gauge symmetry. In ref. [3] we found such abelian charges to be problematic in the HW context as none of the 7D $SU(N)$ breaking patterns seemed to satisfy all the kinematic constraints. The correct solution turns out to be rather complicated or even bizarre in purely HW terms — but natural and fairly simple in terms of the type I'/D6 brane engineering.

5.1 THE SYMMETRIC \mathbb{Z}_3 ORBIFOLD

Our first model is a perturbative T^4/\mathbb{Z}_3 heterotic orbifold with both $E_8^{(1),(2)}$ gauge groups broken to $[SO(14) \times U(1)]^{(1),(2)}$ in identical fashion,[★] hence the name ‘symmetric’. The massless spectrum of this model comprises:

- Untwisted states:

SUGRA + 1 tensor multiplet (the dilaton);

184 vector multiplets in the adjoint representation of the $[SO(14) \times U(1)]^2$;

2 moduli and 156 charged hypermultiplets,

$$H_0 = (\mathbf{64}, +\frac{1}{2}; \mathbf{1}, 0) + (\mathbf{14}, -1; \mathbf{1}, 0) + (\mathbf{1}, 0; \mathbf{64}, +\frac{1}{2}) + (\mathbf{1}, 0; \mathbf{14}, -1) + 2M. \quad (5.2)$$

- Twisted states:

30 charged hypermultiplets for each of the 9 \mathbb{Z}_3 fixed points on the T^4 ,

$$H_1 = 9 \left[(\mathbf{14}, -\frac{1}{3}; \mathbf{1}, +\frac{2}{3}) + (\mathbf{1}, +\frac{2}{3}; \mathbf{14}, -\frac{1}{3}) + 2(\mathbf{1}, +\frac{2}{3}; \mathbf{1}, +\frac{2}{3}) \right]. \quad (5.3)$$

From the Hořava–Witten point of view, the charges (5.3) indicate that the abelian $U(1) \times U(1)$ gauge fields must somehow span the x^6 along the $\mathcal{O}6$ fixed planes, thus

$$U(1) \times U(1) = \text{diag} \left[(U(1) \times U(1))_{10\text{D}} \times \prod_{\text{fixed planes}} (U(1) \times U(1))_{7\text{D}} \right]. \quad (5.4)$$

Or rather

$$U(1) \times U(1) = \text{diag} \left[(U(1) \times U(1))_{10\text{D}} \times \prod_{\text{fixed planes}} (U(1) \times U(1) \subset SU(3))_{7\text{D}} \right] \quad (5.5)$$

since the actual 7D gauge symmetry living on each \mathbb{Z}_3 $\mathcal{O}6$ plane is $SU(3) \supset U(1) \times U(1)$. We shall see momentarily that the symmetry breaking (5.5) follows from

★ In lattice terms, the action of the \mathbb{Z}_3 orbifold group on each E_8 corresponds to the shift vector $\delta = (\frac{2}{3}, 0, 0, 0, 0, 0, 0, 0)$.

the boundary conditions for the 7D and 10D gauge fields at the $\mathcal{I}5 = \mathcal{O}6 \cap \text{M}9$ intersections of the HW theory, but the boundary conditions are so *Mysterious* it took us months to find them. Again, the key to this *Mystery* is provided by the brane engineering.

The general setup of the type I'/D6 brane dual of the symmetric \mathbb{Z}_3 fixed plane is quite clear:

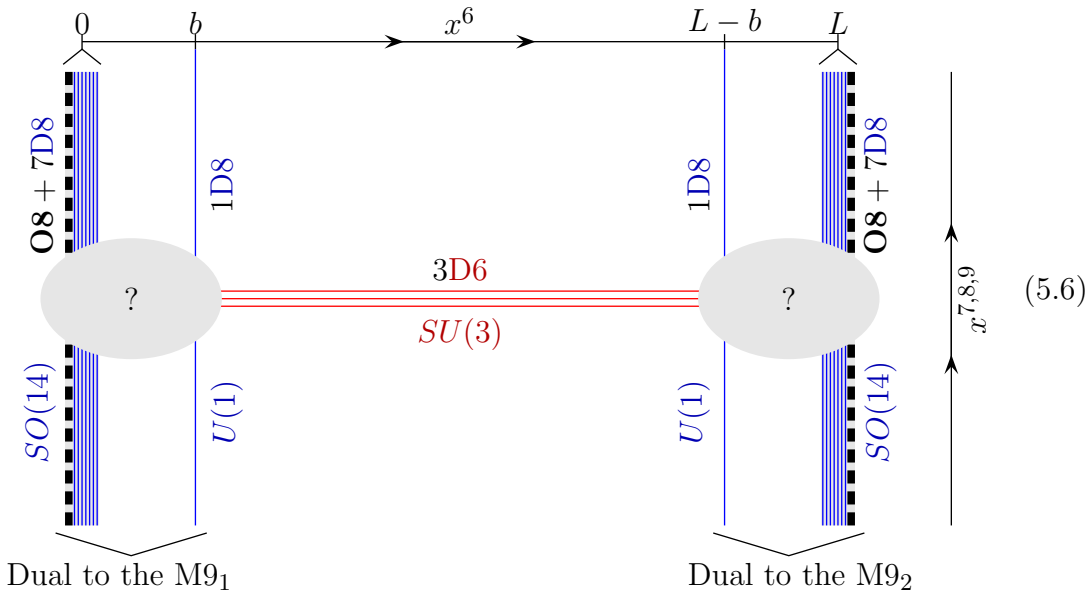

At each end of the x^6 , the distance b between the **O8** orientifold plane and the outlier **D8** brane is less than critical, hence finite string coupling λ at the orientifold plane and the 9D gauge symmetry is $SO(14) \times U(1)$ rather than E_8 , *cf.* section 3. The 7D $SU(3)$ gauge symmetry follows from three coincident **D6** branes at $\mathbf{x} = \mathbf{0}$. The only non-obvious features of the brane model — denoted by the gray areas of fig. (5.6) — are the terminal regions of the **D6** branes at the two ends of the x^6 .

The two terminal regions are related by the $E_8^{(1)} \leftrightarrow E_8^{(2)}$ symmetry of the model, so let us focus on the left terminal. The existence of twisted hypermultiplets in the vector **14** representation of the $SO(14)_1$ group living at $x^6 = 0$ indicates that at least some of the **D6** branes must reach all the way to the orientifold plane. On the other hand, we saw in section 4.3 that the net number of **D6** branes terminating

on an **O8** orientifold plane must be even. Altogether, we have 3 **D6** branes, which means that 2 of them should terminate on the orientifold plane at $x^6 = 0$ while the third **D6** terminates on the outlier **D8** brane at $x^6 = b$:

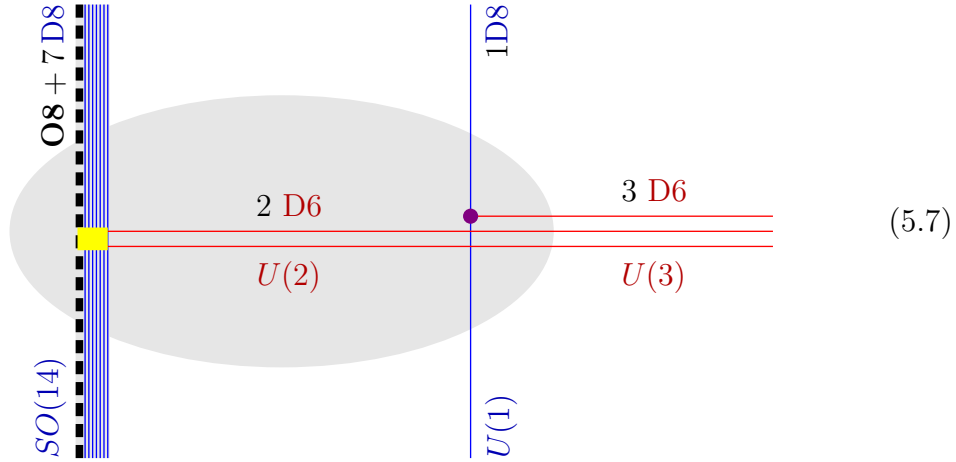

String theory of the **D6**–**D8** brane junction at $x^6 = b$ follows from T-duality along the lines of § 4.4. The outlier **D8** brane and the **D6** brane which terminates on it are together T-dual to a single curved **D7** brane at $u = e^{-w}$ (in the coordinates of eq. (4.13)) while the other two **D6** branes are T-dual to flat **D7'** branes at $u \equiv 0$:

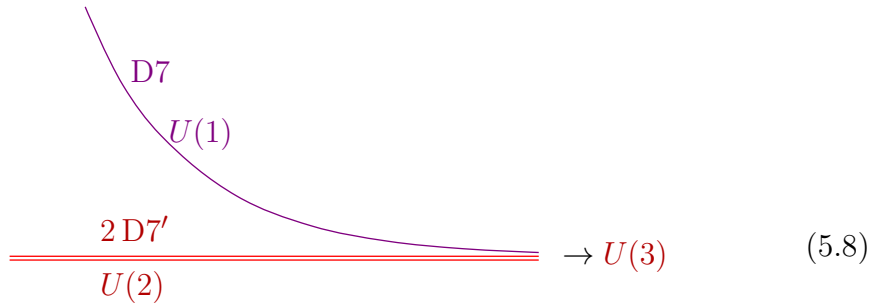

The curved **D7** brane carries a $U(1)$ gauge theory; it is T-dual to the 7D $U(1)$ for $x^6 \geq b$ locked onto a 9D $U(1)$ via boundary condition (4.9) at $x^6 = b$. At the same time, the two flat **D7'** branes carry a $U(2)$ SYM whose T-dual is obviously a 7D $U(2)$ SYM which continues from $x^6 \geq b$ to $x^6 < b$ without anything happening to it at the junction point $x^6 = b$.

The new element here are the $77'$ open strings whose length asymptotes to zero for $\text{Re } w \rightarrow +\infty$. The lowest-energy modes of these strings give rise to $U(3)/[U(1) \times U(2)]$ SYM fields which are massless in the $\text{Re } w \rightarrow +\infty$ limit but become massive for finite $\text{Re } w$ and super-heavy for $\text{Re } w \rightarrow -\infty$. From the 8D field theory point of view, we have a SYM with $U(3)$ gauge symmetry *spontaneously* broken to $U(2) \times U(1)$ by an x -dependent VEV of the adjoint scalar field. In the unitary gauge,

$$\langle \Phi \rangle = \text{diag}(1, 0, 0) \times u(w) = \text{diag}(1, 0, 0) \times e^{-w}. \quad (5.9)$$

Generally, gradients of scalar VEVs break supersymmetry but holomorphic VEVs such as (5.9) preserve half of the supercharges. Consequently, we have two different 2D wave equations for the field modes corresponding to vector and hypermultiplets in 6D, namely

$$\begin{aligned} \left[\nabla^2 - |\langle \Phi \rangle|^2 \right] (A_\mu, \psi_L) &= 0, \\ |\langle \Phi \rangle|^2 \left(\nabla \frac{1}{|\langle \Phi \rangle|^2} \nabla - 1 \right) (\phi, \psi_R) &= 0. \end{aligned} \quad (5.10)$$

In terms of the (w, w^*) coordinates, the massless vector modes satisfy

$$\left[4 \frac{\partial}{\partial w} \frac{\partial}{\partial w^*} - e^{-(w+w^*)} \right] (A_\mu, \psi_L) = 0 \quad (5.11)$$

while the massless hyper modes satisfy

$$\left[4 \frac{\partial}{\partial w} \frac{\partial}{\partial w^*} + 2 \left(\frac{\partial}{\partial w} + \frac{\partial}{\partial w^*} \right) - e^{-(w+w^*)} \right] (\phi, \psi_R) = 0; \quad (5.12)$$

furthermore, physical wavefunctions should not blow up for $\text{Re } w \rightarrow \pm\infty$. These conditions uniquely specify the 2D wavefunctions:

$$(A_\mu, \psi_L) \propto \int_1^\infty \frac{dt}{\sqrt{t^2 - 1}} \times \exp\left(-te^{-\text{Re } w}\right) \xrightarrow{\text{Re } w \rightarrow +\infty} \text{Re } w + \left(\begin{array}{c} \text{a small} \\ \text{constant} \end{array} \right) \quad (5.13)$$

for the massless 6D vector multiplets and

$$(\phi, \psi_R) \propto \int_1^\infty \frac{dt}{\sqrt{t^2 - 1}} \times t e^{-\text{Re} w} \exp\left(-t e^{-\text{Re} w}\right) \xrightarrow{\text{Re} w \rightarrow +\infty} 1 \quad (5.14)$$

for the massless hypermultiplets. Note that both wavefunctions describe (the zero energy limit of) unbound motion of a particle in the semi-infinite $\text{Re} w \gtrsim 0$ region; there are no bound states.

In T-dual terms, we have a 7D $U(3)$ SYM living on the three **D6** branes at $x^6 \geq b$. At the junction, the $U(3)$ group is abruptly broken to its $U(1) \times U(2)$ subgroup while the remaining $U(3)/[U(1) \times U(2)]$ SYM fields satisfy reflecting boundary conditions at $x^6 = b$. According to eqs. (5.13) and (5.14), the boundary conditions are Dirichlet for the 8-SUSY vector multiplet fields and Neumann for the hypermultiplet fields. Furthermore, there are no massless 6D fields localized at the junction. Although classically the **68** open strings have zero length at the junction, they do not have massless modes because of world-sheet quantum corrections. Indeed, the **68** strings are T-dual to the **7'7** strings giving rise to the $U(3)/[U(1) \times U(2)]$ SYM fields — which have no *normalizable* zero modes localized in the junction area.

The above discussion concerns the **D6–D8** junction at $x^6 = b$. There is another junction at $x^6 = 0$ — denoted by the yellow rectangle in fig. (5.7) — where two **D6** branes reach the **O8** orientifold plane accompanied by seven **D8** branes. As explained in §4.3, at this second junction the $U(2)$ gauge symmetry is broken to $Sp(1) = SU(2)$, the **3** vector multiplets satisfy Neumann boundary conditions at $x^6 = 0$ while the **3** hypermultiplets satisfy Dirichlet conditions and the **86** open strings give rise to localized 6D massless particles forming half-hypermultiplets in the **(2, 14)** representation of the $SU(2) \times SO(14)$ gauge group.

The two junctions at $x^6 = b$ and $x^6 = 0$ are distinct in the type I'/D6 theory, but in the Hořava–Witten theory $b \rightarrow 0$ and the two junctions collapse into a single

$\mathcal{I}5$ intersection plane. The local physics on this plane is simply the net effect of the two junctions of the dual type I'/D6 model translated into HW orbifold terms:

1. The 7D $SU(3)$ gauge symmetry (we discard the $U(1)$ center of the $U(3)$ as explained in §4.2) is broken to $SU(2) \times U(1)$. Furthermore, the $U(1) \subset SU(3)$ and the 10D $U(1) \subset E_8$ are broken to the diagonal $U(1)$. The net gauge symmetry on the intersection plane is therefore

$$G_{\text{local}}^{6\text{D}} = SU(2) \times U(1) \times SO(14) \quad (5.15)$$

2. The local 6D massless fields at the $\mathcal{I}5$ comprise a half-hypermultiplet in the $(\mathbf{2}, 0, \mathbf{14})$ representation of (5.15).
3. The 7D SYM fields have boundary conditions depending on their $SU(2) \times U(1)$ and 8-SUSY quantum numbers. Decomposing the $SU(3)$ adjoint $\mathbf{8}$ as $(\mathbf{3}, 0) + (\mathbf{1}, 0) + (\mathbf{2}, \pm 1)$ and 16-SUSY vector multiplet as 8-SUSY vector + hyper-multiplets, we have

$$\begin{aligned} (\mathbf{3}, 0) \text{ vector: Neumann b.c.,} & \quad (\mathbf{3}, 0) \text{ hyper: Dirichlet b.c.,} \\ (\mathbf{1}, 0) \text{ vector: Locking b.c.,} & \quad (\mathbf{1}, 0) \text{ hyper: Neumann b.c.,} \\ (\mathbf{2}, \pm 1) \text{ vector: Dirichlet b.c.,} & \quad (\mathbf{2}, \pm 1) \text{ hyper: Neumann b.c.} \end{aligned} \quad (5.16)$$

Note that the boundary conditions (5.16) are rather complicated compared to the models presented in ref. [3] — where all vector multiplets at the same boundary had similar boundary conditions and ditto for the hypermultiplets. Furthermore, the specific gauge symmetry breaking (5.15) following from the conditions (5.16) is totally counter-intuitive from the heterotic point of view; indeed, the unbroken $SU(2)$ factor of the local symmetry (5.15) does not exist in the heterotic orbifold's spectrum and the twisted states' charges (5.3) do not indicate any hidden $SU(2)$ symmetry either. A bit later in this section, we shall brane engineer the removal of this unwanted $SU(2)$ from the massless spectrum of the 6D theory, but first we would like to show that its existence as a local symmetry at the $\mathcal{I}5$ is crucial to the local anomaly cancellations.

Indeed, the locally visible charged chiral fields at the intersection plane weighed by their contributions to the local anomaly (*cf.* section 2) comprise

$$\begin{aligned}
Q_6 &= \frac{1}{2}(\mathbf{2}, \mathbf{0}, \mathbf{14}), \\
Q_7 &= \frac{1}{2}[2(\mathbf{2}, +\mathbf{1}, \mathbf{1})\mathbf{1} + (\mathbf{1}, \mathbf{0}, \mathbf{1}) - (\mathbf{3}, \mathbf{0}, \mathbf{1})], \\
Q_{10} &= \frac{1}{9}[(\mathbf{1}, +\frac{1}{2}, \mathbf{64}) + (\mathbf{1}, -\mathbf{1}, \mathbf{14}) - (\mathbf{1}, \mathbf{0}, \mathbf{91}) - (\mathbf{1}, \mathbf{0}, \mathbf{1})],
\end{aligned} \tag{5.17}$$

and it's a matter of (boring) algebra to verify conditions (2.11) and (2.12) of complete anomaly cancellation. Specifically, the magnetic charge g vanishes for the symmetric orbifold, thus

$$\dim(Q = Q_6 + Q_7 + Q_{10}) = 0 + \frac{121}{9} \tag{5.18}$$

which provides for cancellation of the irreducible $\text{tr}(R^4)$ anomaly, and

$$\begin{aligned}
\mathcal{A}' &= \frac{2}{3} \text{Tr}_Q(F^4) - \frac{1}{6} \text{tr}(R^2) \times \text{Tr}_Q(F^2) + \frac{1}{18} (\text{tr}(R^2))^2 \\
&= 0 + \left(\text{tr} F_{SO(14)}^2 + 2F_{U(1)}^2 - \frac{1}{2} \text{tr} R^2 \right) \times \left(\text{tr} F_{SU(2)}^2 + \frac{4}{3} F_{U(1)}^2 - \frac{1}{9} \text{tr} R^2 \right)
\end{aligned} \tag{5.19}$$

which lets the rest of the one-loop anomaly cancel against the inflow and intersection anomalies.*

It is very important that the $(\text{tr} F_{SU(2)}^2)^2$ term cancels out of the one-loop anomaly (5.19) because the inflow and intersection anomalies cannot possibly cancel un-mixed anomalies of gauge symmetries of purely 7D origins. Such cancellation requires both hyper- and vector multiplets with non-trivial $SU(2)$ quantum numbers to be locally visible at the intersection plane — and of course the vector multiplets are the 7D fields with Neumann boundary conditions which are responsible for the $SU(2)$'s existence in the first place. Now suppose we did not have the unbroken $SU(2)$ but only its $U(1)$ subgroup (which eventually mixes with the $U(1) \subset E_8^{(2)}$ at the other end of x^6). In such a hypothetical model, two out of **3**

* Actually, the inflow anomaly vanishes for this model because of $g = 0$.

vector multiplets would have Dirichlet rather than Neumann boundary condition and the only vector multiplet visible at the intersection plane would be the generator of the $U(1)$ — which is neutral. On the other hand, there would be plenty of locally present $U(1)$ -charged hypermultiplets — and we would be stuck with the resulting $F_{U(1)}^4$ local anomaly we would have no way of canceling.

In other words, cancellation of the $F_{U(1)}^4$ local anomaly requires local presence of $U(1)$ -charged vector multiplets — and hence embedding the $U(1)$ into a locally unbroken non-abelian symmetry group. For the \mathbb{Z}_3 model in question, local anomaly cancellation favors local spectrum (5.17) and hence boundary condition (5.16). Such boundary conditions are very strange from the heterotic point of view; discovering them without the benefit of the dual type I'/D6 model would have been rather difficult.

Our next task is therefore to brane engineer the correct twisted spectrum (5.3) of the heterotic orbifold; in particular, we need to break the un-observed $SU(2)$ symmetry. In the dual type I'/D6 model, let us shift our attention from the left terminus (5.7) of the three D6 branes to the big picture (5.6). Thanks to $E_8^{(1)} \leftrightarrow E_8^{(2)}$ symmetry of the model, the right terminus of the D6 branes also looks like (5.7) (modulo $x^6 \rightarrow L - x^6$), but this leaves open the question whether the D6 branes terminating on the outlier D8 branes on the left and on the right are two ends of the same D6 brane or two distinct D6 branes. Thus we have two distinct brane models, namely

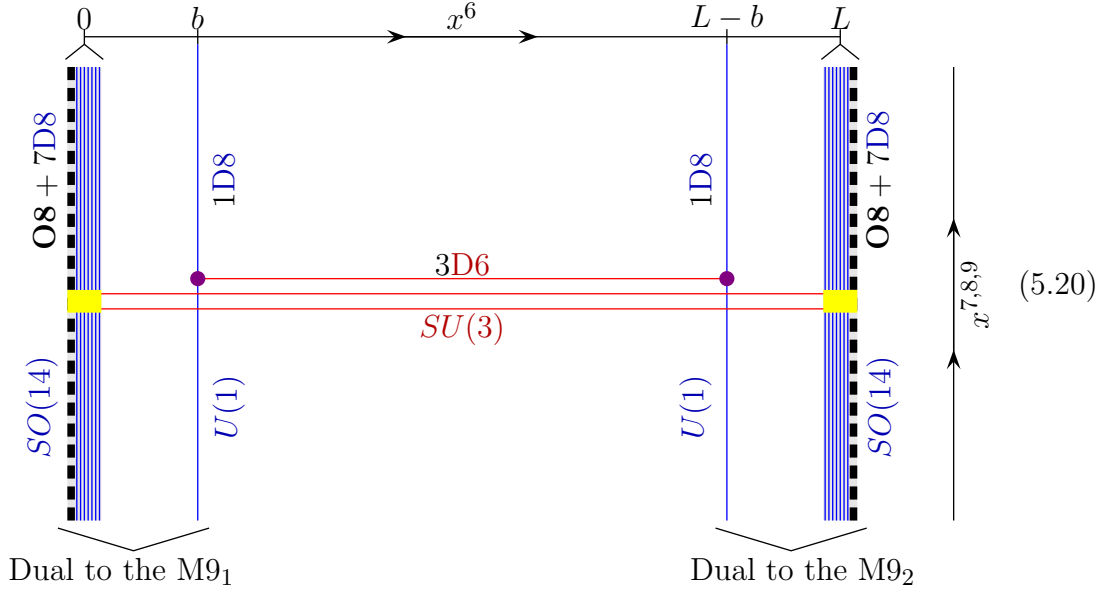

and

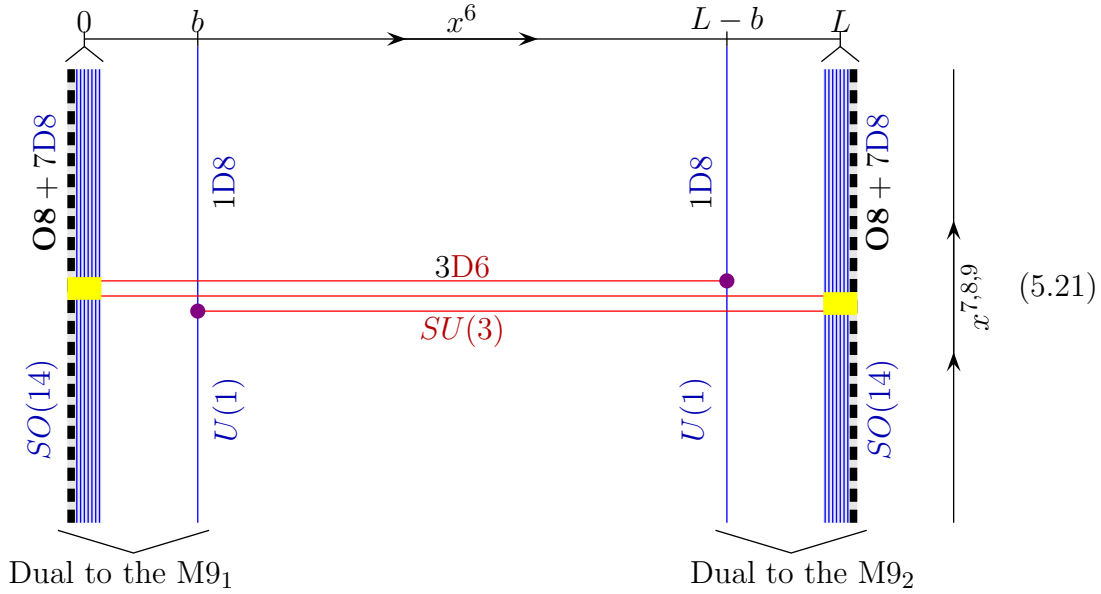

In each model, the 7D $SU(3)$ gauge symmetry is broken down to an $SU(2) \times U(1)$ subgroup at both purple junctions ($x^6 = b$ and $x^6 = (L-b)$), but there is one crucial difference: In the first model (5.20), the two junctions preserve *the same* $SU(2) \times U(1) \subset SU(3)$ at both ends, hence the same **3** 7D gauge fields have Neumann

boundary conditions at both ends of x^6 and therefore zero modes. Consequently, the 6D effective theory contains massless $SU(2)$ gauge fields of purely 7D origin. In the dual heterotic terms, this means a *non-perturbative* 6D $SU(2)$ SYM at each fixed plane of the T^4/\mathbb{Z}_3 orbifold in addition to the perturbative gauge fields in the untwisted sector. This is a very interesting heterotic string model in its own right, but unfortunately it is quite different from the perturbative T^4/\mathbb{Z}_3 orbifold we started from.

By contrast, in the second model (5.21) the two purple junctions preserve two *different* $SU(2) \times U(1)$ subgroups of the $SU(3)$.[★] Because of this mis-alignment, the 3 vector fields with Neumann boundary conditions at $x^6 = b$ have Dirichlet or locking boundary conditions at $x^6 = (L - b)$ and vice versa, hence no zero modes and no purely non-perturbative vector multiplets in the twisted sector of the heterotic orbifold. The abelian $U(1) \times U(1) \subset SU(3)$ vector fields which mix with the 9D abelian fields according to eq. (5.5) belong to the overlap of the two surviving subgroups of the $SU(3)$ at each junction,

$$[SU(2) \times U(1)]_1 \cap [SU(2) \times U(1)]_2 = U(1) \times U(1). \quad (5.22)$$

To keep track of the $U(1) \times U(1)$ charges of various 7D fields we need two orthogonal commuting generators of the $SU(3)$. The $SU(3) \rightarrow [SU(2) \times U(1)]_1 \rightarrow U(1) \times U(1)$ chain of symmetry breaking suggests

$$T_1 = \text{diag}(+\frac{1}{2}, -\frac{1}{2}, 0) \quad \text{and} \quad Y_1 = \text{diag}(+\frac{1}{3}, +\frac{1}{3}, -\frac{2}{3}) \quad (5.23)$$

while the $SU(3) \rightarrow [SU(2) \times U(1)]_2 \rightarrow U(1) \times U(1)$ chain suggests

$$T_2 = \text{diag}(0, +\frac{1}{2}, -\frac{1}{2}) \quad \text{and} \quad Y_2 = \text{diag}(-\frac{2}{3}, +\frac{1}{3}, +\frac{1}{3}); \quad (5.24)$$

★ To be precise, the two subgroups are equivalent via an $SU(3)$ isomorphism $W \neq 0$. In gauge invariant terms, $W = \text{P exp}\left(\int_b^{L-b} A_6 dx^6\right) \times$ a non-trivial element of the Weyl group of the $SU(3)$.

the two sets of charges are related to each other according to

$$\left\{ \begin{array}{l} T_1 = -\frac{1}{2}T_2 - \frac{3}{4}Y_2 \\ Y_1 = +T_2 - \frac{1}{2}Y_2 \end{array} \right\} \Leftrightarrow \left\{ \begin{array}{l} T_2 = -\frac{1}{2}T_1 + \frac{3}{4}Y_1 \\ Y_2 = -T_1 - \frac{1}{2}Y_1 \end{array} \right\}. \quad (5.25)$$

For completeness sake, the table below lists both sets of charges as well as boundary conditions for the all the 7D SYM fields.

Charges		Boundary Conditions	
(T_1, Y_1)	(T_2, Y_2)	8-SUSY vector	hyper
$(\pm 1, 0)$	$(\mp \frac{1}{2}, \mp 1)$	(Neumann, Dirichlet)	(Dirichlet, Neumann)
$(\pm \frac{1}{2}, \pm 1)$	$(\pm \frac{1}{2}, \mp 1)$	(Dirichlet, Dirichlet)	(Neumann, Neumann)
$(\mp \frac{1}{2}, \pm 1)$	$(\pm 1, 0)$	(Dirichlet, Neumann)	(Neumann, Dirichlet)
$(0, 0)$	$(0, 0)$	(locking, Neumann)	(Neumann, Dirichlet)
$(0, 0)$	$(0, 0)$	(Neumann, locking)	(Dirichlet, Neumann)

(5.26)

As promised, none of the vector multiplets have Neumann–Neumann boundary conditions. On the other hand, two hypermultiplets with similar charges[†] have Neumann–Neumann conditions and hence zero modes. In the dual heterotic terms, these two zero modes manifest themselves as twisted hypermultiplets charged with respect to $U(1) \times U(1)$ (thanks to the 10D/7D abelian field mixing (5.5)) but singlets with respect to $SO(14) \times SO(14)$. And indeed the twisted spectrum (5.3) of the perturbative heterotic orbifold contains precisely two such singlets per fixed point of the T^4/\mathbb{Z}_3 .

Altogether, the hypermultiplets localized at $\mathbf{x} = \mathbf{0}$ in the brane model (5.21) comprise one $\mathbf{14}$ of the $SO(14)_1$ at $x^6 = 0$, one $\mathbf{14}$ of the $SO(14)_2$ at $x^6 = L$, and two singlets from zero modes spanning the whole x^6 .

- The $(\mathbf{14}, \mathbf{1})$ fields have abelian charges $(T_1 = \frac{1}{2}, Y_1 = 0)$ (from $\frac{1}{2}(\mathbf{2}, 0)$ of the $[SU(2) \times U(1)]_1$ local symmetry at $x^6 = 0$) and hence $(T_2 = -\frac{1}{4}, Y_2 = -\frac{1}{2})$.

[†] For a hypermultiplet, the overall sign of all its charges is a matter of convention. Hence, two hypermultiplets with exactly opposite charges are equivalent to two hypermultiplets with identical charges.

- Likewise, the $(\mathbf{1}, \mathbf{14})$ fields have abelian charges $(T_2 = \frac{1}{2}, Y_2 = 0)$ and hence $(T_1 = -\frac{1}{4}, Y_1 = +\frac{1}{2})$.
- Finally, the two $(\mathbf{1}, \mathbf{1})$ singlet fields have $(T_1 = +\frac{1}{2}, Y_1 = +1)$ and $(T_2 = +\frac{1}{2}, Y_2 = -1)$.

Comparing this spectrum to the heterotic twisted spectrum (5.3) we see full agreement, provided we identify the abelian $U(1) \times U(1)$ charges according to

$$\begin{aligned}
C_1^{\text{heterotic}} &= C_{U(1) \subset E_8^{(1)}}^{\text{HW}} + \sum_{\text{fixed planes}} [Y_1 - \frac{2}{3}T_1 = \frac{4}{3}T_2], \\
C_2^{\text{heterotic}} &= C_{U(1) \subset E_8^{(2)}}^{\text{HW}} + \sum_{\text{fixed planes}} [-Y_2 - \frac{2}{3}T_2 = \frac{4}{3}T_1].
\end{aligned} \tag{5.27}$$

Weirdly, the observed abelian symmetries (5.5) of the heterotic \mathbb{Z}_3 orbifold mix the 10D abelian charge living on the left end of the world with the 7D charge that happens to be part of an unbroken non-abelian symmetry $SU(2)_2$ at the right end of the world and vice versa. In section 7 we shall see similar coincidences happening for other orbifold models; alas, we have no explanation for this phenomenon. Instead, we have an independent confirmation of the charges (5.27) through the gauge couplings of the model.

Specifically, the $(\frac{4}{3}T_2, \frac{4}{3}T_1)$ 7D abelian charges at each fixed plane come with gauge couplings

$$\begin{aligned}
\frac{1}{g_{7D}^2[U(1) \times U(1)]} &= \frac{1}{g^2[SU(3)]} \times \begin{pmatrix} \text{tr}(\frac{4}{3}T_2)^2 & \text{tr}((\frac{4}{3}T_2)(\frac{4}{3}T_1)) \\ \text{tr}((\frac{4}{3}T_2)(\frac{4}{3}T_1)) & \text{tr}(\frac{4}{3}T_1)^2 \end{pmatrix}^{\ddagger} \\
&= \frac{1}{g^2[SU(3)]} \times \begin{pmatrix} \frac{16}{9} & -\frac{8}{9} \\ -\frac{8}{9} & \frac{16}{9} \end{pmatrix},
\end{aligned} \tag{5.28}$$

hence the observed abelian charges (5.27) have

$$\frac{1}{g^2[U(1) \times U(1)]} = \frac{2}{g^2[E_8 \times E_8]} + \frac{9}{g^2[SU(3)]} \times \begin{pmatrix} \frac{16}{9} & -\frac{8}{9} \\ -\frac{8}{9} & \frac{16}{9} \end{pmatrix} \tag{5.29}$$

\ddagger Note normalization $\text{tr} \equiv 2 \text{Tr}_3$.

where the factor 9 in the second term stems from 9 fixed planes of the T^4/\mathbb{Z}_3 orbifold. (The factor 2 in the first term comes from the normalization of the $U(1) \subset E_8$ charges, $\frac{1}{30} \text{Tr}_{\mathbf{248}}(C_{U(1) \subset E_8})^2 = 2$.) The two E_8 couplings are equal for the symmetric \mathbb{Z}_3 orbifold (12 instantons in each E_8 hence $k_1 = k_2 = 0$), thus in terms of the coefficients v, \tilde{v} in eq. (2.5) the abelian charges have

$$v[U(1) \times U(1)] = \begin{pmatrix} 2 & 0 \\ 0 & 2 \end{pmatrix}, \quad \tilde{v}[U(1) \times U(1)] = \begin{pmatrix} 16 & -8 \\ -8 & 16 \end{pmatrix}. \quad (5.30)$$

On the other hand, for any perturbative heterotic model in 6D, the coefficients v, \tilde{v} follow from the model's massless spectrum via factorization of the net 6D anomaly polynomial according to eq. (2.2). Evaluating and factorizing the anomaly polynomial for the symmetric T^4/\mathbb{Z}_3 orbifold model is a straightforward albeit tedious exercise which eventually yields

$$\begin{aligned} v[SO(14)_1] = v[SO(14)_2] = 1, & \quad v[U(1) \times U(1)] = \begin{pmatrix} 2 & 0 \\ 0 & 2 \end{pmatrix}, \\ \tilde{v}[SO(14)_1] = \tilde{v}[SO(14)_2] = 0, & \quad \tilde{v}[U(1) \times U(1)] = \begin{pmatrix} 16 & -8 \\ -8 & 16 \end{pmatrix}, \end{aligned} \quad (5.31)$$

in full agreement with eq. (5.30) based on the specific charges (5.27).

To summarize, we have a HW description of the symmetric T^4/\mathbb{Z}_3 heterotic orbifold which passes all the consistency conditions, the twisted spectrum, the gauge couplings, the local anomalies, the works. Furthermore, this description is based on the type I'/D6 brane model (5.21) which explains all the *M*ysterious phenomena at the $\mathcal{I}5$ intersection planes. Indeed, the fairly straightforward logic of brane engineering leads directly to the correct HW solution — which looks weird but works well.

5.2 A \mathbb{Z}_4 MODEL

Our next model is a T^4/\mathbb{Z}_4 heterotic orbifold in which the first $E_8^{(1)}$ is broken to $SO(12) \times SU(2) \times U(1)$ (lattice shift vector $\delta_1 = (-\frac{3}{4}, \frac{1}{4}, 0, 0, 0, 0, 0, 0)$) while the second $E_8^{(2)}$ is broken to $SO(16)$ (shift vector $\delta_2 = (1, 0, 0, 0, 0, 0, 0, 0)$). In terms of the unbroken subgroups, the $\alpha_1 : \mathbb{Z}_4 \mapsto E_8^{(1)}$ twist acts according to

$$\begin{aligned} \alpha_1(\mathbf{248}) = & + [(\mathbf{66}, \mathbf{1}, 0) + (\mathbf{1}, \mathbf{3}, 0) + (1, 1, 0)] - [(\mathbf{32}', \mathbf{2}, 0) + (\mathbf{1}, \mathbf{1}, \pm 2)] \\ & + i [(\mathbf{32}, \mathbf{1}, +1) + (\mathbf{12}, \mathbf{2}, -1)] - i [(\mathbf{32}, \mathbf{1}, -1) + (\mathbf{12}, \mathbf{2}, +1)]. \end{aligned} \quad (5.32)$$

while the $\alpha_2 : \mathbb{Z}_4 \mapsto E_8^{(2)}$ twist acts as

$$\alpha_2(\mathbf{248} = \mathbf{120} + \mathbf{128}) = +(\mathbf{120}) - (\mathbf{128}). \quad (5.33)$$

Note $(\alpha_2)^2 = 1$, hence all massless hypermultiplets in the untwisted and the doubly-twisted sectors are singlets with respect to the $SO(16) \subset E_8^{(2)}$. Altogether, the massless spectrum of this model comprises:

- In the untwisted sector: SUGRA+1 tensor multiplet (the dilaton); 190 vector multiplets in the adjoint representation of the

$$G = [SO(12) \times SU(2) \times U(1)] \times SO(16); \quad (5.34)$$

2 moduli and 56 charged hypermultiplets,

$$H_0 = (\mathbf{12}, \mathbf{2}, +1; \mathbf{1}) + (\mathbf{32}, \mathbf{1}, -1; \mathbf{1}) + 2M. \quad (5.35)$$

- In the singly-twisted sector: 32 charged hypermultiplets for each of the 4 \mathbb{Z}_4 fixed points on the T^4 ,

$$H_1 = 4(\mathbf{1}, \mathbf{2}, -\frac{1}{2}; \mathbf{16}). \quad (5.36)$$

- In the doubly-twisted sector:

$$H_2 = 6 \times \frac{1}{2}(\mathbf{32}, \mathbf{1}, 0; \mathbf{1}) + 10 \times \frac{1}{2}(\mathbf{12}, \mathbf{2}, 0; \mathbf{1}) + 32(\mathbf{1}, \mathbf{1}, +1; \mathbf{1}). \quad (5.37)$$

In terms of individual $\mathcal{O}6$ fixed planes, the orbifold has 6 \mathbb{Z}_2 fixed planes where the $E_8^{(1)}$ is broken to $[E_7 \supset SO(12) \times SU(2)] \times [SU(2) \supset U(1)]$, the $E_8^{(2)}$ remains unbroken and the twisted hypermultiplets comprise $\frac{1}{2}(\mathbf{56}, \mathbf{1}; \mathbf{1}) + 2(\mathbf{1}, \mathbf{2}; \mathbf{1})$, plus 4 \mathbb{Z}_4 fixed planes each having gauge symmetry (5.34) and twisted hypermultiplets

$$H_{\text{tw}} = (\mathbf{1}, \mathbf{2}, -\frac{1}{2}; \mathbf{16}) + \frac{1}{2}(\mathbf{12}, \mathbf{2}, 0; \mathbf{1}) + 2(\mathbf{1}, \mathbf{1}, +1; \mathbf{1}). \quad (5.38)$$

In the HW picture, the twisted states' charges (5.38) require the $SU(2) \times U(1)$ gauge fields to span the x^6 dimension between the end-of-the-world M9 branes along the $\mathcal{O}6$ fixed planes, thus

$$SU(2) \times U(1)_{\text{net}} = \text{diag} \left[(SU(2) \times U(1))_{10\text{D}} \times \prod_{\substack{\mathbb{Z}_4 \text{ fixed} \\ \text{planes}}} (SU(2) \times U(1))_{7\text{D}} \right]. \quad (5.39)$$

(The 7D gauge fields on the \mathbb{Z}_2 fixed planes do not participate in this mixing, *cf.* discussion of the $[E_7 \times SU(2)] \times E_8^{(2)}$ model in ref. [3].) The actual 7D gauge symmetry on a \mathbb{Z}_4 fixed plane is of course $SU(4)$; somehow, we need to break it down to a non-maximal $SU(2) \times U(1)$ subgroup, then impose locking boundary conditions on the 7/10 D $SU(2) \times U(1)$ fields at the $\mathcal{I}5_1$ intersection.

Again, the solution comes courtesy of the dual type I'/D6 brane model:

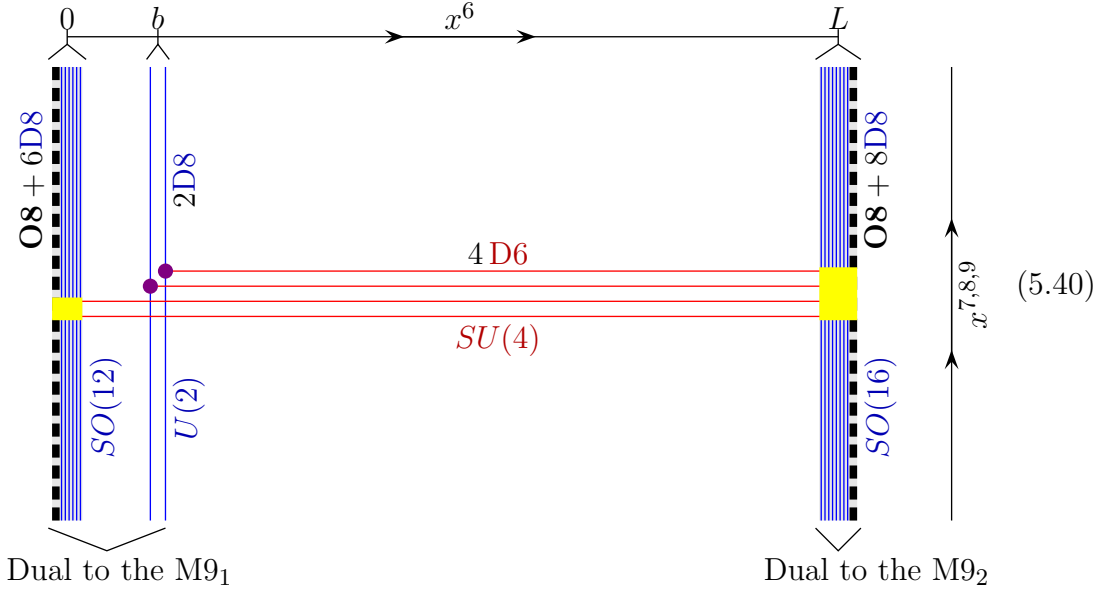

At the right terminus of the four coincident **D6** branes dual to a \mathbb{Z}_4 fixed plane, all four **D6** branes end on the **O8** orientifold at $x^6 = L$. Junctions of this type were discussed in §4.3, so let us simply quote the results for the case at hand ($N = 4$, $k = 8$):

- The $SU(4)$ gauge symmetry on the **D6** world volume is broken at $x^6 = L$ down to $Sp(2) \subset SU(4)$.
- The 7D SYM fields form the adjoint **15** representation of $SU(4)$. In terms of the $Sp(2) \subset SU(4)$, $\mathbf{15} = \mathbf{10}(\square) + \mathbf{5}(\tilde{\square})$ and the boundary conditions for the corresponding fields are as follows:

$$\begin{array}{ll}
 \mathbf{10} \text{ vector: Neumann,} & \mathbf{10} \text{ hyper: Dirichlet,} \\
 \mathbf{5} \text{ vector: Dirichlet,} & \mathbf{5} \text{ hyper: Neumann.}
 \end{array} \tag{5.41}$$

- The **68** open strings produce 6D hypermultiplets localized at the junction. Their $Sp(2) \times SO(16)$ quantum numbers are

$$6D H = \frac{1}{2}(\mathbf{4}, \mathbf{16}). \tag{5.42}$$

Almost at the other end of the world, at $x^6 = b$ we have two of the **D6** branes terminating at the two outlier **D8** branes while the other two **D6** branes continue

toward the orientifold plane at $x^6 = 0$. For the sake of $SU(2)_{9D} \times SU(2)_{7D} \rightarrow SU(2)_{\text{diag}}$ gauge symmetry mixing we let each of the first two **D6** branes terminate on a separate **D8**. Altogether, the junction at $x^6 = b$ is T-dual to

$$\begin{array}{c}
 \text{2 D7} \\
 U(2)_1 \\
 \text{2 D7'} \\
 U(2)_2
 \end{array}
 \rightarrow U(4) \quad (5.43)$$

in the same manner as a similar junction in §5.1 is T-dual to (5.8). The physical consequences are also similar: There is a $U(2)_1$ SYM living on the two curved **D7** branes, another $U(2)_2$ SYM living on the two flat **D7'** branes, plus $U(4)/[U(2)_1 \times U(2)_2]$ SYM fields which are asymptotically massless for $x^6 \gg b$ but become heavy and decouple for $x^6 \lesssim b$. In T-dual terms, we have a 7D SYM whose $U(4)$ gauge symmetry (at $x^6 \geq b$) is abruptly broken down to $U(2)_1 \times U(2)_2$ by boundary conditions at $x^6 = b$. Specifically, the coset $U(4)/[U(2)_1 \times U(2)_2]$ SYM fields satisfy Dirichlet boundary conditions for the 8-SUSY vector multiplet components and Neumann for the hypermultiplet components. Also, in spite of zero length of the **68** open strings at the junction, there are no 6D massless fields localized at $x^6 = b$. Furthermore, the $U(2)_1$ vector fields satisfy locking boundary conditions which break $U(2)_1^{7D} \times U(2)^{9D} \rightarrow U(2)^{\text{diag}}$ while the corresponding hypermultiplets satisfy Neumann boundary conditions.

On the other hand, the $U(2)_2$ SYM fields do not have any boundary conditions at $x^6 = b$ and continue unmolested toward the ultimate boundary at $x^6 = 0$. The physics at this boundary follows from two **D6** branes terminating on an **O8** orientifold plane, *cf.* §4.3: The $U(2)$ gauge symmetry is broken to $Sp(1) = SU(2)$, the **3** vector multiplets satisfy Neumann boundary conditions while the **3** hypermultiplets satisfy Dirichlet condition, and the **68** open strings give rise to a localized

6D massless half-hypermultiplet in the $(\mathbf{2}, \mathbf{12})$ representation of the locally visible $SU(2) \times SO(12)$ gauge group.

In the HW picture of the type I'/D6 model (5.40), the two separate brane junctions at $x^6 = 0$ and $x^6 = b$ collapse into a single $\mathcal{I}5_1$ intersections plane. The local physics at this plane is simply the net effect of the two junctions, modulo decoupling of the $U(1)$ center of the 7D $U(4)$ SYM related to the center-of-mass motion of the four D6 branes. Thus:

1. The 7D gauge symmetry $SU(4)$ is broken down to $SU(2)_1 \times U(1) \times SU(2)_2$ and furthermore, the $[SU(2)_1 \times U(1)] \subset SU(4)$ and the 10D $[SU(2) \times U(1)] \subset E_8^{(1)}$ are broken to the diagonal $SU(2) \times U(1)$. The net gauge symmetry at the $\mathcal{I}5_1$ is therefore

$$G_{\text{local}}^{6\text{D}} = SO(12)^{10\text{D}} \times [SU(2)_1 \times U(1)]^{\text{diag}} \times SU(2)_2^{7\text{D}}. \quad (5.44)$$

2. The boundary conditions for the 7D SYM fields depend on their $SU(2)_1 \times U(1) \times SU(2)_2$ as well as 8-SUSY quantum numbers. Decomposing the $SU(4)$ adjoint $\mathbf{15}$ as $(\mathbf{3}, \mathbf{0}, \mathbf{1}) + (\mathbf{1}, \mathbf{0}, \mathbf{3}) + (\mathbf{1}, \mathbf{0}, \mathbf{1}) + (\mathbf{2}, \pm\mathbf{1}, \mathbf{2})$, we have

$$\begin{aligned} (\mathbf{3}, \mathbf{0}, \mathbf{1}) \text{ vector: Locking b.c.}, & \quad (\mathbf{3}, \mathbf{0}, \mathbf{1}) \text{ hyper: Neumann b.c.}, \\ (\mathbf{1}, \mathbf{0}, \mathbf{1}) \text{ vector: Locking b.c.}, & \quad (\mathbf{1}, \mathbf{0}, \mathbf{1}) \text{ hyper: Neumann b.c.}, \\ (\mathbf{1}, \mathbf{0}, \mathbf{3}) \text{ vector: Neumann b.c.}, & \quad (\mathbf{1}, \mathbf{0}, \mathbf{3}) \text{ hyper: Dirichlet b.c.}, \\ (\mathbf{2}, \pm\mathbf{1}, \mathbf{2}) \text{ vector: Dirichlet b.c.}, & \quad (\mathbf{2}, \pm\mathbf{1}, \mathbf{2}) \text{ hyper: Neumann b.c.} \end{aligned} \quad (5.45)$$

3. The local 6D massless fields at the intersection comprise a half-hypermultiplet in the $(\mathbf{12}, \mathbf{1}, \mathbf{0}, \mathbf{2})$ representation of (5.44).

Note that the heterotic twisted spectrum (5.38) contains a similar $(\mathbf{12}, \mathbf{2}, \mathbf{0})$ half-hypermultiplet, but the $(\mathbf{12}, \mathbf{1}, \mathbf{0}, \mathbf{2})$ particles we see at the $\mathcal{I}5_1$ intersection are *doublets of the wrong $SU(2)$* ! Hence, for duality's sake, we must somehow mix this purely 7D $SU(2)_2$ with the already mixed $SU(2)_1 = \text{diag} (SU(2)_1^{7\text{D}} \times SU(2)^{10\text{D}})$. This second diagonalization occurs not at the $\mathcal{I}5_1$ but at the $\mathcal{I}5_2$ at the other

end of the world: the $SU(4) \rightarrow Sp(2)$ breaking locks the two 7D $SU(2)_{1,2}$ gauge symmetries together. To see how this works, consider the net result of the $SU(4)$ breaking at both ends of the $\mathcal{O}6$,

$$\begin{array}{ccc} SU(4) & \longrightarrow & SU(2)_1 \times SU(2)_2 \times U(1) \\ \downarrow & & \downarrow \\ Sp(2) & \longrightarrow & ?? \end{array} \quad (5.46)$$

To clarify this diagram, we identify

$$SU(4) = SO(6), \quad Sp(2) = SO(5), \quad SU(2) \times SU(2) \times U(1) = SO(4) \times SO(2), \quad (5.47)$$

and note two distinct options for the overlap

$$SO(5) \cap [SO(4) \times SO(2)] = \begin{cases} SO(3) \times SO(2) = SU(2) \times U(1) \\ \text{or } SO(4) = SU(2) \times SU(2). \end{cases} \quad (5.48)$$

Because the $U(1)$ is observed in the heterotic theory, we choose the first option and consequently

$$\begin{array}{ccc} SU(4) & \longrightarrow & SU(2)_1 \times SU(2)_2 \times U(1), \\ \downarrow & & \downarrow \\ Sp(2) & \longrightarrow & SU(2)_{1+2} \times U(1) \end{array} \quad (5.49)$$

where $SU(2)_{1+2} = \text{diag}(SU(2)_1 \times SU(2)_2)$ (*cf.* $SO(3) \subset SO(4)$).

Ultimately, the $SU(2)$ observed in the heterotic theory is the common diagonal of the

$$SU(2)^{10D} \times \prod_{\substack{\mathbb{Z}_4 \text{ fixed} \\ \text{planes}}} [SU(2)_1 \times SU(2)_2]^{7D}. \quad (5.50)$$

At each $\mathcal{O}6[\mathbb{Z}_4]$ fixed plane of the HW picture, the $SU(2)$ quantum numbers of the

$\frac{1}{2}(\mathbf{12}, \mathbf{2})$ twisted hypermultiplet follow a weird trajectory

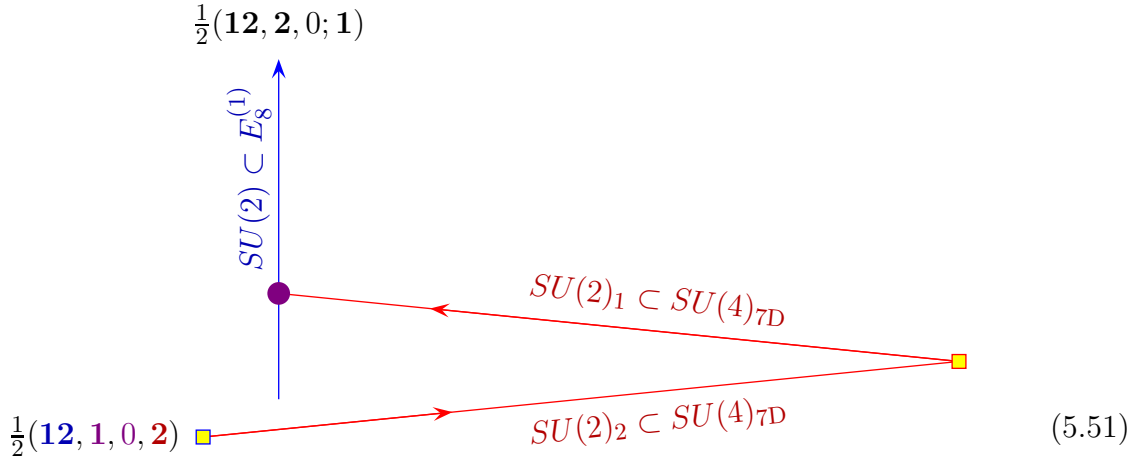

from the $x^6 = 0$ end of the fixed plane all the way to the other end $x^6 = L$ and back to $x^6 = b \approx 0$. At the end of this trajectory, the $\frac{1}{2}(\mathbf{12}, \mathbf{1}, \mathbf{0}, \mathbf{2})$ multiplet of the local gauge symmetry (5.44) indeed becomes the $\frac{1}{2}(\mathbf{12}, \mathbf{2}, \mathbf{0}, \mathbf{1})$ multiplet of the net 6D gauge symmetry (5.34). We admit however that such a HW origin of a twisted state's quantum numbers is so bizarre, we would have never found it without the dual type I'/D6 model (5.40).

The HW origins of the remaining twisted states (5.38) are less complicated. The $\frac{1}{2}(\mathbf{4}, \mathbf{16})$ multiplet of the $Sp(2) \times SO(16)$ living at $\mathcal{I}5_2$ at the right end of the fixed plane becomes $(\mathbf{1}, \mathbf{2}, +\frac{1}{2}; \mathbf{16})$ of the net 6D symmetry (5.34) after the $Sp(2)$ is broken down to $SU(2) \times U(1)$ which eventually mixes with the 10D $SU(2) \times U(1)$ at $x^6 = b \approx 0$. Indeed, in $SO(5)$ terms, the $\mathbf{4}$ representation of the $Sp(2)$ is the spinor, hence it decomposes as $\mathbf{4} = (\mathbf{2}, +\frac{1}{2}) + (\mathbf{2}, -\frac{1}{2})$ with respect to the $SO(3) \times SO(2) \subset SO(5)$; therefore, for a hypermultiplet $\frac{1}{2}(\mathbf{4}) = (\mathbf{2}, +\frac{1}{2})$.

Finally, the two charged singlets in the twisted spectrum (5.38) arise from the zero modes of the 7D fields. Indeed, let us arrange the $\mathbf{15}$ 7D SYM fields according to their $SU(2)_{1+2} \times U(1)$ quantum numbers and note their boundary conditions

at both ends of the x^6 :

Charges	Boundary Conditions	
$SU(2)_{1+2} \times U(1)$	8-SUSY vector	hyper
$(\mathbf{3}, 0)$	(locking, Neumann)	(Neumann, Dirichlet)
$(\mathbf{1}, 0)$	(locking, Neumann)	(Neumann, Dirichlet)
$(\mathbf{3}, 0)$	(Neumann, Dirichlet)	(Dirichlet, Neumann)
$(\mathbf{3}, \pm 1)$	(Dirichlet, Neumann)	(Neumann, Dirichlet)
$(\mathbf{1}, \pm 1)$	(Dirichlet, Dirichlet)	(Neumann, Neumann)

(5.52)

According to this table, two hypermultiplets on the last line have Neumann boundary conditions at both ends and hence massless (in 6D) zero modes. The $(\mathbf{1}, \pm 1)$ charges of these hypermultiplets are exactly opposite and therefore equivalent; in the (5.34) terms, we have $2(\mathbf{1}, \mathbf{1}, +1, \mathbf{1})$, *cf.* the last entry in the heterotic twisted spectrum (5.38).

To summarize the above discussion, the HW dual of the type I'/D6 brane model (5.40) correctly reproduces the twisted spectrum of the heterotic \mathbb{Z}_4 fixed plane, albeit in a rather weird manner. To justify this weirdness, we conclude this section by verifying the other kinematical requirements of the HW orbifold, namely the heterotic gauge couplings and the local anomaly cancelation at both $\mathcal{I}_{5,2}$ intersection planes.

We begin with the gauge couplings: According to eq. (5.50), the net $SU(2)$ gauge theory of the orbifold involves two copies of the $SU(2)$ embedded in the $SU(4)$ at each \mathbb{Z}_4 fixed plane. Consequently,

$$\frac{1}{g^2[SU(2)]} = \frac{1}{g^2[E_8^{(1)}]} + \frac{4 \times 2}{g^2[SU(4)]} \quad (5.53)$$

or in terms of the v, \tilde{v} coefficients,

$$v[SU(2)] = 1, \quad \tilde{v}[SU(2)] = \frac{1}{2}k_1 + 8. \quad (5.54)$$

The generator C_{7D} of the $U(1) \subset SU(4)$ has eigenvalues $(+\frac{1}{2}, +\frac{1}{2}, -\frac{1}{2}, -\frac{1}{2})$ hence the norm $\text{tr}(C_{7D}^2) = 2$ while the generator C_{10D} of the $U(1) \subset E_8^{(1)}$ is normalized

to $\text{tr}(C_{10\text{D}}^2) = 4$, thus the net $U(1)$ of the orbifold has

$$v[U(1)] = 4, \quad \tilde{v}[U(1)] = 2k_1 + 4 \times 2. \quad (5.55)$$

Finally, the remaining $SO(12)$ and $SO(16)$ gauge factors are of purely 10D origins, therefore

$$v[SO(12)] = v[SO(16)] = 1, \quad \tilde{v}[SO(12)] = \frac{1}{2}k_1, \quad \tilde{v}[SO(16)] = \frac{1}{2}k_2. \quad (5.56)$$

Formulae (5.54) through (5.56) are predictions of the HW picture of the orbifold which is itself a prediction of the type $I'/D6$ dual model (5.40). To verify these predictions, we calculated the net anomaly polynomial of the orbifold and factorized it according to eq. (2.2). After some boring arithmetic, we arrived at

$$\begin{aligned} v[SO(12)] &= 1, & \tilde{v}[SO(12)] &= +2, \\ v[SU(2)] &= 1, & \tilde{v}[SU(2)] &= +10, \\ v[U(1)] &= 4, & \tilde{v}[U(1)] &= +16, \\ v[SO(16)] &= 1, & \tilde{v}[SO(16)] &= -2, \end{aligned} \quad (5.57)$$

which indeed agrees with eqs. (5.54), (5.55) and (5.56) for $k_1 = +4$, $k_2 = -4$ (*i.e.*, 16 instantons in the $E_8^{(1)}$ and 8 in the $E_8^{(2)}$).

Next, consider the local anomalies at the $\mathcal{I}5_1$ intersection plane where the local gauge symmetry is given by eq. (5.44). The anomaly-weighted chiral spectrum at this plane comprises

$$\begin{aligned} Q_6 &= \frac{1}{2}(\mathbf{12}, \mathbf{1}, \mathbf{0}, \mathbf{2}), \\ Q_7 &= \frac{1}{2}[(\mathbf{1}, \mathbf{3}, \mathbf{0}, \mathbf{1}) + (\mathbf{1}, \mathbf{1}, \mathbf{0}, \mathbf{1}) - (\mathbf{1}, \mathbf{1}, \mathbf{0}, \mathbf{3}) + (\mathbf{1}, \mathbf{2}, \pm\mathbf{1}, \mathbf{2})], \\ Q_{10} &= \frac{1}{32}[(\mathbf{12}, \mathbf{2}, \pm\mathbf{1}, \mathbf{1}) + (\mathbf{32}, \mathbf{1}, \pm\mathbf{1}, \mathbf{1})] + \frac{3}{32}[(\mathbf{32}', \mathbf{2}, \mathbf{0}, \mathbf{1}) + (\mathbf{1}, \mathbf{1}, \pm\mathbf{2}, \mathbf{1})] \\ &\quad - \frac{5}{32}[(\mathbf{66}, \mathbf{1}, \mathbf{0}, \mathbf{1}) + (\mathbf{1}, \mathbf{3}, \mathbf{0}, \mathbf{1}) + (\mathbf{1}, \mathbf{1}, \mathbf{0}, \mathbf{1})], \end{aligned} \quad (5.58)$$

while the plane's magnetic charge is

$$g_1[\mathbb{Z}_4] = \frac{1}{4} \left(k_1 - 6g_1[\mathbb{Z}_2] \right) = \frac{1}{4} \left(4 - 6 \times \frac{3}{4} \right) = -\frac{1}{8}, \quad (5.59)$$

thus we can easily verify that

$$\dim(Q = Q_6 + Q_7 + Q_{10}) = \frac{61}{4} = 19 + 30 \times \frac{-1}{8} \quad (5.60)$$

and hence the $\text{tr}(R^4)$ anomaly cancels out, *cf.* eq. (2.11). The rest of the anomaly follows via straightforward if tedious evaluation of

$$\begin{aligned} \mathcal{A}' &\equiv \frac{2}{3} \text{Tr}_Q(\mathcal{F}^4) - \frac{1}{6} \text{tr}(R^2) \times \text{Tr}_Q(\mathcal{F}^2) + \left(\frac{1}{8}g + \frac{1}{2}T(1) = \frac{1}{16} \right) (\text{tr}(R^2))^2 \\ &= \frac{-1}{16} \left(\text{tr}(F_{SO(12)}^2) + \text{tr}(F_{SU(2)}^2) + 4F_{U(1)}^2 - \frac{1}{2} \text{tr}(R^2) \right)^2 \\ &\quad + \left(\text{tr}(F_{SO(12)}^2) + \text{tr}(F_{SU(2)_1}^2) + 4F_{U(1)}^2 - \frac{1}{2} \text{tr}(R^2) \right) \\ &\quad \times \left(\text{tr}(F_{SU(2)_1}^2) + 2F_{U(1)}^2 + \text{tr}(F_{SU(2)_2}^2) - \frac{5}{32} \text{tr}(R^2) \right), \end{aligned} \quad (5.61)$$

which indeed shows cancellation of the one-loop anomaly against the inflow and intersection anomalies, *cf.* eq. (2.12).

The $SU(2)$ trajectory (5.51) goes through the $\mathcal{I}5_1$ intersection twice, hence two separate $SU(2)$ gauge factors in the local symmetry (5.44). To see the importance of this setup anomaly-wise, suppose we had only one $SU(2)_{1+2}$ factor instead and focus on the $(\text{tr}(F_{SU(2)}^2))^2$ anomaly term. In the $SU(2)_{1+2}$ terms, the **15** 7D SYM fields comprise four triplets and three singlets, and in our hypothetical model all the triplets would have to have Dirichlet or locking boundary conditions for the vector fields in order to prevent the appearance of a second $SU(2)$ factor. Anomaly-wise, the effect of this change is to change the sign of the third term in eq. (5.58) for the Q_7 from negative to positive — and therefore to increase the one-loop $\text{Tr}_Q(F_{SU(2)}^4)$ by $+2(\text{tr}(F_{SU(2)}^2))^2$. At the same time, the Q_6 , the Q_{10} and all the terms in the inflow and intersection anomalies are completely fixed by the heterotic data, so

they must remain unchanged. Altogether, we would have $+2(\text{tr}(F_{SU(2)}^2))^2$ worth of un-canceled local anomaly — which rules out the single $SU(2)$ hypothesis. On the other hand, the setup with two local $SU(2)$ gauge symmetries leads to complete anomaly cancellation. Thus, the trajectory (5.51) may look weird, but it works and nothing else seem to do the job, so it must be right!

Finally, at the $\mathcal{I}5_2$ intersection plane, the local gauge symmetry is $SO(16) \times Sp(2)$, the anomaly-weighted chiral spectrum comprises

$$\begin{aligned} Q_6 &= \frac{1}{2}(\mathbf{16}, \mathbf{4}), \\ Q_7 &= \frac{1}{2}[(\mathbf{1}, \mathbf{5}) - (\mathbf{1}, \mathbf{10})], \\ Q_{10} &= \frac{3}{32}(\mathbf{128}, \mathbf{1}) - \frac{5}{32}(\mathbf{120}, \mathbf{1}), \end{aligned} \tag{5.62}$$

and the magnetic charge is $g_2 = -g_1 = +\frac{1}{8}$. We immediately see that eq. (2.11) is satisfied,

$$\dim(Q = Q_6 + Q_7 + Q_{10}) = \frac{91}{4} = 19 + 30 \times \frac{+1}{8}, \tag{5.63}$$

and after a bit of arithmetic we can see that eq. (2.12) is satisfied as well,

$$\begin{aligned} \mathcal{A}' &\equiv \frac{2}{3} \text{Tr}_Q(\mathcal{F}^4) - \frac{1}{6} \text{tr}(R^2) \times \text{Tr}_Q(\mathcal{F}^2) + \left(\frac{1}{8}g + \frac{1}{2}T(1) = \frac{3}{32}\right)(\text{tr}(R^2))^2 \\ &= \frac{+1}{16} \left(\text{tr}(F_{SO(16)}^2) - \frac{1}{2} \text{tr}(R^2)\right)^2 \\ &\quad + \left(\text{tr}(F_{SO(12)}^2) - \frac{1}{2} \text{tr}(R^2)\right) \times \left(\text{tr}(F_{Sp(4)}^2) - \frac{5}{32} \text{tr}(R^2)\right). \end{aligned} \tag{5.64}$$

Again, cancelation of the net $\text{tr}(\mathcal{F}_{7D}^4)$ anomaly does not allow any changes in Q_7 (since all the other contributions to this anomaly are fixed by the heterotic data), which confirms that the 7D vector fields with Neumann boundary conditions should indeed comprise the adjoint $\mathbf{10}$ multiplet of the $Sp(2) \supset SU(2) \times U(1)$, exactly as in the dual type I'/D6 brane model.

6. NS5 Half–Branes at the End of the World

In this section, we add another tool to our brane engineering toolkit, namely NS5 branes serving as terminals of several coincident D6 branes. Or rather NS5 *half-branes*, stuck on the **O8** orientifold planes and unable to move in the x^6 direction. Such half-branes are explained in some detail in refs. [11,30]; the following couple of pages give a brief summary of relevant phenomena.

An NS5 half-brane terminus of N D6 branes results from **O8** orientifold projection of the following picture:

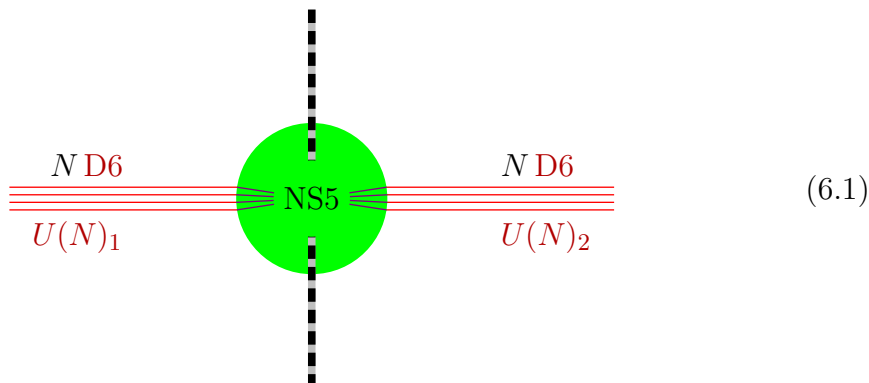

In the middle of this picture we have an NS5 brane — a supersymmetric co-dimension 4 soliton of the metric, dilaton and $B_{\mu\nu}$ fields of the type IIA superstring. The metric is asymptotically flat for $r \rightarrow \infty$ but develops an infinite $S^3 \times R_+$ throat at $r \rightarrow 0$; deep down the throat, the string coupling $\lambda = e^\varphi$ increases and eventually becomes strong. The D6 branes approaching the NS5 brane from the right (*i.e.*, $\mathbf{x} = \mathbf{0}$, $x^6 \rightarrow +0$) plunge down the throat and eventually suffer some kind of a ‘meltdown’ in the strong coupling region. In the local metric (string frame), the $x^6 \rightarrow +0$ dimension of these D6 branes is infinite and there is no terminus, but the continuously rising string coupling causes reflection of the 7D particles living on the D6 world-volume back to $x^6 \rightarrow +\infty$. Hence, from the low-energy / long-distance point of view, the 6D branes *appear to terminate* on the NS5 brane where the 7D $U(N)$ SYM fields have reflecting boundary conditions: Neumann for the 8–SUSY vector multiplet components and Dirichlet for the hypermultiplet components.

On the left side of the picture (6.1) we have N more D6 branes at $x^6 < 0$; they also plunge down the NS5 throat for $x^6 \rightarrow -0$, but the two sets of D6 branes remain at finite distance from each other all the way down. Therefore, the $U(N)$ SYM fields at $x^6 < 0$ suffer reflecting boundary conditions at $x^6 = -0$ without any locking onto the similar SYM fields at $x^6 = +0$, hence *locally at $x^6 = 0$* we have a double gauge symmetry $U(N)_L \times U(N)_R$. Or rather $SU(N)_L \times SU(N)_R \times U(1)_{L-R}$ whereas the other $U(1)_{L+R}$ is Higgsed out by quantum corrections (the Fayet–Iliopoulos term and its superpartners); the hypermultiplet ‘eaten up’ by this Higgs effect corresponds to moving the NS5 brane in the $x^{7,8,9,10}$ directions separately from the D6 branes. On the other hand, moving the NS5 brane in the x^6 direction corresponds to the scalar in the 8–SUSY tensor multiplet, which remains in the massless spectrum of the configuration.

Finally, we have open strings connecting the two sets of the D6 branes in the throat region. Such strings have short $O(\sqrt{\alpha'})$ but non-zero length; nevertheless they have zero modes giving rise to 6D massless hypermultiplets localized at $x^6 = 0$. Naturally, the gauge quantum numbers of these particles are (\mathbf{N}, \mathbf{N}) .

The **O8** orientifold projection identifies the two halves of the picture (6.1) as mirror images of each other: The physical part of the NS5 brane is only a half-brane and there is only one independent set of N D6 branes. The 7D SYM fields surviving the projection comprise the diagonal $SU(N)_{L+R}$ while the $U(1)$ fields are projected out altogether. The tensor multiplet is also projected out; consequently, the NS5 half-brane cannot move in the x^6 direction any longer and remains forever stuck at the orientifold plane. Finally, the (\mathbf{N}, \mathbf{N}) multiplet of localized 6D fields splits into a symmetric \square and an antisymmetric \boxminus multiplets of the diagonal $SU(N)$ gauge symmetry. The two multiplets have opposite signs with respect to the orientifold projection Ω : The \square is Ω –negative while the \boxminus is Ω –positive, thus only the antisymmetric \boxminus multiplet survives the projection.

Ultimately, from the low-energy, $x^6 > 0$ point of view, the NS5 half-brane serves as a new kind of a terminal junction between the **D6** branes and the **O8**

orientifold plane,

$$\left\{ \begin{array}{l} G^{\text{local}} = SU(N), \\ 7\text{D } V = \text{Adj.}, \\ 7\text{D } H = 0, \\ 7\text{D } H = \mathbf{\bar{5}}, \end{array} \right\} \frac{1}{2} \text{NS5} \text{ --- } \begin{array}{c} N \text{ D6} \\ \text{---} \\ \text{---} \\ \text{---} \\ \text{---} \\ SU(N) \end{array} \quad (6.2)$$

Unlike the junctions discussed in §4.3 (*cf.* fig. (4.6)), the $\frac{1}{2}\text{NS5}$ junction (6.2) provides Neumann boundary conditions at $x^6 = 0$ for all the 7D $SU(N)$ 8-SUSY vector multiplets while all the 7D hypermultiplets satisfy Dirichlet conditions.[★] Consequently, the entire $SU(N)$ symmetry is visible at the junction and it is no longer necessary for the number N of the D6 branes to be even. Finally, the $\frac{1}{2}\text{NS5}$ junction supports localized 6D massless hypermultiplets which form an antisymmetric tensor representation $\mathbf{\bar{5}}$ of the $SU(N)$. From the brane engineering point of view, such $\mathbf{\bar{5}}$ hypermultiplets are characteristic of NS5 half-branes and do not occur at other types of brane junctions.

As an example of a $\frac{1}{2}\text{NS5}$ junction in a type I'/D6 brane dual of a perturbative heterotic orbifold, consider a T^4/\mathbb{Z}_6 model in which $E_8^{(1)}$ is broken down to $SU(6) \times E_3 \equiv SU(6) \times SU(3) \times SU(2)$ and $E_8^{(2)}$ down to $SU(8) \times U(1)$. In terms of the lattice shift vectors, $\delta_1 = (-\frac{5}{6}, \frac{1}{6}, \dots, \frac{1}{6}, 0, 0)$ and $\delta_2 = (-\frac{11}{12}, \frac{+1}{12}, \dots, \frac{+1}{12})$; in terms of the unbroken subgroups, the $\alpha_1 : \mathbb{Z}_6 \mapsto E_8^{(1)}$ twist acts as

$$\begin{aligned} \alpha_1(\mathbf{248}) = & + [(\mathbf{35}, \mathbf{1}, \mathbf{1}) + (\mathbf{1}, \mathbf{8}, \mathbf{1}) + (\mathbf{1}, \mathbf{1}, \mathbf{3})] - (\mathbf{20}, \mathbf{1}, \mathbf{2}) \\ & + e^{2\pi i/6}(\overline{\mathbf{6}}, \overline{\mathbf{3}}, \mathbf{2}) + e^{-2\pi i/6}(\mathbf{6}, \mathbf{3}, \mathbf{2}) \\ & + e^{4\pi i/6}(\overline{\mathbf{15}}, \mathbf{3}, \mathbf{1}) + e^{-4\pi i/6}(\mathbf{15}, \overline{\mathbf{3}}, \mathbf{1}) \end{aligned} \quad (6.3)$$

[★] As usual, we disregard the $U(1)$ factor of the 7D $U(N)$ as irrelevant to the orbifold problem.

while the $\alpha_2 : \mathbb{Z}_6 \mapsto E_8^{(2)}$ twist acts according to

$$\begin{aligned} \alpha_2(\mathbf{248}) = & + [(\mathbf{63}, 0) + (\mathbf{1}, 0)] - (\mathbf{70}, 0) \\ & + e^{2\pi i/6}[(\overline{\mathbf{28}}, -1) + (\mathbf{1}, +2)] + e^{-2\pi i/6}[(\mathbf{28}, +1) + (\mathbf{1}, -2)] \quad (6.4) \\ & + e^{4\pi i/6}(\overline{\mathbf{28}}, +1) + e^{-4\pi i/6}(\mathbf{28}, -1). \end{aligned}$$

In the untwisted sector of the orbifold, massless particles comprise the usual SUGRA and dilaton multiplets, 110 vector multiplets in the adjoint of

$$G = [SU(6) \times SU(3) \times SU(2)] \times [SU(8) \times U(1)], \quad (6.5)$$

two moduli and 65 charged hypermultiplets,

$$H_{\text{untw}} = (\overline{\mathbf{6}}, \overline{\mathbf{3}}, \mathbf{2}; \mathbf{1}, 0) + (\mathbf{1}, \mathbf{1}, \mathbf{1}; \mathbf{1}, +2) + (\mathbf{1}, \mathbf{1}, \mathbf{1}; \overline{\mathbf{28}}, -1) + 2M. \quad (6.6)$$

The twisted sectors contain further 287 charged massless hypermultiplets; arranging them according to specific fixed $\mathcal{O}5$ planes of the model (*i.e.*, fixed points of the T^4/\mathbb{Z}_6), we have:

- One \mathbb{Z}_6 fixed plane carries 63 hypermultiplets,

$$H_{\text{tw}}[\mathbb{Z}_6] = (\mathbf{6}, \mathbf{1}, \mathbf{1}; \mathbf{8}, +\frac{1}{6}) + (\mathbf{15}, \mathbf{1}, \mathbf{1}; \mathbf{1}, -\frac{2}{3}). \quad (6.7)$$

- Five \mathbb{Z}_2 fixed planes, each carrying 16 hypermultiplets,

$$H_{\text{tw}}[\mathbb{Z}_2] = (\mathbf{1}, \mathbf{1}, \mathbf{2}; \mathbf{8}, -\frac{1}{2}) \equiv \frac{1}{2}(\mathbf{1}, \mathbf{2}; \mathbf{16}). \quad (6.8)$$

The second expression on the right hand side shows the quantum numbers of these hypermultiplets with respect to the locally surviving gauge symmetry $G_{\mathbb{Z}_2} = [E_7 \times SU(2)] \times SO(16)$. Note that each of these \mathbb{Z}_2 fixed planes works exactly like the fixed planes of the T^2/\mathbb{Z}_2 orbifold of section 4.

- Four \mathbb{Z}_3 fixed planes, each carrying 36 hypermultiplets,

$$\begin{aligned}
H_{\text{tw}}[\mathbb{Z}_3] &= (\mathbf{15}, \mathbf{1}, \mathbf{1}; \mathbf{1}, -\frac{2}{3}) + (\bar{\mathbf{6}}, \mathbf{1}, \mathbf{2}; \mathbf{1}, -\frac{2}{3}) \\
&\quad + 2(\mathbf{1}, \mathbf{3}, \mathbf{1}; \mathbf{1}, -\frac{2}{3}) + (\mathbf{1}, \mathbf{3}, \mathbf{1}; \mathbf{1}, +\frac{4}{3}) \\
&\equiv (\mathbf{27}, \mathbf{1}; \mathbf{1}, -\frac{2}{3}) + 2(\mathbf{1}, \mathbf{3}; \mathbf{1}, -\frac{2}{3}) + (\mathbf{1}, \mathbf{3}; \mathbf{1}, +\frac{4}{3}).
\end{aligned} \tag{6.9}$$

Again, the second expression on the RHS indicates the representation of the locally surviving symmetry $G_{\mathbb{Z}_3} = [E_6 \times SU(3)] \times [E_7 \times U(1)]$. Naturally, there is a T^4/\mathbb{Z}_3 model with similar fixed planes, but for technical reasons we do not discuss this model in the present article; hopefully, we shall return to it in a future publication.

For our present purposes, we are interested in the HW point of view of the \mathbb{Z}_6 fixed plane. In 7D, this $\mathcal{O}6$ plane carries an $SU(6)$ SYM, and it is clear from the twisted spectrum (6.7) that the entire $SU(6)$ gauge group is involved in communicating quantum numbers between the two M9 branes. That is, at the $\mathcal{I}5_1$ intersection at $x^6 = 0$, all the 7D $SU(6)$ vector fields lock onto the 10D $SU(6)$ vector fields according to eq. (1.2) and all **35** hypermultiplet components have Neumann boundary conditions. All the massless twisted states (6.7) are localized at the other intersection $\mathcal{I}5_2$ at $x^6 = L$ where the 7D vector multiplets have Neumann BC and hypermultiplets Dirichlet BC. Thus,

$$\mathcal{I}5_1 \left\{ \begin{array}{l} G^{\text{local}} = SU(6)^{\text{diag}} \times [SU(3) \times SU(2)]^{10\text{D}}, \\ 7\text{D } H = \mathbf{35}, \\ 7\text{D } V = 0, \\ 6\text{D } H = 0; \end{array} \right. \tag{6.10}$$

$$\mathcal{I}5_2 \left\{ \begin{array}{l} G^{\text{local}} = SU(6)^{7\text{D}} \times [SU(8) \times U(1)]^{10\text{D}}, \\ 7\text{D } H = 0, \\ 7\text{D } V = \mathbf{35}, \\ 6\text{D } H = (\mathbf{6}; \mathbf{8}, +\frac{1}{6}) + (\mathbf{15}; \mathbf{1}, -\frac{2}{3}). \end{array} \right. \tag{6.11}$$

Clearly, this HW picture does lead to the correct twisted spectrum, and in the Appendix we shall verify the rest of the kinematical constraints (the 6D gauge couplings and the local anomaly cancelation at both $\mathcal{I}5_1$ and $\mathcal{I}5_2$ intersections), but for now let us focus on brane engineering a dual model.

Brane-wise, two features of the $\mathcal{I}5_2$ intersection are particularly noteworthy: First, *all* of the **35** 7D vector fields have Neumann boundary conditions at the $\mathcal{I}5_2$ which preserves the entire $SU(6)$ gauge symmetry. Second, the massless hypermultiplets localized at the $\mathcal{I}5_2$ include an antisymmetric tensor representation $\mathbf{\bar{15}}$ of this 7D symmetry. Both features cry out for an **NS5** half-brane being present at the junction dual to the $\mathcal{I}5_2$, so let us engineer the following model:

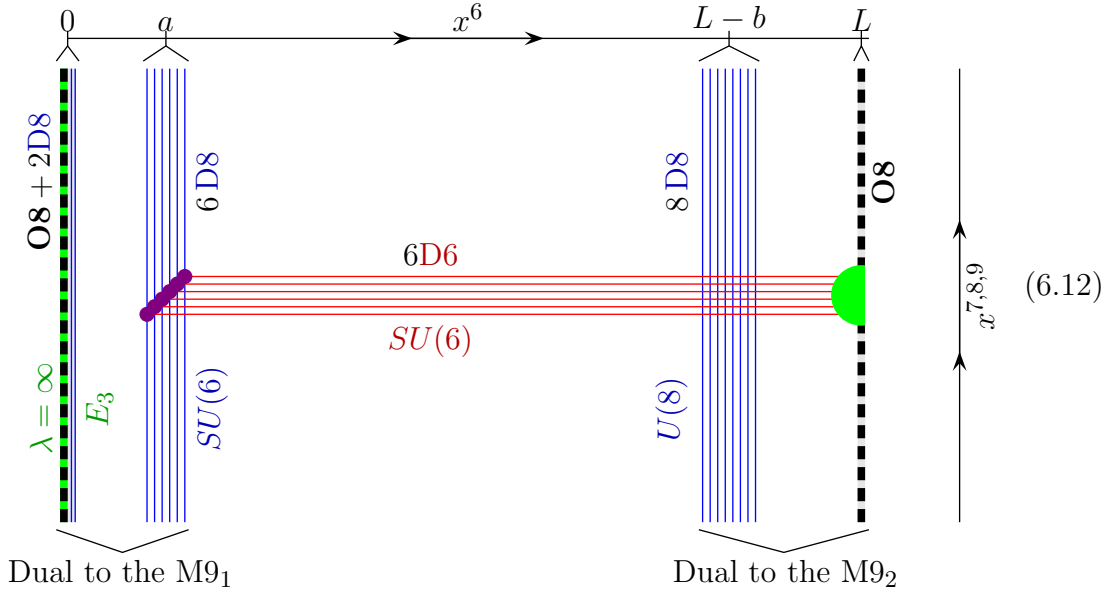

On the left side of this diagram, the distance a between the orientifold and the outlier **D8** branes is critical, hence $\lambda = \infty$ at $x^6 = 0$ and the enhancement of the perturbative 9D gauge symmetry from $SO(4) \times U(6)$ to $E_3 \times SU(6)$. On the right side, the distance b is less than critical, hence finite $\lambda(x^6 = L)$ and the 9D gauge symmetry remains $U(8) = SU(8) \times U(1)$. The $\mathcal{O}6$ fixed plane is dual to six coincident **D6** branes and the $\mathcal{I}5_1$ intersection is dual to the **D6** branes terminating on the six outlier **D8** branes at $x^6 = a$ without reaching the

strongly coupled orientifold plane. As explained in §4.4, junctions of this type impose locking boundary conditions (4.9) upon the appropriate gauge fields — in the present case $SU(6)^{7D} \times SU(6)^{10D} \rightarrow SU(6)^{\text{diag}}$ — without giving rise to any localized massless 6D particles. Also, the $E_3 = SU(2) \times SU(3)$ gauge fields living at $x^6 = 0 \neq a$ remain mere spectators at the intersection. In other words, our brane model (6.12) correctly explains all the *Mysteries* of the $\mathcal{I}5_1$ intersection, *cf.* eqs. (6.10).

The $\mathcal{I}5_2$ intersection plane is dual to a combination of two distinct brane junctions on the right side of the diagram (6.12). First, at $x^6 = L - b$ all six **D6** branes cross eight **D8** branes without terminating. At this ‘junction’ we have zero length **68** open strings which give rise to localized massless 6D hypermultiplets in the $(\mathbf{6}, \mathbf{8})$ representation of the $SU(6)^{7D} \times SU(8)^{9D}$ gauge symmetry. Naturally, the 7D SYM fields suffer no boundary conditions at $x^6 = L - b$ and continue unmolested towards the second junction at $x^6 = L$ where the **D6** branes meet the **NS5** half-brane. As we saw earlier in this section, the **NS5** half-brane preserves the entire $SU(6)^{7D}$ gauge symmetry by effectively imposing Neumann boundary condition for all 7D vector fields and their 8-SUSY fermionic partners. At the same time, all 7D hypermultiplets suffer Dirichlet boundary conditions while the open strings deep in the **NS5** half-brane’s throat give rise to localized hypermultiplets in the $\mathbf{\bar{15}} = \mathbf{15}$ of the $SU(6)$.

Together, the two junctions at $x^6 = L$ and at $x^6 = L - b$ correctly reproduce all the localized twisted states and the boundary conditions of the $\mathcal{I}5_2$ intersection plane of the HW picture, *cf.* eqs. (6.11). One *Mystery* however remains unexplained, namely the $U(1)$ charge of the $(\mathbf{15}, \mathbf{1}, -\frac{2}{3})$ twisted states. Naively, the 9D $U(1)$ charge is a part of the $U(8)$ symmetry living on the **D8** world-volume at $x^6 = L - b$ and hence should not attach to particles originating elsewhere in x^6 . Since the **15** twisted states live on the **NS5** half-brane at $x^6 = L \neq (L - b)$, they should therefore remain $U(1)$ -neutral.

Clearly, this reasoning is too naive to be true, and indeed the abelian charges

in the type I' superstring theory are known to mix with each other thanks to the x^6 -dependent ‘cosmological constant’[31,19] and its superpartners. Besides the $U(1)$ center of the $U(8)$ on the **D8** world-volume, we also have the RR one-form of the type I' theory and the $B_{6,\mu}^{\text{NS}}$ field (which is a one-form from the 9D point of view). Both of these vector fields live in the ‘bulk’ of the type I' theory, which puts them in touch with the **NS5** half-brane. Although we do not quite understand the behavior of these fields in the throat region of the half-brane, it stands to reason they might do something interesting enough to couple to the **15** twisted states living there. Consequently, the **15** twisted states acquire *an* abelian charge which we then need to identify as belonging to the $U(1) \subset E_8^{(2)}$.

To back up this bit of wishful thinking with a mathematical argument, let us consider the brane model (6.12) from a six-dimensional point of view. Taking the $x^{7,8,9}$ coordinates to be genuinely non-compact, we turn off the 9D gauge couplings — which makes the corresponding symmetries global rather than local. The symmetries originating from *finite* stretches of **D6** branes keep finite 6D gauge couplings and hence remain local — provided of course that they do not lock onto global symmetries of 9D origins. Since we are now interested in the *M*ysteries at the right side of the diagram (6.12) rather than the locking happening at the left side, let us replace the whole left side with some kind of a **D6** terminal which does not break or lock the $SU(6)$ symmetry, *e.g.*, a free-floating **NS5** brane. In other words, consider the following model:

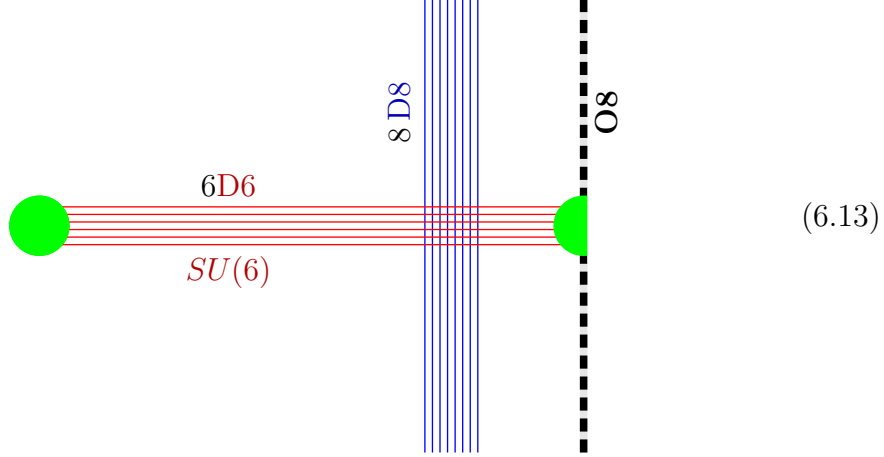

From the 6D point of view, this new model describes an $SU(6)$ gauge theory coupled to hypermultiplets in the $(\mathbf{15}) + 8(\mathbf{6})$ representation of the gauge group.[★] Classically, the *flavor* symmetry of this model is $U(1)_{15} \times U(8)_6 = U(1) \times U(1) \times SU(8)$, but in the quantum theory one combination of the abelian flavor symmetries is destroyed by the color anomaly. The surviving anomaly-free combination is determined by the cubic index of the color group,

$$\mathrm{Tr}_{8(\mathbf{6})}(F^3) = 8 \mathrm{Tr}_{(\mathbf{6})}(F^3) = 4 \mathrm{Tr}_{(\mathbf{15})}(F^3), \quad (6.14)$$

hence the charge of the $\mathbf{15}$ hypermultiplet should be exactly -4 times the charge of the $\mathbf{6}$. In other words, we have

$$\begin{aligned} G &= SU(6)^{\mathrm{color}} \times [SU(8) \times U(1)]^{\mathrm{flavor}}, \\ H &= (\mathbf{6}; \mathbf{8}, +1) + (\mathbf{15}; \mathbf{1}, -4), \end{aligned} \quad (6.15)$$

modulo an overall rescaling of the abelian charge.

[★] There is also a tensor multiplet arising from the freely floating NS5 brane, but its existence does not affect the following argument.

When this picture is translated back into the type I' language, the flavor symmetry $SU(8) \times U(1)$ becomes a 9D gauge symmetry which we would like to identify as *the* $SU(8) \times U(1) \subset E_8^{(1)}$. Consequently, the quantum numbers of the twisted states localized at the junctions dual to the HW $\mathcal{I}5_2$ should be exactly as in eq. (6.15) — and indeed these are precisely the quantum numbers of the twisted states in eq. (6.11) (modulo rescaling of the abelian charge by a factor $\frac{1}{6}$).

The bottom line of this exercise is to show that the brane model does somehow provide the **15** twisted states with a correct $U(1)$ charge. Unfortunately, the provenance of this charge from the type I' point of view remains an unsolved *Mystery*.

7. Junctions at Infinite String Coupling

The **NS5** half-branes have strong string coupling regions hiding deep in their throats. Other brane models have $\lambda \rightarrow \infty$ divergence at the **O8** orientifold planes, in full view of the 9D gauge symmetry — and in fact instrumental for brane engineering this symmetry in the first place. In this section, we consider brane models where such $\lambda = \infty$ orientifold planes are in direct contact with the **D6** branes dual to fixed planes of the HW orbifolds.

Unfortunately, our knowledge of string theory is insufficient to directly describe the physics of such strong-coupling brane junctions. Instead, we put the HW $\leftrightarrow I'$ duality machinery in reverse gear and use the HW data to predict what *should* happen at the $\lambda = \infty$ junctions and leave the question of *how* it actually happens for future research. Specifically, we consider two junction types, one involving a $\lambda = \infty$ **O8⁻** plane of D-brane charge -8 and the other an **O8^{*}** plane [13] of charge -9 . To keep our predictions reliable, we develop each junction using a simple orbifold model with a clear HW picture described in our previous paper [3], then confirm the results using a much more complicated model with the same junction.

7.1 A \mathbb{Z}_4 MODEL WITH E_1 EXTENDED SYMMETRY.

We begin with the \mathbb{Z}_4 orbifold model of ref. [3] where the $E_8^{(1)}$ is broken to $E_5 \times SU(4)$ and the $E_8^{(2)}$ to $E_1 \times SU(8)$. Conventionally, the E_5 symmetry is better known as the $SO(10)$ and the E_1 as the $SU(2)$, but here we use the E_n notation to highlight the origin of these two gauge groups in the type I' picture of the model:

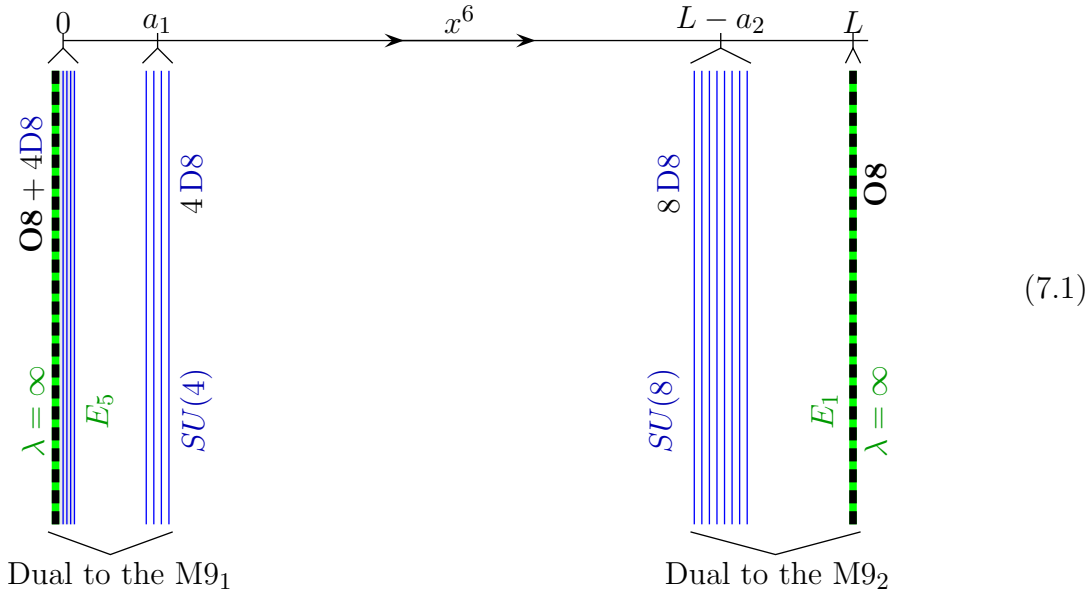

On both sides of this diagram, the outlier **D8** branes are at critical distances from the **O8** planes, hence divergent $\lambda \rightarrow \infty$ both at $x^6 = 0$ and at $x^6 = L$ and therefore enhancement of the 9D gauge symmetry $SO(8) \times U(4) \rightarrow E_5 \times SU(4)$ on the left side and $SO(0) \times U(8) \rightarrow E_1 \times SU(8)$ on the right side.

In the HW picture of this model (*cf.* section 2), each \mathbb{Z}_4 fixed plane of the orbifold carries an $SU(4)$ which locks upon the 10D $SU(4)$ at the left intersection $\mathcal{I}5_1$. At the right intersection $\mathcal{I}5_2$, the $SU(4)^{7D}$ gauge fields have free (Neumann) boundary conditions, and that's where the twisted states live. Altogether,

we have

$$\mathcal{I}5_1 \begin{cases} G^{\text{local}} = SU(4)^{\text{diag}} \times [SO(10)]^{10\text{D}}, \\ 7\text{D } H = 15, \\ 7\text{D } V = 0, \\ 6\text{D } H = 0; \end{cases} \quad (7.2)$$

$$\mathcal{I}5_2 \begin{cases} G^{\text{local}} = SU(4)^{7\text{D}} \times [SU(8) \times SU(2)]^{10\text{D}}, \\ 7\text{D } H = 0, \\ 7\text{D } V = 15, \\ 6\text{D } H = (\mathbf{4}; \mathbf{8}, \mathbf{1}) + \frac{1}{2}(\mathbf{6}; \mathbf{1}, \mathbf{2}). \end{cases} \quad (7.3)$$

In brane engineering, the $\mathcal{I}5_1$ intersection is obviously dual to a junction where the four **D6** branes (dual to the $\mathcal{O}6$) terminate on the four outlier **D8** branes at $x^6 = a_1$, cf. §4.4. Engineering the $\mathcal{I}5_2$ intersection is less obvious, but the fact that both the $(\mathbf{4}; \mathbf{8}, \mathbf{1})$ and the $\frac{1}{2}(\mathbf{6}; \mathbf{1}, \mathbf{2})$ twisted states live there evidently requires the **D6** branes to cross the eight outlier **D8** branes at $x^6 = L - a_2$, reach all the way to the $\lambda = \infty$ orientifold plane at $x^6 = L$ and terminate there somehow. Thus,

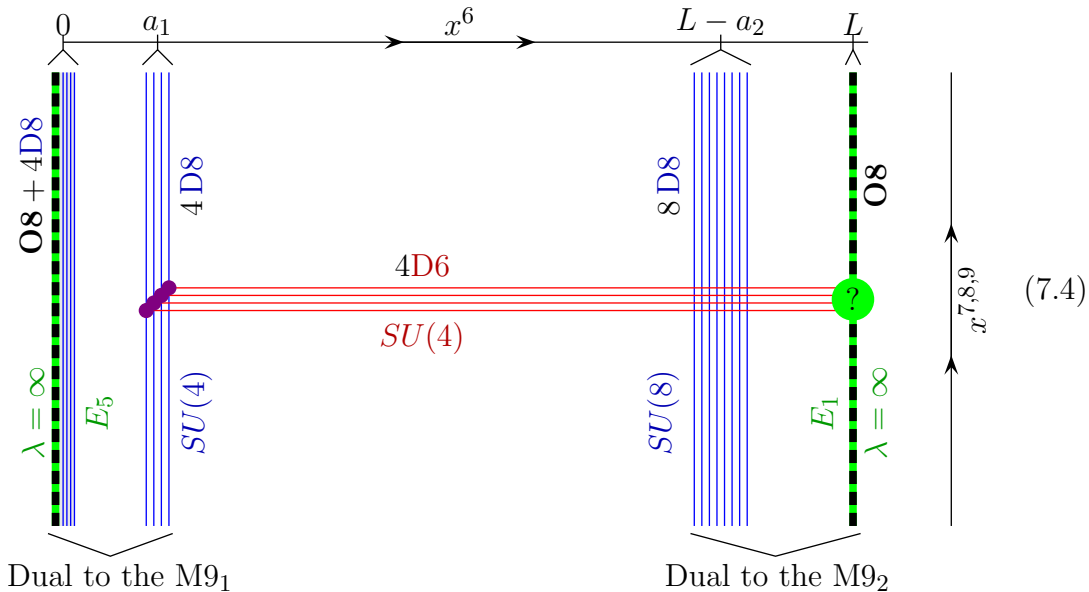

the $\mathcal{I}5_2$ splits into a simple D6–D8 brane crossing at $x^6 = L - a_2$ — which clearly gives rise to the $(4; 8, 1)$ twisted hypermultiplets but does nothing to the 7D SYM fields themselves — plus a mysterious $\lambda = \infty$ terminus which is supposed to fulfill the rest of eqs. (7.3). In other words, for the sake of the HW \leftrightarrow I' duality, we need this terminus to produce: (1) Neumann boundary conditions for all **15** 7D vector fields, (2) Dirichlet boundary conditions for all 7D hypermultiplets, and (3) localized 6D massless half-hypermultiplets in the $(\mathbf{6}, \mathbf{2})$ representations of the $SU(4) \times SU(2)$,

$$\begin{array}{c}
 \text{4D6} \\
 \text{SU(4)} \\
 \text{O8 @ } \lambda = \infty \\
 \text{E}_1 = \text{SU(2)}
 \end{array}
 \left\{ \begin{array}{l}
 G^{\text{local}} = \text{SU(4)} \times \text{SU(2)}, \\
 7\text{D } V = 15, \\
 7\text{D } H = 0, \\
 6\text{D } H = \frac{1}{2}(\mathbf{6}, \mathbf{2}).
 \end{array} \right. \quad (7.5)$$

Although we do not have a complete theory of this junction, we do have a conjecture based on a ‘detuned’ version of the model. That is, in the multi–Taub–NUT picture of the HW $\mathcal{O}6$ fixed plane, let us detune the Wilson line from a \mathbb{Z}_4 twist breaking $E_8^{(2)} \rightarrow SU(8) \times SU(2)$ to a more generic $U(1)$ twist which commutes with the $SU(8)$ subgroup but not with the $SU(2)$. Please note that while such a detuning breaks the duality with the T^4/\mathbb{Z}_4 heterotic orbifold model, it is a perfectly legitimate deformation of the multi–Taub–NUT configuration of the HW theory in its own right. In the type I' language, this detuning corresponds to bringing the D8 branes closer to the orientifold, $a_2 \rightarrow b < a_2$ and consequently avoiding the string coupling divergence at $x^6 = L$ and the gauge symmetry enhancement from $U(1)$ to $E_1 = SU(2)$.

For the detuned model, we want a terminal junction which works as similarly to the $\lambda = \infty$ junction (7.5) as mathematically possible. That is, we want the same boundary conditions for the 7D SYM fields as well as localized 6D hypermultiplets in a $\mathbf{6} = \mathbf{\bar{6}}$ representation of the $SU(4)$; in lieu of the half-doublet of the $SU(2)$ we broke down to the $U(1)$, the local states should simply have a non-zero $U(1)$ charge. Luckily, we already know how to engineer such a junction — we need to put an NS5 half-brane at O8 plane and let the four D6 branes terminate on the $\frac{1}{2}$ NS5, *cf.* §6. Indeed, according to eqs. (6.2) this type of a terminus leads to precisely the boundary conditions and the local 6D states we need at $x^6 = L$, *cf.* eqs. (7.5).

Similarly to the \mathbb{Z}_6 model of section 6, we do not understand the string theoretical origin of the $U(1)$ charge of the $\mathbf{6} = \mathbf{\bar{6}}$ twisted states, but we can work it out in terms of the anomaly-free flavor symmetry of the appropriate 6D theory. Specifically, we build a brane model along the lines of fig. (6.13) but use four D6 branes instead of six, which gives us a 6D $SU(4)$ gauge theory with $8(\mathbf{4}) + (\mathbf{6})$ hypermultiplet matter. Because the cubic index of the $(\mathbf{6})$ representation of the $SU(4)$ vanishes (it's a real representation), the anomaly-free abelian flavor symmetry of this model acts on the $(\mathbf{6})$ fields only and leaves the $8(\mathbf{4})$ fields neutral. Translating this result back into the type I' language, we see that the $(\mathbf{6})$ states living at $x^6 = 0$ have a 9D $U(1)$ charge but the $(\mathbf{4}, \mathbf{8})$ states living at $x^6 = L - b$ remain neutral. This is very important for the eventual 9D symmetry enhancement $U(1) \rightarrow E_1 = SU(2)$ because the $(\mathbf{4}, \mathbf{8})$ states are $SU(2)$ singlets.

In light of the above argument, we would like to conclude that the *Mysterious* junction (7.5) is simply the $\lambda(L) \rightarrow \infty$ limit of a $\frac{1}{2}$ NS5 junction with four D6 branes. Unfortunately, this is not a well defined limit because the NS5 half-brane's tension is proportional to the $\lambda^{-1}(L)$ while its geometric size as a soliton is proportional to the $\lambda^{+1}(L)$. Indeed, in the strong coupling limit, the NS5 half-brane is best described as a magnetic monopole [11] of the $SU(2)$ SYM living on the orientifold plane. This $SU(2)$ is spontaneously broken down to $U(1)$ by the adjoint Higgs VEV $\propto \lambda^{-1}(L)$, hence magnetic monopoles. Unfortunately, when the Higgs

VEV vanishes and the non-abelian gauge symmetry is restored, the monopoles become zero-tension infinite-size notional entities rather than physical objects located at some particular places in 9D. In particular, in the $\lambda(L) \rightarrow \infty$ limit we cannot affix such a monopole / NS5 half-brane to the D6–O8 junction at $\mathbf{x} = 0$, at least not by any 9D means at our disposal.

Therefore, we *conjecture* that somehow *the D6 branes pin down the NS5 half-brane to the junction and prevent it from bloating to infinite size despite $\lambda(L) = \infty$* . This conjecture is not based on any brane dynamics we know; instead, we are driven to it by the logic of heterotic \leftrightarrow HW \leftrightarrow type I' duality in the orbifold context. It would be very interesting to find out how the conjectured pinning down of the NS5 half-brane actually works — or even to verify that it indeed works — but it's clearly a subject of future research.

Finally, to complete the duality, we need two more conjectures. First, *the \square hypermultiplets made of open 66 strings in the throat of such a pinned-down NS5 half-brane are half-doublets of the 9D gauge symmetry $E_1 = SU(2)$* . Again, we do not know the type I' origin of such E_1 quantum numbers, we simply infer them from the heterotic \rightarrow HW \rightarrow I' duality chain. Furthermore, we note that half-doublets of an $SU(2)$ symmetry are allowed only for hypermultiplets in a *real* representation of all other symmetries. Consequently, the \square representation of the 7D $SU(N)$ symmetry must be real, which happens only for the $N = 4$. Therefore, we *conjecture* that *it takes precisely four D6 branes to pin down a NS5 half-brane to a $\lambda = \infty$ junction*.

7.2 A \mathbb{Z}_6 MODEL WITH E_1 SYMMETRY.

The conjectures we made would be better for a proof or at least for another example of a similar junction (7.5). Let us therefore consider a T^4/\mathbb{Z}_6 heterotic orbifold in which the $E_8^{(1)}$ is broken down to $SO(12) \times SU(2) \times U(1)$ (lattice shift vector $\delta_1 = (-\frac{5}{6}, \frac{1}{6}, 0, \dots, 0)$) and the $E_8^{(2)}$ down to $SU(6) \times SU(2) \times SU(2) \times U(1)$ (shift vector $\delta_2 = (-\frac{3}{4}, \frac{1}{4}, \frac{1}{12}, \dots, \frac{1}{12})$). In terms of the unbroken subgroups, the

E_8 -breaking twists act according to

$$\begin{aligned}
\alpha_1(\mathbf{248}) &= +[(\mathbf{66}, \mathbf{1}, 0) + (\mathbf{1}, \mathbf{3}, 0) + (\mathbf{1}, \mathbf{1}, 0)] \\
&\quad + e^{+2\pi i/6} (\mathbf{12}, \mathbf{2}, -1) + e^{-2\pi i/6} (\mathbf{12}, \mathbf{2}, +1) \\
&\quad + e^{+4\pi i/6} [(\mathbf{32}, \mathbf{1}, +1) + (\mathbf{1}, \mathbf{1}, -2)] \\
&\quad + e^{-4\pi i/6} [(\mathbf{32}, \mathbf{1}, -1) + (\mathbf{1}, \mathbf{1}, +2)] \\
&\quad - (\mathbf{32}', \mathbf{2}, 0), \\
\alpha_2(\mathbf{248}) &= +[(\mathbf{35}, \mathbf{1}, \mathbf{1}, 0) + (\mathbf{1}, \mathbf{3}, \mathbf{1}, 0) + (\mathbf{1}, \mathbf{1}, \mathbf{3}, 0) + (\mathbf{1}, \mathbf{1}, \mathbf{1}, 0)] \quad (7.6) \\
&\quad + e^{+2\pi i/6} [(\overline{\mathbf{15}}, \mathbf{1}, \mathbf{2}, +1) + (\mathbf{6}, \mathbf{2}, \mathbf{1}, -2)] \\
&\quad + e^{-2\pi i/6} [(\mathbf{15}, \mathbf{1}, \mathbf{2}, -1) + (\overline{\mathbf{6}}, \mathbf{2}, \mathbf{1}, +2)] \\
&\quad + e^{+4\pi i/6} [(\mathbf{15}, \mathbf{1}, \mathbf{1}, +2) + (\overline{\mathbf{6}}, \mathbf{2}, \mathbf{2}, -1)] \\
&\quad + e^{-4\pi i/6} [(\overline{\mathbf{15}}, \mathbf{1}, \mathbf{1}, -2) + (\mathbf{6}, \mathbf{2}, \mathbf{2}, +1)] \\
&\quad - [(\mathbf{20}, \mathbf{2}, \mathbf{1}, 0) + (\mathbf{1}, \mathbf{1}, \mathbf{2}, \pm 3)].
\end{aligned}$$

The untwisted sector of the orbifold's spectrum comprises SUGRA and dilaton multiplets, 112 vector multiplets in the adjoint representation of

$$G = [SO(12) \times SU(2)_A \times U(1)_1] \times [SU(6) \times SU(2)_B \times SU(2)_C \times U(1)_2], \quad (7.7)$$

two moduli and 66 charged hypermultiplets,

$$H_0 = (\mathbf{12}, \mathbf{2}, -1; \mathbf{1}, \mathbf{1}, \mathbf{1}, 0) + (\mathbf{1}, \mathbf{1}, 0; \overline{\mathbf{15}}, \mathbf{1}, \mathbf{2}, +1) + (\mathbf{1}, \mathbf{1}, 0; \mathbf{6}, \mathbf{2}, \mathbf{1}, -2) + 2M. \quad (7.8)$$

Organizing the twisted sectors according to the fixed planes of the orbifold, we have five \mathbb{Z}_2 fixed planes (16 hypermultiplets per plane), four \mathbb{Z}_3 fixed planes (36 hypermultiplets per plane), and one \mathbb{Z}_6 fixed plane carrying 60 hypermultiplets with rather complicated quantum numbers:

$$\begin{aligned}
H_{\text{tw}}[\mathbb{Z}_6] &= (\mathbf{1}, \mathbf{2}, +\frac{2}{3}; \mathbf{6}, \mathbf{1}, \mathbf{1}, -1) + (\mathbf{1}, \mathbf{1}, -\frac{2}{3}; \mathbf{6}, \mathbf{2}, \mathbf{1}, 0) \\
&\quad + \frac{1}{2}(\mathbf{1}, \mathbf{2}, 0; \mathbf{1}, \mathbf{2}, \mathbf{2}, 0) + (\mathbf{1}, \mathbf{1}, +\frac{4}{3}; \mathbf{1}, \mathbf{1}, \mathbf{2}, -1) \\
&\quad + (\mathbf{12}, \mathbf{1}, -\frac{1}{3}; \mathbf{1}, \mathbf{2}, \mathbf{1}, +1) \\
&\quad + 2(\mathbf{1}, \mathbf{2}, +\frac{2}{3}; \mathbf{1}, \mathbf{2}, \mathbf{1}, +1) + 2(\mathbf{1}, \mathbf{1}, +\frac{2}{3}; \mathbf{1}, \mathbf{1}, \mathbf{1}, -2).
\end{aligned} \quad (7.9)$$

At a first glance, these quantum numbers look too complicated for any HW picture we might be able to write down. Fortunately, brane engineering comes to rescue, so let us consider the following monsterpiece:

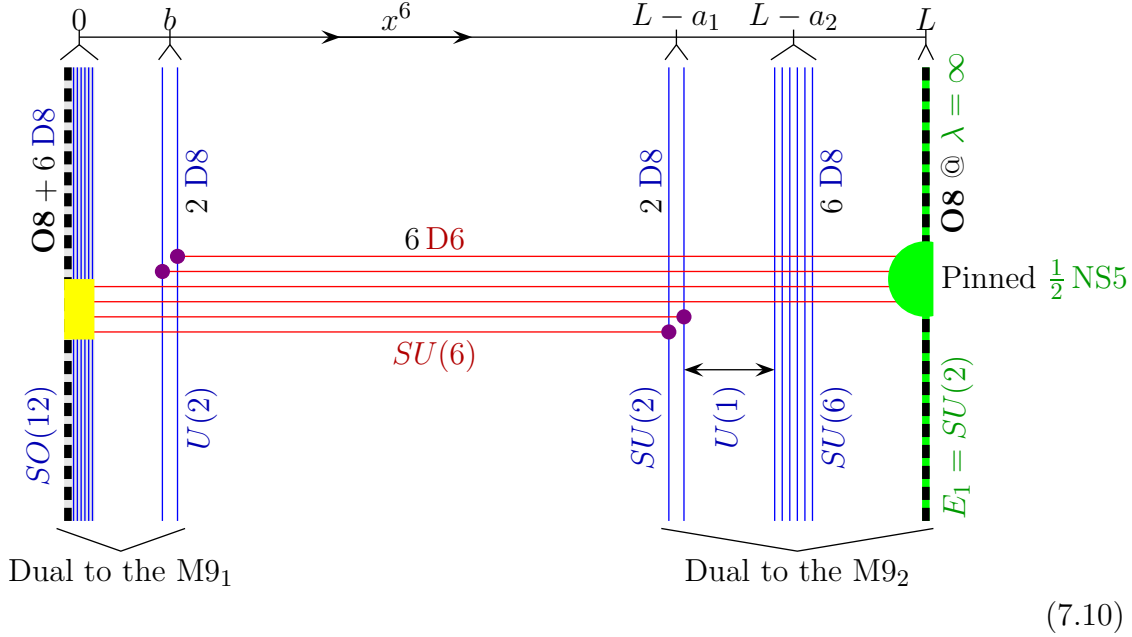

On the left side of this brane diagram, the two outlier D8 branes are at less-than-critical distance $b < a_c$ from the orientifold plane, hence finite $\lambda(0)$ and the 9D gauge symmetry is purely classical $SO(12) \times U(2)$. Of the six D6 branes dual to the \mathbb{Z}_6 O6 plane, two have their left termini on the outlier D8 branes at $x^6 = b$. Brane junctions of this type were discussed in detail in section 5; applying the same general rules to the junction at hand, we find the $SU(6)^{7D}$ gauge symmetry broken down to $SU(2)_1 \times SU(4) \times U(1)$ and furthermore $[SU(2)_1 \times U(1)]^{7D} \times [SU(2)_A \times U(1)_1]^{9D} \rightarrow [SU(2)_A \times U(1)_1]^{\text{diag}}$. The other four D6 branes end on the O8 plane at $x^6 = 0$ where the 7D gauge symmetry is further broken $SU(4) \rightarrow Sp(2)$ and the 68 open strings give rise to localized 6D massless half-hypermultiplets in the bi-fundamental representation of the $Sp(2) \times SO(12)$.

According to the $I' \leftrightarrow$ HW duality, the two brane junctions at $x^6 = 0$ and $x^6 = b$ are together dual to the $\mathcal{I}5_1$ intersection plane. Totalling their combined

effect, we have

$$\mathcal{I}5_1 \begin{cases} G^{\text{local}} = SO(12)^{10\text{D}} \times [SU(2)_A \times U(1)_1]^{\text{diag}} \times Sp(2)^{7\text{D}}, \\ 7\text{D } H = (\mathbf{1}, \mathbf{3}, \mathbf{0}, \mathbf{1}) + (\mathbf{1}, \mathbf{1}, \mathbf{0}, \mathbf{1}) + 2(\mathbf{1}, \mathbf{2}, +\mathbf{1}, \mathbf{4}) + (\mathbf{1}, \mathbf{1}, \mathbf{0}, \mathbf{5}), \\ 7\text{D } V = (\mathbf{1}, \mathbf{1}, \mathbf{0}, \mathbf{10}), \\ 6\text{D } H = \frac{1}{2}(\mathbf{12}, \mathbf{1}, \mathbf{0}, \mathbf{4}). \end{cases} \quad (7.11)$$

On the right side of the brane diagram (7.10) we have a critical combination of the distances a_1 and a_2 , hence $\lambda(L) = \infty$ and the 9D gauge symmetry enhancement from $U(2) \times U(6)$ to $S(U(2) \times U(6)) \times E_1 \equiv SU(6) \times SU(2)_B \times U(1)_2 \times SU(2)_C$. For the **D6** branes, the right side offers three junctions: First, at $(L - a_1)$ two of the six **D6** branes terminate on the **D8** branes. Consequently, the $SU(6)^{7\text{D}}$ gauge symmetry breaks down to $SU(4) \times SU(2)_3 \times U(1)$ and furthermore $[SU(2)_3 \times U(1)]^{7\text{D}} \times [SU(2)_B \times U(1)_2]^{9\text{D}} \rightarrow [SU(2)_B \times U(1)_2]^{\text{diag}}$. Second, at $(L - a_2)$ there is a **D6/D8** brane crossing which produces localized 6D hypermultiplets in the bi-fundamental of the $SU(4) \times SU(6)$. Finally, at $x^6 = L$ the four **D6** branes pin down an **NS5** half-brane to the $\lambda = \infty$ orientifold plane. We presume this junction works exactly as conjectured in the previous section, *cf.* eqs. (7.5), thus unbroken $SU(4)$ and localized half-hypermultiplets with $(\mathbf{6}, \mathbf{2})$ quantum numbers.

Together, the three junctions are dual to the $\mathcal{I}5_2$ intersection plane of the HW picture. Their net effect amounts to

$$\mathcal{I}5_2 \begin{cases} G^{\text{local}} = SU(4)^{7\text{D}} \times [SU(2)_C \times U(1)_2]^{\text{diag}} \times [SU(6) \times SU(2)_C]^{10\text{D}}, \\ 7\text{D } H = (\mathbf{1}, \mathbf{3}, \mathbf{0}, \mathbf{1}, \mathbf{1}) + (\mathbf{1}, \mathbf{1}, \mathbf{0}, \mathbf{1}, \mathbf{1}) + 2(\mathbf{4}, \mathbf{2}, \beta, \mathbf{1}, \mathbf{1}), \\ 7\text{D } V = (\mathbf{15}, \mathbf{1}, \mathbf{0}, \mathbf{1}, \mathbf{1}), \\ 6\text{D } H = (\mathbf{4}, \mathbf{1}, \gamma, \mathbf{6}, \mathbf{1}) + \frac{1}{2}(\mathbf{6}, \mathbf{1}, \mathbf{0}, \mathbf{1}, \mathbf{2}). \end{cases} \quad (7.12)$$

The abelian charges β and γ in these formulæ depend on the precise manner of the $U(1)^{7\text{D}} \times U(1)_2^{9\text{D}} \rightarrow U(1)_2^{\text{diag}}$ diagonalization. The simplest way to determine these charges is via anomaly considerations; in the Appendix we show that all local anomalies at the $\mathcal{I}5_2$ cancel out provided $\beta = +\frac{3}{2}$ and $\gamma = -\frac{1}{2}$.

In order to make sense out of the local quantum numbers in eqs. (7.11–12) we need to combine the $SU(6)^{7D}$ breaking effects at both ends of the x^6 . Diagrammatically,

$$\begin{array}{ccc}
SU(6) & \rightarrow & SU(4)_{12} \times SU(2)_3 \times U(1) \\
\downarrow & & \downarrow \\
SU(2)_1 \times SU(4)_{23} \times U(1) & \rightarrow & SU(2)_1 \times SU(2)_2 \times SU(2)_3 \times U(1)^2 \quad (7.13) \\
\downarrow & & \downarrow \\
SU(2)_1 \times Sp(2) \times U(1) & \rightarrow & SU(2)_1 \times SU(2)_{2+3} \times U(1)^2
\end{array}$$

where the upper block follows from the left and right termini of the six $D6$ branes in fig. (7.10) matching each other in in three distinct pairs while the lower block accounts for the orientifold projection at $x^6 = 0$, *cf.* eq. (5.49). The abelian charges may be identified via either chain of symmetry breaking, hence we may use

$$\begin{array}{l}
\text{either } \left\{ \begin{array}{l} X_1 = \text{diag}(0, 0, \frac{+1}{2}, \frac{+1}{2}, \frac{-1}{2}, \frac{-1}{2}), \\ Y_1 = \text{diag}(\frac{+2}{3}, \frac{+2}{3}, \frac{-1}{3}, \frac{-1}{3}, \frac{-1}{3}, \frac{-1}{3}), \end{array} \right. \\
\text{or } \left\{ \begin{array}{l} X_2 = \text{diag}(\frac{+1}{2}, \frac{+1}{2}, \frac{-1}{2}, \frac{-1}{2}, 0, 0), \\ Y_2 = \text{diag}(\frac{+1}{3}, \frac{+1}{3}, \frac{+1}{3}, \frac{+1}{3}, \frac{-2}{3}, \frac{-2}{3}); \end{array} \right.
\end{array} \quad (7.14)$$

the two sets of charges are related according to

$$\left\{ \begin{array}{l} X_1 = \frac{3}{4}Y_2 - \frac{1}{2}X_2 \\ Y_1 = \frac{1}{2}Y_2 + X_2 \end{array} \right\} \longleftrightarrow \left\{ \begin{array}{l} X_2 = \frac{3}{4}Y_1 - \frac{1}{2}X_1 \\ Y_2 = \frac{1}{2}Y_1 + X_1 \end{array} \right\}. \quad (7.15)$$

Locally at the $\mathcal{I}5_2$ intersection, the $U(1)_2^{\text{diag}}$ charge is βY_2 while X_2 is one of the $SU(4)$ generators. Consequently, the $(\mathbf{4}, \mathbf{1}, \gamma, \mathbf{6}, \mathbf{1})$ hypermultiplets localized at the $\mathcal{I}5_2$ have $Y_2 = (\gamma/\beta) = -\frac{1}{3}$ and $X_2 = \pm\frac{1}{2}$. Specifically, we have doublets of the $SU(2)_1$ with $X_2 = +\frac{1}{2}$ and doublets of the $SU(2)_2$ with $X_2 = -\frac{1}{2}$. Following

7D/10D symmetry mixings at both ends of the world, the quantum numbers of these states evolve according to the following trajectories

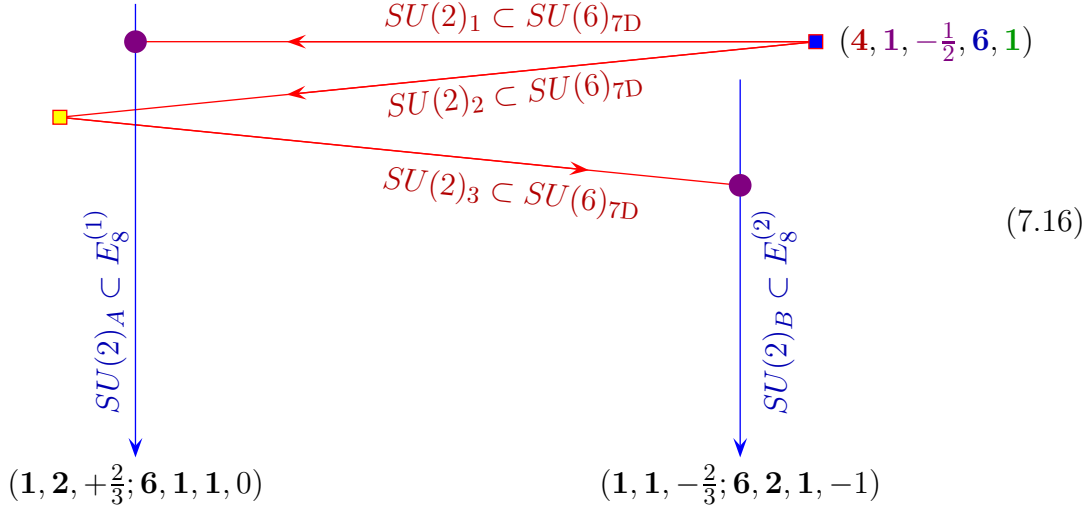

and eventually become precisely as on the first line of eq. (7.9), provided we identify the abelian charges according to

$$\begin{aligned}
 C_1^{\text{heterotic}} &= C_{U(1) \subset E_8^{(1)}}^{\text{HW}} + \left(\frac{4}{3}X_2 = Y_1 - \frac{2}{3}X_1\right), \\
 C_2^{\text{heterotic}} &= C_{U(1) \subset E_8^{(2)}}^{\text{HW}} + \left(\frac{3}{2}Y_2 - X_2 = 2X_1\right).
 \end{aligned}
 \tag{7.17}$$

Similarly, the $\frac{1}{2}(\mathbf{6}, \mathbf{1}, \mathbf{0}, \mathbf{1}, \mathbf{2})$ states at $\mathcal{I}5_2$ (originating from the pinned down NS5 half-brane) have $Y_2 = 0$ while the $\mathbf{6} \in SU(4)$ splits into a bi-doublet of $SU(2)_1 \times SU(2)_2$ with $X_2 = 0$ and two singlets with $X_2 = \pm 1$. Again, these quantum numbers evolve according to

$$\begin{array}{ccc}
\bullet & \xleftarrow{SU(2)_1 \subset SU(6)_{7D}} & \blacksquare \frac{1}{2}(6, 1, 0, 1, 2) \\
& \xleftarrow{SU(2)_2 \subset SU(6)_{7D}} & \\
\blacksquare & \xrightarrow{SU(2)_3 \subset SU(6)_{7D}} & \bullet \\
\downarrow SU(2)_A \subset E_8^{(1)} & & \downarrow SU(2)_B \subset E_8^{(2)} \\
(1, 1, +\frac{4}{3}; 1, 1, 2, -1) & & \frac{1}{2}(1, 2, 0; 1, 2, 2, 0)
\end{array} \tag{7.18}$$

and eventually become precisely as on the second line of eq. (7.9).

Next, consider the $\mathcal{I}5_1$ intersection plane and the $\frac{1}{2}(\mathbf{12}, \mathbf{1}, \mathbf{0}, \mathbf{4})$ hypermultiplets which live there. In terms of the unbroken symmetries of the model, these states have $Y_1 = 0$ (Y_1 being the local $U(1)_1$ abelian charge) and $X_1 = \frac{1}{2}$ (which follows from $X_1 \in Sp(2)$); they are also doublets of the $SU(2)_{2+3}$, which translates into the heterotic language as $SU(2)_B \subset E_8^{(2)}$. Consequently, we have $(\mathbf{12}, \mathbf{1}, -\frac{1}{3}; \mathbf{1}, \mathbf{2}, \mathbf{1}, +1)$, exactly as on the third line of eq. (7.9).

The remaining twisted states arise as zero modes of 7D hyper fields with Neumann boundary conditions at both ends. The following table lists the $SU(6)^{7D}$ SYM fields according to their $SU(2)_1 \times SU(2)_{2+3} \times U(1)^2$ and 8-SUSY quantum numbers and shows the boundary conditions at $\mathcal{I}5_{1,2}$ according to eqs. (7.11–12):

Charges			Boundary Conditions	
$SU(2)_1 \times SU(2)_{2+3}$	(X_1, Y_1)	(X_2, Y_2)	8-SUSY vector	hyper
$(\mathbf{3}, \mathbf{1})$	$(0, 0)$	$(0, 0)$	(locking, Neumann)	(Neumann, Dirichlet)
$(\mathbf{1}, \mathbf{1})$	$(0, 0)$	$(0, 0)$	(locking, Neumann)	(Neumann, Dirichlet)
$(\mathbf{1}, \mathbf{3})$	$(0, 0)$	$(0, 0)$	(Neumann, locking)	(Dirichlet, Neumann)
$(\mathbf{1}, \mathbf{1})$	$(0, 0)$	$(0, 0)$	(Neumann, locking)	(Dirichlet, Neumann)
$(\mathbf{1}, \mathbf{3})$	$(\pm 1, 0)$	$(\mp \frac{1}{2}, \pm 1)$	(Neumann, Dirichlet)	(Dirichlet, Neumann)
$(\mathbf{1}, \mathbf{3})$	$(0, 0)$	$(0, 0)$	(Dirichlet, Neumann)	(Neumann, Dirichlet)
$(\mathbf{2}, \mathbf{2})$	$(\pm \frac{1}{2}, \mp 1)$	$(\mp 1, 0)$	(Dirichlet, Neumann)	(Neumann, Dirichlet)
$(\mathbf{1}, \mathbf{1})$	$(\pm 1, 0)$	$(\mp \frac{1}{2}, \pm 1)$	(Dirichlet, Dirichlet)	(Neumann, Neumann)
$(\mathbf{2}, \mathbf{2})$	$(\pm \frac{1}{2}, \pm 1)$	$(\pm \frac{1}{2}, \pm 1)$	(Dirichlet, Dirichlet)	(Neumann, Neumann)

(7.19)

On the last two lines of this table we indeed find hypermultiplets with Neumann BC at both ends and hence zero modes. Translating their abelian charges into the heterotic language according to eqs. (7.17) and identifying the two $SU(2)_1 \times SU(2)_{2+3}$ as $SU(2)_A \times SU(2)_B$, we find precisely the twisted states on the last line of eq. (7.9).

This completes our verification of the heterotic \leftrightarrow HW \leftrightarrow I' duality as far as the massless spectrum of the model is concerned. In the Appendix we verify the remaining duality constraints due to 6D gauge couplings and local anomaly cancellation. The bottom line is, in spite of formidable complexity of this model, the duality works like *Magic!*

Among other things, this *Magic* involves a junction where four **D6** branes pin down an **NS5** half-brane on an $\mathbf{O8}^{\lambda=\infty}$ orientifold plane. To maintain the duality, this junction must work precisely according to eqs. (7.5); this gives us strong ‘experimental’ evidence in favor of the conjectures we made in the previous section. In particular, we confirm that the $\frac{1}{2}\mathbf{NS}@\mathbf{O8}^{\lambda=\infty}$ junction involves precisely $N = 4$ **D6** branes: Although our model (7.10) has six **D6** branes in the middle of the x^6 dimension, only four of them reach the **NS5** half-brane while the other two terminate elsewhere!

7.3 JUNCTIONS AT $\mathbf{O8}^*$ PLANES: A \mathbb{Z}_3 EXAMPLE.

All the type I'/D6 brane models we considered thus far were either within or at the limit of the classical moduli space of the type I' superstring. That is, even in the models where the string coupling diverged at the orientifold planes, we could ‘detune’ such divergence and keep λ finite after an infinitesimal change of Wilson lines around the multi-Taub-NUT configuration of the HW theory. In this section, we go beyond the classical limits and encounter an *excited* orientifold plane [13] $\mathbf{O8}^*$ which has D-brane charge -9 rather than -8 and *requires* $\lambda = \infty$ for its very existence.

Consider the the T^4/\mathbb{Z}_3 model of ref. [3] where the $E_8^{(1)}$ is broken down to $E_6 \times SU(3)$ and the $E_8^{(2)}$ down to $E_0 \times SU(9) \equiv SU(9)$. The E_0 factor here is trivial as a symmetry group, but in the type I' terms it denotes a very non-trivial $\mathbf{O8}^*$ plane at $x^6 = L$ (see section 3 for discussion):

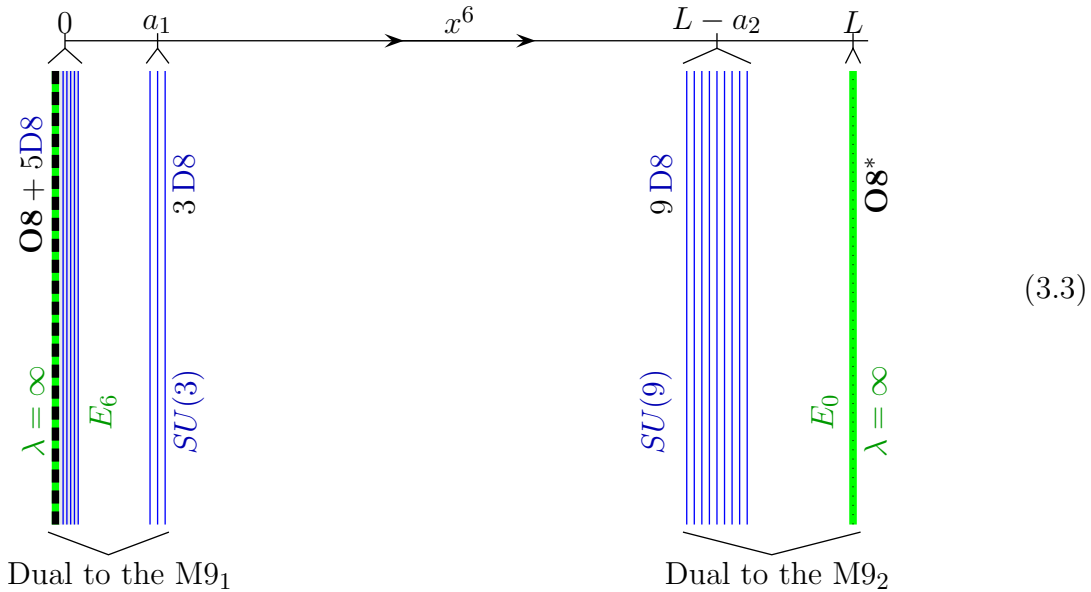

Thanks to the -9 charge of this plane, we put nine rather than eight coincident D8 branes at the critical location $L - a_2$ where they carry an $SU(9)$ SYM on their world-volume. The $\mathbf{O8}^*$ plane itself does not carry any 9D fields, but manifests

itself via non-trivial junctions with the **D6** branes. On the left side of diagram (3.3), we have a more conventional **O8**[−] plane accompanied by 5 **D8** branes while 3 more **D8** branes are at critical distance a_1 away. Due to this criticality, $\lambda(0) = \infty$ and the classical $SO(10) \times U(3)$ gauge symmetry is enhanced to the $E_6 \times SU(3)$.

In the HW picture of the T^4/\mathbb{Z}_3 orbifold, each **O6** fixed plane carries an $SU(3)$, which locks upon the 10D $SU(3) \subset E_1^{(1)}$ at the left intersection $\mathcal{I}5_1$; the twisted $(\mathbf{1}, \mathbf{3}, \mathbf{9})$ states live at the right intersection $\mathcal{I}5_2$. Altogether, we have

$$\mathcal{I}5_1 \left\{ \begin{array}{l} G^{\text{local}} = SU(3)^{\text{diag}} \times [E_6]^{10\text{D}}, \\ 7\text{D } H = 8, \\ 7\text{D } V = 0, \\ 6\text{D } H = 0; \end{array} \right. \quad (7.20)$$

$$\mathcal{I}5_2 \left\{ \begin{array}{l} G^{\text{local}} = SU(3)^{7\text{D}} \times SU(9)^{10\text{D}}, \\ 7\text{D } H = 0, \\ 7\text{D } V = 8, \\ 6\text{D } H = (\mathbf{3}, \mathbf{9}). \end{array} \right. \quad (7.21)$$

Brane-wise, the left intersection $\mathcal{I}5_1$ is evidently dual to the §4.4 type of a junction where the three **D6** branes (dual to the \mathbb{Z}_3 **O6**) end on the three outlier **D8** branes at $x^6 = a_1$. On the right side of the brane picture, the existence of the $(\mathbf{3}, \mathbf{9})$ localized states as well as absence of $SU(3)$ locking clearly calls for the **D6** branes crossing the **D8** branes at $x^6 = L - a_2$ without termination. This leaves only one option for their eventual right terminus — right on the **O8**^{*} plane at $x^6 = L$, *cf.* the following diagram:

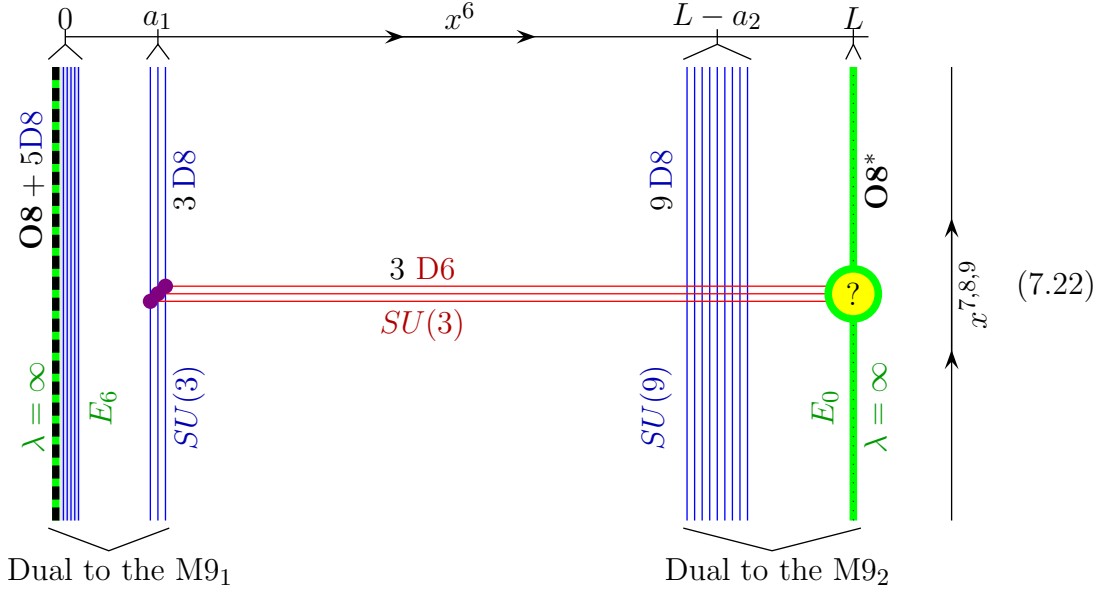

The yellow circle with a ‘?’ here denotes a **D6/O8*** junction whose string theory is beyond our present knowledge. Instead, we may use $\text{HW} \leftrightarrow I'$ duality to argue that this junction — whatever it is — must accomplish the $\mathcal{I}5_2$ intersection’s job (*cf.* eqs. (7.21)) which isn’t accomplished by the the **D6/D8** brane crossing at $x^6 = (L - a_2)$. Consequently, for duality’s sake, *we conjecture* that the **D6/O8*** junction somehow produces: (1) Neumann boundary conditions for all **8** 7D vector fields, (2) Dirichlet boundary conditions for the 7D hypermultiplet fields, and (3) no localized 6D massless particles,

$$\left\{ \begin{array}{l} G^{\text{local}} = SU(3) \times E_0, \\ 7\text{D } V = 8, \\ 7\text{D } H = 0, \\ 6\text{D } H = 0. \end{array} \right. \quad (7.23)$$

Note that the survival of the whole $SU(3)^{7\text{D}}$ gauge symmetry at this junction

is quite different from the orientifold projection $SU(N) \rightarrow Sp(N/2)$ at ordinary **D6/O8** junctions, *cf.* §4.3. Consequently, while the ordinary **O8** planes require an even number N of **D6** branes to terminate at the same point \mathbf{x} , the **O8*** plane is evidently quite happy with an odd **D6** number $N = 3$.

7.4 A \mathbb{Z}_4 EXAMPLE OF AN **O8*** JUNCTION.

Again, to affirm the conjectures we made about the **D6/O8*** junction (7.23) we present another orbifold model with a similar junction. In heterotic terms, the model is an T^4/\mathbb{Z}_4 orbifold with $E_8^{(1)}$ broken down to $SO(12) \times SU(2) \times U(1)$ (*cf.* eq. (5.32)) and $E_8^{(2)}$ down to $SU(8) \times U(1)$; in lattice terms, $\delta_2 = (\frac{5}{8}, \frac{1}{8}, \dots, \frac{1}{8})$ while in terms of the surviving gauge symmetry,

$$\begin{aligned} \alpha_2(\mathbf{248}) = & +[(\mathbf{63}, 0) + (\mathbf{1}, 0)] - [(\mathbf{28}, +1) + (\overline{\mathbf{28}}, -1)] \\ & + i[(\overline{\mathbf{56}}, +\frac{1}{2}) + (\mathbf{8}, -\frac{3}{2})] - i[(\mathbf{56}, -\frac{1}{2}) + (\overline{\mathbf{8}}, +\frac{3}{2})]. \end{aligned} \quad (7.24)$$

The untwisted sector of this model comprises the usual SUGRA and dilaton multiplets, 134 vector multiplets in the adjoint of

$$G = [SO(12) \times SU(2) \times U(1)] \times [SU(8) \times U(1)], \quad (7.25)$$

2 moduli and 120 charged hypermultiplets,

$$H_0 = (\mathbf{32}, \mathbf{1}, +1; \mathbf{1}, 0) + (\mathbf{12}, \mathbf{2}, -1; \mathbf{1}, 0) + (\mathbf{1}, \mathbf{1}, 0; \overline{\mathbf{56}}, +\frac{1}{2}) + (\mathbf{1}, \mathbf{1}, 0; \mathbf{8}, -\frac{3}{2}) + 2M. \quad (7.26)$$

Arranging the twisted sector according to the $\mathcal{O}5$ fixed planes, we have 6 \mathbb{Z}_2 planes carrying 16 hypermultiplets per plane,

$$H_{\text{tw}}[\mathbb{Z}_2] = (\mathbf{1}, \mathbf{1}, \pm 1; \mathbf{8}, +\frac{1}{2}), \quad (7.27)$$

and 4 \mathbb{Z}_4 planes carrying 40 hypermultiplets per plane,

$$\begin{aligned} H_{\text{tw}}[\mathbb{Z}_4] = & (\mathbf{12}, \mathbf{1}, -\frac{1}{2}; \mathbf{1}, +1) + (\mathbf{1}, \mathbf{2}, +\frac{1}{2}; \mathbf{8}, -\frac{1}{2}) + (\mathbf{1}, \mathbf{1}, -1; \mathbf{8}, +\frac{1}{2}) \\ & + 2(\mathbf{1}, \mathbf{2}, +\frac{1}{2}; \mathbf{1}, +1). \end{aligned} \quad (7.28)$$

The brane dual of such a \mathbb{Z}_4 fixed plane is engineered as follows:

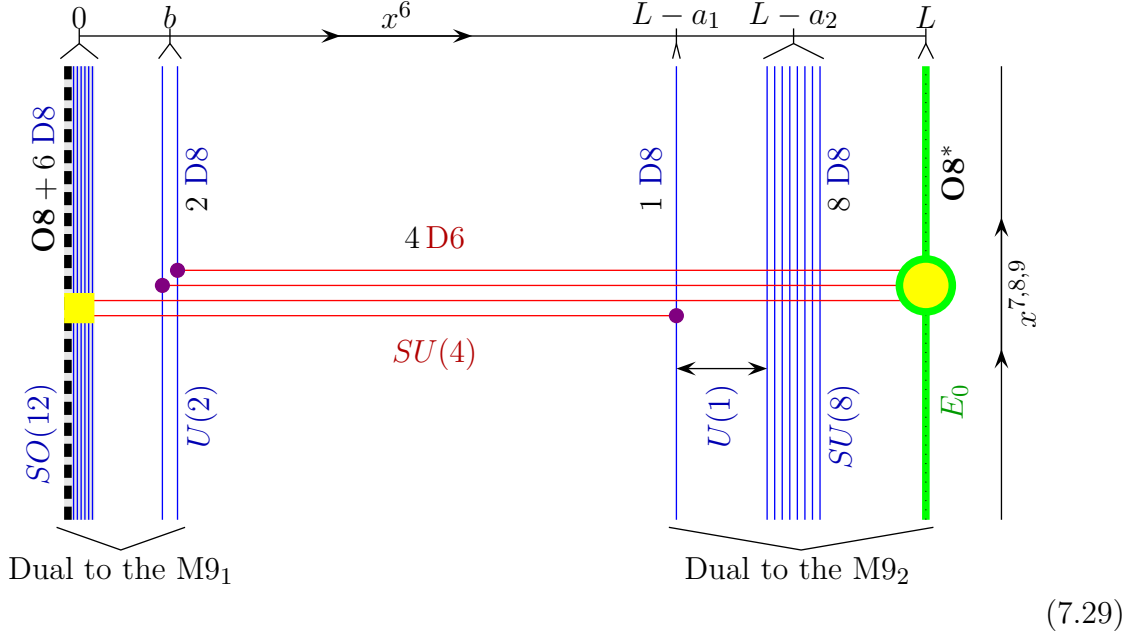

The left half of this diagram is similar to that of fig (5.40) and works in exactly the same way: First, at $x^6 = b$ the $SU(4)^{7D}$ gauge symmetry breaks down to $SU(2)_1 \times SU(2)_2 \times U(1)$ and the $SU(2)_2 \times U(1)$ gauge fields lock onto the 9D $SU(2) \times U(1)$ fields. Second, at $x^6 = 0$ the 68 opens strings produce localized half-hypermultiplets in the bi-fundamental representation of the $SU(2)_1 \times SO(12)$. Together, the two junctions are dual to the $\mathcal{I}5_1$ intersection of the HW picture whose net effect is therefore

$$\mathcal{I}5_1 \left\{ \begin{array}{l} G^{\text{local}} = SO(12)^{10D} \times [SU(2)_1 \times U(1)]^{\text{diag}} \times SU(2)_2^{7D}, \\ 7D V = (\mathbf{1}, \mathbf{1}, 0, \mathbf{3}), \\ 7D H = (\mathbf{1}, \mathbf{3}, 0, \mathbf{1}) + (\mathbf{1}, \mathbf{1}, 0, \mathbf{1}) + (\mathbf{1}, \mathbf{2}, \pm 1, \mathbf{2}), \\ 6D H = \frac{1}{2}(\mathbf{12}, \mathbf{1}, 0, \mathbf{2}). \end{array} \right. \quad (7.30)$$

The right half of the diagram (7.29) is more complicated. The $SU(8) \times U(1)$ subgroup of E_8 described in eq. (7.24) is actually $S(U(8) \times U(1)) \times E_0$, hence the $O8^*$ plane at $x^6 = L$ and nine $D8$ branes, eight at $(L - a_2)$ and one further away

at $(L - a_1)$.^{*} Therefore, the $\mathcal{I}5_2$ intersection of the HW picture is dual to three distinct brane junctions: First, at $(L - a_1)$ one of the **D6** branes ends on the outlier **D8** brane. Consequently, the $SU(4)^{7D}$ gauge symmetry breaks to $SU(3) \times U(1)$ and furthermore $U(1)^{7D} \times U(1)^{9D} \rightarrow U(1)^{\text{diag}}$. Second, there is a **D6/D8** brane crossing at $(L - a_2)$ which yields localized hypermultiplets in the bi-fundamental representation of the $SU(3) \times SU(8)$. Finally, three **D6** branes terminate on **O8*** at $x^6 = L$; we presume this junction to work exactly as in the previous model, *cf.* eqs. (7.23).

In HW terms, the net effect of the three junctions is as follows:

$$\mathcal{I}5_2 \left\{ \begin{array}{l} G^{\text{local}} = SU(8)^{10D} \times U(1)^{\text{diag}} \times SU(3)^{7D}, \\ 7D V = (\mathbf{1}, 0, \mathbf{8}), \\ 7D H = (\mathbf{1}, 0, \mathbf{1}) + 2(\mathbf{1}, \beta, \mathbf{3}), \\ 6D H = (\mathbf{8}, \gamma, \mathbf{3}), \end{array} \right. \quad (7.31)$$

where the abelian charges β and γ are non-zero but their exact values depend on the details of the $U(1)$ gauge fields locking. As in §7.2, we use anomaly considerations to determine $\beta = +\frac{2}{3}$, $\gamma = -\frac{1}{6}$, *cf.* calculation in the Appendix.

To verify that eqs. (7.30) and (7.31) correctly describe the HW picture of the heterotic model, we need to combine the $SU(4)^{7D}$ breaking effects at both ends of the x^6 ,

$$\begin{array}{ccc} SU(4) & \rightarrow & SU(3) \times U(1) \\ \downarrow & & \downarrow \\ SU(2)_1 \times U(1) \times SU(2)_2 & \rightarrow & SU(2)_1 \times U(1) \times U(1). \end{array} \quad (7.32)$$

Note that the surviving $SU(2)$ subgroup is the $SU(2)_1$ (which locks onto the $SU(2) \subset E_8^{(1)}$ at the $\mathcal{I}5_1$) rather than the $SU(2)_2$ (which acts freely at the $\mathcal{I}5_1$);

^{*} There are two inequivalent $SU(8) \times U(1)$ subgroups of E_8 distinguished by the respective adjoint decompositions, *cf.* eq. (6.4) *v.* eq. (7.24). Brane-wise, the first alternative is depicted on fig. (6.12) and the second on fig. (7.29).

this identification follows from matching the left termini of each of the four **D6** branes in fig. (7.29) with the appropriate right termini. The abelian charges may be identified via either chain of symmetry breaking, hence we may use

$$\begin{aligned} \text{either } X &= \text{diag}\left(+\frac{1}{2}, +\frac{1}{2}, -\frac{1}{2}, -\frac{1}{2}\right) \quad \text{and} \quad T = \text{diag}\left(0, 0, +\frac{1}{2}, -\frac{1}{2}\right) \\ \text{or } Z &= \text{diag}\left(+\frac{1}{4}, +\frac{1}{4}, +\frac{1}{4}, -\frac{3}{4}\right) \quad \text{and} \quad Y = \text{diag}\left(+\frac{1}{3}, +\frac{1}{3}, -\frac{2}{3}, 0\right); \end{aligned} \quad (7.33)$$

the two sets of charges are related according to

$$\left\{ \begin{array}{l} X = \frac{2}{3}Z + Y \\ T = \frac{2}{3}Z - \frac{1}{2}Y \end{array} \right\} \longleftrightarrow \left\{ \begin{array}{l} Z = \frac{1}{2}X + T \\ Y = \frac{2}{3}X - \frac{2}{3}T \end{array} \right\}. \quad (7.34)$$

Locally at the $\mathcal{I}5_1$ intersection, the manifest abelian charge is X while T is a generator of the $SU(2)_2$. Therefore, the 12 hypermultiplets localized at the $\mathcal{I}5_1$ have $(X = 0, T = \frac{1}{2})$ and hence $(Z = \frac{1}{2}, Y = -\frac{1}{3})$. Similarly, locally at the $\mathcal{I}5_2$ the manifest abelian charge is βZ while Y is a generator of the $SU(3)$. Consequently, the $(8, 3)$ hypermultiplets living at the $\mathcal{I}5_2$ have $Z = (\gamma/\beta) = -\frac{1}{8}$ and split into $SU(2)_1$ doublets with $Y = \frac{1}{3} \Rightarrow (X = \frac{1}{4}, T = -\frac{1}{4})$ and $SU(2)_1$ singlets with $Y = -\frac{2}{3} \Rightarrow (X = -\frac{3}{4}, T = +\frac{1}{4})$.

Thanks to the $SU(2)_1^{7D} \times SU(2)^{10D} \rightarrow SU(2)^{\text{diag}}$ symmetry locking, the $SU(2)_1$ quantum numbers of the twisted states appear in the heterotic picture as belonging to the $SU(2) \subset E_8^{(1)}$. Consequently, the non-abelian quantum numbers of the twisted states on the first line of eq. (7.28) precisely correspond to the localized 6D states of the intersection planes $\mathcal{I}5_1 + \mathcal{I}5_2$ of the HW picture. The abelian quantum numbers have a similar correspondence provided we identify

$$\begin{aligned} C_1^{\text{heterotic}} &= C_{U(1) \subset E_8^{(1)}}^{\text{HW}} + \sum_{\substack{z_4 \text{ fixed} \\ \text{planes}}} (X - T = \frac{3}{2}Y), \\ C_2^{\text{heterotic}} &= C_{U(1) \subset E_8^{(2)}}^{\text{HW}} + \sum_{\substack{z_4 \text{ fixed} \\ \text{planes}}} \left(\frac{4}{3}Z - Y = 2T\right). \end{aligned} \quad (7.35)$$

As in models of §5.1 and §7.2, the 7D abelian charge which mixes with the 10D abelian charge at the left end of the world happen to be a part of an unbroken

nonabelian symmetry at the right end of the world and vice verse; we do not know why.

Finally, let us check for 7D fields with Neumann boundary conditions at both ends of the x^6 . Organizing the 7D SYM fields according to their $SU(2)_1 \times U(1) \times U(1)$ and 8-SUSY quantum numbers, we tabulate their respective boundary conditions at $\mathcal{I}5_1$ and at $\mathcal{I}5_2$ as follows:

Charges			Boundary Conditions	
$SU(2)$	(X, T)	(Z, Y)	8-SUSY vector	hyper
(3)	$(0, 0)$	$(0, 0)$	(locking,Neumann)	(Neumann,Dirichlet)
(1)	$(0, 0)$	$(0, 0)$	(locking,Neumann)	(Neumann,Dirichlet)
(2)	$(\pm 1, \mp \frac{1}{2})$	$(0, \pm 1)$	(Dirichlet,Neumann)	(Neumann,Dirichlet)
(1)	$(0, 0)$	$(0, 0)$	(Neumann,locking)	(Dirichlet,Neumann)
(1)	$(0, \pm 1)$	$(\pm 1, \mp \frac{2}{3})$	(Neumann,Dirichlet)	(Dirichlet,Neumann)
(2)	$(\pm 1, \pm \frac{1}{2})$	$(\pm 1, \pm \frac{1}{3})$	(Dirichlet,Dirichlet)	(Neumann,Neumann)

(7.36)

On the last line of this table, we indeed find hypermultiplets with Neumann–Neumann BC and hence zero modes. In heterotic terms, these zero modes manifest itself as twisted states which are $SU(2)$ doublets with $C_1 = \frac{1}{2}$, $C_2 = 1$, — *cf.* the second line of the heterotic twisted spectrum (7.28).

The bottom line of the above discussion is that the HW picture we deduced from the brane model (7.29) yields the correct spectrum from the heterotic point of view. In the Appendix we verify the other kinematic constraints due to 6D gauge couplings and local anomaly cancellation. The conclusion is that our HW picture is correct and therefore, *the HW \leftrightarrow I' duality we used to derive eqs. (7.30–31) is correct.* In particular, *our analysis of various brane junctions of fig. (7.29) was correct, including the $\mathbf{O8}^*$ junction (7.23) at $x^6 = L$.*

We conclude this section with three simple observations. First, we cannot eliminate the $\mathbf{O8}^*/\mathbf{D6}$ brane junction from the brane model (7.29) without a major disruption of the model's spectrum. Indeed, for the sake of $3(\mathbf{8})$ twisted states,

three **D6** branes have to cross the eight **D8** branes and hence terminate on the **O8*** plane simply because they don't have any other place to end. Second, unless the **O8*/D6** junction works exactly as advertised in eqs. (7.23), the twisted spectrum of the brane model does not match that of the heterotic orbifold. Indeed, our analysis (7.32) of the $SU(4)^{7D}$ symmetry breaking depends on the unbroken $SU(3)$ — and hence Neumann BC for the vector fields — at $x^6 = L$. Likewise, the rules of Dirichlet BC for all the 7D hypermultiplets and no local states at the **O8*** junction are important for avoiding extra twisted states not present in the heterotic spectrum.

Finally, assuming eqs. (7.23) for the **O8*/D6** junction at $x^6 = L$, we have the heterotic \leftrightarrow HW \leftrightarrow I' duality working like *Magic*. Naturally, in light of these observations we come to the evident conclusion that eqs. (7.23) must hold true, string only knows how.

7.5 AN **O8*** JUNCTION WITH SIX **D6** BRANES.

Both our previous examples of **O8*/D6** junctions had $N = 3$ **D6** branes terminating at the same point of the **O8*** plane. Despite diligently searching for other examples involving $N = 2, 4$ or 5 **D6** branes, we did not find any. We suspect such junctions may be forbidden, although that remains to be confirmed via more extensive model building. We do however have an example with $N = 6$ branes, so the rule for the **D6** branes ending on an **O8*** plane seems to be $N \equiv 0$ modulo 3 (we wonder why).

Our example is the good old T^4/\mathbb{Z}_6 model of ref. [3] in which the $E_8^{(1)}$ is broken down to $SU(6) \times E_3 \equiv SU(6) \times SU(3) \times SU(2)$ (*cf.* eq. (6.3)) while the $E_8^{(2)}$ is broken down to the $SU(9) \times E_0 \equiv SU(9)$ similarly to the T^4/\mathbb{Z}_3 model of §7.3 (and indeed the $\alpha_2 : \mathbb{Z}_6 \mapsto E_8^{(2)}$ twist satisfies $\alpha_2^3 = 1$). The HW picture of the \mathbb{Z}_6 fixed plane is similar to the model of section 6: The 7D $SU(6)$ gauge fields lock on the 10D $SU(6)$ gauge fields at the left intersection $\mathcal{I}5_1$ while the twisted states

are localized at the right intersection $\mathcal{I}5_2$, thus

$$\mathcal{I}5_1 \begin{cases} G^{\text{local}} = SU(6)^{\text{diag}} \times [SU(3) \times SU(2)]^{10\text{D}}, \\ 7\text{D } H = 35, \\ 7\text{D } V = 0, \\ 6\text{D } H = 0; \end{cases} \quad (7.37)$$

$$\mathcal{I}5_2 \begin{cases} G^{\text{local}} = SU(6)^{7\text{D}} \times SU(9)^{10\text{D}}, \\ 7\text{D } H = 0, \\ 7\text{D } V = 35, \\ 6\text{D } H = (\mathbf{6}, \mathbf{9}) + \frac{1}{2}(\mathbf{20}, \mathbf{1}). \end{cases} \quad (7.38)$$

The brane dual of this HW fixed plane is quite straightforward:

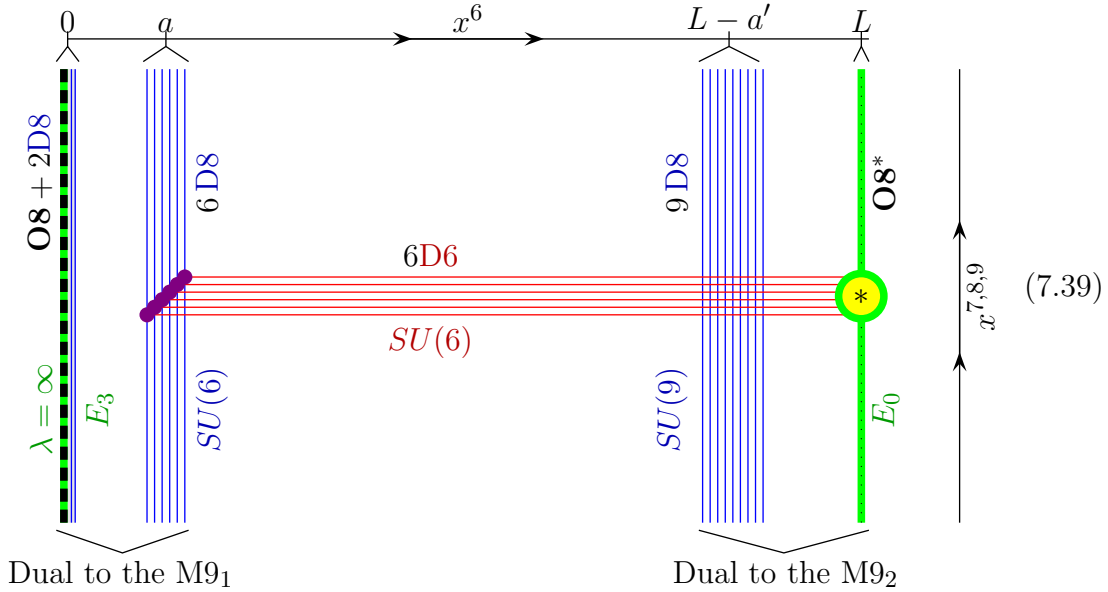

The left side of this diagram is similar to that of fig. (6.12) due to similarity of the respective HW $\mathcal{I}5_1$ intersection planes of the two models. On the right side, for the sake of the $(\mathbf{6}, \mathbf{9})$ bi-fundamentals localized at the $\mathcal{I}5_2$, we have a $\text{D6}/\text{D8}$ brane crossing at $x^6 = (L - a')$. Since the D6 branes do not terminate at this crossing,

they have to continue all the way to the $\mathbf{O8}^*$ plane. Consequently, the HW \leftrightarrow I' duality tells us that the $\mathbf{D6}/\mathbf{O8}^*$ junction must somehow produce: (1) Neumann BC for all the $SU(6)^{7D}$ gauge fields, (2) Dirichlet BC for all $\mathbf{35}$ 7D hypermultiplets, and (3) *local 6D half-hypermultiplets* in the \square representation of the $SU(6)$,

$$\left\{ \begin{array}{l} G^{\text{local}} = SU(6) \times E_0, \\ 7D V = (\mathbf{35}), \\ 7D H = 0, \\ 6D H = \frac{1}{2}(\mathbf{20}). \end{array} \right. \quad (7.40)$$

The boundary conditions for the 7D fields here are similar to eqs. (7.23); they appear to be characteristic of the $\mathbf{D6}/\mathbf{O8}^*$ junctions with any number N of $\mathbf{D6}$ branes. On the other hand, for $N = 6$ we have local 6D hypermultiplets which we did not have for $N = 3$. It would be very interesting to find a string-theoretical reason for this difference, but this is clearly a subject of future research.

8. Summary

The main result of this paper is a dynamical, string-theoretical explanation of the *M*ysteries involved in the dual Hořava–Witten picture of heterotic T^4/\mathbb{Z}_N orbifolds and their twisted sectors. In our previous paper [3] we explained how massless twisted states become charged under both the $G^{(1)} \subset E_8^{(1)}$ living on one end-of-the-world M9 brane of the HW theory and the $G^{(2)} \subset E_8^{(2)}$ living on the other M9 brane at the other end of eleventh dimension. Our resolution of this apparent paradox depends on the 7D $SU(N)$ SYM fields living on the $\mathcal{O6}$ fixed planes (of the \mathbb{Z}_N orbifold action in the 11D bulk of the HW theory)

and on their mixing with the 10D SYM fields living on the M9 branes along the $\mathcal{I}5 = \mathcal{O}6 \cap M9$ intersection planes. We had no mechanism for such mixing; instead, we *assumed* a complicated pattern of boundary conditions for various 7D SYM fields — including the locking boundary conditions (1.2) for the 7D and 10D gauge fields — as needed to explain the twisted spectrum of a heterotic orbifold, and then subjected the resulting HW models to stringent tests of local anomaly cancellation and correctness of the 6D gauge couplings. At the end of this process, we had an answer to the *kinematical* questions of the heterotic \leftrightarrow HW duality for the orbifolds but the dynamical, *M*-theoretical origins of our assumed boundary conditions and local fields remained unexplained *M*ysteries.

In this paper we explain these *M*ysteries in terms of the HW \leftrightarrow I' duality which maps each end-of-the-world M9 brane onto an $\mathbf{O}8^-$ orientifold plane accompanied by 8 **D8** branes (or an $\mathbf{O}8^*$ plane accompanied by 9 **D8** branes) and a \mathbb{Z}_N $\mathcal{O}6$ fixed plane onto a stack of N coincident **D6** branes. The $\mathcal{I}5$ intersection planes therefore become brane junctions — or combinations of several brane junctions — and the boundary conditions and the local fields at such junctions follow from the superstring theory. Consequently, resolving the *M*ysteries of the $\mathcal{I}5$ intersections becomes a matter of brane engineering, *i.e.* arranging appropriate junctions for the type I'/D6 dual models of specific heterotic T^4/\mathbb{Z}_N orbifolds.

There are several distinct types of brane junctions, some of which we encountered in sections 4–7 of this paper, plus a few we left out for future research. Let us briefly review them, starting with the perturbative junctions of sections 4–6:

1. **O8** terminus: An even number N **D6** branes terminate on an **O8** plane accompanied by k coincident **D8** branes (§4.3).

For $N \geq 4$ the 7D gauge symmetry $SU(N)$ is broken down to $Sp(N/2)$; the \square gauge fields have Neumann boundary condition at the junction while the $\tilde{\square}$ fields have Dirichlet BC. The junction plane supports localized massless half-hypermultiplets in the $(\mathbf{N}, \mathbf{2k})$ bi-fundamental representation of the $Sp(N/2)^{7D} \times SO(2k)^{10D}$.

2. **D8** terminus: Several **D6** branes terminate on an equal number of **D8** branes in a one-on-one fashion (§4.4).

This is the junction which causes 7D/10D gauge symmetry mixing via locking boundary conditions (4.9) for the $SU(N)^{7D} \times SU(N)^{10D} \rightarrow SU(N)^{\text{diag}}$ gauge fields. There are no localized 6D massless particles at this junction.

3. Brane crossing: Several **D6** branes cross a stack of **D8** branes without termination (§6).

At this junction, nothing happens to the 7D SYM fields themselves, but there are localized massless 6D hypermultiplets in the bi-fundamental representation of the $SU(N)^{7D} \times SU(k)^{10D}$.

4. Partial termination: In a stack of N **D6** branes, $k < N$ branes terminate on k **D8** branes while the remaining $(N - k)$ **D6** branes cross the **D8** branes without termination and continue to the next junction (§5).

This junction combines 7D gauge symmetry breaking with 7D/10D symmetry mixing: The $SU(N)^{7D}$ breaks to $SU(k) \times U(1) \times SU(N - k)$ and furthermore $(SU(k) \times U(1))^{7D} \times (SU(k) \times U(1))^{10D} \rightarrow (SU(k) \times U(1))^{\text{diag}}$. Altogether, the $SU(N)^{7D} \times (SU(k) \times U(1))^{10D}$ symmetry breaks to $(SU(k) \times U(1))^{\text{diag}} \times SU(N - k)^{7D}$. Despite apparent brane crossing, there are no localized 6D massless particles at this junction.

5. **NS5** half-brane stuck on the **O8** plane (§6):

Any number N (even or odd) of **D6** branes may terminate on such a half-brane without breaking the $SU(N)^{7D}$ gauge symmetry — all the 7D gauge fields have Neumann BC. A characteristic feature of this junction is a \mathbb{H} multiplet of localized 6D massless hypermultiplets.

Physics of these five junctions follows directly from the perturbative superstring theory. In section 7 however, we encountered infinite-coupling terminal junctions which cannot be described perturbatively — and the appropriate non-perturbative string theory is yet to be developed. Instead, we used the heterotic \leftrightarrow HW \leftrightarrow I' duality to predict the overall features of these junctions:

6. E_1 terminus: The string coupling λ diverges along an **O8** plane; four **D6** branes terminate on this plane and somehow pin down an **NS5** half-brane. All the 7D gauge fields have Neumann BC at this junction and the localized 6D massless particles comprise half-hypermultiplets in the $(\mathbf{6}, \mathbf{2})$ representation of the locally visible gauge symmetry $SU(4)^{7D} \times (E_1 = SU(2))^{10D}$.
7. E_0 terminus: N **D6** branes terminate on an **O8*** plane. Again, all the 7D gauge fields have Neumann BC at this junction, but the localized 6D massless spectrum depends on N : Nothing for $N = 3$ while for $N = 6$ there are 20 half-hypermultiplets in the \mathbb{R} representation of the $SU(6)$. Furthermore, this junction appears to require $N \equiv 0 \pmod{3}$, we don't know why.

Finally, there are two more junction types whose physics we have not quite worked out:

8. E_{n+1} termini for $n = 1, 3, \dots, 6$: Here the string coupling λ diverges along an **O8** plane accompanied by k coincident **D8** branes, hence extended E_{n+1} 9D gauge symmetry. The junction is formed by several **D6** branes terminating on such a plane.

Such junctions presumably gives rise to massless twisted states in non-trivial representations of extended gauge groups. Unfortunately, we cannot derive the physics of these junctions from the perturbative superstring theory while the heterotic \leftrightarrow HW \leftrightarrow I' duality analysis along the lines of section 7 is impeded by the lack of suitable models. Specifically, all the heterotic models with E_{n+1} -charged twisted states we tried thus far have difficulties with their HW duals: The local anomalies at the $\mathcal{I}5$ intersection planes don't cancel out and sometimes even the spectrum does not make local sense (*cf. e.g.* §5.2 of ref. [3]).

9. Degenerate **D8** termini in which several **D6** branes terminate on the same **D8** brane.

For example, for any heterotic orbifold with an unbroken $E_8^{(2)}$ gauge symme-

try, all the **D6** branes of the type I' dual model have their right ends on the single outlier **D8** brane at $x^6 = (L - a)$. Physics of such junctions is governed by the perturbative superstring theory, which predicts Dirichlet BC for the 7D gauge fields and no localized 6D massless particles. Unfortunately, applying this prediction to specific models runs into difficulties with the dual HW picture, namely the local anomalies at the $\mathcal{I}5$ planes fail to cancel out. We are presently investigating the reasons for this failure and hope to present a resolution in our next publication.

Another open problem concerns the rules — if any — for pairing up different junctions at the two ends of the **D6** branes in type $I'/D6$ models. Clearly, there are many constraints on such pairings for models based on perturbative heterotic T^4/\mathbb{Z}_N orbifolds, but these constraints have nothing to do with the type $I'/D6$ theory itself. Likewise, requiring a consistent 11D HW picture imposes constraints which are quite unnecessary in purely type I' terms. On the other hand, brane engineering has its own rules such as the S rule of MQCD [32]; perhaps this S rule has analogues applicable in the present type $I'/D6$ context.

Ultimately, the most interesting open problem is to generalize our work (both here and in ref. [3]) from six Minkowski dimension to four, *i.e.* to Calabi–Yau orbifolds T^6/Γ of the heterotic string and their HW duals. The main difficulty here lies in the $\mathcal{O}4$ orbifold fixed planes of the M theory which carry superconformal 5D theories instead of simple 7D SYM of their $\mathcal{O}6$ analogues. Furthermore, unlike the $\mathcal{O}6$ planes which are dual to stacks of **D6** branes, the $\mathcal{O}4$ planes do not have simple brane duals. The hope remains however that a different duality would prove to be equally productive; future research will tell.

Acknowledgements: The authors are grateful to A. Hanany and O. Aharony for many helpful discussions. VK thanks the School of Physics and Astronomy of Tel Aviv University and the Theory Division of CERN for hospitality while much of the work presented here was done. ST thanks A. Font for useful discussions and the Physics Department of Universidad Central de Venezuela for hospitality during

the writing-up stage.

APPENDIX

Verifying New Models

This Appendix focuses on the HW picture of heterotic orbifolds that were not discussed in [3] but made their first appearance in this paper. For the two models discussed in section 5, we have explicitly verified all the kinematic constraints of the HW picture, namely the correct 6D massless spectrum, correct gauge couplings and local anomaly cancellation at each $\mathcal{I}5$ intersection plane. But in sections 6 and 7 we focused on the spectrum and the type I'/D6 brane engineering; in this Appendix, we complete the discussion and verify the gauge couplings and the local anomaly cancelation. Or rather we outline such verification — to save the gentle reader from utter tedium of evaluating and factorizing various anomaly polynomials (2.2) and (2.12), we merely present the results of such calculations.

We begin with the T^4/\mathbb{Z}_6 model of section 6. The net observed 6D gauge symmetry of this model has five factors of diverse HW origins,

$$\begin{aligned}
G^{\text{net}} &= SU(6) \times SU(3) \times SU(2) \times SU(8) \times U(1), \\
SU(6) &= \text{diag} \left[\left(SU(6) \subset E_8^{(1)} \right) \times \left(SU(6) \right)_{\mathbb{Z}_6 \text{ fixed plane}} \right], \\
SU(3) &= \left(SU(3) \subset E_8^{(1)} \right), \\
SU(2) &= \text{diag} \left[\left(SU(2) \subset E_8^{(1)} \right) \times \prod_{\mathbb{Z}_2 \text{ fixed planes}} \left(SU(2) \right) \right], \\
SU(8) &= \left(SU(8) \subset E_8^{(2)} \right), \\
U(1) &= \text{diag} \left[\left(U(1) \subset E_8^{(2)} \right) \times \prod_{\mathbb{Z}_3 \text{ fixed planes}} \left(U(1) \subset SU(3) \right) \right].
\end{aligned} \tag{A.1}$$

In terms of the observed gauge couplings, this list implies

$$\begin{aligned}
\frac{1}{g^2[SU(6)]} &= \frac{1}{g^2[E_8^{(1)}]} + \frac{1}{g^2[SU(6)_{Z_6}]}, \\
\frac{1}{g^2[SU(3)]} &= \frac{1}{g^2[E_8^{(1)}]} + 0, \\
\frac{1}{g^2[SU(2)]} &= \frac{1}{g^2[E_8^{(1)}]} + \frac{5}{g^2[SU(2)_{Z_2}]}, \\
\frac{1}{g^2[SU(8)]} &= \frac{1}{g^2[E_8^{(2)}]} + 0, \\
\frac{1}{g^2[U(1)]} &= \frac{1}{g^2[E_8^{(2)}]} + \frac{4 \times (16/3)^*}{g^2[SU(3)_{Z_3}]},
\end{aligned} \tag{A.2}$$

or in terms of the v, \tilde{v} coefficients in eq. (2.5),

$$\begin{aligned}
v[SU(6)] &= 1, & \tilde{v}[SU(6)] &= \frac{1}{2}k_1 + 1, \\
v[SU(3)] &= 1, & \tilde{v}[SU(3)] &= \frac{1}{2}k_1, \\
v[SU(2)] &= 1, & \tilde{v}[SU(2)] &= \frac{1}{2}k_1 + 5, \\
v[SU(8)] &= 1, & \tilde{v}[SU(8)] &= \frac{1}{2}k_2, \\
v[U(1)] &= 4, & \tilde{v}[U(1)] &= 2k_2 + 4 \times \frac{16}{3}.
\end{aligned} \tag{A.3}$$

By comparison, using the heterotic orbifold's spectrum to evaluate and factorize the net 6D anomaly polynomial (2.2) yields (after some boring algebra)

$$\begin{aligned}
v[SU(6)] &= 1, & \tilde{v}[SU(6)] &= \frac{3}{2}, \\
v[SU(3)] &= 1, & \tilde{v}[SU(3)] &= \frac{1}{2}, \\
v[SU(2)] &= 1, & \tilde{v}[SU(2)] &= \frac{11}{2}, \\
v[SU(8)] &= 1, & \tilde{v}[SU(8)] &= -\frac{1}{2}, \\
v[U(1)] &= 4, & \tilde{v}[U(1)] &= \frac{58}{3},
\end{aligned} \tag{A.4}$$

in perfect consistency with the HW results (A.3) (assuming $k_1 = +1, k_2 = -1$ *i.e.*,

* The factor $(16/3)$ comes from the normalization of the $U(1) \subset SU(3)$ generator at the Z_3 fixed planes. This normalization — namely $Y = \text{diag}(-\frac{2}{3}, -\frac{2}{3}, +\frac{4}{3})$ can be inferred from the abelian charges of the $SU(3)^{10D}$ triplets in eq. (6.9). Consequently, $\text{tr}(Y^2) = 2 \text{Tr}_3(Y^2) = (16/3)$.

13 instantons in the $E_8^{(1)}$ and 11 in the $E_8^{(2)}$).

Our next test concerns the local 6D anomaly at the $\mathcal{I}5_1$ intersection plane. In light of eqs. (6.10) we have local gauge symmetry

$$G^{\text{local}} = SU(6) \times SU(3) \times SU(2)$$

and the anomaly-weighted chiral matter comprises

$$\begin{aligned} Q_6 &= 0, \\ Q_7 &= +\frac{1}{2}(\mathbf{35}, \mathbf{1}, \mathbf{1}), \\ Q_{10} &= \frac{19}{144}(\mathbf{20}, \mathbf{1}, \mathbf{2}) + \frac{13}{72}(\mathbf{15}, \bar{\mathbf{3}}, \mathbf{1}) - \frac{5}{72}(\mathbf{6}, \mathbf{3}, \mathbf{2}) \\ &\quad - \frac{35}{144} \left[(\mathbf{35}, \mathbf{1}, \mathbf{1}) + (\mathbf{1}, \mathbf{8}, \mathbf{1}) + (\mathbf{1}, \mathbf{1}, \mathbf{3}) \right]; \end{aligned} \tag{A.5}$$

the last line here follows from the $\alpha_1 : \mathbb{Z}_6 \mapsto E_8^{(1)}$ twist, *cf.* eq. (6.3). The magnetic charge of the $\mathcal{I}5_1$ plane is

$$g_1[\mathbb{Z}_6] = k_1 - 4g_1[\mathbb{Z}_3] - 5g_1[\mathbb{Z}_2] = -\frac{5}{12} \tag{A.6}$$

and it is easy to see that eq. (2.11) holds true,

$$\dim(Q = Q_6 + Q_7 + Q_{10}) = \frac{155}{9} = \frac{535}{18} + 30g. \tag{A.7}$$

As usual, eq. (2.12) takes more work to verify, but it holds true as well,

$$\begin{aligned} \mathcal{A}' &\equiv \frac{2}{3} \text{Tr}_Q(\mathcal{F}^4) - \frac{1}{6} \text{tr}(R^2) \times \text{Tr}_Q(\mathcal{F}^2) + \left(\frac{1}{8}g + \frac{1}{2}T(1) = \frac{5}{72}\right) (\text{tr}(R^2))^2 \\ &= -\frac{5}{24} \left(\text{tr}(F_{SU(6)}^2) + \text{tr}(F_{SU(3)}^2) + \text{tr}(F_{SU(3)}^2) - \frac{1}{2} \text{tr}(R^2) \right)^2 \\ &\quad + \left(\text{tr}(F_{SU(6)}^2) + \text{tr}(F_{SU(3)}^2) + \text{tr}(F_{SU(3)}^2) - \frac{1}{2} \text{tr}(R^2) \right) \\ &\quad \times \left(\text{tr}(F_{SU(6)}^2) - \frac{35}{144} \text{tr}(R^2) \right). \end{aligned} \tag{A.8}$$

Finally, the $\mathcal{I}5_2$ intersection plane has magnetic charge $g_2 = -g_1 = +\frac{5}{12}$, local

symmetry

$$G^{\text{local}} = SU(6) \times SU(8) \times U(1)$$

and the anomaly-weighted chiral matter comprising

$$\begin{aligned} Q_6 &= (\mathbf{6}, \mathbf{8}, -\frac{1}{6}) + (\mathbf{15}, \mathbf{1}, +\frac{2}{3}), \\ Q_7 &= -\frac{1}{2}(\mathbf{35}, \mathbf{1}, 1), \\ Q_{10} &= \frac{19}{144}(\mathbf{1}, \mathbf{70}, 0) + \frac{13}{72}(\mathbf{1}, \mathbf{28}, -1) - \frac{5}{72}[(\mathbf{1}, \mathbf{28}, +1) + (\mathbf{1}, \mathbf{1}, -2)] \\ &\quad - \frac{35}{144}[(\mathbf{1}, \mathbf{63}, 0) + (\mathbf{1}, \mathbf{1}, 0)]. \end{aligned} \quad (\text{A.9})$$

(The first two lines here follow from eqs. (6.11) while the Q_{10} follows from eq. (6.4).)

Again, we find that eqs. (2.11) and (2.12) hold true,

$$\dim(Q = Q_6 + Q_7 + Q_{10}) = \frac{380}{9} = \frac{535}{18} + 30g, \quad (\text{A.10})$$

and

$$\begin{aligned} \mathcal{A}' &\equiv \frac{2}{3} \text{Tr}_Q(\mathcal{F}^4) - \frac{1}{6} \text{tr}(R^2) \times \text{Tr}_Q(\mathcal{F}^2) + (\frac{1}{8}g + \frac{1}{2}T(1) = \frac{25}{144})(\text{tr}(R^2))^2 \\ &= +\frac{5}{24} \left(\text{tr}(F_{SU(8)}^2) + F_{U(1)}^2 - \frac{1}{2} \text{tr}(R^2) \right)^2 \\ &\quad + \left(\text{tr}(F_{SU(8)}^2) + F_{U(1)}^2 - \frac{1}{2} \text{tr}(R^2) \right) \times \left(\text{tr}(F_{SU(6)}^2) - \frac{35}{144} \text{tr}(R^2) \right). \end{aligned} \quad (\text{A.11})$$

Next, consider the monster T^4/\mathbb{Z}_6 model of §7.2. The 6D gauge symmetry of this monster has seven factors whose HW provenance includes various mixtures of the two M9 end-of-the-world branes and the ten $\mathcal{O}6$ planes. To wit,

$$G^{\text{net}} = SO(12) \times SU(2)_A \times U(1)_1 \times SU(6) \times SU(2)_B \times SU(2)_C \times U(1)_2, \quad (\text{A.12})$$

where

$$SO(12) = \left(SO(12) \subset E_8^{(1)} \right), \quad (\text{A.13})$$

$$SU(2)_A = \text{diag} \left[\begin{aligned} & \left(SU(2) \subset E_8^{(1)} \right) \times \left(SU(2)_1 \subset SU(6) \right)_{\mathbb{Z}_6 \text{ fixed plane}} \\ & \times \prod_{\mathbb{Z}_2 \text{ fixed planes}} \left(SU(2) \right) \end{aligned} \right], \quad (\text{A.14})$$

$$U(1)_1 = \text{diag} \left[\begin{aligned} & \left(U(1) \subset E_8^{(1)} \right) \times \left(U(1)_1 \subset SU(6) \right)_{\mathbb{Z}_6 \text{ fixed plane}} \\ & \times \prod_{\mathbb{Z}_3 \text{ fixed planes}} \left(U(1) \subset SU(3) \right) \end{aligned} \right], \quad (\text{A.15})$$

$$SU(6) = \left(SU(6) \subset E_8^{(2)} \right), \quad (\text{A.16})$$

$$SU(2)_B = \text{diag} \left[\left(SU(2)_B \subset E_8^{(2)} \right) \times \left(SU(2)_2 \times SU(2)_3 \subset SU(6) \right)_{\mathbb{Z}_6 \text{ fixed plane}} \right], \quad (\text{A.17})$$

$$SU(2)_C = \left(SU(2)_C \subset E_8^{(2)} \right), \quad (\text{A.18})$$

$$U(1)_2 = \text{diag} \left[\left(U(1) \subset E_8^{(2)} \right) \times \left(U(1)_2 \subset SU(6) \right)_{\mathbb{Z}_6 \text{ fixed plane}} \right]. \quad (\text{A.19})$$

Consequently, the five nonabelian factors have gauge couplings

$$\begin{aligned} \frac{1}{g^2[SU(12)]} &= \frac{1}{g^2[E_8^{(1)}]}, \\ \frac{1}{g^2[SU(2)_A]} &= \frac{1}{g^2[E_8^{(1)}]} + \frac{1}{g^2[SU(6)_{\mathbb{Z}_6}]} + \frac{5}{g^2[SU(2)_{\mathbb{Z}_2}]}, \\ \frac{1}{g^2[SU(6)]} &= \frac{1}{g^2[E_8^{(2)}]}, \\ \frac{1}{g^2[SU(2)_B]} &= \frac{1}{g^2[E_8^{(2)}]} + \frac{2}{g^2[SU(6)_{\mathbb{Z}_6}]}, \\ \frac{1}{g^2[SU(2)_C]} &= \frac{1}{g^2[E_8^{(2)}]}, \end{aligned} \quad (\text{A.20})$$

while the two abelian factors have

$$\begin{aligned}
\frac{1}{g^2[U(1) \times U(1)]} &= \begin{pmatrix} \frac{4}{g^2[E_8^{(1)}]} & 0 \\ 0 & \frac{12}{g^2[E_8^{(2)}]} \end{pmatrix} + \frac{4}{g^2[SU(3)_{\mathbb{Z}_3}]} \begin{pmatrix} \frac{16}{3} & 0 \\ 0 & 0 \end{pmatrix} \\
&+ \frac{1}{g^2[SU(6)_{\mathbb{Z}_6}]} \begin{pmatrix} \frac{32}{9} & -\frac{8}{3} \\ -\frac{8}{3} & 8 \end{pmatrix}.
\end{aligned} \tag{A.21}$$

The last matrix here follows from the normalization of the two $U(1) \times U(1) \subset SU(6)$ generators $C_1 = \frac{4}{3}X_2$ and $C_2 = 2X_1$ (*cf.* eqs. (7.17)):

$$\begin{aligned}
\text{tr}(C_1^2) &\equiv 2 \text{Tr}_{\mathbf{6}}(C_1^2) = \frac{32}{9}, \\
\text{tr}(C_2^2) &\equiv 2 \text{Tr}_{\mathbf{6}}(C_2^2) = 8, \\
\text{tr}(C_1 C_2) &\equiv 2 \text{Tr}_{\mathbf{6}}(C_1 C_2) = -\frac{8}{3}.
\end{aligned} \tag{A.22}$$

Translating the gauge couplings (A.20) and (A.21) into the v, \tilde{v} coefficients of eq. (2.5), we find

$$\begin{aligned}
v[SO(12)] &= 1, & \tilde{v}[SO(12)] &= \frac{1}{2}k_1, \\
v[SU(2)_A] &= 1, & \tilde{v}[SU(2)_A] &= \frac{1}{2}k_1 + 6, \\
v[SU(6)] &= 1, & \tilde{v}[SU(6)] &= \frac{1}{2}k_2, \\
v[SU(2)_B] &= 1, & \tilde{v}[SU(2)_B] &= \frac{1}{2}k_2 + 2, \\
v[SU(2)_C] &= 1, & \tilde{v}[SU(2)_C] &= \frac{1}{2}k_2, \\
v[U(1) \times U(1)] &= \begin{pmatrix} 4 & 0 \\ 0 & 12 \end{pmatrix}, & \tilde{v}[U(1) \times U(1)] &= \begin{pmatrix} 2k_1 + \frac{224}{9} & -\frac{8}{3} \\ -\frac{8}{3} & 6k_2 + 8 \end{pmatrix}.
\end{aligned} \tag{A.23}$$

By comparison, using the heterotic orbifold's spectrum to evaluate and factorize the net 6D anomaly polynomial (2.2) yields (after some boring algebra)

$$\begin{aligned}
v[SO(12)] &= 1, & \tilde{v}[SO(12)] &= -2, \\
v[SU(2)_A] &= 1, & \tilde{v}[SU(2)_A] &= +4, \\
v[SU(6)] &= 1, & \tilde{v}[SU(6)] &= +2, \\
v[SU(2)_B] &= 1, & \tilde{v}[SU(2)_B] &= +4, \\
v[SU(2)_C] &= 1, & \tilde{v}[SU(2)_C] &= +2, \\
v[U(1) \times U(1)] &= \begin{pmatrix} 4 & 0 \\ 0 & 12 \end{pmatrix}, & \tilde{v}[U(1) \times U(1)] &= \begin{pmatrix} \frac{152}{9} & -\frac{8}{3} \\ -\frac{8}{3} & 32 \end{pmatrix}.
\end{aligned} \tag{A.24}$$

in perfect consistency with the HW results (A.23) (assuming $k_1 = -4$, $k_2 = +4$ *i.e.*, 8 instantons in the $E_8^{(1)}$ and 16 in the $E_8^{(2)}$).

Next, consider the local anomalies at the $\mathcal{I}5$ intersections of the HW picture. According to eqs. (7.11) the local gauge symmetry at the $\mathcal{I}5_1$ intersection plane is

$$G^{\text{local}} = [SO(12)]^{10\text{D}} \times [SU(2)_A \times U(1)]^{\text{diag}} \times Sp(2)^{7\text{D}}$$

and the anomaly-weighted chiral matter comprises

$$\begin{aligned}
Q_6 &= \frac{1}{2}(\mathbf{12}, \mathbf{1}, \mathbf{0}, \mathbf{4}), \\
Q_7 &= \frac{1}{2}(\mathbf{1}, \mathbf{3}, \mathbf{0}, \mathbf{1}) + \frac{1}{2}(\mathbf{1}, \mathbf{1}, \mathbf{0}, \mathbf{1}) + (\mathbf{1}, \mathbf{2}, \mathbf{1}, \mathbf{4}) \\
&\quad + \frac{1}{2}(\mathbf{1}, \mathbf{1}, \mathbf{0}, \mathbf{5}) - \frac{1}{2}(\mathbf{1}, \mathbf{1}, \mathbf{0}, \mathbf{10}), \\
Q_{10} &= \frac{19}{144}(\mathbf{32}', \mathbf{2}, \mathbf{0}, \mathbf{1}) + \frac{13}{72}[(\mathbf{32}, \mathbf{1}, \mathbf{1}, \mathbf{1}) + (\mathbf{1}, \mathbf{1}, \mathbf{2}, \mathbf{1})] - \frac{5}{72}(\mathbf{12}, \mathbf{2}, \mathbf{1}, \mathbf{1}) \\
&\quad - \frac{35}{144}[(\mathbf{66}, \mathbf{1}, \mathbf{0}, \mathbf{1}) + (\mathbf{1}, \mathbf{3}, \mathbf{0}, \mathbf{1}) + (\mathbf{1}, \mathbf{1}, \mathbf{0}, \mathbf{1})].
\end{aligned} \tag{A.25}$$

(The last equation here follows from the first eq. (7.6).) The magnetic charge of the $\mathcal{I}5_1$ plane is

$$g_1[\mathbb{Z}_6] = k_1 - 4g_1[\mathbb{Z}_3] - 5g_1[\mathbb{Z}_2] = -\frac{1}{12}, \tag{A.26}$$

and it easy to check that eq. (2.11) holds true,

$$\dim(Q = Q_6 + Q_7 + Q_{10}) = \frac{245}{9} = \frac{535}{18} + 30g, \tag{A.27}$$

hence no net $\text{tr}(R^4)$ anomaly. Verifying cancelation of all other anomalies takes

more work, but at the end eq. (2.12) holds true as well,

$$\begin{aligned}
\mathcal{A}' &\equiv \frac{2}{3} \text{Tr}_Q(\mathcal{F}^4) - \frac{1}{6} \text{tr}(R^2) \times \text{Tr}_Q(\mathcal{F}^2) + \left(\frac{1}{8}g + \frac{1}{2}T(1) = \frac{1}{9}\right) (\text{tr}(R^2))^2 \\
&= -\frac{1}{24} \left(\text{tr}(F_{SO(12)}^2) + \text{tr}(F_{SU(2)_A}^2) + 4F_{U(1)}^2 - \frac{1}{2} \text{tr}(R^2) \right)^2 \\
&\quad + \left(\text{tr}(F_{SO(12)}^2) + \text{tr}(F_{SU(2)_A}^2) + 4F_{U(1)}^2 - \frac{1}{2} \text{tr}(R^2) \right) \\
&\quad \times \left(\text{tr}(F_{SU(2)_A}^2) + \frac{8}{3}F_{U(1)}^2 + \text{tr}(F_{Sp(2)}^2) - \frac{35}{144} \text{tr}(R^2) \right).
\end{aligned} \tag{A.28}$$

At the other intersection plane $\mathcal{I}5_2$ we have (*cf.* eq. (7.12)) local symmetry

$$G^{\text{local}} = SU(4)^{7D} \times [SU(2)_C \times U(1)_2]^{\text{diag}} \times [SU(6) \times SU(2)_C]^{10D},$$

the anomaly-weighted chiral matter

$$\begin{aligned}
Q_6 &= (\mathbf{4}, \mathbf{1}, \gamma, \mathbf{6}, \mathbf{1}) + \frac{1}{2}(\mathbf{6}, \mathbf{1}, \mathbf{0}, \mathbf{1}, \mathbf{2}), \\
Q_7 &= \frac{1}{2}(\mathbf{1}, \mathbf{3}, \mathbf{0}, \mathbf{1}, \mathbf{1}) + \frac{1}{2}(\mathbf{1}, \mathbf{1}, \mathbf{0}, \mathbf{1}, \mathbf{1}) + (\mathbf{4}, \mathbf{2}, \beta, \mathbf{1}, \mathbf{1}) - \frac{1}{2}(\mathbf{15}, \mathbf{1}, \mathbf{0}, \mathbf{1}, \mathbf{1}), \\
Q_{10} &= \frac{19}{144}(\mathbf{1}, \mathbf{2}, \mathbf{0}, \mathbf{20}, \mathbf{1}) + \frac{19}{72}(\mathbf{1}, \mathbf{1}, +\mathbf{3}, \mathbf{1}, \mathbf{2}) \\
&\quad + \frac{13}{72}[(\mathbf{1}, \mathbf{1}, +\mathbf{2}, \mathbf{15}, \mathbf{1}) + (\mathbf{1}, \mathbf{2}, +\mathbf{1}, \mathbf{6}, \mathbf{2})] \\
&\quad - \frac{5}{72}[(\mathbf{1}, \mathbf{1}, -\mathbf{1}, \mathbf{15}, \mathbf{2}) + (\mathbf{1}, \mathbf{2}, -\mathbf{2}, \mathbf{6}, \mathbf{1})] \\
&\quad - \frac{35}{144}[(\mathbf{1}, \mathbf{3}, \mathbf{0}, \mathbf{1}, \mathbf{1}) + (\mathbf{1}, \mathbf{1}, \mathbf{0}, \mathbf{1}, \mathbf{1}) + (\mathbf{1}, \mathbf{1}, \mathbf{0}, \mathbf{35}, \mathbf{1}) + (\mathbf{1}, \mathbf{1}, \mathbf{0}, \mathbf{1}, \mathbf{3})]
\end{aligned} \tag{A.29}$$

(the last line here follows from the second eq. (7.6)), and the magnetic charge of the plane is $g_2 = -g_1 = +\frac{1}{12}$. Hence, we can easily see the cancelation of the gravitational $\text{tr}(R^4)$ anomaly according to eq. (2.11),

$$\dim(Q = Q_6 + Q_7 + Q_{10}) = \frac{290}{9} = \frac{535}{18} + 30g. \tag{A.30}$$

Next, consider the gauge anomalies involving one power of the abelian field $F_{U(1)}$

and three power of the nonabelian fields $F_{SU(4)}$ and $F_{SU(6)}$. For the anomaly-weighted spectrum (A.29), we have

$$\begin{aligned}\mathrm{Tr}_Q \left(F_{U(1)} F_{SU(4)}^3 \right) &= F_{U(1)} \mathrm{tr}(F_{SU(4)}^3) \times (6\gamma + 2\beta), \\ \mathrm{Tr}_Q \left(F_{U(1)} F_{SU(6)}^3 \right) &= F_{U(1)} \mathrm{tr}(F_{SU(6)}^3) \times (4\gamma + 2),\end{aligned}\tag{A.31}$$

hence to assure cancelation of these dangerous anomalies we must have $\beta = +\frac{3}{2}$, $\gamma = -\frac{1}{2}$. As explained in §7.2, these coefficients determine respectively the normalization of the $U(1)^{7D} \times U(1)^{10D} \rightarrow U(1)^{\mathrm{diag}}$ charge mixing at the $\mathcal{I}5_2$ and the overall charge of the twisted states which live there.

Given $\beta = +\frac{3}{2}$, $\gamma = -\frac{1}{2}$, verifying cancelation of all the remaining local anomalies at the $\mathcal{I}5_2$ is the usual tedious exercise of evaluating and factorizing anomaly polynomials. At the end of this exercise, eq. (2.12) indeed holds true,

$$\begin{aligned}\mathcal{A}' &\equiv \frac{2}{3} \mathrm{Tr}_Q(\mathcal{F}^4) - \frac{1}{6} \mathrm{tr}(R^2) \times \mathrm{Tr}_Q(\mathcal{F}^2) + \left(\frac{1}{8}g + \frac{1}{2}T(1) = \frac{19}{144}\right) (\mathrm{tr}(R^2))^2 \\ &= +\frac{1}{24} \left(\mathrm{tr}(F_{SU(6)}^2) + \mathrm{tr}(F_{SU(2)_B}^2) + \mathrm{tr}(F_{SU(2)_C}^2) + 12 F_{U(1)}^2 - \frac{1}{2} \mathrm{tr}(R^2) \right)^2 \\ &\quad + \left(\mathrm{tr}(F_{SU(6)}^2) + \mathrm{tr}(F_{SU(2)_B}^2) + \mathrm{tr}(F_{SU(2)_C}^2) + 12 F_{U(1)}^2 - \frac{1}{2} \mathrm{tr}(R^2) \right) \\ &\quad \times \left(\mathrm{tr}(F_{SU(2)_B}^2) + 6F_{U(1)}^2 + \mathrm{tr}(F_{SU(4)}^2) - \frac{35}{144} \mathrm{tr}(R^2) \right).\end{aligned}\tag{A.32}$$

Finally, consider the T^4/\mathbb{Z}_4 model of §7.4. This time, we have three nonabelian and two abelian gauge group factors

$$G^{\mathrm{net}} = SO(12) \times SU(2) \times U(1)_1 \times SU(8) \times U(1)_2\tag{A.33}$$

of the following HW provenance:

$$SO(12) = \left(SO(12) \subset E_8^{(1)} \right),\tag{A.34}$$

$$SU(2) = \mathrm{diag} \left[\left(SU(2) \subset E_8^{(1)} \right) \times \prod_{\substack{\mathbb{Z}_4 \text{ fixed} \\ \text{planes}}} \left(SU(2) \subset SU(4) \right) \right],\tag{A.35}$$

$$U(1)_1 = \text{diag} \left[\left(U(1) \subset E_8^{(1)} \right) \times \prod_{\substack{\mathbb{Z}_4 \text{ fixed} \\ \text{planes}}} \left(U(1)_1 \subset SU(4) \right) \times \prod_{\substack{\mathbb{Z}_2 \text{ fixed} \\ \text{planes}}} \left(U(1) \subset SU(2) \right) \right], \quad (\text{A.36})$$

$$SU(8) = \left(SU(8) \subset E_8^{(2)} \right), \quad (\text{A.37})$$

$$U(1)_2 = \text{diag} \left[\left(U(1) \subset E_8^{(2)} \right) \times \prod_{\substack{\mathbb{Z}_4 \text{ fixed} \\ \text{planes}}} \left(U(1)_2 \subset SU(4) \right) \right]. \quad (\text{A.38})$$

Accordingly, the nonabelian gauge couplings of the model are

$$\begin{aligned} \frac{1}{g^2[SO(12)]} &= \frac{1}{g^2[E_8^{(1)}]}, \\ \frac{1}{g^2[SU(2)]} &= \frac{1}{g^2[E_8^{(1)}]} + \frac{4}{g^2[SU(4)_{\mathbb{Z}_4}]}, \\ \frac{1}{g^2[SU(8)]} &= \frac{1}{g^2[E_8^{(2)}]}, \end{aligned} \quad (\text{A.39})$$

while the abelian couplings are

$$\begin{aligned} \frac{1}{g^2[U(1) \times U(1)]} &= \begin{pmatrix} \frac{4}{g^2[E_8^{(1)}]} & 0 \\ 0 & \frac{4}{g^2[E_8^{(2)}]} \end{pmatrix} + \frac{6}{g^2[SU(2)_{\mathbb{Z}_2}]} \begin{pmatrix} 4 & 0 \\ 0 & 0 \end{pmatrix} \\ &+ \frac{4}{g^2[SU(4)_{\mathbb{Z}_4}]} \begin{pmatrix} 3 & -2 \\ -2 & 4 \end{pmatrix}. \end{aligned} \quad (\text{A.40})$$

The last matrix here follows from the normalization of the two $U(1) \times U(1) \subset SU(4)$ generators $C_1 = \frac{3}{2}Y$ and $C_2 = 2T$ (*cf.* eqs. (7.35)):

$$\begin{aligned} \text{tr}(C_1^2) &\equiv 2 \text{Tr}_4(C_1^2) = 3, \\ \text{tr}(C_2^2) &\equiv 2 \text{Tr}_4(C_2^2) = 4, \\ \text{tr}(C_1 C_2) &\equiv 2 \text{Tr}_4(C_1 C_2) = -2. \end{aligned} \quad (\text{A.41})$$

Translating these couplings into the v, \tilde{v} coefficients of eq. (2.5), we find

$$\begin{aligned}
v[SO(12)] &= 1, & \tilde{v}[SO(12)] &= \frac{1}{2}k_1, \\
v[SU(2)] &= 1, & \tilde{v}[SU(2)] &= \frac{1}{2}k_1 + 4, \\
v[SU(8)] &= 1, & \tilde{v}[SU(8)] &= \frac{1}{2}k_2, \\
v[U(1) \times U(1)] &= \begin{pmatrix} 4 & 0 \\ 0 & 4 \end{pmatrix}, & \tilde{v}[U(1) \times U(1)] &= \begin{pmatrix} 2k_1 + 36 & -8 \\ -8 & 2k_2 + 16 \end{pmatrix}.
\end{aligned} \tag{A.42}$$

By comparison, using the heterotic orbifold's spectrum to evaluate and factorize the net 6D anomaly polynomial (2.2) yields (after some boring algebra)

$$\begin{aligned}
v[SO(12)] &= 1, & \tilde{v}[SO(12)] &= -1, \\
v[SU(2)] &= 1, & \tilde{v}[SU(2)] &= +3, \\
v[SU(8)] &= 1, & \tilde{v}[SU(8)] &= +1, \\
v[U(1) \times U(1)] &= \begin{pmatrix} 4 & 0 \\ 0 & 12 \end{pmatrix}, & \tilde{v}[U(1) \times U(1)] &= \begin{pmatrix} 32 & -8 \\ -8 & 20 \end{pmatrix}.
\end{aligned} \tag{A.43}$$

in perfect consistency with the HW results (A.42) (assuming $k_1 = -2$, $k_2 = +2$ *i.e.*, 10 instantons in the $E_8^{(1)}$ and 14 in the $E_8^{(2)}$).

The local anomaly at the $\mathcal{I}5_1$ intersection in the HW picture of this model cancels out exactly as in the model of §5.2 (which has a similar $\mathcal{I}5_1$ plane). At the $\mathcal{I}5_2$ intersection plane, we have local symmetry

$$G^{\text{local}} = SU(8) \times U(1) \times SU(3)$$

and the anomaly-weighted chiral matter comprises

$$\begin{aligned}
Q_6 &= (\mathbf{8}, \gamma, \mathbf{3}), \\
Q_7 &= \frac{1}{2}(\mathbf{1}, \mathbf{0}, \mathbf{1}) + (\mathbf{1}, \beta, \mathbf{3}) - \frac{1}{2}(\mathbf{1}, \mathbf{0}, \mathbf{8}), \\
Q_{10} &= \frac{3}{16}(\mathbf{28}, +1, \mathbf{1}) + \frac{1}{16}[(\mathbf{56}, -\frac{1}{2}, \mathbf{1}) + (\mathbf{8}, -\frac{3}{2}, \mathbf{1})] \\
&\quad - \frac{5}{32}[(\mathbf{63}, \mathbf{0}, \mathbf{1}) + (\mathbf{1}, \mathbf{0}, \mathbf{1})],
\end{aligned} \tag{A.44}$$

cf. eqs. (7.31) and (7.24). The magnetic charge of the $\mathcal{I}5_2$ plane is $g_2 = -g_1 = +\frac{1}{8}$

and we can easily see that eq. (2.11) holds true

$$\dim(Q = Q_6 + Q_7 + Q_{10}) = \frac{91}{4} = 19 + 30g \quad (\text{A.45})$$

and hence the irreducible gravitational anomaly $\text{tr}(R^4)$ cancels out.

Next, consider the gauge anomalies involving one power of the abelian field $F_{U(1)}$ and three power of the nonabelian fields $F_{SU(3)}$ and $F_{SU(8)}$. Given the anomaly-weighted spectrum (A.44), we have

$$\begin{aligned} \text{Tr}_Q \left(F_{U(1)} F_{SU(3)}^3 \right) &= F_{U(1)} \text{tr}(F_{SU(3)}^3) \times (8\gamma + \beta), \\ \text{Tr}_Q \left(F_{U(1)} F_{SU(8)}^3 \right) &= F_{U(1)} \text{tr}(F_{SU(8)}^3) \times (3\gamma + \frac{1}{2}), \end{aligned} \quad (\text{A.46})$$

hence to assure cancelation of these dangerous anomalies we must have $\beta = +\frac{2}{3}$, $\gamma = -\frac{1}{6}$. As explained in §7.4, these coefficients determine respectively the normalization of the $U(1)^{7D} \times U(1)^{10D} \rightarrow U(1)^{\text{diag}}$ charge mixing at the $\mathcal{I}5_2$ and the overall charge of the twisted states which live there.

Given $\beta = +\frac{2}{3}$, $\gamma = -\frac{1}{6}$, the remaining local anomalies at the $\mathcal{I}5_2$ duly cancel out according to eq. (2.12),

$$\begin{aligned} \mathcal{A}' &\equiv \frac{2}{3} \text{Tr}_Q(\mathcal{F}^4) - \frac{1}{6} \text{tr}(R^2) \times \text{Tr}_Q(\mathcal{F}^2) + \left(\frac{1}{8}g + \frac{1}{2}T(1) = \frac{3}{32} \right) (\text{tr}(R^2))^2 \\ &= +\frac{1}{16} \left(\text{tr}(F_{SU(8)}^2) + 4F_{U(1)}^2 - \frac{1}{2} \text{tr}(R^2) \right)^2 \\ &\quad + \left(\text{tr}(F_{SU(8)}^2) + 4F_{U(1)}^2 - \frac{1}{2} \text{tr}(R^2) \right) \\ &\quad \times \left(\text{tr}(F_{SU(3)}^2) + \frac{8}{3}F_{U(1)}^2 - \frac{5}{32} \text{tr}(R^2) \right). \end{aligned} \quad (\text{A.47})$$

*** Q. E. D. ***

REFERENCES

1. P. Hořava and E. Witten, “Heterotic and type I string dynamics from eleven dimensions”, Nucl. Phys. B **460** (1996) 506 [hep-th/9510209].
2. P. Hořava and E. Witten, “Heterotic and type I string dynamics from eleven dimensions”, Nucl. Phys. B **506** (1996) 506 [hep-th/9510209].
3. V. S. Kaplunovsky, J. Sonnenschein, S. Theisen and S. Yankielowicz, “On the Duality between Perturbative Heterotic Orbifolds and M-Theory on T^4/Z_N ”, Nucl. Phys. B **590** (2000) 123 [hep-th/9912144].
4. M. Faux, D. Lüst and B. A. Ovrut, “Intersecting orbifold planes and local anomaly cancellation in M-theory”, Nucl. Phys. B **554** (1999) 437 [hep-th/9903028].
5. M. Faux, D. Lüst and B. A. Ovrut, “Local anomaly cancellation, M-theory orbifolds and phase-transitions”, Nucl. Phys. B **589** (2000) 269 [hep-th/0005251]; “An M-theory perspective on heterotic K3 orbifold compactifications”, hep-th/0010087; “Twisted sectors and Chern-Simons terms in M-theory orbifolds”, hep-th/0011031.
6. K. Dasgupta and S. Mukhi, “Orbifolds of M -theory”, Nucl. Phys. B **465** (1996) 399 [hep-th/9512196].
7. E. Witten, “Five-branes and M -Theory on an Orbifold”, Nucl. Phys. B **463** (1996) 383, [hep-th/9512219].
8. G. Aldazabal, A. Font, L. E. Ibanez, A. M. Uranga and G. Violero, “Non-Perturbative Heterotic D=6, N=1 Orbifold Vacua”, Nucl. Phys. B **519** (1998) 239, [hep-th/9706158].
9. A. Bilal, J.-P. Derendinger and R. Sauser, “M-Theory on S^1/Z_2 : New Facts from a Careful Analysis”, Nucl. Phys. B **576** (2000) 347 [hep-th/9912150].
10. P. Townsend, “The eleven-dimensional supermembrane revisited”, Phys. Lett. B **350** (1995) 184 [hep-th/9501068].

11. A. Hanany and A. Zaffaroni, “Branes and six-dimensional supersymmetric theories”, Nucl. Phys. B **529** (1998) 180 [hep-th/9712145]; “Monopoles in string theory”, JHEP **9912** (1999) 014 [hep-th/9911113].
12. N. Seiberg, “Five dimensional SUSY field theories, non-trivial fixed points and string dynamics”, Phys. Lett. B **388** (1996) 753 [hep-th/9608111].
13. D. R. Morrison and N. Seiberg, “Extremal transitions and five-dimensional supersymmetric field theories”, Nucl. Phys. B **483** (1997) 229 [hep-th/9609070].
14. G. Aldazabal, A. Font, L. E. Ibanez and F. Quevedo, “Chains of N=2, D=4 heterotic/type II duals”, Nucl. Phys. B **461** (1996) 85 [hep-th/9510093].
15. M. Duff, R. Minasian and E. Witten, “Evidence for Heterotic/Heterotic Duality”, Nucl. Phys. B **465** (1996) 413 [hep-th/9601036].
16. J. Polchinski, “String Theory, Vol. II”, Cambridge University Press, 1998.
17. M. Dine, P. Huet and N. Seiberg, “Large And Small Radius In String Theory”, Nucl. Phys. B **322** (1989) 301.
18. J. Dai, R. G. Leigh and J. Polchinski, “New Connections Between String Theories”, Mod. Phys. Lett. A **4** (1989) 2073.
19. J. Polchinski and E. Witten, “Evidence for Heterotic - Type I String Duality”, Nucl. Phys. B **460** (1996) 525 [hep-th/9510169].
20. S. Kachru and E. Silverstein, “On gauge bosons in the matrix model approach to M theory”, Phys. Lett. B **396** (1997) 70 [hep-th/9612162].
21. D. A. Lowe, “Bound states of type I’ D-particles and enhanced gauge symmetry”, Nucl. Phys. B **501** (1997) 134 [hep-th/9702006], “Heterotic matrix string theory”, Phys. Lett. B **403** (1997) 243 [hep-th/9704041].
22. D. Matalliotakis, H. Nilles and S. Theisen, “Matching the BPS spectra of heterotic – type-I – type-I’ strings”, Phys. Lett. B **421** (1998) 169 [hep-th/9710247].

23. O. Bergman, M. R. Gaberdiel and G. Lifschytz, “String creation and heterotic-type I’ duality”, Nucl. Phys. B **524** (1998) 524 [hep-th/9711098].
24. C. P. Bachas, M. B. Green and A. Schwimmer, “(8,0) quantum mechanics and symmetry enhancement in type I’ superstrings”, JHEP **9801** (1998) 006 [hep-th/9712086].
25. F. A. Cachazo and C. Vafa, “Type I’ and real algebraic geometry”, [hep-th/0001029].
26. M. R. Douglas, S. Katz and C. Vafa, “Small instantons, del Pezzo surfaces and type I’ theory”, Nucl. Phys. B **497** (1997) 155 [hep-th/9609071].
27. E. Witten, “New “Gauge” Theories In Six Dimension”, JHEP **9801** (1998) 001; Adv. Theor. Math.Phys. **2** (1998) 61 [hep-th/9710065].
28. S. Elitzur, A. Giveon, D. Kutasov, E. Rabinovici and A. Schwimmer “Brane dynamics and N=1 supersymmetric gauge theories”, Nucl. Phys. B **505** (1997) 202 [hep 9704104]; K. Landsteiner and E. Lopez, “New curves from branes” Nucl. Phys. B **516** (1998) 273 [hep-th 9708118]; N. Evans, C.V. Johnson and A.D. Sharpere, “Orientifolds, branes, and duality of 4D gauge theories”, Nucl. Phys. B **505** (1997) 251 [hep-th 9703210]; A. Brandhuber, J. Sonnenschein, S. Theisen and S. Yankielowicz, “M theory and Seiberg-Witten curves: orthogonal and symplectic groups”, Nucl. Phys. B **504** (1997) 175 [hep-th 9705232]; for a review, *cf.* A. Giveon and D. Kutasov, “Brane dynamics and gauge theory”, Rev. Mod. Phys. **71** (1999) 983 [hep-th/9802067].
29. E. Witten “Solutions of 4d field theories via M-theory”, Nucl./ Phys./ B **500** (1997) 3 [hep-th 9703166].
30. I. Brunner and A. Karch, “Branes at orbifolds versus Hanany Witten in six dimensions,” JHEP **03** (1998) 003 [hep-th/9712143].
31. J.L. Romans, “Massive N=2a Supergravity in 10 Dimensions”, Phys. Lett. B **169** (1986) 147.

32. A. Hanany and E. Witten, “Type IIB superstrings, BPS monopoles, and three-dimensional gauge dynamics”, Nucl. Phys. B **492** (1997) 152 [hep-th/9611230].