

Panoptic: True Joint mmWave Communication and Sensing with Compressive Sidelobe Forming

Heyu Guo, Ruiyi Shen, Florian Kosterhon, and Yasaman Ghasempour

Abstract—The integration of communication and sensing functions within mmWave systems has gained attention due to the potential for enhanced passive sensing and improved communication reliability. State-of-the-art techniques separate these two functions in frequency, use of hardware, or time, i.e., sending known preambles for channel sensing or unknown symbols for communications. In this paper, we introduce Panoptic, a novel system architecture for integrated communication and sensing sharing the same hardware, frequency, and time resources. Panoptic jointly detects unknown symbols and channel components from data-modulated signals. The core idea is a new beam manipulation technique, which we call compressive sidelobe forming, that maintains a directional mainlobe toward the intended communication nodes while acquiring unique spatial information through pseudorandom sidelobe perturbations. We implemented Panoptic on 60 GHz mmWave radios and conducted extensive over-the-air experiments. Our results show that Panoptic achieves reflector angular localization error of less than 2° while at the same time supporting mmWave data communication with a negligible BER penalty when compared with conventional communication-only mmWave systems.

Index Terms—Joint Communication and Sensing; wireless networks; mmWave

I. INTRODUCTION

Millimeter-wave (mmWave) wireless networks are emerging thanks to the wide available bandwidth and multi-Gbps data rates that enable new applications like extended reality [1], and high-quality video streaming [2], among other applications. On the other hand, GHz-scale bandwidth, mm-scale wavelength, and the ability to manipulate EM radiation using large antenna arrays have made this spectral regime attractive for localization, sensing, and even imaging tasks [3], [4], [5], [6], [7], [8]. The convergence of sensing and communication functions in mmWave wireless networks is a promising trend that has gained increasing momentum in recent research and industrial developments [9], [10]. Indeed, such an interaction enables two key advantages over traditional wireless systems: First, it can offer additional services from existing communication resources and infrastructure, and second, the sensing input from the surrounding medium can significantly enhance the reliability of mobile mmWave communications.

H. Guo, R. Shen, and Y. Ghasempour are with the Department of Electrical and Computer Engineering, Princeton University, Princeton, NJ, 08544 USA e-mail: {hg9046, ruiyishen, ghasempour}@princeton.edu. F. Kosterhon is with TU Delft e-mail: F.Kosterhon@tudelft.nl. This work was conducted while F. Kosterhon was affiliated with TU Darmstadt.

© 2025 IEEE. Personal use of this material is permitted. Permission from IEEE must be obtained for all other uses, in any current or future media, including reprinting/republishing this material for advertising or promotional purposes, creating new collective works, for resale or redistribution to servers or lists, or reuse of any copyrighted component of this work in other works.

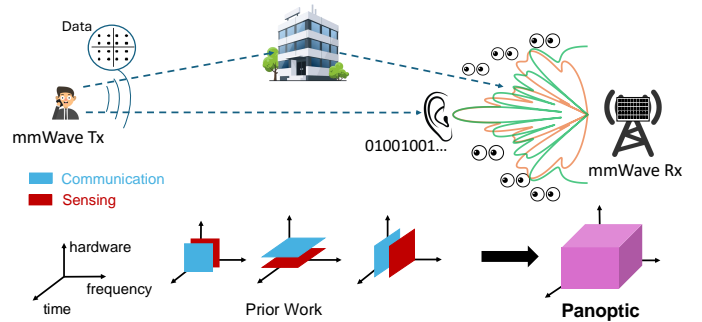

Fig. 1: Overview of Panoptic, a framework for joint data reception and reflector sensing at the same time, frequency, and using the same hardware resources.

The state-of-the-art integrated communication and sensing techniques separate the two functionalities either in time or frequency, or exploit two distinct hardware (e.g., mmWave radar and communication module) [11], [12], [13]. Therefore, despite promising prospects, these efforts do not achieve true joint communication and sensing functionalities¹ that share time, frequency, and hardware resources.

In this paper, we present Panoptic², a novel framework for integrated communication and sensing at the same time, and frequency band. Panoptic does not require additional hardware deployment (e.g., radar) and can be implemented using pervasive and widely available single-RF chain mmWave antenna arrays. The fundamental challenge behind realizing this goal is two-fold: (i) the communication and sensing functions have inherently different requirements, i.e., sensing needs time-varying directional beam scanning while communication demands a stable and accurately aligned directional beam to achieve high SNR; (ii) communication includes detection of *unknown* data symbols while sensing involves analyzing the properties of *known* signals (e.g., cross-correlation of received and known preambles) to extract the key components of the wireless medium.

Panoptic tackles these challenges by introducing a novel antenna modulation and compressive signal processing framework that capitalizes on channel sparsity. Specifically, our key idea is to maintain a directional mainlobe toward the communication node while simultaneously generating pseudorandom sidelobe perturbations to allow for reflection sensing in non-mainlobe directions. The high-level overview of Panoptic is

¹We refer to sensing as finding and tracking surrounding reflecting objects in real-time, which for example can form back-up paths in case of blockage.

²In Greek mythology, Argus Panoptes is a giant with 100 eyes, whose name means "all-seeing".

depicted in Fig. 1 illustrating a bistatic integrated communication and sensing architecture. A mmWave data-carrying link is formed between the two communication parties while, at the same time, sidelobe perturbations on one end assist with environmental tracking. Specifically, a reflected path yields random albeit unique power and phase fluctuations at the receiver for a given suite of randomly shaped sidelobes. Such variations may act as a signature for path sensing when properly extracted from the overall superposed signals containing unknown complex-valued symbols.

To realize such desired beam manipulation, Panoptic leverages antenna subset modulation. Particularly, we randomly turn off (or change the gain of) a subset of antennas in each round. Since the relative phase delays among the antennas are unchanged, the remaining ON antennas still form constructive interference along the same mainlobe directions while random destructive interference perturbs the radiation gain in all other angles. Indeed, our compressive sidelobe architecture enables separating the sensing and communication functionalities in space, while its implementation requires simple single-chain arrays with antenna ON/OFF switching that are commercially available and even already deployed in many real-world settings.

While our compressive sidelobe forming framework addresses challenge (i) explained above, the problem of joint data recovery and path sensing has remained unsolved. Specifically, the received signal is a combination of an unknown data-modulated signal that travels through a set of unknown paths. Further, the non-line-of-sight (NLOS) signatures are inherently weaker due to additional path loss and significantly smaller directivity gain along the sidelobe directions where such paths are perceived. Hence, the NLOS fingerprints may be masked under a much-stronger mainlobe signal. To tackle this, we mathematically model the received signal and present a new signal processing framework that performs consecutive symbol detection and then NLOS angle estimation by integrating information across several compressive sidelobe patterns. Therefore, Panoptic enables real-time and continuous reflector identification and tracking at zero additional overhead, i.e., through joint sensing and data reception in mobile environments. Indeed, such environmental inputs are the key to immediate link recovery under blockage, and realizing reliable and resilient mmWave networking.

We have implemented Panoptic on off-the-shelf mmWave arrays and performed extensive over-the-air experiments at 60 GHz in various configurations in two different environments: a conference room and a large open lab space. As a baseline, we implemented conventional mmWave directional beamforming, in which all antennas are constructively forming an aligned beam toward the communication node; thus, maximizing the link SNR with no sensing capability. Our experimental results demonstrate that Panoptic provides an accurate estimation of NLOS angle with a mean error of less than 1.3° and the standard deviation of less than 1.2° while incurring a negligible penalty on BER performance when compared with the baseline scheme under different modulation schemes. Our results also suggest that Panoptic is scalable to detecting multiple reflectors in the medium as the average NLOS angle

estimation error only slightly rises to 1.70° with two reflectors.

In addition, we have also experimentally investigated the tradeoff between communication and sensing functionalities. Specifically, by randomly turning off a larger subset of antennas, the sidelobe randomness space grows and better sensing accuracy is observed, albeit at the cost of a higher SNR reduction for the mainlobe communication link. Fortunately, this penalty alleviates when large antenna arrays are employed. Indeed, the length of the NLOS perturbation signature correlates with $\binom{N}{k}$, where k is the number of OFF antennas out of total N antennas while the mainlobe directivity scales by a factor of $1 - k/N$. Interestingly, our results reveal that randomly turning off only 2 out of 64 antenna elements creates sufficiently large random space for accurate NLOS angle estimation (error of less than 1.5 degrees) while penalizing the communication SNR by only a negligible amount of 0.28 dB (which does not often result in downgrading the Modulation and Coding Scheme (MCS) of the communication link). Further, thanks to its compressive sensing nature, the number of required beam configurations only grows by $O(\log(N))$ with the number of antennas; therefore, Panoptic is scalable to future massive mmWave arrays. Finally, Panoptic is compliant with IEEE 802.11ay and 5G NR as it does not impose any changes to the communication protocol and frame structure.

II. PRIMER AND STATE-OF-THE-ART

A. Principles of Joint Communication and Sensing

Recently, developing joint communication and sensing (JCS) techniques have emerged to integrate the two functions into one by sharing hardware and signal processing modules, and achieving immediate benefits of reduced cost, size, weight, and better spectral efficiency [14]. In wireless communication networks, the received signal is a function of both the unknown data symbols and the propagation medium, which we intend to sense. In particular, we can write:

$$y = \mathbf{W}_r^* \mathbf{H} \mathbf{W}_t s + n, \quad (1)$$

where \mathbf{W}_r is the receiver weight vector, $*$ is conjugate transpose, \mathbf{H} is the channel response, \mathbf{W}_t is the transmitter weight vector, s is the data symbol and n is the noise. The goal of wireless sensing is to extract \mathbf{H} , which carries key environmental components. However, from Eq. (1), it is evident that simultaneous channel estimation (\mathbf{H}) and data decoding (s) is not trivial.

Therefore, most existing efforts in JCS leverage *known preambles and pilots* that are already part of the IEEE 802.11 or 5G NR frame structures for sensing. Existing mmWave sensing systems have repurposed the beam training period in IEEE 802.11ad/ay, during which the AP adopts sequential directional beams toward different angles. By analyzing the received sector sweep frames, one can then track the channel multipath or the angular location of the transmitting or receiving node passively [15], [16], [17], [18], [19], [20]. However, the beam training period is a low-duty cycle event (e.g., every 100 ms) originally designed to find the best-aligned beams between the AP and stations. Similarly, in 5G NR protocol, the SSB bursts can be sent with a periodicity of 5, 10, 20,

40, 80, or 160 ms (where typically SSB bursts take 5 ms in duration) and leveraged for sensing [21], [9]. Clearly, a more frequent SSB burst can offer advantages for sensing at the cost of increased overhead (i.e., occupying channel resources that be otherwise used for data communication). We emphasize that, unfortunately, these techniques do not support truly joint communication and sensing: when the AP/BS is performing beam training, it can sense the environment but without data communication; when the AP and stations are communicating, sensing cannot be achieved.

In addition, the preamble and header of a directional multi-gigabit (DMG) packet in IEEE 802.11ad can be used for sensing [22], [23]. However, according to the standard, the preamble, header, and data fields of a DMG packet are transmitted with the same antenna weight vector (AWV), which limits their capability to sense channel dynamics (e.g., reflectors) outside of the mainlobe.

In contrast, Panoptic supports integrated directional data reception and quasi-omni sensing without adding any additional overhead using unknown data symbols.

B. JCS with Auxiliary Spectral Bands or Hardware

To achieve communication and target sensing at the same time, some prior efforts mount additional hardware on the mmWave base station or the mobile users to act as a passive radio sensor or an active transceiver, albeit at a different frequency band to avoid interference on the ongoing communications. This includes the use of co-located sub-6 GHz radios [12], mmWave radar [13], reflective surfaces [24], cameras [25], and the auxiliary mmWave radios [26], [27].

However, these works require additional hardware or spectrum resources hindering spectrum efficiency. Mounting additional hardware increases power consumption and may even yield new privacy concerns (e.g., in the case of the camera). Further, the cost of hardware in addition to the prohibitively high labor cost associated with implementation and maintenance make these solutions impractical and non-scalable beyond laboratory settings. In contrast, Panoptic uses existing single-chain analog arrays prevalent in all mmWave nodes (base stations, access points, and mobile users) without the need for additional hardware, spectrum resources, or even without any hardware modification, making it easily scalable in real-world settings.

C. Multi-Beam Full Duplex JCS Systems

Different from the above strategies, another line of work exploits spatial division between sensing and communication via beam manipulation [28], [29]. Although beamforming for communication and sensing separately has been studied extensively [30], its application in JCS comes with a different set of challenges. Specifically, communication and sensing have different beam requirements: sensing needs time-varying directional beam scanning while communication demands stable and accurately aligned directional beam to achieve high SNR. More recently, multi-beam designs using full-duplex radios have been proposed, where there is a fixed directional beam for downlink communication and the other sweeping beam for

collecting the reflected signal back for sensing [31], [32], [33]. In such case, complex beamforming optimization is needed to mitigate the self-interference between communication and sensing at the full-duplex node [34], [35], [36]. In such full-duplex monostatic architectures, the transmitted signals are known at the co-located receiver and can be used as a reference to easily extract the desired reflection information from nearby objects. Overall, full duplex radios are not common in practical infrastructure settings, especially for mobile devices because of the increased hardware complexity and power consumption.

While our work falls into the general category of beam manipulation for JCS, Panoptic has a fundamentally different system model exploiting half-duplex single-chain analog phased arrays commonly available in all mmWave nodes. Further, the bistatic JCS architecture in Panoptic means that nodes might not be tightly synchronized posing additional challenges for sensing. Further, unlike multi-beam full duplex JCS systems that assume known data preambles for sensing, Panoptic is the first to jointly decode unknown data symbols and sense channel components at the same time.

III. PANOPTIC DESIGN

A. System Model

We consider the case where two mmWave nodes have established a directional communication link. We assume each node is equipped with a conventional analog beamforming array connected to a single RF chain, i.e., an N_{tx} -element TX antenna array and N_{rx} -element RX antenna array. For simplicity, we assume that the antenna arrays are uniform linear arrays but extension to arbitrary antenna arrays is straightforward. Our goal is to jointly decode unknown data symbols while extracting the sparse channel components (i.e., reflected paths) at the same time, and frequency, and using the same one-chain receiver antenna array.

We present Panoptic, a novel beam manipulation technique for true joint communication and sensing. The key idea is maintaining the receiver mainlobe toward the communication node while simultaneously generating pseudorandom perturbations on sidelobes. Thanks to the sparsity of mmWave channels and compressive sensing principles, Panoptic is able to extract the target components in the environment (i.e., the angular location of reflectors) while correctly detecting the unknown sent symbols.

The Panoptic system model is shown in Fig. 2 where the transmitter adopts any fixed beam while the receiver has time-varying compressive sidelobe patterns. The pseudorandom perturbation of the sidelobes can be realized by randomly turning off (or changing the gain) a subset of antennas for each reception. Since the relative phase delays among the antennas are unchanged, the remaining antennas still form constructive interference along the same mainlobe directions while random destructive interference perturbs the radiation gain in all other angles. We will show that this simple scheme creates a wide angular field of view (FoV) for sensing. We underscore that such a radiation manipulation technique does not need hardware modification or multiple RF chains as almost all commodity phased arrays allow for at least 1-bit amplitude control (ON/OFF) per antenna.

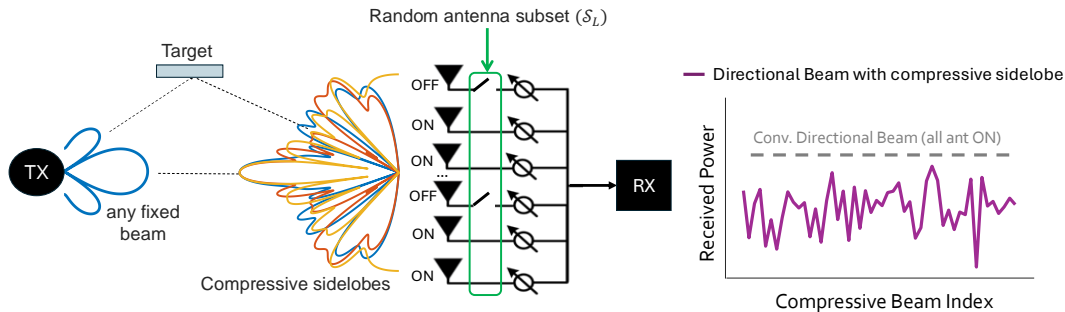

Fig. 2: The architecture for compressive sidelobe beamforming that maintains a directional and aligned mainlobe for communication and creates pseudorandom sidelobes for NLOS sensing.

Another key challenge is simultaneously extracting symbols and target information from received data-modulated signals. This is non-trivial because the received signal contains an unknown combination of the transmitted symbols and the propagating environment. Further, the sensing sidelobes are much weaker than the communication mainlobe, making accurate and reliable sensing much more difficult. In other words, the sidelobe variations yield minute perturbations in the overall captured phase and amplitude at the RX, which acts as a unique fingerprint for the target's angular location. However, such information-rich perturbations may be masked under the data-induced phase/amplitude variations that are received under a much stronger mainlobe direction. This is demonstrated in Fig. 3. To tackle this issue, we perform integration of multiple signals for sensing, where the integration window length can be adjusted subject to sidelobe power. Our key insight is that the antenna ON/OFF switching is controllable and can happen at a much lower pace than the symbol rate; hence, several samples are effectively collected under the same sidelobe pattern. Indeed, the sensing time scale follows the mobility time scale (at millisecond scale) and is slower than the symbol transmission rate (at MHz or even GHz). Finally, Panoptic provides a *non-coherent* target sensing framework that only utilizes the amplitude of received signals, and therefore is robust to carrier frequency offset and synchronization non-idealities between the two communicating parties.

Next, we will explain our theory of compressive sidelobe beams and present the joint data decoding and sensing algorithm in Panoptic.

B. Compressive Sidelobe Beam Design

The objective of adaptive compressive sidelobe beam design is to ensure a directional communication link maximizing the beamforming gain between the transmitter and the target receiver (described by the angular location AoA (Angle of Arrival) / AoD (Angle of Departure) of (ϕ_0, θ_0)) while at the same time causing sufficient perturbations at other angles ($\phi \neq \phi_0$ and/or $\theta \neq \theta_0$) for NLOS sensing. Such radiation perturbations can be created by manipulating the weight vector at the transmit/receive mmWave arrays.

We consider a sensing interval of T seconds during which the channel variation is small enough to allow for a quasi-stationary assumption of channel paths and end users. Note that T can be adapted as a control knob in Panoptic's

framework. During this sensing interval, the mmWave end nodes adopt M different beam configurations. We can write the received signal for the n^{th} symbol under the m^{th} beam configuration as follows:

$$y[n, m] = w_r^*[m]Hw_t[m]s[n, m] + z[n, m], \quad (2)$$

where $w_r[m]$ and $w_t[m]$ are the m^{th} receiver and transmitter weight vectors, respectively, and $z[n, m]$ is the zero-mean noise. The wireless channel H consists of K multipath components described by their AoA/AoD pair (ϕ_k, θ_k) and complex channel gain α_k . Hence, we can write H as follows:

$$H = \sqrt{\alpha_0}\mathbf{b}(\phi_0)\mathbf{a}^*(\theta_0) + \sum_{k=1}^K \sqrt{\alpha_k}\mathbf{b}(\phi_k)\mathbf{a}^*(\theta_k), \quad (3)$$

where $\mathbf{b}(\cdot)$ is the steering vector for the TX array and $\mathbf{a}(\cdot)$ is the steering vector for the RX array. We note that K is small in practice due to the sparsity in mmWave channels.

In principle, the pseudorandom sidelobe perturbations can be realized in both TX arrays and RX arrays. However, in practice, changing the radiation profile on both sides at the same time may cause challenges in sensing and inference. This is because the weight vector variation on both ends (i.e., $w_r[m]$ and $w_t[m]$ in Eq. (2)) should be somewhat synchronized. In other words, the receiver should know the weight vector (i.e., sidelobe patterns) adopted at the TX for each signal reception. Hence, without loss of generality, we consider a fixed transmit beam $w_t[m] = w_t$ and a varying receive radiation pattern. We highlight that the Panoptic's framework can be directly applied to a fixed received beam and varying transmit sidelobe beams. In Sec. III-C3, we will illustrate the communication-sensing tradeoffs and discuss that it is desirable to implement Panoptic's compressive sidelobes on the mmWave end node (TX or RX) with more antennas.

To create pseudorandom perturbations on the sidelobes, Panoptic uses a randomly chosen subset of antennas to form a directional received beam toward the TX while the remaining antennas are kept idle. Since the antenna amplitudes are changing (ON vs. OFF) and not their phases, this creates sidelobes without changing the mainlobe direction, as also depicted in Fig. 2. Mathematically, let $\mathcal{S}_L[m]$ be a random subset of L antennas (out of N_{rx}) used for the m^{th} pattern configuration. We can write the varying received weight vector with the mainlobe pointing toward the TX (i.e., ϕ_0 AoA) as:

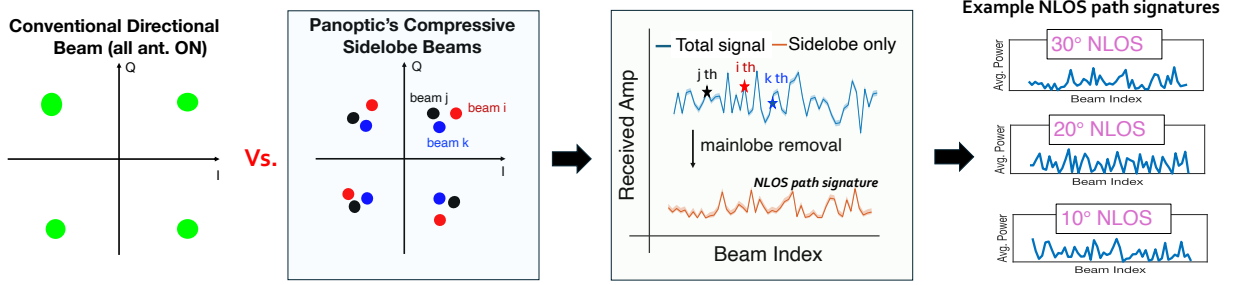

Fig. 3: Compressive sidelobe beam creates small but pseudorandom perturbations on the received constellation, creating a unique NLOS-dependent fingerprint. Yet, such signatures might appear hidden under a stronger mainlobe.

$$w_r[m](l) = \begin{cases} e^{j(l-1)2\pi\frac{d}{\lambda}\cos(\phi_0)}, & l \in \mathcal{S}_L[m] \\ 0, & \text{otherwise} \end{cases} \quad (4)$$

where $w_r[m](l)$ is the l^{th} entry of the received weight vector (i.e., $l = 1 : N_{rx}$) and d is the antenna spacing. Hence, by combining the steering vector and the weight vector from Eq. (4), we can find the array factor (or radiation profile) of the receiver beam as follows:

$$R(m, \phi) = \sum_{l \in \mathcal{S}_L[m]} e^{j(l-1)2\pi\frac{d}{\lambda}(\cos\phi_0 - \cos\phi)}. \quad (5)$$

We highlight three important observations: First, $R(m, \phi)$ converges to a constant $R(m, \phi) = L$ at the target communication transmitter location ($\phi = \phi_0$). Indeed, all antennas being ON (i.e., $L = N_{rx}$) provides the maximum directivity gain toward the TX. Second, the radiation gain toward other angles ($\phi \neq \phi_0$) is a *random variable* that is dependent on ϕ , the antenna subset size L and the exact subset of antennas that are ON. Finally, random sidelobe perturbations are realized solely with binary amplitude control, making it applicable to practical phased arrays that are not equipped with complex phase/amplitude control circuitry.

C. Joint Data Detection and NLOS Sensing Framework

In this section, we explain how Panoptic exploits compressive sidelobes in joint data detection and NLOS extraction. Recall from Sec. III-B that while symbols should be detected at the symbol rate, the sensing time-scale is slower as M compressive sidelobe beams should be observed to reliably extract NLOS components. We will elaborate on the impact of the number of observations (M) later in this subsection.

1) *Symbol Detection*: The key insight behind data detection in Panoptic is that the overall received signal contains a strong contribution from the mainlobe with a stable amplitude and phase profile that does not significantly vary with sidelobe perturbations. In other words, the much weaker sidelobe signals bonding off reflectors and reaching the receiver would have much lower power than the mainlobe signal. Specifically, by taking into consideration Eq. (2) and Eq. (5) and assuming that the TX beam is aligned to the RX, we can write

$$y[n, m] = \left[\sqrt{N_{tx}^2 L^2 \alpha_0} + \sum_{k=1}^K \sqrt{\alpha_k} R(m, \phi_k) \right] s[n, m] + z[n, m] \\ \cong N_{tx} L \sqrt{\alpha_0} s[n, m]. \quad (6)$$

Given the random perturbations in the sidelobe, the NLOS components will add up randomly at the receiver while the mainlobe direction provides a fixed and high directivity gain. Hence, the received constellation does not deviate too much from the nominal constellation realized when all received are ON. Fig. 3 illustrates the received constellation before and after applying compressive sidelobe patterns. We can observe that the received symbols have slightly lower power and random yet small phase fluctuations. Nevertheless, a scaled decision boundary can still be used for symbol detection. Since the antenna subset size (L) is known at the receiver, finding the scaled decision boundary is straightforward by multiplying the original scaled boundary and L/N_{rx} .

We emphasize that the communication SNR can be modeled as $\text{SNR} = \epsilon_s \alpha_0 N_{tx}^2 L^2 / \sigma^2$, thus, the received SNR increases with the antenna subset size (i.e., the number of ON antennas). Hence there is a tradeoff between accurate symbol extraction and sensing performance: decreasing the antenna subset size hinders the communication SNR and may yield a higher symbol error rate but it will increase the random space for sidelobe sensing. We will explore it in Sec. III-C3.

2) *Reflector Sensing Framework*: After detecting the data symbols, Panoptic attempts to extract the AoA of the reflectors in the environment. Intuitively, such information is embedded in the small perturbation of the received signal vector around the constellation points. As depicted in Fig. 3, such small perturbations are a function of compressive sidelobe in-use, the reflector angle, and noise. The impact of noise can be alleviated by averaging over several observations under a fixed compressive sidelobe pattern. Recall from Sec. III-B that we received multiple symbols under m^{th} compressive sidelobe configuration. Therefore, as shown in Fig. 3, the pattern of average power fluctuations under several different pseudorandom compressive beams acts as a fingerprint that hints at the underlying reflectors' characteristics. Fig. 3 illustrates that such power variations are a unique signature for the reflector's angular location.

Next, we mathematically formulate Panoptic's AoA estimation scheme that builds on the insights explained above. Specifically, we can first find the amplitude of the signal captured by the mainlobe as follows:

$$A_{ML} = \frac{1}{MN} \sum_m \sum_n \left| \frac{y[n, m]}{\bar{s}[n, m]} \right| \cong N_{tx} L |\sqrt{\alpha_0}|, \quad (7)$$

where $\tilde{s}[n, m]$ is the estimated symbol from the data extraction phase, M is the total number of compressive sidelobe configurations and N is the total number of measurements under each compressive beam. In other words, by taking the average of the measured signals under many different random sidelobe perturbations, the result converges to the mainlobe signal, which is the unchanged portion of the transmission throughout. Further, since the amplitude of the received signal is also a function of transmitted data (particularly in amplitude modulation schemes), we remove the impact of data symbols in calculating A_{ML} .

Next, we can isolate the impact of the NLOS components by removing the mainlobe contribution from the received signal:

$$F[m] = \frac{1}{N} \sum_n \left| \frac{y[n, m]}{\tilde{s}[n, m]} - A_{ML} \right|. \quad (8)$$

Here $F[m]$ is only dependent on NLOS paths and the sidelobe perturbations of the m^{th} beam, i.e., $F[m] \propto \left| \sum_{k=1}^K \sqrt{\alpha_k} R(m, \phi_k) \right|$. Indeed, the vector $\mathbf{F} = [F[1], F[2], \dots, F[M]]$ can be tested as the NLOS angle fingerprint explained above. Therefore, to find the angle of arrival of the most dominant NLOS path, we leverage the principle of compressive sensing and find the angle that offers the maximum correlation between the pattern of power perturbation vs compressive sidelobe beams in theory (i.e., $R(m, \phi)$ as defined in Eq. (5)) against the measured perturbation fingerprint (i.e., \mathbf{F}):

$$\phi_1^* = \operatorname{argmax}_{\phi} \mathbf{F} \cdot |\mathbf{R}(\phi)| = \operatorname{argmax}_{\phi} \sum_m F[m] \cdot |R(m, \phi)|, \quad (9)$$

where ϕ_1^* is the estimated AoA of the dominant reflected path. If extracting p NLOS paths is desired, then we extract the angle corresponding to the top p peaks in $\mathbf{F} \cdot |\mathbf{R}(\phi)|$. It is expected that the estimation accuracy worsens for less pronounced paths as they are inherently weaker and leave a smaller footprint in sidelobe perturbations. Fortunately, due to channel sparsity in mmWave bands, only a few paths may exist in practice.

In Panoptic, several parameters affect the NLOS extraction performance: First, increasing the number of measurements or observations (i.e., N) can help remove hardware non-idealities and channel noise, while improving sensing accuracy, consequently. Second, increasing the number of compressive sidelobes used during measurements (i.e., M) yields longer and more spatially diverse power perturbation signatures. Hence, Panoptic can infer the AOA with finer granularity. Third, increased radiation gain toward the sidelobe angles would definitely improve NLOS sensing. However, increasing the sidelobe power level would inevitably yield the theft of power from the mainlobe direction, hindering the underlying communication performance and reliability.

Coherent vs Non-Coherent Sensing. In principle, minute perturbations in power and phase can both be leveraged for NLOS sensing. Extending the mathematical framework of Panoptic to include complex signatures is straightforward. Specifically, only slight changes to Eq. (7) to Eq. (9) are needed, i.e., we can write them as $A_{ML} = \frac{1}{MN} \sum_m \sum_n \frac{y[n, m]}{\tilde{s}[n, m]}$, $F[m] = \frac{1}{N} \sum_n \left(\frac{y[n, m]}{\tilde{s}[n, m]} - A_{ML} \right)$, and

$\phi_1^* = \operatorname{argmax}_{\phi} \left| \sum_m F[m] \cdot R^*(m, \phi) \right|$. However, for practical considerations, non-coherent sensing has certain advantages over its coherent counterpart: first, it is more resilient to the phase noise, carrier frequency offset, and synchronization non-idealities commonly seen in commercial mmWave arrays [37] and second, it allows for aggregation of information across several packets that might not be tightly synchronized in phase. We emphasize that if accurate phase measurements are available, Panoptic can be easily extended to include phase readings in the AoA extraction framework, as discussed above. Finally, while the above modeling considers a narrowband channel, the extension of Panoptic to wideband channels with multiple subcarriers (i.e., OFDM) is straightforward. We will experimentally evaluate Panoptic in both coherent and non-coherent cases (under OFDM) in Sec. V-D4.

Overhead and Complexity of Sensing Framework.

Panoptic exploits received data symbols for sensing and hence does not incur any additional overhead in time. In terms of computational complexity, Panoptic's framework is lightweight, as also indicated from Eq. (7)-(9). We note that $R(m, \phi)$ is a deterministic function of array geometry and can be known a priori. It is evident that the computational complexity scales linearly with the total number of sidelobe configurations. Furthermore, we argue that the number of compressive sidelobe patterns needed for accurate path sensing itself scales with $O(\log N_{rx})$, where N_{rx} is the number of antennas. Theoretically, with this number of patterns, the probability of error exceeding a certain range is very small [38]. We emphasize that this complexity is much lower than the conventional path discovery with directional steering that scales with $O(N_{rx})$, thanks to the channel sparsity and properties of compressive sensing.

Specifically, the idea of compressive sidelobe beams originates from compressive sensing in which several pseudo-random weight vectors are used for AoA extraction [39]. Specifically, in compressive sensing, $w_n = e^{j\phi_n}$, where ϕ_n is i.i.d. and follows a uniform distribution over $(0, 2\pi)$ to ensure $\mathbb{E}[w_n] = 0$, and $\operatorname{Var}[w_n] = 1$. This results in completely random radiation patterns that unfortunately fail to provide sufficient directivity gain for a communication link. Instead, in Panoptic, by maintaining a high-gain mainlobe and perturbing the sidelobes, we achieve the best of two worlds: high-gain communication link from the mainlobe and compressive AoA estimation in sidelobe directions. Previous works rigorously proved that the path estimation task requires $O(\log N)$ unique patterns [39]. Intuitively, by removing the impact of the mainlobe (see Eq. (8)), the residual pattern resembles the pseudorandom compressive beams from the literature; hence, the number of measurements/configurations scales with the same log factor. We skip the detailed proof due to space limitations. This indicates that Panoptic is scalable to future massive mmWave MIMO settings.

3) Tradeoff between Communication and Sensing: In Panoptic, the communication and sensing functions share the same front-end, time, frequency, and even the same waveform. Here, we elaborate on the tradeoffs between these two functionalities. In principle, the communication SNR depends on the directivity gain along the mainlobe direction, and the AoA

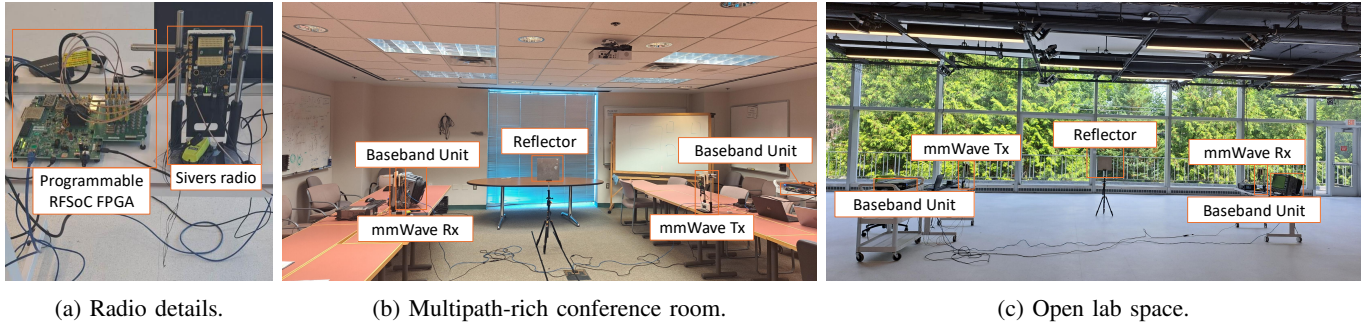

Fig. 4: Experimental setup with custom off-the-shelf mmWave arrays deployed in two different environments.

resolution depends on the level of unique perturbations created along sidelobe angles. Given a fixed antenna array size, the mainlobe strength is directly related to the number of ON antennas (L). The random space for sidelobe perturbations, however, depends on $\binom{N_{rx}}{L}$. Therefore, an antenna subset size below $N_{rx}/2$ would not benefit communication or sensing. When L increases ($L > N_{rx}/2$), the communication SNR improves but the random space for sensing shrinks, and vice versa. It is also evident that implementing Panoptic on a mmWave node with a larger antenna array size (larger N_{rx}) is desired as it can create the same sidelobe random space while turning off fewer antennas, imposing less penalty on the communication SNR. Hence, if there is an asymmetry between the array size at the two mmWave end nodes, running Panoptic on the node that has a larger array is advantageous. Interestingly, our evaluations suggest that randomly turning off only 2 antennas in a 64-element array creates sufficiently large random space for angular sensing of 1.5 degrees while imposing an SNR loss of less than 0.3 dB for the directional communication link.

IV. IMPLEMENTATION

We implement Panoptic on COTS mmWave hardware and conduct extensive over-the-air experiments at 60 GHz.

Hardware. We use commercial mmWave phased arrays as front-ends at both TX and RX. Specifically, we use Siviers EVK06002 boards [40] that can operate in 57-71 GHz regime and are widely employed in previous mmWave research and development studies. These boards have 16 antennas for transmission and reception separately, as shown in Fig.4(a). The array supports beam scanning in the azimuthal direction with the field of view of 90° , i.e., the mainlobe spans from -45° to 45° with a step size of about 1.5° . We generate a compressive sidelobe beambook for any given mainlobe direction by randomly turning off a subset of antennas without modifying the phase shifters' values. If not specified, we turn off four out of sixteen antennas, and we consider $63 \times 3 = 189$ different random subsets, i.e., sidelobe configurations. We evaluate the impact of antenna subset size and number of observations in Sec. V-C.

Experimental Setup. We conduct experiments in two different environments. The first environment is a multipath-rich conference room with several tables, chairs, and whiteboards as shown in Fig. 4(b). The second environment is an open lab space, as shown in Fig. 4(c), with a highly reflective

glass wall and large square footage suitable for long-distance experiments. In both environments, we use a small metal reflector of size 0.3×0.3 m (even smaller than a mini TV or a monitor) and place them in various locations and orientations. We note that detecting this small reflector is more challenging compared with a large whiteboard or wall that was naturally present in those environments.

We have implemented Panoptic using both benchtop equipment as well as high-speed RFSocFs. In the former, we use an arbitrary waveform generator and real-time scope as baseband units on the TX and RX sides, respectively. In this case, the symbol rate is 25 MHz and our frame structure contains 20 preamble symbols followed by 1500 data symbols. We also implemented Panoptic programmable RFSoc FPGA as baseband units on both ends. The ADC sample rate is 3.52 GHz, and the bandwidth is 1.1 GHz with 192 active subcarriers. Our frame structure contains a standard IEEE 802.11 preamble and 64 data symbols.

On the TX side, the mmWave array is connected to the baseband unit, sending modulated data streams with different modulation and coding rates. On the RX side, the downconverted IQ samples are captured and processed by another baseband unit. Differential IQ ports are connected for both TX and RX to remove the distortion and noise. The TX and RX clocks are not synchronized (the nodes are not wire-connected). Panoptic's algorithm is written in a single Python code controlling the Siviers array configuration and data capture. For all experiments, the center frequency is 60.48 GHz. If not specified, we place the TX and RX 3 m apart (we evaluate the impact of TX-RX distance in Sec. V-D). The preambles are used for coarse carrier frequency offset removal adopting conventional signal processing schemes from the literature [41]. The data symbols are used for joint data recovery and NLOS sensing.

V. EVALUATION

A. Compressive Sidelobe Radiation Patterns

First, we evaluate our compressive sidelobe generation technique by measuring the radiation pattern.

Setup. We place the transmitter and receiver at a distance of 1 m apart in an open space without any reflectors around (to resemble an anechoic chamber). To measure the radiation pattern, we rotate the Rx from -50° to 50° , which is slightly wider than the field of view of the phased array.

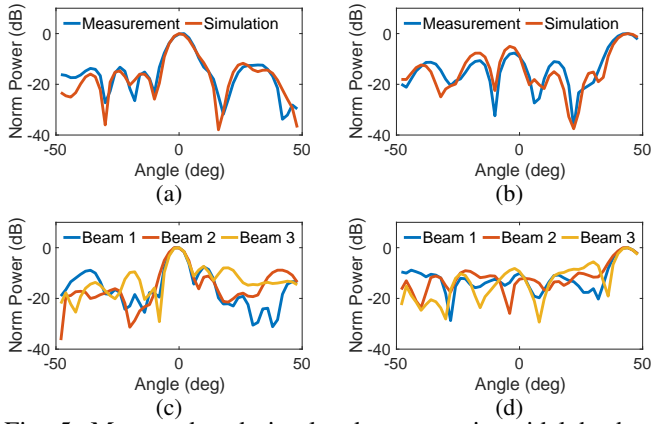

Fig. 5: Measured and simulated compressive sidelobe beam patterns realized with random antenna subset switching; Mainlobe toward (a) 0° , (b) 45° ; Sidelobe-varying beams with mainlobe toward (c) 0° , (d) 45° .

Results. We measure the radiation pattern under different mainlobe directions and we randomly turn off 4 out of 16 antenna elements. The measured radiation patterns are shown in Fig. 5. We show examples of two different mainlobe configurations and two distinct random sidelobe patterns under each mainlobe. In addition, we have simulated the theoretical radiation pattern using the knowledge of antenna geometry, inter-element spacing, and randomly chosen antenna subsets in measurements. We note that the internal nonidealities between antenna elements (e.g., due to variations in the lengths of the transmission lines in the circuit board connecting the RFIC to the antennas), require a one-time calibration for the array. We have performed antenna calibration based on the beambook provided by the manufacturer [42]. Fig. 5 illustrates good agreement between the simulated and measured radiation patterns. Note that we collected tens of different radiation patterns overall and validated the random sidelobe generation in all cases. Fig. 5c and Fig. 5d depict a few examples of measured sidelobe-varying beam patterns while the mainlobe remains unchanged toward 0° and 45° , respectively.

The results demonstrate a few key findings: First, the compressive sidelobe generation is able to maintain a directional dominant mainlobe. Second, strong sidelobe variations can be synthesized using a simple antenna ON/OFF switch. Third, the radiation pattern can be accurately predicted in simulations even with imperfect COTS arrays. We note that Panoptic relies solely on simulated compressive beams for AoA sensing as acquiring measured radiation patterns of compressive beams is not realistic in practice.

B. Panoptic's JCS Performance

Next, we evaluate the performance of Panoptic in extracting the unknown symbols while angularly tracking the environment at the same time.

Setup. We place the TX at the broadside of RX with a 3 m distance in a multipath-rich conference room (see Fig. 4). In these experiments, Panoptic attempts to angularly localize a reflector placed at different locations, i.e., from -40° to 40° (with 5° step except at 0° where the LOS path lies) relative to

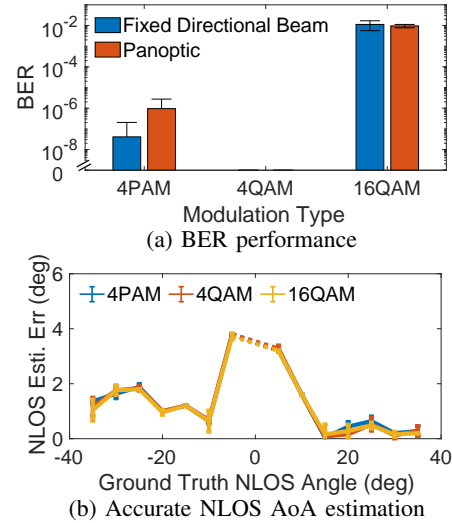

Fig. 6: Panoptic's JCS performance: (a) the measured BER under various modulations; (b) NLOS angle estimation accuracy.

the receiver. At each reflector location, the transmitter sends modulated signals (with a total of 1.23×10^8 bits) and the receiver captures the signal with 189 compressed sidelobe beams. Each compressed beam is generated by randomly turning off 4 out of 16 antennas (i.e., $L = 12$).

Result. Fig. 6a summarized the BER performance under different modulation types. For comparison purposes, we repeat the experiments with a conventional directional beam (all antennas are ON creating a strong mainlobe without any sidelobe perturbations) that supports communication only. We observe that Panoptic yields a slight increase in BER under 4PAM but the BER remains unchanged with other modulations. In particular, for 4PAM, the mean BER for directional beam and compressive sidelobe beam are 4.0967×10^{-8} and 9.4954×10^{-7} , respectively. For 4QAM, the mean BER for the directional beam and compressive sidelobe beam is 0. The better performance of 4QAM compared with 4PAM is owed to the carrier frequency offset mitigation algorithm implemented in our setup [41]. As expected, the BER is higher for 16QAM. Interestingly, spatial diversity offered by sidelobe perturbations in Panoptic even slightly improves the BER results. Hence, in summary, a compressive sidelobe beam achieves similar BER performance compared with adopting conventional fixed directional beams, regardless of modulation type.

However, unlike conventional fixed beams, Panoptic leverage random sidelobe perturbation for NLOS sensing. The estimation accuracy of NLOS AoA is shown in Fig.6b. The mean estimation error for all three modulations is below 2° for all ground truth NLOS angles except for $\pm 5^\circ$. The higher estimation error at $\pm 5^\circ$ is rooted in the fact that at those angles, the NLOS path is close to the LOS angle (which is at 0°). In general, the NLOS sensing results are promising. The mean angle error for 4PAM, 4QAM, and 16QAM is 1.28° , 1.25° , and 1.23° , respectively. Moreover, the standard deviations for 4PAM, 4QAM, and 16QAM are 1.08° , 1.12° , and 1.10° , respectively. Hence, the NLOS sensing performance is robust to various phase/amp modulations.

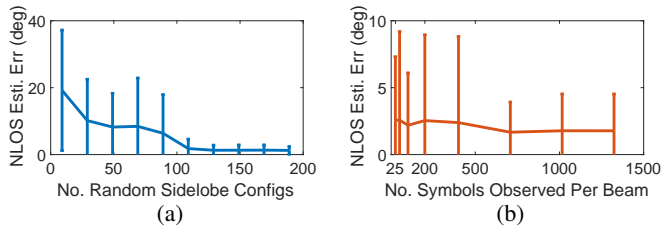

Fig. 7: Impact of Panoptic parameters on NLOS estimation error: (a) Number of random sidelobe configuration tested; (b) Number of data symbols (measurements) captured per beam.

The NLOS sensing in Panoptic offers a reliable backup path for the mmWave communication link without incurring any additional overhead. Indeed, if the LOS path is blocked, the mmWave nodes can automatically adapt their beams toward the known NLOS path. We highlight that with our COTS 16-antennas array, the half-power beamwidth is 6.6° , and the NLOS AoA estimation error of 2° would result in about 1.02 dB loss in maximum achievable directivity gain. In summary, Panoptic achieves high reflector sensing accuracy with a negligible loss on the accurate data detection performance.

C. Impact of Panoptic’s Design Parameters

In Sec. III, we illustrated that a few key parameters affect Panoptic’s data reception and NLOS sensing capabilities. Namely, the number of compressive sidelobe beams (M), the antenna subset size (L), and the number of data symbols captured under any given beam (N). Here, we experimentally evaluate the impact of these parameters. To this end, we use the setup explained in Sec. V-B and use 4QAM for modulation (the same trends and findings hold for other modulations).

1) *Number of random sidelobe configurations (M):* First, Fig.7a depicts the NLOS angle estimation accuracy with the varying number of randomly generated sidelobe configurations. We observe that the estimation error decreases monotonically with more sidelobe configurations, which matches well with the theoretical analysis in Sec.III-C2. Further, with 100+ configurations, the error reaches a plateau. Hence, beyond this point, there is only negligible improvement in NLOS extraction when adopting more beam patterns, but rather, this would yield a higher sensing and detection delay. In practice, Panoptic adapts the number of sidelobe configurations based on the desired sensing resolution and the scale of mobility in the environment.

2) *Number of data symbols per beam (N):* Second, Fig.7b shows the impact of the number of data symbols captured per compressive beam at the receiver. Recall from Eq. (8) that several measurements with a fixed beam help with averaging out noise and better mapping the sidelobe perturbations to the NLOS path signature. This is also reflected in our experimental results in Fig.7b. We observe that the mean sensing error decreases with more observations per beam. With 25 symbols per beam, the mean NLOS angle error is 2.57° , very close to the final value. The average reflector estimation error decreases below 2° after the symbol number exceeds 700. Also, the standard deviation decreases with more observation which indicates a robust estimation.

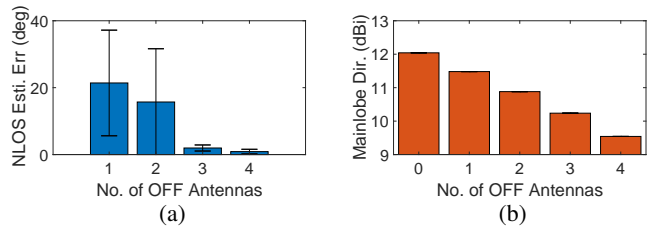

Fig. 8: Impact of random antenna subset size: turning off more antennas (a) yields a larger random beamspace and better NLOS angular localization; (b) decreases the communication (mainlobe) directivity gain.

These results indicate Panoptic’s ability to support beam switching at the sub-packet level, avoiding the untimely update problem caused by long data packets and systems using only known preamble. In other words, Panoptic achieves accurate NLOS sensing independent of the packet length, the presence or lack of known preambles, and other protocol-specific parameters. Instead, Panoptic obtains rich information about the medium by analyzing the captured data symbols themselves at a much faster sampling rate.

3) *Antenna subset Size (L):* Finally, we evaluate the impact of antenna subset size, i.e., the number of randomly selected OFF antennas. To this end, we repeat the experiments by turning off 1,2,3, and 4 antennas (out of 16) while placing a reflector at various angular locations within the range of -30 to 30 degrees (relative to TX). Recall that when all antennas are ON, no sidelobe perturbation happens, and hence NLOS sensing is not possible. We note that the total number of possible sidelobe configurations is only $M=\binom{16}{1}=16$ and $M=\binom{16}{2}=120$, for the case with 1 and 2 antennas OFF, respectively. For a larger number of OFF antennas, the random beam space size is much larger than the beambook memory in the Sivers arrays and hence we limit the number of tested beam configurations to $M = 3 \times 63 = 189$.

As Fig.8a shows the reflector angle estimation error decreases as the number of OFF antennas increases. This matches well with our mathematical foundation in Sec.III-C3 that the more number of antennas off, the larger the number of possible beam patterns, and the higher the sensing accuracy. The mean angle error is 1.97° with 3 antennas OFF and 0.89° with 4 antennas OFF. We note that the lower average error compared with results in Sec. V-B is due to the fact that the considered angular range for the reflector is smaller in this experiment.

On the other side, when turning off more antennas, the mainlobe directivity gain is reduced, which is also captured in Fig.8b (all antennas ON in the leftmost). This may hinder the data detection performance with Panoptic. In this particular experiment, the BER remained at 0 (out of 10^8 transmitted bits) in all cases as the gain of the mainlobe was sufficiently high to close a 3-meter link between the TX and RX even when using 12 antennas only. We evaluate the impact of TX-RX distance in Sec. V-D. We underline that the communication penalty becomes negligible with a larger antenna array because fewer antennas have to be turned OFF. For example, the randomness space size for the 16-element array with 4 antennas

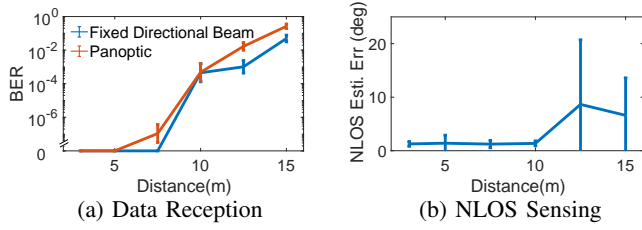

Fig. 9: Impact of TX-RX range on Panoptic.

OFF is $\binom{16}{4} = 1820$, and the size for a 64-element array with 2 antennas OFF is $\binom{64}{2} = 2016$. However, turning off 2 out of 64 antennas decreases the mainlobe directivity (and consequently the SNR of the data link) roughly by $20 \log_{10} \frac{62}{64} = -0.2758$ dB. According to the MCS -EVM table in IEEE 802.11ad MCS [23], such an SNR reduction will not trigger an MCS downgrade. Therefore, Panoptic can offer the same achievable data rate and EVM performance while enabling seamless and real-time reflector sensing capability. In practice, the antenna subset size can be adapted in Panoptic to balance between angular localization accuracy and the desired BER.

D. Microbenchmarks

1) *Impact of Tx-Rx Distance:* In all previous experiments, the TX-RX distance was set to 3 m. Here, we evaluate how Panoptic's performance extends to longer-range communication and sensing. To this end, we repeat our experiments in an open space (see Fig. 4), to push the range up to 15 m. We keep the radio power gains fixed throughout the experiment.

Fig. 9a depicts the result. We observe that as expected, the BER worsens with larger distances. However, interestingly, the BER results are comparable when applying a fixed directional beam (maximum mainlobe directivity) vs. when adopting Panoptic that steals power from the mainlobe direction for the sake of sidelobe modulation. Specifically, in distances below 7.5 m, the BER is 0 for both the directional and compressive sidelobe beams. At a 10 m distance, the BER for directional and compressive sidelobe beam is around 4.5×10^{-4} . When the distance is 12.5 m or larger, the BER gap between the directional beam and compressive sidelobe beam widens as in such low SNR regimes an additional mainlobe directivity can make a more significant difference.

Fig. 9b shows the NLOS sensing accuracy degrades beyond 10 m ranges. The mean angle estimation error is 1.34° at 10m but it increases rapidly to 8.65° at 12.5 m. The reason is that errors in symbol detection would inevitably lead to inaccurate reflector fingerprint extraction and NLOS angular localization, consequently. Indeed, as we explained in Sec. III-C2, a successful symbol detection is the foundation for accurate NLOS angle estimation.

To summarize, Panoptic's communication and sensing performance remains promising in long ranges. Ultimately, in very low SNR regimes, the data perception capability is hindered and its corresponding errors negatively affect the ability of Panoptic to accurately extract the NLOS components. We emphasize that with automatic gain control at the mmWave nodes, distances beyond 10m are achievable too. In these experiments, we kept the amplifier gain fixed to better understand

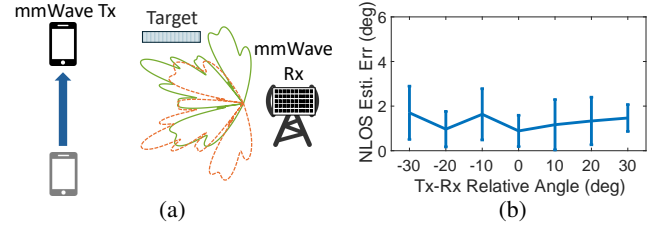

Fig. 10: The impact of Tx-Rx relative angle: (a) Schematic of the setup; (b) NLOS angle estimation error.

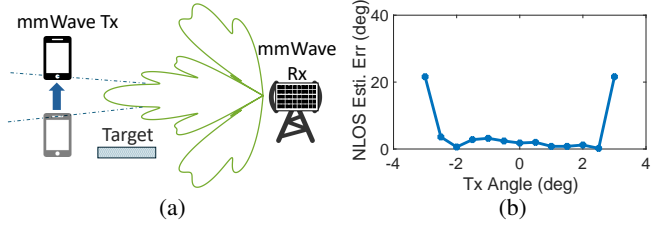

Fig. 11: The impact of slight nodal mobility without beam adaptation: (a) Schematic of the setup; (b) NLOS angle estimation error.

the underlying distance-related trends. Nevertheless, our setup supports an additional 45 dB of amplification gain that, if used, can extend the range significantly.

2) *Impact of TX-RX Relative Angular Location:* So far, we placed TX and RX at the broadside of each other and varied the reflector location. Here, we change the TX-RX relative angular location as depicted in Fig. 10a and investigate the performance of Panoptic. At each LOS configuration, we try several reflector placements. From Fig.10b, we observe that the NLOS AoA estimation accuracy is robust to such nodal configurations and the mean estimation error remains less than 2° regardless of TX-RX angular location. Further, the BER remains all 0 for 4QAM (not shown).

3) *Impact of Nodal Mobility:* In all previous experiments, the transmitter was fixed while the environment (reflector) kept moving. Here, we ask the question: What happens if both the environment and the transmitter are mobile?

Obviously, when the TX moves outside of the RX's beamwidth, the SNR drops significantly and the communication link is compromised. In this case, Panoptic that enables sensing on top of data reception cannot be implemented. Indeed, according to IEEE 802.11ay and 3GPP, a beam re-alignment procedure should be initiated in this scenario. However, the key question is whether Panoptic is robust to slight nodal mobility that does not trigger beam re-alignment protocol. To test this, we move the TX from -3° to 3° relative to the RX in 0.5° step as depicted in Fig. 11a. The receiver mainlobe is steered towards the broadside (i.e., 0°).

The result is shown in Fig. 11b. We observe that the NLOS angle estimation error remains low in the angular range of -2.5° to 2.5° , and grows rapidly beyond that. This is because as the transmitter moves out of the RX beamwidth, the spatial separation between the two functionalities (communication and sidelobe sensing) does not hold anymore, i.e., the significant interference of the LOS communication link hinders obtaining accurate NLOS fingerprints through sidelobe perturbations. Unsurprisingly, due to TX motion, the

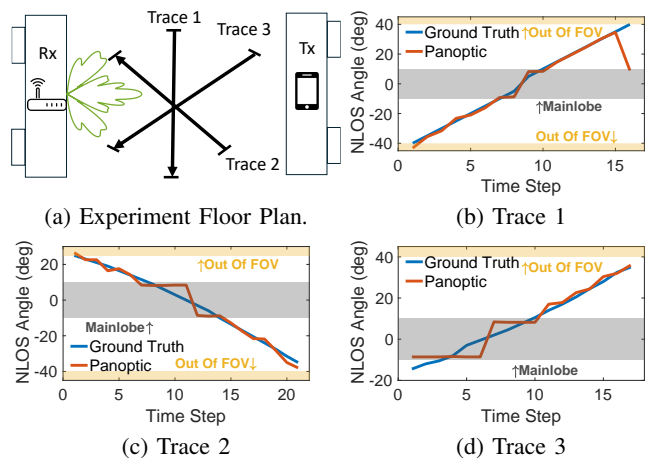

Fig. 12: Panoptic with different target trajectory.

communication SNR also drops which would trigger beam re-alignment protocols. Once the new directional beam is established, Panoptic will be able to provide accurate sidelobe sensing on top of the underlying communication link. Therefore, Panoptic is resilient to slight TX motion as long as the transmitter does not fall outside of the receiver half-power beamwidth, in which both communication and sensing performances are compromised.

4) *Mobile Reflector Trajectory*: So far, we have configured a reflector moving perpendicular to the TX-RX LOS path, similar to Trace 1 in Fig. 12a. Here, we argue that Panoptic is robust to other arbitrary trajectories that a reflector might take as long as the object's reflection footprint can be observed at the receiver. Hence, we place the TX and RX at a 3 m distance in a conference room and transmit 4QAM data symbols at a rate of 25 MHz. We configure three different trajectories as shown in Fig. 12a. The estimation results are depicted in Fig. 12b, 12c and 12d, respectively. We observe that the ground truth angles match well with angles estimated by Panoptic. The error is higher around 0° for all three traces as the reflector is partially blocking the LOS path. Further, the error increases as the reflector approaches the FoV of TX or RX antenna arrays. Overall, we observe that the NLOS sensing accuracy is oblivious to the distance of the reflector from the TX or RX.

Finally, it is worth mentioning that while we adopt a relatively low antenna switching rate for proof of concept experiments, it is possible to increase the antenna switching rate in practice for faster environmental tracking. With a simple calculation, we find that the antenna switching rate needed to angularly track mobile targets is well below the capability of today's off-the-shelf arrays, allowing for real-time estimation and angular tracking in practical mobile environments. Specifically, given a symbol rate of f_s and the number of data symbols per beam N , the beam switching rate can be found as $\frac{f_s}{N}$. For instance, with a symbol rate of 1 GHz and minimum required $N = 750$ (for reliable NLOS signature extraction as discussed in Sec. V-D), we reach the beam switching rate of 1.33 MHz, which is an order of magnitude smaller than the Sivers array switching rate of 18.18 MHz. Indeed, previous work showed an antenna switching rate

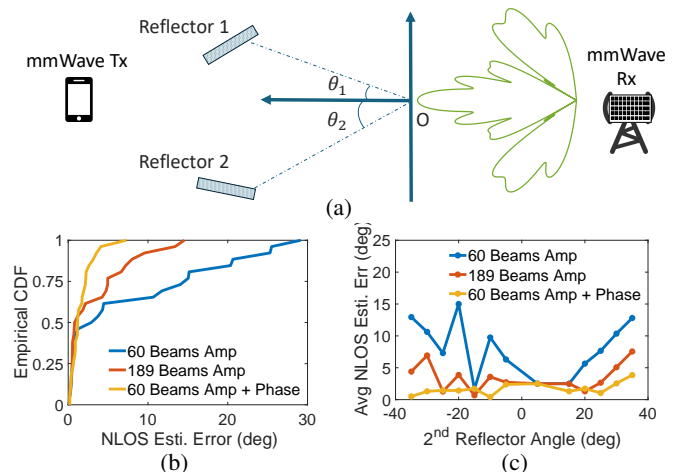

Fig. 13: Panoptic supports sensing multiple reflectors: (a) Schematic of the setup; (b) Empirical CDF of error; (c) AoA error as a function of the angular separation between NLOS paths.

of about 18 MHz on Sivers arrays with FPGA [15]. Note that supporting higher symbol rates is trivial as one can consider increasing N , which helps with better averaging and NLOS signature extraction from weak sidelobe perturbations. Further, as shown by our experimental results in Sec. V-D, testing about $M = 100$ different random sidelobe configurations is sufficient for accurate NLOS sensing. Hence, the sensing frequency is calculated by $\frac{f_s}{N \times M} = 13.3$ KHz, following the previous example. Such a high sensing rate is sufficient to angularly track even high-speed targets, e.g., cars moving at the velocity of 100 km/h.

E. Sensing Multiple Reflectors: Coherent vs Non-Coherent

In previous experiments, we evaluated the JCS capabilities of Panoptic when there is one dominant reflecting target in the environment. Here, we show that Panoptic can be used to extract multiple targets. Further, for comparison purposes, we also implement Panoptic under the coherent setting, where complex NLOS signatures (amplitude and phase) for various random sidelobe patterns are used for NLOS sensing.

Setup. We use two reflectors of the same size 0.3×0.3 m for this setup. We place one reflector at 10° relative to the LOS angle and move another reflector from -35° to 35° with 5° step size, skipping 0° . We send modulated data symbols (4QAM) with OFDM waveforms under each configuration. We switch the sidelobe pattern every two data symbols at a high rate of 2.5 MHz. We collect the data-modulated signals under 60 beams, and evaluate Panoptic under both coherent and non-coherent assumption as described in Sec.III-C2. We also collect data from non-coherent 189 beams to compare with previous results. We repeat all experiments 50 times.

Result. First, we observe that the BER does not get negatively impacted by the placement of two reflectors (not shown), i.e., 0 out of 6.39×10^7 bits, even in a wideband OFDM setting. Further, Fig. 13b shows the empirical cumulative distribution function (CDF) of error across all configurations.

First, as expected, assessing more pseudorandom sidelobe configurations help with improving NLOS estimation under the non-coherent setting. But interestingly integrating phase and amplitude information provides a better AoA estimation performance compared with amp-only sensing framework even with more sidelobe configurations. Fig. 13c confirms that the error is relatively consistent independent of the reflector location. Indeed, the mean angle error (for both reflectors) is measured at 1.70° using the coherent scheme, and the standard deviation remains low at 0.93° . The 90th percentile is 3.15° . Hence, our results confirm that Panoptic can successfully extract multiple targets in the environment while detecting the unknown transmitted OFDM data symbols.

VI. DISCUSSION

Super-Resolution Sensing with Panoptic. While this paper builds a novel foundation for joint communication and sensing using antenna subset switching, there are several schemes that can be adopted in future work to improve the sensing resolution. First, combining phase and amplitude readings, one can extend Panoptic to more advanced sensing tasks like environmental imaging, human activity recognition, etc. We leave this exploration for future work. Second, Panoptic chooses the antenna subset randomly without any feedback from the RX. In principle, not every sidelobe perturbation pattern provides the same amount of information for a particular target extraction. In the future, we will explore adaptive compressive sidelobe selection strategies. Last but not least, more advanced data processing methods such as data-driven and ML-assisted techniques could potentially improve sensing accuracy. We leave this for future work.

Scaling to Large Arrays . The mmWave nodes we use in evaluating Panoptic have 16 antenna elements on the azimuth plane. Indeed, mmWave AP/BS (and even mmWave handheld devices) are often equipped with larger antenna arrays. Larger antenna arrays expand the randomness space for sidelobe perturbations and result in better angular localization resolutions. In this case, turning off a small number of antennas can provide sufficient random space for sensing; hence, the penalty of compressive sidelobe transmission on the communication SNR and BER becomes negligible. As discussed in Sec. III-C2, the number of compressive sidelobe beam measurements only grows with $O(\log N)$; hence, Panoptic is scalable to large arrays.

Integrating Inputs from Preambles and Data Symbols. While past work exploited known signals (e.g., preambles) for channel sensing, this paper introduced a paradigm shift in JCS systems by jointing detecting channel components and unknown data symbols. A frame includes short preambles and many data symbols. Hence, in principle, one can leverage inferences from preambles as known reference signals (albeit available at lower duty-cycle) to further improve sensing resolution in Panoptic. We will leave this for future exploration.

Extension to 3D Imaging. In this paper, we have implemented 2D sensing using mmWave arrays that support azimuth beamforming only. In principle, with radios supporting beamforming in both azimuth and elevation, Panoptic can achieve 3D imaging. While there are numerous applications

for such joint communication and 3D imaging framework, mapping the sidelobe perturbations in azimuth and elevation to 3D fingerprints requires further exploration that we leave for future work.

LOS Blockage and Compatibility with Existing Protocols. When the direct path is blocked or unavailable for communication, Panoptic relies on the strongest NLOS path for communication as suggested by conventional protocols . In such a case, we can detect other NLOS paths in the same way as discussed in the paper . Panoptic is compatible with existing protocols like IEEE 802.11ad and 3GPP by replacing directional beams in data transmission with compressive sidelobe beams, which enables reflector sensing during communication at the same time, frequency and using the same hardware resources.

VII. CONCLUSION

This paper presents Panoptic, a novel system architecture for integrated mmWave communication and sensing that share time, frequency, and hardware resources. Panoptic’s foundation lies on a unique beam manipulation technique realized by antenna subset modulation using a single RF-chain mmWave array. We introduce compressive sidelobe radiation, a novel beam pattern that simultaneously supports a stable high-gain communication link as well as pseudorandom sidelobe perturbations enabling NLOS sensing. Our extensive over-the-air experiments using commercial 60 GHz arrays demonstrate a mean NLOS angle estimation error of below 1.3° without compromising accurate symbol extraction. This work paves the way for true joint communication and sensing in mmWave wireless networks.

ACKNOWLEDGMENT

This work was supported in part by the National Science Foundation (grant 2148271) and by the Center for Ubiquitous Connectivity (CUBiC), sponsored by Semiconductor Research Corporation (SRC) and Defense Advanced Research Projects Agency (DARPA) under the JUMP 2.0 program.

REFERENCES

- [1] J. Chakareski, M. Khan, T. Ropitault, and S. Blandino, “Millimeter wave and free-space-optics for future dual-connectivity 6dof mobile multi-user vr streaming,” *ACM Transactions on Multimedia Computing, Communications and Applications*, vol. 19, no. 2, pp. 1–25, 2023.
- [2] D. Zhang, B. Han, P. Pathak, and H. Wang, “Innovating multi-user volumetric video streaming through cross-layer design,” in *Proceedings of the 20th ACM Workshop on Hot Topics in Networks*, 2021, pp. 16–22.
- [3] H. Liu, K. Cui, K. Hu, Y. Wang, A. Zhou, L. Liu, and H. Ma, “mtranssee: Enabling environment-independent mmwave sensing based gesture recognition via transfer learning,” *Proceedings of the ACM on Interactive, Mobile, Wearable and Ubiquitous Technologies*, vol. 6, no. 1, pp. 1–28, 2022.
- [4] H. Liu, Y. Wang, A. Zhou, H. He, W. Wang, K. Wang, P. Pan, Y. Lu, L. Liu, and H. Ma, “Real-time arm gesture recognition in smart home scenarios via millimeter wave sensing,” *Proceedings of the ACM on interactive, mobile, wearable and ubiquitous technologies*, vol. 4, no. 4, pp. 1–28, 2020.
- [5] X. Zhang, Z. Li, and J. Zhang, “Synthesized millimeter-waves for human motion sensing,” in *Proceedings of the 20th ACM Conference on Embedded Networked Sensor Systems*, 2022, pp. 377–390.
- [6] I. Pefkianakis and K.-H. Kim, “Accurate 3d localization for 60 ghz networks,” in *Proceedings of the 16th ACM Conference on Embedded Networked Sensor Systems*, 2018, pp. 120–131.

- [7] A. Adhikari, H. Regmi, S. Sur, and S. Nelakuditi, "Mishape: Accurate human silhouettes and body joints from commodity millimeter-wave devices," *Proceedings of the ACM on Interactive, Mobile, Wearable and Ubiquitous Technologies*, vol. 6, no. 3, pp. 1–31, 2022.
- [8] H. Regmi, M. S. Saadat, S. Sur, and S. Nelakuditi, "Squigglemilli: Approximating sar imaging on mobile millimeter-wave devices," *Proceedings of the ACM on Interactive, Mobile, Wearable and Ubiquitous Technologies*, vol. 5, no. 3, pp. 1–26, 2021.
- [9] A. Paidimarri, A. Tzadok, S. G. Sanchez, A. Kludze, A. Gallyas-Sanhueza, and A. Valdes-Garcia, "Eye-beam: A mmwave 5g-compliant platform for integrated communications and sensing enabling ai-based object recognition," *IEEE Journal on Selected Areas in Communications*, 2024.
- [10] Y. Li, Z. Chen, J. Luo, and S. Banerjee, "Gemini: Integrating full-fledged sensing upon millimeter wave communications," *arXiv preprint arXiv:2407.04174*, 2024.
- [11] J. Pegoraro, J. O. Lacruz, T. Azzino, M. Mezzavilla, M. Rossi, J. Widmer, and S. Rangan, "Jump: Joint communication and sensing with unsynchronized transceivers made practical," *IEEE Transactions on Wireless Communications*, 2024.
- [12] M. Alrabeiah and A. Alkhateeb, "Deep learning for mmwave beam and blockage prediction using sub-6 ghz channels," *IEEE Transactions on Communications*, vol. 68, no. 9, pp. 5504–5518, 2020.
- [13] A. Graff, Y. Chen, N. González-Prelcic, and T. Shimizu, "Deep learning-based link configuration for radar-aided multiuser mmwave vehicle-to-infrastructure communication," *IEEE Transactions on Vehicular Technology*, vol. 72, no. 6, pp. 7454–7468, 2023.
- [14] J. A. Zhang, M. L. Rahman, K. Wu, X. Huang, Y. J. Guo, S. Chen, and J. Yuan, "Enabling joint communication and radar sensing in mobile networks—a survey," *IEEE Communications Surveys & Tutorials*, vol. 24, no. 1, pp. 306–345, 2021.
- [15] J. O. Lacruz, D. Garcia, P. J. Mateo, J. Palacios, and J. Widmer, "mm-flex: an open platform for millimeter-wave mobile full-bandwidth experimentation," in *Proceedings of the 18th International Conference on Mobile Systems, Applications, and Services*, 2020, pp. 1–13.
- [16] S. Jog, J. Wang, J. Guan, T. Moon, H. Hassanieh, and R. R. Choudhury, "{Many-to-Many} beam alignment in millimeter wave networks," in *16th USENIX Symposium on Networked Systems Design and Implementation (NSDI 19)*, 2019, pp. 783–800.
- [17] Y. Ghasempour, M. K. Haider, C. Cordeiro, D. Koutsonikolas, and E. Knightly, "Multi-stream beam-training for mmwave mimo networks," in *Proceedings of the 24th Annual International Conference on Mobile Computing and Networking*, 2018, pp. 225–239.
- [18] Y. Ghasempour, M. K. Haider, C. Cordeiro, and E. W. Knightly, "Multi-user multi-stream mmwave wlans with efficient path discovery and beam steering," *IEEE Journal on Selected Areas in Communications*, vol. 37, no. 12, pp. 2744–2758, 2019.
- [19] H. Hassanieh, O. Abari, M. Rodriguez, M. Abdelghany, D. Katabi, and P. Indyk, "Fast millimeter wave beam alignment," in *Proceedings of the 2018 Conference of the ACM Special Interest Group on Data Communication*, 2018, pp. 432–445.
- [20] D. Garcia, J. O. Lacruz, P. J. Mateo, and J. Widmer, "Polar: Passive object localization with ieee 802.11 ad using phased antenna arrays," in *IEEE INFOCOM 2020-IEEE Conference on Computer Communications*. IEEE, 2020, pp. 1838–1847.
- [21] I. K. Jain, R. Subbaraman, and D. Bharadia, "Two beams are better than one: Towards reliable and high throughput mmwave links," in *Proceedings of the 2021 ACM SIGCOMM 2021 Conference*, 2021, pp. 488–502.
- [22] J. Pegoraro, J. O. Lacruz, M. Rossi, and J. Widmer, "Sparses: A sparse recovery approach for integrated communication and human sensing in mmwave systems," in *2022 21st ACM/IEEE International Conference on Information Processing in Sensor Networks (IPSN)*. IEEE, 2022, pp. 79–91.
- [23] "Ieee standard for information technology–telecommunications and information exchange between systems–local and metropolitan area networks–specific requirements–part 11: Wireless lan medium access control (mac) and physical layer (phy) specifications amendment 3: Enhancements for very high throughput in the 60 ghz band," *IEEE Std 802.11ad-2012 (Amendment to IEEE Std 802.11-2012, as amended by IEEE Std 802.11ae-2012 and IEEE Std 802.11aa-2012)*, pp. 1–628, 2012.
- [24] L. Jiao, P. Wang, A. Alipour-Fanid, H. Zeng, and K. Zeng, "Enabling efficient blockage-aware handover in ris-assisted mmwave cellular networks," *IEEE Transactions on Wireless Communications*, vol. 21, no. 4, pp. 2243–2257, 2021.
- [25] Y. Yang, F. Gao, X. Tao, G. Liu, and C. Pan, "Environment semantics aided wireless communications: A case study of mmwave beam prediction and blockage prediction," *IEEE Journal on Selected Areas in Communications*, vol. 41, no. 7, pp. 2025–2040, 2023.
- [26] J. Guan, A. Paidimarri, A. Valdes-Garcia, and B. Sadhu, "3-d imaging using millimeter-wave 5g signal reflections," *IEEE Transactions on Microwave Theory and Techniques*, vol. 69, no. 6, pp. 2936–2948, 2021.
- [27] C. Yu, Y. Sun, Y. Luo, and R. Wang, "mmlert: mmwave link blockage prediction via passive sensing," *IEEE Wireless Communications Letters*, 2023.
- [28] C. B. Barneto, S. D. Liyanaarachchi, T. Riihonen, L. Anttila, and M. Valkama, "Multibeam design for joint communication and sensing in 5g new radio networks," in *ICC 2020-2020 IEEE International Conference on Communications (ICC)*. IEEE, 2020, pp. 1–6.
- [29] C. B. Barneto, T. Riihonen, S. D. Liyanaarachchi, M. Heino, N. González-Prelcic, and M. Valkama, "Beamformer design and optimization for joint communication and full-duplex sensing at mm-waves," *IEEE Transactions on Communications*, vol. 70, pp. 8298–8312, 2022.
- [30] Q. Xue, C. Ji, S. Ma, J. Guo, Y. Xu, Q. Chen, and W. Zhang, "A survey of beam management for mmwave and thz communications towards 6g," *IEEE Communications Surveys & Tutorials*, 2024.
- [31] Q. Yang, H. Wu, Q. Huang, J. Zhang, H. Chen, W. Li, X. Tao, and Q. Zhang, "Side-lobe can know more: Towards simultaneous communication and sensing for mmwave," *Proceedings of the ACM on Interactive, Mobile, Wearable and Ubiquitous Technologies*, vol. 6, no. 4, pp. 1–34, 2023.
- [32] A. Tang, S. Li, and X. Wang, "Self-interference-resistant ieee 802.11 ad-based joint communication and automotive radar design," *IEEE Journal of Selected Topics in Signal Processing*, vol. 15, no. 6, pp. 1484–1499, 2021.
- [33] P. Kumari, M. E. Eltayeb, and R. W. Heath, "Sparsity-aware adaptive beamforming design for ieee 802.11 ad-based joint communication-radar," in *2018 IEEE Radar Conference (RadarConf18)*. IEEE, 2018, pp. 0923–0928.
- [34] I. P. Roberts, J. G. Andrews, and S. Vishwanath, "Hybrid beamforming for millimeter wave full-duplex under limited receive dynamic range," *IEEE Transactions on Wireless Communications*, vol. 20, no. 12, pp. 7758–7772, 2021.
- [35] I. P. Roberts, Y. Zhang, T. Osman, and A. Alkhateeb, "Real-world evaluation of full-duplex millimeter wave communication systems," *IEEE Transactions on Wireless Communications*, 2024.
- [36] I. P. Roberts and S. Vishwanath, "Beamforming cancellation design for millimeter-wave full-duplex," in *2019 IEEE Global Communications Conference (GLOBECOM)*. IEEE, 2019, pp. 1–6.
- [37] M. E. Rasekh, M. Abdelghany, U. Madhow, and M. Rodwell, "Phase noise in modular millimeter wave massive mimo," *IEEE Transactions on Wireless Communications*, vol. 20, no. 10, pp. 6522–6535, 2021.
- [38] D. Ramasamy, S. Venkateswaran, and U. Madhow, "Compressive parameter estimation in awgn," *IEEE Transactions on Signal Processing*, vol. 62, no. 8, pp. 2012–2027, 2014.
- [39] M. E. Rasekh and U. Madhow, "On the design of low-resolution sensing matrices for noncoherent compressive channel estimation," in *2022 56th Asilomar Conference on Signals, Systems, and Computers*. IEEE, 2022, pp. 543–547.
- [40] S. Semiconductors. (2024) Evaluation kit evk06002. [Online]. Available: <https://www.sivers-semiconductors.com/5g-millimeter-wave-mmwave-and-satcom/wireless-products/evaluation-kits/evaluation-kit-evk06002/>
- [41] T. A. Thomas, M. Cudak, and T. Kovarik, "Blind phase noise mitigation for a 72 ghz millimeter wave system," in *2015 IEEE International Conference on Communications (ICC)*. IEEE, 2015, pp. 1352–1357.
- [42] O. Delafrooz Noroozi, H. Guo, R. Shen, Z. Shao, H. Chen, K. Sengupta, Y. Ghasempour, and U. Madhow, "Zero-shot accurate mmwave antenna array calibration in the wild," in *Proceedings of the 30th Annual International Conference on Mobile Computing and Networking*, 2024, pp. 1938–1945.