

# Control of Humanoid Robots with Parallel Mechanisms using Kinematic Actuation Models

Victor Lutz<sup>1,\*</sup>, Ludovic De Matteis<sup>1,2</sup>, Virgile Batto<sup>1,3</sup> Nicolas Mansard<sup>1,4</sup>

**Abstract**—Inspired by the mechanical design of Cassie, several recently released humanoid robots are using actuator configuration in which the motor is displaced from the joint location to optimize the leg inertia. This in turn induces a non-linearity in the reduction ratio of the transmission which is often neglected when computing the robot motion (e.g. by trajectory optimization or reinforcement learning) and only accounted for at control time. This paper proposes an analytical method to efficiently handle this non-linearity. Using this actuation model, we demonstrate that we can leverage the dynamic abilities of the non-linear transmission while only modeling the inertia of the main serial chain of the leg, without approximating the motor capabilities nor the joint range. Based on analytical inverse kinematics, our method does not need any numerical routines dedicated to the closed-kinematics actuation, hence leading to very efficient computations. Our study focuses on two mechanisms widely used in recent humanoid robots; the four-bar knee linkage as well as a parallel 2 DoF ankle mechanism. We integrate these models inside optimization based (DDP) and learning (PPO) control approaches. A comparison of our model against a simplified model that completely neglects closed-chains is then shown in simulation.

## I. INTRODUCTION

Many recent advances in biped locomotion resulted from new hardware development. Companies and laboratories designing humanoid and biped robots tend to shift toward serial-parallel architecture (see Fig. 1), especially in the leg design. These architectures allow lower foot effective inertia, reduced limb weight and better impact absorption [1] [2], opening the possibility for more dynamic movements at the cost of more complex modeling and control.

The majority of the impressive results on these platforms have been obtained by decoupling the motion generation, done by only modeling the serial kinematics, from the actuator dynamics, accounted for only at control time using dedicated numerical routines, often given by the manufacturer.

This decoupling then enables to apply the recent progress in either Whole Body Model Predictive Control (WB-MPC) [3] and Reinforcement Learning (RL) [4] to control humanoid robots. Applying WB-MPC requires an accurate computation of the robot dynamics to optimize online a

This work is supported by ROBOTEX 2.0 (ROBOTEX ANR-10-EQPX-0044 and TIRREX ANR-21-ESRE-0015), ANITI (ANR-19-P3IA-0004), by the French government (INEXACT ANR-22-CE33-0007 and "Investissements d'avenir" ANR-19-P3IA-0001) (PRAIRIE 3IA Institute), and by the Louis Vuitton ENS Chair on Artificial Intelligence

<sup>1</sup> Gepetto, LAAS-CNRS, Université de Toulouse, France

<sup>2</sup> Inria, École normale Supérieure, PSL Research University, Paris, France

<sup>3</sup> Auctus, Inria, centre de l'université de Bordeaux, Talence, France

<sup>4</sup> Artificial and Natural Intelligence Toulouse Institute, France

\* Corresponding author: [victor.lutz@laas.fr](mailto:victor.lutz@laas.fr)

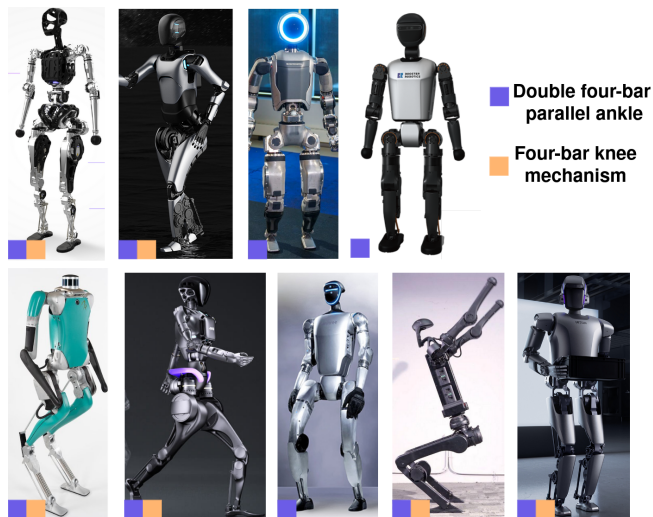

Fig. 1: Recent humanoids using parallel architectures. From top-left to bottom-right: Adam, A2, Atlas, T1, Digit V2, GR1, G1, H1, Walker S1 (Non exhaustive list)

sequence of control signals. Libraries such as Pinocchio [5] and RBDL [6], based on the work of Featherstone [7] allow fast computation of such dynamics. On the other hand, RL relies on a performant simulator to model the robot behavior and learn a policy, usually offline. Most modern RL approaches use GPU based simulators such as PhysicX [8], MuJoCo XLA (MJX) [9], Bullet or Brax to perform robot simulation. However, support for closed-chain mechanisms remains unavailable, incomplete, or comes with limitations in these simulators and libraries. Whether MPC or RL is used, the motion is often computed in the joint space, and a low level layer, dedicated for the robot is in charge of converting it to the actuator space at control time. As we will show in the experiments, this leads to underestimate either the joint range or the actuator capabilities which hinder the capabilities of the robot to reach more dynamic movements.

Recent advancements have been made to more tightly couple the modeling of the serial chain with the actuation. A first method consists in approximating the robot model by a simpler fully serial model [2], [10] and delegating the conversion from computed joint torques into motor torques to the low level controller. This approach allows the direct usage of well-known WB-MPC and RL methods with the simpler serial dynamics [11], [12]. A first study have shown that a simplification of this type could decrease the computation time without leading to significant errors [13]. Yet, their

comparison relied only on a leg extension motion and no further study have extended this work in the case of dynamic walking and jumping. An alternative method, consists in considering a complete dynamic of the model, with the kinematics closures modeled using loop-closure constraints [14]–[17]. However, this suffers from higher dimensionality and higher amount of constraints, which causes high computational burden, making it difficult to run on real hardware. In RL, to the best of our knowledge, the only GPU-implemented simulator able to handle closed-kinematics is Isaac Sim, at the cost of simulation performance. For this reason, this approach is not widely used in robot learning. Liang et al. [18] propose an intermediate simplification that neglect joint acceleration in parallel mechanism, and argue that this creates minor difference with the full dynamics model. They apply their method in an WB-MPC setting and they show dynamic walking and disturbance rejection on a real robot. This might be a fruitful direction for more complex robots. Yet, when the robot inertias are mostly carried in a main serial chain, such an approach leads to excessive computation times which we propose to drastically reduce.

In this paper, we derive analytical models of the geometric and kinematic mappings of the closed-loop transmissions composing many modern robot architecture, as well as their analytical derivatives. This allows us to get a mapping from motor positions and torques to the joints positions and torques of the underlying serial chain. We propose a method to apply this mapping inside the decision making algorithm (WB-MPC and RL) to enable a detailed study on the effects of the simplification and on the benefits of accounting for the closed-loop transmission. We show that our method leads to increased robot performance by leveraging the entirety of the closed-loop transmission while maintaining a low complexity thanks to the use of the underlying serial chain. In particular, this allows us to take advantage of the variable reduction ratio induced by the transmission, enabling more complex motions and performing tasks with wider ranges. This also enables more precise and more realistic joints limits, preventing the use of too conservative constraints. We present the application and performances of our method in a WB-MPC setting and extend it to use to RL.

The contributions in this paper are presented in the following order. First, in Sec. II, we present unified calculation of the geometric and kinematic mapping (so called Actuation models) for the knee and ankle mechanism and we compute the derivatives of these mappings for their efficient use in Trajectory Optimization. Then, in Sec. III, we explain how we applied this method for trajectory optimization. Finally, in Sec. IV, we demonstrate the capabilities of our approach through an experimental comparison against a classical serial approximation and present its application in Reinforcement Learning.

## II. METHOD

We consider a robot composed of a main serial chain (carrying most of the inertia) whose motors actuate the joints through closed-loop linkages (See Fig. 2 for an example of

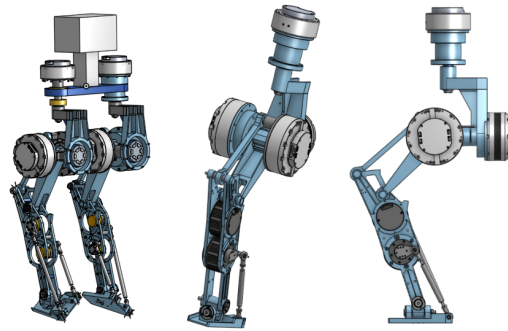

Fig. 2: Our Serial-parallel robot architecture

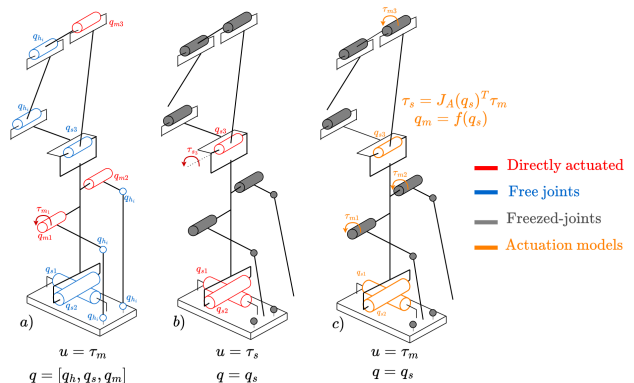

Fig. 3: Variation of closed-loop models. a) The *Closed-Kinematics* models the entire chain and controls the motors, b) The *Minimal Serial* model relies on an underlying serial chain and controls the serial joints torques, c) The *Actuated Serial* model (ours) uses the same serial chain but control the serial joints torques through a kinematic actuation model.

such architecture, also similar to H1 [19], Adam [20] or Atlas [21]). While the most accurate model would consider the complete closed-loop kinematics (Fig. 3 - Left), many of the results on these robots have been obtained by neglecting the actuator mechanics (Fig. 3 - Center). Rather than handling the complexity of the full model, we propose an intermediate solution, depicted in Fig. 3 - right. In this section, we first provide the equations for the knee joint configuration (1 DoF) before extending it to the ankle (2 DoF). We then derive it to obtain the Actuation Jacobian (first order) and the transmission dynamics (second order) which are needed for derivative-based trajectory optimization.

### A. Direct Geometry

1) *Four bars linkages*: We first consider a simple planar four-bars linkage transmission, present in many modern robots such as in the knee of H1 [22] or in the ankle of Talos [23]. Fig. 4 presents a view of the mechanism where we denote  $q_m$  the motor joint configuration and  $q_s$  the joint in the *Minimal Serial* model associated to this motor motion.

To be able to model the complete robot dynamic from the only knowledge of the serial joints, we need to find the

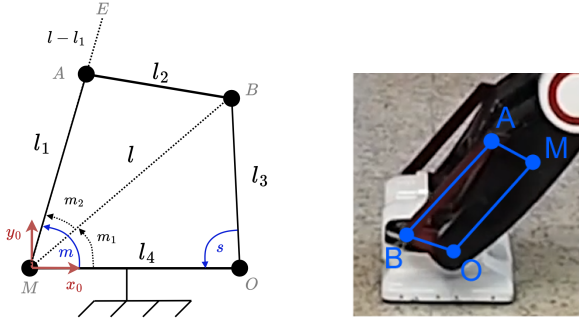

Fig. 4: Planar 4-bar mechanism, with the serial link rotating around O, of angle  $q_s$ , motor rotating around M of angle  $q_m$ , B the attachment of the linkage on the lower limb and A the joint of the closed-loop linkage. A concrete example is given on the right (ankle of the Talos robot)

mapping  $f$  such that:

$$q_m \triangleq f(q_s) \quad (1)$$

We will denote  $b \in \mathbb{R}^2$  the coordinate vector of point B, in the motor frame,  $l = \|b\|$  its norm,  $m_2$  the angle between the lines  $(MB)$  and  $(MA)$ , and  $(r, \bar{r}) = (\cos(m_2), \sin(m_2))$ . Applying Al-Kashi theorem (law of cosines) yields:

$$r = \frac{l^2 + l_1^2 - l_2^2}{2ll_1} \quad (2)$$

Then, the angle  $q_m = \widehat{OMA}$  can be obtained by summing  $m_1 = \widehat{OMB}$  and  $m_2 = \widehat{BMA} = \widehat{BME}$ :

$$m_1 = \text{atan2}(y_b, x_b) \quad (3)$$

$$m_2 = \text{acos}(r) = \text{acos}\left(\frac{l^2 + l_1^2 - l_2^2}{2ll_1}\right) \quad (4)$$

This gives that the motor configuration  $q_m = m_1 + m_2$  is a function of the position of the point B. In the motor frame, we can write  $b(q_s) = [l_4 + l_3 \cos(s), l_3 \sin(s)]$  or directly express it as the forward kinematics of the serial chain.

$$b(q_s) = fk(q_s) \quad (5)$$

Then we can express the motor configuration as a function of the serial joint configuration:

$$q_m = f(q_s) \quad (6)$$

2) *Intricate four bars linkages*: A more complex mechanism consists in two intricate four-bar linkages, permitting the coupled control of two DoF using two motors, which can be observed in the ankles of H1, G1, GR1, Digit, T1. A schematic representation of this mechanism is presented in Fig. 5. While the mechanism is not planar, each side of it can be projected into a virtual planar four-bar mechanism contained in the plane orthogonal to the motor joint and going through the linkage point A.

We now consider  $b \in \mathbb{R}^3$ , and denote  $\bar{b} = [b_x, b_y, 0]^T$  the projection of the point in the plane generated by the motor joint. Let us note  $l_1 = \|\vec{AB}\|$ ,  $l_2 = \|\vec{AC}\|$  and  $\bar{l}_2^2 =$

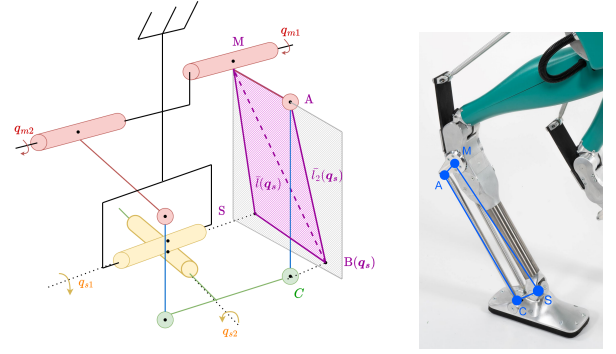

Fig. 5: Sub projected planar four-bar from the ankle in purple. A concrete example is given on the right (ankle of the Digit robot)

$l_2^2 - b_z^2$  the projected length. We now take  $r = \frac{l^2 + l_1^2 - \bar{l}_2^2}{2ll_1}$ . By doing so, we get a virtual planar four-bar mechanism that obey to similar equations and gives a relation between the motor configuration  $q_{m1}$  and the ankle configuration  $q_s = (q_{s1} \ q_{s2})^T$ . Applying this method on both sides of the mechanism yields a relation of the form

$$q_m = \begin{pmatrix} q_{m1} \\ q_{m2} \end{pmatrix} = f(q_s) \quad (7)$$

This relation generalizes the four-bar linkage (as it is its own projection) and from now we will use this notation for both mechanisms.

### B. Actuation Jacobian

To control the serial joints using the motor control, we need to get a relation between the motor torques  $\tau_m$  and the serial joints torques  $\tau_s$ . To obtain such a relation, we compute the so called **actuation Jacobian**  $J_A$ , function of  $q_s$  that satisfies the relations:

$$\begin{aligned} \dot{q}_m &= J_A(q_s) \dot{q}_s \\ \tau_s &= J_A(q_s)^T \tau_m \end{aligned} \quad (8)$$

In this section, we will specifically focus on the intricate four-bar mechanism and proceed by first considering the effect of a single motor on the serial joints, before summing the contributions of the two motors. We arbitrary choose to derive the equations for  $\tau_{m1}$  and write  $\tau_{s[\tau_{m1}]}$  the serial torques it induces and  $J_{A1}$  the corresponding Actuation Jacobian. The derivations for  $\tau_{s[\tau_{m1}]}$  do not add any additional complexity. Computing the derivative of the mapping  $f$  with respect to  $q_s$  gives

$$\frac{dq_{m1}}{dq_s} = \frac{df(q_s)}{dq_s} \triangleq J_{A1}(q_s) \quad (9)$$

To apply the chain rule, we develop the dependencies of the mapping  $f(q_s) = m_1(b(q_s)) + m_2(r(l(b)))$ . Using the chain rule, we get

$$\frac{dq_{m1}}{dq_s} = \frac{dm_1}{db} \frac{\partial b}{\partial q_s} + \frac{dm_2}{dr} \frac{dr}{dl} \frac{dl}{db} \frac{\partial b}{\partial q_s} \quad (10)$$

We will note  $\frac{db}{dq_s} = B_s$  and generally compute it using the derivatives of the forward kinematics, implemented in Pinocchio [24]. The other terms are given by

$$\frac{dm_1}{db} = \frac{1}{l^2} \begin{pmatrix} -y_b & x_b & 0 \end{pmatrix} = b^T \begin{bmatrix} 0 & 1/l^2 & 0 \\ -1/l^2 & 0 & 0 \\ 0 & 0 & 0 \end{bmatrix} \quad (11)$$

Introducing the notation  $r' = \frac{dr}{dl} = \frac{1}{l_1} - \frac{r}{l}$ , we can directly compute the second term as

$$\frac{dm_2}{db} = \frac{dm_2}{dr} \frac{dr}{dl} \frac{dl}{db} = \frac{l_1 r - l}{\bar{r} l^2 l_1} b^T \quad (12)$$

$$\frac{dm_2}{db_z} = \frac{dm_2}{dr} \frac{dr}{dl_2} \frac{dl_2}{db_z} = \frac{-1}{\bar{r} l l_1} \quad (13)$$

This yields

$$\frac{dq_{m_1}}{db} = \frac{dm_1}{db} + \frac{dm_2}{db} = b^T \underbrace{\begin{bmatrix} \mu & \nu & 0 \\ -\nu & \mu & 0 \\ 0 & 0 & \xi \end{bmatrix}}_K \quad (14)$$

where  $\mu = \frac{r l_1 - l}{\bar{r} l^2 l_1}$ ,  $\nu = \frac{1}{l^2}$  and  $\xi = \frac{-1}{\bar{r} l l_1}$ .

It follows:

$$J_{A1}(q_s) = b(q_s)^T K(r(q_s), l(q_s)) B_s(q_s) \quad (15)$$

For the intricate four-bar (i.e. the ankle transmission),  $B_s \in \mathbb{R}^{3 \times 2}$ . This gives that  $J_{A1}$  is a scalar for the four-bar mechanism (and equals  $J_A$ ) but an element of  $\mathbb{R}^{1 \times 2}$  for each side of the ankle. For the full ankle, we denote

$$J_A = \begin{bmatrix} J_{A1} \\ J_{A2} \end{bmatrix} \quad (16)$$

We then obtain the actuation model

$$\tau_s = J_A^T(q_s) \tau_m \quad (17)$$

### C. Actuation derivatives

In order to use our *Actuated Serial* model (cf Fig. 3) within a derivative-based motion planning algorithm such as DDP (cf Sec. III-C), we need to obtain the derivatives of the dynamics with respect to states and controls. The derivatives of the serial dynamics are well known [25]. However, the derivatives of the actuation model with respect to the control  $\frac{\partial \tau_s}{\partial u}$  and states  $\frac{\partial \tau_s}{\partial x}$  are missing. Our approach control directly controls the motor torques, giving  $u = \tau_m$ , with the relation (17). The derivative with respect to  $u$  is direct:

$$\frac{\partial \tau_s}{\partial u} = J_A^T \quad (18)$$

The model state is the serial joints configuration and velocity  $x = x_s = [q_s, \dot{q}_s]$ , we then compute the derivative in two parts  $\frac{\partial \tau_s}{\partial q_s}$  and  $\frac{\partial \tau_s}{\partial \dot{q}_s}$ , with

$$\frac{\partial \tau_s}{\partial \dot{q}_s} = 0 \quad (19)$$

Differentiating  $\tau_s$  with respect to the configuration  $q_s$  is more involved, since the product rule naturally involve tensorial elements. We will again proceed by separating the Actuation Jacobian into two parts  $J_{A1}$  and  $J_{A2}$  and focus on the

first term. Let us differentiate this product by rewriting it differently:

$$\tau_{s[\tau_{m_1}]} = J_{A1}^T \tau_{m_1} = B_s^T f \quad (20)$$

where  $f = K^T b \tau_{m_1}$  corresponds to the force applied by the motor 1 on the point B. Deriving this relation gives

$$\frac{\partial \tau_{s[\tau_{m_1}]}}{\partial q_s} = \frac{\partial B_s^T f}{\partial q_s} \Big|_{f=cste} + B_s^T \frac{\partial f}{\partial b} B_s \quad (21)$$

Let us the derivative of  $K$  with respect to  $l$ , scalar variable.

$$K' = \frac{dK}{dm_2} \frac{dm_2}{dl} + \frac{dK}{dl} \quad (22)$$

$$K' = \begin{bmatrix} \mu_{m_2} dm_2/dl + \mu_l & \nu_l \\ -\nu_l & \mu_{m_2} dm_2/dl \end{bmatrix}$$

where

$$\mu_{m_2} = \frac{r l - l_1}{\bar{r}^2 l^2 l_1} \quad (23)$$

$$\mu_l = \frac{l - 2r l_1}{\bar{r}^2 l^3 l_1} \quad (24)$$

$$\nu_l = \frac{-2}{l^3} \quad (25)$$

$$\frac{dm_2}{dl} = \frac{r l_1 - l}{\bar{r} l l_1} \quad (26)$$

The gives the derivative of  $f$  with respect to  $b$

$$\frac{df}{db} = \tau_{m_1} (K^T + \frac{1}{l} K'^T b b^T) \quad (27)$$

We finally get:

$$\frac{d\tau_{s[\tau_{m_1}]}}{dq_s} = B_{ss}^T f + B_s^T (K'^T \frac{1}{l} b b^T + K^T) B_s \tau_{m_1} \quad (28)$$

We can recover the dependency from each motor by summing their influence to the final derivative:

$$\frac{d\tau_s}{dq_s} = \sum_i \frac{d\tau_{s[\tau_{m_i}]}}{dq_s} \quad (29)$$

With  $i \in \{1\}$  for the four-bar,  $i \in \{1, 2\}$  for the ankle transmission. For the four-bar,  $B_{ss}$  is a  $3 \times 1$  vector, however, in the intricate four bar,  $B_{ss}$  represents a third-order tensor that is difficult to manipulate. However, we only need to evaluate  $B_{ss}^T f$ , a matrix, we can directly use the spatial algebra implemented in Pinocchio [5] to avoid manipulating tensor elements.

## III. IMPLEMENTATION

### A. Robot model

We implemented our strategy on the Bipetto walker, showcased in Fig. 6, whose model is available in open-source [26]. The robot is composed of a four-bar transmission, similar to the one of Talos ankle, for the knee joint and of an intricate four-bars transmission for the ankle, following the inspiration of Digit, H1 and others. We define an *Approximate Serial* model of the robot by freezing the joints corresponding to the closed-loop transmission and adding fictive actuation in the serial joints. This results in a model with 6 actuated DoF per leg.

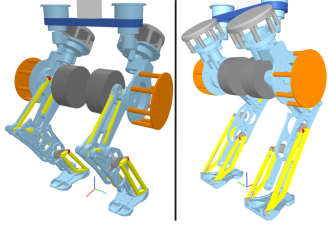

Fig. 6: Projected four-bars on the robot model, displayed in yellow

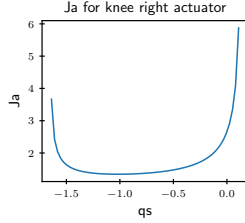

Fig. 7: Variable transmission ratio  $J_A(q_s)$  for the knee of our robot architecture, i.e. a four-bar architecture

### B. Actuation models

We represent in Fig. 6, in yellow, the four-bar linkages used in the computation of our actuation model. The Actuation Jacobians for our robot architecture are represented in 7 and 8 for the knee and ankle respectively. Note that the variable reduction ratio for each mechanism increases when the closed-loop linkage gets closer to singularities, i.e. for the bent and stretched legs.

### C. Trajectory Optimization

We seek for a solution of the motion generation problem formulated as a multiple shooting whole body Optimal Control Problem (OCP), i.e. we solve for controls  $u[k]$  and states  $x[k]$  at each time step  $k$  [27]. This classical transcribes

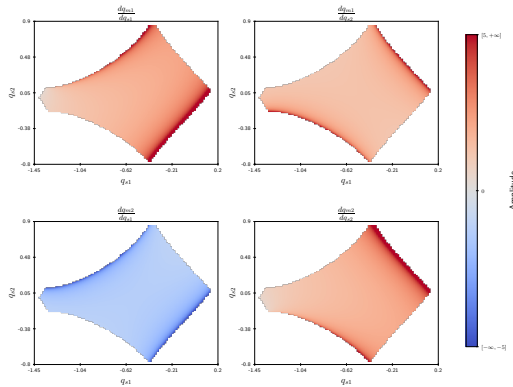

Fig. 8: Variable transmission ratio  $J_A(q_s)$  for the ankle of our robot architecture. The four parts represent the influence of motors 1 (top) et 2 (bottom) on the two serial DoF (left and right)

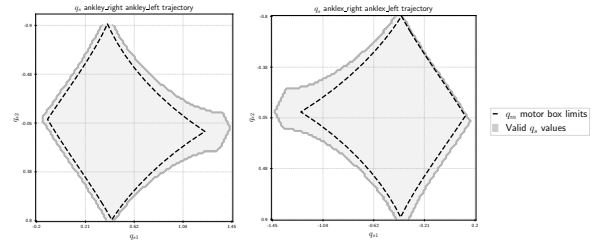

Fig. 9: Ankle motor angles box limits

as a Non-Linear Program (NLP)

$$\begin{aligned} \min_{u, x} \quad & \sum_k^{N-1} l_k(x[k], u[k]) + l_N(x[N]) \\ \text{s.t.} \quad & \forall k \in \llbracket 0, N-1 \rrbracket \quad x[k+1] = f_k(x[k], u[k]) \end{aligned} \quad (30)$$

where  $l_k$  defines the running costs,  $l_N$  the terminal cost, and  $f_k$  is the dynamics defining state evolution. In our method, the dynamics is the one of the *Minimal Serial* system with joint torques defined as  $J_A^T u[k]$  so that we control the system using directly the motor torques, i.e.  $u[k] = \tau_m[k]$ , even in the presence of closed-loop transmissions. We solve it with a multiple shooting approach, using the DPP algorithm. The problem is written and solved using the Crocoddyl library [28], relying on Pinocchio [5] for dynamics computation. Thanks to our approach, the joint torques used in the dynamic computation now depend on the controls  $u[k]$  through a the actuation model described before, and yielding a variable reduction ratio. Our formulation also allow to set limits on motor torques directly, which would not be possible otherwise for the ankle mechanism as it relies on coupled motors. To solve the OCP (30) using the FDDP algorithm, we need the derivatives of the dynamics with respect to the states and controls. The derivatives implemented in Pinocchio, allow us the compute the derivatives of the serial dynamics  $f_k(x[k], \tau_s[k])$  with respect to  $x[k]$  and  $\tau_s[k]$  but do not account for possible dependence of  $\tau_s[k]$  on the states. Through our actuation model, we get  $\tau_s[k] = \tau_s(x[k], u[k])$  and thus need to add the corresponding additional derivatives. The feasible region in the configuration space for our mechanism is not a box neither for the serial joints nor the motor joints. However, as we found (9), setting ankle motor box limits on motor angles  $q_m$  allow us to cover a large range of our feasible space, as opposed to box constraints on the serial joints. Thanks to the actuation models, we can set some box constraints on the ankle joints.

$$q_m \leq f(q_s) \leq \overline{q_m} \quad (31)$$

We implemented a flat and rough terrain walk, as well as a star climbing problem which were done to push the robot close to his joint limits. The cost terms in the cost functions are standard, inspired from [29].

We compare the results with the minimal simplified model, where  $u = \tau_s$ , which we turn a posteriori into motor torques using the following relation  $\tau_m = (J_A^T)^\dagger \tau_s$ , (when this trajectory is feasible), with  $A^\dagger$  the pseudo inverse of  $A$  [30].

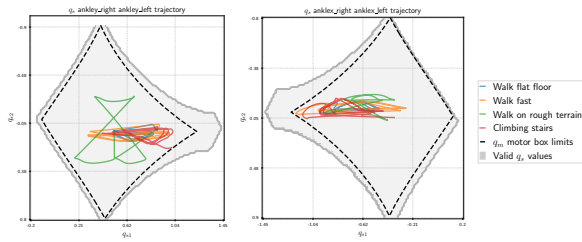

Fig. 10: Ankle  $q_s(t)$  for walking on flat floor (slowly and fast), walking on rough terrain, climbing stairs.

#### D. Reinforcement Learning

We implemented bipedal locomotion in Reinforcement Learning (RL) using the Isaac Lab framework [11]. Since we relied on Pinocchio to compute  $b$  that runs on CPU, and to avoid CPU computations in RL, we use CasADi [31] to generate Pinocchio routines, which are then compiled into CUDA code via CusADi [32]. The mapping  $q_m = f(q_s)$  is fully parallelized in CUDA/PyTorch and supports batched robot evaluations for training. For efficiency,  $J_A(q_s)$  is precomputed offline as lookup tables and loaded into GPU VRAM. We define the policy optimization problem with the following rewards:

$$R_{q_m} = \omega_{q_m} \sum_i [-\min(0, f(q_s) - \underline{q_m}) + \max(0, f(q_s) - \overline{q_m})] \quad (32)$$

$$R_{\tau_m} = \omega_{\tau_m} \sum_i [-\min(0, J_A(q_s)^{-T} \tau_s - \underline{\tau_m}) + \max(0, J_A(q_s)^{-T} \tau_s - \overline{\tau_m})] \quad (33)$$

where  $\omega_{q_m}, \omega_{\tau_s} < 0$  are set to penalize unfeasible motor angles and torques, respectively. A natural direction for future work will be to apply our method to learn a policy that generates motor commands directly, rather than serial commands, as demonstrated in our trajectory optimization approach. This would require an inverse mapping (i.e. getting serial configuration from motors position) as mentioned in Appendix I.

### IV. RESULTS

#### A. Trajectory Optimization

We first perform various tasks to assess the applicability of our method and demonstrate the limits of the *Minimal Serial Model*. We perform a walk on a flat terrain at a constant target Center of Mass velocity of 0.7m/s (equivalent to 8km/h walk for a human sized robot). On this movement, the *Actuated Serial Model*, that accounts for the closed-loop transmission in the optimization, and the *Minimal Serial model*, that optimizes on serial joints torques that are then converted into motor controls, yield similar results.

However, advancing to walk on rough terrain and climbing stairs, more demanding movements for the ankle, show a first divergence between models. Fig. 10 presents the trajectories of the left and right ankles joints, with 2 DoF per ankle and opposes it to the limits of the actuation model, discussed

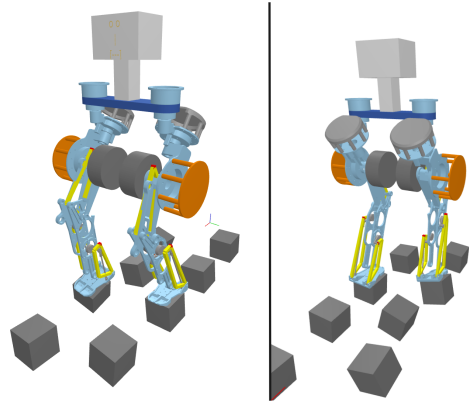

Fig. 11: Rough terrain walking

in Sec. III-C. We observe that it is not possible to define limits on the serial joints (that would result in a straight square limit in Fig 10) that would not be detrimental for the robot motions. Indeed, clamping the serial joints range to allow walking on flat floor would prevent configuration yet necessary to walk on rough terrains or to climb high stairs. On the opposite, setting bounds that allow all the motions demonstrated here, would also allow the ankle to reach a configuration not feasible for the real mechanism. Our approach can successfully exploit this range by stating the limits in the actuator space, resulting in more permissive, yet feasible, serial limits. The different movements can be seen in the companion video.

#### B. Reinforcement Learning

Using the RL implementation presented before, we were able to deploy a walking policy that effectively respects feasible domains, ensuring not only that the robot configuration remains feasible but also that the motor torques required to generate the movements remain in the limits. We validated the learned policy in MuJoCo [9], to ensure that the policy is feasible and has not been overfitted to Isaac Sim. The walking movements are reported in the companion video. This result highlight the potential of the method in handling a wide range of operational scenarios, even beyond restrictive limits on serial joints. It demonstrates that we can include the closed-loop transmission effect in the learning process. We hope that such approach can help reducing the simulation to reality gap but getting a more accurate representation of the robot capabilities during the learning phase. This opens the way for future works to study policies with direct motor configuration output instead of relying on the low level controller to convert serial joint configuration into motor controls.

### V. CONCLUSION

In this paper, we proposed to extend both MPC and RL locomotion to robots with closed-kinematic actuators, with minimal computation burden. Our method relies on deriving a model of the closed-loop transmission for classical mechanisms, allowing the control of a reduced model of the

robot while modeling the transmission effects. We proposed the derivatives of this actuation model to use it in an derivative based optimal control solver. We propose a complete implementation based on the open-source solver Crocodyl. To validate our method, we developed a benchmark for comparing the motions obtained using an serial model that ignores the closed-loop transmission against motions obtained with our *Actuated Serial* model. We showed that the *Actuated Serial* model allows a wider range of motion compared to the serial model without the actuation model, as it can account for more complex serial joints limits by writing them directly in the actuation space. We demonstrated that our method applies to a Reinforcement Learning setting, by training a locomotion policy that can account for the closed-loop transmission and its inherent variable actuation ratio, taking full advantage of the robot capabilities.

## REFERENCES

- [1] V. Batto, T. Flayols, N. Mansard, and M. Vulliez, "Comparative metrics of advanced serial/parallel biped design and characterization of the main contemporary architectures," Aug. 2023.
- [2] D. Mronga, S. Kumar, and F. Kirchner, "Whole-Body Control of Series-Parallel Hybrid Robots," in *2022 International Conference on Robotics and Automation (ICRA)*, (Philadelphia, PA, USA), pp. 228–234, IEEE, May 2022.
- [3] S. Katayama, M. Murooka, and Y. Tazaki, "Model predictive control of legged and humanoid robots: models and algorithms," *Advanced Robotics*, vol. 37, pp. 1–18, Feb. 2023.
- [4] R. P. Singh, Z. Xie, P. Gergondet, and F. Kanehiro, "Learning Bipedal Walking for Humanoids With Current Feedback," *IEEE Access*, vol. 11, pp. 82013–82023, 2023.
- [5] J. Carpentier, G. Saurel, G. Buondonno, J. Mirabel, F. Lamiroux, O. Stasse, and N. Mansard, "The Pinocchio C++ library – A fast and flexible implementation of rigid body dynamics algorithms and their analytical derivatives," Jan. 2019.
- [6] "RBDL: an efficient rigid-body dynamics library using recursive algorithms | Request PDF," *ResearchGate*, Dec. 2024.
- [7] R. Featherstone, *Rigid Body Dynamics Algorithms*. Boston, MA: Springer US, 2008.
- [8] V. Makoviychuk, L. Wawrzyniak, Y. Guo, M. Lu, K. Storey, M. Macklin, D. Hoeller, N. Rudin, A. Allshire, A. Handa, and G. State, "Isaac Gym: High Performance GPU-Based Physics Simulation For Robot Learning," Aug. 2021. arXiv:2108.10470 [cs].
- [9] E. Todorov, T. Erez, and Y. Tassa, "MuJoCo: A physics engine for model-based control," in *2012 IEEE/RSJ International Conference on Intelligent Robots and Systems*, pp. 5026–5033, Oct. 2012. ISSN: 2153-0866.
- [10] J. Eßer, S. Kumar, H. Peters, V. Bargsten, J. Fernández, C. Mastalli, O. Stasse, and F. Kirchner, *Design, analysis and control of the series-parallel hybrid RH5 humanoid robot*. Jan. 2021.
- [11] M. Mittal, C. Yu, Q. Yu, J. Liu, N. Rudin, D. Hoeller, J. L. Yuan, R. Singh, Y. Guo, H. Mazhar, A. Mandlekar, B. Babich, G. State, M. Hutter, and A. Garg, "Orbit: A unified simulation framework for interactive robot learning environments," *IEEE Robotics and Automation Letters*, vol. 8, no. 6, pp. 3740–3747, 2023.
- [12] "unitreerobotics/unitree\_rl\_gym," Feb. 2025. original-date: 2023-10-11T07:24:59Z.
- [13] S. Kumar, J. Martensen, A. Mueller, and F. Kirchner, "Model Simplification For Dynamic Control of Series-Parallel Hybrid Robots - A Representative Study on the Effects of Neglected Dynamics Shivesh," in *2019 IEEE/RSJ International Conference on Intelligent Robots and Systems (IROS)*, pp. 5701–5708, Nov. 2019. ISSN: 2153-0866.
- [14] J. Carpentier, R. Budhiraja, and N. Mansard, "Proximal and Sparse Resolution of Constrained Dynamic Equations," in *Robotics: Science and Systems XVII*, Robotics: Science and Systems Foundation, July 2021.
- [15] S. Sovukluk, J. Engelsberger, and C. Ott, "Whole Body Control Formulation for Humanoid Robots with Closed/Parallel Kinematic Chains: Kangaroo Case Study," in *2023 IEEE/RSJ International Conference on Intelligent Robots and Systems (IROS)*, pp. 10390–10396, Oct. 2023. ISSN: 2153-0866.
- [16] E. M. Hoffman, A. Curti, N. Miguel, S. K. Kothakota, A. Molina, A. Roig, and L. Marchionni, "Modeling and Numerical Analysis of Kangaroo Lower Body based on Constrained Dynamics of Hybrid Serial-Parallel Floating-Base Systems," Feb. 2024. arXiv:2312.04161 [cs].
- [17] B. Zhang and R. Vasudevan, "Rapid and Robust Trajectory Optimization for Humanoids," Dec. 2024. arXiv:2409.00303 [cs].
- [18] Y. Liang, F. Yin, Z. Li, Z. Xiong, Z. Peng, Y. Zhao, and W. Yan, "Reduced-Dimensional Whole-Body Control Based on Model Simplification for Bipedal Robots With Parallel Mechanisms," *IEEE Robotics and Automation Letters*, vol. 10, pp. 1696–1703, Feb. 2025. Conference Name: IEEE Robotics and Automation Letters.
- [19] "unitree\_sdk2/example/h1 at main · unitreerobotics/unitree\_sdk2."
- [20] "PNDbotics." Accessed on 2024-09-12.
- [21] "Boston dynamics - electri atlas." Accessed on 2025-02-28.
- [22] "Unitree - h1." Accessed on 2025-02-28.
- [23] O. Stasse, T. Flayols, R. Budhiraja, K. Giraud-Esclasse, J. Carpentier, J. Mirabel, A. Del Prete, P. Souères, N. Mansard, F. Lamiroux, *et al.*, "Talos: A new humanoid research platform targeted for industrial applications," *2017 IEEE-RAS 17th International Conference on Humanoid Robotics (Humanoids)*, pp. 689–695, 2017.
- [24] J. Carpentier and N. Mansard, "Analytical Derivatives of Rigid Body Dynamics Algorithms," in *Robotics: Science and Systems (RSS 2018)*, (Pittsburgh, United States), June 2018.
- [25] Shubham Singh, R. Russell, and Patrick M. Wensing, "Efficient Analytical Derivatives of Rigid-Body Dynamics Using Spatial Vector Algebra," *IEEE Robotics and Automation Letters*, 2021.
- [26] "Example parallel robots: a repository containing several urdf models of legged robots with parallel kinematics - on github."
- [27] M. Diehl, H. G. Bock, H. Diedam, and P.-B. Wieber, "Fast direct multiple shooting algorithms for optimal robot control," in *Fast motions in biomechanics and robotics: optimization and feedback control*, pp. 65–93, Springer, 2006.
- [28] C. Mastalli, R. Budhiraja, W. Merkt, G. Saurel, B. Hammoud, M. Naveau, J. Carpentier, L. Righetti, S. Vijayakumar, and N. Mansard, "Crocodyl: An Efficient and Versatile Framework for Multi-Contact Optimal Control," in *2020 IEEE International Conference on Robotics and Automation (ICRA)*, (Paris, France), pp. 2536–2542, IEEE, May 2020.
- [29] E. Dantec, M. Naveau, P. Fernbach, N. Villa, G. Saurel, O. Stasse, M. Taix, and N. Mansard, "Whole-Body Model Predictive Control for Biped Locomotion on a Torque-Controlled Humanoid Robot," in *2022 IEEE-RAS 21st International Conference on Humanoid Robots (Humanoids)*, pp. 638–644, Nov. 2022. ISSN: 2164-0580.
- [30] A. Ben-Israel and T. N. Greville, *Generalized inverses: theory and applications*. Springer Science & Business Media, 2006.
- [31] J. A. E. Andersson, J. Gillis, G. Horn, J. B. Rawlings, and M. Diehl, "CasADi – A software framework for nonlinear optimization and optimal control," *Mathematical Programming Computation*, 2018.
- [32] S. H. Jeon, S. Hong, H. J. Lee, C. Khazoom, and S. Kim, "CusADi: A GPU Parallelization Framework for Symbolic Expressions and Optimal Control," Aug. 2024. arXiv:2408.09662 [cs].

## APPENDIX I

### TRANSFER ON THE REAL SYSTEM

In a MPC or RL setting, the actual  $q_s$  angles from the robot are needed. On the real system, motor encoders provide only  $q_m$ , requiring the inverse mapping  $f^{-1}$  to recover  $q_s$ . For the four-bar mechanism,  $f^{-1}$  has an analytical form, but for the more complex ankle mechanism, it does not. In both cases, we estimate  $q_s$  via numerical optimization:

$$q_s = f^{-1}(q_m) = \min_{q_s} |f(q_s) - q_m|^2 \quad (34)$$

State continuity over time provides accurate warm starts, enabling rapid convergence in just a few steps with minimal computation.