

Optimizing the frequency positioning of tunable couplers in a circuit QED processor to mitigate spectator effects on quantum operations

S. Vallés-Sanclemente,¹ T. H. F. Vroomans,¹ T. R. van Abswoude,² F. Brulleman,³ T. Stavenga,³
S. L. M. van der Meer,¹ Y. Xin,¹ A. Lawrence,² V. Singh,^{1,*} M. A. Rol,² and L. DiCarlo¹

¹*QuTech and Kavli Institute of Nanoscience, Delft University of Technology, P.O. Box 5046, 2600 GA Delft, The Netherlands*

²*Orange Quantum Systems, Elektronicaweg 2, 2628 XG Delft, The Netherlands*

³*Quantware B.V., Elektronicaweg 10, 2628 XG Delft, The Netherlands*

(Dated: March 18, 2025)

We experimentally optimize the frequency of flux-tunable couplers in a superconducting quantum processor to minimize the impact of spectator transmons during quantum operations (single-qubit gates, two-qubit gates and readout) on other transmons. We adapt a popular transmon-like tunable-coupling element, achieving high-fidelity, low-leakage controlled-Z gates with unipolar, fast-adiabatic pulsing only on the coupler. We demonstrate the ability of the tunable coupler to null residual ZZ coupling as well as exchange couplings in the one- and two-excitation manifolds. However, the nulling of these coherent interactions is not simultaneous, prompting the exploration of tradeoffs. We present experiments pinpointing spectator effects on specific quantum operations. We also study the combined effect on the three types of operations using repeated quantum parity measurements.

Residual quantum interactions between qubits are a key source of crosstalk in multi-qubit processors. In particular, spectator (i.e., inactive) qubits during single-qubit gates, two-qubit gates and readout of other qubits can introduce state-dependent errors. In legacy circuit QED processors employing transmons coupled via fixed-frequency resonators, a dominant residual interaction is ZZ coupling, which adds a Hamiltonian term

$$\delta H = \hbar \xi_{ZZ}^{ij} |1_i 1_j\rangle \langle 1_i 1_j|,$$

making the qubit transition frequency of transmon Q_i dependent on the state of Q_j , and viceversa. (Here, \hbar is the reduced Planck constant and numbers indicate energy excitation level.) It is not uncommon for the coupling strength $|\xi_{ZZ}|/(2\pi)$ to reach MHz-level for some pairs [1], due to limited frequency targeting. Post-fabrication frequency trimming methods have allowed taming $|\xi_{ZZ}|/(2\pi)$ to the ~ 100 kHz range in many cases [2].

Exchange interactions in the one- and two-excitation manifolds are strong, adding Hamiltonian terms

$$\begin{aligned} \hbar J_1^{ij} |0_i 1_j\rangle \langle 1_i 0_j| + \text{h.c.}, \\ \hbar J_2^{ij} |1_i 1_j\rangle \langle 0_i 2_j| + \text{h.c.}, \end{aligned}$$

with coupling strengths $J_{1,2}/(2\pi)$ typically at the 10 – MHz level. Only large detuning $|\Delta| \gg J$ between the coupled levels limits their impact.

In recent years, significant effort has focused on the development of flux-tunable couplers to mitigate these interactions [3–19]. A popular approach uses flux-tunable transmon-like elements [20–49], with variants including floating [34, 39], grounded [32] and chiplet-linking configurations [41]. A characteristic of this approach is that ξ_{ZZ} , J_1 and J_2 can all be nulled, provided the coupled transmons lie in the straddling regime where the qubit ($|0\rangle - |1\rangle$) transition of one transmon is flanked by the qubit and leakage ($|1\rangle - |2\rangle$) transitions of

the other. Crucially though, ξ_{ZZ} , J_1 and J_2 cannot be simultaneously nulled at the same frequency positioning of the coupler. This fact motivates the question: what tunable coupler positioning is best to mitigate the impact of spectator transmons on the fidelity of quantum operations (readout, single- and two-qubit gates) performed on other transmons [32]?

In this Letter, we experimentally address this question using a 5-transmon prototype of our tunable-coupler-based processor architecture under development. After mapping out the dependence of ξ_{ZZ} , J_1 and J_2 on coupler frequency, we first find that spectator effects on single-qubit gates are strongly mitigated over a wide range of coupler positioning, spanning both $\xi_{ZZ} = 0$ and $J_1 = 0$, but not $J_2 = 0$. However, for readout, nulling J_1 or J_2 is advantageous: it avoids the excitation exchange activated by measurement-induced spectral overlap between transitions of coupled transmons. To also consider the impact of spectators on two-qubit gates, we first consider several options for realizing controlled-Z (CZ) gates, converging on unipolar, fast-adiabatic flux pulsing only on the tunable coupler, achieving CZ error $\epsilon_{CZ} < 1\%$ with leakage $L_1 \approx 0.05\%$. Our final experiment studies the combined effect of spectators on readout, single- and two-qubit gates in a minimal setting relevant for quantum error correction (QEC): repeated weight-2 parity checks, which yield a baseline defect rate of $\sim 12\%$. By repeatedly toggling a spectator, we observe that the defect rate is lowest with the coupler bias in a region that includes $\xi_{ZZ} = 0$, while it degrades at $J_1 = 0$ and $J_2 = 0$. For ultimate performance, it may be worthwhile to dynamically switch coupler positioning for readout and gate operations, taking advantage of the fast flux tunability already in place.

Our device consists of five flux-tunable transmon qubits in a starfish configuration, with central transmon Q_0 connected to four corner transmons (Q_1 – Q_4) via dedicated, also flux-tunable couplers C_{0i} (Please see [50] for device parameters and performance characteristics). Numerical simulations show that the targeted coupling strengths, $g_{qq}/(2\pi) = 6$ MHz

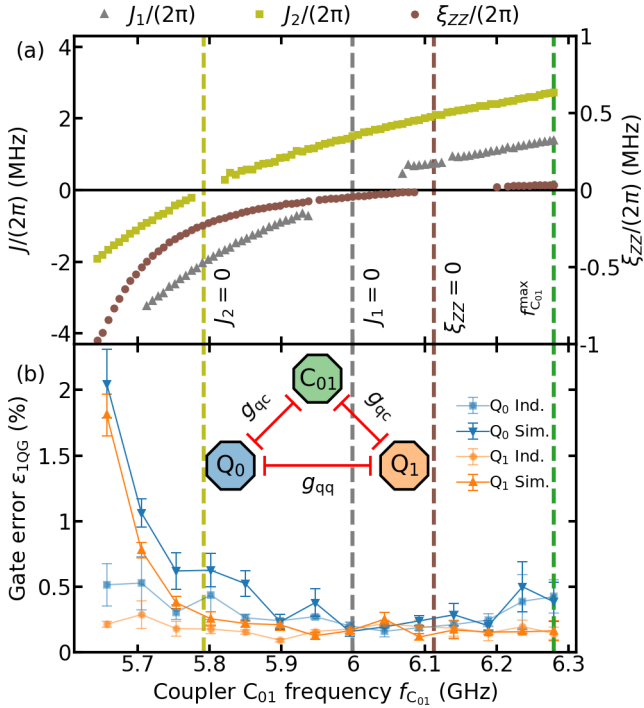

FIG. 1. Single-qubit gate performance as a function of tunable coupler frequency. (a) J_1 , J_2 and ξ_{ZZ} between Q_1 and Q_0 as a function of coupler C_{01} frequency. Vertical grey, golden and brown lines indicate the C_{01} frequencies at which J_1 , J_2 and ξ_{ZZ} are nulled, respectively. (b) Single-qubit gate errors on Q_0 and Q_1 , measured using simultaneous and individual randomized benchmarking, as a function of C_{01} frequency. Error bars are the standard deviation of the mean computed from 10 repetitions. Inset: Schematic of the sub-system formed by Q_1 , Q_0 and C_{01} .

and $g_{qc}/(2\pi) = 70$ MHz [50], can null ξ_{ZZ} with the transmons in the so-called straddling regime and the coupler positioned ~ 700 MHz above the qubit transition frequencies. In this device, we find all coupled transmon pairs in the straddling regime with all biased at their simultaneous sweetspot, making this the clear choice of bias point for transmons as it maximizes qubit coherence.

We start our study by mapping the dependence of ξ_{ZZ} , J_1 and J_2 on coupler bias frequency. Figure 1(a) shows example results for pair (Q_1, Q_0) (see [50] for similar results for the other pairs). We measure ξ_{ZZ} using a modified echo sequence [51] and J_1 (J_2) by spectroscopy of the $|0_1 1_0\rangle - |1_1 0_0\rangle$ ($|1_1 1_0\rangle - |0_1 2_0\rangle$) avoided crossing reached by flux biasing Q_0 (Q_1) away from sweetspot. Decoherence limits the ability of both methods to accurately extract these quantities at their zero crossings. When necessary, we rely on simple polynomial fits to exact the C_{01} frequencies at which they are nulled. The results clearly illustrate that the three residual interaction strengths can be nulled, but not simultaneously.

We first focus on single-qubit gates, studying the impact of C_{01} bias frequency on the individual and simultaneous single-

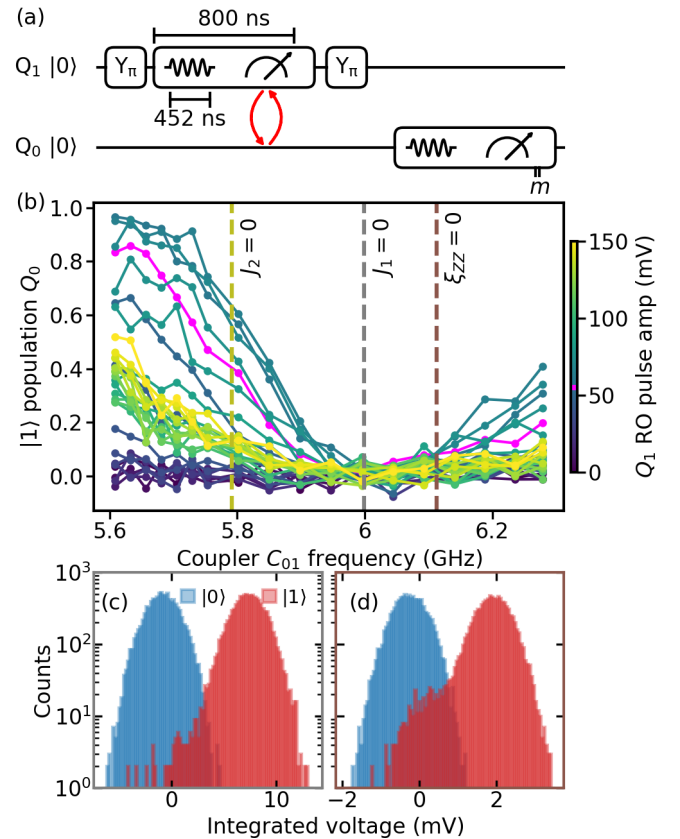

FIG. 2. Measurement-induced population exchange. (a) Experiment used to study population exchange from Q_0 to Q_1 during readout of Q_0 . (b) Population of Q_1 as a function of C_{01} frequency and amplitude of the Q_0 readout pulse. The pink trace shows the data acquired with the chosen amplitude [50]. (c) Single-shot readout (SSRO) characterization for Q_0 at $J_1 = 0$, yielding $\epsilon_{RO} = 0.8\%$. (d) Similar characterization at $\xi_{ZZ} = 0$ and using identical readout parameters, yielding $\epsilon_{RO} = 2.5\%$.

qubit gate performance of Q_1 and Q_0 [Fig. 1(b)]. Individual single-qubit randomized benchmarking (RB) with the other transmon kept in $|0\rangle$ provides a baseline single-qubit native gate error of $\sim 0.2\%$ across most of the 650 MHz range covered in C_{01} . We attribute the increase observed at the lower end of C_{01} frequency to increased transmon dephasing due to hybridization with the coupler and increased sensitivity of the bare coupler to $1/f$ flux noise [50]. Simultaneous performance matches individual performance over a wide C_{01} range, including $\xi_{ZZ}^{01} = 0$ and $J_1^{01} = 0$. A degradation is observed in simultaneous performance by $J_2 = 0$. Note that the C_{01} sweetspot limits our ability to extensively cover the $\xi_{ZZ}^{01} > 0$ regime. This is intentional: we strategically targeted couplers to have sweetspots just above $\xi_{ZZ}^{01} = 0$ to avoid unnecessarily comprising on their coherence.

During this above study, we observed that $\xi_{ZZ}^{01} = 0$ is not the optimal choice for readout. Specifically, at this C_{01} bias, we found it impossible to achieve an average assignment error [52] $\epsilon_{RO} < 2.5\%$ for Q_0 , whose qubit transition frequency

is above that of Q_1 . The underlying physical reason is population exchange $|1_00_1\rangle \rightarrow |0_00_1\rangle$ activated during readout: photons injected to the Q_0 readout mode cause a Stark shift of Q_0 , displacing its qubit transition downward in frequency and broadening its linewidth [53], causing spectral overlap with Q_1 . Similar physics has been used to explain enhanced qubit relaxation during readout, caused by Stark-shift activated exchange with lower-frequency two-level defects [54]. Figure 2 evidences the phenomenon and offers a mitigation strategy, showing the loss of excitation from Q_0 to Q_1 as a function of both Q_0 readout pulse amplitude and C_{01} bias. Population exchange is strongly suppressed in a C_{01} frequency range centered around $J_1^{01} = 0$, where $\epsilon_{RO} < 1\%$ is reached for Q_0 with a total readout duration of 800 ns (including photon depletion). As all coupled transmon pairs have $\xi_{ZZ}/(2\pi) < 100$ kHz at $J_1 = 0$, and in consideration of Fig. 1, it seems tempting to choose this bias as the default for all couplers. However, it remains important to first study spectator effects on two-qubit gates before reaching conclusions.

To this end, we must now choose an implementation of CZ gates drawing inspiration from prior work on similar tunable-coupling architectures [26, 28, 32–34, 39] (Fig. 3). A general controlled-phase gate can be implemented by dynamically detuning the coupler, controllably increasing ξ_{ZZ} until the target conditional phase is acquired [26, 28, 33]. We study the conditional phase and missing fraction (a proxy for leakage) [55] of pair (Q_2, Q_0) in response to a unipolar, fast-adiabatic pulse [56] on C_{02} and a square pulse to the lower-frequency transmon Q_2 , both of duration 60 ns. The conditional-phase landscape displays a contour of 180° , the required phase for CZ. We select four points along this contour to evaluate the performance of CZ gates using interleaved RB with modifications to quantify leakage [57, 58]. The best performance is achieved when Q_2 remains at sweetspot (i.e., only the coupler is pulsed), where we extract a CZ gate error $\epsilon_{CZ} = (0.62 \pm 0.03)\%$ with leakage $L_1 = (0.051 \pm 0.014)\%$. Most likely, this choice maximizes fidelity because keeping Q_2 at sweetspot maximizes its coherence, as shown in Figs. 3(e-f). However, we did not perform detailed numerical simulation to dissect the contribution of different physical error sources to the error budget [51, 55].

We can now study the combined effect of spectators on readout, single- and two-qubit gates in a minimal setting relevant for QEC [59]. Specifically, we perform repeated indirect measurement of the parity operator X_2X_1 using Q_0 as ancilla and Q_4 as spectator (Fig. 4). We extract the defect rate up to 100 rounds as a function of C_{04} bias frequency without and with toggling spectator Q_4 in every round (similar results are obtained when using Q_3 as the spectator [50].) The defect rate at a given round is defined as the fraction of time that the declared parity outcome does not match that declared in the previous round. When Q_4 is not toggled, the defect rate is largely insensitive to C_{04} positioning, remaining $< 12\%$ over all bias positions and all rounds. In contrast, when Q_4 is toggled, the defect rate remains low and nearly round independent only near $\xi_{ZZ}^{04} = 0$. A slight degradation is ob-

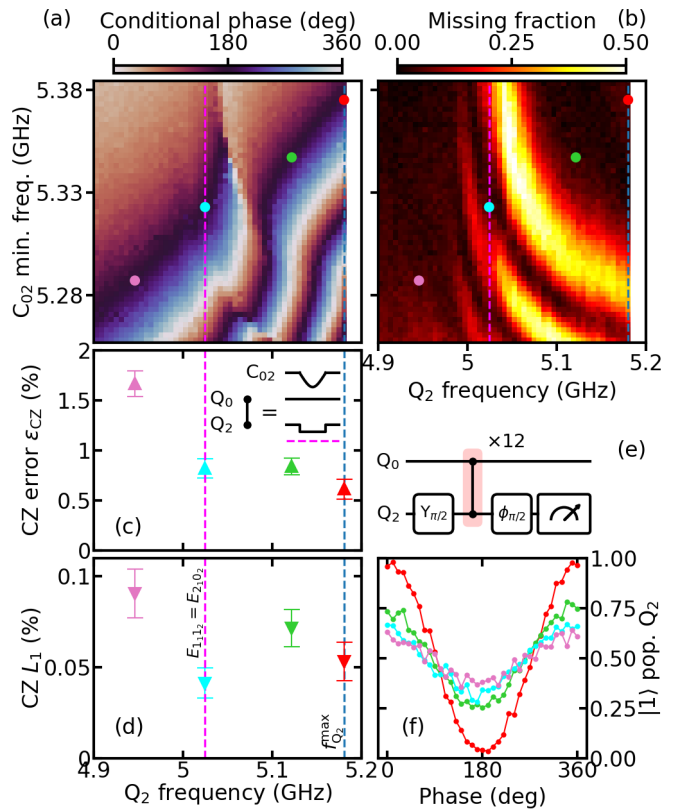

FIG. 3. Study of a CZ gate between Q_2 and Q_0 , implemented by applying a fast-adiabatic flux pulse to coupler C_{02} and a square pulse to the lower-frequency qubit, Q_2 . (a,b) Conditional phase and missing fraction extracted from conditional oscillation experiments. (c,d) CZ error and leakage measured using interleaved RB at four points along the contour of 180° conditional phase [colored markers in (a,b)]. Error bars are the standard deviation of the mean computed from 5 repetitions. The inset in (c) is a cartoon representation of frequency excursions of C_{02} , Q_0 and Q_2 . (e) Schematic of a simple experiment to study the impact that flux pulsing Q_2 during CZ gates has on its coherence. We embed 12 CZ gates in a Ramsey sequence on Q_2 . (f) Ramsey oscillations for the four chosen CZ settings, clearly showing that the impact on coherence is lowest when Q_2 remains at its sweetspot, as expected.

served by $J_1^{04} = 0$ (more noticeable when toggling Q_3 instead of Q_4 [50]). As $|\xi_{ZZ}^{04}|$ further increases, the defect rates rise, showing a positive slope toward a higher steady state with increasing rounds. This slope is a hallmark of leakage [31, 60] to higher-excited transmon states (of Q_0 in this case). Note that because the Q_0 qubit frequency is below that of Q_4 , no measurement-induced exchange is expected to take place in the one-excitation manifold. However, exchange can occur in the two-excitation manifold as $|1_41_0\rangle$ is Stark-shifted toward $|2_4, 0_0\rangle$ (In [50] we show that this effect is suppressed at the $J_2^{04} = 0$ bias). This effect could underlie the small increase in defect rate at $\xi_{ZZ} = 0$ observed when toggling Q_4 .

In summary, we have performed an experimental study

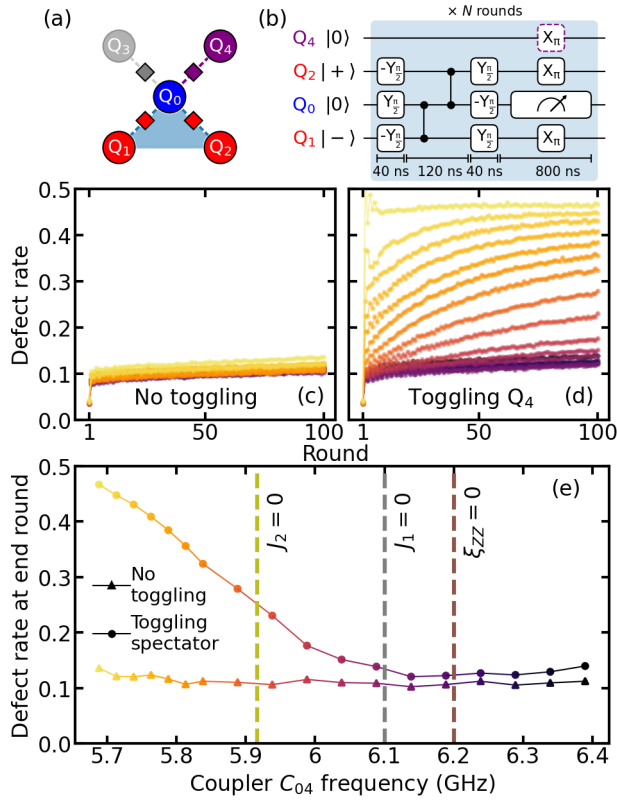

FIG. 4. Study of spectator effects during repeated parity checks. (a) Simplified schematic of the device with color coding to identify data qubits (Q_1 and Q_2 , red), ancilla (Q_0 , blue) and spectator (Q_4 , purple). (b) Quantum circuit realizing the indirect measurement of X_2X_1 parity using Q_0 as ancilla. (c) Defect rates measured over 100 rounds at different C_{04} frequencies (represented by the color scale), keeping spectator Q_4 in the ground state. (d) Defect rates measured now toggling Q_4 at every round. (e) Common plot of the defect rate at round 100 for data in (c) and (d). Vertical lines mark the $\xi_{ZZ}^{04} = 0$, $J_1^{04} = 0$ and $J_2^{04} = 0$ coupler bias points.

to identify the best frequency positioning of flux-tunable, transmon-like couplers to mitigate spectator effects on quantum operations in a circuit QED processor. We show that this type of tunable coupler can null ZZ and exchange couplings, but not simultaneously. For single-qubit gates, spectator effects are minimized at a coupler bias region that spans $J_1 = 0$ and $\xi_{ZZ} = 0$. For two-qubit gates, the spectator defect rate study suggests that $\xi_{ZZ} = 0$ is the preferable bias configuration. For readout, however, spectator effects are only minimized at $J_1 = 0$ ($J_2 = 0$) when the measured transmon is above (below) the coupled spectator. Consequently, it could prove beneficial to dynamically switch between nulling conditions for different quantum operations, taking advantage of the fast flux tunability already in place and calibrated for two-qubit gates. Moving forward, it will also be important to further test our device architecture and spectator-effect mitigation strategies on larger devices, for example the 17-transmon, 24-coupler processor required for the distance-3 surface code [42, 61, 62], where all transmons couple to ei-

ther two, three, or four nearest neighbors. It is also interesting to explore alternative tunable-coupling strategies with the capability to simultaneously null ZZ and exchange interactions [63].

DATA AVAILABILITY

The data for all figures in main text and supplement are available online at <http://github.com/DiCarloLab-Delft/SpectatorEffectsTunableCouplers>. Requests for additional materials should be addressed to LDC (l.dicarlo@tudelft.nl).

ACKNOWLEDGEMENTS

We thank S. Dobrovolskiy and G. Limodio of QuantWare for fabricating the device, F. Battistel, A. Radhakrishnan and R. Navarathna of Qblox for assistance with electronics, H. Ali for insightful discussions, and V. Sinha for project management assistance. We are grateful to G. Calusine and W. Oliver for providing the traveling-wave parametric amplifier used in the amplification chain. This research is funded by the Netherlands Organization for Scientific Research (NWA.1292.19.194), Quantum Delta NL (DiagnostiQ and National Growth Fund KAT-1), the Allowance for Top Consortia for Knowledge and Innovation (TKI) of the Dutch Ministry of Economic Affairs, the European Union Flagship on Quantum Technology (OpenSuperQplus100, No. 101113946), and Intel Corporation.

AUTHOR CONTRIBUTIONS

SVS and LDC conceptualized the experimental study. SVS performed the experiment with contributions from THFV, TRA, AL and MAR. SVS performed the data analysis with contributions from THFV, SLMM and YX. SVS, THFV and LDC designed the Hamiltonian parameters of device, with contributions from VS. TS and FB designed the device layout to target these parameters. SVS and LDC wrote the manuscript with contributions from TS and FB, with feedback from all coauthors. LDC supervised the project.

CONFLICTS OF INTERESTS

The authors declare no conflict of interests.

* Present address: A*STAR Quantum Innovation Centre (Q.InC), Institute of Materials Research and Engineering (IMRE),

Agency for Science, Technology and Research (A*STAR), 2 Fusionopolis Way, 08-03, Singapore, Republic of Singapore

- [1] J. F. Marques, B. M. Varbanov, M. S. Moreira, H. Ali, N. Muthusubramanian, C. Zachariadis, F. Battistel, M. Beekman, N. Haider, W. Vlothuizen, A. Bruno, B. M. Terhal, and L. DiCarlo, *Nat. Phys.* **18**, 80 (2022).
- [2] E. J. Zhang, S. Srinivasan, N. Sundaresan, D. F. Bogorin, Y. Martin, J. B. Hertzberg, J. Timmerwilke, E. J. Pritchett, J.-B. Yau, C. Wang, W. Landers, E. P. Lewandowski, A. Narasgond, S. Rosenblatt, G. A. Keefe, I. Lauer, M. B. Rothwell, D. T. McClure, O. E. Dial, J. S. Orcutt, M. Brink, and J. M. Chow, *Sci. Adv.* **8**, eabi6690 (2022).
- [3] T. Hime, P. A. Reichardt, B. L. T. Plourde, T. L. Roberson, C.-E. Wu, A. V. Ustinov, and J. Clarke, *Science* **314**, 1427 (2006).
- [4] P. Bertet, C. Harmans, and J. Mooij, *Phys. Rev. B* **73**, 064512 (2006).
- [5] A. O. Niskanen, K. Harrabi, F. Yoshihara, Y. Nakamura, S. Lloyd, and J. S. Tsai, *Science* **316**, 723 (2007).
- [6] S. H. W. van der Ploeg, A. Izmalkov, A. M. van den Brink, U. Hübner, M. Grajcar, E. Il'ichev, H.-G. Meyer, and A. M. Zagoskin, *Phys. Rev. Lett.* **98**, 057004 (2007).
- [7] R. Harris, A. Berkley, M. Johnson, P. Bunyk, S. Govorkov, M. Thom, S. Uchaikin, A. Wilson, J. Chung, E. Holtham, *et al.*, *Phys. Rev. Lett.* **98**, 177001 (2007).
- [8] M. S. Allman, F. Altomare, J. D. Whittaker, K. Cicak, D. Li, A. Sirois, J. Strong, J. D. Teufel, and R. W. Simmonds, *Phys. Rev. Lett.* **104**, 177004 (2010).
- [9] R. Bialczak, M. Ansmann, M. Hofheinz, M. Lenander, E. Lucero, M. Neeley, A. O'Connell, D. Sank, H. Wang, M. Weides, *et al.*, *Phys. Rev. Lett.* **106**, 060501 (2011).
- [10] S. Srinivasan, A. Hoffman, J. Gambetta, and A. A. Houck, *Phys. Rev. Lett.* **106**, 083601 (2011).
- [11] Y. Yin, Y. Chen, D. Sank, P. J. J. O'Malley, T. C. White, R. Barends, J. Kelly, E. Lucero, M. Mariantoni, A. Megrant, C. Neill, A. Vainsencher, J. Wenner, A. N. Korotkov, A. N. Cleland, and J. M. Martinis, *Phys. Rev. Lett.* **110**, 107001 (2013).
- [12] B. Peropadre, D. Zueco, F. Wulschner, F. Deppe, A. Marx, R. Gross, and J. J. García-Ripoll, *Phys. Rev. B* **87**, 134504 (2013).
- [13] I.-C. Hoi, A. F. Kockum, T. Palomaki, T. M. Stace, B. Fan, L. Tornberg, S. R. Sathyamoorthy, G. Johansson, P. Delsing, and C. Wilson, *Phys. Rev. Lett.* **111**, 053601 (2013).
- [14] M. Pierre, I.-M. Svensson, S. Raman Sathyamoorthy, G. Johansson, and P. Delsing, *App. Phys. Lett.* **104**, 232604 (2014).
- [15] Y. Chen, C. Neill, P. Roushan, N. Leung, M. Fang, R. Barends, J. Kelly, *et al.*, *Phys. Rev. Lett.* **113**, 220502 (2014).
- [16] D. C. McKay, S. Filipp, A. Mezzacapo, E. Magesan, J. M. Chow, and J. M. Gambetta, *Phys. Rev. App.* **6**, 064007 (2016).
- [17] S. J. Weber, G. O. Samach, D. Hover, S. Gustavsson, D. K. Kim, A. Melville, D. Rosenberg, A. P. Sears, F. Yan, J. L. Yoder, *et al.*, *Phys. Rev. App.* **8**, 014004 (2017).
- [18] Y. Lu, S. Chakram, N. Leung, N. Earnest, R. K. Naik, Z. Huang, P. Groszkowski, E. Kapit, J. Koch, and D. I. Schuster, *Phys. Rev. Lett.* **119**, 150502 (2017).
- [19] M. Kounalakis, C. Dickel, A. Bruno, N. K. Langford, and G. A. Steele, *npj Quantum Inf.* **4**, 1 (2018).
- [20] J. Koch, T. M. Yu, J. Gambetta, A. A. Houck, D. I. Schuster, *et al.*, *Phys. Rev. A* **76**, 042319 (2007).
- [21] F. Yan, D. Campbell, P. Krantz, M. Kjaergaard, D. Kim, J. L. Yoder, D. Hover, A. Sears, A. J. Kerman, T. P. Orlando, S. Gustavsson, and W. D. Oliver, *Phys. Rev. Lett.* **120**, 260504 (2018).
- [22] S. Rosenblum, Y. Y. Gao, P. Reinhold, C. Wang, C. J. Axline, L. Frunzio, S. M. Girvin, L. Jiang, M. Mirrahimi, M. H. Devoret, *et al.*, *Nat. Commun.* **9**, 652 (2018).
- [23] Y. Y. Gao, B. J. Lester, K. S. Chou, L. Frunzio, M. H. Devoret, L. Jiang, S. Girvin, and R. J. Schoelkopf, *Nature* **566**, 509 (2019).
- [24] P. Mundada, G. Zhang, T. Hazard, and A. Houck, *Phys. Rev. Appl.* **12**, 054023 (2019).
- [25] F. Arute, K. Arya, R. Babbush, D. Bacon, J. C. Bardin, R. Barends, R. Biswas, S. Boixo, F. G. Brandao, D. A. Buell, *et al.*, *Nature* **574**, 505 (2019).
- [26] M. C. Collodo, J. Herrmann, N. Lacroix, C. K. Andersen, A. Remm, S. Lazar, J.-C. Besse, T. Walter, A. Wallraff, and C. Eichler, *Phys. Rev. Lett.* **125**, 240502 (2020).
- [27] B. Foxen, C. Neill, A. Dunsworth, P. Roushan, B. Chiaro, A. Megrant, J. Kelly, Z. Chen, K. Satzinger, R. Barends, *et al.*, *Phys. Rev. Lett.* **125**, 120504 (2020).
- [28] Y. Xu, J. Chu, J. Yuan, J. Qiu, Y. Zhou, L. Zhang, X. Tan, Y. Yu, S. Liu, J. Li, F. Yan, and D. Yu, *Phys. Rev. Lett.* **125**, 240503 (2020).
- [29] X. Li, T. Cai, H. Yan, Z. Wang, X. Pan, Y. Ma, W. Cai, J. Han, Z. Hua, X. Han, Y. Wu, H. Zhang, H. Wang, Y. Song, L. Duan, and L. Sun, *Phys. Rev. App.* **14**, 024070 (2020).
- [30] X. Han, T. Cai, X. Li, Y. Wu, Y. Ma, Y. Ma, J. Wang, H. Zhang, Y. Song, and L. Duan, *Phys. Rev. A* **102**, 022619 (2020).
- [31] Google Quantum A.I. *et al.*, *Nature* **595**, 383 (2021).
- [32] Y. Sung, L. Ding, J. Braumüller, A. Vepsäläinen, B. Kannan, M. Kjaergaard, A. Greene, G. O. Samach, C. McNally, D. Kim, A. Melville, B. M. Niedzielski, M. E. Schwartz, J. L. Yoder, T. P. Orlando, S. Gustavsson, and W. D. Oliver, *Phys. Rev. X* **11**, 021058 (2021).
- [33] J. Stehlik, D. M. Zajac, D. L. Underwood, T. Phung, J. Blair, S. Carnevale, D. Klaus, G. A. Keefe, A. Carniol, M. Kumph, M. Steffen, and O. E. Dial, *Phys. Rev. Lett.* **127**, 080505 (2021).
- [34] E. A. Sete, A. Q. Chen, R. Manenti, S. Kulkshreshtha, and S. Poletto, *Phys. Rev. App.* **15**, 064063 (2021).
- [35] Y. Ye, S. Cao, Y. Wu, X. Chen, Q. Zhu, S. Li, F. Chen, M. Gong, C. Zha, H.-L. Huang, *et al.*, *Chin. Phys. Lett.* **38**, 100301 (2021).
- [36] P. Zhao, Y. Zhang, G. Xue, Y. Jin, and H. Yu, *App. Phys. Lett.* **121**, 032601 (2022).
- [37] I. N. Moskaleiko, I. A. Simakov, N. N. Abramov, A. A. Grigorev, D. O. Moskalev, A. A. Pishchimova, N. S. Smirnov, E. V. Zikiy, I. A. Rodionov, and I. S. Besedin, *npj Quantum Inf.* **8**, 130 (2022).
- [38] H. Goto, *Phys. Rev. App.* **18**, 034038 (2022).
- [39] F. Marxer, A. Vepsäläinen, S. W. Jolin, J. Tuorila, A. Landra, C. Ockeloen-Korppi, W. Liu, O. Aho, A. Auer, L. Belzane, *et al.*, *PRX Quantum* **4**, 010314 (2023).
- [40] K. Kubo and H. Goto, *App. Phys. Lett.* **122**, 064001 (2023).
- [41] D. L. Campbell, A. Kamal, L. Ranzani, M. Senatore, and M. D. LaHaye, *Phys. Rev. App.* **19**, 064043 (2023).
- [42] Google Quantum A.I. *et al.*, *Nature* **614**, 676 (2023).
- [43] L. Ding, M. Hays, Y. Sung, B. Kannan, J. An, A. Di Paolo, A. H. Karamlou, T. M. Hazard, K. Azar, D. K. Kim, *et al.*, *Phys. Rev. X* **13**, 031035 (2023).
- [44] C. Križan, J. Biznárová, L. Chen, E. Hogedal, A. Osman, C. W. Warren, S. Kosen, H.-X. Li, T. Abad, A. Aggarwal, *et al.*, *arXiv:2412.15022* (2024).
- [45] K. Kubo, Y. Ho, and H. Goto, *Phys. Rev. App.* **22**, 024057 (2024).
- [46] Google Quantum A.I. *et al.*, *Nature* **638**, 920 (2025).
- [47] H.-T. Liu, B.-J. Chen, J.-C. Zhang, Y.-X. Xiao, T.-M. Li, K. Huang, Z. Wang, H. Li, K. Zhao, Y. Xu, *et al.*, *arXiv:2501.18319* (2025).
- [48] X. Zhang, X. Zhang, C. Chen, K. Tang, K. Yi, K. Luo, Z. Xie, Y. Chen, and T. Yan, *arXiv:2501.13646* (2025).

- [49] R. Li, K. Kubo, Y. Ho, Z. Yan, S. Inoue, Y. Nakamura, and H. Goto, [arXiv:2503.03053 \(2025\)](#).
- [50] See supplemental material for additional information supporting statements and claims made in the main text.
- [51] V. Negîrneac, H. Ali, N. Muthusubramanian, F. Battistel, R. Sagastizabal, M. S. Moreira, J. F. Marques, W. J. Vlothuizen, M. Beekman, C. Zachariadis, N. Haider, A. Bruno, and L. DiCarlo, [Phys. Rev. Lett. **126**, 220502 \(2021\)](#).
- [52] E. H. Chen, T. J. Yoder, Y. Kim, N. Sundaresan, S. Srinivasan, M. Li, *et al.*, [Phys. Rev. Lett. **128**, 110504 \(2022\)](#).
- [53] D. I. Schuster, A. Wallraff, A. Blais, L. Frunzio, R.-S. Huang, J. Majer, S. M. Girvin, and R. J. Schoelkopf, [Phys. Rev. Lett. **94**, 123602 \(2005\)](#).
- [54] T. Thorbeck, Z. Xiao, A. Kamal, and L. C. Govia, [Phys. Rev. Lett. **132**, 090602 \(2024\)](#).
- [55] M. A. Rol, F. Battistel, F. K. Malinowski, C. C. Bultink, B. M. Tarasinski, R. Vollmer, N. Haider, N. Muthusubramanian, A. Bruno, B. M. Terhal, and L. DiCarlo, [Phys. Rev. Lett. **123**, 120502 \(2019\)](#).
- [56] J. M. Martinis and M. R. Geller, [Phys. Rev. A **90**, 022307 \(2014\)](#).
- [57] E. Magesan, J. M. Gambetta, and J. Emerson, [Phys. Rev. A **85**, 042311 \(2012\)](#).
- [58] C. J. Wood and J. M. Gambetta, [Phys. Rev. A **97**, 032306 \(2018\)](#).
- [59] A. G. Fowler, M. Mariantoni, J. M. Martinis, and A. N. Cleland, [Phys. Rev. A **86**, 032324 \(2012\)](#).
- [60] M. McEwen, D. Kafri, Z. Chen, J. Atalaya, K. Satzinger, C. Quintana, P. V. Klimov, D. Sank, C. Gidney, A. Fowler, *et al.*, [Nat. Commun. **12**, 1 \(2021\)](#).
- [61] S. Krinner, N. Lacroix, A. Remm, A. Di Paolo, E. Genois, C. Leroux, *et al.*, [Nature **605**, 669 \(2022\)](#).
- [62] I. Besedin, M. Kerschbaum, J. Knoll, I. Hesner, L. Bodeker, L. Colmenarez, L. Hofele, N. Lacroix, C. Hellings, F. Swiadek, *et al.*, [arXiv:2501.04612 \(2025\)](#).
- [63] L. Heunisch, C. Eichler, and M. J. Hartmann, [Phys. Rev. App. **20**, 064037 \(2023\)](#).

SUPPLEMENTARY MATERIAL FOR “OPTIMIZING THE FREQUENCY POSITIONING OF TUNABLE COUPLERS IN A CIRCUIT QED PROCESSOR TO MITIGATE SPECTATOR EFFECTS ON QUANTUM OPERATIONS”

This supplementary material provides additional information supporting the claims and figures of the main text.

EXPERIMENTAL SETUP

The device used consists of 5 transmons in a starfish configuration, with 4 dedicated tunable couplers connecting the central transmon Q_0 to each of the 4 corner ones (Fig. S1). Every transmon has a dedicated microwave-drive line and flux-control line, as well as a dedicated pair of readout Purcell-filter resonators [S1] for independent readout via one common feedline. Tunable couplers have dedicated flux-control lines. The otherwise planar device, fabricated from a Ta base layer sputtered on a Si substrate, has Al crossovers and airbridges, including ‘shoelacing’ airbridges enabling post-fabrication frequency trimming of readout resonator and Purcell filters [S2].

The device is cooled in a Leiden Cryogenics CS81 dilution refrigerator with ~ 10 mK base temperature, fitted with standard attenuation and filtering in all input lines, and amplification in the readout chain provided by a travelling-wave parametric amplifier [S3] (at the mixing chamber) and a high-electron-mobility-transistor amplifier at 4 K. All control and readout signals are generated and acquired at room temperature using a Qblox Cluster that contains one QRM-RF module for readout, three QCM-RF modules for single-qubit gates and three QCM modules for baseband flux control of transmons and couplers. All the experiments are scheduled using the open-source framework Quantify, together with the Superconducting Qubit Tools package of Orange Quantum Systems.

TUNABLE-COUPLER DESIGN

As discussed in the main text, our target exchange coupling strengths for the system consisting of two transmons connected by a tunable coupler are $g_{qq} = 2\pi \times 6$ MHz and $g_{qc} = 2\pi \times 70$ MHz. Translating these couplings into geometry requires fine tuning of the capacitive couplings. Approximately [S5],

$$g_{qq} = \frac{E_{ij}}{\sqrt{2}} \left(\frac{E_{J_i} E_{J_j}}{E_{C_i} E_{C_j}} \right)^{\frac{1}{4}},$$

where E_{J_i} and E_{J_j} are the Josephson energies of the two coupled transmons Q_i and Q_j , while E_{C_i} and E_{C_j} are their charging energies. E_{ij} represents the direct capacitive coupling energy between both transmons. The transmon parameters (E_J and E_C) are previously fixed while designing the layout, leaving only E_{ij} as an adjustable parameter used to target g_{qq} .

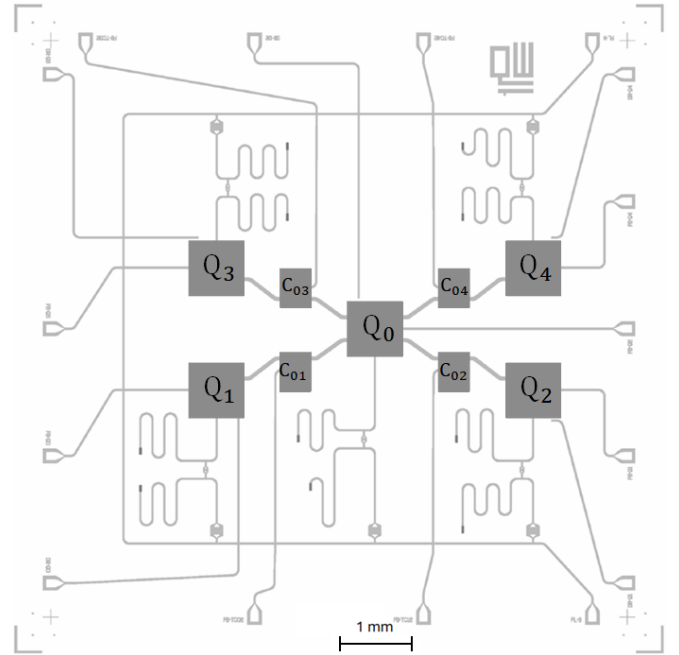

FIG. S1. Schematic of the 5 transmon, 4 tunable coupler device used in this experiment.

Similarly [S5],

$$g_{qc} = \frac{E_{ic}}{\sqrt{2}} \left(\frac{E_{J_i} E_{J_c}}{E_{C_i} E_{C_c}} \right)^{\frac{1}{4}},$$

where E_{J_c} and E_{C_c} represent the Josephson and charging energies of the tunable coupler and E_{ic} the coupling energy between transmon Q_i and the coupler. In our architecture, E_{ic} is dependent on E_{ij} , since a single coupling pad is used to couple all three elements, and it is therefore fixed when targeting g_{qq} . The value of E_{J_c} is constrained to target the coupler sweetspot frequency 100 MHz above the $\xi_{ZZ} = 0$ point, leaving E_{C_c} as the only adjustable parameter when targeting g_{qc} .

Fast calculation of the capacitance matrix

The methods described above allow coarse tuneup of the exchange coupling strengths. In a more realistic scenario, some of the design parameters have non-negligible impact on each other. For example, decreasing E_{qc} by increasing the qubit-coupler capacitance will also decrease E_{C_c} and E_{C_q} for both qubits. For small systems, we can tune each of these components multiple times with a finite-element method (FEM) simulation to converge towards the target values. However, this approach is relatively slow, requiring ~ 12 min per simulation on a desktop computer. Making small changes to the geometry and iterating to get the correct coupling be-

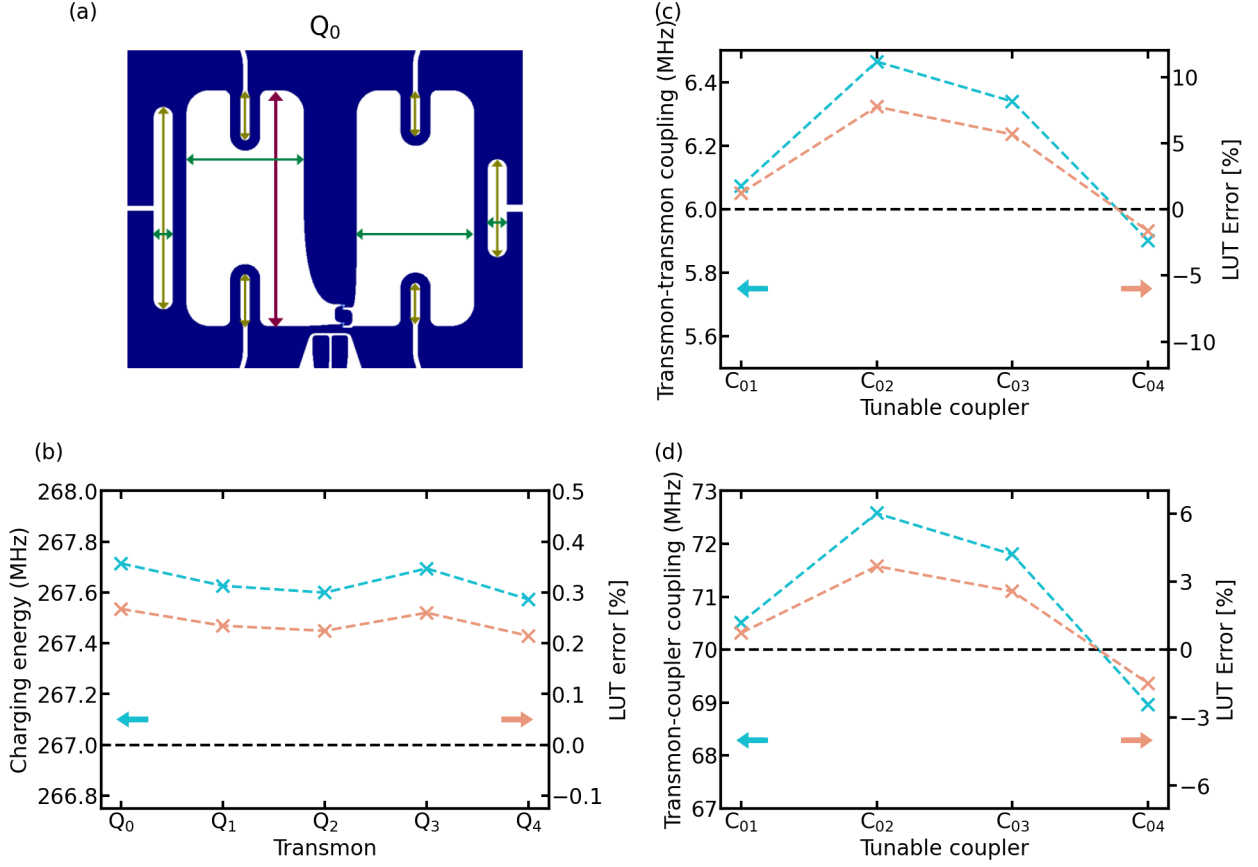

FIG. S2. Fine-tuning of the transmon and tunable-coupler capacitances using the lookup-table method. (a) Schematic of the transmon geometry, showing the 7 adjustable dimensions that are tuned for capacitance targeting. The six gold-colored arrows indicate dimensions used for coupling capacitances. The dimensions of the main pads (red arrow) are used to set the total transmon capacitance. Other dimensions (green arrows) are kept constant during tunable-coupler design. (b) Charging energy, (c) qubit-qubit coupling strength and (d) qubit-coupler coupling strength as predicted by the LUT method, and prediction error determined with full finite-element simulation.

	Q_0	Q_1	Q_2	Q_3	Q_4
Sweetspot frequency (GHz)	5.295	5.218	5.181	5.463	5.457
Anharmonicity (MHz)	-275	-285	-286	-279	-281
T_1 (μ s)	31.5 ± 0.8	76.2 ± 1.3	68.2 ± 0.8	81.4 ± 1.2	34.1 ± 0.4
T_{2R} (μ s)	12.0 ± 0.2	29.2 ± 1.1	33.7 ± 0.8	34.1 ± 0.4	10.2 ± 0.9
T_{2E} (μ s)	32.8 ± 0.6	70.0 ± 2.2	95.9 ± 1.3	80.0 ± 1.2	35.7 ± 2.4
Single-qubit gate error (%)	0.056 ± 0.015	0.08 ± 0.02	0.023 ± 0.002	0.057 ± 0.016	0.043 ± 0.001

TABLE S1. Summary of key qubit parameters. The relaxation and coherence times are measured with all the couplers at $J_1 = 0$ bias. The uncertainties represent the standard deviation of the mean over repeated measurements.

	C_{01}	C_{02}	C_{03}	C_{04}
Sweetspot frequency (GHz)	6.275	6.296	6.317	6.383
Anharmonicity (MHz)	-250	-245	-253	-255
T_1 at sweetspot (μ s)	37.4 ± 8.0	36.1 ± 6.0	27.5 ± 9.0	50.1 ± 3.5
T_{2R} at sweetspot (μ s)	6.8 ± 2.5	16.6 ± 1.6	14.1 ± 3.9	21.2 ± 3.0
T_{2E} at sweetspot (μ s)	14.0 ± 2.9	34.6 ± 4.9	16.7 ± 3.3	26.9 ± 3.0
CZ gate error (%)	0.49 ± 0.33	0.61 ± 0.10	0.72 ± 0.05	0.88 ± 0.07
CZ leakage (%)	0.005 ± 0.024	0.053 ± 0.011	0.075 ± 0.008	0.005 ± 0.014

TABLE S2. Summary of key tunable coupler parameters. The relaxation and coherence times are measured with each coupler individually at the sweetspot, while the other couplers are placed at $0.5\Phi_0$ flux. The CZ gates are calibrated and characterized with all the tunable couplers biased $J_1 = 0$.

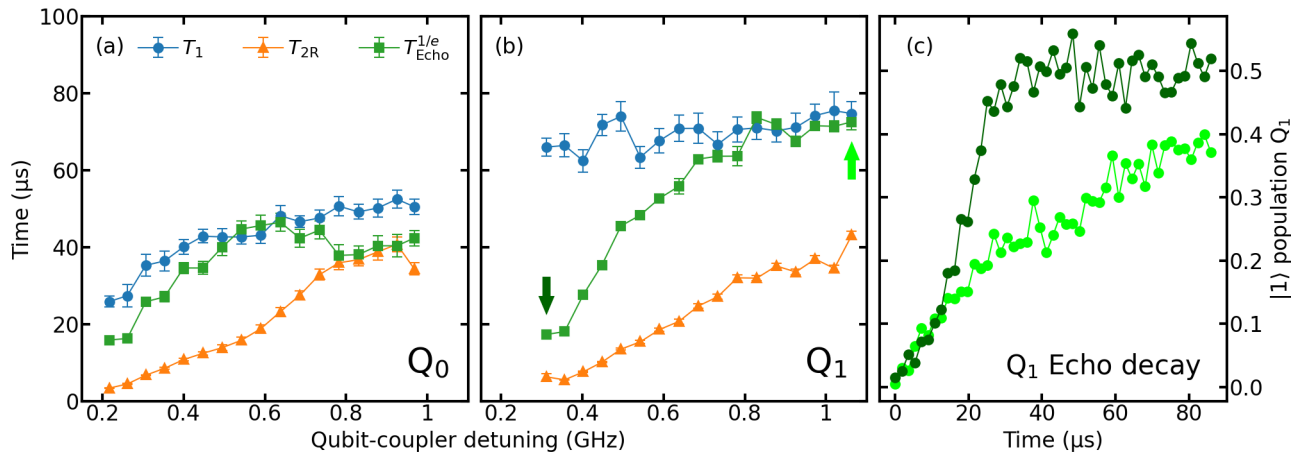

FIG. S3. Relaxation and dephasing (Ramsey and echo) times of transmons (a) Q_0 and (b) Q_1 at their sweetspot, as a function of coupler C_{01} frequency detuning. Error bars are the standard deviation of the mean computed from 35 repetitions. As the coupler is biased away from its sweetspot and toward the transmons, the increasing sensitivity of the bare coupler to flux noise and the increasing hybridization affect the transmon dephasing times. Relaxation time is also worsened by the increased hybridization as the bare coupler has lower relaxation time than the transmons. (c) Echo decay of Q_1 for two coupler biases: (light green) coupler at sweetspot, (dark green) coupler just ~ 300 MHz above Q_1 . Note the transition from exponential to gaussian decay resulting from the increase in sensitivity of the bare coupler to $1/f$ flux noise [S4] and the increase in transmon-coupler hybridization.

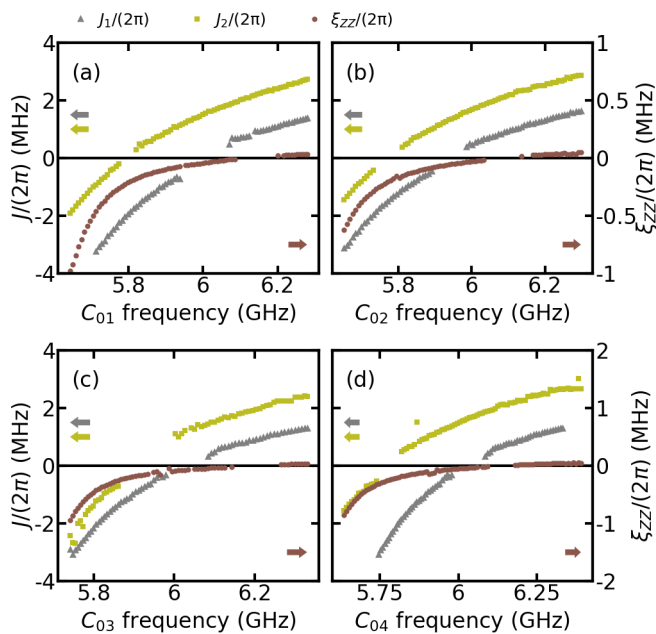

FIG. S4. J_1^{0i} , J_2^{0i} and ξ_{ZZ}^{0i} for all transmon pairs (Q_0, Q_i) as a function of the frequency of the coupler C_{0i} connecting them: (a) C_{01} , (b) C_{02} , (c) C_{03} , (d) C_{04} .

comes an arduous process, especially for devices with many couplers.

To circumvent this bottleneck, we make use of pre-simulated lookup tables (LUTs) for the transmon and tunable coupler geometries in order to more efficiently calculate the total capacitance matrix. The individual capacitance matrix

for each transmon and tunable coupler are calculated first from the LUTs and then combined to form the total capacitance matrix,

$$\begin{pmatrix} [Q_i] & [C_{ij}Q_i] \\ [C_{ij}Q_i] & [C_{ij}] & [C_{ij}Q_j] \\ [C_{ij}Q_j] & [C_{ij}Q_j] & [Q_j] \end{pmatrix}.$$

The transmon LUT consists of simulations of the qubit geometry, where most of the geometry is defined by fixed dimensions that are not changed during capacitance targeting [green arrows in Fig. S2(a)], and free dimensions that are adjusted while targeting a coupling capacitance [golden and red arrows in Fig. S2(a)]. We use a total of seven adjustable dimensions, six for defining a coupling to a readout resonator or a tunable coupler [golden arrows in Fig. S2(a)], and one for tuning E_{Cq} [red arrow in Fig. S2(a)]. For each adjustable dimension, two strategic values are chosen for simulation, one at the lower end of possible coupling capacitance and one at the higher end. Importantly, for all the possible dimension values in between, the capacitance has to be highly linear. The linearity ensures that only two values suffice per adjustable dimension for the LUT, making a total of $2^7 = 128$ required simulations for the full LUT. Comparing the interpolated values with FEM simulations, the error of using the LUT method is estimated to be below 0.3%, confirmed with simulations of the charging energy [Fig. S2(b)]. Crucially, this method decreases tuning times by up to four orders of magnitude.

Connecting the three LUTs introduces a larger error that can reach at most 5% per connection, yielding a maximum error of 4% for our device design [coupler C_{02} in Fig. S2(d)]. Including the second transmon with another connection doubles

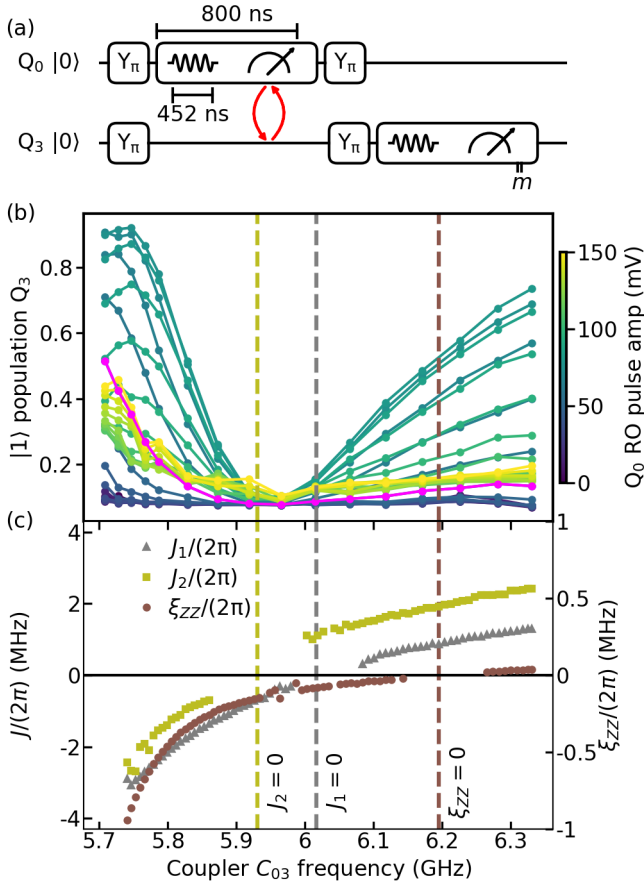

FIG. S5. Measurement-induced population exchange in the two-excitation manifold. (a) Circuit schematic of the experiment implemented on transmons Q_0 and Q_3 . (b) Population of Q_3 second-excited state, measured as a function of C_{03} frequency and amplitude of the Q_0 readout pulse. (c) J_1^{03} , J_2^{03} and ξ_{ZZ}^{03} as a function of C_{03} frequency [same data as Fig. S4(c)].

the prediction error of the LUT method, reaching a maximum value of 8% [coupler C_{02} in Fig. S2(c)]. A possible source of this discrepancy is an unaccounted capacitance from the transmon pad to a connection outside of the transmon square, in this case the part of the tunable coupler pad outside of the transmon pocket. Crucially, the error of the transmon-coupler and transmon-transmon couplings are correlated, making the error in the $\xi_{ZZ} = 0$ tunable-coupler frequency less sensitive to LUT prediction error.

QUBIT COHERENCE DEPENDENCE ON COUPLER BIAS

In tunable coupling architectures, the mode used to define the qubit (qubit-like mode) is partially hybridized with the tunable coupler. As the coupler approaches the qubit in frequency, they become more hybridized. Consequently, the coherence of the qubit-like mode decreases as the coupler becomes more sensitive to flux noise [Fig. S3(a,b)]. The Echo

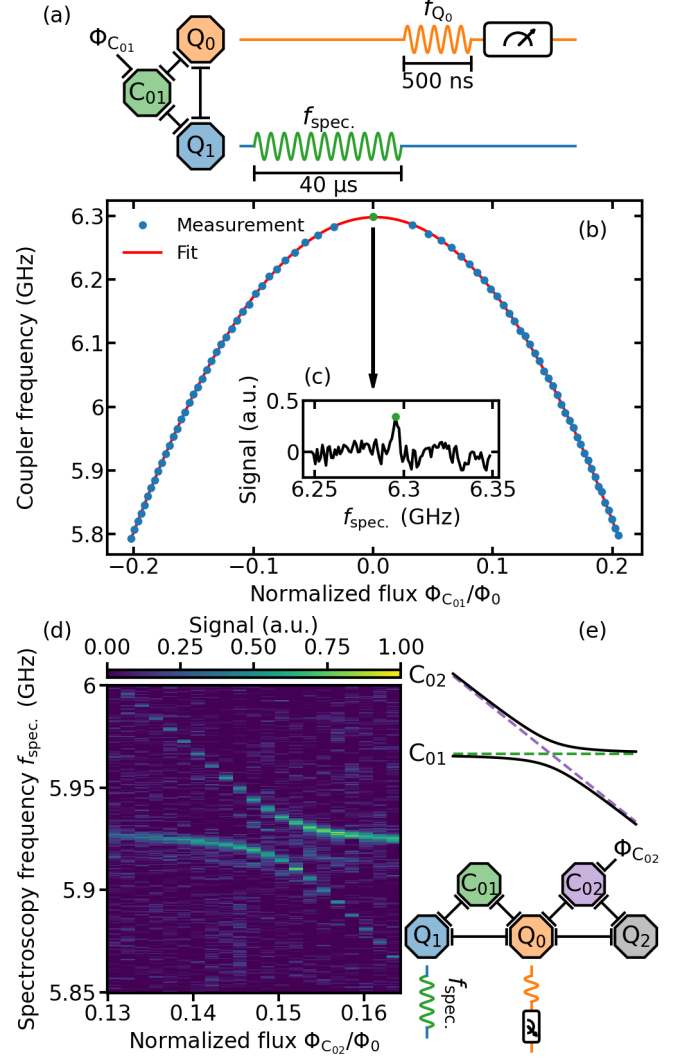

FIG. S6. (a) Pulsed spectroscopy sequence on coupler C_{01} . A spectroscopic pulse is applied to the drive line of Q_1 and Q_0 then readout. (b) C_{01} flux arc obtained by this spectroscopy method. A polynomial best fit is used to convert from static flux to C_{01} frequency. Inset (c): example single spectroscopy trace, revealing the frequency of C_{01} at its flux insensitive point (sweetspot). (d) Spectroscopy of C_{01} while sweeping the flux bias of C_{02} in a region where the two elements hybridize, producing an avoided crossing with minimum splitting of 17 MHz. (e) Schematic of the system of two interacting tunable couplers.

decay of the qubit-like modes also becomes more gaussian as the coupler becomes more flux-sensitive [Fig. S3(c)], a signature associated to $1/f$ flux noise [S4]. If the qubit and coupler have different relaxation times, the relaxation time of the qubit-like mode will also vary as they become more hybridized [Fig. S3(c)].

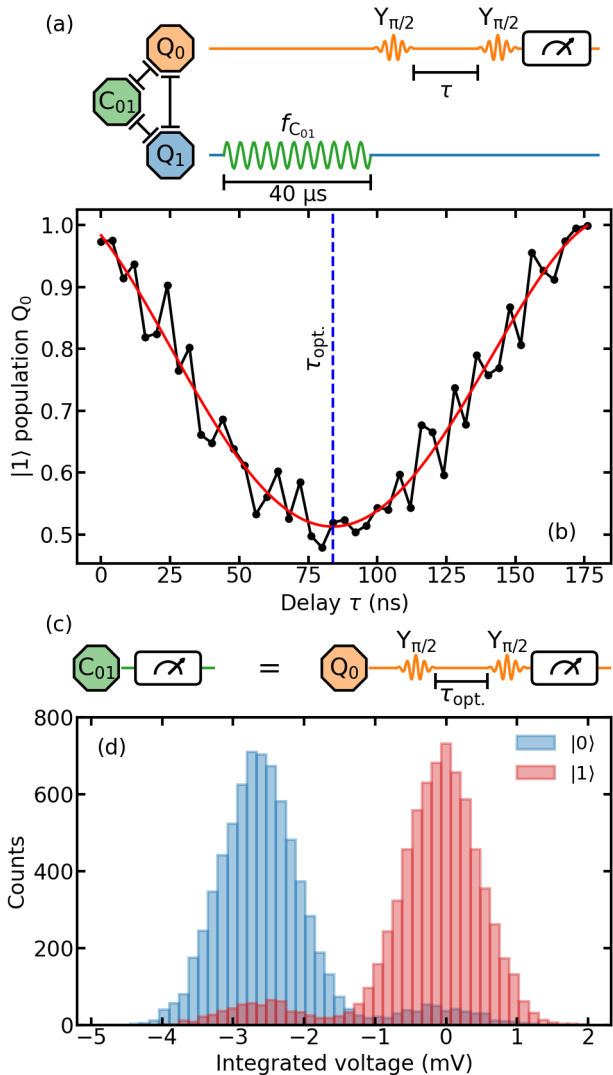

FIG. S7. Indirect readout of coupler C_{01} via Q_0 . (a) Calibration using a long spectroscopy pulse on C_{01} (applied on the microwave drive line of Q_1) and a Ramsey sequence on Q_0 . (b) Excited-state population of Q_0 , as a function of delay τ between the two $Y_{\pi/2}$ pulses on Q_0 . (c) Optimized quantum circuit to measure C_{01} via Q_0 . (d) SSRO characterization for C_{01} , showing $\epsilon_{\text{RO}} = 8\%$.

COUPLER CHARACTERIZATION

To study the dependence of various parameters on tunable-coupler frequency, it is necessary to be able to drive and readout the tunable couplers. Given that tunable couplers in our device do not have dedicated circuitry for drive and readout, only flux control, we must make use of the neighboring transmons and harness the strong dispersive coupling between coupler and transmons. For example (Fig. S6), pulsed spectroscopy on C_{01} is implemented by applying a $40 \mu\text{s}$ square pulse via the drive line of Q_1 .

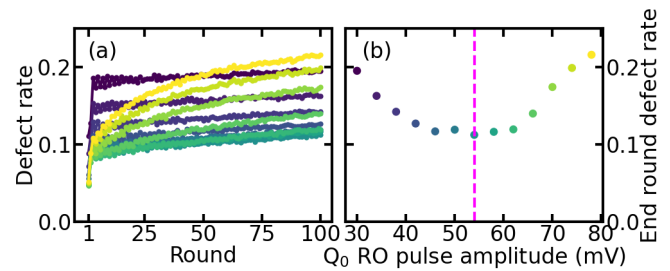

FIG. S8. Parity-check defect rates for different amplitudes of the ancilla Q_0 readout pulse. (a) Defect rates measured over 100 rounds. (b) Defect rate at round 100 as a function of Q_0 readout pulse amplitude. We choose the readout pulse amplitude (pink vertical line) that minimizes the defect rate at round 100.

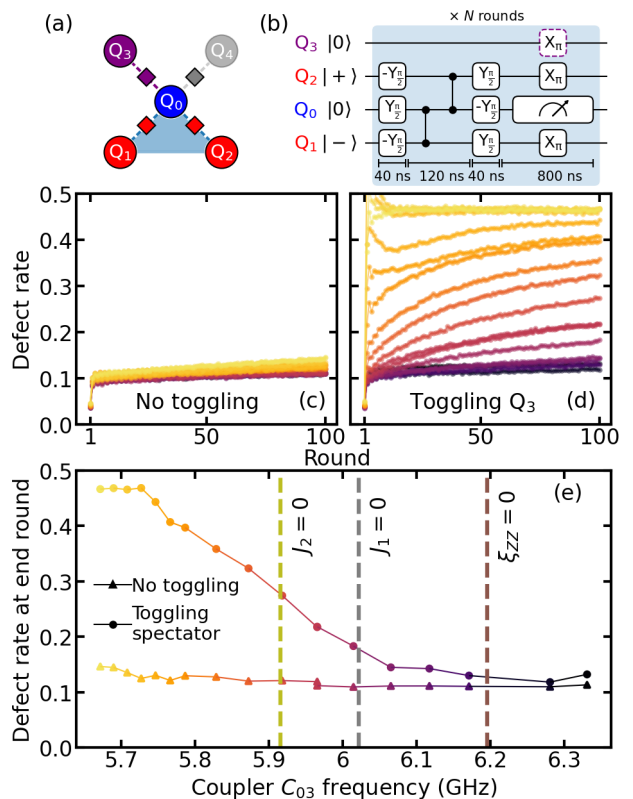

FIG. S9. Same experiment as in Fig. 4, but using Q_3 instead of Q_4 as the spectator. (a) Simplified schematic of the device with color coding to identify data qubits (Q_1 and Q_2 , red), ancilla (Q_0 , blue) and spectator (Q_3 , purple). (b) Quantum circuit realizing the indirect measurement of $X_2 X_1$ parity using Q_0 as ancilla. (c) Defect rates measured over 100 rounds at different C_{03} frequencies (represented by the color scale), keeping spectator Q_3 in the ground state. (d) Defect rates measured now toggling Q_3 at every round. (e) Common plot of the defect rate at round 100 for data in (c) and (d). Vertical lines identify the C_{03} frequencies at which $\xi_{ZZ} = 0$ and $J_1 = 0$. Vertical lines mark the $\xi_{ZZ}^{03} = 0$, $J_1^{03} = 0$ and $J_2^{03} = 0$ coupler bias points.

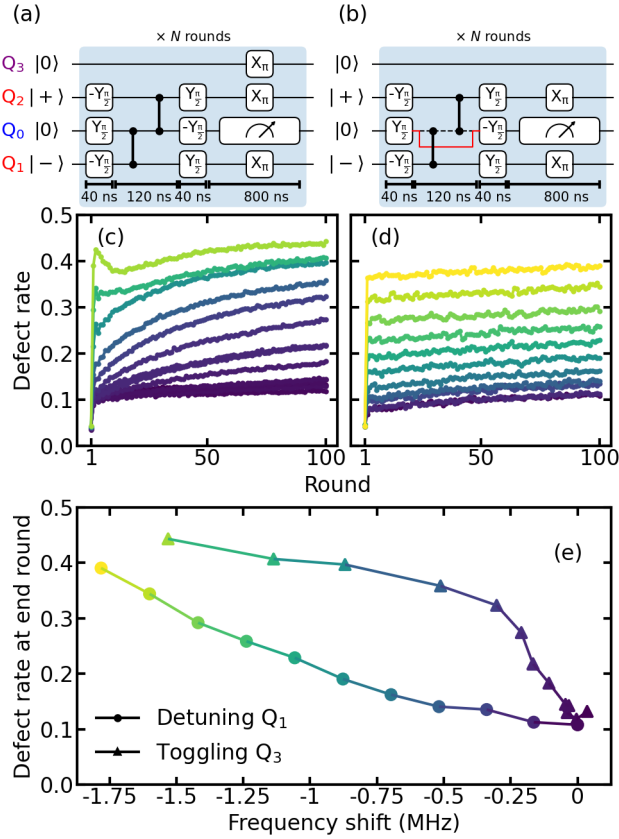

FIG. S10. Emulating residual ZZ coupling errors by flux pulsing Q_0 . (a,c) Same experiment and data as in Fig. S9. (b) Weight-2 X -type parity check experiment, marking that Q_0 is now dynamically detuned. (d) Defect rates measured for different frequency shift for Q_0 . (e) Comparison of defect rates at round 100 for both cases.

A shorter square pulse of 500 ns is subsequently applied to Q_0 , and Q_0 then readout [S6, S7]. This Q_0 pulse is intended to partially excite the qubit only when the coupler is in the ground state, generating a signal when the 40 μ s pulse is resonant with C_{01} . We use this modified pulsed spectroscopy to characterize the flux dependence of C_{01} frequency. A polynomial fit to this flux arc gives the conversion from static flux to frequency and viceversa. We perform this calibration on all couplers.

The 4 tunable couplers in our device are all strongly coupled to Q_0 . Consequently, there exists a non-negligible interaction between tunable couplers mediated by Q_0 [Fig. S6(d-e)]. This observation prompts us to characterize each tunable coupler individually, by biasing the non-measured couplers to $\Phi = 0.5\Phi_0$ to avoid unwanted population exchange between coupler modes.

The above described spectroscopy method has the advantage of being straightforward to implement, making it convenient in the early device exploration stage. But achieving high contrast between the ground and excited states of the coupler with this method would require longer microwave

pulses with a frequency spectrum narrower than the coupler-state-dependent shift in qubit frequency, which in this device is at least 4 MHz. As such a longer coupler readout operation could be limited by the coupler relaxation time, we opt for a faster Ramsey-based indirect readout scheme, shown in Fig. S7(c). A Ramsey sequence (two $Y_{\pi/2}$ pulses separated by τ) is applied to one of the neighboring transmons, followed by standard dispersive readout of the transmon. We chose τ_{opt} to maximize contrast. This method achieves single-shot readout of C_{01} with $\epsilon_{\text{RO}} = 8\%$ (Fig. S7d), mainly limited by dephasing of Q_0 during τ_{opt} and Q_0 readout fidelity.

This Ramsey-based indirect readout of couplers was made compatible with standard single-qubit calibration routines in Quantify, enabling the characterization of coupler coherence times as displayed in Table S2. It is also compatible with the Cryoscope experiment [S8] used to characterize dynamical distortion of flux pulses applied to the tunable coupler up to 500 ns. Furthermore, it is also compatible with the spectroscopy-based flux pulse characterization [S9] used to measure such distortion up to 30 μ s. By pre-distorting flux pulses using the real-time filtering capability of QCM modules, we compensate the dynamical distortions in these short and long timescales. This is critical to implementing repeatable, high-fidelity, two-qubit gates with unipolar flux pulses.

MEASUREMENT-INDUCED POPULATION EXCHANGE IN THE TWO-EXCITATION MANIFOLD

The frequency shift and increased linewidth of qubit transitions during readout can induce population exchange between neighboring transmons, as shown in Fig. 2. This phenomenon can also occur in the two-excitation manifold. For example, as shown in Fig. S5, when Q_0 and Q_3 are prepared in $|1_01_3\rangle$ and Q_0 is readout, population exchange to $|0_02_3\rangle$ can occur via the same mechanism. This population exchange is avoided when C_{03} is biased to $J_2^{03} = 0$ [Fig. S5(b)]. The exchange is small but non-zero at $\xi_{ZZ}^{03} = 0$ for the chosen Q_0 readout-pulse amplitude. We believe this is the reason why in Fig. 4(e) the parity-check defect rate with spectator Q_3 toggling does not perfectly match the defect rate without toggling. Finally, note that as $|\xi_{ZZ}|$ is large when $J_2 = 0$ [Fig. S5(c)], we do not consider $J_2 = 0$ a good bias condition for any tunable coupler.

CHOOSING THE READOUT PULSE AMPLITUDE FOR Q_0

For the repeated parity-check experiment, the readout on ancilla Q_0 is realized with a 452 ns square pulse at a frequency optimized to distinguish the ground and first-excited states. The total allocated time for readout is 800 ns, long enough to ensure photon depletion in the readout mode [S10]. Integration of the transmitted signal is performed using optimal weight functions [S11, S12]. Figure S8 shows the dependence of the parity defect rate on Q_0 readout-pulse amplitude. At low amplitude, the signal-to-noise ratio is worse

and the defect rates increase. The defect rate also increases at high readout amplitude and also shows a slope, a signal typically associated to leakage [S13] (in this case, measurement induced). Based on this study, we chose the Q_0 readout-pulse amplitude indicated by the vertical line.

FAST-ADIABATIC PULSE PARAMETRIZATION

We implement the baseband flux pulse on the coupler as a unipolar, fast-adiabatic pulse as introduced by Martinis and Geller[S14], adapted to the tunable coupler system in a similar way as in Ref. [S15]. Therefore, we define the time-dependent parameter

$$\theta(t) = \arctan\left(\frac{g_{qc}}{\Delta(t)}\right), \quad (S1)$$

where $\Delta(t) = \omega_c(t) - \omega_q$ and ω_c and ω_q the coupler and high-frequency qubit frequencies, respectively. The starting value, θ_i , is determined by the coupler frequency at the $J_1 = 0$ bias. The final value, θ_f , is chosen from landscapes similar to those of Figs. 3(a-b), chosen to minimize leakage along the contour of 180° conditional phase. Based on these values, the time-dependent pulse is parametrized as

$$\theta(t) = \frac{\theta_f - \theta_i}{2} \left[1 - \cos(2\pi t/t_p) \right], \quad (S2)$$

where $t_p = 60$ ns is the pulse duration. After generating the $\theta(t)$ pulse, we convert it to coupler frequency using Eq. S1 and then into voltage-pulse amplitude using the frequency-to-amplitude conversion characterized using the Cryoscope method [S8] at different pulse amplitudes.

DEFECT RATE WITH SPECTATOR EFFECTS ON Q_3

The spectator effects observed by toggling Q_4 during repeated X_2X_1 parity checks (Fig. 4) are reproduced when toggling Q_3 instead. This experiment is shown in Fig. S9.

EMULATING RESIDUAL ZZ ERRORS BY FLUX PULSING THE ANCILLA

Toggling a spectator like Q_3 (Q_4) when $\xi_{ZZ}^{03} \neq 0$ ($\xi_{ZZ}^{04} \neq 0$) forces a frequency shift in Q_0 . To better understand the dynamics of defect rates under toggling of spectators, we emulate this state-dependent frequency shift of Q_0 by dynamically detuning Q_0 an equivalent amount during the two-qubit gates (Fig. S10). Note that we only apply the dynamical detuning at odd-numbered rounds to emulate the switching of the spectator qubit. We indeed observe that the defect rates also increase with increased dynamical detuning of Q_0 , as expected. However, comparing both experiments at round 100, we observe

that the defect rate increases faster when toggling the spectator than when just dynamically detuning Q_0 [Fig. S10(e)]. Moreover, the defect rates measured while toggling a spectator present a more pronounced slope, an effect typically associated with leakage to higher excited transmon states [S13]. We surmise that the root of the discrepancy may be that toggling the spectator affects the hybridization of Q_0 , not just its frequency.

* Present address: A*STAR Quantum Innovation Centre (Q.InC), Institute of Materials Research and Engineering (IMRE), Agency for Science, Technology and Research (A*STAR), 2 Fusionopolis Way, 08-03, Singapore, Republic of Singapore

- [S1] J. Heinsoo, C. K. Andersen, A. Remm, S. Krinner, T. Walter, Y. Salathé, S. Gasparinetti, J.-C. Besse, A. Potočnik, A. Wallraff, and C. Eichler, *Phys. Rev. App.* **10**, 034040 (2018).
- [S2] S. Vallés-Sanclemente, S. L. M. van der Meer, M. Finkel, N. Muthusubramanian, M. Beekman, H. Ali, J. F. Marques, C. Zachariadis, H. M. Veen, T. Stavenga, N. Haider, and L. DiCarlo, *App. Phys. Lett.* **123**, 034004 (2023).
- [S3] C. Macklin, K. O'Brien, D. Hover, M. Schwartz, V. Bolkhovskiy, X. Zhang, W. Oliver, and I. Siddiqi, *Science* **350**, 307 (2015).
- [S4] J. Braumüller, L. Ding, A. P. Vepsäläinen, Y. Sung, M. Kjaergaard, T. Menke, R. Winik, D. Kim, B. M. Niedzielski, A. Melville, J. L. Yoder, C. F. Hirjibehedin, T. P. Orlando, S. Gustavsson, and W. D. Oliver, *Phys. Rev. App.* **13**, 054079 (2020).
- [S5] E. A. Sete, A. Q. Chen, R. Manenti, S. Kulshreshtha, and S. Poletto, *Phys. Rev. App.* **15**, 064063 (2021).
- [S6] F. Marxer, A. Vepsäläinen, S. W. Jolin, J. Tuorila, A. Landra, C. Ockeloen-Korppi, W. Liu, O. Ahonen, A. Auer, L. Belzane, *et al.*, *PRX Quantum* **4**, 010314 (2023).
- [S7] C. Zhang, T.-L. Wang, L.-L. Guo, X.-Y. Yang, X.-X. Yang, P. Duan, Z.-L. Jia, W.-C. Kong, and G.-P. Guo, *App. Phys. Lett.* **122**, 024001 (2023).
- [S8] M. A. Rol, L. Ciorciaro, F. K. Malinowski, B. M. Tarasinski, R. E. Sagastizabal, C. C. Bultink, Y. Salathe, N. Haandbaek, J. Sedivy, and L. DiCarlo, *App. Phys. Lett.* **116**, 054001 (2020).
- [S9] C. Hellings, N. Lacroix, A. Remm, R. Boell, J. Herrmann, S. Lazăr, S. Krinner, F. Swiadek, C. K. Andersen, C. Eichler, and A. Wallraff, *arXiv:2503.04610* (2025).
- [S10] C. C. Bultink, M. A. Rol, T. E. O'Brien, X. Fu, B. C. S. Dikken, C. Dickel, R. F. L. Vermeulen, J. C. de Sterke, A. Bruno, R. N. Schouten, and L. DiCarlo, *Phys. Rev. App.* **6**, 034008 (2016).
- [S11] E. Magesan, J. M. Gambetta, A. D. Córcoles, and J. M. Chow, *Phys. Rev. Lett.* **114**, 200501 (2015).
- [S12] C. A. Ryan, B. R. Johnson, J. M. Gambetta, J. M. Chow, M. P. da Silva, O. E. Dial, and T. A. Ohki, *Phys. Rev. A* **91**, 022118 (2015).
- [S13] Google Quantum A.I. *et al.*, *Nature* **595**, 383 (2021).
- [S14] J. M. Martinis and M. R. Geller, *Phys. Rev. A* **90**, 022307 (2014).
- [S15] Y. Sung, L. Ding, J. Braumüller, A. Vepsäläinen, B. Kannan, M. Kjaergaard, A. Greene, G. O. Samach, C. McNally, D. Kim, A. Melville, B. M. Niedzielski, M. E. Schwartz, J. L.

