

# AN ACTION OF THE WITT ALGEBRA ON KHOVANOV–ROZANSKY HOMOLOGY

ALEXIS GUÉRIN AND FELIX ROZ

ABSTRACT. We construct an action of the positive part of the Witt algebra on the Khovanov–Rozansky  $\mathfrak{gl}_N$ -link homology and prove that this construction is functorial.

## CONTENTS

1. Introduction	1
2. Algebraic background	3
3. $\mathfrak{W}_{-1}^{\infty}$ -action on foams	5
4. Twists of the $\mathfrak{W}_{-1}^{\infty}$ action	12
5. A homological invariant	18
6. Functoriality	34
7. Computations	35
Appendix A. Verdier quotient	43
References	46

## 1. INTRODUCTION

The problem of categorifying the Witten–Reshetikhin–Turaev (WRT) [Wit89, RT91] invariants of 3-manifolds [CF94] directly led to the problem of categorifying polynomial invariants in knot theory. One of the first breakthroughs in this direction was the categorification of the Jones polynomial by Khovanov [Kho00]. This discovery gave rise to numerous other homology theories categorifying different polynomial invariants:  $\mathfrak{gl}_N$ -homology, triply-graded HOMFLY-PT homology [KR08a, KR08b, Kho07, Rou17], Heegaard–Floer homology [OS04, Ras03],  $\mathfrak{gl}_{-N}$ -homology [Cau17, QRS18, RW20b], etc.

In this paper, we study symmetries of  $\mathfrak{gl}_N$ -homology, following the foamy approach which is fit for functoriality [ETW18]. The connection between link homology and foams was first established in [Kho04] to categorify the  $\mathfrak{sl}_3$ -link invariant. Mackaay, Stošić, and Vaz used the Kapustin–Li formula [KL03, KR07] to evaluate closed foams in order to extend Khovanov’s work to  $\mathfrak{gl}_N$ -homologies. The relations defining the category of foams described in [LQR15, QR16] by Lauda, Queffelec, and Rose were later shown to be consequences of the foam evaluation defined in [RW20a].

The full functoriality of the Khovanov–Rozansky  $\mathfrak{gl}_N$ -link homologies using foam evaluation was established in [ETW18], building on earlier work on the functoriality

of the  $\mathfrak{sl}_2$  case [Jac04, Kho06, BN05], up to a sign, and later refined in works such as [BHPW23, Bla10, Cap07, CMW09, EST20, Vog20].

The study of symmetries of link homologies was initiated by Gorsky, Oblomov, and Rasmussen [GOR13], who conjectured that certain colored link homologies have graded dimensions equal to characters of representations of affine Lie algebras. These symmetries were first constructed for HOMFLY-PT homology, initially in the case of the positive half of the Witt algebra by Khovanov and Rozansky [KR16], and later for  $\mathfrak{sl}_2$  by Gorsky, Hogancamp, and Mellit [GHM24]. This latter work was applied in [CG24] to reveal structural properties of  $\mathfrak{gl}_N$ -homology. In a similar vein, an action of  $\mathfrak{sl}_2$  was constructed on Soergel bimodules in [EQ23]. In an other direction, an  $\mathfrak{sl}_2$ -action was constructed by Grigsby, Licata, and Wehrli [GLW18] on annular Khovanov homology. This paper is inspired by a work of Qi, Robert, Sussan, and Wagner who constructed an  $\mathfrak{sl}_2$ -action on the Khovanov–Rozansky homology in [QRSW23].

Based on the results in [KR16], the action of the degree-2 Witt generator  $L_1$  has been used to define a  $p$ -DG structure on HOMFLY-PT homology and  $\mathfrak{gl}_{-2}$ -homology, leading to categorifications of Jones and colored Jones polynomial at a root of unity [QRSW21, QS22]. Moreover, the operator  $\Delta$  introduced by Wang in [Wan24], can be seen as a part of the  $\mathfrak{W}_{-1}^\infty$  action described in [QRSW24].

In this paper we show that the  $\mathfrak{W}_{-1}^\infty$  algebra action on foams constructed by Qi, Robert, Sussan, and Wagner [QRSW23] endows the  $\mathfrak{gl}_N$ -homology of a link with a  $\mathfrak{W}_{-1}^\infty$ -module structure, extending  $\mathfrak{sl}_2$  module structure constructed by the same authors [QRSW24]. This action is functorial in the sense that there is a functor from a link category to a homotopy category of  $\mathfrak{W}_{-1}^\infty$ -modules. As an example, we describe the  $\mathfrak{W}_{-1}^\infty$  structure on  $T(2, m)$  links, extending previous computations by the second author [Roz23].

In future work, the functoriality of the  $\mathfrak{W}_{-1}^\infty$  action may be used to better understand invariants based on Khovanov–Rozansky homology such as Skein lasagna modules. In the recent papers of Morrison, Walker, and Wedrich [MWW24] Skein lasagna modules were shown to be sensitive to smooth structure and in the paper of Ren and Willis [RW24] they were used to distinguish an exotic pair of 4-manifolds. Despite these advances, lasagna modules are difficult to compute and often infinite dimensional. The presence of a  $\mathfrak{W}_{-1}^\infty$  action on these modules may provide an additional means of decomposition and give access to the relevant components more easily.

**1.1. Acknowledgements.** We would like to thank Louis-Hadrien Robert, Joshua Sussan and Emmanuel Wagner for advising us on this project as well as Matt Hogancamp for helpful discussions related to twisting of representations.

We thank the authors of [QRSW23] for allowing us to use the diagrams from their paper.

**1.2. Outline of the paper.** In section 2 we define the target category for our version of the Khovanov–Rozansky homology and develop technical tools for working in this category.

Section 3 provides a review of foams and the  $\mathfrak{W}_{-1}^\infty$ -action defined on them in [QRSW24].

In Section 4, we describe twists of the  $\mathfrak{W}_{-1}^\infty$ -actions on foams which are necessary for the action on homology.

Section 5 is dedicated to defining the  $\mathfrak{W}_{-1}^\infty$ -equivariant Khovanov–Rozansky  $\mathfrak{gl}_N$ -homology and proving that it is a (framed) link invariant

Section 6 discusses functoriality which is a direct application of results from [ETW18] and Section 5 of [QRSW23].

In Section 7 we compute the action on a basis for  $(2, m)$ -torus links and discuss some basic structural results.

**1.3. Conventions.** Let us denote by  $\mathbb{N}_{-1}$  the set  $\mathbb{N} \cup \{-1\}$  and let  $N$  be a fixed natural number.

Let  $\mathbb{R}$  be a ring with unity where 2 is invertible. For all  $x \in \mathbb{R}$ , we set  $\bar{x} := 1 - x$ .

For  $k \in \mathbb{N}$ , we denote by  $Sym_k^{\mathbb{R}} = \mathbb{R}[x_1, \dots, x_k]^{\mathfrak{S}_k}$  the ring of symmetric polynomials with  $\mathbb{R}$  coefficients in  $k$  variables. When  $\mathbb{R}$  is the ring of integers we write  $Sym_k = Sym_k^{\mathbb{Z}}$ . When working in such a ring, we will let  $e_i$ ,  $h_i$ , and  $p_i$  be the  $i$ th elementary, complete homogeneous, and power sum symmetric polynomials respectively without reference to the variables. The ring  $Sym_k$  is graded by imposing  $deg(x_i) = 2$ .

We often work with polynomials in  $N$  variables, where  $N$  is our fixed natural number. In this case, we write  $\mathbb{Z}_N := Sym_N$  and  $\mathbb{R}_N := Sym_N^{\mathbb{R}}$ , and refer to the variables, the elementary, complete homogeneous, and power sum symmetric polynomials with capital letters:  $X_i$ ,  $E_i$ ,  $H_i$ , and  $P_i$  respectively. We denote by  $\underline{X}_A = (X_j)_{j \in A}$  where  $A$  is a subset of  $\{1, \dots, N\}$ .

For  $n \in \mathbb{Z}$ , and  $q$  a formal variable, let  $[n] := \frac{q^n - q^{-n}}{q - q^{-1}} = \sum_{i=0}^{n-1} q^{n-1-2i}$ , for  $k \in \mathbb{N}$ , we let  $[k]! = \prod_{j=1}^k [j]$ . Finally, for  $m \in \mathbb{Z}$  and  $a \in \mathbb{N}$ , define:

$$\begin{bmatrix} m \\ a \end{bmatrix} = \prod_{i=1}^a \frac{[m+1-i]}{[i]} \in \mathbb{Z}[q, q^{-1}].$$

Note that if  $m$  is non-negative, one has  $\begin{bmatrix} m \\ a \end{bmatrix} = \frac{[m]!}{[a]![m-a]!}$ .

For a  $\mathbb{Z}$ -graded module  $M$ , let  $M_i$  denote the subspace in degree  $i$ . Let  $q^n M$  denotes the  $\mathbb{Z}$ -graded module where  $(q^n M)_i = M_{i-n}$ .

Complexes will be taken to be cohomologically graded; in other words, the  $i$ th differential goes from  $C_i$  to  $C_{i+1}$ . For a complex  $C$ , we let  $t^i C$  denote the complex with  $(t^j C)_i = C_{i-j}$ .

## 2. ALGEBRAIC BACKGROUND

**2.1. Homological preliminaries.** Let  $H$  be a Hopf algebra,  $A$  is a  $H$ -module algebra if  $A$  is an algebra object in  $H\text{-mod}$ , the category of  $H$ -modules. In particular, with the Sweedler's notation:

$$h \cdot (ab) = \sum_h (h_{(1)} \cdot a)(h_{(2)} \cdot b) \quad \text{and} \quad h \cdot 1_A = \varepsilon(h)1_A$$

where  $\varepsilon$  is the counit of the Hopf algebra  $H$ . The *smash product algebra*  $A \# H$ , as a  $\mathbb{R}$ -module, is  $A \otimes_{\mathbb{R}} H$  endowed with the multiplicative structure:

$$(a \otimes h)(b \otimes k) = \sum_h a(h_{(1)} \cdot b) \otimes h_{(2)}k,$$

for  $a, b \in A$  and  $h, k \in H$ . Thus,  $A$  and  $H$ , respectively identified with  $A \otimes_{\mathbb{R}} 1$  and  $1 \otimes_{\mathbb{R}} H$ , are subalgebras of  $A \# H$ .

In the following work, we will call objects and morphisms in  $A\#H\text{-mod}$   $H$ -equivariant  $A$ -modules and morphisms.

There is the forgetful functor between the usual homotopy categories of chain complexes of graded modules:

$$\text{For} : \mathcal{C}(A\#H) \rightarrow \mathcal{C}(A).$$

An object  $C$  of  $\mathcal{C}(A\#H)$  is annihilated by the forgetful functor if and only if, when forgetting the  $H$ -module structure on each term of  $C$ , the complex is null-homotpic. An object in  $\text{Ker}(\text{For})$  is said to be *relatively null-homotopic*.

**Definition 2.1.** Given an  $H$ -module algebra  $A$ , the *relative homotopy category* is the Verdier quotient:

$$\mathcal{C}^H(A) := \frac{\mathcal{C}(A\#H)}{\text{Ker}(\text{For})}.$$

More details about Verdier quotient can be found in Appendix A.

Thanks to the universal property of the Verdier quotient, we have the following commutative diagram:

$$(1) \quad \begin{array}{ccc} \mathcal{C}(A\#H) & \xrightarrow{\text{For}} & \mathcal{C}(A) \\ & \searrow F_u & \nearrow \\ & \mathcal{C}^H(A) & \end{array}$$

The proof of the next lemma is in the Appendix A.

**Lemma 2.2.** *A triangle is distinguished in  $\mathcal{C}^H(A)$  if and only if it is isomorphic to*

$$F_u(M) \rightarrow F_u(N) \rightarrow F_u(L) \rightarrow t^{-1}F_u(M)$$

where  $M \rightarrow N \rightarrow L$  is a short exact sequence in  $\mathcal{C}(A\#H)$  that is termwise  $A$ -split exact.

**Corollary 2.3.** *Let  $M \xrightarrow{f} N \xrightarrow{g} L$  be a short exact sequence in  $\mathcal{C}(A\#H)$  that is termwise  $A$ -split exact. If  $L$  is contractible, then  $F_u(f)$  is an isomorphism in  $\mathcal{C}^H(A)$ . Similarly, if  $M$  is contractible then  $F_u(g)$  is an isomorphism in  $\mathcal{C}^H(A)$ .  $\square$*

**2.2. Twists.** Let  $\mathfrak{g}$  be a Lie algebra over a commutative ring  $R$ . Let  $\mathcal{C}$  be a  $R$ -linear category. Recall that  $\mathcal{C}$  is enriched in  $\mathcal{U}(\mathfrak{g})$ -modules if for all all objects  $V, W$  in  $\mathcal{C}$ , the set  $\text{Hom}_{\mathcal{C}}(V, W)$  is a  $\mathcal{U}(\mathfrak{g})$ -module and for all  $X \in \mathcal{U}(\mathfrak{g})$  and  $f \in \text{Hom}_{\mathcal{C}}(W, U)$  and  $g \in \text{Hom}_{\mathcal{C}}(V, W)$ ,

$$(2) \quad X(f \circ g) = (Xf) \circ g + f \circ (Xg).$$

In other words,  $\mathfrak{g}$  acts by derivations with respect to composition.

**Definition 2.4.** A  $\mathfrak{g}$ -Maurer–Cartan element for an object  $V$  in  $\mathcal{C}$  is an  $R$ -linear map  $\alpha : \mathfrak{g} \rightarrow \text{End}_{\mathcal{C}}(V)$  such that for all  $X, Y \in \mathfrak{g}$ :

$$\alpha_{[X, Y]} = [\alpha_X, \alpha_Y] + X\alpha_Y - Y\alpha_X,$$

where  $[\ , \ ]$  in  $\text{End}_{\mathcal{C}}(V)$  is the commutator and the notation  $\alpha_X$ , with  $X \in \mathfrak{g}$ , denotes the evaluation of  $\alpha$  at  $X$ .

A Maurer–Cartan element “twists” the action of  $\mathfrak{g}$  in the following sense.

**Proposition 2.5.** *Let  $(V, \alpha)$  and  $(W, \beta)$  elements of  $\mathcal{C}$  and associated  $\mathfrak{g}$ -Maurer–Cartan elements,  $X \in \mathfrak{g}$ ,  $f \in \text{Hom}_{\mathcal{C}}(V, W)$  and  $Xf$  denote the action of  $X$  on  $\text{Hom}_{\mathcal{C}}(V, W)$ . The following relation defines a new  $\mathcal{U}(\mathfrak{g})$ -module structure on  $\text{Hom}_{\mathcal{C}}(V, W)$ :*

$$(3) \quad X \cdot f := Xf + \beta_X \circ f - f \circ \alpha_X$$

To prove the previous proposition, we need to check that the new action satisfies the relation (2) and the following one:

$$(4) \quad [X, Y] \cdot f = X \cdot Y \cdot f - Y \cdot X \cdot f.$$

This follows from the definition of a Maurer–Cartan element and is left to the reader as an exercise.

This new structure gives rise to the following definition:

**Definition 2.6.** Let  $Tw(\mathcal{C})$  be the  $\mathcal{U}(\mathfrak{g})$ -module enriched category of “twisted  $\mathcal{C}$  objects”. Its objects are formal pairs  $(V, \alpha)$  of objects in  $\mathcal{C}$  and Maurer–Cartan elements. The hom sets have the same underlying  $\mathbb{R}$ -modules,  $\text{Hom}_{Tw(\mathcal{C})}((V, \alpha), (W, \beta)) = \text{Hom}_{\mathcal{C}}(V, W)$ , with the  $\mathcal{U}(\mathfrak{g})$ -module structure defined by equation (3).

### 3. $\mathfrak{W}_{-1}^{\infty}$ -ACTION ON FOAMS

**3.1. Webs and foams.** In this section, we introduce the notion of foams, following [RW20a] [QRSW23] and [QRSW24].

**Definition 3.1.** Let  $\Sigma$  be a surface. A *closed web* (also called *web*) is a finite, oriented, trivalent graph  $\Gamma = (V(\Gamma), E(\Gamma))$  (where  $V(\Gamma)$  is the set of vertices and  $E(\Gamma)$  the set of edges) embedded in the interior of  $\Sigma$  and endowed with a *thickness function*  $\ell : E(\Gamma) \rightarrow \mathbb{N}$  satisfying a flow condition: vertices and thicknesses of their adjacent edges must be one of these two types:

$$(5) \quad \begin{array}{c} a+b \\ \uparrow \\ \swarrow \quad \searrow \\ a \quad b \end{array} \quad \text{and} \quad \begin{array}{c} a \quad b \\ \swarrow \quad \searrow \\ \downarrow \\ a+b \end{array}$$

The first type of vertex is called a *merge* vertex, the second a *split* vertex. In each of these types, there is one *thick* edge and two *thin* edges. Oriented circles with non-negative thickness are regarded as edges without vertices and can be part of a web. The embedding of  $\Gamma$  in  $\Sigma$  is smooth outside its vertices, and at the vertices should fit with the local models in (5).

**Definition 3.2.** Let  $M$  be an oriented smooth 3-manifold with a collared boundary. A *foam*  $F \subset M$  is a collection of *facets*, which are compact oriented surfaces labeled with non-negative integers and glued together along their boundary points, such that every point  $p$  of  $F$  has a closed neighbourhood homeomorphic to one of the following, shown in Figure 1:

- (1) a disk, when  $p$  belongs to a unique facet,
- (2)  $Y \times [0, 1]$ , where  $Y$  is the neighbourhood of a merge or split vertex of a web, when  $p$  belongs to three facets,
- (3) the cone over the 1-skeleton of a tetrahedron with  $p$  as the vertex of the cone, so that it belongs to six facets.

The set of points of second type is a collection of curves called *bindings* and points of the third type are called *singular vertices*. The boundary  $\partial F$  of  $F$  is the closure of the set of boundary points of facets that do not belong to a binding. It is understood that  $F$  coincides with  $\partial F \times [0, 1]$  on the collar of  $\partial M$ . For each facet  $f$  of  $F$ , we denote by  $\ell(f) \in \{1, \dots, N\}$  the *thickness* of  $f$ . A foam  $F$  is *decorated* if each facet  $f$  of  $F$  is assigned an element<sup>1</sup>  $P_f \in \text{Sym}_{\ell(f)}^{\mathbb{R}} \otimes \text{Sym}_{N-\ell(f)}^{\mathbb{R}}$ . In the second local model, it is implicitly understood that thicknesses of the three facets are given by that of the edges in  $Y$ . In particular, it satisfies a flow condition and locally one has a thick facet and two thin ones. We also require that orientations of bindings are induced by that of the thin facets and by the opposite of the thick facet. Foams are regarded up to ambient isotopy relative to boundary. Foams without boundary are said to be *closed*.

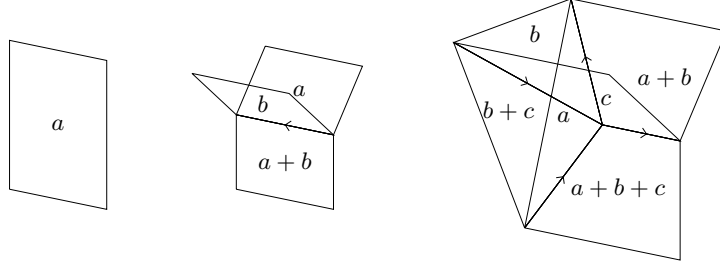

FIGURE 1. The three local models of the definition of foams. One denotes by  $Y^{(a,b)}$  the one in the middle and  $T^{(a,b,c)}$  the one on the right.

Let  $F$  be a foam, one denotes by:

- $F^2$  the collection of facets of  $F$ .
- $F^1$  the collection of bindings of  $F$ .
- $F^0$  the collection of singular vertices of  $F$ .

We partition  $F^1$  as follows:  $F^1 = F^1_{\circ} \sqcup F^1_{\_}$ , where  $F^1_{\circ}$  is the collection of circular bindings of  $F$ , and  $F^1_{\_}$  is the collection of bindings diffeomorphic to intervals. For a facet  $f$  of thickness  $a$  let us define its  $N$ -degree by:

$$\deg_N(f) = a(N - a)\chi(f).$$

Where  $\chi(f)$  stands for the Euler characteristic of  $f$ . If  $s \in F^1_{\_}$  each of its points have a neighbourhood diffeomorphic to  $Y^{(a,b)}$  we define:

$$\deg_N(s) = ab + (a + b)(N - a - b).$$

For  $v \in F^0$  that has a neighbourhood diffeomorphic to  $T^{(a,b,c)}$  we define:

$$\deg_N(v) = ab + bc + ac + (a + b + c)(N - a - b - c).$$

<sup>1</sup>Usually, decorations are taken in  $\text{Sym}_{\ell(f)}^{\mathbb{R}}$ , but in [QRSW23], it is explained how to extend this type of decorations to  $\text{Sym}_{\ell(f)}^{\mathbb{R}} \otimes \text{Sym}_{N-\ell(f)}^{\mathbb{R}}$ .

**Definition 3.3.** Let  $F$  be a decorated foam and suppose that all decorations are homogeneous. For all  $N$  in  $\mathbb{N}$ , the  $N$ -degree of  $F$  is defined as follows:

$$\deg_N(F) = \sum_{f \in F^2} \deg(P_f) - \deg_N(f) + \sum_{s \in F^1} \deg_N(s) - \sum_{v \in F^0} \deg_N(v),$$

where we recall that the degree of a polynomial is taken with the convention that the degree of the variables are two.

The degree of a foam can be understood as a modified Euler characteristic.

The boundary of a foam  $F \subset M$  is a closed web in  $\partial M$ . If  $M = \Sigma \times [0, 1]$ , where  $\Sigma$  is a surface, a generic section  $F_t := F \cap (\Sigma \times \{t\})$  is a web. The bottom and top webs  $F_0$  and  $F_1$  are called the *input* and the *output* of  $F$  respectively. Thus, one can define the following category:

Let  $\Sigma$  be a surface. The category  $\widehat{\mathbf{Foam}}_\Sigma$  has objects that are webs in  $\Sigma$  and morphisms that are foams defined as follows:

$$\mathrm{Hom}(\Gamma_0, \Gamma_1) = \{\text{decorated foams } F \text{ in } \Sigma \times [0, 1] \text{ with } F_0 = -\Gamma_0 \text{ and } F_1 = \Gamma_1\} / \text{ambient isotopy},$$

where  $-\Gamma_0$  is the same web as  $\Gamma_0$  but with all edges oriented in the opposite direction. Composition is given by stacking foams on one another and rescaling. Decorations behave multiplicatively. The identity morphism for  $\Gamma$  in this composition is the foam  $\Gamma \times [0, 1]$ , decorated with the constant polynomial 1 on every facet. We can show that the  $N$ -degree is additive under composition. We extend the category  $\widehat{\mathbf{Foam}}_\Sigma$  by adding formal grading shifts, direct sums, and  $\mathbb{R}_N$ -linear combinations of foams to form the graded, additive,  $\mathbb{R}_N$ -linear category  $\mathbf{Foam}_\Sigma$ .

In this work, we use the category  $\mathbf{Foam}_{\mathbb{R}^2}$ , which we denote by  $\mathbf{Foam}$ . Moreover, for two webs  $\Gamma$  and  $\Gamma'$  we denote by  $\mathbf{Foam}(\Gamma, \Gamma')$  the morphisms between  $\Gamma$  and  $\Gamma'$  in  $\mathbf{Foam}$ .

If  $\Gamma$  is a web in a surface  $\Sigma$ , and  $h : \Sigma \times [0, 1] \rightarrow \Sigma$  is a smooth isotopy of  $\Sigma$ , we can define  $F(h)$ , the trace of  $h(\Gamma)$  in  $\Sigma \times [0, 1]$ , by setting  $F(h)_t = h_t(\Gamma)$  for all  $t \in [0, 1]$ . Such foams are called *traces of isotopies*, have degree 0 and are isomorphisms in the category  $\mathbf{Foam}_\Sigma$ .

**Definition 3.4.** A foam in a surface  $\Sigma \times [0, 1]$  is called *basic* if it is a trace of an isotopy or if it is equal to  $\Gamma \times [0, 1]$  outside a cylinder  $B \times [0, 1]$ , where inside the cylinder it is given by one of the local models shown in Figure 2. A foam in  $\Sigma \times [0, 1]$  is said to be in *good position* if it is a composition of basic foams.

We can restrict our work to foams in good position, but in fact, every foam in  $\Sigma \times [0, 1]$  is isotopic to a foam in good position. This result can be found in [QW24].

To follow the process of universal construction, we can define a  $\mathfrak{gl}_N$ -evaluation on foams. This evaluation  $\langle F \rangle_N$  is an element of  $\mathbb{R}_N$ . It is defined in [RW20a] but its definition is not important here.

In the following sections, decorations of foams that we consider will often be power sums, and we introduce the following notations for a facet of thickness  $a$ :

$$\boxed{\spadesuit_i} := \boxed{\dot{p}_i} \quad \text{and} \quad \boxed{\hat{\spadesuit}_i} := \boxed{\hat{\dot{p}}_i}$$

where  $p_i = p_i \otimes 1 \in \mathrm{Sym}_a^{\mathbb{R}} \otimes \mathrm{Sym}_{N-a}^{\mathbb{R}}$  and  $\hat{p}_i = 1 \otimes p_i \in \mathrm{Sym}_a^{\mathbb{R}} \otimes \mathrm{Sym}_{N-a}^{\mathbb{R}}$ . In particular,  $\spadesuit_0 = a$  and  $\hat{\spadesuit}_0 = N - a$ .

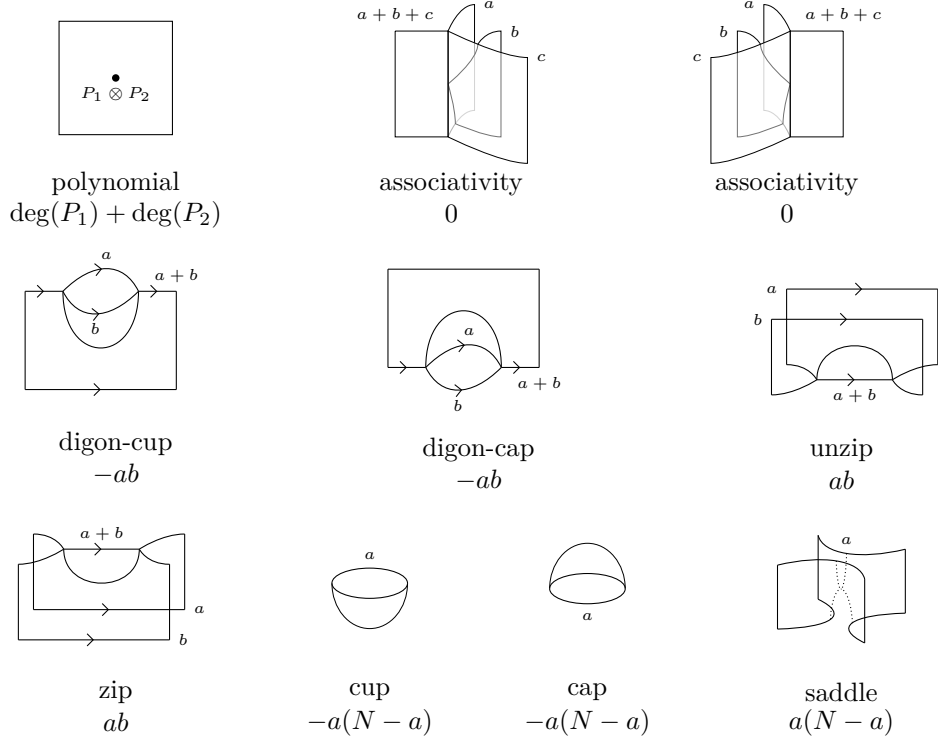

FIGURE 2. The degree of a basic foam is given below the name of each of the local models.

### 3.2. $\mathfrak{W}_{-1}^{\infty}$ -action.

**Definition 3.5.** Let  $\mathfrak{W}$  be the Lie algebra, over  $\mathbb{R}$ , generated by  $(L_n)_{n \in \mathbb{Z}}$  with relations  $\forall n, m \in \mathbb{Z}$ :

$$(7) \quad [L_n, L_m] = (n - m)L_{n+m}.$$

This algebra is called *Witt algebra*. Let us denote  $\mathfrak{W}_{-1}^{\infty}$ , the Lie subalgebra generated by symbols  $(L_n)_{n \geq -1}$ .

The map:

$$(7) \quad i : \begin{cases} e & \mapsto L_{-1} \\ h & \mapsto 2L_0 \\ f & \mapsto -L_1 \end{cases}$$

induces an injective morphism of Lie algebras from  $\mathfrak{sl}_2$  to  $\mathfrak{W}$  whose image is in  $\mathfrak{W}_{-1}^{\infty}$ .

$\mathfrak{W}_{-1}^{\infty}$  acts on polynomial rings, for any  $Q \in \mathbb{R}[x_1, \dots, x_k]$ :

$$(8) \quad L_n \cdot Q := - \sum_{i=1}^k x_i^{n+1} \frac{\partial Q}{\partial x_i}$$

Note that this action fixes symmetric polynomials so it defines an action on  $\mathbb{R}[x_1, \dots, x_k]^{\mathfrak{S}_k}$ .



Fix three elements of  $\mathbb{R}$  denoted  $s$ ,  $\lambda$  and  $\mu$  and denote<sup>2</sup> by  $\lambda_n = \lambda(n+1)$  and  $\mu_n = \mu(n+1)$ . Using these distinguished elements we define the following operators  $\mathbf{L}_n$  on basic foams:

$$(9) \quad \mathbf{L}_n \left( \begin{array}{c} \square \\ \bullet \\ P_1 \otimes P_2 \end{array} \right) = \begin{array}{c} \square \\ \bullet \\ L_n \cdot (P_1 \otimes P_2) \end{array}$$

$$(10) \quad \mathbf{L}_n \left( \begin{array}{c} a+b+c \\ \text{foam} \\ c \end{array} \right) = \mathbf{L}_n \left( \begin{array}{c} a \\ \text{foam} \\ a+b+c \end{array} \right) = 0$$

$$(11) \quad \mathbf{L}_n \left( \begin{array}{c} a \\ \text{foam} \\ b \\ a+b \end{array} \right) = \lambda_n \begin{array}{c} a \\ \spadesuit_0 \\ \text{foam} \\ \spadesuit_n \\ b \\ a+b \end{array} + \mu_n \begin{array}{c} a \\ \spadesuit_n \\ \text{foam} \\ \spadesuit_0 \\ b \\ a+b \end{array} + s \sum_{k+l=n} \begin{array}{c} a \\ \spadesuit_k \\ \text{foam} \\ \spadesuit_l \\ b \\ a+b \end{array}$$

$$(12) \quad \mathbf{L}_n \left( \begin{array}{c} \square \\ \text{foam} \\ a \\ b \\ a+b \end{array} \right) = -\lambda_n \begin{array}{c} \square \\ \text{foam} \\ a \\ \spadesuit_0 \\ \spadesuit_n \\ b \\ a+b \end{array} - \mu_n \begin{array}{c} \square \\ \text{foam} \\ a \\ \spadesuit_n \\ \spadesuit_0 \\ b \\ a+b \end{array} + \bar{s} \sum_{k+l=n} \begin{array}{c} \square \\ \text{foam} \\ a \\ \spadesuit_k \\ \spadesuit_l \\ b \\ a+b \end{array}$$

<sup>2</sup>In [QRSW24], authors use the terminology of Witt sequences. When 2 is invertible in the ground ring, these sequences are always of the form  $(\lambda(n+1))_{n \in \mathbb{N}_{-1}}$  with  $\lambda \in \mathbb{R}$ .

$$(13) \quad \mathbf{L}_n \left( \begin{array}{c} \text{Diagram with boundary } a+b \text{ and } a, b \\ \text{and a horizontal line with arrow} \end{array} \right) = \lambda_n \begin{array}{c} \text{Diagram with } \spadesuit_0 \text{ and } \spadesuit_n \\ \text{on the horizontal line} \end{array} + \mu_n \begin{array}{c} \text{Diagram with } \spadesuit_0 \text{ and } \spadesuit_n \\ \text{on the top boundary} \end{array} \\ - \bar{s} \sum_{k+\ell=n} \begin{array}{c} \text{Diagram with } \spadesuit_k \text{ and } \spadesuit_\ell \\ \text{on the horizontal line} \end{array}$$

$$(14) \quad \mathbf{L}_n \left( \begin{array}{c} \text{Diagram with boundary } a \text{ and } a+b \\ \text{and a horizontal line with arrow} \end{array} \right) = -\lambda_n \begin{array}{c} \text{Diagram with } \spadesuit_0 \text{ and } \spadesuit_n \\ \text{on the horizontal line} \end{array} - \mu_n \begin{array}{c} \text{Diagram with } \spadesuit_0 \text{ and } \spadesuit_n \\ \text{on the top boundary} \end{array} \\ - s \sum_{k+\ell=n} \begin{array}{c} \text{Diagram with } \spadesuit_k \text{ and } \spadesuit_\ell \\ \text{on the horizontal line} \end{array}$$

$$(15) \quad \mathbf{L}_n \left( \begin{array}{c} \text{Diagram with boundary } a \\ \text{and a horizontal line with arrow} \end{array} \right) = \frac{1}{2} \sum_{k+\ell=n} \begin{array}{c} \text{Diagram with } \spadesuit_k \text{ and } \spadesuit_\ell \\ \text{on the horizontal line} \end{array}$$

$$(16) \quad \mathbf{L}_n \left( \begin{array}{c} \text{Diagram with boundary } a \\ \text{and a horizontal line with arrow} \end{array} \right) = \frac{1}{2} \sum_{k+\ell=n} \begin{array}{c} \text{Diagram with } \spadesuit_k \text{ and } \spadesuit_\ell \\ \text{on the top boundary} \end{array}$$

$$(17) \quad \mathbf{L}_n \left( \begin{array}{c} \text{Diagram with boundary } a \\ \text{and a horizontal line with arrow} \end{array} \right) = -\frac{1}{2} \sum_{k+\ell=n} \begin{array}{c} \text{Diagram with } \spadesuit_k \text{ and } \spadesuit_\ell \\ \text{on the horizontal line} \end{array}$$

These operators can be extended to arbitrary foams in good position by the Leibniz rule with respect to gluing and acting by 0 on traces of isotopies.

**Proposition 3.6.** *Mapping  $L_n$  to  $\mathbf{L}_n$  for all  $n \in \mathbb{N}_{-1}$  defines an action of  $\mathfrak{W}_{-1}^\infty$  on the  $\mathbb{R}_N$ -module generated by foams in good position.*

*Proof.* We need to prove that for all  $n, m \in \mathbb{N}_{-1}$ ,  $[\mathbf{L}_n, \mathbf{L}_m] = (n - m)\mathbf{L}_{n+m}$  where  $[\mathbf{L}_n, \mathbf{L}_m] := \mathbf{L}_n \circ \mathbf{L}_m - \mathbf{L}_m \circ \mathbf{L}_n$ . Without loss of generality, we can assume that  $n \leq m$ . We can check that the operator  $[\mathbf{L}_n, \mathbf{L}_m]$  and  $(n - m)\mathbf{L}_{n+m}$  satisfy the

Leibniz rule. Therefore it is enough to prove the relation for basic foams. For traces of isotopies, this is trivial. For polynomial foams, the identity is satisfied because  $\mathfrak{W}_{-1}^\infty$  act on polynomial foams as it acts on symmetric polynomials. We need to check that the identity holds on caps, cups, zips, unzips, saddles, digon-caps and digon-cups foams. In all cases, the computation is similar, so we only treat the case of the saddle:

Note that for all  $n, k \in \mathbb{N}$ ,

$$L_n(\spadesuit_k) = -k\spadesuit_{k+n} \text{ and } L_n(\hat{\spadesuit}_k) = -k\hat{\spadesuit}_{k+n}.$$

Set:

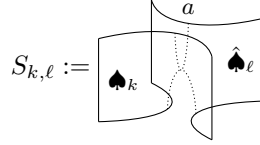

and  $S$  is the saddle without decorations. Therefore following (9) and (17) we have:

$$\mathbf{L}_n \circ \mathbf{L}_m(S) = -\frac{1}{2} \sum_{k+\ell=m} \mathbf{L}_n(S_{k,\ell})$$

and,

$$\mathbf{L}_n(S_{k,\ell}) = -kS_{k+n,\ell} - \ell S_{k,\ell+n} - \frac{1}{2} \sum_{i+j=n} S_{(i,k),(\ell,j)},$$

where  $S_{(i,k),(\ell,j)}$  denotes the saddle decorated by  $\spadesuit_i, \spadesuit_k, \hat{\spadesuit}_\ell$  and  $\hat{\spadesuit}_j$ . Moreover,  $\sum_{k+\ell=m} \sum_{i+j=n} S_{(i,k),(\ell,j)}$  is symmetric in  $n$  and  $m$  so:

$$\begin{aligned} \mathbf{L}_n \circ \mathbf{L}_m(S) - \mathbf{L}_m \circ \mathbf{L}_n(S) &= \frac{1}{2} \sum_{k+\ell=m} kS_{k+n,\ell} + \ell S_{k,\ell+n} - \frac{1}{2} \sum_{k+\ell=n} kS_{k+m,\ell} + \ell S_{k,\ell+m}. \end{aligned}$$

Now we distinguish three cases to establish the coefficient of  $S_{i,j}$ , with  $i+j = n+m$ , in the previous formula:

- if  $0 \leq i \leq n$  then  $m \leq j \leq n+m$  and the coefficient of  $S_{i,j}$  is:

$$\frac{j-n}{2} - \frac{j-m}{2} = -\frac{n-m}{2};$$

- if  $n \leq i \leq m$  then  $n \leq j \leq m$  and the coefficient of  $S_{i,j}$  is:

$$\frac{i-n}{2} + \frac{j-n}{2} = \frac{i+j-2n}{2} = -\frac{n-m}{2};$$

- if  $m \leq i \leq n+m$  then  $0 \leq j \leq n$  and the coefficient of  $S_{i,j}$  is:

$$\frac{i-n}{2} - \frac{i-m}{2} = \frac{n-m}{2}.$$

Therefore,

$$[\mathbf{L}_n, \mathbf{L}_m](S) = -\frac{n-m}{2} \sum_{i+j=n+m} S_{i,j} = (n-m)\mathbf{L}_{n+m}(S)$$

□

The computation for a cup is detailed in [QRSW24, p.24].

**3.3. State spaces.** As in [QRSW24] and [RW20a], we use foam evaluation to associate to each web  $\Gamma$  a graded  $\mathbb{R}_N$ -module  $\mathcal{F}_N(\Gamma)$  called the  $\mathfrak{gl}_N$ -state space of  $\Gamma$ . For a web  $\Gamma$ , the associated state space  $\mathcal{F}_N(\Gamma)$  is the quotient of  $\mathbb{R}_N$ -module  $\mathbf{Foam}(\emptyset, \Gamma)$  by relations induced by foam evaluation. Some of the relations are described explicitly in [RW20a]. When working with diagrams, we omit  $\mathcal{F}_N(\cdot)$  to prevent overloaded diagrams.

**Theorem 3.7.** [QRSW24, Theorem 4.4] *For any web  $\Gamma$ , the operators  $(\mathbf{L}_n)_{n \geq -1}$  induce an action of  $\mathfrak{W}_{-1}^\infty$  on the state space  $\mathcal{F}_N(\Gamma)$ . Moreover, the action is compatible with the degree of an element of  $\mathcal{F}_N(\Gamma)$  in the following sense, for all element  $F \in \mathcal{F}_N(\Gamma)$  and  $n \in \mathbb{N}_{-1}$ :*

$$\deg_N(L_n \cdot F) = 2n + \deg_N(F).$$

#### 4. TWISTS OF THE $\mathfrak{W}_{-1}^\infty$ ACTION

**4.1. Twists on webs.** In the language of Section 2.2, the category  $\mathbf{Foam}$  is enriched in  $\mathcal{U}(\mathfrak{W}_{-1}^\infty)$ -modules. We will now describe the category  $Tw(\mathbf{Foam})$ .

**Remark 4.1.** Following definition 2.4, a  $\mathfrak{W}_{-1}^\infty$ -Maurer–Cartan element for a web  $\Gamma$  is an  $\mathbb{R}_N$ -linear map  $\alpha : \mathfrak{W}_{-1}^\infty \rightarrow \mathbf{Foam}(\Gamma, \Gamma)$  such that

$$(18) \quad (n - m)\alpha_{L_{n+m}} = [\alpha_{L_n}, \alpha_{L_m}] + L_n\alpha_{L_m} - L_m\alpha_{L_n}$$

for all generators  $L_n, L_m \in \mathfrak{W}_{-1}^\infty$ .

Within  $\mathbf{Foam}(\Gamma, \Gamma)$  there is a distinguished subalgebra  $D_\Gamma$  constructed as follows. For each edge  $e$  with label  $a$  in  $\Gamma$ , let

$$D_e = \mathbb{R}[x_1, \dots, x_a, y_1, \dots, y_{N-a}]^{\mathfrak{S}_a \times \mathfrak{S}_{N-a}} = D'_e \otimes_{\mathbb{R}} \widehat{D}'_e,$$

where we have the identification:

$$D'_e := \mathbb{R}[x_1, \dots, x_a]^{\mathfrak{S}_a} \simeq Sym_a^{\mathbb{R}}$$

and

$$\widehat{D}'_e := \mathbb{R}[y_1, \dots, y_{N-a}]^{\mathfrak{S}_{N-a}} \simeq Sym_{N-a}^{\mathbb{R}}$$

as  $\mathbb{R}$ -algebras. This algebra is included into  $\mathbf{Foam}(\Gamma, \Gamma)$  by mapping a decoration  $p \in D_e$  to the identity foam for  $\Gamma$  decorated with  $p$  on the edge  $e$ . Thus, the algebra:

$$D_\Gamma = \bigotimes_{e \in E(\Gamma)} D_e$$

is a subalgebra of  $\mathbf{Foam}(\Gamma, \Gamma)$ . The action of  $\mathfrak{W}_{-1}^\infty$  on the polynomial algebras  $Sym_k^{\mathbb{R}}$  endows  $D_\Gamma$  with a  $\mathfrak{W}_{-1}^\infty$ -module structure that agrees with the action on  $\mathbf{Foam}(\Gamma, \Gamma)$ . Thus  $D_\Gamma$  is a sub- $\mathcal{U}(\mathfrak{W}_{-1}^\infty)$ -module of  $\mathbf{Foam}(\Gamma, \Gamma)$  as well. Note that since decorations slide freely on facets of foams, this subalgebra is commutative.

Let  $\alpha$  be a  $\mathfrak{W}_{-1}^\infty$ -Maurer–Cartan element, if the image of  $\alpha$  lands in  $D_\Gamma \subset \mathbf{Foam}(\Gamma, \Gamma)$  then the  $\mathfrak{W}_{-1}^\infty$ -Maurer–Cartan condition (18) reduces to:

$$(n - m)\alpha_{L_{n+m}} = L_n\alpha_{L_m} - L_m\alpha_{L_n}.$$

In [QRSW23], this condition was called  $\mathfrak{W}_{-1}^\infty$ -flatness for the map

$$\alpha : \begin{array}{c|c} \mathfrak{W}_{-1}^\infty & \longrightarrow & D_\Gamma \\ L_n & \longmapsto & \alpha_{L_n} \end{array}.$$

Note that since the  $\mathcal{U}(\mathfrak{W}_{-1}^\infty)$ -enriched structure on  $\mathbf{Foam}$  gave us a  $\mathfrak{W}_{-1}^\infty$ -action on  $\mathcal{F}_N(\Gamma)$ , a  $\mathfrak{W}_{-1}^\infty$ -Maurer–Cartan element  $\alpha$  for a web  $\Gamma$  twists the  $\mathfrak{W}_{-1}^\infty$ -action on

$\mathcal{F}_N(\Gamma)$ . Thus,  $\mathcal{F}_N$  naturally extends to a functor on  $Tw(\mathbf{Foam})$ , whose objects land in the subcategory of  $R_N\text{-mod}_{gr}$  whose objects carry a  $\mathfrak{W}_{-1}^\infty$ -action. The twisted action is defined by:

$$L_n * f := L_n \cdot f + \alpha_{L_n} \circ f$$

For this reason we call  $\alpha$  a *twist* on the state space of  $\Gamma$ .

Let  $\Gamma$  and  $\Gamma'$  be two webs,  $F \in \mathbf{Foam}(\Gamma, \Gamma')$ , and  $F' \in \mathcal{F}_N(\Gamma)$  then, due to the Leibniz rule we have for all  $n \in \mathbb{N}_{-1}$ :

$$\mathcal{F}_N(F)(L_n \cdot F') = L_n \cdot \mathcal{F}_N(F)(F') - \mathcal{F}_N(L_n \cdot F)(F').$$

Thus, a map  $\mathcal{F}_N(F)$  intertwines the actions of  $\mathfrak{W}_{-1}^\infty$  if and only if for all  $n \in \mathbb{N}_{-1}$ ,  $\mathcal{F}_N(L_n \cdot F) = 0$ . In this case,  $\mathcal{F}_N(F)$  is  $\mathfrak{W}_{-1}^\infty$ -equivariant, in other words, it is a morphism in the subcategory  $R_N \# \mathfrak{W}_{-1}^\infty\text{-Mod}_{gr}$ .

In general  $\mathcal{F}_N(L_n \cdot F) \neq 0$ , however using twists to deform actions on sources and targets state spaces, one can often recover  $\mathfrak{W}_{-1}^\infty$ -equivariance of  $\mathcal{F}_N(F)$ . The reader may think of these twists as analogues of grading shifts on objects which are utilized to force morphisms to have degree 0 in a graded context.

**4.2. Red dots.** For notational convenience we introduce a diagrammatic formalism to track twists on webs.

**Definition 4.2.** Let  $p_k^{(e)} = p_k \in D'_e \subset D_\Gamma$  and  $\hat{p}_k^{(e)} := p_k^{(e)} \in \widehat{D}'_e \subset D_\Gamma$ . A *Red-dotted* web is a web  $\Gamma$  endowed with a finite collection  $\mathcal{D}$  of *red dots* on the interiors of the edges of  $\Gamma$ , labelled by elements of  $\mathbb{R}$  of the following three types:

- A hollow red dot  $\circ$  labelled by  $\omega_1$ , associated to the twist

$$L_n \mapsto -\omega_1 \sum_{k=0}^n p_k^{(e)} p_{n-k}^{(e)}.$$

- A solid red dot  $\bullet$  labelled by  $\omega_2$ , associated to the twist

$$L_n \mapsto -\omega_2 \sum_{k=0}^n p_k^{(e)} \hat{p}_{n-k}^{(e)}.$$

- A triangular red dot  $\triangle$  labelled by  $\lambda$ , associated to the twist

$$L_n \mapsto -\lambda(n+1)p_n^{(e)}$$

A twist induced by a red dot is local, in a sense that it just involves label of a single edge. We can represent this twisted action schematically:

$$(19) \quad L_n * \begin{array}{|c|} \hline \circ \\ \hline \end{array} \omega_1 = L_n \cdot \begin{array}{|c|} \hline \\ \hline \end{array} - \omega_1 \sum_{k=0}^n \begin{array}{|c|} \hline \spadesuit_k \spadesuit_{n-k} \\ \hline \end{array}$$

$$(20) \quad L_n * \begin{array}{|c|} \hline \bullet \\ \hline \end{array} \omega_2 = L_n \cdot \begin{array}{|c|} \hline \\ \hline \end{array} - \omega_2 \sum_{k=0}^n \begin{array}{|c|} \hline \spadesuit_k \hat{\spadesuit}_{n-k} \\ \hline \end{array}$$

$$(21) \quad L_n * \begin{array}{|c|} \hline \triangle \\ \hline \end{array} \lambda = L_n \cdot \begin{array}{|c|} \hline \\ \hline \end{array} - \lambda(n+1) \begin{array}{|c|} \hline \spadesuit_n \\ \hline \end{array}$$

Note that, following Proposition 2.5, the twists from red dots on the target web of a foam are subtracted, while the twists on the source web are added.

**Proposition 4.3.** *For any red-dotted web  $(\Gamma, \mathcal{D})$ , twisting the action of  $L_n$  as described above endows  $\mathcal{F}_N(\Gamma)$  with a  $\mathfrak{W}_{-1}^\infty$ -module structure.*

*Proof.* The proposition is equivalent to showing that the twist maps associated to red dots are Maurer–Cartan elements. Since each twist lands in  $D_\Gamma$ , we only need to show flatness of the following three maps:

$$\begin{aligned}\tau_1(L_n) &= -\omega_1 \sum_{i=0}^n p_i^{(e)} p_{n-i}^{(e)}, \\ \tau_2(L_n) &= -\omega_2 \sum_{i=0}^n p_i^{(e)} \widehat{p}_{n-i}^{(e)}, \\ \tau_3(L_n) &= -\lambda(n+1)p_n^{(e)},\end{aligned}$$

where  $\omega_1, \omega_2$  and  $\lambda$  are elements of  $\mathbb{R}$ . Recall the action of  $L_n$  on  $p_k^{(e)}$  and  $\widehat{p}_{n-k}^{(e)}$ :

$$L_n \cdot p_k^{(e)} = -k p_{k+n}^{(e)} \quad \text{and} \quad L_n \cdot \widehat{p}_k^{(e)} = -k \widehat{p}_{k+n}^{(e)}.$$

Thus,

$$L_m \cdot \tau_1(L_n) = \omega_1 \sum_{i=0}^n \left( i p_{i+m}^{(e)} p_{n-i}^{(e)} + (n-i) p_i^{(e)} p_{n+m-i}^{(e)} \right).$$

Assume without loss of generality that  $n \leq m$ , then,

$$\begin{aligned}L_n \cdot \tau_1(L_m) - L_m \cdot \tau_1(L_n) &= \\ &= \omega_1 \sum_{i=0}^n (m-n) p_i^{(e)} p_{n+m-i}^{(e)} + \omega_1 \sum_{i=n+1}^m (m-i) p_i^{(e)} p_{n+m-i}^{(e)} \\ &\quad - \omega_1 \sum_{i=n}^{m+n} (n-i) p_i^{(e)} p_{n+m-i}^{(e)} - \omega_1 \sum_{i=m}^{n+m} (i-m) p_i^{(e)} p_{n+m-i}^{(e)} \\ &= \omega_1 \sum_{i=0}^n (m-n) p_i^{(e)} p_{n+m-i}^{(e)} + \omega_1 \sum_{i=m}^{m+n} (m-n) p_i^{(e)} p_{n+m-i}^{(e)} \\ &\quad + \omega_1 \sum_{i=n}^{m-1} (i-n) p_i^{(e)} p_{n+m-i}^{(e)} + \omega_1 \sum_{i=n+1}^m (m-i) p_i^{(e)} p_{n+m-i}^{(e)} \\ &= (n-m) \tau_1(L_{m+n}).\end{aligned}$$

This proves that  $\tau_1$  is flat. The computation for  $\tau_2$  is the same. Let us check if  $\tau_3$  is flat:

$$\begin{aligned}L_n \cdot \tau_3(L_m) - L_m \cdot \tau_3(L_n) &= (m\lambda(m+1) - n\lambda(n+1)) p_{n+m}^{(e)} \\ &= (n-m) \tau_3(L_{m+n}).\end{aligned}$$

and, the proof is complete.  $\square$

**Remark 4.4.** By choosing a triangular red dot labelled by  $\frac{\lambda}{2} \in \mathbb{R}$  we find the definition of hollow green dots labelled by  $\lambda$  in the  $\mathfrak{sl}_2$  case defined in [QRSW23].

The following lemma is a reformulation of the condition of being  $\mathfrak{W}_{-1}^\infty$ -equivariant for a morphism in the category  $Tw(\mathbf{Foam})$ .

**Lemma 4.5.** *Let  $(\Gamma_0, \mathcal{D}_0)$  and  $(\Gamma_1, \mathcal{D}_1)$  be two red dotted webs. For  $i \in \{0, 1\}$ ,  $\tau_i : \mathfrak{W}_{-1}^\infty \rightarrow D_{\Gamma_i}$  is the map determined by the collection  $\mathcal{D}_i$  of red dots, so  $(\Gamma_i, \tau_i)$  is an element of  $Tw(\mathbf{Foam})$ . Let  $F$  be a foam in  $\text{Hom}_{Tw(\mathbf{Foam})}((\Gamma_0, \tau_0), (\Gamma_1, \tau_1)) = \mathbf{Foam}(\Gamma_0, \Gamma_1)$ . Then, this morphism is  $\mathfrak{W}_{-1}^\infty$ -equivariant if and only if, for all  $n \in \mathbb{N}_{-1}$ :*

$$(22) \quad L_n * F := L_n \cdot F + \tau_1(L_n)F - \tau_0(L_n)F = 0.$$

The following remark is a direct consequence of equation (22).

**Remark 4.6.** In  $Tw(\mathbf{Foam})$ , a foam  $F \in \mathbf{Foam}(\Gamma_0, \Gamma_1)$  always determines a morphism between  $(\Gamma_0, \alpha_0)$  and  $(\Gamma_1, \alpha_1)$  in  $Tw(\mathbf{Foam})$ , whatever the twists  $\alpha_0$  and  $\alpha_1$ . Suppose that a foam  $F$  induces a  $\mathfrak{W}_{-1}^\infty$ -equivariant morphism in  $Tw(\mathbf{Foam})$  between  $(\Gamma_0, \tau_0)$  and  $(\Gamma_1, \tau_1)$ , where  $\tau_0$  and  $\tau_1$  are maps determined by collections of red dots. Moreover, assume that an edge of  $\Gamma_0$  and an edge of  $\Gamma_1$  both lie on the boundary of the same facet  $f$  of  $F$ , and that one of these edges carries a red dot denoted by  $r$ . Let  $\tau'_0$  and  $\tau'_1$  be the twists induced by the same collections of red dots as  $\tau_0$  and  $\tau_1$ , except for  $r$ , which has migrated along  $f$  and picked up a minus sign on its label. Then, the morphism induced by  $F$  between  $(\Gamma_0, \tau'_0)$  and  $(\Gamma_1, \tau'_1)$  is also  $\mathfrak{W}_{-1}^\infty$ -equivariant.

**Example 4.7.** Here is an example of two  $\mathfrak{W}_{-1}^\infty$ -equivariant morphisms in  $Tw(\mathbf{Foam})$  which are the same foam  $F$  in  $\mathbf{Foam}$  (the unzip foam) after forgetting the twists:

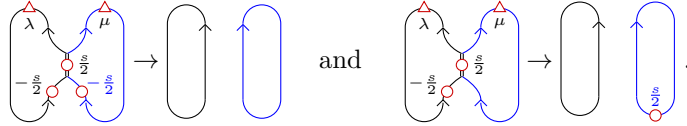

In this example  $r$  is the red dot  $\circ$  first labelled by  $-\frac{s}{2}$  and then by  $\frac{s}{2}$  on the blue facet.

By the Leibniz rule, red-dotted twists are additive. Thus we trivially obtain the following identities between state spaces:

**Lemma 4.8.** *We have the following relations between state spaces:*

$$(23) \quad \begin{array}{c} \omega_1 \quad \omega_2 \\ \circ \quad \circ \\ \hline \end{array} \rightarrow a = \begin{array}{c} \omega_1 + \omega_2 \\ \circ \\ \hline \end{array} \rightarrow a$$

$$(24) \quad \begin{array}{c} \omega_1 \quad \omega_2 \\ \bullet \quad \bullet \\ \hline \end{array} \rightarrow a = \begin{array}{c} \omega_1 + \omega_2 \\ \bullet \\ \hline \end{array} \rightarrow a$$

$$(25) \quad \begin{array}{c} \omega_1 \quad \omega_2 \\ \triangle \quad \triangle \\ \hline \end{array} \rightarrow a = \begin{array}{c} \omega_1 + \omega_2 \\ \triangle \\ \hline \end{array} \rightarrow a$$

To simplify our computations, we introduce the following notation:

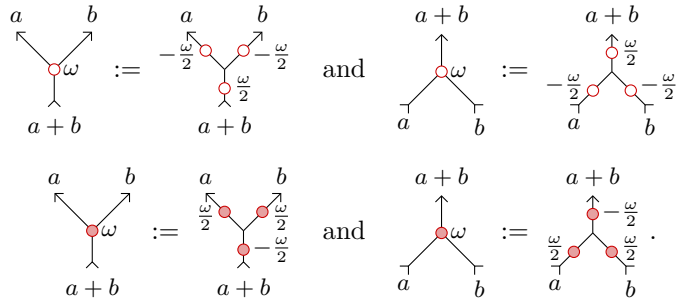

Lemmas 4.9 and 4.10 are consequences of the dot migration which is the relation [RW20a, (11)].

**Lemma 4.9.** *We have the following relation between state spaces:*

$$(26) \quad \begin{array}{c} a \quad b \\ \diagdown \quad \diagup \\ \bullet \\ \diagup \quad \diagdown \\ a+b \end{array} = \begin{array}{c} a \quad b \\ \diagdown \quad \diagup \\ \circ \\ \diagup \quad \diagdown \\ a+b \end{array} \quad \text{and} \quad \begin{array}{c} a+b \\ \uparrow \\ \bullet \\ \diagdown \quad \diagup \\ a \quad b \end{array} = \begin{array}{c} a+b \\ \uparrow \\ \circ \\ \diagdown \quad \diagup \\ a \quad b \end{array} .$$

**Lemma 4.10.** *We have the following relations between state spaces:*

$$(27) \quad \begin{array}{c} \diagup \quad \diagdown \\ \circ \\ \diagdown \quad \diagup \\ \circ \\ \diagup \quad \diagdown \\ \omega \quad \omega \end{array} = \begin{array}{c} \omega \quad \omega \\ \diagdown \quad \diagup \\ \circ \\ \diagup \quad \diagdown \\ \omega \quad \omega \end{array} \quad \text{and} \quad \begin{array}{c} \diagup \quad \diagdown \\ \circ \\ \diagdown \quad \diagup \\ \omega \quad \omega \end{array} = \begin{array}{c} \diagup \quad \diagdown \\ \circ \\ \diagdown \quad \diagup \\ \omega \quad \omega \end{array} .$$

**Lemma 4.11.** *We have the following relation between state spaces:*

$$(28) \quad \begin{array}{c} \omega \\ \uparrow \\ \triangle \\ \rightarrow 1 \end{array} = \begin{array}{c} \omega \\ \uparrow \\ \circ \\ \rightarrow 1 \end{array} .$$

**4.3. Useful morphisms.** In this section, we give examples of  $\mathfrak{W}_{-1}^\infty$ -equivariant morphisms that we will often use. Throughout the paper, we will use the notation for morphisms introduced in the following lemmas.

**Lemma 4.12.** *The two orientations for the following foam:*

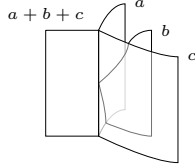

induce two  $\mathfrak{W}_{-1}^\infty$ -equivariant isomorphisms:

$$\alpha : \begin{array}{c} a \quad b \quad c \\ \diagdown \quad \diagup \quad \diagup \\ \bullet \\ \diagup \quad \diagdown \\ a+b+c \end{array} \rightarrow \begin{array}{c} a \quad b \quad c \\ \diagdown \quad \diagup \quad \diagup \\ \circ \\ \diagup \quad \diagdown \\ a+b+c \end{array} \quad \text{and} \quad \alpha : \begin{array}{c} a+b+c \\ \uparrow \\ \bullet \\ \diagdown \quad \diagup \quad \diagup \\ a \quad b \quad c \end{array} \rightarrow \begin{array}{c} a+b+c \\ \uparrow \\ \circ \\ \diagdown \quad \diagup \quad \diagup \\ a \quad b \quad c \end{array} .$$

**Lemma 4.13.** *The two following foams:*

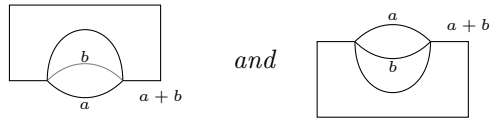

induce two  $\mathfrak{W}_{-1}^\infty$ -equivariant morphisms:

$$\zeta : \begin{array}{c} a+b \\ \uparrow \\ \triangle \\ \diagdown \quad \diagup \\ a \quad b \\ \downarrow \\ \circ \\ \diagup \quad \diagdown \\ a+b \end{array} \rightarrow \begin{array}{c} a+b \\ \uparrow \\ \bullet \\ \diagup \quad \diagdown \\ a+b \end{array} \quad \text{and} \quad \rho : \begin{array}{c} a+b \\ \uparrow \\ \bullet \\ \diagup \quad \diagdown \\ a+b \end{array} \rightarrow \begin{array}{c} a+b \\ \uparrow \\ \triangle \\ \diagdown \quad \diagup \\ a \quad b \\ \downarrow \\ \circ \\ \diagup \quad \diagdown \\ a+b \end{array} .$$



*Proof.* We prove that  $\rho$  is indeed  $\mathfrak{W}_{-1}^\infty$ -equivariant:

$$\begin{aligned} L_n \left( \begin{array}{c} a \quad a+b \\ \text{---} \\ b \\ \text{---} \end{array} \right) &= \lambda_n \begin{array}{c} a \quad a+b \\ \text{---} \\ b \spadesuit_n \spadesuit_0 \\ \text{---} \end{array} + \mu_n \begin{array}{c} a \quad a+b \\ \text{---} \\ b \spadesuit_0 \spadesuit_n \\ \text{---} \end{array} \\ &+ s \sum_{k+l=n} \begin{array}{c} a \quad a+b \\ \text{---} \\ b \spadesuit_k \spadesuit_l \\ \text{---} \end{array} - b \lambda_n \begin{array}{c} a \quad a+b \\ \text{---} \\ b \\ \text{---} \end{array} - a \mu_n \begin{array}{c} a \quad a+b \\ \text{---} \\ b \\ \text{---} \end{array} \\ &- \frac{s}{2} \sum_{k+l=n} \left( \begin{array}{c} a \quad a+b \\ \text{---} \\ b \spadesuit_k \spadesuit_l \\ \text{---} \end{array} - \begin{array}{c} a \quad a+b \\ \text{---} \\ b \spadesuit_k \spadesuit_l \\ \text{---} \end{array} - \begin{array}{c} a \quad a+b \\ \text{---} \\ b \spadesuit_k \spadesuit_l \\ \text{---} \end{array} \right). \end{aligned}$$

We denote by  $\spadesuit_i^a$  a decoration on the facet of thickness  $a$ . By definition of  $\spadesuit_i$  for all  $i \in \mathbb{N}$  we have:

$$\spadesuit_i^{a+b} = \spadesuit_i^a + \spadesuit_i^b.$$

By using this identity, the computation between the parenthesis can be summarized by:

$$\sum_{k+l=n} \spadesuit_k^{a+b} \spadesuit_l^{a+b} - \spadesuit_k^a \spadesuit_l^a - \spadesuit_k^b \spadesuit_l^b = 2 \sum_{k+l=n} \spadesuit_k^a \spadesuit_l^b.$$

Thus, we obtain that

$$L_n \left( \begin{array}{c} a \quad a+b \\ \text{---} \\ b \\ \text{---} \end{array} \right) = 0.$$

□

The proofs of the following lemmas are analogous and are left to the reader.

**Lemma 4.14.** *The two following foams:*

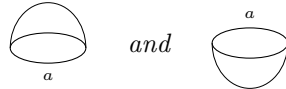

induce two  $\mathfrak{W}_{-1}^\infty$ -equivariant morphisms:

$$\kappa : \begin{array}{c} \text{---} \\ \text{---} \end{array} \begin{array}{c} \text{---} \\ \text{---} \end{array} \begin{array}{c} a \\ \text{---} \end{array} \rightarrow \emptyset \quad \text{and} \quad \kappa : \emptyset \rightarrow \begin{array}{c} \text{---} \\ \text{---} \end{array} \begin{array}{c} \text{---} \\ \text{---} \end{array} \begin{array}{c} a \\ \text{---} \end{array}.$$

**Lemma 4.15.** *The foam:*

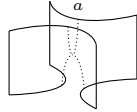

induces the following  $\mathfrak{W}_{-1}^\infty$ -equivariant morphism:

$$\sigma : \begin{array}{c} a \\ \text{---} \\ a \end{array} \rightarrow \begin{array}{c} a \\ \text{---} \\ a \end{array} \begin{array}{c} \text{---} \\ \text{---} \end{array} \begin{array}{c} \text{---} \\ \text{---} \end{array} \begin{array}{c} a \\ \text{---} \\ a \end{array}.$$

**Lemma 4.16.** *The two following foams:*

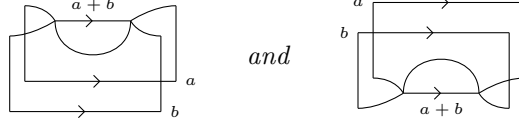

induce two  $\mathfrak{W}_{-1}^\infty$ -equivariant morphisms:

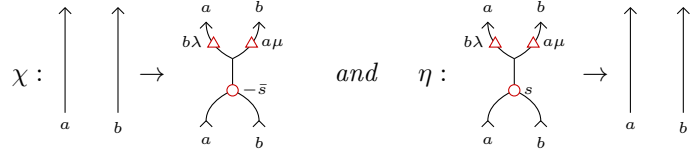

**Lemma 4.17.** *The singular saddle:*

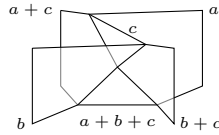

induces the following morphism:

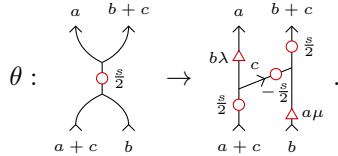

5. A HOMOLOGICAL INVARIANT

From now on, we will use the following convention in web diagrams: an edge of thickness 1 will always be represented by a single edge (—), a double edge (==) represents thickness 2, and in the proof of the Reidemeister III move, an edge of thickness 3 will be depicted by a thicker edge (—).

**5.1. Definition of a link homology.** In the previous section, we built the foundations for the construction of Khovanov–Rozansky  $\mathfrak{gl}_N$ -link homology. As with Khovanov homology, we construct a hypercube complex for any link diagrams by specifying locally a length two complex at each crossing. We define the following cohomologically graded braiding complexes:

(29)

$$(30) \quad \begin{array}{c} \diagup \quad \diagdown \\ \diagdown \quad \diagup \end{array} := \begin{array}{c} \uparrow \\ \uparrow \end{array} \xrightarrow{\quad} q^{-1} \begin{array}{c} \lambda \quad \mu \\ \diagdown \quad \diagup \\ \text{---} \bar{s} \\ \diagup \quad \diagdown \\ \text{~~~~~} \end{array}$$

where, in both complexes, it is assumed that the term underlying by a zigzag lies in cohomological degree 0. In these diagrams,  $\mathcal{F}_N(\cdot)$  has been omitted for clarity.

For a link  $L$ , let  $\text{KRW}_N(L, \mathbb{R}) := \text{KRW}_{N, \lambda, \mu, s}(L, \mathbb{R})$  be the Khovanov–Rozansky  $\mathfrak{gl}_N$ -homology of  $L$  with coefficients in a ring  $\mathbb{R}$ , equipped with the action of the Hopf algebra  $\mathcal{U}(\mathfrak{W}_{-1}^\infty)$ . To prevent overloaded diagrams, we will often drop  $\text{KRW}_N(\cdot)$  around them. Sometimes we will use the notation  $t^i S$ , where  $S$  is a state space. This notation indicates that  $S$  is in cohomological degree  $i$  in an explicit chain of complex. The rest of the section is devoted to proving the following theorem:

**Theorem 5.1.** *Let  $L$  be a framed oriented link diagram. The chain complex  $\text{KRW}_N(L)$  is invariant under Reidemeister moves in the relative homotopy category.*

**5.2. The sliding lemmas.** The proof of this lemma originates from [KR16] and its formulation in the  $\mathfrak{sl}_2$  case can be found in [QRSW23].

**Lemma 5.2.** *Let  $\omega$  be an element in  $\mathbb{R}$ , there is an isomorphism in the relative homotopy category:*

$$(31) \quad {}_x C := \begin{array}{c} \diagup \quad \diagdown \\ \diagdown \quad \diagup \\ \omega \end{array} \cong \begin{array}{c} \diagup \quad \diagdown \\ \diagdown \quad \diagup \\ \omega \end{array} =: C_y.$$

*Proof.* Recall the following notation:

$$\chi = \begin{array}{c} \text{---} \\ \diagdown \quad \diagup \\ \text{---} \end{array}, \quad \eta = \begin{array}{c} \text{---} \\ \diagup \quad \diagdown \\ \text{---} \end{array}$$

The proof proceeds by extending the polynomial rings with a new variable  $z$  that twists can be transferred onto. We can imagine that the variable  $z$  represents a disjoint circle at infinity where red dots on any edge can be moved to and from.

Let  $x$  be the variable involved in the lower left red dot, and  $y$  the variable involved in the upper right red dot. Let  $\mathbb{R}_N[z] = \mathbb{R}[E_1, \dots, E_N][z]$ , the  $\mathfrak{W}_{-1}^\infty$ -action can be extended to this algebra by defining

$$L_n \cdot z^k := -kz^{k+n}.$$

Let  $S$  be a state space associated with a web, and define  $S[z] := S \otimes_{\mathbb{R}_N} \mathbb{R}_N[z]$ . The notation  $S[z]^{\gamma z} = S \otimes_{\mathbb{R}_N} \mathbb{R}_N[z]^{\gamma z}$  denotes the twisted  $\mathfrak{W}_{-1}^\infty$  representation defined by:

$$L_n \cdot z^k = -kz^{k+n} - \gamma(n+1)z^{k+n}.$$

In other words  $\mathbb{R}_N[z]$  is twisted by the map  $L_n \mapsto -\gamma(n+1)z^n \text{Id}_{\mathbb{R}_N[z]}$ . For a given state space  $S[z]$ , the notation  $S[z]^{\star z}$  refers to the  $\mathfrak{W}_{-1}^\infty$ -representation twisted by  $L_n \mapsto -h_n(x, z) \text{Id}_{\mathbb{R}_N[z]}$ .

We can fit  ${}_x C$  into a short exact sequence of complexes, where each map is  $\mathfrak{W}_{-1}^\infty$ -equivariant (the verification is left to the reader):

(32)

This short exact sequence splits when the  $\mathfrak{W}_1^\infty$ -action is forgotten, and the complex  ${}_x C''$  is null-homotopic. Hence, by Corollary 2.3,  ${}_x C$  and  ${}_x C'$  are isomorphic in the relative homotopy category.

Let  ${}_x C[z] = {}_x C \otimes_{R_N} R_N[z]$  denotes the complex  ${}_x C$  with all state spaces replaced with their tensor product with  $R_N[z]$ . The map  $x$  denotes the foam which adds an  $x$  decoration and  $z$  denotes multiplication by the variable  $z$ . Then the map  $x - z$  defines a chain map  ${}_x C[z] \rightarrow {}_x C[z]$  with twists added in the appropriate places. The complex  ${}_x C$  is the cokernel of the map  $x - z$ , the complex  ${}_x C'$  is the cone of this map, and the complex  ${}_x C''$  is the cone of the identity map. Thus we can view this step as a cofibrant replacement of our braiding complex which gives us more space to move our twists.

Similarly, we produce the following complex for  $C^y$ :

(33)

The red arrows indicate that the action of  $\mathfrak{W}_{-1}^\infty$  is further twisted on the middle terms by Maurer–Cartan elements:

$$(1) : L_n \mapsto h_n(x, z) - h_n(x, y) \begin{pmatrix} 0 & 0 \\ 0 & \chi \end{pmatrix}$$

and

$$(2) : L_n \mapsto \frac{h_n(y, z) - h_n(x, z)}{x - y} \begin{pmatrix} 0 & 0 \\ 0 & \chi \end{pmatrix}$$

To verify that these are Maurer–Cartan elements and that all maps are  $\mathfrak{W}_{-1}^\infty$ -equivariant, we need the following identity:

$$h_n(x, z) - h_n(x, y) = (y - z) \frac{h_n(y, z) - h_n(x, z)}{x - y}.$$

Hence, we obtain  $C^y \cong C'^y$ .

For a better understanding of the twists introduced in this proof, we provide the action of  $\mathfrak{W}_{-1}^\infty$  on an element denoted by  $F = F_1 + F_2$  from the following direct sum of state spaces:

$$(34) \quad M = \begin{array}{c} \begin{array}{c} \lambda \nearrow \Delta \nearrow \mu \\ \circlearrowleft s \\ \lambda \searrow \Delta \searrow \mu \end{array} \xrightarrow{\star_y^z} \begin{array}{c} [z]^{\omega z} \oplus \\ \uparrow \\ [z]^{\omega z} \end{array} \end{array}$$

(2)

The action is given by the following formula:

$$\begin{aligned} L_n \cdot_M F &= L_n \cdot F - (\lambda(n+1)x^n + \mu(n+1)y^n)F_1 - (n+1)sx^n F_1 - h(z, y)F_1 \\ &\quad - h_n(z, x)F_2 + \frac{h_n(y, z) - h_n(x, z)}{x - y} \chi \circ F_2. \end{aligned}$$

Finally, there is an isomorphism between  ${}_x C'$  and  $C'^y$ :

$$(35) \quad \begin{array}{c} \begin{array}{c} \lambda \nearrow \Delta \nearrow \mu \\ \circlearrowleft s \\ \lambda \searrow \Delta \searrow \mu \end{array} \xrightarrow{\star_x^z} \begin{array}{c} [z]^{\omega z} \xrightarrow{\left(\frac{z-x}{\eta}\right)} \\ \uparrow \\ [z]^{\omega z} \oplus \end{array} \begin{array}{c} \uparrow \\ [z]^{\omega z} \oplus \\ \uparrow \\ [z]^{\omega z} \end{array} \xrightarrow{(\eta x - z)} \begin{array}{c} \uparrow \\ [z]^{\omega z} \\ \uparrow \\ [z]^{\omega z} \end{array} \\ \text{Id} \uparrow \qquad \qquad \qquad \begin{pmatrix} 1 & \chi \\ 0 & 1 \end{pmatrix} \uparrow \qquad \qquad \qquad \text{Id} \uparrow \\ \begin{array}{c} \lambda \nearrow \Delta \nearrow \mu \\ \circlearrowleft s \\ \lambda \searrow \Delta \searrow \mu \end{array} \xrightarrow{\star_x^z} \begin{array}{c} [z]^{\omega z} \xrightarrow{\left(\frac{z-y}{\eta}\right)} \\ \uparrow \\ [z]^{\omega z} \oplus \end{array} \begin{array}{c} \uparrow \\ [z]^{\omega z} \oplus \\ \uparrow \\ [z]^{\omega z} \end{array} \xrightarrow{(\eta y - z)} \begin{array}{c} \uparrow \\ [z]^{\omega z} \\ \uparrow \\ [z]^{\omega z} \end{array} \end{array},$$

(1)

This proves that  ${}_x C \cong C^y$ .  $\square$

The proof of the following lemma is straightforward by using the Lemma 4.10:

**Lemma 5.3.** *Let  $\omega$  be an element of  $\mathbb{R}$ , there is an isomorphism in the relative homotopy category:*

$$(36) \quad \begin{array}{c} \begin{array}{c} \omega \circlearrowleft \\ \omega \circlearrowright \end{array} \cong \begin{array}{c} \omega \circlearrowleft \\ \omega \circlearrowright \end{array} \end{array}$$

**Corollary 5.4.** *Let  $\omega$  and  $\varepsilon$  be elements of  $\mathbb{R}$ , there are isomorphisms in the relative homotopy category:*

$$(37) \quad \begin{array}{c} \nearrow \\ \omega \circlearrowleft \quad \circlearrowright \varepsilon \\ \searrow \end{array} \cong \begin{array}{c} \hat{\varepsilon} \circlearrowleft \quad \hat{\omega} \circlearrowright \\ \nearrow \\ \searrow \end{array} \quad \text{and} \quad \begin{array}{c} \searrow \\ \omega \circlearrowleft \quad \circlearrowright \varepsilon \\ \nearrow \end{array} \cong \begin{array}{c} \hat{\varepsilon} \circlearrowleft \quad \hat{\omega} \circlearrowright \\ \searrow \\ \nearrow \end{array},$$

*Proof.* The first isomorphism of (37) is deduced from Lemmas 5.2, 5.3, and the properties of red dots:

$$(38) \quad \begin{array}{c} \nearrow \\ \omega \circlearrowleft \quad \circlearrowright \varepsilon \\ \searrow \end{array} \cong \begin{array}{c} \nearrow \\ \omega \circlearrowleft \quad \circlearrowright \varepsilon \\ \circlearrowleft \varepsilon \quad \circlearrowright \omega \\ \searrow \end{array} \cong \begin{array}{c} \nearrow \\ \varepsilon \circlearrowleft \quad \omega \circlearrowright - \varepsilon \\ \circlearrowleft \varepsilon \quad \circlearrowright \omega \\ \searrow \end{array} \cong \begin{array}{c} \hat{\varepsilon} \circlearrowleft \quad \hat{\omega} \circlearrowright \\ \nearrow \\ \searrow \end{array}$$

To prove the second isomorphism in (37), one needs to use Proposition 5.9, which does not rely on it.

$$(39) \quad \begin{array}{c} \searrow \\ \omega \circlearrowleft \quad \circlearrowright \varepsilon \\ \nearrow \end{array} \stackrel{\text{RII}}{\cong} \begin{array}{c} \nearrow \\ \omega \circlearrowleft \quad \circlearrowright \varepsilon \\ \searrow \\ \nearrow \\ \omega \circlearrowleft \quad \circlearrowright \varepsilon \\ \searrow \end{array} \cong \begin{array}{c} \searrow \\ \varepsilon \circlearrowleft \quad \omega \circlearrowright \\ \nearrow \\ \searrow \\ \varepsilon \circlearrowleft \quad \omega \circlearrowright \\ \nearrow \end{array} \stackrel{\text{RII}}{\cong} \begin{array}{c} \hat{\varepsilon} \circlearrowleft \quad \hat{\omega} \circlearrowright \\ \searrow \\ \nearrow \end{array}$$

That end the proof.  $\square$

The following corollary becomes immediate thanks to Lemma 4.11.

**Corollary 5.5.** *Let  $\lambda$  and  $\mu$  be elements of  $\mathbb{R}$ . There is an isomorphism in the relative homotopy category:*

$$\begin{array}{c} \nearrow \\ \lambda \triangleleft \quad \triangleleft \mu \\ \searrow \end{array} \cong \begin{array}{c} \hat{\mu} \triangleleft \quad \triangleleft \hat{\lambda} \\ \nearrow \\ \searrow \end{array}.$$

**Lemma 5.6.** *Let  $\omega$  and  $\varepsilon$  be elements of  $\mathbb{R}$ , there are isomorphisms in the relative homotopy category:*

$$(40) \quad \begin{array}{c} \nearrow \\ \omega \circlearrowleft \quad \circlearrowright \varepsilon \\ \searrow \end{array} \cong \begin{array}{c} \hat{\varepsilon} \circlearrowleft \quad \hat{\omega} \circlearrowright \\ \nearrow \\ \searrow \end{array} \quad \text{and} \quad \begin{array}{c} \searrow \\ \omega \circlearrowleft \quad \circlearrowright \varepsilon \\ \nearrow \end{array} \cong \begin{array}{c} \hat{\varepsilon} \circlearrowleft \quad \hat{\omega} \circlearrowright \\ \searrow \\ \nearrow \end{array}.$$

*Proof.* We only need to prove the following relation,

$$(41) \quad \begin{array}{c} \nearrow \\ \omega \circlearrowleft \\ \searrow \end{array} \cong \begin{array}{c} \nearrow \\ \omega \circlearrowleft \\ \circlearrowleft \omega \\ \searrow \end{array},$$

the rest of the proof uses exactly the same arguments as those in the proof of the Corollary 5.4.

To avoid dealing with the  $N - 1$  variables involved in this twist, we introduce a new type of dot associated with the twist  $L_n \mapsto -\omega \sum_{k=0}^n p_k^{(e)} P_{n-k}$  (with notations of Definition 4.2):

$$(42) \quad L_n \cdot \begin{array}{|c|} \hline \bullet \\ \hline \omega \\ \hline \end{array} = L_n \cdot \begin{array}{|c|} \hline \\ \hline \end{array} - \omega \sum_{k=0}^n \begin{array}{|c|} \hline \spadesuit_k P_{n-k} \\ \hline \end{array}.$$

The proof that the map induced by this twist is flat consists of the same computations as in the proof of Proposition 4.3. Then, since  $P_{n-k} = p_{n-k}^{(e)} + \hat{p}_{n-k}^{(e)}$ , we have the relation:

$$\xrightarrow{\omega} \textcircled{\bullet} \rightarrow a = \xrightarrow{-\omega} \textcircled{\circ} \xrightarrow{\omega} \bullet \rightarrow a.$$

Thus, with Lemma 5.2, proving that

$$(43) \quad \begin{array}{c} \nearrow \\ \searrow \\ \bullet \end{array} \cong \begin{array}{c} \nearrow \\ \searrow \\ \bullet \end{array} \xrightarrow{\omega},$$

is sufficient to establish (41).

The proof of (43) is exactly the same as the proof of Lemma 5.2 except of one detail, we need to change the twist on  $R_N[z]$ . The notation  $S[z]^{\gamma z} = S \otimes R_N[z]^{\gamma z}$  denotes, in this case, a twisted  $\mathfrak{W}_{-1}^{\infty}$ -representation defined as follows:

$$L_n \cdot z^k = -kz^{k+n} - \gamma \left( \sum_{j=0}^n z^j P_{n-j} \right) z^k,$$

where  $P_{n-j} \in R_N$ . □

### 5.3. Reidemeister I.

**Proposition 5.7.** *There are isomorphisms in the relative homotopy category:*

$$(44) \quad \begin{array}{c} \nearrow \\ \searrow \\ \bullet \end{array} \cong t^{-1} q^{N-1} \begin{array}{c} \uparrow \\ \textcircled{\bullet} \\ \uparrow \end{array} \quad \text{and} \quad \begin{array}{c} \nearrow \\ \searrow \\ \bullet \end{array} \cong tq^{1-N} \begin{array}{c} \uparrow \\ \textcircled{\circ} \\ \uparrow \end{array}.$$

*Proof.* We only present the proof for the first isomorphism since the second uses the same ideas. Thanks to the Lemma 5.6 the existence of the following isomorphism is enough:

$$(45) \quad \begin{array}{c} \nearrow \\ \searrow \\ \bullet \end{array} \cong t^{-1} q^{N-1} \begin{array}{c} \uparrow \\ \textcircled{\bullet} \\ \uparrow \end{array}.$$

The first complex is defined to be:

$$\begin{array}{c} \nearrow \\ \searrow \\ \bullet \end{array} \cong t^{-1} \begin{array}{c} \uparrow \\ \textcircled{\bullet} \\ \uparrow \end{array} \xrightarrow{\chi} q^{-1} \begin{array}{c} \nearrow \\ \searrow \\ \textcircled{\bullet} \\ \nearrow \\ \searrow \\ \bullet \end{array}.$$

We embed these two complexes in a short exact sequence of  $\mathfrak{W}_{-1}^{\infty}$ -equivariant complexes that splits when one forgets the  $\mathfrak{W}_{-1}^{\infty}$  action:

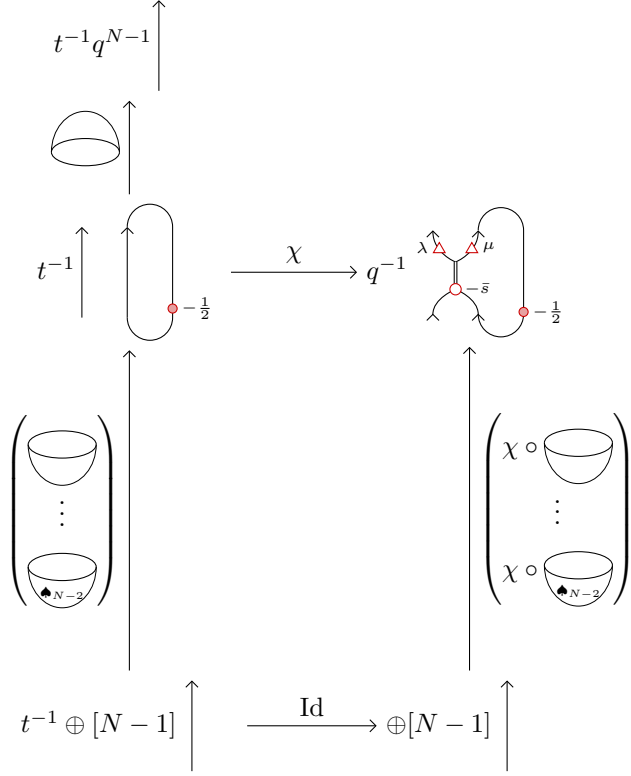

Note that the splitting of the bottom complex does not respect the  $\mathfrak{W}_{-1}^\infty$ -structure. However, it is isomorphic to the kernel of the top morphism as a vector space, and thus there is an induced action on it that we do not specify. The important thing is that this complex is null-homotopic. Thus, by using Corollary 2.3 we have found the desired isomorphism in (45) in the relative homotopy category. By taking the negative twisting, we obtain the first isomorphism in (44).  $\square$

5.4. **Reidemeister II.** The following result can be proved with simple computations.

**Lemma 5.8.** *There is a short exact sequence of webs that splits when the action of  $\mathfrak{W}_{-1}^\infty$  is forgotten:*

(46)



where the splitting maps are provided by:

$$\zeta^X - X\zeta = \left[ \begin{array}{c} \square \\ \text{Diagram 1} \end{array} \right] - \left[ \begin{array}{c} \square \\ \text{Diagram 2} \end{array} \right]$$

$$\rho^X - X\rho = \left[ \begin{array}{c} \square \\ \text{Diagram 3} \end{array} \right] - \left[ \begin{array}{c} \square \\ \text{Diagram 4} \end{array} \right]$$

**Proposition 5.9.** *There are isomorphisms in the relative homotopy category:*

$$\begin{array}{c} \curvearrowright \cong \uparrow \\ \curvearrowleft \end{array} \quad \begin{array}{c} \uparrow \\ \cong \\ \uparrow \end{array} \quad \begin{array}{c} \uparrow \\ \cong \\ \curvearrowright \\ \curvearrowleft \end{array}$$

*Proof.* The constructions of both isomorphisms are the same; we will prove the first one. By definition, we have:

$$(47) \quad \begin{array}{c} \curvearrowright \\ \curvearrowleft \end{array} = \begin{array}{c} \begin{array}{ccc} & \uparrow & \uparrow \\ & \eta & \chi \\ \begin{array}{c} \lambda \uparrow \Delta \mu \\ \downarrow \\ \text{red circle} \\ \downarrow \\ \lambda \end{array} & & \begin{array}{c} \lambda \uparrow \Delta \mu \\ \downarrow \\ \text{red circle} \\ \downarrow \\ \lambda \end{array} \\ & \searrow^{-\chi} & \nearrow^{\eta} \\ & \begin{array}{c} \lambda \uparrow \Delta \mu \\ \downarrow \\ \text{red circle} \\ \downarrow \\ \lambda \end{array} & & \begin{array}{c} \lambda \uparrow \Delta \mu \\ \downarrow \\ \text{red circle} \\ \downarrow \\ \lambda \end{array} \\ & & & \begin{array}{c} \lambda \uparrow \Delta \mu \\ \downarrow \\ \text{red circle} \\ \downarrow \\ \lambda \end{array} \end{array} \end{array}$$

Thanks to Lemma 5.8 we can place this complex in a short exact sequence of complexes that splits when forgetting the  $\mathfrak{W}_{-1}^\infty$ -action.

(48)

The diagram consists of three vertically stacked boxes, each enclosed in a dotted line. The top box shows a complex starting with a zero object  $0$  on the left. Two arrows point from  $0$  to a diagram with two red triangles and a circle, labeled  $q^{-1}$ . From this diagram, two arrows point to another diagram with two red triangles and a circle, labeled  $q^{-1}$ . The top arrow is labeled  $\chi$  and the bottom arrow is labeled  $\text{Id}$ . The middle box shows a complex starting with a diagram with two red triangles and a circle, labeled  $q$ . Two arrows point from  $q$  to a zero object  $0$  in the middle. From  $0$ , two arrows point to a diagram with two red triangles and a circle, labeled  $q^{-1}$ . The top arrow is labeled  $\eta$  and the bottom arrow is labeled  $\eta$ . The bottom box shows a complex starting with a diagram with two red triangles and a circle, labeled  $q$ . Two arrows point from  $q$  to a zero object  $0$  in the middle. From  $0$ , two arrows point to a diagram with two red triangles and a circle, labeled  $q^{-1}$ . The top arrow is labeled  $-\text{Id}$  and the bottom arrow is labeled  $-\text{Id}$ . Vertical arrows connect the zero objects of the top and middle complexes, and the zero objects of the middle and bottom complexes.

The last complex is contractible, thus by using Corollary 2.3, the first and the second complexes are isomorphic in the relative homotopy category. Moreover, in the first complex, we can contract out terms:

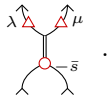

thus the complex is isomorphic to:



Note that the proof of the previous proposition does not require any result of Section 5.2, which allows us to use it within the same section.

**Proposition 5.10.** *There is an isomorphism in the relative homotopy category:*

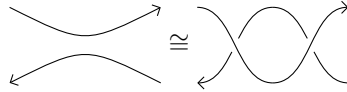

*Proof.* By using the additivity and sliding of dots in Lemma 5.6, we can add the following pair of dots to our diagram:

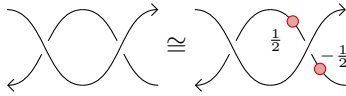

By definition, the second complex is given by:

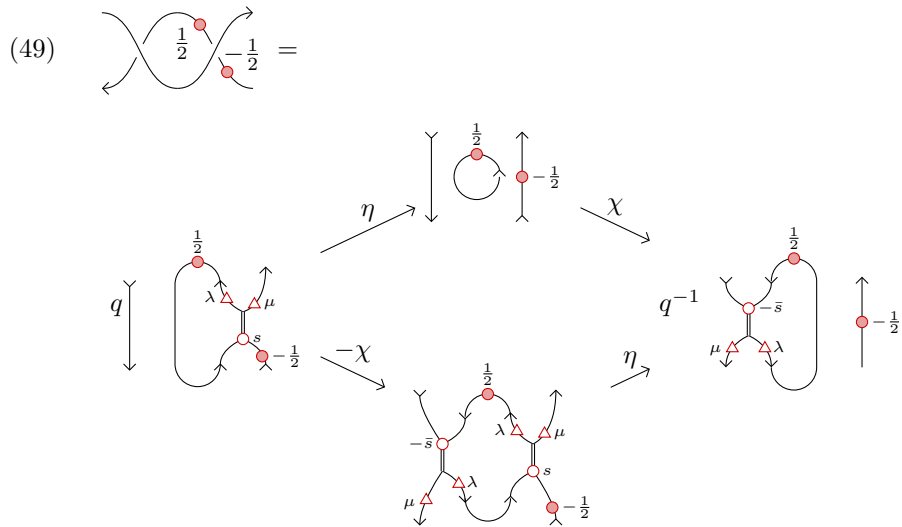

The following map is a homotopy equivalence when forgetting the  $\mathfrak{W}_{-1}^\infty$ -action, so it induces an isomorphism in the relative homotopy category:

(50)

Let us check that the morphisms are indeed  $\mathfrak{W}_{-1}^\infty$ -equivariant. We can represent  $\sigma \circ \chi\chi \circ \kappa\kappa$  with the following movie:

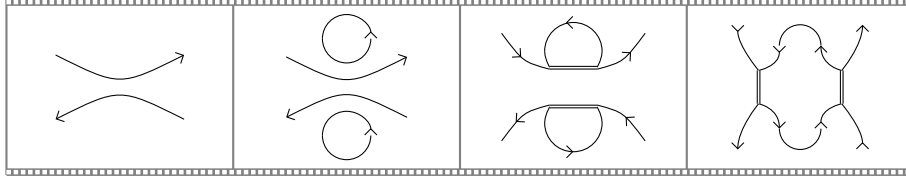

Twists induced by lemmas (4.14), (4.15), and (4.16) for the morphism  $\sigma \circ \chi\chi \circ \kappa\kappa$  are the following:

Where the identity is due to Lemma 4.9. In the above case, this relation takes the following form:

Thus, the map  $\sigma \circ \chi\chi \circ \kappa\kappa$  in (50) is indeed  $\mathfrak{W}_{-1}^\infty$ -equivariant. The computation for  $\kappa \circ \sigma$  is easier than the previous one and is left to the reader as an exercise.  $\square$

5.5. Reidemeister III.

**Proposition 5.11.** *There are isomorphisms in the relative homotopy category:*

(51) 

*Proof.* In the following proof, we omit canonical differentials and  $q$ -shifts for readability. The complex on the left-hand side in (51) is given by:

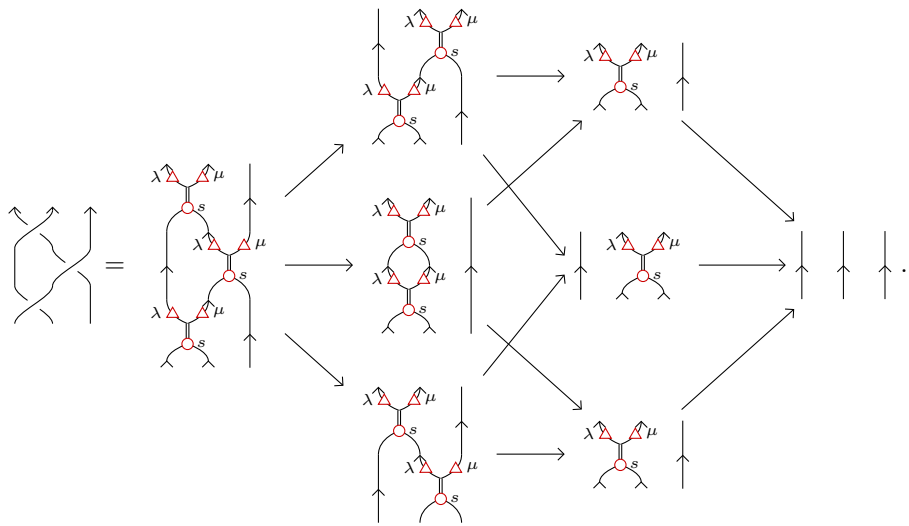
(52) 

We embed this complex in a short exact sequence of  $\mathfrak{W}_{-1}^\infty$ -equivariant complexes that splits when we forget the  $\mathfrak{W}_{-1}^\infty$  action:

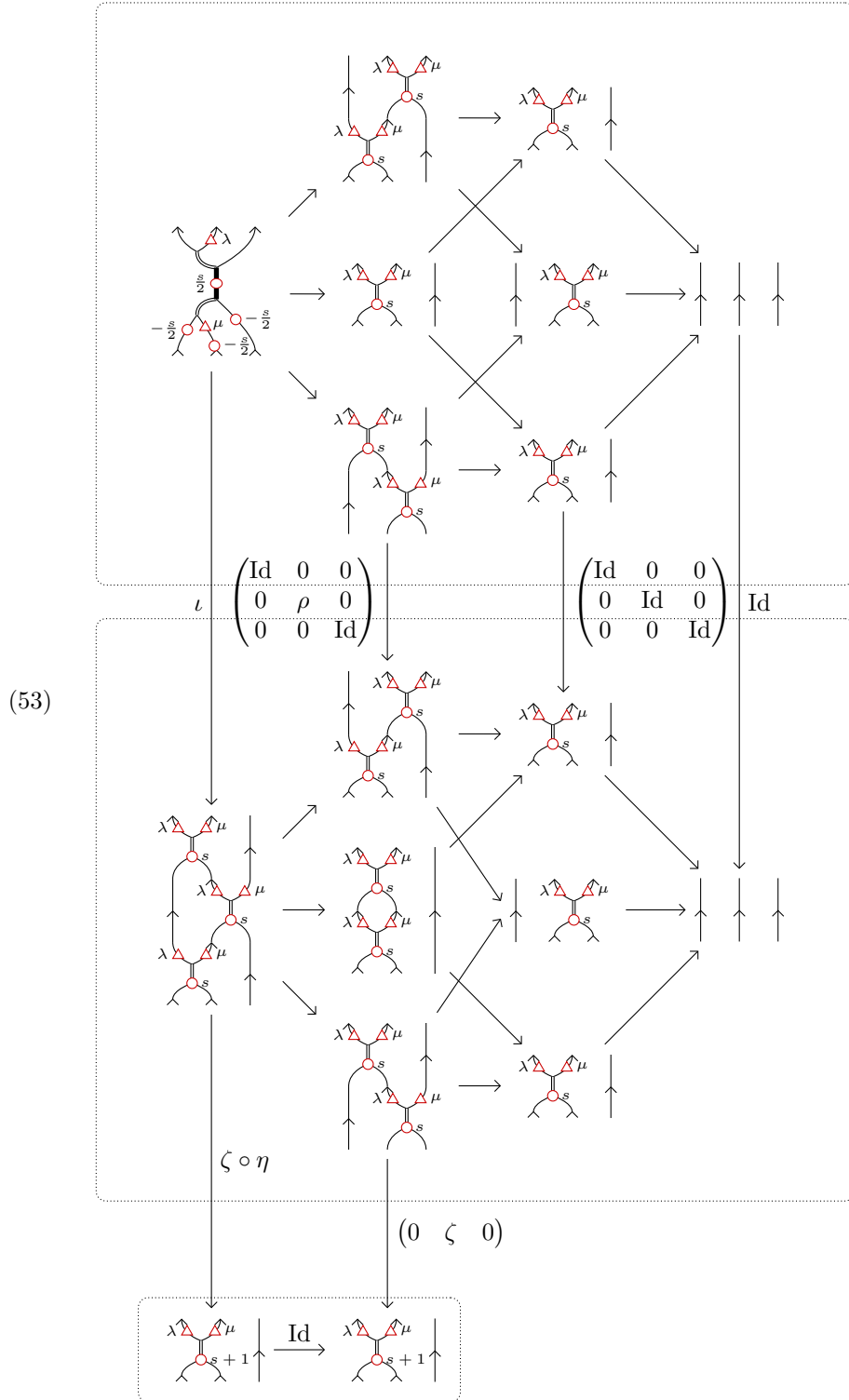

Where the thickest edge of the web at the top left is an edge of thickness 3. The map  $\iota := \theta \circ \alpha \circ \rho$  is the composition of a digon-cup, associativity, and the singular saddle. Its movie is:

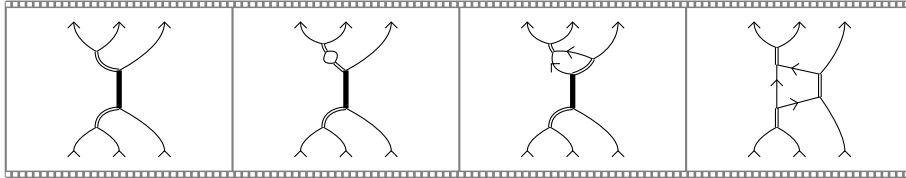

Since the bottom complex is acyclic, the two other complexes are isomorphic in the relative homotopy category.

There is a short exact sequence of  $\mathfrak{W}_{-1}^\infty$ -equivariant complexes that splits when one forgets the  $\mathfrak{W}_{-1}^\infty$  action:

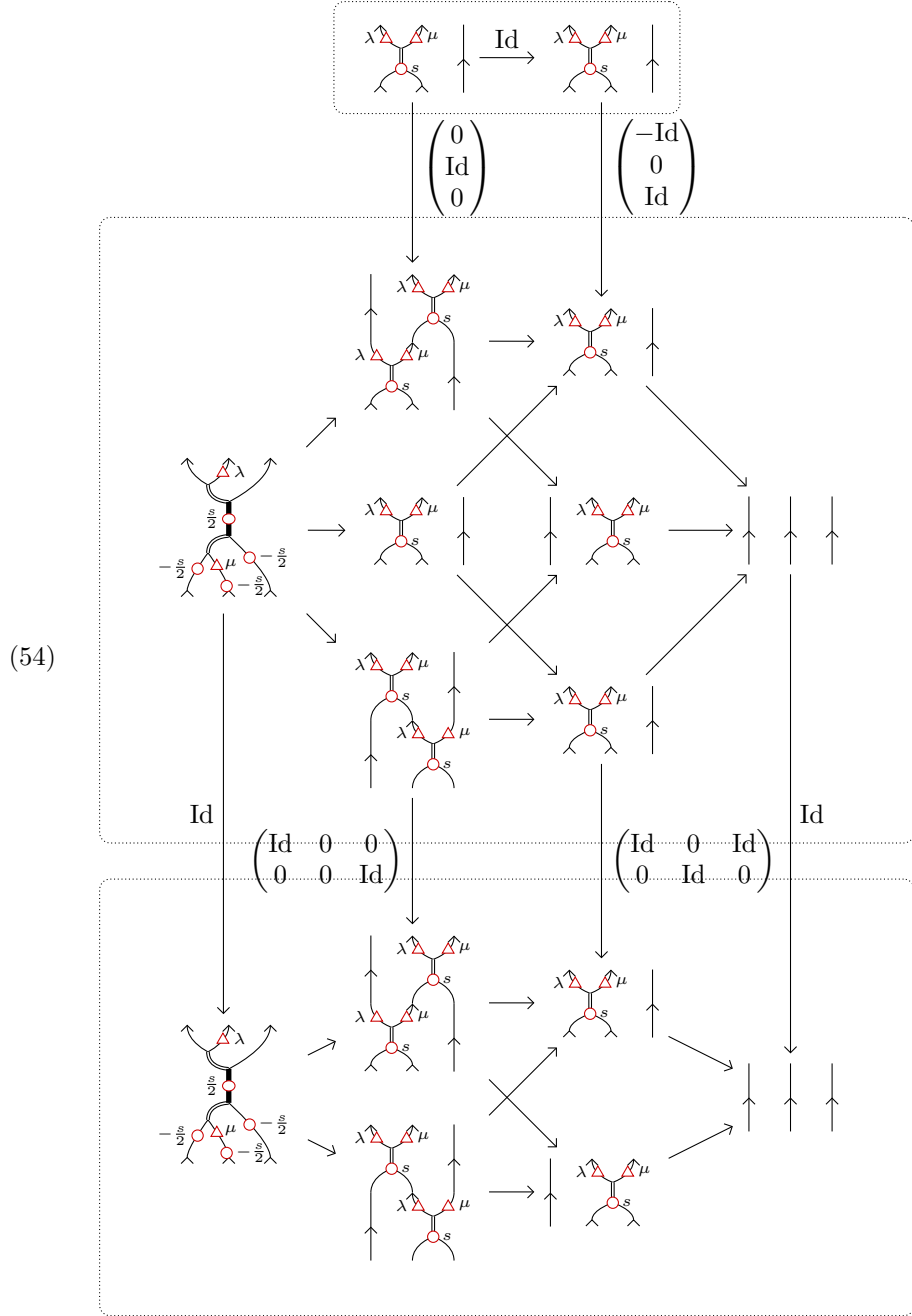

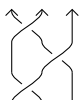
Using the same argument as for (53), we obtain that  is isomorphic to the following complex:



(55)

By noticing that we have the following isomorphism:

(56)

the complex (55) is left-right symmetric. So and are isomorphic to the same complex in the relative homotopy category. □

**5.6. Unframed invariance.** In previous sections, we proved that  $\text{KRW}_N(\cdot)$  is an invariant of framed link diagrams. However, we can introduce a unframed homology using the following length two complexes with modified twisting:

(57)

(58)

Equivalently, we can add an additional solid red dot labelled  $1/2$  to the bottom left strand on each crossing, then use dot sliding and dot addition to move all new dots to at most one new twist per component of the unframed link.

For a link  $L$  let  $\widehat{\text{KRW}}_N(L, R)$  be the unframed  $(\mathfrak{W}_{-1}^\infty)$ -equivariant) Khovanov–Rozansky  $\mathfrak{gl}_N$ -homology.

**Corollary 5.12.** *The unframed Khovanov–Rozansky  $\mathfrak{gl}_N$ -homology  $\widehat{\text{KRW}}_N(L, R)$  is an invariant of (unframed) oriented link diagrams.*

## 6. FUNCTORIALITY

The following is adapted from the proof of the functoriality of the  $\mathfrak{sl}_2$  action on Khovanov–Rozansky  $\mathfrak{gl}_N$ -link homology presented in [QRSW23].

**Definition 6.1.** Let  $\mathbf{Links}$  be the category whose objects are framed oriented links and whose morphisms are two dimensional oriented framed cobordisms.

**Theorem 6.2** ([ETW18] Th 4.5). *There is a functor  $\mathbf{KRW}_N : \mathbf{Links} \rightarrow \mathcal{C}^{\mathfrak{W}_{-1}^\infty}(\mathbf{R}_N\text{-proj}_{gr})$ .*

The  $\mathfrak{W}_{-1}^\infty$ -action on foams induces a  $\mathfrak{W}_{-1}^\infty$ -action on morphisms in the category  $\mathcal{C}^{\mathfrak{W}_{-1}^\infty}(\mathbf{R}_N\text{-proj}_{gr})$  that are induced by foams. To see this, consider  $F$  to be a foam between two red-dotted webs  $\Gamma_0$  and  $\Gamma_1$ . Denote by  $\alpha_0$  and  $\alpha_1$  the maps encoded by the red dots on  $\Gamma_0$  and  $\Gamma_1$ , respectively. Then the  $\mathfrak{W}_{-1}^\infty$ -action on the morphism induced by  $F$  between the state spaces associated to  $\Gamma_0$  and  $\Gamma_1$  is defined by:

$$L_n * F := L_n \cdot F - \alpha_0(L_n)F + \alpha_1(L_n)F.$$

Thus, we have a  $\mathfrak{W}_{-1}^\infty$ -action on maps between state spaces induced by foams. To properly encode this action on morphism spaces in a categorical way, we need to work within a category.

If we want the image of a cobordism to intertwine with the  $\mathfrak{W}_{-1}^\infty$ -action on the objects, we need to introduce solid red dots on links. These dots will compensate the  $\mathfrak{W}_{-1}^\infty$ -action on cups, caps, and saddles in a two-dimensional cobordisms. Thanks to Lemma 5.6, we can gather the solid red dots on each connected component of the link. This remark leads to the following definition:

**Definition 6.3.** Let us define the category  $\mathbf{rLinks}$ . The objects are couples  $(L, (\lambda_j))$  where  $L$  is a framed oriented link and  $(\lambda_j) \in \mathbb{R}^k$ , where  $k$  is the number of components of  $L$ . A morphism  $C$  from  $(L_0, (\lambda_j^0))$  to  $(L_1, (\lambda_j^1))$  is a two-dimensional oriented framed cobordism between  $L_0$  and  $L_1$  in  $\mathbb{R}^3 \times \mathbb{R}$  such that:

$$\chi(C) = 2\left(\sum_{j=1}^{k_1} \lambda_j^1 - \sum_{j=1}^{k_0} \lambda_j^0\right),$$

where  $\chi$  is the Euler characteristic of  $C$ .

The following theorem is a direct consequence of the functoriality of the  $\mathfrak{gl}_N$ -Khovanov–Rozansky homology.

**Theorem 6.4.** *There is a functor  $\mathbf{KRW}_N : \mathbf{rLinks} \rightarrow \mathcal{C}^{\mathfrak{W}_{-1}^\infty}(\mathbf{R}_N\text{-proj}_{gr})$  that respects the  $\mathfrak{W}_{-1}^\infty$ -action on objects.*

Let  $\mathbf{Links}_{Con}$  be the category whose objects are framed oriented links and whose morphisms are connected link concordances. Recall that a link concordance is a two-dimensional oriented framed cobordism between two links which is an embedding of a cylinders inside  $\mathbb{R}^3 \times [0, 1]$ . The Euler characteristic of a link concordance is always zero.

**Corollary 6.5.** *The functor  $\mathbf{KRW}_N$  of the previous corollary restricts to a functor:*

$$\mathbf{KRW}_N : \mathbf{Links}_{Con} \rightarrow \mathcal{C}^{\mathfrak{W}_{-1}^\infty}(\mathbf{R}_N\text{-proj}_{gr}).$$

We formulated the functoriality in the framed case, but with Section 5.6 one can apply all the previous results to the unframed case.

7. COMPUTATIONS

We now present the computation of the  $\mathfrak{W}_{-1}^\infty$ -equivariant Khovanov–Rozansky  $\mathfrak{gl}_N$ -homology in the case of the Hopf link.

**7.1. Forktwist lemma.** We begin with a lemma, that helps us compute the homology of the Hopf link.

**Lemma 7.1.** *There are the following isomorphisms in the relative homotopy category:*

$$(59) \quad \begin{array}{c} \uparrow \quad \uparrow \\ \diagdown \quad \diagup \\ \circlearrowleft \\ \diagup \quad \diagdown \\ \uparrow \quad \uparrow \end{array} \cong q^2 \begin{array}{c} \uparrow \quad \uparrow \\ | \quad | \\ \circ \\ | \quad | \\ \uparrow \quad \uparrow \end{array} \quad \text{and} \quad \begin{array}{c} \uparrow \quad \uparrow \\ \diagdown \quad \diagup \\ \circlearrowright \\ \diagup \quad \diagdown \\ \uparrow \quad \uparrow \end{array} \cong q^{-2} \begin{array}{c} \uparrow \quad \uparrow \\ | \quad | \\ \circ \\ | \quad | \\ \uparrow \quad \uparrow \end{array} .$$

*Proof.* The construction of both isomorphisms uses the same ideas. We present the proof for the first isomorphism. Thanks to Lemma 5.3 the existence of the following isomorphism is enough:

$$(60) \quad \begin{array}{c} \uparrow \quad \uparrow \\ \diagdown \quad \diagup \\ \circlearrowleft \\ \diagup \quad \diagdown \\ \uparrow \quad \uparrow \end{array} \cong q^2 \begin{array}{c} \uparrow \quad \uparrow \\ | \quad | \\ \circ \\ | \quad | \\ \uparrow \quad \uparrow \end{array} .$$

The first complex is defined to be:

$$\begin{array}{c} \uparrow \quad \uparrow \\ \diagdown \quad \diagup \\ \circlearrowleft \\ \diagup \quad \diagdown \\ \uparrow \quad \uparrow \end{array} = q \begin{array}{c} \uparrow \quad \uparrow \\ \diagdown \quad \diagup \\ \circlearrowleft \\ \diagup \quad \diagdown \\ \uparrow \quad \uparrow \end{array} \xrightarrow{\eta} \begin{array}{c} \uparrow \quad \uparrow \\ | \quad | \\ \circ \\ | \quad | \\ \uparrow \quad \uparrow \end{array} .$$

We embed these two complexes in a short exact sequence of  $\mathfrak{W}_{-1}^\infty$ -equivariant complexes that splits when one forgets the  $\mathfrak{W}_{-1}^\infty$  action:

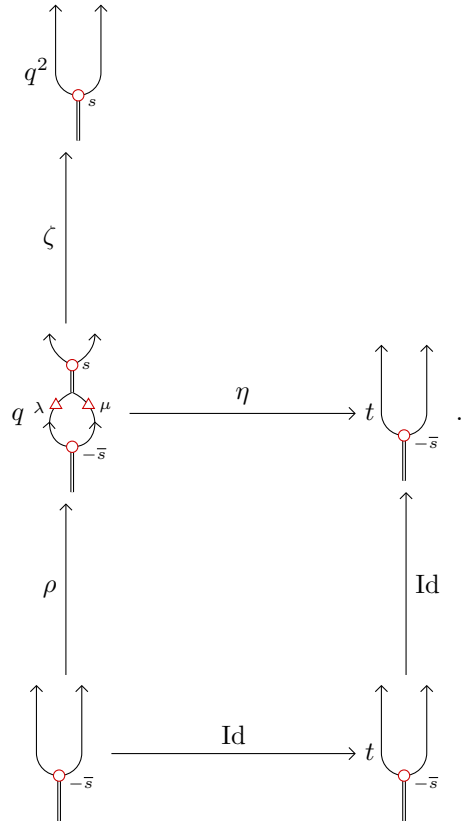

The vertical maps are given by the digon cup and digon cap. Since the bottom complex is contractible, and thanks to Corollary 2.3, we obtain the desired isomorphism. □

**7.2. The Hopf link.** As an example we provide the following computation of the action on the positive Hopf link:

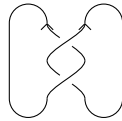

By resolving the top crossing only we have the following complex:

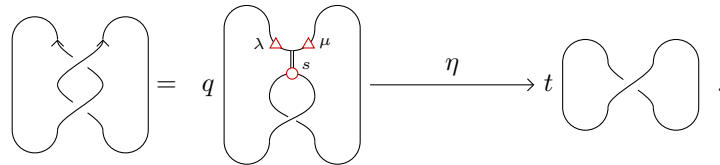

After applying a fork twist 7.1 and a Reidemeister I move, we obtain the following equivalent complex, which has no differential because its two non-zero terms lie in cohomological degrees 0 and 2:

The homological degree 2 state space has a basis, as an  $R_N$ -module, given by the following foams:

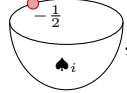

with  $0 \leq i \leq N - 1$ . The homological degree 0 state space has a basis is given by the following foams:

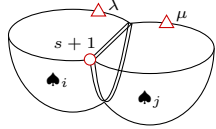

with  $0 \leq i \leq N - 1$  and  $0 \leq j \leq N - 2$ . In both cases, we list the action of  $\mathfrak{W}_{-1}^\infty$  on the elements of the basis:

$$(61) \quad L_n \cdot \begin{array}{c} \text{red dot } -\frac{1}{2} \\ \text{black dot } i \end{array} = -i \begin{array}{c} \text{red dot } -\frac{1}{2} \\ \text{black dot } n+i \end{array} + \sum_{k+l=n} \begin{array}{c} \text{red dot } -\frac{1}{2} \\ \text{black dot } k+i \quad \text{black dot } l \end{array}$$

$$(62) \quad L_n \cdot \begin{array}{c} \text{red triangles } \lambda, \mu \\ \text{red dot } s+1 \\ \text{black dot } i \quad \text{black dot } j \end{array} = -i \begin{array}{c} \text{red triangles } \lambda, \mu \\ \text{red dot } s+1 \\ \text{black dot } n+i \quad \text{black dot } j \end{array} - j \begin{array}{c} \text{red triangles } \lambda, \mu \\ \text{red dot } s+1 \\ \text{black dot } i \quad \text{black dot } n+j \end{array} + \sum_{k+l=n} \left( -2 \begin{array}{c} \text{red triangles } \lambda, \mu \\ \text{red dot } s+1 \\ \text{black dot } k+i \quad \text{black dot } l+j \end{array} + \frac{1}{2} \begin{array}{c} \text{red triangles } \lambda, \mu \\ \text{red dot } s+1 \\ \text{black dot } k+i \quad \text{black dot } l \quad \text{black dot } j \end{array} + \frac{1}{2} \begin{array}{c} \text{red triangles } \lambda, \mu \\ \text{red dot } s+1 \\ \text{black dot } i \quad \text{black dot } k+j \quad \text{black dot } l \end{array} \right)$$

To express the  $\mathfrak{W}_{-1}^\infty$ -action on the two considered state spaces in their respective bases, we need to use the following identity, which arise from the relations<sup>3</sup> between Schur polynomials. For  $k \geq N$ :

$$(63) \quad x^k = \sum_{i=0}^{N-1} \sum_{m=0}^i (-1)^m H_{k-i} E_m x^{i-m}.$$

<sup>3</sup>These relations can be found in [Mac95]

For the theta foams decorated by polynomials  $\hat{\spadesuit}_i$ , we use the relation  $\hat{\spadesuit}_i = P_i - \spadesuit_i$  and the identity (63). One tricky case remains, the theta foam with  $i = 0$  and  $j = N - 1$ . The variable  $x$  denotes the variable in the " $i$ -cup," and  $y$  the variable in the " $j$ -cup." We apply dot migration using the identity  $y^{N-1} = h_{N-1}(x, y) - xh_{N-2}(x, y)$  and the following relation:

$$(64) \quad h_{N-1}(x, y) = \sum_{k=0}^{N-2} \sum_{i=0}^k (-1)^i H_{N-1-k} E_i h_{k-i}(x, y).$$

**7.3. (2,m) Torus links.** Using a standard argument we compute the action on  $T(2, m)$  torus links by induction.

The following diagram represents the positive  $T(2, m)$  torus link which has  $m$  half twists.

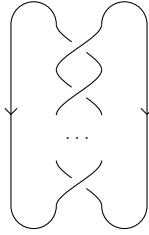

By resolving the top crossing only we have the following complex where both terms contain a chain of  $m - 1$  half twists:

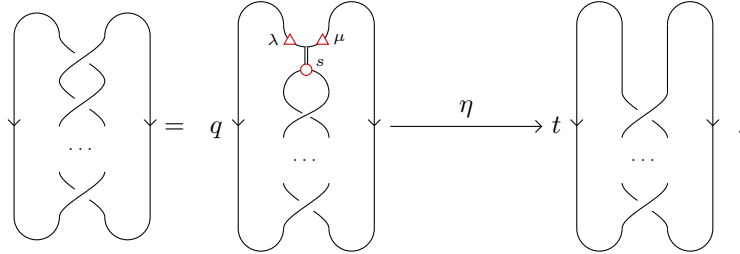

After applying a fork twist 7.1 we obtain the following:

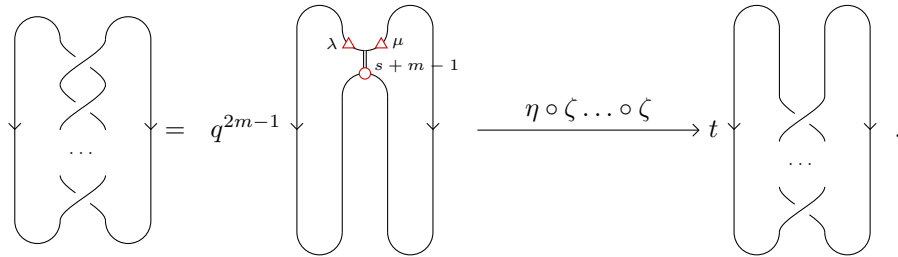

Since the right term is the link  $T(2, m - 1)$  we can apply the induction hypothesis to obtain the length  $m + 1$  complex:

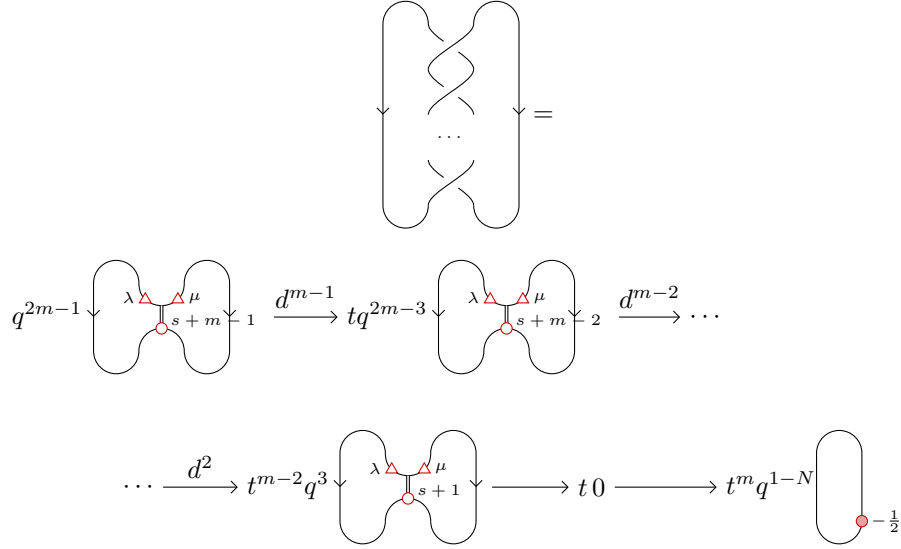

The differentials alternate between the following two maps:

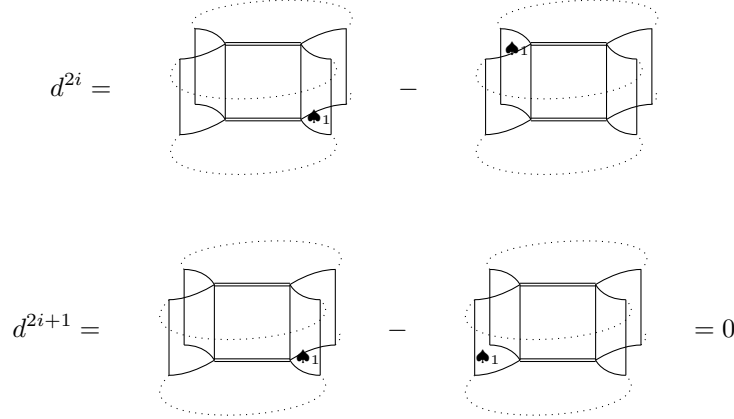

Thus the homology of  $T(2, m)$  splits into three disjoint components:

- (1) The state space of the circle web with a solid red dot  $-1/2$  twist in homological degree  $m$  and  $q$ -degree  $1 - N$ .
- (2) The state space of the theta web with  $\lambda, \mu$ , and  $s + m - 1$  twists in homological degree 0 and  $q$ -degree  $2m - 1$  if  $m$  is even.
- (3) Two-term complexes of theta webs in homological degree  $m - 2i - 1$  and  $q$ -degree  $2i + 3$ , and, homological degree  $m - 2i$  and  $q$ -degree  $2i + 1$  with the non-zero even differential between them.

The state spaces of the first two components are the same as in the Hopf link case. The even differential has no kernel and its cokernel identifies the left and right decorations. In particular, it identifies the left decoration of degree  $N - 1$  with the right decoration of degree  $N - 2$  which can be rewritten as a linear combination of lower degree terms. Thus the third component has a basis given by theta-cup foams with decorations on one side of degree  $\leq N - 2$ .

As in the Hopf link case the  $\mathfrak{W}_{-1}^\infty$ -action is determined by the action on the bases of the states spaces. The generators are identical to those of the Hopf link but with different twisting. For  $1 \leq r \leq m-1$ ,  $0 \leq i \leq N-1$  and  $0 \leq j \leq N-2$ :

$$(65) \quad L_n \cdot \begin{array}{c} \text{cup with } -\frac{1}{2} \text{ twist and } \spadesuit_i \\ \text{foam} \end{array} = -i \begin{array}{c} \text{cup with } -\frac{1}{2} \text{ twist and } \spadesuit_{n+i} \\ \text{foam} \end{array} + \sum_{k+l=n} \begin{array}{c} \text{cup with } -\frac{1}{2} \text{ twist and } \spadesuit_{k+i} \spadesuit_l \\ \text{foam} \end{array}$$

$$(66) \quad L_n \cdot \begin{array}{c} \text{cup with } \spadesuit_i \text{ and } \spadesuit_j \text{ and } s+r \text{ twist} \\ \text{foam} \end{array} = -i \begin{array}{c} \text{cup with } \spadesuit_{i+n} \text{ and } \spadesuit_j \text{ and } s+r \text{ twist} \\ \text{foam} \end{array} - j \begin{array}{c} \text{cup with } \spadesuit_i \text{ and } \spadesuit_{j+n} \text{ and } s+r \text{ twist} \\ \text{foam} \end{array} + \frac{1}{2} \sum_{k+l=n} \left( -2(t+1) \begin{array}{c} \text{cup with } \spadesuit_{k+i} \text{ and } \spadesuit_{l+j} \text{ and } s+r \text{ twist} \\ \text{foam} \end{array} + \begin{array}{c} \text{cup with } \spadesuit_{k+i} \spadesuit_l \text{ and } \spadesuit_j \text{ and } s+r \text{ twist} \\ \text{foam} \end{array} + \begin{array}{c} \text{cup with } \spadesuit_i \text{ and } \spadesuit_{k+j} \spadesuit_l \text{ and } s+r \text{ twist} \\ \text{foam} \end{array} \right).$$

**7.4. Structural results.** We provide some comments about the structure of the Witt representations obtained in the above examples. To begin we consider the restriction of the  $\mathfrak{W}_{-1}^\infty$  action to the sub-Lie algebra isomorphic to  $\mathfrak{sl}_2$  with generators  $e = L_{-1}, h = 2L_0, f = -L_1$  and decompose the representation into  $h$ -weight spaces. Next we determined how the Witt generators link the  $\mathfrak{sl}_2$  direct summands. The key observations are that on a highest weight vector  $v$ ,  $L_{-1}L_nv = [L_{-1}L_n]v + L_nL_{-1}v = -(n+1)L_{n-1}v$  and  $h$  generator acts by scalar multiplication on all foams.

**7.4.1. Weight spaces of  $KRW_N(T(2, m))$ .** On  $KRW_N(T(2, m))$ ,  $h$  multiplies the twisted, undecorated cup generator by  $2(N-1)$ , the  $r$ -twisted theta foam by  $2(N-2-r)$ , and all polynomials by the negative of their degree. Thus, the decorated generators and the generators with any  $R_N$  coefficient have lower weights than the undecorated generators.

Recall that an  $\mathcal{U}(\mathfrak{sl}_2)$ -module of highest weight  $\lambda$  has non-trivial extensions only with modules of highest weight  $-\lambda-2$ . Therefore all vectors of weight strictly less than  $-2N$  in the cup component and all vectors of weight strictly less than  $-2(N-1-r)$  in the  $s+r$ -twisted theta components generate infinite dimensional Verma modules. In particular this means whenever  $r > N-2$  the  $s+r$ -twisted component is a direct sum of infinite dimensional Verma modules. For example, if  $N=2$  all of the theta components of the homology are direct sums of Verma modules.

Next we find dimension bounds on the number of finite dimensional highest weight submodules. As a graded  $R_N$ -module, the cup component of the homology is

$$q^{2(N-1)} \bigoplus_{0 \leq m \leq N-1} q^{-2m} R_N \cdot x^m.$$



For  $k$  less than  $N$ , the dimension of the degree  $2k$  piece of  $R_N$  is the number of integer partitions of  $k$ , denoted  $P(k)$ . Note that the  $R_N$ -coefficients of vectors that lie in the positive weight part of the module are within this low-degree range. The differences in the dimensions of weight spaces form a finite telescoping sum so that the  $2(N-1) - m$  weight space has dimension  $P(m)$ . Therefore, the locally finite portion of the cup component is a subrepresentation of

$$\bigoplus_{0 \leq m \leq N-1} L(2(N-1-m))^{\oplus P(m)}.$$

The theta components are more complicated since there are multiple homology generators in each  $q$ -degree. As an  $R_N$ -module, the theta component is

$$q^{2(N-2-r)} \bigoplus_{0 \leq n \leq N-1, 0 \leq m \leq N-2} q^{-2(m+n)} R_N \cdot x^n y^m$$

For a vector to have positive weight, it must have both  $m, n \leq N-2$  and the number of  $R_N$  generators  $x^n y^m$  in each degree  $n+m$  is  $n+m+1$ . Again we have a telescoping sum for the differences of the dimensions of the weight spaces but this time we find that the  $2(N-2-r-m-n)$  weight space has dimension  $\sum_{0 \leq k \leq m+n} P(k)$ . We abbreviate this sum as  $\overline{P}(k)$ . Therefore the locally finite portion of the cup component is a sub representation of

$$\bigoplus_{0 \leq m \leq N-2-r} L(2(N-2-r-m))^{\oplus \overline{P}(k)}.$$

**7.4.2. Witt structure of  $KRW_2(\emptyset)$ .** When  $N=2$ , there are very few highest weight vectors and we can describe the way the Witt action connects the  $\mathfrak{sl}_2$ -direct summands explicitly.

To start we look at the homology of the empty link:  $KRW_2(\emptyset) \cong R_N$ . The highest weight is 0 and there is a unique highest weight vector in every weight  $-4k$ . The highest weight vector is 1 which generates a copy of  $L(0)$  and is in extension with a copy of  $M(-2)$  generated by  $P_1$  to form a direct summand  $M^*(0)$ . The remaining highest weight vectors generate direct summands of infinite Verma modules  $M(-4k)$ . The Witt generators send power sums to multiples of power sums so  $M^*(0)$  is a Witt direct summand as well..

Let  $v$  be a highest weight vector with weight  $M < 0$  and consider  $L_2 v$  which has weight  $M-4$ . The weight space  $M-4$  has a basis given by a highest weight vector  $w$ ,  $(L_1)^2 v$  which lives in  $\mathcal{U}(\mathfrak{sl}_2)v$ , and a collection of vectors  $x_i$  living in other highest weight modules. From the Witt relation,  $L_{-1} L_2(v) = -3L_1(v)$  since  $L_{-1} v = 0$ . Since the  $\mathfrak{sl}_2$  module splits as a direct sum of the highest weight modules, the vectors  $L_{-1} x_i$  are all independent of  $L_1 v$  so  $L_2 v$  is in the span of  $(L_1)^2 v$  and  $w$  only.

Let  $L_2 v = a(L_1)^2 v + w$ . Since  $w$  is killed by  $L_{-1}$ ,  $0 = L_{-1}[L_2 v - a(L_1)^2 v] = (2a(M-1) - 3)L_1(v)$  which determines the coefficient  $a = \frac{3}{2a(M-1)}$ . If  $2(M-1)L_2(v) - 3(L_1)^2(v) = w = 0$ , then  $L_2 v$  will be a scalar multiple of  $(L_1)^2 v$  and otherwise, the  $\mathcal{W}_1^\infty$  module generated by  $v$  contains the  $\mathfrak{sl}_2$  module  $w$ .

Since we are only considering the base ring of symmetric polynomials we can compare these polynomials one degree at a time.  $L_2$  and  $L_1$  both send the highest  $x$  degree term in  $v$  to the highest degree term so we start by comparing those. Without loss of generality we assume that  $v$  is a monic polynomial of highest power  $k$  so that  $M = -2k$ . Then the highest degree term of  $L_2 v$  is  $-kx^{k+2}$

and the highest degree term of  $(L_1)^2v$  is  $k(k+1)x^{k+2}$ . Thus  $w = 0$  whenever  $2(-2k-1)(-k) - 3k(k+1) = k(k-1) = 0$  which is when  $k = 0$  and  $k = 1$ . There are no highest weight vectors with highest power 1, thus  $L_2v$  is independent of  $(L_1)^2v$  as long as  $v \neq 1$ . In these cases  $w = 2(M-1)L_2v - 3(L_1)^2v$ .

Thus as a  $\mathfrak{W}_{-1}^\infty$ -module,  $R_N$  splits as a direct sum between  $M^*(0)$  and its complement.

7.4.3. *Witt structure of  $KRW_2(T(2, m))$ .* When  $N = 2$  the twisting severely limits the structure of the module. The components of the homology in the cokernel of the non-zero differential are isomorphic to a single infinite Verma module which must be preserved by the  $\mathfrak{W}_{-1}^\infty$  action. In the other two components there is a single highest weight vector in each weight space [Roz23]. Therefore the argument for the empty link case proceeds identically until the relation  $2(M-1)L_2(v) - 3(L_1)^2(v) = w = 0$ .

Since the generators of this module are not simply polynomials and the action on 1 is non-trivial depending on the action on cups and unzips, it is not obvious how to find general conditions for when  $w = 0$ . We easily see from direct computation that when  $v$  is the undecorated cup,  $w \neq 0$ , but further results are not known.

## APPENDIX A. VERDIER QUOTIENT

This appendix is here to explain the proof of the Lemma 2.2. The curious reader can read [Nee01] for more detailed about triangulated categories. Let  $\mathcal{D}$  be a triangulated category endowed with an autofunctor  $T$ .

**Definition A.1.** Let  $F : \mathcal{D} \rightarrow \mathcal{T}$  be a triangulated functor. The *kernel* of  $F$  is defined to be the full subcategory  $\mathcal{C}$  of  $\mathcal{D}$  whose objects map to objects of  $\mathcal{T}$  isomorphic to 0.

**Lemma A.2.** [Nee01, Lem.2.1.4] *The kernel of  $F$  is a triangulated subcategory of  $\mathcal{D}$ .*

**Theorem A.3.** [Nee01, Th.2.1.8] *Let  $\mathcal{D}$  be a triangulated category,  $\mathcal{C} \subset \mathcal{D}$  a triangulated subcategory. There exists a triangulated category  $\mathcal{D}/\mathcal{C}$  and a functor  $F_u : \mathcal{D} \rightarrow \mathcal{D}/\mathcal{C}$  so that  $\mathcal{C}$  is in the kernel of  $F_u$ , and  $F_u$  is universal in the following sense. If  $\mathcal{G} : \mathcal{D} \rightarrow \mathcal{T}$  is a triangulated functor whose kernel contains  $\mathcal{C}$ , then it factors uniquely as:*

$$(67) \quad \begin{array}{ccc} \mathcal{D} & \xrightarrow{\mathcal{G}} & \mathcal{T} \\ & \searrow^{F_u} & \nearrow \\ & \mathcal{D}/\mathcal{C} & \end{array}$$

Objects of  $\mathcal{D}/\mathcal{C}$  are the same object as  $\mathcal{D}$ , in other words,  $F_u$  is the identity on objects. By noticing the previous fact, we understand that the purpose of this category is to expand the class of objects that are isomorphic to 0. So to understand the category  $\mathcal{D}/\mathcal{C}$  we need to describe  $\text{Hom}_{\mathcal{D}/\mathcal{C}}$

For a triangulated subcategory  $\mathcal{C} \subset \mathcal{D}$ , we define  $\text{Mor}_{\mathcal{C}} \subset \mathcal{D}$  as follows. A morphism  $u : X \rightarrow Y$  lies in  $\text{Mor}_{\mathcal{C}}$  if and only if in the triangle:

$$X \xrightarrow{u} Y \rightarrow Z \rightarrow T(X)$$

the object  $Z$  lies in  $\mathcal{C}$ . Note that it is irrelevant which particular triangle we take because  $Z$  is unique up to isomorphism thanks to axioms of a triangulated category. For two objects  $X, Y$  in  $\mathcal{D}$  denote by  $\alpha(X, Y)$  the class of diagrams of the form:

$$(68) \quad \begin{array}{ccc} & Z & \\ f \swarrow & & \searrow g \\ X & & Y \end{array}$$

such that  $f$  belongs to  $\text{Mor}_{\mathcal{C}}$ . Consider a relation  $R(X, Y)$  on  $\alpha(X, Y)$  such that  $[(Z, f, g), (Z', f', g')]$  belongs to  $R(X, Y)$  if and only if there is an element  $(Z'', f'', g'')$  in  $\alpha(X, Y)$  and morphisms:

$$v : Z'' \rightarrow Z, w : Z'' \rightarrow Z'$$

which make the diagram:

$$(69) \quad \begin{array}{ccccc} & & Z' & & \\ & f' \swarrow & \uparrow w & \searrow g' & \\ X & \xleftarrow{f''} & Z'' & \xrightarrow{g''} & Y \\ & \nwarrow f & \downarrow v & \nearrow g & \\ & & Z & & \end{array}$$

commute. We can prove that  $v$  and  $w$  are in  $\text{Mor}_{\mathcal{C}}$  (cf [Nee01, Lem.2.1.12]). Then  $\text{Hom}_{\mathcal{D}/\mathcal{C}}(X, Y)$  is the class of equivalence in  $\alpha(X, Y)$  with respect to  $R(X, Y)$ . A morphism  $f : X \rightarrow Y$ , in  $\mathcal{D}$ , is mapped by  $F_u$  to

$$(70) \quad \begin{array}{ccc} & X & \\ & \swarrow 1 & \searrow f \\ X & & Y \end{array}$$

Let  $f : X \rightarrow Y$  be such that  $f \in \text{Mor}_{\mathcal{C}}$ . Then a triangulated functor  $F$  takes an object  $Z$  to 0 if and only if it takes the distinguished triangle

$$X \xrightarrow{f} Y \rightarrow Z \rightarrow T(X)$$

to a triangle isomorphic to the image of

$$X \xrightarrow{1} X \rightarrow 0 \rightarrow T(X)$$

In other words,  $F(f)$  must be an isomorphism. Therefore, in the category  $\mathcal{D}/\mathcal{C}$ , all the morphisms in  $\text{Mor}_{\mathcal{C}}$  become invertible.

**Proposition A.4.** [Nee01, Prop.2.1.24] *The functor  $F_u : \mathcal{D} \rightarrow \mathcal{D}/\mathcal{C}$  is universal for all functor  $F : \mathcal{D} \rightarrow \mathcal{T}$  which takes all morphisms in  $\text{Mor}_{\mathcal{C}}$  to invertible morphisms.*

With the previous proposition we can assume that  $\mathcal{D}/\mathcal{C} \simeq (\text{Mor}_{\mathcal{C}})^{-1}\mathcal{D}$  where the second category is the localization of  $\mathcal{D}$  with respect to  $\text{Mor}_{\mathcal{C}}$ .

Let us prove Lemma 2.3.

**Lemma A.5.** *A triangle is distinguished in  $\mathcal{C}^H(A)$  if and only if it is isomorphic to*

$$F_u(M) \rightarrow F_u(N) \rightarrow F_u(L) \rightarrow t^{-1}F_u(M)$$

where  $M \rightarrow N \rightarrow L$  is a short exact sequence in  $\mathcal{C}(A\#H)$  termwise  $A$ -split exact.

*Proof.* We begin by the first implication. A distinguished triangle in  $\mathcal{C}^H(A)$  is a triangle isomorphic to

$$F_u(M) \rightarrow F_u(N) \rightarrow F_u(L) \rightarrow t^{-1}F_u(M)$$

where  $M \rightarrow N \rightarrow L \rightarrow t^{-1}M$  is a distinguished triangle in  $\mathcal{C}(A\#H)$ . So  $M \rightarrow N \rightarrow L$  is a short exact sequence of complexes that is termwise  $A\#H$ -split exact, especially it is termwise  $A$ -split exact. Let us prove the converse.

Let  $M \xrightarrow{f} N \xrightarrow{g} L$  be a short exact sequence of complexes in  $\mathcal{C}(A\#H)$  that is termwise  $A$ -split exact. In  $\mathcal{C}(A\#H)$  one has the distinguished triangle  $M \rightarrow N \rightarrow \text{Cone}(f) \rightarrow t^{-1}M$ , where

$$\text{Cone}(f) = \left( t^{-1}M \oplus N, \begin{pmatrix} -d^M & 0 \\ -f & d^N \end{pmatrix} \right),$$

that gives rise to a distinguished triangle in  $\mathcal{C}^H(A)$ . So prove that  $\text{Cone}(f)$  and  $L$  are isomorphic in  $\mathcal{C}^H(A)$  will show that the short exact sequence gives rise to a distinguished triangle in the relative homotopy category. So let us define

$$h : \begin{array}{ccc} \text{Cone}(f) & \longrightarrow & L \\ (m, n) & \longmapsto & g(n) \end{array} .$$

We have  $\text{Ker}(h) = t^{-1}M \oplus \text{Ker}(g) = t^{-1}M \oplus \text{Im}(f)$ . Moreover one has  $\text{Ker}(h) \simeq \text{Cone}(\text{Id}_M)$  in  $\mathcal{C}(A\#H)$  thanks to:

$$(71) \quad \begin{array}{ccc} M_n \oplus \text{Im}(f)_{n-1} & \xrightarrow{\begin{pmatrix} -d^M & 0 \\ -f & d^N \end{pmatrix}} & M_{n+1} \oplus \text{Im}(f)_n \\ \left( \begin{array}{cc} \text{Id}_M & 0 \\ 0 & f \end{array} \right) \updownarrow & & \updownarrow \left( \begin{array}{cc} \text{Id}_M & 0 \\ 0 & f^{-1} \end{array} \right) \\ M_n \oplus M_{n-1} & \xrightarrow{\begin{pmatrix} -d^M & 0 \\ -\text{Id}_M & d^N \end{pmatrix}} & M_{n+1} \oplus M_n \end{array} .$$

So we have the following short exact sequence  $\text{Cone}(\text{Id}_M) \rightarrow \text{Cone}(h) \xrightarrow{h} L$ . Now under  $\text{For}$  we have:

$$\text{For}(\text{Cone}(f)) \simeq \text{For}(t^{-1}M) \oplus \text{For}(M) \oplus \text{For}(L) \simeq \text{For}(\text{Cone}(\text{Id}_M)) \oplus \text{For}(L)$$

where the first isomorphism is given by the fact that the original short exact sequence is termwise  $A$ -split. Thus we have the following distinguished triangle in  $\mathcal{C}(A)$ :

$$0 \simeq \text{For}(\text{Cone}(\text{Id}_M)) \rightarrow \text{For}(\text{Cone}(f)) \xrightarrow{\text{For}(h)} \text{For}(L) \rightarrow t^{-1}\text{For}(\text{Cone}(\text{Id}_M)) \simeq 0.$$

so  $\text{For}(h)$  is an isomorphism.

Let  $\text{Cone}(f) \xrightarrow{h} L \rightarrow Z \rightarrow t^{-1}\text{Cone}(f)$  be a distinguished triangle in  $\mathcal{C}(A\#H)$ , then  $\text{For}(\text{Cone}(f) \xrightarrow{h} L \rightarrow Z \rightarrow t^{-1}\text{Cone}(f))$  is a distinguished triangle in  $\mathcal{C}(A)$  (because  $\text{For}$  is a triangulated functor) and because  $\text{For}(h)$  is an isomorphism then  $\text{For}(Z) \simeq 0$ . In other words  $Z \in \text{Ker}(\text{For})$ , thus  $h \in \text{Mor}_{\text{Ker}(\text{For})}$  and  $F_u(h)$  is an isomorphism in  $\mathcal{C}^H(A)$ .  $\square$

## REFERENCES

- [BHPW23] Anna Beliakova, Matthew Hogancamp, Krzysztof K. Putyra, and Stephan M. Wehrli. On the functoriality of  $\mathfrak{sl}_2$  tangle homology. *Algebr. Geom. Topol.*, 23(3):1303–1361, 2023. doi:10.2140/agt.2023.23.1303. 2
- [Bla10] Christian Blanchet. An oriented model for Khovanov homology. *J. Knot Theory Ramifications*, 19(2):291–312, 2010. doi:10.1142/S0218216510007863. 2
- [BN05] Dror Bar-Natan. Khovanov’s homology for tangles and cobordisms. *Geom. Topol.*, 9:1443–1499, 2005. doi:10.2140/gt.2005.9.1443. 2
- [Cap07] Carmen Livia Caprau. *An  $\mathfrak{sl}(2)$  tangle homology and seamed cobordisms*. ProQuest LLC, Ann Arbor, MI, 2007. Thesis (Ph.D.)—The University of Iowa. URL: [http://gateway.proquest.com/openurl?url\\_ver=Z39.88-2004&rft\\_val\\_fmt=ofi/ft:kev:mtx:dissertation&res\\_dat=xri:pqdiss&rft\\_dat=xri:pqdiss:3281349](http://gateway.proquest.com/openurl?url_ver=Z39.88-2004&rft_val_fmt=ofi/ft:kev:mtx:dissertation&res_dat=xri:pqdiss&rft_dat=xri:pqdiss:3281349). 2
- [Cau17] Sabin Cautis. Remarks on coloured triply graded link invariants. *Algebr. Geom. Topol.*, 17(6):3811–3836, 2017. doi:10.2140/agt.2017.17.3811. 1
- [CF94] Louis Crane and Igor B. Frenkel. Four-dimensional topological quantum field theory, Hopf categories, and the canonical bases. *J. Math. Phys.*, 35(10):5136–5154, 1994. Topology and physics. doi:10.1063/1.530746. 1
- [CG24] Alex Chandler and Eugene Gorsky. Structures in HOMFLY-PT Homology. *Exp. Math.*, 33(4):817–842, 2024. doi:10.1080/10586458.2023.2300412. 2
- [CMW09] David Clark, Scott Morrison, and Kevin Walker. Fixing the functoriality of Khovanov homology. *Geom. Topol.*, 13(3):1499–1582, 2009. doi:10.2140/gt.2009.13.1499. 2
- [EQ23] Ben Elias and You Qi. Categorifying Hecke algebras at prime roots of unity, part I. *Trans. Amer. Math. Soc.*, 376(11):7691–7742, 2023. doi:10.1090/tran/8908. 2
- [EST20] Michael Ehrig, Catharina Stroppel, and Daniel Tubbenhauer. Generic  $\mathfrak{gl}_2$ -foams, web and arc algebras, 2020. URL: <https://arxiv.org/abs/1601.08010>, arXiv:1601.08010. 2
- [ETW18] Michael Ehrig, Daniel Tubbenhauer, and Paul Wedrich. Functoriality of colored link homologies. *Proc. Lond. Math. Soc. (3)*, 117(5):996–1040, 2018. doi:10.1112/plms.12154. 1, 3, 34
- [GHM24] Eugene Gorsky, Matthew Hogancamp, and Anton Mellit. Tautological classes and symmetry in Khovanov-Rozansky homology. *Duke Math. J.*, 173(13):2481–2561, 2024. doi:10.1215/00127094-2023-0063. 2
- [GLW18] J. Elisenda Grigsby, Anthony M. Licata, and Stephan M. Wehrli. Annular Khovanov homology and knotted Schur-Weyl representations. *Compos. Math.*, 154(3):459–502, 2018. doi:10.1112/S0010437X17007540. 2
- [GOR13] Eugene Gorsky, Alexei Oblomkov, and Jacob Rasmussen. On stable Khovanov homology of torus knots. *Exp. Math.*, 22(3):265–281, 2013. doi:10.1080/10586458.2013.798553. 2
- [HM19] Matthew Hogancamp and Anton Mellit. Torus link homology, 2019. URL: <https://arxiv.org/abs/1909.00418>, arXiv:1909.00418.
- [Jac04] Magnus Jacobsson. An invariant of link cobordisms from Khovanov homology. *Algebr. Geom. Topol.*, 4:1211–1251, 2004. doi:10.2140/agt.2004.4.1211. 2
- [Kho00] Mikhail Khovanov. A categorification of the Jones polynomial. *Duke Math. J.*, 101(3):359–426, 2000. doi:10.1215/S0012-7094-00-10131-7. 1
- [Kho04] Mikhail Khovanov.  $\mathfrak{sl}(3)$  link homology. *Algebr. Geom. Topol.*, 4:1045–1081, 2004. doi:10.2140/agt.2004.4.1045. 1
- [Kho06] Mikhail Khovanov. An invariant of tangle cobordisms. *Trans. Amer. Math. Soc.*, 358(1):315–327, 2006. doi:10.1090/S0002-9947-05-03665-2. 2
- [Kho07] Mikhail Khovanov. Triply-graded link homology and Hochschild homology of Soergel bimodules. *Internat. J. Math.*, 18(8):869–885, 2007. doi:10.1142/S0129167X07004400. 1
- [KL03] Anton Kapustin and Yi Li. Topological correlators in Landau-Ginzburg models with boundaries. *Adv. Theor. Math. Phys.*, 7(4):727–749, 2003. doi:10.4310/atmp.2003.v7.n4.a5. 1

- [KR07] Mikhail Khovanov and Lev Rozansky. Topological Landau-Ginzburg models on the world-sheet foam. *Adv. Theor. Math. Phys.*, 11(2):233–259, 2007. doi:10.4310/atmp.2007.v11.n2.a2. 1
- [KR08a] Mikhail Khovanov and Lev Rozansky. Matrix factorizations and link homology. *Fund. Math.*, 199(1):1–91, 2008. doi:10.4064/fm199-1-1. 1
- [KR08b] Mikhail Khovanov and Lev Rozansky. Matrix factorizations and link homology. II. *Geom. Topol.*, 12(3):1387–1425, 2008. doi:10.2140/gt.2008.12.1387. 1
- [KR16] Mikhail Khovanov and Lev Rozansky. Positive half of the Witt algebra acts on triply graded link homology. *Quantum Topol.*, 7(4):737–795, 2016. doi:10.4171/QT/84. 2, 19
- [LQR15] Aaron D. Lauda, Hoel Queffelec, and David E. V. Rose. Khovanov homology is a skew Howe 2-representation of categorified quantum  $\mathfrak{sl}_m$ . *Algebr. Geom. Topol.*, 15(5):2517–2608, 2015. doi:10.2140/agt.2015.15.2517. 1
- [Mac95] I G Macdonald. *Symmetric Functions and Hall Polynomials*. Oxford University Press, 03 1995. doi:10.1093/oso/9780198534891.001.0001. 37
- [Mel22] Anton Mellit. Homology of torus knots. *Geom. Topol.*, 26(1):47–70, 2022. doi:10.2140/gt.2022.26.47.
- [MWW24] Scott Morrison, Kevin Walker, and Paul Wedrich. Invariants of surfaces in smooth 4-manifolds from link homology, 2024. URL: <https://arxiv.org/abs/2401.06600>, arXiv:2401.06600. 2
- [Nee01] Amnon Neeman. *Triangulated categories*, volume 148 of *Annals of Mathematics Studies*. Princeton University Press, Princeton, NJ, 2001. doi:10.1515/9781400837212. 43, 44
- [OS04] Peter Ozsváth and Zoltán Szabó. Holomorphic disks and knot invariants. *Adv. Math.*, 186(1):58–116, 2004. doi:10.1016/j.aim.2003.05.001. 1
- [QR16] Hoel Queffelec and David E. V. Rose. The  $\mathfrak{sl}_n$  foam 2-category: a combinatorial formulation of Khovanov-Rozansky homology via categorical skew Howe duality. *Adv. Math.*, 302:1251–1339, 2016. doi:10.1016/j.aim.2016.07.027. 1
- [QRS18] Hoel Queffelec, David E. V. Rose, and Antonio Sartori. Annular evaluation and link homology, 2018. URL: <https://arxiv.org/abs/1802.04131>, arXiv:1802.04131. 1
- [QRSW21] You Qi, Louis-Hadrien Robert, Joshua Sussan, and Emmanuel Wagner. A categorification of the colored jones polynomial at a root of unity, 2021. URL: <https://arxiv.org/abs/2111.13195>, arXiv:2111.13195. 2
- [QRSW23] You Qi, Louis-Hadrien Robert, Joshua Sussan, and Emmanuel Wagner. Symmetries of equivariant Khovanov-Rozansky homology, 2023. URL: <https://arxiv.org/abs/2306.10729>, arXiv:2306.10729. 2, 3, 5, 6, 12, 14, 19, 34
- [QRSW24] You Qi, Louis-Hadrien Robert, Joshua Sussan, and Emmanuel Wagner. Symmetries of  $\mathfrak{gl}_N$ -foams. *Quantum Topol.* (2024), published online first, 2024. arXiv:2212.10106, doi:10.4171/QT/215. 2, 5, 9, 11, 12
- [QS22] You Qi and Joshua Sussan. On some  $p$ -differential graded link homologies. *Forum Math. Pi*, 10:Paper No. e26, 58, 2022. doi:10.1017/fmp.2022.19. 2
- [QW24] Hoel Queffelec and Kevin Walker. Movie moves for framed foams from multijet transversality. *Quantum Topology*, 2024. doi:DOI10.4171/QT/205. 7
- [Ras03] Jacob Andrew Rasmussen. *Floer homology and knot complements*. ProQuest LLC, Ann Arbor, MI, 2003. Thesis (Ph.D.)–Harvard University. URL: [http://gateway.proquest.com/openurl?url\\_ver=Z39.88-2004&rft\\_val\\_fmt=info:ofi/fmt:kev:mtx:dissertation&res\\_dat=xri:pqdiss&rft\\_dat=xri:pqdiss:3091665](http://gateway.proquest.com/openurl?url_ver=Z39.88-2004&rft_val_fmt=info:ofi/fmt:kev:mtx:dissertation&res_dat=xri:pqdiss&rft_dat=xri:pqdiss:3091665). 1
- [Rou17] Raphaël Rouquier. Khovanov-Rozansky homology and 2-braid groups. In *Categorification in geometry, topology, and physics*, volume 684 of *Contemp. Math.*, pages 147–157. Amer. Math. Soc., Providence, RI, 2017. 1
- [Roz23] Felix Roz. An  $\mathfrak{sl}_2$  action on link homology of  $t(2,k)$  torus links, 2023. URL: <https://arxiv.org/abs/2307.01910>, arXiv:2307.01910. 2, 42
- [RT91] N. Reshetikhin and V. G. Turaev. Invariants of 3-manifolds via link polynomials and quantum groups. *Invent. Math.*, 103(3):547–597, 1991. doi:10.1007/BF01239527. 1
- [RW20a] Louis-Hadrien Robert and Emmanuel Wagner. A closed formula for the evaluation of foams. *Quantum Topol.*, 11(3):411–487, 2020. doi:10.4171/qt/139. 1, 5, 7, 12, 16

- [RW20b] Louis-Hadrien Robert and Emmanuel Wagner. Symmetric Khovanov-Rozansky link homologies. *J. Éc. polytech. Math.*, 7:573–651, 2020. doi:10.5802/jep.124. 1
- [RW24] Qiuyu Ren and Michael Willis. Khovanov homology and exotic 4-manifolds, 2024. URL: <https://arxiv.org/abs/2402.10452>, arXiv:2402.10452. 2
- [Vog20] Pierre Vogel. Functoriality of Khovanov homology. *J. Knot Theory Ramifications*, 29(4):2050020, 66, 2020. doi:10.1142/S0218216520500200. 2
- [Wan24] Joshua Wang. On  $\mathfrak{sl}(N)$  link homology with mod  $N$  coefficients. *Quantum Topol.*, 15(1):87–121, 2024. doi:10.4171/qt/194. 2
- [Wit89] Edward Witten. Quantum field theory and the Jones polynomial. *Comm. Math. Phys.*, 121(3):351–399, 1989. URL: <http://projecteuclid.org/euclid.cmp/1104178138>. 1