

Categorical Symmetries in Spin Models with Atom Arrays

Alison Warman¹, Fan Yang^{2,3}, Apoorv Tiwari⁴, Hannes Pichler^{2,3}, and Sakura Schäfer-Nameki¹

¹Mathematical Institute, University of Oxford, Woodstock Road, Oxford, OX2 6GG, United Kingdom

²Institute for Theoretical Physics, University of Innsbruck, Innsbruck 6020, Austria

³Institute for Quantum Optics and Quantum Information of the Austrian Academy of Sciences, Innsbruck 6020, Austria and

⁴Center for Quantum Mathematics at IMADA, Southern Denmark University, Campusvej 55, 5230 Odense, Denmark

Categorical symmetries have recently been shown to generalize the classification of phases of matter, significantly broadening the traditional Landau paradigm. To test these predictions, we propose a simple spin chain model that encompasses all gapped phases and second-order phase transitions governed by the categorical symmetry $\text{Rep}(D_8)$. This model not only captures the essential features of non-invertible phases but is also straightforward enough to enable practical realization. Specifically, we outline an implementation using neutral atoms trapped in optical tweezer arrays. Employing a dual-species setup and Rydberg blockade, we propose a digital simulation approach that can efficiently implement the many-body evolution in several nontrivial quantum phases.

Introduction. Symmetries are fundamental in studying and constraining phases of matter, and were traditionally limited to groups. This framework underpins a wide range of theoretical physics, from quantum mechanics, condensed matter, to quantum field theory (QFT). However, recent developments have revealed that symmetries in any dimension are far more general and form so-called (higher) fusion categories, characterized by the key property that not every symmetry transformation has an inverse. In recent years, these categorical or non-invertible symmetries have been recognized as ubiquitous, with far-reaching implications, including a categorical extension of the Landau paradigm of phases, new constraints on Standard Model physics, and advances in formal QFT (for reviews, see [1, 2]). Our aim is to establish a framework that allows direct testing of certain predictions from categorical symmetries in quantum simulators realizing spin chains.

Phases with Categorical Symmetries. In (1+1)d the most general (finite and internal) symmetry structure is a fusion category, whose generators $\{a, b, c, \dots\}$ satisfy the composition \otimes rule $a \otimes b = \sum_c N_{ab}^c c$, where N_{ab}^c are non-negative integers, which in general is not an invertible operation. Phases with these symmetries are described by a categorical extension of the Landau paradigm, and feature novel symmetry-breaking patterns and new symmetry-protected critical models. A systematic characterization of all gapped and gapless phases was recently proposed [3–10] using the so-called Symmetry Topological Field Theory (SymTFT) [11–15][16]. This computes all symmetric gapped phases, including the order parameters, ground states, and the action of the categorical symmetry on the phases. The theory furthermore predicts new second-order phase transitions, which are gapless phases with categorical symmetries.

Lattice Models and Cold Atom Implementation. This paper aims to explore these phenomena through simple spin-chains that realize categorical phases, while also proposing an experimental protocol to probe them. This is particularly interesting for systems that may have phase transitions that are hard to study numerically, examples are precisely categorical symmetries, with e.g. the

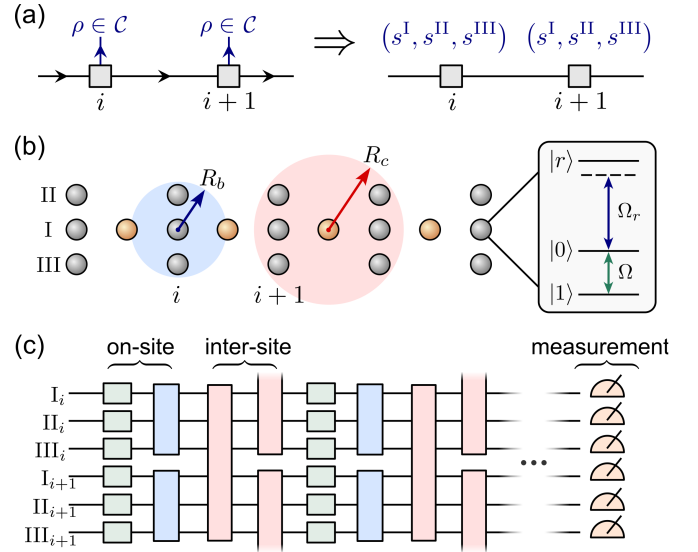

Figure 1. (a) The anyon chain for a categorical symmetry (left) is used to construct lattice models, generically on a constrained Hilbert space. Here, we realize this on a spin-chain, realized on an unconstrained 3-qubit tensor product Hilbert space (right). (b) Lattice configuration and atomic level diagram used in our proposal for realizing the spin chain in (a) with categorical symmetry. The silver and the golden circles represent the data and the ancillary atomic qubits, respectively. (c) Trotterization scheme of the quantum circuit for simulating the many-body dynamics. On-site and inter-site terms can be realized by only driving data atoms or ancillary atoms, respectively.

Haagerup symmetry being one of the most notorious examples (for recent progress see [17–19]). Lattice models with a categorical symmetry can be systematically constructed from the anyon chain [20], which generically results in a constrained Hilbert space [21–28]. This approach allows a systematic construction of commuting projector Hamiltonians for all gapped phases and second-order phase transitions of a categorical symmetry [28].

In this Letter, we present a benchmark spin-chain that demonstrates all the characteristic features of phases

with non-invertible symmetries. Inspired by this general approach, the model has the distinctive advantage of being realized in an unconstrained tensor product Hilbert space based on qubits, as illustrated in Fig. 1(a). Its Hamiltonian takes the schematic form

$$H = \sum_i V_{i,i+1} + \sum_i P_i, \quad (1)$$

where P_i denotes a projector acting on a few spins at a given site i , while $V_{i,i+1}$ is the interaction between neighboring sites i and $i+1$. This system not only captures all the key non-invertible features but is also well-suited for experimental implementation. For the latter, we focus on implementations with Rydberg-atom arrays, which have emerged as promising platforms for quantum simulation of spin models [29–32]. These systems have already been used to experimentally probe quantum phase transitions breaking conventional discrete [33–36] and continuous [37] group symmetries, as well as topologically ordered phases [38]. Here we discuss how these systems can be used to experimentally probe phases with non-invertible symmetries and the transitions between them. Specifically, our proposal is based on a digital evolution that can be induced by two driving lasers in a dual species Rydberg atom array [39, 40], as shown in Fig. 1(b).

Benchmark Model: $\text{Rep}(D_8)$ Categorical Symmetry. The benchmark symmetry is $\text{Rep}(D_8)$, i.e. the representations of the finite group $D_8 := (\mathbb{Z}_2^a \times \mathbb{Z}_2^b) \rtimes \mathbb{Z}_2^c$ of symmetries of the square (rotations and reflections). The generators are the irreducible representations (irreps)

$$\text{Generators of } \text{Rep}(D_8): 1, 1_c, 1_a, 1_{ca}, E, \quad (2)$$

with $\dim(1_k) = 1$, $\dim(E) = 2$, and their composition is the tensor product of irreps with $k = a, c, ca$:

$$\begin{aligned} 1_a \otimes 1_c &= 1_c \otimes 1_a = 1_{ca}, & 1_k \otimes 1_k &= 1, \\ E \otimes 1_k &= 1_k \otimes E = E, & & \\ E \otimes E &= 1 \oplus 1_a \oplus 1_c \oplus 1_{ca}, & & \end{aligned} \quad (3)$$

the last line being a non-invertible composition rule. Some background on this symmetry and its multiplet-structure is given in appendix A.

Using recent advancements in the representation theory of categorical symmetries, we can now demonstrate the full scope of the categorical Landau paradigm in action. This includes a comprehensive characterization of gapped phases and phase transitions [10]. Lattice models for a subset of these phases have recently been realized using a complementary approach based on the cluster state [41, 42]. In this work, we show that all phases can be captured within a straightforward tensor product Hilbert space constructed from qubits.

The benchmark model provides a: (1) Derivation of all gapped and gapless phases governed by $\text{Rep}(D_8)$, exhibiting the key features of categorical symmetries;

(2) Realization in simple spin models, with few-body interactions; (3) Realistic near future implementation of the spin model in Rydberg atom arrays.

Gapped Phases for $\text{Rep}(D_8)$. There are 11 distinct gapped phases for $\text{Rep}(D_8)$, which can be labeled by (F, β) , where F is a representative of a conjugacy class of subgroups of D_8 and a cocycle $\beta \in H^2(F, U(1))$ [10, 43].

On general grounds [28], the gapped phases for this symmetry can be realized on a lattice model, where the states are labeled by group elements $\mathbf{g}, \mathbf{h} \in D_8$ and operators acting as

$$L^{\mathbf{g}} |\mathbf{h}\rangle = |\mathbf{gh}\rangle, \quad R^{\mathbf{g}} |\mathbf{h}\rangle = |\mathbf{hg}\rangle. \quad (4)$$

The Hamiltonians for the gapped phases take the general form (1), and are given by [44]

$$H_{(F,\beta)} = -\frac{1}{|F|} \sum_i \sum_{\mathbf{f} \in F} (R_{\beta}^{\mathbf{f}^{-1}})_i (L_{\beta}^{\mathbf{f}})_{i+1} - \sum_i P_i^{(F)}. \quad (5)$$

Here $P^{(F)}$ is a projector onto the F subgroup of D_8 [45]. For each $\text{Rep}(D_8)$ irrep Γ , and $l, m \in \{1, \dots, \dim(\Gamma)\}$, we introduce a (diagonal) operator $Z_{\Gamma}^{l,m}$ that acts as

$$Z_{\Gamma}^{l,m} |\mathbf{g}\rangle = \mathcal{D}_{\Gamma}^{l,m}(\mathbf{g}) |\mathbf{g}\rangle, \quad (6)$$

where $\mathcal{D}_{\Gamma}(\mathbf{g})$ is the matrix representation of \mathbf{g} in the irrep Γ , and the symmetry operator

$$\mathcal{S}_{1_k} = \prod_i (Z_{1_k})_i, \quad \mathcal{S}_E = Z_{E,\text{prod}}^{1,1} + Z_{E,\text{prod}}^{2,2}, \quad (7)$$

where $Z_{E,\text{prod}} = \prod_i (Z_E)_i$. The diagonal operators \mathcal{S}_{Γ} commute with $H_{(F,\beta)}$ since $P^{(F)}$ is also diagonal and since $\mathcal{D}_{\Gamma}(\mathbf{f}^{-1})\mathcal{D}_{\Gamma}(\mathbf{f}) = \mathbb{I}$, hence the Hamiltonians (5) are $\text{Rep}(D_8)$ -symmetric. The key simplification in this benchmark setup is that with the identification (A10) we can map each lattice site to a three-qubit system

$$|s^{\text{I}} s^{\text{II}} s^{\text{III}}\rangle, \quad s^{\alpha} \in \{0, 1\}, \quad (8)$$

and the Hamiltonians for each phase can be written in terms of Pauli operators only. We label the x, z Pauli operators acting on the α^{th} qubit, $\alpha = \text{I}, \text{II}, \text{III}$, at site i by X_i^{α} and Z_i^{α} respectively. This simplification is key to the potential realization in future experiments.

The gapped phases, with their Hamiltonians, are summarized in table I. For each phase, we also show the number of ground states and as well as the symmetry action, including the non-invertible generator E satisfying (3). They are either symmetry protected topological (SPT) or spontaneous symmetry breaking (SSB) phases for particular sub-symmetries of $\text{Rep}(D_8)$. The realization in Rydberg arrays that we will present can easily realize the first five phases, whereas the remaining ones require a slight generalization.

Phase Type	Hamiltonian and Ground States with $\text{Rep}(D_8)$ Action
Trivial	$H_1 = -\sum_i [\mathbb{I} + \frac{1}{8}(\mathbb{I} + Z^I)(\mathbb{I} + Z^{II})(\mathbb{I} + Z^{III})]_i$, $ \text{GS}\rangle \curvearrowright$
\mathbb{Z}_2 SSB	$H_{\mathbb{Z}_2^a} = -\frac{1}{2}\sum_i (\mathbb{I}_i \mathbb{I}_{i+1} + X_i^{II} X_{i+1}^{II}) - \frac{1}{4}\sum_i [(\mathbb{I} + Z^I)(\mathbb{I} + Z^{III})]_i$ 
$\frac{\text{Rep}(D_8)}{(\mathbb{Z}_2 \times \mathbb{Z}_2)}$ SSB	$H_{\mathbb{Z}_2^{ab}} = -\frac{1}{2}\sum_i [\mathbb{I}_i \mathbb{I}_{i+1} + (X^{II} X^{III})_i (X^{II} X^{III})_{i+1}] - \frac{1}{4}\sum_i [(\mathbb{I} + Z^I)(\mathbb{I} + Z^{II} Z^{III})]_i$ 
$\mathbb{Z}_2 \times \mathbb{Z}_2$ SSB	$H_{(\mathbb{Z}_2 \times \mathbb{Z}_2)^+} = -\frac{1}{4}\sum_i (2\mathbb{I}_i \mathbb{I}_{i+1} + X_i^{II} X_{i+1}^{II} + X_i^{III} X_{i+1}^{III}) - \frac{1}{2}\sum_i [\mathbb{I} + Z^I]_i$ 
SPT	$H_{(\mathbb{Z}_2 \times \mathbb{Z}_2)^-} = -\frac{1}{4}\sum_i [\mathbb{I}_i \mathbb{I}_{i+1} + X_i^{II} (X^{II} Z^{III})_{i+1}] - \frac{1}{4}\sum_i [\mathbb{I}_i \mathbb{I}_{i+1} + (Z^{II} X^{III})_i X_{i+1}^{III}] - \frac{1}{2}\sum_i [\mathbb{I} + Z^I]_i$, $ \text{GS}\rangle \curvearrowright$
\mathbb{Z}_2 SSB	$H_{\mathbb{Z}_2^c} = -\frac{1}{2}\sum_i (\mathbb{I}_i \mathbb{I}_{i+1} + X_i^I X_{i+1}^I) - \frac{1}{4}\sum_i [(\mathbb{I} + Z^{II})(\mathbb{I} + Z^{III})]_i$ 
$\mathbb{Z}_2 \times \mathbb{Z}_2$ SSB	$H_{(\mathbb{Z}_2 \times \mathbb{Z}_2^b)^+} = -\frac{1}{4}\sum_i [2\mathbb{I}_i \mathbb{I}_{i+1} + X_i^I X_{i+1}^I + (X^{II} X^{III})_i (X^{II} X^{III})_{i+1}] - \frac{1}{2}\sum_i [\mathbb{I} + Z^{II} Z^{III}]_i$ 
SPT	$H_{(\mathbb{Z}_2 \times \mathbb{Z}_2^b)^-} = -\frac{1}{4}\sum_i [\mathbb{I}_i \mathbb{I}_{i+1} + X_i^I (X^I Z^{II})_{i+1}] - \frac{1}{4}\sum_i [\mathbb{I}_i \mathbb{I}_{i+1} + (Z^I X^{II} X^{III})_i (X^{II} X^{III})_{i+1}] - \frac{1}{2}\sum_i [\mathbb{I} + Z^{II} Z^{III}]_i$ $ \text{GS}\rangle \curvearrowright$
\mathbb{Z}_2 SSB	$H_{(D_8)^-} = (\text{A110})$ 
$\mathbb{Z}_2 \times \mathbb{Z}_2$ SSB	$H_{\mathbb{Z}_4^{ca}} = (\text{A96})$ 
$\text{Rep}(D_8)$ SSB	$H_{(D_8)^+} = (\text{A103})$ 

Table I. All gapped phases for the benchmark system with $\text{Rep}(D_8)$ symmetry, showing the type of phase, i.e. SSB (spontaneously broken symmetry) and SPT (symmetry protected topological phase). For each phase we write the commuting projector Hamiltonian of the spin model, realized on $(\mathbb{C}_I^2 \otimes \mathbb{C}_{II}^2 \otimes \mathbb{C}_{III}^2)^L$ and the number of ground states (GS) with the action of the categorical symmetry. We denote the $\text{Rep}(D_8)$ symmetry generators as follows: 1_c in red, 1_a in green, (their product is $1_{ca} = 1_c \otimes 1_a$) and the non-invertible symmetry E in blue. We use black for the full $\text{Rep}(D_8)$. The phases above the triple line separation do not require the Swap gate, and are easier to implement in our experimental proposal based on dual-species atom arrays.

Phase Transitions. One of the most recent advances is the systematic study of second-order phase transitions between two gapped phases with categorical symmetries, facilitated by the SymTFT framework [7, 8, 10, 28] that generalizes Kennedy-Tasaki (KT) transformations. In simple spin-chain models, we can furthermore analyze interpolating Hamiltonians between two gapped phases with Hamiltonians $H_{(l)}$ or $H_{(m)}$ respectively,

$$H_{(l,m)}(\lambda) = \lambda H_{(l)} + (1 - \lambda) H_{(m)}, \quad (9)$$

where for some value between 0 and 1 we have the gapless Hamiltonian for the critical point describing the second-order phase transition between the two gapped phases. From the general continuum analysis in [28] one can determine furthermore the CFTs that describe these transitions, which we corroborate from by a spin-chain analysis in appendix A 7, where we show that the transitions can be realized within this simple framework.

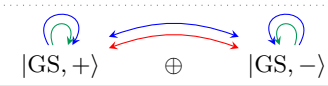
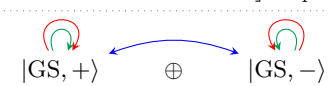
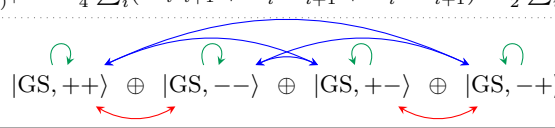
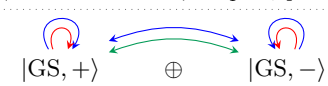
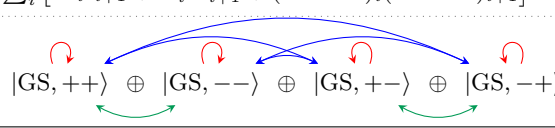
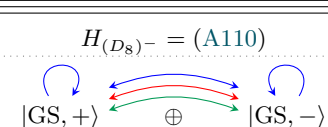
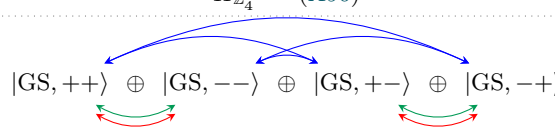
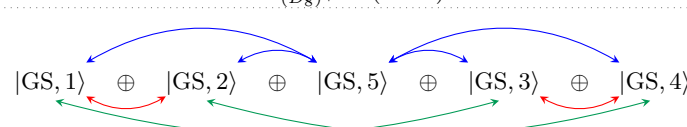
Hardware-efficient Simulation Scheme. We now turn to a potential implementation of these spin models with Rydberg atom arrays. While these systems often realize spin models in an analog way [35, 36, 46–49], here we propose a digital approach [50–53] that is versatile enough to accommodate the first five phases in Tab. I, and potentially can be extended to the remaining ones.

The configuration of the atom array is illustrated in Fig. 1(b): for each lattice site i , a group of three atoms are aligned perpendicular to the direction of the chain, representing spins $\{I_i, II_i, III_i\}$ as in Eq. (8). These atomic data qubits are encoded by two long-living hyperfine ground states $|1\rangle$ (spin-down) and $|0\rangle$ (spin-up). The latter state can be further coupled to a Rydberg state $|r\rangle$ for inducing interactions between qubits via the Rydberg blockade mechanism [54]. We assume that certain subsets of the atoms on each site can be addressed by the Rydberg laser, e.g., by shifting the other atoms out of resonance using a few distinct tweezer patterns [55]. In addition, an ancillary atom of a different species, is placed between two neighboring sites i and $i + 1$ (see Fig. 1(b)). These ancillary atoms have an analogous level scheme as our data atoms, but can be driven independently from them. Moreover, this dual-species setup supports an asymmetric Rydberg blockade, in which the intra- and the inter-species blockade radius (R_b and R_c) can be independently tuned, e.g., via Förster resonance [40]. Here, we choose $R_c > R_b$ such that each data qubit can only be blockaded by its on-site nearest neighbors (I_i and II_i ; I_i and III_i) or two closest ancillary qubits [see Fig. 1(b)]. As we show below, such a dual-species configuration facilitates both parallel and efficient simulations of the desired multi-body interactions.

Simulation of the quantum evolution is then realized by a Trotterized sequence $e^{-iH\tau} \approx \prod_p e^{-iH_p\tau} + \mathcal{O}(\tau^2)$, where $H = \sum_p H_p$ and each H_p is a collection of mutually commuting terms that can be executed in a parallel and system-size independent manner. With the physical system sketched above, arbitrary combinations of the Hamil-

tonians $\{H_1, H_{Z_2^s}, H_{Z_2^{ab}}, H_{(Z_2^a \times Z_2^b)_\pm}\}$ in Table I can be efficiently simulated. Expressing such a combination in the generic form Eq. (1), first, the on-site evolutions $e^{-iP_i\tau}$ involving up to three-body interactions can be realized by three types of phase gates in few steps: single-qubit phase gate $U_P(\phi) = e^{-i\phi Q_i^I}$, two-qubit controlled phase gate $U_{CP}(\phi) = e^{-i\phi Q_i^I Q_i^\alpha}$ ($\alpha = II, III$), and three-qubit controlled phase gate $U_{CCP}(\phi) = e^{-i\phi Q_i^I Q_i^{II} Q_i^{III}}$, where $Q = (I + Z)/2 = |0\rangle\langle 0|$. As data qubits sitting on different sites are outside the blockade radius, the operation $e^{-i\sum_i P_i\tau}$ can be parallelized [56, 57]. Second, the two-site evolution $e^{-iH_{i,i+1}}$ containing up to four-body plaquette interactions $U_{\square}(\phi) = \exp(-i\phi \mathcal{O}_i^{II} \mathcal{O}_{i+1}^{II} \mathcal{O}_{i+1}^{III} \mathcal{O}_i^{III})$ with $\mathcal{O}_j^\alpha \in \{I, X, Y, Z\}_j^\alpha$ can be constructed from a multi-qubit- Z gate controlled by an ancillary qubit [58–60]. In such a construction, the ancillary qubit is only temporarily entangled with data qubits and can be traced out from the dynamics after completion of the gate operation (see Appendix B). Since each data qubit is only affected by its two closest ancillary qubits, this operation can be executed in just two steps $e^{-i\sum_i H_{2i-1,2i}\tau}$ and $e^{-i\sum_i H_{2i,2i+1}\tau}$. The stroboscopic application of the on-site and the inter-site evolution then composes a Trotterization, realizing the desired many-body evolution [see Fig. 1(c)]. The detailed pulse sequences for the elementary gates are provided in Appendix B.

Generalization and Outlook. While the current configuration supports exploration of the first five regimes in Table I, which already includes most of the nontrivial phases, a simple generalization can reach all possible phases emerging from the $\text{Rep}(D_8)$ symmetry and derived in Appendix A. For example, one can use microwave dressing to achieve a perfect asymmetric blockade [61], where data qubits themselves are completely non-interacting and all the interactions are mediated by the ancillary qubit. In this way, arbitrary six-body interactions within each plaquette can be engineered, and the cost is just to partition the on-site operations into two pieces.

Starting from the current scheme, it is possible to increase the circuit depth, as both the execution time and the robustness of each elementary gate can be improved by optimal control methods [62, 63]. To study the transition between the revealed phases, one can carry out an adiabatic annealing in the form of Eq. (9). Each gapped phases can then be characterized by measuring both local [33] and string-like [38, 64] order parameters. In addition to the dual-species scheme, one may also use a linear-chain configuration and coherently rearrange atomic qubits [65] to establish the multi-body interaction, e.g., using the globally driving scheme to realize the four-body interaction [66]. While we focus on a digital implementation here, developing analog simulation schemes represents an interesting route as well.

The physical implementation presented here serves as a versatile framework for simulating a wide range of categorical symmetries, such as $\text{Rep}(S_3)$ non-invertible sym-

metries [67–69], and spin models in higher dimensions. Indeed, lattice models with higher categorical symmetries [70–72] in 2+1d and 3+1d, lattice models have been developed recently in [73–77], giving rise to novel phases of matter (e.g., [76, 78–81]). Extending the framework discussed here to higher dimensions would naturally align with these developments and presents an exciting challenge for experimental realization in neutral-atom systems as well as other quantum simulation platforms, such as superconducting circuits [82] and trapped ions [83].

Acknowledgments. We thank Lea Bottini, Luisa Eck, Paul Fendley, Yuhan Gai, Dan Pajer, Zhongda Zeng,

and Klaus Mølmer for discussions at various stages of this work and Lakshya Bhardwaj for initial collaboration. The work of S.S.N. and A.W. is supported by the UKRI Frontier Research Grant, underwriting the ERC Advanced Grant “Generalized Symmetries in Quantum Field Theory and Quantum Gravity”. A.T. is funded by Villum Fonden Grant no. VIL60714. Work in Innsbruck is supported by the European Union’s Horizon Europe research and innovation program under Grant Agreement No. 101113690 (PASQuans2.1), the ERC Starting grant QARA (Grant No. 101041435), and the Austrian Science Fund (FWF) (Grant No. DOI 10.55776/COE1).

-
- [1] S. Schafer-Nameki, “ICTP lectures on (non-)invertible generalized symmetries,” *Phys. Rept.* **1063** (2024) 1–55, [arXiv:2305.18296 \[hep-th\]](#).
- [2] S.-H. Shao, “What’s Done Cannot Be Undone: TASI Lectures on Non-Invertible Symmetry,” [arXiv:2308.00747 \[hep-th\]](#).
- [3] L. Bhardwaj and S. Schafer-Nameki, “Generalized Charges, Part II: Non-Invertible Symmetries and the Symmetry TFT,” [arXiv:2305.17159 \[hep-th\]](#).
- [4] L. Bhardwaj, L. E. Bottini, D. Pajer, and S. Schafer-Nameki, “Categorical Landau Paradigm for Gapped Phases,” *Phys. Rev. Lett.* **133** no. 16, (2024) 161601, [arXiv:2310.03786 \[cond-mat.str-el\]](#).
- [5] L. Bhardwaj, L. E. Bottini, D. Pajer, and S. Schafer-Nameki, “Gapped Phases with Non-Invertible Symmetries: (1+1)d,” [arXiv:2310.03784 \[hep-th\]](#).
- [6] L. Bhardwaj, L. E. Bottini, D. Pajer, and S. Schafer-Nameki, “The Club Sandwich: Gapless Phases and Phase Transitions with Non-Invertible Symmetries,” [arXiv:2312.17322 \[hep-th\]](#).
- [7] A. Chatterjee and X.-G. Wen, “Holographic theory for continuous phase transitions: Emergence and symmetry protection of gaplessness,” *Phys. Rev. B* **108** no. 7, (2023) 075105, [arXiv:2205.06244 \[cond-mat.str-el\]](#).
- [8] R. Wen and A. C. Potter, “Classification of 1+1D gapless symmetry protected phases via topological holography,” [arXiv:2311.00050 \[cond-mat.str-el\]](#).
- [9] S.-J. Huang and M. Cheng, “Topological holography, quantum criticality, and boundary states,” [arXiv:2310.16878 \[cond-mat.str-el\]](#).
- [10] L. Bhardwaj, D. Pajer, S. Schafer-Nameki, and A. Warman, “Hasse Diagrams for Gapless SPT and SSB Phases with Non-Invertible Symmetries,” [arXiv:2403.00905 \[cond-mat.str-el\]](#).
- [11] W. Ji and X.-G. Wen, “Categorical symmetry and noninvertible anomaly in symmetry-breaking and topological phase transitions,” *Phys. Rev. Res.* **2** no. 3, (2020) 033417, [arXiv:1912.13492 \[cond-mat.str-el\]](#).
- [12] D. Gaiotto and J. Kulp, “Orbifold groupoids,” *JHEP* **02** (2021) 132, [arXiv:2008.05960 \[hep-th\]](#).
- [13] F. Apruzzi, F. Bonetti, I. n. García Etxebarría, S. S. Hosseini, and S. Schafer-Nameki, “Symmetry TFTs from String Theory,” *Commun. Math. Phys.* **402** no. 1, (2023) 895–949, [arXiv:2112.02092 \[hep-th\]](#).
- [14] D. S. Freed, G. W. Moore, and C. Teleman, “Topological symmetry in quantum field theory,” [arXiv:2209.07471 \[hep-th\]](#).
- [15] H. Moradi, S. F. Moosavian, and A. Tiwari, “Topological holography: Towards a unification of Landau and beyond-Landau physics,” *SciPost Phys. Core* **6** (2023) 066, [arXiv:2207.10712 \[cond-mat.str-el\]](#).
- [16] For gapped phases an alternative approach uses module categories in [43].
- [17] T.-C. Huang, Y.-H. Lin, K. Ohmori, Y. Tachikawa, and M. Tezuka, “Numerical Evidence for a Haagerup Conformal Field Theory,” *Phys. Rev. Lett.* **128** no. 23, (2022) 231603, [arXiv:2110.03008 \[cond-mat.stat-mech\]](#).
- [18] R. Vanhove, L. Lootens, M. Van Damme, R. Wolf, T. J. Osborne, J. Haegeman, and F. Verstraete, “Critical Lattice Model for a Haagerup Conformal Field Theory,” *Phys. Rev. Lett.* **128** no. 23, (2022) 231602, [arXiv:2110.03532 \[cond-mat.stat-mech\]](#).
- [19] L. E. Bottini and S. Schafer-Nameki, “A Gapless Phase with Haagerup Symmetry,” [arXiv:2410.19040 \[hep-th\]](#).
- [20] The input data that determines the Hilbert space is $(\mathcal{C}, \mathcal{M}, \rho \in \mathcal{C})$, where \mathcal{C} is a fusion category and \mathcal{M} is a \mathcal{C} -module category and $\mathcal{S} = \mathcal{C}_{\mathcal{M}}^*$ is the actual symmetry category.
- [21] A. Feiguin, S. Trebst, A. W. W. Ludwig, M. Troyer, A. Kitaev, Z. Wang, and M. H. Freedman, “Interacting anyons in topological quantum liquids: The golden chain,” *Phys. Rev. Lett.* **98** (2007) 160409, [arXiv:cond-mat/0612341](#).
- [22] D. Aasen, R. S. K. Mong, and P. Fendley, “Topological Defects on the Lattice I: The Ising model,” *J. Phys. A* **49** no. 35, (2016) 354001, [arXiv:1601.07185 \[cond-mat.stat-mech\]](#).
- [23] D. Aasen, P. Fendley, and R. S. K. Mong, “Topological Defects on the Lattice: Dualities and Degeneracies,” [arXiv:2008.08598 \[cond-mat.stat-mech\]](#).
- [24] I. Cong, M. Cheng, and Z. Wang, “Hamiltonian and

- Algebraic Theories of Gapped Boundaries in Topological Phases of Matter,” *Commun. Math. Phys.* **355** (2017) 645–689, [arXiv:1707.04564 \[cond-mat.str-el\]](#).
- [25] M. Buican and A. Gromov, “Anyonic Chains, Topological Defects, and Conformal Field Theory,” *Commun. Math. Phys.* **356** no. 3, (2017) 1017–1056, [arXiv:1701.02800 \[hep-th\]](#).
- [26] K. Inamura, “Topological field theories and symmetry protected topological phases with fusion category symmetries,” *JHEP* **05** (2021) 204, [arXiv:2103.15588 \[cond-mat.str-el\]](#).
- [27] L. Lootens, C. Delcamp, G. Ortiz, and F. Verstraete, “Dualities in One-Dimensional Quantum Lattice Models: Symmetric Hamiltonians and Matrix Product Operator Intertwiners,” *PRX Quantum* **4** no. 2, (2023) 020357, [arXiv:2112.09091 \[quant-ph\]](#).
- [28] L. Bhardwaj, L. E. Bottini, S. Schafer-Nameki, and A. Tiwari, “Lattice Models for Phases and Transitions with Non-Invertible Symmetries,” [arXiv:2405.05964 \[cond-mat.str-el\]](#).
- [29] A. Browaeys and T. Lahaye, “Many-body physics with individually controlled rydberg atoms,” *Nat. Phys.* **16** no. 2, (2020) 132–142.
- [30] X. Wu, X. Liang, Y. Tian, F. Yang, C. Chen, Y.-C. Liu, M. K. Tey, and L. You, “A concise review of rydberg atom based quantum computation and quantum simulation,” *Chin. Phys. B* **30** no. 2, (2021) 020305.
- [31] A. M. Kaufman and K.-K. Ni, “Quantum science with optical tweezer arrays of ultracold atoms and molecules,” *Nat. Phys.* **17** no. 12, (2021) 1324–1333.
- [32] M. Morgado and S. Whitlock, “Quantum simulation and computing with rydberg-interacting qubits,” *AVS Quantum Sci.* **3** no. 2, (2021) 023501.
- [33] H. Bernien, S. Schwartz, A. Keesling, H. Levine, A. Omran, H. Pichler, S. Choi, A. S. Zibrov, M. Endres, M. Greiner, *et al.*, “Probing many-body dynamics on a 51-atom quantum simulator,” *Nature* **551** no. 7682, (2017) 579–584.
- [34] A. Keesling, A. Omran, H. Levine, H. Bernien, H. Pichler, S. Choi, R. Samajdar, S. Schwartz, P. Silvi, S. Sachdev, P. Zoller, M. Endres, M. Greiner, V. Vuletić, and M. D. Lukin, “Quantum Kibble–Zurek mechanism and critical dynamics on a programmable Rydberg simulator,” *Nature* **568** no. 7751, (Apr., 2019) 207–211.
- [35] P. Scholl, M. Schuler, H. J. Williams, A. A. Eberharter, D. Barredo, K.-N. Schymik, V. Lienhard, L.-P. Henry, T. C. Lang, T. Lahaye, A. M. Läuchli, and A. Browaeys, “Quantum simulation of 2d antiferromagnets with hundreds of rydberg atoms,” *Nature* **595** no. 7866, (2021) 233–238.
- [36] S. Ebadi, T. T. Wang, H. Levine, A. Keesling, G. Semeghini, A. Omran, D. Bluvstein, R. Samajdar, H. Pichler, W. W. Ho, S. Choi, S. Sachdev, M. Greiner, V. Vuletić, and M. D. Lukin, “Quantum phases of matter on a 256-atom programmable quantum simulator,” *Nature* **595** no. 7866, (2021) 227–232.
- [37] C. Chen, G. Bornet, M. Bintz, G. Emperauger, L. Leclerc, V. S. Liu, P. Scholl, D. Barredo, J. Hauschild, S. Chatterjee, *et al.*, “Continuous symmetry breaking in a two-dimensional rydberg array,” *Nature* **616** no. 7958, (2023) 691–695.
- [38] G. Semeghini, H. Levine, A. Keesling, S. Ebadi, T. T. Wang, D. Bluvstein, R. Verresen, H. Pichler, M. Kalinowski, R. Samajdar, A. Omran, S. Sachdev, A. Vishwanath, M. Greiner, V. Vuletić, and M. D. Lukin, “Probing topological spin liquids on a programmable quantum simulator,” *Science* **374** no. 6572, (2021) 1242–1247.
- [39] K. Singh, C. E. Bradley, S. Anand, V. Ramesh, R. White, and H. Bernien, “Mid-circuit correction of correlated phase errors using an array of spectator qubits,” *Science* **380** no. 6651, (2023) 1265–1269.
- [40] S. Anand, C. E. Bradley, R. White, V. Ramesh, K. Singh, and H. Bernien, “A dual-species Rydberg array,” *Nat. Phys.* **20** (2024) 1744.
- [41] S. Seifnashri and S.-H. Shao, “Cluster State as a Noninvertible Symmetry-Protected Topological Phase,” *Phys. Rev. Lett.* **133** no. 11, (2024) 116601, [arXiv:2404.01369 \[cond-mat.str-el\]](#).
- [42] L. Li, R.-Z. Huang, and W. Cao, “Noninvertible Symmetry-Enriched Quantum Critical Point,” [arXiv:2411.19034 \[cond-mat.str-el\]](#).
- [43] R. Thorngren and Y. Wang, “Fusion category symmetry. Part I. Anomaly in-flow and gapped phases,” *JHEP* **04** (2024) 132, [arXiv:1912.02817 \[hep-th\]](#).
- [44] For the expert reader, we choose the categorical input data: $\mathcal{C} = \text{Vec}_{D_8}$, $\mathcal{M} = \text{Vec}$, $\rho = \bigoplus_{g \in D_8} g$, so that the symmetry of the model is $\mathcal{S} = \mathcal{C}_{\mathcal{M}}^* = \text{Rep}(D_8)$.
- [45] $H_{(F,\beta)}$ is Hermitian as the projectors are and $(L_\beta^f)^\dagger = L_\beta^{f^{-1}}$, $(R_\beta^f)^\dagger = R_\beta^{f^{-1}}$ and we sum over $f \in F$ where F is a group.
- [46] J. Zeiher, J.-y. Choi, A. Rubio-Abadal, T. Pohl, R. Van Bijnen, I. Bloch, and C. Gross, “Coherent many-body spin dynamics in a long-range interacting ising chain,” *Phys. Rev. X* **7** no. 4, (2017) 041063.
- [47] P. Scholl, A. L. Shaw, R. B.-S. Tsai, R. Finkelstein, J. Choi, and M. Endres, “Erasure conversion in a high-fidelity rydberg quantum simulator,” *Nature* **622** no. 7982, (2023) 273–278.
- [48] L.-M. Steinert, P. Osterholz, R. Eberhard, L. Festa, N. Lorenz, Z. Chen, A. Trautmann, and C. Gross, “Spatially tunable spin interactions in neutral atom arrays,” *Phys. Rev. Lett.* **130** no. 24, (2023) 243001.
- [49] K. Kim, F. Yang, K. Mølmer, and J. Ahn, “Realization of an extremely anisotropic heisenberg magnet in rydberg atom arrays,” *Phys. Rev. X* **14** no. 1, (2024) 011025.
- [50] H. Levine, A. Keesling, G. Semeghini, A. Omran, T. T. Wang, S. Ebadi, H. Bernien, M. Greiner, V. Vuletić, H. Pichler, *et al.*, “Parallel implementation of high-fidelity multiqubit gates with neutral atoms,” *Phys. Rev. Lett.* **123** no. 17, (2019) 170503.
- [51] S. Ma, G. Liu, P. Peng, B. Zhang, S. Jandura, J. Claes, A. P. Burgers, G. Pupillo, S. Puri, and J. D. Thompson, “High-fidelity gates and mid-circuit erasure conversion in an atomic qubit,” *Nature* **622** no. 7982, (2023)

- 279–284.
- [52] A. Cao, W. J. Eckner, T. Lukin Yelin, A. W. Young, S. Jandura, L. Yan, K. Kim, G. Pupillo, J. Ye, N. Darkwah Oppong, *et al.*, “Multi-qubit gates and schrödinger cat states in an optical clock,” *Nature* **634** no. 8033, (2024) 315–320.
- [53] N. Maskara, S. Ostermann, J. Shee, M. Kalinowski, A. M. Gomez, R. A. Bravo, D. S. Wang, A. I. Krylov, N. Y. Yao, M. Head-Gordon, *et al.*, “Programmable simulations of molecules and materials with reconfigurable quantum processors,” *arXiv preprint arXiv:2312.02265* (2023) .
- [54] D. Jaksch, J. I. Cirac, P. Zoller, S. L. Rolston, R. Côté, and M. D. Lukin, “Fast quantum gates for neutral atoms,” *Phys. Rev. Lett.* **85** no. 10, (2000) 2208.
- [55] A. Omran, H. Levine, A. Keesling, G. Semeghini, T. T. Wang, S. Ebadi, H. Bernien, A. S. Zibrov, H. Pichler, S. Choi, J. Cui, M. Rossignolo, P. Rembold, S. Montangero, T. Calarco, M. Endres, M. Greiner, V. Vuletić, and M. D. Lukin, “Generation and manipulation of Schrödinger cat states in Rydberg atom arrays,” *Science* **365** no. 6453, (Aug., 2019) 570–574.
- [56] S. J. Evered, D. Bluvstein, M. Kalinowski, S. Ebadi, T. Manovitz, H. Zhou, S. H. Li, A. A. Geim, T. T. Wang, N. Maskara, *et al.*, “High-fidelity parallel entangling gates on a neutral-atom quantum computer,” *Nature* **622** no. 7982, (2023) 268–272.
- [57] D. Bluvstein, S. J. Evered, A. A. Geim, S. H. Li, H. Zhou, T. Manovitz, S. Ebadi, M. Cain, M. Kalinowski, D. Hangleiter, *et al.*, “Logical quantum processor based on reconfigurable atom arrays,” *Nature* **626** no. 7997, (2024) 58–65.
- [58] H. Weimer, M. Müller, I. Lesanovsky, P. Zoller, and H. P. Büchler, “A Rydberg quantum simulator,” *Nat. Phys.* **6** no. 5, (2010) 382–388.
- [59] H. Weimer, M. Müller, H. P. Büchler, and I. Lesanovsky, “Digital quantum simulation with rydberg atoms,” *Quantum Inf. Process.* **10** (2011) 885–906.
- [60] A. Bohrdt, A. Omran, E. Demler, S. Gazit, and F. Grusdt, “Multiparticle interactions for ultracold atoms in optical tweezers: Cyclic ring-exchange terms,” *Phys. Rev. Lett.* **124** no. 7, (2020) 073601.
- [61] J. T. Young, P. Bienias, R. Belyansky, A. M. Kaufman, and A. V. Gorshkov, “Asymmetric blockade and multiqubit gates via dipole-dipole interactions,” *Phys. Rev. Lett.* **127** no. 12, (2021) 120501.
- [62] S. Jandura and G. Pupillo, “Time-optimal two-and three-qubit gates for rydberg atoms,” *Quantum* **6** (2022) 712.
- [63] C. Fromenteil, R. Tricarico, F. Cesa, and H. Pichler, “Hamilton-jacobi-bellman equations for rydberg-blockade processes,” *Phys. Rev. Research* **6** no. 3, (2024) 033333.
- [64] S. De Léséleuc, V. Lienhard, P. Scholl, D. Barredo, S. Weber, N. Lang, H. P. Büchler, T. Lahaye, and A. Browaeys, “Observation of a symmetry-protected topological phase of interacting bosons with rydberg atoms,” *Science* **365** no. 6455, (2019) 775–780.
- [65] D. Bluvstein, H. Levine, G. Semeghini, T. T. Wang, S. Ebadi, M. Kalinowski, A. Keesling, N. Maskara, H. Pichler, M. Greiner, *et al.*, “A quantum processor based on coherent transport of entangled atom arrays,” *Nature* **604** no. 7906, (2022) 451–456.
- [66] C. Dlaska, K. Ender, G. B. Mbeng, A. Kruckenhauser, W. Lechner, and R. van Bijnen, “Quantum optimization via four-body Rydberg gates,” *Phys. Rev. Lett.* **128** no. 12, (2022) 120503.
- [67] L. Eck and P. Fendley, “Critical lines and ordered phases in a Rydberg-blockade ladder,” *Phys. Rev. B* **108** no. 12, (2023) 125135, [arXiv:2304.08484 \[cond-mat.str-el\]](#).
- [68] L. Bhardwaj, L. E. Bottini, S. Schafer-Nameki, and A. Tiwari, “Illustrating the Categorical Landau Paradigm in Lattice Models,” [arXiv:2405.05302 \[cond-mat.str-el\]](#).
- [69] A. Chatterjee, O. M. Aksoy, and X.-G. Wen, “Quantum Phases and Transitions in Spin Chains with Non-Invertible Symmetries,” [arXiv:2405.05331 \[cond-mat.str-el\]](#).
- [70] J. Kaidi, K. Ohmori, and Y. Zheng, “Kramers-Wannier-like Duality Defects in (3+1)D Gauge Theories,” *Phys. Rev. Lett.* **128** no. 11, (2022) 111601, [arXiv:2111.01141 \[hep-th\]](#).
- [71] Y. Choi, C. Cordova, P.-S. Hsin, H. T. Lam, and S.-H. Shao, “Noninvertible duality defects in 3+1 dimensions,” *Phys. Rev. D* **105** no. 12, (2022) 125016, [arXiv:2111.01139 \[hep-th\]](#).
- [72] L. Bhardwaj, L. E. Bottini, S. Schafer-Nameki, and A. Tiwari, “Non-Invertible Higher-Categorical Symmetries,” *SciPost Phys.* **14** (2023) 007, [arXiv:2204.06564 \[hep-th\]](#).
- [73] C. Delcamp and A. Tiwari, “Higher categorical symmetries and gauging in two-dimensional spin systems,” *SciPost Phys.* **16** (2024) 110, [arXiv:2301.01259 \[hep-th\]](#).
- [74] K. Inamura and K. Ohmori, “Fusion Surface Models: 2+1d Lattice Models from Fusion 2-Categories,” [arXiv:2305.05774 \[cond-mat.str-el\]](#).
- [75] L. Eck and P. Fendley, “Generalizations of Kitaev’s honeycomb model from braided fusion categories,” [arXiv:2408.04006 \[cond-mat.str-el\]](#).
- [76] P. Gorantla, S.-H. Shao, and N. Tantivasadakarn, “Tensor networks for non-invertible symmetries in 3+1d and beyond,” [arXiv:2406.12978 \[quant-ph\]](#).
- [77] L. Bhardwaj, K. Inamura, S. Huang, S. Schafer-Nameki, and A. Tiwari, “Fusion Surface Models for Categorical Phases in (2+1)d ,” .
- [78] A. Antinucci, C. Copetti, and S. Schafer-Nameki, “SymTFT for (3+1)d Gapless SPTs and Obstructions to Confinement,” [arXiv:2408.05585 \[hep-th\]](#).
- [79] L. Bhardwaj, D. Pajer, S. Schafer-Nameki, A. Tiwari, A. Warman, and J. Wu, “Gapped Phases in (2+1)d with Non-Invertible Symmetries: Part I,” [arXiv:2408.05266 \[hep-th\]](#).
- [80] R. Wen, “String condensation and topological holography for 2+1D gapless SPT,” [arXiv:2408.05801](#)

[cond-mat.str-el].

- [81] Y. Choi, Y. Sanghavi, S.-H. Shao, and Y. Zheng, “Non-invertible and higher-form symmetries in 2+1d lattice gauge theories,” [arXiv:2405.13105](#) [cond-mat.str-el].
- [82] H.-L. Huang, D. Wu, D. Fan, and X. Zhu, “Superconducting quantum computing: a review,” *Sci. China Inf. Sci.* **63** (2020) 1–32.
- [83] C. Monroe, W. C. Campbell, L.-M. Duan, Z.-X. Gong, A. V. Gorshkov, P. W. Hess, R. Islam, K. Kim, N. M. Linke, G. Pagano, *et al.*, “Programmable quantum simulations of spin systems with trapped ions,” *Rev. Mod. Phys.* **93** no. 2, (2021) 025001.
- [84] M. Iqbal *et al.*, “Non-Abelian topological order and anyons on a trapped-ion processor,” *Nature* **626** no. 7999, (2024) 505–511, [arXiv:2305.03766](#) [quant-ph].
- [85] D. Tambara and S. Yamagami, “Tensor categories with fusion rules of self-duality for finite abelian groups,” *Journal of Algebra* **209** no. 2, (1998) 692–707.
- [86] V. Ostrik, “Module categories over the Drinfeld double of a finite group,” *arXiv Mathematics e-prints* (Feb., 2002) math/0202130, [arXiv:math/0202130](#) [math.QA].
- [87] Alternatively, they can be labeled in terms of three copies of the toric code with non-trivial 3-cocycle [84].
- [88] Y.-H. Lin, M. Okada, S. Seifnashri, and Y. Tachikawa, “Asymptotic density of states in 2d CFTs with non-invertible symmetries,” *JHEP* **03** (2023) 094, [arXiv:2208.05495](#) [hep-th].
- [89] L. Bhardwaj and S. Schafer-Nameki, “Generalized Charges, Part I: Invertible Symmetries and Higher Representations,” [arXiv:2304.02660](#) [hep-th].
- [90] L. Bhardwaj, L. E. Bottini, S. Schafer-Nameki, and A. Tiwari, “Non-invertible symmetry webs,” *SciPost Phys.* **15** no. 4, (2023) 160, [arXiv:2212.06842](#) [hep-th].
- [91] We have simplified the expression by replacing the product $(\mathbb{I}_i \mathbb{I}_{i+1} + R_i^a L_{i+1}^a)(\mathbb{I}_i \mathbb{I}_{i+1} + R_i^b L_{i+1}^b)$ with the sum of its two factors, since they mutually commute and hence can be minimized independently.
- [92] D. Pérez-García, M. M. Wolf, M. Sanz, F. Verstraete, and J. I. Cirac, “String Order and Symmetries in Quantum Spin Lattices,” *Phys. Rev. Lett.* **100** no. 16, (2008) 167202.
- [93] F. Pollmann and A. M. Turner, “Detection of symmetry-protected topological phases in one dimension,” *Phys. Rev. B* **86** no. 12, (2012) 125441.
- [94] We have simplified the expression by replacing the product $(\mathbb{I}_i \mathbb{I}_{i+1} + R_i^c L_{i+1}^c)(\mathbb{I}_i \mathbb{I}_{i+1} + R_i^{ab} L_{i+1}^{ab})$ with the sum of its two factors, since they mutually commute and hence can be minimized independently.
- [95] T. Kennedy and H. Tasaki, “Hidden $Z_2 \times Z_2$ symmetry breaking in Haldane-gap antiferromagnets,” *Phys. Rev. B* **45** no. 1, (1992) 304.
- [96] T. Kennedy and H. Tasaki, “Hidden symmetry breaking and the haldane phase in $s=1$ quantum spin chains,” *Communications in mathematical physics* **147** (1992)

431–484.

- [97] H. Moradi, O. M. Aksoy, J. H. Bardarson, and A. Tiwari, “Symmetry fractionalization, mixed-anomalies and dualities in quantum spin models with generalized symmetries,” [arXiv:2307.01266](#) [cond-mat.str-el].

CONTENTS

References	5
A. Lattice Model with $\text{Rep}(D_8)$ symmetry	8
1. Preliminaries	8
2. SymTFT, Generalized Charges and Gapped Phases	9
3. Spin chain: State Space and Local Operators	9
4. Solvable Hamiltonians for Gapped Phases	11
5. Multiplets of the $\text{Rep}(D_8)$ Symmetry	11
6. Spin-Chain Realization of all Gapped Phases	14
7. $\text{Rep}(D_8)$ Phase Transitions	20
B. Elementary quantum gates in a Rydberg quantum simulator	21

Appendix A: Lattice Model with $\text{Rep}(D_8)$ symmetry

1. Preliminaries

In this section, we describe some mathematical preliminaries related to the group D_8 and its representation theory, which play an important role in the model we will subsequently consider. The dihedral group D_8 is the isometry group of a square and can be presented as

$$D_8 := (\mathbb{Z}_2^a \times \mathbb{Z}_2^b) \rtimes \mathbb{Z}_2^c = \{1, a, b, ab, c, ca, cb, cab\}. \quad (\text{A1})$$

It comprises of a normal subgroup

$$\mathbb{Z}_2^a \times \mathbb{Z}_2^b = \{1, a, b, ab\}. \quad (\text{A2})$$

The adjoint action of $c \in \mathbb{Z}_2^c$ exchanges a and b , i.e.,

$$cac = b, \quad cbc = a. \quad (\text{A3})$$

D_8 has two order-4 elements, given by $ca = bc$ and its inverse $cb = ac$. All other non-identity elements are of order-2. The conjugacy classes of D_8 are:

$$\begin{aligned} [1] &= \{1\}, & [ab] &= \{ab\}, & [ca] &= \{ca, cb\}, \\ [a] &= \{a, b\}, & [c] &= \{c, cab\}. \end{aligned} \quad (\text{A4})$$

The group D_8 has five irreducible representations labeled as $\{1, 1_c, 1_a, 1_{ca}, E\}$. From these the first four labeled as 1_x are 1-dimensional, while the E representations is 2-dimensional. The character table for D_8 is shown in table II.

	[1]	[ab]	[ca]	[c]	[a]
1:	1	1	1	1	1
1_c :	1	1	-1	1	-1
1_a :	1	1	-1	-1	1
1_{ca} :	1	1	1	-1	-1
E :	2	-2	0	0	0

Table II. D_8 character table.

The invertible, i.e., one dimensional, irreducible representations $\{1, 1_c, 1_a, 1_{ca}\}$ can be read off from their characters while the 2-dimensional irreducible representation E has the matrix representation

$$\begin{aligned} \mathcal{D}_E(1) &= \mathbb{I}^{(2)}, & \mathcal{D}_E(c) &= X, \\ \mathcal{D}_E(a) &= Y, & \mathcal{D}_E(b) &= -Y. \end{aligned} \quad (\text{A5})$$

The fusion category $\text{Rep}(D_8)$, which will be the symmetry category of our spin model, has five simple objects which correspond to the irreducible representations of D_8 . The fusion rules in $\text{Rep}(D_8)$ are inherited from the tensor product of the representations. Specifically, the 1 dimensional irreps 1_k , for $k = c, a, ca$, fuse according to $\mathbb{Z}_2 \times \mathbb{Z}_2$:

$$1_a \otimes 1_c = 1_c \otimes 1_a = 1_{ca}, \quad 1_k \otimes 1_k = 1, \quad (\text{A6})$$

whereas the two dimensional representation E satisfies

$$\begin{aligned} E \otimes 1_k &= 1_k \otimes E = E, \\ E \otimes E &= 1 \oplus 1_a \oplus 1_c \oplus 1_{ca}. \end{aligned} \quad (\text{A7})$$

These fusion rules are those of a Tambara-Yamagami category $\text{Rep}(D_8) = \text{TY}(\mathbb{Z}_2 \times \mathbb{Z}_2, \chi_1, +\frac{1}{2})$, defined in [85], which also contains more refined data corresponding to the associator $\alpha_{R_1, R_2, R_3} : (R_1 \otimes R_2) \otimes R_3 \rightarrow R_1 \otimes (R_2 \otimes R_3)$ encoding the F -symbols of the fusion category.

2. SymTFT, Generalized Charges and Gapped Phases

In this section we will briefly summarize the theoretical underpinning of the classification of phases in the categorical Landau paradigm (for more details see [3–6, 10]). The protagonist is the SymTFT for a categorical symmetry \mathcal{S} , which for a d -dimensional system is a $d + 1$ dimensional topological field theory, which allows the separation of symmetry from dynamics. The SymTFT for a $(1+1)d$ theory with symmetry \mathcal{S} is a $(2+1)d$ TFT with two boundaries: $\mathfrak{B}^{\text{sym}}$ specifies the symmetry, whereas $\mathfrak{B}^{\text{phys}}$ encodes the dynamical information of a $(1+1)d$ theory:

$$\begin{array}{ccc} \mathfrak{B}^{\text{sym}} & & \mathfrak{B}^{\text{phys}} \\ & \boxed{\text{SymTFT}} & \\ & & \end{array} \quad (\text{A8})$$

The topological defects (anyons) of the SymTFT (which form the so-called Drinfeld center of the symmetry category) generalize the notion of representations to categorical symmetries: they give rise to generalized charges, which form multiplets under the categorical symmetry. For $\text{Rep}(D_8)$ the generalized charges are $\mathcal{Q}_{[g], R}$, where $[g]$ is a conjugacy class and Γ a representation of the centralizer of $g \in [g]$. We will determine the generalized charges in detail and their lattice realization in section A 5.

Gapped phases with symmetry \mathcal{S} are classified in the SymTFT by letting $\mathfrak{B}^{\text{phys}}$ also be a gapped boundary condition. Gapped boundary conditions are in 1-1 correspondence with so-called Lagrangian algebras, which specify the anyons that can end on the boundary of the SymTFT. For $\text{Rep}(D_8)$ these are summarized in table III. The simplicity of this classification of gapped phases is not the only advantage of the SymTFT approach: it encodes the order parameters for the phase, and the action of the categorical symmetry on these.

For $\text{Rep}(D_8)$ there are 11 gapped phases, given by the pairing $\mathfrak{B}^{\text{sym}} = \mathcal{A}_{33}$ in table III with $\mathfrak{B}^{\text{phys}}$ taking value in each of the Lagrangian algebras in table III. The order parameters are determined as the set of anyons that appear both in the set of anyons specifying the symmetry boundary and the physical boundary. The action of the symmetry on the order parameters is given by the linking in the 3d SymTFT. In summary:

- Gapped phases: SymTFT with choice of $\mathfrak{B}^{\text{sym}} = \mathcal{A}_{33}$, $\mathfrak{B}^{\text{phys}} = \mathcal{A}_i$ in table III.
- Order parameters: $\mathcal{A}_{33} \cap \mathcal{A}_i$ (counted with multiplicities)
- Ground states: $n = \sum_a n_a^{\mathcal{A}_{33}} n_a^{\mathcal{A}_i}$
- Categorical symmetry action on ground states: linking of anyons in the SymTFT.

3. Spin chain: State Space and Local Operators

Our model is based on a spin chain with an eight dimensional Hilbert space $\mathcal{V}_i = \mathbb{C}[D_8] \cong \mathbb{C}^8$ associated to each lattice site i spanned by basis states $|g\rangle$ for $g \in D_8$. Practically, we consider the space \mathcal{V}_i as corresponding to three qubits located at the site i and therefore we may also span this state space by the basis

$$|s^I s^{II} s^{III}\rangle, \quad s^\alpha \in \{0, 1\}, \quad (\text{A9})$$

with the identification between $|g\rangle$ and $|s^I s^{II} s^{III}\rangle$ given by

$$\begin{aligned} |1\rangle &\mapsto |000\rangle, & |a\rangle &\mapsto |010\rangle, \\ |b\rangle &\mapsto |001\rangle, & |ab\rangle &\mapsto |011\rangle, \\ |c\rangle &\mapsto |100\rangle, & |ca\rangle &\mapsto |101\rangle, \\ |cb\rangle &\mapsto |110\rangle, & |cab\rangle &\mapsto |111\rangle. \end{aligned} \quad (\text{A10})$$

Label in [10]	Lagrangian algebra	$(F)^\beta$	Gapped phase for $S = \text{Rep}(D_8)$	n	Section
\mathcal{A}_{27}	$([1], 1) \oplus ([1], 1_a) \oplus ([1], 1_c) \oplus ([1], 1_{ca}) \oplus 2([1], E)$	1	SPT	1	A 6 a
\mathcal{A}_{28}	$([1], 1) \oplus ([ab], 1_{ca}) \oplus ([1], 1_{ca}) \oplus ([ab], 1) \oplus 2([ca], 1)$	\mathbb{Z}_4^{ca}	$\mathbb{Z}_2 \times \mathbb{Z}_2$ SSB	4	A 6 i
\mathcal{A}_{29}	$([1], 1) \oplus ([ab], 1_c) \oplus ([1], 1_c) \oplus ([ab], 1) \oplus 2([c], 1_{+,+})$	$(\mathbb{Z}_2^c \times \mathbb{Z}_2^{ab})^+$	$\mathbb{Z}_2 \times \mathbb{Z}_2$ SSB	4	A 6 g
\mathcal{A}_{30}	$([1], 1) \oplus ([ab], 1_{ca}) \oplus ([1], 1_c) \oplus ([ab], 1_a) \oplus 2([c], 1_{+,-})$	$(\mathbb{Z}_2^c \times \mathbb{Z}_2^{ab})^-$	SPT	1	A 6 h
\mathcal{A}_{31}	$([1], 1) \oplus ([1], 1_a) \oplus ([ab], 1_a) \oplus ([ab], 1) \oplus 2([a], 1_{+,+})$	$(\mathbb{Z}_2^a \times \mathbb{Z}_2^b)^+$	$\mathbb{Z}_2 \times \mathbb{Z}_2$ SSB	4	A 6 d
\mathcal{A}_{32}	$([1], 1) \oplus ([ab], 1_{ca}) \oplus ([1], 1_a) \oplus ([ab], 1_c) \oplus 2([a], 1_{+,-})$	$(\mathbb{Z}_2^a \times \mathbb{Z}_2^b)^-$	SPT	1	A 6 e
\mathcal{A}_{33}	$([1], 1) \oplus ([ab], 1) \oplus ([c], 1_{+,+}) \oplus ([a], 1_{+,+}) \oplus ([ca], 1)$	D_8^+	$\mathfrak{B}^{\text{sym}}$ and $\text{Rep}(D_8)$ SSB	5	A 6 j
\mathcal{A}_{34}	$([1], 1) \oplus ([ab], 1_{ca}) \oplus ([c], 1_{+,-}) \oplus ([a], 1_{+,-}) \oplus ([ca], 1)$	D_8^-	\mathbb{Z}_2 SSB	2	A 6 k
\mathcal{A}_{35}	$([1], 1) \oplus ([1], 1_c) \oplus ([1], E) \oplus ([c], 1_{+,-}) \oplus ([c], 1_{+,+})$	\mathbb{Z}_2^c	\mathbb{Z}_2 SSB	2	A 6 f
\mathcal{A}_{36}	$([1], 1) \oplus ([1], 1_a) \oplus ([1], E) \oplus ([a], 1_{+,-}) \oplus ([a], 1_{+,+})$	\mathbb{Z}_2^a	\mathbb{Z}_2 SSB	2	A 6 b
\mathcal{A}_{37}	$([1], 1) \oplus ([1], 1_c) \oplus ([1], 1_a) \oplus ([1], 1_{ca}) \oplus ([ab], 1) \oplus ([ab], 1_c) \oplus ([ab], 1_a) \oplus ([ab], 1_{ca})$	\mathbb{Z}_2^{ab}	$\frac{\text{Rep}(D_8)}{(\mathbb{Z}_2 \times \mathbb{Z}_2)}$ SSB	2	A 6 c

Table III. Lagrangian algebras for $\text{Rep}(D_8)$ SymTFT, comprised of anyons, which are labeled by $\mathbf{Q}_{[g],R}$, these define gapped boundary conditions, where these anyons can condense. $(F)^\beta$ denotes the corresponding choice of (a representative of a) conjugacy class of subgroups F and $\beta \in H^2(F, U(1))$; n is the number of vacua in the gapped phase. The generalized charges that contain the local order parameters for the gapped phases are shown in blue: $\mathbf{Q}_{[g],R}$. The numbering of the Lagrangian algebras is that of reference [10].

We consider three kinds of local operators acting on any given site i . These are $L^\mathfrak{g}$, $R^\mathfrak{g}$ and $Z_\Gamma^{l,m}$ where $\mathfrak{g} \in D_8$, $\Gamma \in \text{Rep}(D_8)$ and $l, m \in \{1, \dots, \dim(\Gamma)\}$. These operators act on the group basis $|\mathfrak{g}\rangle$ as:

$$\begin{aligned} L^\mathfrak{g} |\mathfrak{h}\rangle &= |\mathfrak{gh}\rangle, \\ R^\mathfrak{g} |\mathfrak{h}\rangle &= |\mathfrak{hg}\rangle, \\ Z_\Gamma^{l,m} |\mathfrak{g}\rangle &= \mathcal{D}_\Gamma^{l,m}(\mathfrak{g})|\mathfrak{g}\rangle, \end{aligned} \quad (\text{A11})$$

where \mathcal{D}_Γ is the matrix representation of Γ . The left and right multiplication operators compose as $L_{\mathfrak{g}_2} L_{\mathfrak{g}_1} = L_{\mathfrak{g}_2 \mathfrak{g}_1}$ and $R_{\mathfrak{g}_2} R_{\mathfrak{g}_1} = R_{\mathfrak{g}_1 \mathfrak{g}_2}$ respectively.

Similarly, on the α^{th} qubit ($\alpha \in \{\text{I}, \text{II}, \text{III}\}$) at the i^{th} site, we define the Pauli operators X_i^α and Z_i^α respectively as well as the phase gate S_i^α , where $S = \text{diag}(1, i)$. For example $X_i^{\text{I}} = (X \otimes \mathbb{I}^{(2)} \otimes \mathbb{I}^{(2)})_i$. Additionally we also define the following standard two qubit gates: (i) the Swap gate $(\text{Swap})^{\alpha,\beta}$ which swaps the α and β qubits and (ii) the CZ gate ($\text{diag} = (1, 1, 1, -1)$). Concretely the left multiplication operators in (A11) can be expressed in terms of the qubit gates

$$L^a = X^{\text{II}}, \quad L^b = X^{\text{III}}, \quad L^c = X^{\text{I}} (\text{Swap})^{\text{II}, \text{III}}, \quad (\text{A12})$$

where

$$\text{Swap} = \begin{pmatrix} 1 & 0 & 0 & 0 \\ 0 & 0 & 1 & 0 \\ 0 & 1 & 0 & 0 \\ 0 & 0 & 0 & 1 \end{pmatrix}, \quad \text{Swap}^{\text{II}, \text{III}} = \mathbb{I}^{(2)} \otimes \text{Swap}, \quad (\text{A13})$$

while the right multiplication operators become

$$\begin{aligned} R^a &= Q^{\text{I},+} X^{\text{II}} + Q^{\text{I},-} X^{\text{III}}, \\ R^b &= Q^{\text{I},-} X^{\text{II}} + Q^{\text{I},+} X^{\text{III}}, \\ R^c &= X^{\text{I}}, \end{aligned} \quad (\text{A14})$$

where we have used $Q^{\alpha,\pm} = (1 \pm Z^\alpha)/2$. The Z_Γ operators corresponding to the one dimensional irreps are:

$$\begin{aligned} Z_1 &= \mathbb{I}, & Z_{1_a} &= Z^{\text{I}}, \\ Z_{1_c} &= Z^{\text{II}} Z^{\text{III}}, & Z_{1_{ca}} &= Z^{\text{I}} Z^{\text{II}} Z^{\text{III}}. \end{aligned} \quad (\text{A15})$$

Meanwhile the operators corresponding to the two dimensional irreducible representation E are

$$\begin{aligned} Z_E^{1,1} &= Q^{1_{ca},+} S^{\text{I}} Z^{\text{III}}, \\ Z_E^{1,2} &= Q^{1_{ca},-} (S^{\text{II}})^\dagger S^{\text{III}} (CZ)^{\text{II}, \text{III}}, \\ Z_E^{2,1} &= Q^{1_{ca},-} S^{\text{II}} (S^{\text{III}})^\dagger (CZ)^{\text{II}, \text{III}}, \\ Z_E^{2,2} &= Q^{1_{ca},+} (S^{\text{I}})^\dagger Z^{\text{III}}. \end{aligned} \quad (\text{A16})$$

where $Q^{1_{ca},\pm}$ is a projector onto the \pm eigensector of $Z_{1_{ca}}$.

Having defined the local on-site Hilbert space and corresponding operator algebra, we now construct a spin-chain model on a circle with sites $i \in \{1, \dots, L\}$, with $\text{Rep}(D_8)$ non-invertible symmetry. The total Hilbert space is spanned by basis states

$$|\vec{g}, \text{hol}(\mathfrak{g})\rangle, \quad (\text{A17})$$

where $\vec{\mathbf{g}} = (\mathbf{g}_1, \dots, \mathbf{g}_L)$ is an assignment of group elements to the vertices of the lattice and

$$\text{hol}(\mathbf{g}) \equiv \prod_{i=1}^L \mathbf{g}_i \quad (\text{A18})$$

is the ‘holonomy’ around the circle. We will also denote a state with holonomy $\mathbf{g} \in D_8$ as $|\Psi_{\mathbf{g}}\rangle$. The symmetry operator wrapping the circle for $\Gamma \in \text{Rep}(D_8)$, denoted by \mathcal{S}_{Γ} , acts as follows:

$$\mathcal{S}_{\Gamma} |\Psi_{\mathbf{g}}\rangle = \chi_{\Gamma}(\mathbf{g}) |\Psi_{\mathbf{g}}\rangle, \quad (\text{A19})$$

where χ_{Γ} is the character for the representation Γ , given in table II. The explicit expression for non-trivial $\Gamma \in \text{Rep}(D_8)$ follows from equations (A15)-(A16) and has the form

$$\begin{aligned} \mathcal{S}_{1_a} &= \prod_i Z_i^I, & \mathcal{S}_{1_c} &= \prod_i Z_i^{II} Z_i^{III}, \\ \mathcal{S}_{1_{ca}} &= \prod_i Z_i^I Z_i^{II} Z_i^{III}, & \mathcal{S}_E &= Z_{E,\text{prod}}^{1,1} + Z_{E,\text{prod}}^{2,2} \end{aligned} \quad (\text{A20})$$

where Z_E is a matrix of operators given in (A16) and $Z_{E,\text{prod}} = \prod_i (Z_E)_i$.

4. Solvable Hamiltonians for Gapped Phases

Gapped phases for $\text{Rep}(D_8)$ symmetry [10, 43] are classified by tuples (F, β) where F is a representative of a conjugacy class of subgroups of D_8 and β is an element of the group cohomology $H^2(F, U(1))$ [86]. A set of possible choices for F is:

$$F \in \{1, \mathbb{Z}_2^a, \mathbb{Z}_2^{ab}, \mathbb{Z}_2^c, \mathbb{Z}_4^{ca}, \mathbb{Z}_2^a \times \mathbb{Z}_2^b, \mathbb{Z}_2^c \times \mathbb{Z}_2^{ab}, D_8\}. \quad (\text{A21})$$

β can be non-trivial only when $F \simeq \mathbb{Z}_2 \times \mathbb{Z}_2$ or D_8 , for which $\beta \in H^2(F, U(1)) = \mathbb{Z}_2$. The fixed-point Hamiltonian for a gapped phase labeled as (F, β) can be written as:

$$H_{(F,\beta)} = -\frac{1}{|F|} \sum_i \sum_{\mathbf{f} \in F} (R_{\beta}^{\mathbf{f}^{-1}})_i (L_{\beta}^{\mathbf{f}})_{i+1} - \sum_i P_i^{(F)}. \quad (\text{A22})$$

Here $P_i^{(F)}$ is an operator diagonal in the qubit or group basis which projects onto the sub-Hilbert space at site i spanned by $|\mathbf{f}\rangle$ for $\mathbf{f} \in F$

$$P_i^{(F)} = \sum_{\mathbf{f} \in F} |\mathbf{f}_i\rangle \langle \mathbf{f}_i|. \quad (\text{A23})$$

These projectors have simple expressions in terms of Pauli operators Z_i^{α} that we will use in constructing concrete Hamiltonians with each phase implementable on atomic array setups. Meanwhile the operators $R_{\beta}^{\mathbf{f}^{-1}}$ and $L_{\beta}^{\mathbf{f}}$ serve as disordering operators within the projected subspace. In the case where β is trivial, these reduce to the usual left and right group multiplication operators

defined in (A11). Instead when β is non-trivial, the operator action gets modified by a $U(1)$ phase controlled by the 2-cocycle β . Concretely,

$$\begin{aligned} R_{\beta}^{\mathbf{f}^{-1}} |\mathbf{f}'\rangle &= \frac{1}{\beta(\mathbf{f}'\mathbf{f}^{-1}, \mathbf{f})} |\mathbf{f}'\mathbf{f}^{-1}\rangle, \\ L_{\beta}^{\mathbf{f}} |\mathbf{f}'\rangle &= \beta(\mathbf{f}, \mathbf{f}') |\mathbf{f}\mathbf{f}'\rangle, \end{aligned} \quad (\text{A24})$$

The Hamiltonians (A22), have been normalized such that ground states of all phases have energy $-2L$ where L is the number of lattice sites.

Twisted sectors. Typically when probing the characterization of phases with a certain symmetry \mathcal{S} , one also requires state spaces twisted by \mathcal{S} action. In the case of invertible symmetries, for example \mathbb{Z}_2 , the symmetry twisted state space is nothing but the familiar space with antiperiodic boundary conditions. Instead state spaces twisted by non-invertible symmetries, are generically not isomorphic to untwisted state spaces. For instance twisting by a symmetry operator $\Gamma \in \text{Rep}(G)$ at a link $(i, i+1)$ on the lattice involves, inserting a defect at $(i, i+1)$ whose associated state space is the vector space underlying the representation Γ which is $\mathbb{C}^{\dim(\Gamma)}$. For invertible representations which are one dimensional, this reduces to the familiar group-like case since the action on \mathbb{C} is by multiplication of a complex number that can be absorbed into a coupling constant of the lattice model. Concretely, the presence of a Γ defect at link $(i_0, i_0 + 1)$ modifies the disordering term in (A22) such that

$$(R_{\beta}^{\mathbf{g}^{-1}})_{i_0} (L_{\beta}^{\mathbf{g}})_{i_0+1}, \quad (\text{A25})$$

is replaced with

$$(R_{\beta}^{\mathbf{g}^{-1}})_{i_0} (\mathcal{D}_{\Gamma}(\mathbf{g}))_{(i_0, i_0+1)} (L_{\beta}^{\mathbf{g}})_{i_0+1} \quad (\text{A26})$$

where $(\mathcal{D}_{\Gamma}(\mathbf{g}))_{(i_0, i_0+1)}$ is an operator acting on the defect state space.

5. Multiplets of the $\text{Rep}(D_8)$ Symmetry

Symmetry representations play a central role in the Landau paradigm as phases and transitions are characterized by their condensation patterns. The collection of symmetry representations condensed in a gapped phase serve as order parameters for that phase. In the same spirit, generalized charges (representations) of non-invertible symmetries also characterize phases and transitions within the categorical Landau paradigm.

Generalized Charges for $\text{Rep}(D_8)$. We now turn to the symmetry representations of $\text{Rep}(D_8)$. We will deduce these representations in the following way. We start with the representations of D_8 symmetry, which are more familiar. We then gauge the D_8 symmetry (in two steps) to obtain the system with $\text{Rep}(D_8)$ symmetry. Since gauging is a topological manipulation, the multiplet of

operators in a given D_8 representation after gauging become operators in a certain symmetry multiplet of the $\text{Rep}(D_8)$ symmetry of the gauged model.

Representations of D_8 . Local operators in a (1+1)d system transforming in representations of D_8 symmetry can either be genuine local operators or non-genuine local operators, i.e., attached to a symmetry defect $\mathfrak{g} \in D_8$. Under the symmetry action by $\mathfrak{h} \in D_8$, a \mathfrak{g} -twisted sector operator transforms to an $\mathfrak{h}\mathfrak{g}\mathfrak{h}^{-1}$ twisted sector operator. Therefore D_8 representations are clubbed into twisted sectors labeled by conjugacy class. Moreover, a non-genuine local operator in a certain twisted sector can transform meaningfully only in a representation of the centralizer of a chosen element in the conjugacy class. To summarize symmetry multiplets of D_8 are labeled as

$$([g], R) \quad (\text{A27})$$

where $[g]$ is a D_8 conjugacy class and R is a representation of the centralizer for a representative $g \in [g]$. These are precisely the anyons in the SymTFT introduced in section A 2 [87].

Among these, the self-local charges play a special role as they can condense or become topological in the infrared. The self-local operators satisfy

$$\frac{\chi_R([g])}{\dim(R)} = 1. \quad (\text{A28})$$

One can recognize that the labels (A27) indeed also correspond to the labels of the D_8 SymTFT bulk topological lines [88, 89] and the condition (A28) simply translates to the fact that the corresponding line is Bosonic and can therefore condense on a boundary. The sets of labels satisfying (A28) are precisely the lines appearing in the Lagrangian algebras in Table III. These serve as order parameters for the different $\text{Rep}(D_8)$ phases and transitions.

We now deduce the structure of the generalized charges $\mathcal{Q}_{[g],R}$, as multiplets under the $\text{Rep}(D_8)$ symmetry.

- **$\mathcal{Q}_{[1],\Gamma}$ generalized charge.** In D_8 symmetric systems, this corresponds to a $\dim(\Gamma)$ dimensional multiplet of genuine local operators that transform in the Γ representation. After gauging the full D_8 symmetry, these Γ charged untwisted operators map to uncharged Γ twisted sector operators. Concretely an operators labeled (Γ, ℓ) with $\ell = 1, \dots, \dim(\Gamma)$ acts by inserting a Γ symmetry twist corresponding to the ℓ^{th} vector in the underlying vector space of Γ . We denote such a twisted sector operator in the lattice model as

$$\mathcal{T}_{(\Gamma, \ell)}. \quad (\text{A29})$$

To study the remaining generalized charges, we carry out the D_8 gauging in two steps. We first gauge the normal subgroup \mathbb{Z}_4^{ca} in D_8 . Upon doing so, we obtain a new dual symmetry which is $\text{Rep}(\mathbb{Z}_4^{ca})$. We denote the dual

$\text{Rep}(\mathbb{Z}_4^{ca})$ generators as ρ_n with $n = 0, 1, 2, 3$. With the properties

$$\rho_n(ca) = i^n. \quad (\text{A30})$$

Additionally there is also the remaining \mathbb{Z}_2^c symmetry which acts on $\text{Rep}(\mathbb{Z}_4^{ca})$ by the outer automorphism exchanging ρ_1 and ρ_3 . Therefore the full symmetry after gauging is

$$\text{Rep}(\mathbb{Z}_4^{ca}) \rtimes \mathbb{Z}_2^c \cong D_8. \quad (\text{A31})$$

In the second step, we gauge \mathbb{Z}_2^c . This causes ρ_1 and ρ_3 to combine into a single c -invariant non-invertible symmetry of dimension 2

$$\rho_1 \oplus \rho_3 \cong E. \quad (\text{A32})$$

Denoting the vector space underlying ρ_n as v_n , it can immediately be seen that D_8 is represented on $v_1 \oplus v_3$ precisely via the matrix representation in (A5). The remaining symmetry generators are invertible. The symmetry ρ_2 survives the \mathbb{Z}_2^c gauging and since $\rho_2(ca) = -1$ and $\rho_2(c) = 1$, we may identify

$$\rho_2 \cong 1_c. \quad (\text{A33})$$

Lastly, there is a $\text{Rep}(\mathbb{Z}_2^c)$ symmetry generated by ρ_c . Since $\rho_c(c) = -1$ and $\rho_c(ca) = -1$, we may identify

$$\rho_c \cong 1_a. \quad (\text{A34})$$

Compatibility between fusions before and after gauging imposes that $1_c, 1_a$ and E satisfy the $\text{Rep}(D_8)$ fusion rules. Similar partial gaugings were detailed in the context of 2-fusion categories in 2+1 dimensions in [90]. Let us now deduce the structure of the remaining self-local $\text{Rep}(D_8)$ generalized charges.

- **$\mathcal{Q}_{[ab],1}$ generalized charge.** As a generalized charge for a D_8 symmetric system, this is a single uncharged operator in the ab twisted sector. Upon gauging \mathbb{Z}_4^{ca} , it maps to a genuine local operator invariant under ρ_2 but transforming with a minus sign under ρ_1 and ρ_3 . Indeed this agrees with

$$\rho_n = (-1)^n. \quad (\text{A35})$$

Since it is uncharged and untwisted with respect to \mathbb{Z}_2^c , it remains unaltered upon a subsequent gauging of \mathbb{Z}_2^c . Therefore, we obtain a single local operator uncharged under $\rho_2 \cong 1_c$, and with a linking -2 (-1×2 from ρ_1 and ρ_3) with E . We identify this operator as

$$\mathcal{Q}_{([ab],1)} \cong X^{\text{II}} X^{\text{III}}. \quad (\text{A36})$$

- **$\mathcal{Q}_{[ab],1_a}$ generalized charge.** As a generalized charge for a D_8 symmetric system, this is a single operator in the ab twisted sector that is charged under ρ_c . Upon gauging \mathbb{Z}_4^{ca} , it maps to a genuine

local operator that carries a charge $(-1)^n$ under ρ_n and -1 under c . Finally, upon the subsequent gauging of \mathbb{Z}_2^c , one obtains a $\rho_c \cong 1_a$ -twisted operator with charge -1 under ρ_1 and ρ_3 or equivalently linking charge -2 under E . We may identify this operator as

$$\mathcal{Q}_{([ab],1_a)} \cong \mathcal{T}_{1_a} X^{\text{II}} X^{\text{III}}. \quad (\text{A37})$$

- **$\mathcal{Q}_{[ab],1_c}$ generalized charge.** As a D_8 symmetry charge, this corresponds to an operator in the ab twisted sector that transforms in the 1_c representation of D_8 . We may decompose $1_c = (\rho_2, 1) \in \text{Rep}(\mathbb{Z}_4^{ca}) \times \text{Rep}(\mathbb{Z}_2^c)$. Therefore upon gauging \mathbb{Z}_4^{ca} , it maps to an operator in the ρ_2 -twisted sector that carries a $(-1)^n$ charge under ρ_n . Since this operator is uncharged and untwisted with respect to \mathbb{Z}_2^c , it remains invariant under the \mathbb{Z}_2^c gauging. As a $\text{Rep}(D_8)$ multiplet, we obtain a single operator in the 1_c twisted sector that has a linking charge of -2 under E . We may identify this as

$$\mathcal{Q}_{[ab],1_c} \cong \mathcal{T}_{1_c} X^{\text{II}} X^{\text{III}}. \quad (\text{A38})$$

- **$\mathcal{Q}_{[ca],1}$ generalized charge.** As a D_8 generalized charge, this is a doublet of twisted sectors operators \mathcal{O}_{ca} and \mathcal{O}_{cb} which are ca and cb twisted respectively. We first gauge the \mathbb{Z}_4^{ca} symmetry to obtain a doublet of local operators in which \mathcal{O}_{ca} and \mathcal{O}_{cb} carry i^n and i^{-n} charge under ρ_n respectively. The \mathbb{Z}_2^c symmetry exchanges \mathcal{O}_{ca} and \mathcal{O}_{cb} . We consider the linear combinations

$$\mathcal{O}_{[ca],\pm} = \mathcal{O}_{ca} \pm \mathcal{O}_{cb}. \quad (\text{A39})$$

Among these $\mathcal{O}_{[ca],+}$ is uncharged, while $\mathcal{O}_{[ca],-}$ is charged under c . Upon gauging \mathbb{Z}_2^c , $\mathcal{O}_{[ca],+}$ becomes an uncharged operator while $\mathcal{O}_{[ca],-}$ becomes a $\rho_c \cong 1_a$ twisted operator. We identify this as the doublet

$$\mathcal{Q}_{([ca],1)} \cong \{ \mathcal{O}_{[ca],+} \sim X^{\text{I}} X^{\text{II}} + X^{\text{I}} X^{\text{III}}, \quad \mathcal{O}_{[ca],-} \sim \mathcal{T}_{1_a} (X^{\text{I}} X^{\text{II}} - X^{\text{I}} X^{\text{III}}) \}. \quad (\text{A40})$$

- **$\mathcal{Q}_{[c],1_{++}}$ generalized charge.** As a D_8 generalized charge, this corresponds to a doublet of operators \mathcal{O}_c and \mathcal{O}_{cab} in the twisted sectors of c and cab respectively. Both \mathcal{O}_c and \mathcal{O}_{cab} are uncharged under the centralizer group $\mathbb{Z}_2^c \times \mathbb{Z}_2^{ab}$ and are exchanged under \mathbb{Z}_2^{ca} (via conjugation). Consider the linear combinations

$$\mathcal{O}_{[c],\pm} = \mathcal{O}_c \pm \mathcal{O}_{cab}. \quad (\text{A41})$$

Among these, $\mathcal{O}_{[c],+}$ is uncharged under \mathbb{Z}_4^{ca} while $\mathcal{O}_{[c],-}$ transforms under $\rho_2 \in \text{Rep}(\mathbb{Z}_4^{ca})$. Upon gauging \mathbb{Z}_4^{ca} , $\mathcal{O}_{[c],+}$ becomes an uncharged c -twisted operator, while $\mathcal{O}_{[c],-}$ becomes a $c \cdot \rho_2$

twisted uncharged operator. Upon the final gauging of \mathbb{Z}_2^c , $\mathcal{O}_{[c],+}$ becomes a genuine local operator carrying a $\rho_c \cong 1_a$ charge while $\mathcal{O}_{[c],-}$ becomes a $\rho_2 \cong 1_c$ twisted sector operator carrying a 1_a charge. On the lattice, we identify this doublet as

$$\mathcal{Q}_{[c],1_{++}} = \{ \mathcal{O}_{[c],+} \sim (X^{\text{I}} + X^{\text{I}} X^{\text{II}} X^{\text{III}}), \quad \mathcal{O}_{[c],-} \sim (X^{\text{I}} - X^{\text{I}} X^{\text{II}} X^{\text{III}}) \mathcal{T}_{1_c} \}. \quad (\text{A42})$$

- **$\mathcal{Q}_{[c],1_{+-}}$ generalized charge.** As a D_8 generalized charge, this comprises of a doublet $\tilde{\mathcal{O}}_c$ and $\tilde{\mathcal{O}}_{cab}$, which transform in the representations $1_{+-}^{(c)}$ and $1_{+-}^{(cab)}$ respectively of the centraliser group $\mathbb{Z}_2^c \times \mathbb{Z}_2^{ab}$. These representations are

$$\begin{aligned} 1_{+-}^{(c)}(c) &= 1, & 1_{+-}^{(c)}(ab) &= -1, \\ 1_{+-}^{(cab)}(c) &= -1, & 1_{+-}^{(cab)}(ab) &= -1, \end{aligned} \quad (\text{A43})$$

The operators $\tilde{\mathcal{O}}_c$ and $\tilde{\mathcal{O}}_{cab}$ are exchanged under the action of ca . Moreover since $(ca)^2 = ab$, we may pick the action

$$ca : (\tilde{\mathcal{O}}_c, \tilde{\mathcal{O}}_{cab}) \mapsto (i\tilde{\mathcal{O}}_{cab}, i\tilde{\mathcal{O}}_c). \quad (\text{A44})$$

Consider the linear combinations

$$\tilde{\mathcal{O}}_{[c],\pm} := \tilde{\mathcal{O}}_c \pm \tilde{\mathcal{O}}_{cab}, \quad (\text{A45})$$

which transform under ca as

$$ca : \tilde{\mathcal{O}}_{[c],\pm} \mapsto \pm i \tilde{\mathcal{O}}_{[c],\pm}. \quad (\text{A46})$$

Upon gauging \mathbb{Z}_4^{ca} , these charged operators become twisted sector operators under the dual $\text{Rep}(\mathbb{Z}_4^{ca})$ symmetry. Specifically, $\tilde{\mathcal{O}}_{[c],+}$ is now $c \cdot \rho_1$ twisted while $\tilde{\mathcal{O}}_{[c],-}$ is $c \cdot \rho_3$ twisted. These two twisted sector operators are exchanged under the c action. This follows from the fact that the twisted sectors ρ_1 and ρ_3 are exchanged under c and is compatible with the charge assignment in (A43). Hence we take odd and even combinations of $\tilde{\mathcal{O}}_{[c],\pm}$. The even combination

$$\tilde{\mathcal{O}}_c \propto \tilde{\mathcal{O}}_{[c],+} + \tilde{\mathcal{O}}_{[c],-}, \quad (\text{A47})$$

is uncharged under \mathbb{Z}_2^c and we therefore obtain a $E = \rho_1 \oplus \rho_3$ twisted sector operator charged under \mathbb{Z}_{1_a} upon gauging \mathbb{Z}_2^c . Instead the odd combination

$$\tilde{\mathcal{O}}_{cab} \propto \tilde{\mathcal{O}}_{[c],+} - \tilde{\mathcal{O}}_{[c],-}, \quad (\text{A48})$$

is charged under c and therefore we obtain a line changing operator from E to 1_a upon gauging \mathbb{Z}_2^c . We propose the following lattice representatives for these operators

$$\mathcal{Q}_{[c],1_{+-}} = \{ \mathcal{T}_{(E,v_+)} X^{\text{I}}, \mathcal{T}_{(E,v_+) \otimes 1_a} X^{\text{I}} X^{\text{II}} X^{\text{III}} \}. \quad (\text{A49})$$

- $\mathcal{Q}_{[a],1_{++}}$ **generalized charge.** As a D_8 symmetry multiplet, this corresponds to a doublet of twisted sector operators \mathcal{O}_a and \mathcal{O}_b , in the $a = c \times ca$ and $b = c \times (ca)^3$ twisted sectors respectively. Upon gauging \mathbb{Z}_4^{ca} , \mathcal{O}_a and \mathcal{O}_b both go to the twisted sector of c and carry charges $(i)^n$ and $(-i)^n$ under ρ_n respectively. Note that \mathcal{O}_a and \mathcal{O}_b are exchanged under the action of c and therefore we must take odd and even combinations

$$\mathcal{O}_{[a],\pm} := \mathcal{O}_a \pm \mathcal{O}_b. \quad (\text{A50})$$

The even and odd combinations are uncharged and charged under \mathbb{Z}_2^c respectively and therefore go to the untwisted and twisted sectors of $\rho_c \cong 1_a$ upon gauging \mathbb{Z}_2^c . We identify these operators as

$$\mathcal{Q}_{[a],1_{++}} = \{X^{\text{II}} + X^{\text{III}}, \mathcal{T}_{1_a}(X^{\text{II}} - X^{\text{III}})\}. \quad (\text{A51})$$

6. Spin-Chain Realization of all Gapped Phases

In this section, we provide a concrete qubit-based realization of commuting projector Hamiltonians within all $\text{Rep}(D_8)$ symmetric gapped phases. These Hamiltonians have the form (A22) for different choices of (F, β) .

a. $\text{Rep}(D_8)$ trivial phase for $F = 1$

Setting $F = 1$ in eq. (A22), the Hamiltonian is:

$$\begin{aligned} H_1 &= - \sum_i \left[\mathbb{I} + P^{(1)} \right]_i \\ &= - \sum_i \left[\mathbb{I} + \frac{1}{8}(\mathbb{I} + Z^{\text{I}})(\mathbb{I} + Z^{\text{II}})(\mathbb{I} + Z^{\text{III}}) \right]_i. \end{aligned} \quad (\text{A52})$$

It has a single ground state (which we write first in the \mathbb{Z}_2^3 basis and then the basis labeled by $g \in D_8$):

$$|\text{GS}\rangle = \bigotimes_i |000\rangle_i = \bigotimes_i |1\rangle_i. \quad (\text{A53})$$

The $\text{Rep}(D_8)$ symmetry (A19) acts as

$$\mathcal{S}_\Gamma |\text{GS}\rangle = \dim(\Gamma) |\text{GS}\rangle. \quad (\text{A54})$$

It is a trivial SPT phase for $\text{Rep}(D_8)$ symmetry, with order parameter given by the charge $\mathcal{Q}_{[1],1}$.

b. \mathbb{Z}_2 SSB phase for $F = \mathbb{Z}_2^a$

Setting $F = \mathbb{Z}_2^a$ in eq. (A22), the Hamiltonian is:

$$\begin{aligned} H_{\mathbb{Z}_2^a} &= -\frac{1}{2} \sum_i (\mathbb{I}_i \mathbb{I}_{i+1} + R_i^a L_{i+1}^a) - \sum_i P_i^{(\mathbb{Z}_2^a)} \\ &\approx -\frac{1}{2} \sum_i (\mathbb{I}_i \mathbb{I}_{i+1} + X_i^{\text{II}} X_{i+1}^{\text{II}}) \\ &\quad - \frac{1}{4} \sum_i [(\mathbb{I} + Z^{\text{I}})(\mathbb{I} + Z^{\text{III}})]_i. \end{aligned} \quad (\text{A55})$$

The second term projects onto $\mathbb{Z}_2^a = \{|000\rangle = |1\rangle, |010\rangle = |a\rangle\}$ on each site i ; the first term (which we simplified by restricting it to this subspace) is minimized by the X^{II} eigenstates, there are therefore 2 linearly independent ground states:

$$\begin{aligned} |\text{GS}, +\rangle &= \bigotimes_i \left(\frac{|000\rangle + |010\rangle}{\sqrt{2}} \right)_i = \bigotimes_i \left(\frac{|1\rangle + |a\rangle}{\sqrt{2}} \right)_i \\ &\equiv |\Psi_1\rangle + |\Psi_a\rangle, \\ |\text{GS}, -\rangle &= \bigotimes_i \left(\frac{|000\rangle - |010\rangle}{\sqrt{2}} \right)_i = \bigotimes_i \left(\frac{|1\rangle - |a\rangle}{\sqrt{2}} \right)_i \\ &\equiv |\Psi_1\rangle - |\Psi_a\rangle. \end{aligned} \quad (\text{A56})$$

The action of the $\text{Rep}(D_8)$ generators (A19) on the ground states (A56) is:

$$\begin{aligned} \mathcal{S}_1 |\text{GS}, \pm\rangle &= \mathcal{S}_{1_a} |\text{GS}, \pm\rangle = |\text{GS}, \pm\rangle, \\ \mathcal{S}_{1_c} |\text{GS}, \pm\rangle &= \mathcal{S}_{1_{ca}} |\text{GS}, \pm\rangle = |\text{GS}, \mp\rangle, \\ \mathcal{S}_E |\text{GS}, \pm\rangle &= |\text{GS}, +\rangle + |\text{GS}, -\rangle. \end{aligned} \quad (\text{A57})$$

This is therefore a \mathbb{Z}_2 SSB phase for $\text{Rep}(D_8)$: the \mathbb{Z}_2 symmetries exchanging the two ground states are \mathcal{S}_{1_c} and $\mathcal{S}_{1_{ca}}$.

We note that \mathcal{S}_E sends each ground state to the sum of both: this a hallmark of non-invertible symmetries.

Order parameter. The local order parameter for this phase is the generalized charge $\mathcal{Q}_{([a],1_{++})}$, which is realized on this subspace by the operator X_i^{II} :

$$\langle \text{GS}, \pm | X_i^{\text{II}} | \text{GS}, \pm \rangle = \pm 1. \quad (\text{A58})$$

c. $\text{Rep}(D_8)/(\mathbb{Z}_2 \times \mathbb{Z}_2)$ SSB phase for $F = \mathbb{Z}_2^{ab}$

Setting $F = \mathbb{Z}_2^{ab}$ in (A22), the Hamiltonian is:

$$\begin{aligned} H_{\mathbb{Z}_2^{ab}} &= -\frac{1}{2} \sum_i [\mathbb{I}_i \mathbb{I}_{i+1} + R_i^{ab} L_{i+1}^{ab}] - \sum_i P_i^{(\mathbb{Z}_2^{ab})} \\ &\approx -\frac{1}{2} \sum_i [\mathbb{I}_i \mathbb{I}_{i+1} + (X_i^{\text{II}} X_{i+1}^{\text{III}})(X_i^{\text{II}} X_{i+1}^{\text{III}})] \\ &\quad - \frac{1}{4} \sum_i [(\mathbb{I} + Z^{\text{I}})(\mathbb{I} + Z^{\text{II}} Z^{\text{III}})]_i. \end{aligned} \quad (\text{A59})$$

The second term projects onto $\mathbb{Z}_2^{ab} = \{|000\rangle = |1\rangle, |011\rangle = |ab\rangle\}$ on each site $i \in \{1, \dots, L\}$; the first term (which we simplified by restricting it to this subspace) is minimized by the $X^{\text{II}} X^{\text{III}}$ eigenstates, there are therefore 2 linearly independent ground states:

$$\begin{aligned} |\text{GS}, +\rangle &= \bigotimes_i \left(\frac{|000\rangle + |011\rangle}{\sqrt{2}} \right)_i = \bigotimes_i \left(\frac{|1\rangle + |ab\rangle}{\sqrt{2}} \right)_i \\ &\equiv |\Psi_1\rangle + |\Psi_{ab}\rangle, \\ |\text{GS}, -\rangle &= \bigotimes_i \left(\frac{|000\rangle - |011\rangle}{\sqrt{2}} \right)_i = \bigotimes_i \left(\frac{|1\rangle - |ab\rangle}{\sqrt{2}} \right)_i \\ &\equiv |\Psi_1\rangle - |\Psi_{ab}\rangle. \end{aligned} \quad (\text{A60})$$

Up to now, this discussion appears very similar to the previous case. However, once we take the $\text{Rep}(D_8)$ symmetry into account, the phases are of different types. Indeed, the action of the $\text{Rep}(D_8)$ generators on the ground states (A60) is:

$$\begin{aligned} \mathcal{S}_\alpha |\text{GS}, \pm\rangle &= |\text{GS}, \pm\rangle, \quad \alpha = 1, 1_a, 1_c, 1_{ca} \\ \mathcal{S}_E |\text{GS}, \pm\rangle &= 2 |\text{GS}, \mp\rangle. \end{aligned} \quad (\text{A61})$$

In this phase the symmetry generated by the 2-dimensional irreducible representation E is spontaneously broken: \mathcal{S}_E exchanges the ground states and also multiplies them by a factor of 2. Unlike previous case, the full $\mathbb{Z}_2 \times \mathbb{Z}_2$ subsymmetry of $\text{Rep}(D_8)$ is preserved, so this is a $\text{Rep}(D_8)/(\mathbb{Z}_2 \times \mathbb{Z}_2)$ SSB phase.

Order parameter. The local order parameter for this phase comes the generalized charge $\mathbf{Q}_{[ab],1}$ and is given by the operator $(X^{\text{II}} X^{\text{III}})_i$:

$$\langle \text{GS}, \pm | (X^{\text{II}} X^{\text{III}})_i | \text{GS}, \pm \rangle = \pm 1. \quad (\text{A62})$$

d. $\mathbb{Z}_2 \times \mathbb{Z}_2$ SSB phase for $(F)^\beta = (\mathbb{Z}_2^a \times \mathbb{Z}_2^b)^+$

By choosing $F = \mathbb{Z}_2^a \times \mathbb{Z}_2^b$ and trivial β in eq. (A22), we obtain the following effective Hamiltonian [91]

$$\begin{aligned} H_{(\mathbb{Z}_2^a \times \mathbb{Z}_2^b)^+} &\approx -\frac{1}{4} \sum_i (\mathbb{I}_i \mathbb{I}_{i+1} + R_i^a L_{i+1}^a) \\ &\quad - \frac{1}{4} \sum_i (\mathbb{I}_i \mathbb{I}_{i+1} + R_i^b R_{i+1}^b) - \sum_i P_i^{(\mathbb{Z}_2^a \times \mathbb{Z}_2^b)} \\ &\approx -\frac{1}{4} \sum_i (\mathbb{I}_i \mathbb{I}_{i+1} + X_i^{\text{II}} X_{i+1}^{\text{II}}) \\ &\quad - \frac{1}{4} \sum_i (\mathbb{I}_i \mathbb{I}_{i+1} + X_i^{\text{III}} X_{i+1}^{\text{III}}) - \frac{1}{2} \sum_i [\mathbb{I} + Z^{\text{I}}]_i. \end{aligned} \quad (\text{A63})$$

The projector term is minimized, on each site $i \in \{1, \dots, L\}$ by the states corresponding to the elements in

$$\begin{aligned} \mathbb{Z}_2^a \times \mathbb{Z}_2^b \\ = \{|000\rangle = |1\rangle, |010\rangle = |a\rangle, |001\rangle = |b\rangle, |011\rangle = |ab\rangle\}. \end{aligned} \quad (\text{A64})$$

The remaining terms are minimized by the X^{II} and X^{III} eigenstates independently, giving rise to 4 linearly inde-

pendent ground states:

$$\begin{aligned} |\text{GS}, ++\rangle &= \bigotimes_i \left(\frac{|1\rangle + |a\rangle + |b\rangle + |ab\rangle}{2} \right)_i \\ &\equiv |\Psi_1\rangle + |\Psi_a\rangle + |\Psi_b\rangle + |\Psi_{ab}\rangle, \\ |\text{GS}, +- \rangle &= \bigotimes_i \left(\frac{|1\rangle + |a\rangle - |b\rangle - |ab\rangle}{2} \right)_i \\ &\equiv |\Psi_1\rangle + |\Psi_a\rangle - |\Psi_b\rangle - |\Psi_{ab}\rangle, \\ |\text{GS}, -+ \rangle &= \bigotimes_i \left(\frac{|1\rangle - |a\rangle + |b\rangle - |ab\rangle}{2} \right)_i \\ &\equiv |\Psi_1\rangle - |\Psi_a\rangle + |\Psi_b\rangle - |\Psi_{ab}\rangle, \\ |\text{GS}, -- \rangle &= \bigotimes_i \left(\frac{|1\rangle - |a\rangle - |b\rangle + |ab\rangle}{2} \right)_i \\ &\equiv |\Psi_1\rangle - |\Psi_a\rangle - |\Psi_b\rangle + |\Psi_{ab}\rangle. \end{aligned} \quad (\text{A65})$$

From the character table II, we deduce the following action of $\text{Rep}(D_8)$ generators on the ground states:

$$\begin{aligned} \mathcal{S}_1 |\text{GS}, s, s'\rangle &= \mathcal{S}_{1_a} |\text{GS}, s, s'\rangle = |\text{GS}, s, s'\rangle, \\ \mathcal{S}_{1_c} |\text{GS}, s, s'\rangle &= \mathcal{S}_{1_{ca}} |\text{GS}, s, s'\rangle = |\text{GS}, -s, -s'\rangle \\ \mathcal{S}_E |\text{GS}, ++\rangle &= \mathcal{S}_E |\text{GS}, --\rangle = |\text{GS}, +- \rangle + |\text{GS}, -+ \rangle, \\ \mathcal{S}_E |\text{GS}, +- \rangle &= \mathcal{S}_E |\text{GS}, -+ \rangle = |\text{GS}, ++\rangle + |\text{GS}, --\rangle, \end{aligned} \quad (\text{A66})$$

for all $s, s' = \pm$. The 4 ground states form 2 different \mathbb{Z}_2 orbits under the broken generators \mathcal{S}_{1_c} and $\mathcal{S}_{1_{ca}}$:

$$\mathcal{S}_{1_c}, \mathcal{S}_{1_{ca}} : \begin{aligned} |\text{GS}, ++\rangle &\leftrightarrow |\text{GS}, --\rangle \\ |\text{GS}, +- \rangle &\leftrightarrow |\text{GS}, -+ \rangle \end{aligned} \quad (\text{A67})$$

this is therefore a $\mathbb{Z}_2 \times \mathbb{Z}_2$ SSB phase for $\text{Rep}(D_8)$ symmetry. The local order parameters come from the generalized charges $\mathbf{Q}_{[ab],1}$ and $2\mathbf{Q}_{[a],1+,+}$, which are realized in the lattice by the operators $X_i^{\text{II}}, X_i^{\text{III}}, (X^{\text{II}} X^{\text{III}})_i$ which have the following eigenvalues in the ground states:

$$\begin{aligned} \langle \text{GS}, s, s' | X_i^{\text{II}} | \text{GS}, s, s' \rangle &= s, \\ \langle \text{GS}, s, s' | X_i^{\text{III}} | \text{GS}, s, s' \rangle &= s', \\ \langle \text{GS}, s, s' | (X^{\text{II}} X^{\text{III}})_i | \text{GS}, s, s' \rangle &= ss'. \end{aligned} \quad (\text{A68})$$

e. *Non-trivial SPT phase for $(F)^\beta = (\mathbb{Z}_2^a \times \mathbb{Z}_2^b)^-$*

We now consider the same subgroup $F = \mathbb{Z}_2^a \times \mathbb{Z}_2^b$ as the previous case, but now with the non-identity

$$\beta \in H^2(\mathbb{Z}_2^a \times \mathbb{Z}_2^b, U(1)) = \mathbb{Z}_2. \quad (\text{A69})$$

As a representative of β , we choose:

$$\beta((p_1, q_1), (p_2, q_2)) = (-1)^{p_1 q_2}. \quad (\text{A70})$$

From the general discussion below equation (A22), this choice of β is realized on the lattice by introducing the

operators $Z^{\text{II}}, Z^{\text{III}}$ in expression (A63) as follows:

$$\begin{aligned} H_{(\mathbb{Z}_2^a \times \mathbb{Z}_2^b)^-} &\approx -\frac{1}{4} \sum_i [\mathbb{I}_i \mathbb{I}_{i+1} + X_i^{\text{II}} (X^{\text{II}} Z^{\text{III}})_{i+1}] \\ &- \frac{1}{4} \sum_i [\mathbb{I}_i \mathbb{I}_{i+1} + (Z^{\text{II}} X^{\text{III}})_i X_{i+1}^{\text{III}}] - \frac{1}{2} \sum_i [\mathbb{I} + Z^{\text{I}}]_i. \end{aligned} \quad (\text{A71})$$

We note that, although X^α anti-commutes with Z^α for fixed $\alpha \in \{\text{I}, \text{II}, \text{III}\}$, all the terms in square brackets commute with each other hence they can be minimized independently. Like for the previous case, the projector term is minimized for the group elements in $\mathbb{Z}_2^a \times \mathbb{Z}_2^b$, eq. (A64). A state |GS) minimizing the remaining terms must furthermore satisfy:

$$\begin{aligned} X_i^{\text{II}} (X^{\text{II}} Z^{\text{III}})_{i+1} |\text{GS}\rangle &= |\text{GS}\rangle, \quad \forall i \in \{1, \dots, L\}, \\ (Z^{\text{II}} X^{\text{III}})_i X_{i+1}^{\text{III}} |\text{GS}\rangle &= |\text{GS}\rangle, \quad \forall i \in \{1, \dots, L\}. \end{aligned} \quad (\text{A72})$$

The ground state is unique because the above are $2L$ independent equations for the $2L$ dimensional Hilbert space of bits II and III on each lattice site (bit I is already fixed to 0). Furthermore, by taking the product over lattice sites i of the constraints (A72), one has:

$$\prod_i Z_i^{\text{III}} |\text{GS}\rangle = \prod_i Z_i^{\text{II}} |\text{GS}\rangle = |\text{GS}\rangle, \quad (\text{A73})$$

which implies that the holonomy of the ground state must be 1. Since the terms in the Hamiltonian mutually commute, we can write the ground state as:

$$|\text{GS}\rangle = \prod_i \frac{1}{\sqrt{2}} [\mathbb{I}_i \mathbb{I}_{i+1} + (Z^{\text{II}} X^{\text{III}})_i X_{i+1}^{\text{III}}] \bigotimes_i |0, +, 0\rangle_i. \quad (\text{A74})$$

where $|0, +, 0\rangle \equiv \frac{|000\rangle + |010\rangle}{\sqrt{2}}$ is a state that satisfies the first condition in (A72), whereas the second condition holds thanks to the operator acting on $|0, +, 0\rangle$.

We can write the symmetry generators \mathcal{S}_Γ , for $\Gamma \in \text{Rep}(D_8)$, on the $\mathbb{Z}_2^a \times \mathbb{Z}_2^b$ subspace as follows:

$$\begin{aligned} \mathcal{S}_1 &= \mathcal{S}_{1_a} |_{\mathbb{Z}_2^a \times \mathbb{Z}_2^b} = \prod_{i=1}^L \mathbb{I}_i \\ \mathcal{S}_{1_c} &= \mathcal{S}_{1_{ca}} |_{\mathbb{Z}_2^a \times \mathbb{Z}_2^b} = \prod_{i=1}^L (Z_i^{\text{II}} Z_i^{\text{III}}) \\ \mathcal{S}_E &|_{\mathbb{Z}_2^a \times \mathbb{Z}_2^b} = \prod_{i=1}^L Z_i^{\text{II}} + \prod_{i=1}^L Z_i^{\text{III}}. \end{aligned} \quad (\text{A75})$$

Recalling eq. (A73), we therefore see that:

$$\mathcal{S}_\Gamma |\text{GS}\rangle = \dim(\Gamma) |\text{GS}\rangle, \quad (\text{A76})$$

and this is a non-trivial $\text{Rep}(D_8)$ SPT phase.

String order parameter. The SPT phase, cannot be diagnosed by genuine local order parameters. Instead

we either require twisted sector operators or string order parameters that are essentially the product of two twisted sector operators separated by a finite (and typically large) distance. The twisted sector operators map between ground states in different twisted sectors. In the present work, for simplicity we restrict ourselves to untwisted sector ground states, which can be straightforwardly extended to twisted sectors using the approach in [28]. We may however detect the SPT using string order parameters [92, 93]. These are

$$\begin{aligned} \mathcal{Q}_{([1], 1_a)}^{(i_0, i_0+N)} &= \prod_{i=i_0}^{i_0+N} Z_i^{\text{I}}, \\ \mathcal{Q}_{([ab], 1_c)}^{(i_0, i_0+N)} &= \prod_{i=i_0}^{i_0+N} (X^{\text{II}} X^{\text{III}})_{i_0} (Z_i^{\text{II}} Z_i^{\text{III}}) (X^{\text{II}} X^{\text{III}})_{i_0+N}, \end{aligned} \quad (\text{A77})$$

which correspond to the condensed charges $([1], 1_a)$ and $([ab], 1_c)$. Both these have a unit expectation value on the fixed-point SPT ground state.

f. \mathbb{Z}_2 SSB phase for $F = \mathbb{Z}_2^c$

Setting $F = \mathbb{Z}_2^c$ in eq. (A22) the Hamiltonian is:

$$\begin{aligned} H_{\mathbb{Z}_2^c} &= -\frac{1}{2} \sum_i (\mathbb{I} + R_i^c L_{i+1}^c) - \sum_i P_{i+1}^{(\mathbb{Z}_2^c)} = \\ &\approx -\frac{1}{2} \sum_i (\mathbb{I}_i \mathbb{I}_{i+1} + X_i^{\text{I}} X_{i+1}^{\text{I}}) \\ &- \frac{1}{4} \sum_i [(\mathbb{I} + Z^{\text{II}})(\mathbb{I} + Z^{\text{III}})]_i. \end{aligned} \quad (\text{A78})$$

The second term projects onto $\mathbb{Z}_2^c = \{|000\rangle = |1\rangle, |100\rangle = |c\rangle\}$ on each site i ; the first term (which we simplified by restricting it to this subspace) is minimized by the X^{I} eigenstates, there are therefore 2 linearly independent ground states:

$$\begin{aligned} |\text{GS}, +\rangle &= \bigotimes_i \left(\frac{|000\rangle + |100\rangle}{\sqrt{2}} \right)_i = \bigotimes_i \left(\frac{|1\rangle + |c\rangle}{\sqrt{2}} \right)_i \\ &\equiv |\Psi_1\rangle + |\Psi_c\rangle, \\ |\text{GS}, -\rangle &= \bigotimes_i \left(\frac{|000\rangle - |100\rangle}{\sqrt{2}} \right)_i = \bigotimes_i \left(\frac{|1\rangle - |c\rangle}{\sqrt{2}} \right)_i \\ &\equiv |\Psi_1\rangle - |\Psi_c\rangle. \end{aligned} \quad (\text{A79})$$

The action of the $\text{Rep}(D_8)$ generators on the ground states (A79) is:

$$\begin{aligned} \mathcal{S}_1 |\text{GS}, \pm\rangle &= \mathcal{S}_{1_c} |\text{GS}, \pm\rangle = |\text{GS}, \pm\rangle, \\ \mathcal{S}_{1_a} |\text{GS}, \pm\rangle &= \mathcal{S}_{1_{ca}} |\text{GS}, \pm\rangle = |\text{GS}, \mp\rangle, \\ \mathcal{S}_E |\text{GS}, \pm\rangle &= |\text{GS}, +\rangle + |\text{GS}, -\rangle. \end{aligned} \quad (\text{A80})$$

The operators exchanging the ground states are \mathcal{S}_{1_a} and $\mathcal{S}_{1_{ca}}$: this is therefore a \mathbb{Z}_2 SSB phase for $\text{Rep}(D_8)$, very

similar to the one discussed in section A 6 b (if we exchange a and c). Also in this phase \mathcal{S}_E sends each ground state to the sum of both, which is a hallmark of non-invertible symmetries.

The local order parameter for this phase is $\mathbf{Q}_{[c],1_{++}}$, given by the operator X_i^I :

$$\langle \text{GS}, + | X_i^I | \text{GS}, + \rangle = +1, \quad \langle \text{GS}, - | X_i^I | \text{GS}, - \rangle = -1. \quad (\text{A81})$$

g. $\mathbb{Z}_2 \times \mathbb{Z}_2$ SSB phase for $(F)^\beta = (\mathbb{Z}_2^c \times \mathbb{Z}_2^{ab})^+$

By choosing $F = \mathbb{Z}_2^c \times \mathbb{Z}_2^{ab}$ and trivial β in eq. (A22), we obtain the following effective Hamiltonian:[94]

$$\begin{aligned} H_{(\mathbb{Z}_2^c \times \mathbb{Z}_2^{ab})^+} &\approx -\frac{1}{4} \sum_i (\mathbb{I}_i \mathbb{I}_{i+1} + R_i^c L_{i+1}^c) \\ &- \frac{1}{4} \sum_i (\mathbb{I}_i \mathbb{I}_{i+1} + R_i^{ab} R_{i+1}^{ab}) - \sum_i P_i^{(\mathbb{Z}_2^c \times \mathbb{Z}_2^{ab})} \\ &\approx -\frac{1}{4} \sum_i [\mathbb{I}_i \mathbb{I}_{i+1} + X_i^I X_{i+1}^I] \\ &- \frac{1}{4} \sum_i [\mathbb{I}_i \mathbb{I}_{i+1} + (X^{\text{II}} X^{\text{III}})_i (X^{\text{II}} X^{\text{III}})_{i+1}] \\ &- \frac{1}{2} \sum_i [\mathbb{I} + Z^{\text{II}} Z^{\text{III}}]_i. \end{aligned} \quad (\text{A82})$$

The projector term is minimized, on each site i , by the states corresponding to the elements in

$$\begin{aligned} \mathbb{Z}_2^c \times \mathbb{Z}_2^{ab} \\ = \{|000\rangle = |1\rangle, |100\rangle = |c\rangle, |011\rangle = |ab\rangle, |111\rangle = |cab\rangle\}. \end{aligned} \quad (\text{A83})$$

The remaining terms are minimized by the X^I and $X^{\text{II}} X^{\text{III}}$ eigenstates independently, giving rise to 4 linearly independent ground states:

$$\begin{aligned} |\text{GS}, ++\rangle &= \bigotimes_i \left(\frac{|1\rangle + |c\rangle + |cab\rangle + |ab\rangle}{2} \right)_i \\ &\equiv |\Psi_1\rangle + |\Psi_c\rangle + |\Psi_{cab}\rangle + |\Psi_{ab}\rangle, \\ |\text{GS}, +- \rangle &= \bigotimes_i \left(\frac{|1\rangle + |c\rangle - |cab\rangle - |ab\rangle}{2} \right)_i \\ &\equiv |\Psi_1\rangle + |\Psi_c\rangle - |\Psi_{cab}\rangle - |\Psi_{ab}\rangle, \\ |\text{GS}, -+ \rangle &= \bigotimes_i \left(\frac{|1\rangle - |c\rangle + |cab\rangle - |ab\rangle}{2} \right)_i \\ &\equiv |\Psi_1\rangle - |\Psi_c\rangle + |\Psi_{cab}\rangle - |\Psi_{ab}\rangle, \\ |\text{GS}, -- \rangle &= \bigotimes_i \left(\frac{|1\rangle - |c\rangle - |cab\rangle + |ab\rangle}{2} \right)_i \\ &\equiv |\Psi_1\rangle - |\Psi_c\rangle - |\Psi_{cab}\rangle + |\Psi_{ab}\rangle. \end{aligned} \quad (\text{A84})$$

The action of $\text{Rep}(D_8)$ generators on the ground states is

$$\begin{aligned} \mathcal{S}_1 |\text{GS}, s, s'\rangle &= \mathcal{S}_{1_c} |\text{GS}, s, s'\rangle = |\text{GS}, s, s'\rangle \\ \mathcal{S}_{1_a} |\text{GS}, s, s'\rangle &= \mathcal{S}_{1_{ca}} |\text{GS}, s, s'\rangle = |\text{GS}, -s, -s'\rangle \\ \mathcal{S}_E |\text{GS}, ++\rangle &= \mathcal{S}_E |\text{GS}, --\rangle = |\text{GS}, +- \rangle + |\text{GS}, -+ \rangle \\ \mathcal{S}_E |\text{GS}, +- \rangle &= \mathcal{S}_E |\text{GS}, -+ \rangle = |\text{GS}, ++\rangle + |\text{GS}, --\rangle. \end{aligned} \quad (\text{A85})$$

The 4 ground states form 2 different \mathbb{Z}_2 orbits under the broken generators \mathcal{S}_{1_a} and $\mathcal{S}_{1_{ca}}$:

$$\mathcal{S}_{1_a}, \mathcal{S}_{1_{ca}} : \begin{aligned} &|\text{GS}, ++\rangle \leftrightarrow |\text{GS}, --\rangle \\ &|\text{GS}, +- \rangle \leftrightarrow |\text{GS}, -+ \rangle, \end{aligned} \quad (\text{A86})$$

this is therefore a $\mathbb{Z}_2 \times \mathbb{Z}_2$ SSB phase for $\text{Rep}(D_8)$ symmetry. We note that this phase is similar to the $\mathbb{Z}_2 \times \mathbb{Z}_2$ SSB phase discussed in section A 6 d. The local order parameters are the operators $\mathbf{Q}_{[ab],1}$ and $2\mathbf{Q}_{[c],1_{++}}$. In the lattice they are realized by X_i^I , $(X^{\text{I}} X^{\text{II}} X^{\text{III}})_i$, $(X^{\text{II}} X^{\text{III}})_i$, which have the following eigenvalues in the ground states:

$$\begin{aligned} \langle \text{GS}, s, s' | X_i^I | \text{GS}, s, s' \rangle &= s, \\ \langle \text{GS}, s, s' | (X^{\text{I}} X^{\text{II}} X^{\text{III}})_i | \text{GS}, s, s' \rangle &= s', \\ \langle \text{GS}, s, s' | (X^{\text{II}} X^{\text{III}})_i | \text{GS}, s, s' \rangle &= ss'. \end{aligned} \quad (\text{A87})$$

h. Non-trivial SPT phase for $(F)^\beta = (\mathbb{Z}_2^c \times \mathbb{Z}_2^{ab})^-$

We now consider the same subgroup $F = \mathbb{Z}_2^c \times \mathbb{Z}_2^{ab}$ as the previous case, but now with the non-identity

$$\beta \in H^2(\mathbb{Z}_2^c \times \mathbb{Z}_2^{ab}, U(1)) = \mathbb{Z}_2, \quad (\text{A88})$$

for whom we chose a representative given by equation (A70). Similarly to the case discussed in section A 6 e, the non-trivial β implies that we modify the Hamiltonian (A82), by introducing Z^{II} , Z^{I} as follows:

$$\begin{aligned} H_{(\mathbb{Z}_2^c \times \mathbb{Z}_2^{ab})^-} &\approx -\frac{1}{4} \sum_i [\mathbb{I}_i \mathbb{I}_{i+1} + X_i^I (X^{\text{I}} Z^{\text{II}})_{i+1}] \\ &- \frac{1}{4} \sum_i [\mathbb{I}_i \mathbb{I}_{i+1} + (Z^{\text{I}} X^{\text{II}} X^{\text{III}})_i (X^{\text{II}} X^{\text{III}})_{i+1}] \\ &- \frac{1}{2} \sum_i [\mathbb{I} + Z^{\text{II}} Z^{\text{III}}]_i. \end{aligned} \quad (\text{A89})$$

Like for the previous case, the projector term is minimized for the group elements in $\mathbb{Z}_2^c \times \mathbb{Z}_2^{ab}$, eq. (A83). A state $|\text{GS}\rangle$ minimizing the remaining terms must furthermore satisfy:

$$\begin{aligned} X_i^I (X^{\text{I}} Z^{\text{II}})_{i+1} |\text{GS}\rangle &= |\text{GS}\rangle, \quad \forall i = 1, \dots, L \\ (Z^{\text{I}} X^{\text{II}} X^{\text{III}})_i (X^{\text{II}} X^{\text{III}})_{i+1} |\text{GS}\rangle &= |\text{GS}\rangle, \quad \forall i = 1, \dots, L. \end{aligned} \quad (\text{A90})$$

Similarly to the phase discussed in section A 6 e, the ground state is unique because the above are $2L$ independent equations for the $2L$ dimensional Hilbert space

of group elements (A83). Furthermore, by taking the product over lattice sites i of the constraints (A90), one has:

$$\prod_i Z_i^{\text{II}} |\text{GS}\rangle = \prod_i Z_i^{\text{I}} |\text{GS}\rangle = |\text{GS}\rangle, \quad (\text{A91})$$

which implies that the holonomy of the ground state must be 1. Since the terms in the Hamiltonian mutually commute, we can write the ground state as:

$$|\text{GS}\rangle = \prod_i \frac{1}{\sqrt{2}} [\mathbb{I}_i \mathbb{I}_{i+1} + X_i^{\text{I}} (X^{\text{I}} Z^{\text{II}})_{i+1}] \bigotimes_i |0, +\rangle_i, \quad (\text{A92})$$

where $|0, +\rangle \equiv \frac{|000\rangle + |011\rangle}{\sqrt{2}}$ is a state that satisfies the second condition in (A90), whereas the first condition holds thanks to the operator acting on $|0, +\rangle$.

We can write the symmetry generators \mathcal{S}_Γ , for $\Gamma \in \text{Rep}(D_8)$, on the $\mathbb{Z}_2^c \times \mathbb{Z}_2^{ab}$ subspace as follows:

$$\begin{aligned} \mathcal{S}_1 &= \mathcal{S}_{1_c} |_{\mathbb{Z}_2^c \times \mathbb{Z}_2^{ab}} = \prod_{i=1}^L \mathbb{I}_i \\ \mathcal{S}_{1_a} &= \mathcal{S}_{1_{ca}} |_{\mathbb{Z}_2^c \times \mathbb{Z}_2^{ab}} = \prod_{i=1}^L Z_i^{\text{I}} \\ \mathcal{S}_E |_{\mathbb{Z}_2^c \times \mathbb{Z}_2^{ab}} &= \prod_{i=1}^L Z_i^{\text{II}} + \prod_{i=1}^L (Z_i^{\text{I}} Z_i^{\text{II}}). \end{aligned} \quad (\text{A93})$$

Recalling eq. (A91), we therefore see that:

$$\mathcal{S}_\Gamma |\text{GS}\rangle = \dim(\Gamma) |\text{GS}\rangle, \quad (\text{A94})$$

and this is a non-trivial $\text{Rep}(D_8)$ SPT phase.

String order parameter. As for the SPT labeled by $(F)^\beta = (\mathbb{Z}_2^a \times \mathbb{Z}_2^b)^-$, this SPT can be detected by strong order parameters

$$\begin{aligned} \mathcal{Q}_{([1], 1_c)}^{(i_0, i_0+N)} &= \prod_{i=i_0}^{i_0+N} (Z^{\text{II}} Z^{\text{III}})_i, \\ \mathcal{Q}_{([ab], 1_a)}^{(i_0, i_0+N)} &= \prod_{i=i_0}^{i_0+N} (X^{\text{II}} X^{\text{III}})_{i_0} Z_i^{\text{I}} (X^{\text{II}} X^{\text{III}})_{i_0+N}, \end{aligned} \quad (\text{A95})$$

which correspond to the condensed charges $([1], 1_c)$ and $([ab], 1_a)$. Both these have a unit expectation value on the SPT ground state.

i. $\mathbb{Z}_2 \times \mathbb{Z}_2$ SSB phase for $F = \mathbb{Z}_4^{ca}$

Setting $F = \mathbb{Z}_4^{ca}$ in eq. (A22), the Hamiltonian is:

$$\begin{aligned} H_{\mathbb{Z}_4^{ca}} &= -\frac{1}{4} \sum_i (\mathbb{I}_i \mathbb{I}_{i+1} + R_i^{ab} L_{i+1}^{ab} + R_i^{cb} L_{i+1}^{ca} + R_i^{ca} L_{i+1}^{cb}) \\ &\quad - \sum_i P_i^{(\mathbb{Z}_4^{ca})}. \end{aligned} \quad (\text{A96})$$

The projector term is minimized, on each site i , by the states corresponding to the elements in

$$\begin{aligned} \mathbb{Z}_4^{ca} \\ = \{ |000\rangle = |1\rangle, |101\rangle = |ca\rangle, |011\rangle = |ab\rangle, |110\rangle = |cb\rangle \}. \end{aligned} \quad (\text{A97})$$

The remaining terms are then minimized by the following 4 linearly independent ground states:

$$\begin{aligned} |\text{GS}, 0\rangle &= \bigotimes_i \left(\frac{|1\rangle + |ca\rangle + |ab\rangle + |cb\rangle}{2} \right)_i \\ &\equiv |\Psi_1\rangle + |\Psi_{ca}\rangle + |\Psi_{ab}\rangle + |\Psi_{cb}\rangle, \\ |\text{GS}, 1\rangle &= \bigotimes_i \left(\frac{|1\rangle + \zeta_4 |ca\rangle - |ab\rangle - \zeta_4 |cb\rangle}{2} \right)_i \\ &\equiv |\Psi_1\rangle + \zeta_4 |\Psi_{ca}\rangle - |\Psi_{ab}\rangle - \zeta_4 |\Psi_{cb}\rangle, \\ |\text{GS}, 2\rangle &= \bigotimes_i \left(\frac{|1\rangle - |ca\rangle + |ab\rangle - |cb\rangle}{2} \right)_i \\ &\equiv |\Psi_1\rangle - |\Psi_{ca}\rangle + |\Psi_{ab}\rangle - |\Psi_{cb}\rangle, \\ |\text{GS}, 3\rangle &= \bigotimes_i \left(\frac{|1\rangle - \zeta_4 |ca\rangle - |ab\rangle + \zeta_4 |cb\rangle}{2} \right)_i \\ &\equiv |\Psi_1\rangle - \zeta_4 |\Psi_{ca}\rangle - |\Psi_{ab}\rangle + \zeta_4 |\Psi_{cb}\rangle, \end{aligned} \quad (\text{A98})$$

where $\zeta_4 = e^{\frac{2\pi i}{4}}$. The action of $\text{Rep}(D_8)$ on the ground states is for $p \in \mathbb{Z}_4$:

$$\begin{aligned} \mathcal{S}_1 |\text{GS}, p\rangle &= \mathcal{S}_{1_{ca}} |\text{GS}, p\rangle = |\text{GS}, p\rangle, \\ \mathcal{S}_{1_a} |\text{GS}, p\rangle &= \mathcal{S}_{1_c} |\text{GS}, p\rangle = |\text{GS}, p+2\rangle, \\ \mathcal{S}_E |\text{GS}, 0\rangle &= \mathcal{S}_E |\text{GS}, 2\rangle = |\text{GS}, 1\rangle + |\text{GS}, 3\rangle, \\ \mathcal{S}_E |\text{GS}, 1\rangle &= \mathcal{S}_E |\text{GS}, 3\rangle = |\text{GS}, 0\rangle + |\text{GS}, 2\rangle. \end{aligned} \quad (\text{A99})$$

The 4 vacua form 2 different \mathbb{Z}_2 orbits under the broken generators \mathcal{S}_{1_a} and \mathcal{S}_{1_c} :

$$\mathcal{S}_{1_a}, \mathcal{S}_{1_c} : |\text{GS}, 0\rangle \leftrightarrow |\text{GS}, 2\rangle, \quad |\text{GS}, 1\rangle \leftrightarrow |\text{GS}, 3\rangle, \quad (\text{A100})$$

this is therefore a $\mathbb{Z}_2 \times \mathbb{Z}_2$ SSB phase for $\text{Rep}(D_8)$ symmetry. The order parameters are $\mathcal{Q}_{[ab], 1}$, $2\mathcal{Q}_{[ca], 1}$ which are realized by the operators

$$\begin{aligned} L_i^{ca} &= (X^{\text{I}} X^{\text{III}} (\text{Swap})^{\text{II}, \text{III}})_i, \quad L_i^{ab} = (L^{ca})_i^2 = (X^{\text{II}} X^{\text{III}})_i \\ L_i^{cb} &= (L^{ca})_i^3 = (X^{\text{I}} X^{\text{II}} (\text{Swap})^{\text{II}, \text{III}})_i, \end{aligned} \quad (\text{A101})$$

which have the following eigenvalues in the ground states:

$$\langle \text{GS}, p | (L^{ca})_i^q | \text{GS}, p \rangle = (-\zeta_4)^{pq}, \quad \forall p, q, \in \{0, 1, 2, 3\}. \quad (\text{A102})$$

j. $\text{Rep}(D_8)$ SSB phase for $(F)^\beta = (D_8)^+$

Setting $F = D_8$ with trivial β in eq. (A22), the Hamiltonian is:

$$H_{(D_8)^+} = -\frac{1}{8} \sum_i \sum_{g \in D_8} R_i^{g^{-1}} L_{i+1}^g - P_i^{(D_8)}. \quad (\text{A103})$$

The space of ground states is spanned by terms with holonomy in the same conjugacy class, whose list can be found in eq. (A4)

$$|\Psi_{[h]}\rangle \equiv \frac{1}{\sqrt{8^L}} \sum_{\{\vec{g} \mid g \in [h]\}} |\vec{g}, g\rangle. \quad (\text{A104})$$

Collecting them according to $\text{Rep}(D_8)$ symmetry, they are:

$$\begin{aligned} |\text{GS}, 1\rangle &= |\Psi_{[1]}\rangle + |\Psi_{[ab]}\rangle + |\Psi_{[ca]}\rangle + |\Psi_{[c]}\rangle + |\Psi_{[a]}\rangle, \\ |\text{GS}, 2\rangle &= |\Psi_{[1]}\rangle + |\Psi_{[ab]}\rangle - |\Psi_{[ca]}\rangle + |\Psi_{[c]}\rangle - |\Psi_{[a]}\rangle, \\ |\text{GS}, 3\rangle &= |\Psi_{[1]}\rangle + |\Psi_{[ab]}\rangle - |\Psi_{[ca]}\rangle - |\Psi_{[c]}\rangle + |\Psi_{[a]}\rangle, \\ |\text{GS}, 4\rangle &= |\Psi_{[1]}\rangle + |\Psi_{[ab]}\rangle + |\Psi_{[ca]}\rangle - |\Psi_{[c]}\rangle - |\Psi_{[a]}\rangle, \\ |\text{GS}, 5\rangle &= 2|\Psi_{[1]}\rangle - 2|\Psi_{[ab]}\rangle. \end{aligned} \quad (\text{A105})$$

The action of $\text{Rep}(D_8)$ on the ground states is:

$$\begin{aligned} \mathcal{S}_{1_c} : & |\text{GS}, 1\rangle \leftrightarrow |\text{GS}, 2\rangle, \quad |\text{GS}, 3\rangle \leftrightarrow |\text{GS}, 4\rangle, \\ \mathcal{S}_{1_a} : & |\text{GS}, 1\rangle \leftrightarrow |\text{GS}, 3\rangle, \quad |\text{GS}, 2\rangle \leftrightarrow |\text{GS}, 4\rangle, \\ \mathcal{S}_{1_{ca}} : & |\text{GS}, 1\rangle \leftrightarrow |\text{GS}, 4\rangle, \quad |\text{GS}, 2\rangle \leftrightarrow |\text{GS}, 3\rangle, \\ \mathcal{S}_{1_k} : & |\text{GS}, 5\rangle = |\text{GS}, 5\rangle \quad \forall 1_k \in \{1_c, 1_a, 1_{ca}\}, \\ \mathcal{S}_E : & |\text{GS}, p\rangle = |\text{GS}, 5\rangle \quad \forall p \in \{1, 2, 3, 4\}, \\ \mathcal{S}_E : & |\text{GS}, 5\rangle = \sum_{p=1}^4 |\text{GS}, p\rangle, \end{aligned} \quad (\text{A106})$$

from which we see that $\text{Rep}(D_8)$ is fully spontaneously broken.

The order parameters are all the charges in $\mathfrak{B}^{\text{sym}} = \mathcal{A}_{33}$: we denote by $L^{[g]}$ the operators L^g for $g \in [g]$ and compute

$$\begin{aligned} \langle \text{GS}, p | L_i^{ab} | \text{GS}, p \rangle &= +1 \quad \forall p \in \{1, 2, 3, 4\} \\ \langle \text{GS}, 5 | L_i^{ab} | \text{GS}, 5 \rangle &= -1, \\ \langle \text{GS}, p | L_i^{[c]} | \text{GS}, p \rangle &= +1 \quad p \in \{1, 2\} \\ \langle \text{GS}, p | L_i^{[c]} | \text{GS}, p \rangle &= -1 \quad p \in \{3, 4\} \\ \langle \text{GS}, p | L_i^{[a]} | \text{GS}, p \rangle &= +1 \quad p \in \{1, 3\} \\ \langle \text{GS}, p | L_i^{[a]} | \text{GS}, p \rangle &= -1 \quad p \in \{2, 4\} \\ \langle \text{GS}, p | L_i^{[ca]} | \text{GS}, p \rangle &= +1 \quad p \in \{1, 4\} \\ \langle \text{GS}, p | L_i^{[ca]} | \text{GS}, p \rangle &= -1 \quad p \in \{2, 3\} \\ \langle \text{GS}, 5 | L_i^{[g]} | \text{GS}, 5 \rangle &= 0 \quad [g] \in \{[a], [c], [ca]\}. \end{aligned} \quad (\text{A107})$$

k. \mathbb{Z}_2 SSB phase for $F^\beta = D_8^-$

We now consider $F = D_8$ as the previous case, but now with the non-identity

$$\beta \in H^2(D_8, U(1)) = \mathbb{Z}_2. \quad (\text{A108})$$

As a representative of β , we choose:

$$\beta(c^{c_1} a^{a_1} b^{b_1}, c^{c_2} a^{a_2} b^{b_2}) = (-1)^{((1-c_2)a_1 + c_2 b_1)b_2 + a_1 b_1 c_2}. \quad (\text{A109})$$

The Hamiltonian for this gapped phase is:

$$H_{D_8^-} = -\frac{1}{8} \sum_i \sum_{g \in D_8} (R_\beta^{g^{-1}})_i (L_\beta^g)_{i+1} - \sum_i P_i^{(D_8)}. \quad (\text{A110})$$

Here we define

$$R_\beta^{f^{-1}} = Z_{(\beta, R)}^f R^{f^{-1}}, \quad L_\beta^f = L^f Z_{(\beta, L)}^f, \quad (\text{A111})$$

with the following non-trivial twists, which follow from (A109):

$$\begin{aligned} Z_{(\beta, L)}^a &= Z_{(\beta, L)}^{ca} = \frac{1}{2} [\mathbb{I} - Z^I + Z^{\text{III}} + Z^I Z^{\text{III}}], \\ Z_{(\beta, L)}^b &= Z_{(\beta, L)}^{cb} = \frac{1}{2} [\mathbb{I} + Z^I + Z^{\text{II}} - Z^I Z^{\text{II}}], \\ Z_{(\beta, L)}^{ab} &= Z_{(\beta, L)}^{cab} = \frac{1}{2} [-Z^{\text{II}} + Z^{\text{III}} + Z^I (Z^{\text{II}} + Z^{\text{III}})], \\ Z_{(\beta, R)}^{ab} &= Z_{(\beta, R)}^b = \frac{1}{2} [Z^{\text{II}} + Z^{\text{III}} + Z^I (Z^{\text{II}} - Z^{\text{III}})], \\ Z_{(\beta, R)}^c &= Z_{(\beta, R)}^{ca} = \frac{1}{2} [\mathbb{I} + Z^{\text{II}} + Z^{\text{III}} - Z^{\text{II}} Z^{\text{III}}], \\ Z_{(\beta, R)}^{cab} &= Z_{(\beta, R)}^{cb} = \frac{1}{2} [\mathbb{I} - Z^I (Z^{\text{II}} - Z^{\text{III}}) + Z^{\text{II}} Z^{\text{III}}]. \end{aligned} \quad (\text{A112})$$

One can diagonalize this Hamiltonian and determine that the ground state space is spanned by $\Psi_{[1]}^\beta$ and $\Psi_{[ca]}^\beta$ with holonomy respectively in the [1] and [ca] conjugacy class. We thus have:

$$\begin{aligned} |\text{GS}, +\rangle &\equiv \left| \Psi_{[1]}^\beta \right\rangle + \left| \Psi_{[ca]}^\beta \right\rangle, \\ |\text{GS}, -\rangle &\equiv \left| \Psi_{[1]}^\beta \right\rangle - \left| \Psi_{[ca]}^\beta \right\rangle. \end{aligned} \quad (\text{A113})$$

The action of the $\text{Rep}(D_8)$ generators (A19) on the ground states (A113) is:

$$\begin{aligned} \mathcal{S}_1 |\text{GS}, \pm\rangle &= \mathcal{S}_{1_{ca}} |\text{GS}, \pm\rangle = |\text{GS}, \pm\rangle, \\ \mathcal{S}_{1_c} |\text{GS}, \pm\rangle &= \mathcal{S}_{1_a} |\text{GS}, \pm\rangle = |\text{GS}, \mp\rangle, \\ \mathcal{S}_E |\text{GS}, \pm\rangle &= |\text{GS}, +\rangle + |\text{GS}, -\rangle. \end{aligned} \quad (\text{A114})$$

This is therefore a \mathbb{Z}_2 SSB phase for $\text{Rep}(D_8)$: the \mathbb{Z}_2 symmetries exchanging the two ground states are \mathcal{S}_{1_c} and \mathcal{S}_{1_a} . The local order parameter is:

$$\begin{aligned} \mathcal{Q}_{([ca], 1)}^\beta &\sim (\mathbb{I} + Z^{\text{III}} - Z^I Z^{\text{II}} (\mathbb{I} - Z^{\text{III}})) X^I X^{\text{II}} + \\ &+ (\mathbb{I} + Z^{\text{II}} + Z^I Z^{\text{III}} (\mathbb{I} - Z^{\text{II}})) X^I X^{\text{III}}, \end{aligned} \quad (\text{A115})$$

for which

$$\langle \text{GS}, \pm | \mathcal{Q}_{([ca], 1)}^\beta | \text{GS}, \pm \rangle = \pm 1. \quad (\text{A116})$$

7. $\text{Rep}(D_8)$ Phase Transitions

We can find lattice models for second-order phase transitions between the gapped phases discussed above. This can be done using the general approach of [28], which takes as an input a lattice model for a known phase transition, like the critical point of Ising model, and embeds it into a larger lattice model to produce the desired transition. These transformations can be viewed as generalized versions of Kennedy-Tasaki (KT) transformations [95, 96]. For $\text{Rep}(D_8)$ symmetry the critical models, that arise using this generalized KT method, as second order phase transitions between two gapped phases were determined in [10] (table IV, v3). These continuum predictions can be complemented by lattice models as shown in [28] taking the input from the SymTFT club sandwich construction. An alternative, less systematic way to see the phase transitions in the lattice models is to construct the Hamiltonian H describing the desired phase transition as

$$H = \lambda H_1 + (1 - \lambda) H_2 \quad (\text{A117})$$

for some $\lambda \in [0, 1]$ where H_1 and H_2 are the commuting projector Hamiltonians for the gapped phases lying on two sides of the phase transition.

Trivial to \mathbb{Z}_2 SSB Transition. The ansatz for the interpolating Hamiltonian is

$$H_{(1, \mathbb{Z}_2^a)}(\lambda) = \lambda H_1 + (1 - \lambda) H_{\mathbb{Z}_2^a}. \quad (\text{A118})$$

The low-energy physics is restricted to the \mathbb{Z}_2^a subspace, i.e. qubit II, on each site. We can thus write a simplified Hamiltonian, by restricting to \mathbb{Z}_2^a :

$$H_{(1, \mathbb{Z}_2^a)} \approx -\frac{1}{2} \sum_i [\lambda Z_i^{\text{II}} + (1 - \lambda) X_i^{\text{II}} X_{i+1}^{\text{II}}]. \quad (\text{A119})$$

Setting $\lambda = \frac{1}{2}$ we obtain the transverse-field critical Ising Hamiltonian, describing the phase transition corresponding to a gSPT phase. This type of analysis can be repeated for all gapped phases. We will consider a few more examples to illustrate this.

Trivial to $\text{Rep}(D_8)/\mathbb{Z}_2 \times \mathbb{Z}_2$ SSB Transition. Similarly taking the Hamiltonians H_1 and $H_{\mathbb{Z}_2^{ab}}$, there are common projectors $(1 + Z^{\text{I}})/2$ and we can project first onto the ground state of $-(1 + Z^{\text{II}})(1 + Z^{\text{III}})/4$ and then restrict $(1 + Z^{\text{II}} Z^{\text{III}})/2$ to that. The resulting Hamiltonian restricted to that subspace is

$$H_{(1, \mathbb{Z}_2^{ab})} \approx -\frac{1}{2} \sum_i \lambda (Z^{\text{II}} + Z^{\text{III}})_i + (1 - \lambda) X_i^{\text{II}} X_i^{\text{III}} X_{i+1}^{\text{II}} X_{i+1}^{\text{III}}. \quad (\text{A120})$$

This reduces again to the critical Ising model, for the diagonal combination \mathbb{Z}_2^{ab} .

Trivial to $\mathbb{Z}_2 \times \mathbb{Z}_2$ SSB Transition. Here we can restrict to the II and III qubit subspace only. The two XX terms from the $\mathbb{Z}_2 \times \mathbb{Z}_2$ SSB result in two Ising chains, giving an Ising \oplus Ising transition.

$\text{Rep}(D_8)/\mathbb{Z}_2 \times \mathbb{Z}_2$ SSB to $\mathbb{Z}_2 \times \mathbb{Z}_2$ SSB Transition. Similarly here we can restrict to the qubits II and III. Restricting the XX term of the $\text{Rep}(D_8)/\mathbb{Z}_2 \times \mathbb{Z}_2$ SSB to the eigenstates of the XX term in the $\mathbb{Z}_2 \times \mathbb{Z}_2$ SSB gives again two decoupled Ising chains, consistent with the Ising \oplus Ising gapless phase.

$\text{Rep}(D_8)/\mathbb{Z}_2 \times \mathbb{Z}_2$ SSB to SPT Transition. The phase transition between the SPT labeled as $(F)^\beta = (\mathbb{Z}_2^a \times \mathbb{Z}_2^b)^-$ and the $\text{Rep}(D_8)/\mathbb{Z}_2 \times \mathbb{Z}_2$ SSB labeled as $(F)^\beta = \mathbb{Z}_2^{ab}$ takes place in the projected subspace of $Z^{\text{I}} = 1$. In this restricted subspace

$$\mathcal{S}_E \Big|_{Z^{\text{I}}=1} = \mathcal{S}_{\text{II}} + \mathcal{S}_{\text{III}}, \quad (\text{A121})$$

and

$$\mathcal{S}_{1_a} = \mathbb{I}, \quad \mathcal{S}_{1_c} = \mathcal{S}_{1_{ca}} = \mathcal{S}_{\text{II}} \mathcal{S}_{\text{III}} \quad (\text{A122})$$

where

$$\mathcal{S}_\alpha = \prod_{i=1}^L (Z^\alpha)_i \quad \alpha \in \{\text{II}, \text{III}\}. \quad (\text{A123})$$

Therefore the effective symmetry in this subspace is $\mathbb{Z}_2^{\text{II}} \times \mathbb{Z}_2^{\text{III}}$ generated by \mathcal{S}_{II} and \mathcal{S}_{III} . $\text{Rep}(D_8)/\mathbb{Z}_2 \times \mathbb{Z}_2$ SSB in this restricted space realizes the $\mathbb{Z}_2^{\text{II}} \times \mathbb{Z}_2^{\text{III}} \rightarrow \mathbb{Z}_2^{\text{diag}}$ SSB phase, while the SPT is indeed the $\mathbb{Z}_2^{\text{II}} \times \mathbb{Z}_2^{\text{III}}$ SPT. The transition takes place at $\lambda = 1/2$ along the following line in parameter space

$$\tilde{H}(\lambda) = \frac{1}{2} \tilde{H}_{\text{SPT}} + (1 - \lambda) \tilde{H}_{\text{Rep}(D_8)/\mathbb{Z}_2^2}, \quad (\text{A124})$$

where \tilde{H} denotes the restriction of H to the $Z^{\text{I}} = 1$ space. In this space, the Hamiltonians have the form

$$\begin{aligned} \tilde{H}_{\text{SPT}} &= -\frac{1}{4} \sum_i [\mathbb{I}_i \mathbb{I}_{i+1} + X_i^{\text{II}} (X^{\text{II}} Z^{\text{III}})_{i+1}] \\ &\quad \times [\mathbb{I}_i \mathbb{I}_{i+1} + (Z^{\text{II}} X^{\text{III}})_i X_{i+1}^{\text{III}}], \\ \tilde{H}_{\text{Rep}(D_8)/\mathbb{Z}_2^2} &= -\frac{1}{4} \sum_i [\mathbb{I}_i \mathbb{I}_{i+1} + (X^{\text{II}} X^{\text{III}})_i (X^{\text{II}} X^{\text{III}})_{i+1}] \\ &\quad \times [\mathbb{I}_i \mathbb{I}_{i+1} + Z_i^{\text{II}} Z_i^{\text{III}}], \end{aligned} \quad (\text{A125})$$

We claim that the transition at $\lambda = 1/2$ in (A124) lies in the Ising universality class. To see this, we will map the transition to a more familiar form in two steps. In the first step we define a unitary that has the following action on the operators generating the $\mathbb{Z}_2^{\text{II}} \times \mathbb{Z}_2^{\text{III}}$ bond algebra [97]

$$U_1 : \begin{pmatrix} Z_j^{\text{II}} \\ Z_j^{\text{III}} \\ X_j^{\text{II}} X_{j+1}^{\text{II}} \\ X_j^{\text{III}} X_{j+1}^{\text{III}} \end{pmatrix} \mapsto \begin{pmatrix} Z_j^{\text{II}} \\ (Z^{\text{II}} Z^{\text{III}})_j \\ (X^{\text{II}} X^{\text{III}})_j (X^{\text{II}} X^{\text{III}})_{j+1} \\ X_j^{\text{III}} X_{j+1}^{\text{III}} \end{pmatrix} \quad (\text{A126})$$

This transition implements an automorphism of $\mathbb{Z}_2^{\text{II}} \times \mathbb{Z}_2^{\text{III}}$ symmetry. It can be easily seen that this unitary preserves the bond algebra. This unitary maps leaves the SPT Hamiltonian unchanged while it transforms the $\text{Rep}(D_8)/\mathbb{Z}_2^2$ Hamiltonian into

$$-\frac{1}{4} \sum_i [1 + X_i^{\text{II}} X_{i+1}^{\text{II}}] \times [1 + Z_i^{\text{III}}], \quad (\text{A127})$$

which realizes the phase $\mathbb{Z}_2^{\text{II}} \times \mathbb{Z}_2^{\text{III}} \rightarrow \mathbb{Z}_2^{\text{III}}$ SSB. Then in the second step, we implement a (SPT entangler) unitary that realizes the following map on the bond algebra

$$U_2 : \begin{pmatrix} Z_j^{\text{II}} \\ Z_j^{\text{III}} \\ X_j^{\text{II}} X_{j+1}^{\text{II}} \\ X_j^{\text{III}} X_{j+1}^{\text{III}} \end{pmatrix} \mapsto \begin{pmatrix} (Z_j^{\text{II}} X_{j+1}^{\text{III}}) X_{j+1}^{\text{II}} \\ X_{j-1}^{\text{II}} (X_j^{\text{II}} Z_j^{\text{III}}) \\ X_j^{\text{II}} X_{j+1}^{\text{II}} \\ X_j^{\text{III}} X_{j+1}^{\text{III}} \end{pmatrix} \quad (\text{A128})$$

This unitary leaves the partial symmetry breaking Hamiltonian (A127) unaltered but maps the SPT Hamiltonian to

$$-\frac{1}{4} \sum_i [1 + Z_i^{\text{II}}] \times [1 + Z_i^{\text{III}}], \quad (\text{A129})$$

which realizes the $\mathbb{Z}_2^{\text{II}} \times \mathbb{Z}_2^{\text{III}}$ disordered phase. Clearly the transition between (A127) and (A129) lies in the Ising universality class. Since these transformations were unitary, they preserve the spectrum and (A124) too lies in the Ising universality class wherein the \mathbb{Z}_2^{II} symmetry is broken. Although the two unitaries have the effect of performing an automorphism on the group $\mathbb{Z}_2^{\text{II}} \times \mathbb{Z}_2^{\text{III}}$ and subsequently pasting an SPT which modifies the charges of the various twisted sectors without affecting the untwisted sectors. In terms of the SymTFT, both these unitaries can be thought of as descending from braided autoequivalences of the SymTFT (which is the doubled Toric Code with lines generated by $e^{\text{II}}, m^{\text{II}}, e^{\text{III}}, m^{\text{III}}$) that leaves the symmetry boundary (which is the e^{II} and e^{III} condensed boundary). These unitaries implement

$$\begin{aligned} U_1 : \{e^{\text{II}}, m^{\text{II}}, e^{\text{III}}, m^{\text{III}}\} &\mapsto \{e^{\text{II}} e^{\text{III}}, m^{\text{II}}, e^{\text{III}}, m^{\text{II}} m^{\text{III}}\} \\ U_2 : \{e^{\text{II}}, m^{\text{II}}, e^{\text{III}}, m^{\text{III}}\} &\mapsto \{e^{\text{II}}, m^{\text{II}} e^{\text{III}}, e^{\text{III}}, m^{\text{III}} e^{\text{II}}\} \end{aligned} \quad (\text{A130})$$

See [15] for more details on how the twisted sectors map.

Appendix B: Elementary quantum gates in a Rydberg quantum simulator

With the atom-array setup illustrated in the main text, the unitary evolution governed by arbitrary combinations of the Hamiltonians $\{H_1, H_{\mathbb{Z}_2^a}, H_{\mathbb{Z}_2^b}, H_{(\mathbb{Z}_2^a \times \mathbb{Z}_2^b)^\pm}\}$ can be realized via Trotterization by four types of elementary quantum gates. Here, we describe in detail the physical implementation of these elementary gates. The corresponding pulse sequence is illustrated in Fig. 2(a).

First, we note that single-qubit rotations $R_{\mathcal{N}}(\phi) = \exp(-i\phi\mathcal{N}/2)$ along different axes $\mathcal{N} = X, Y, Z$ can be straightforwardly realized. The rotation along the x - and the y -axis can be achieved by a two-photon Raman transition between qubit states, i.e., $(\Omega|0\rangle\langle 1| + \text{H.c.})/2$ with $\phi = |\Omega|t$. The rotation along the z -axis can be realized by off-resonantly coupling states $|0\rangle, |1\rangle$ to an intermediate state $|e\rangle$ to acquire an additional light shift $\Delta_{\text{LS}}Z$ with $\phi = \Delta_{\text{LS}}t$. These single-qubit operations are carried out in the ground-state manifold and can thus be executed in a fast and accurate manner, making them efficient building blocks in the multiqubit gate sequence.

(i) *Single-qubit phase gate.*—The single-qubit phase gate $U_{\text{P}}(\phi) = e^{-i\phi Q}$ is equivalent to the single-qubit rotation $R_Z(\phi) = \exp(-iZ\phi/2)$ up to a global phase factor since $Q = |0\rangle\langle 0| = (\mathbb{I} + Z)/2$.

(ii) *Two-qubit controlled phase gate.*—The controlled phase gate $U_{\text{CP}}(\phi) = e^{-i\phi Q_1 Q_2}$ between qubits 1 and 2 can be achieved by a modified version of the gate discussed in Ref. [50], which only requires global addressing of two atoms. Specifically, we consider two atoms within the blockade radius, described by

$$\begin{aligned} H_{\text{Ryd}} = \frac{\Omega_r}{2} [(\mathbb{I} - \sigma_1^{rr})(e^{i\xi}\sigma_2^{0r} + \text{H.c.}) + \\ + (e^{i\xi}\sigma_1^{0r} + \text{H.c.})(\mathbb{I} - \sigma_2^{rr})] - \Delta_r(\sigma_0^{rr} + \sigma_1^{rr}), \end{aligned} \quad (\text{B1})$$

where $\sigma_i^{\alpha\beta} = |\alpha\rangle\langle\beta|_i$. The basis state $|11\rangle$ is invariant under H_{Ryd} , while states $|01\rangle$ and $|10\rangle$ execute Rabi oscillations at frequency Ω . The Rydberg blockade will affect the state $|00\rangle$, which executes a collective Rabi oscillation at an enhanced frequency $\sqrt{2}\Omega$. To ensure that all basis states return to the ground-state manifold, a sudden phase jump $\xi \neq 0$ is applied at time $t_1 = 2\pi/\sqrt{2\Omega_r^2 + \Delta^2}$, when the collective Rabi oscillation

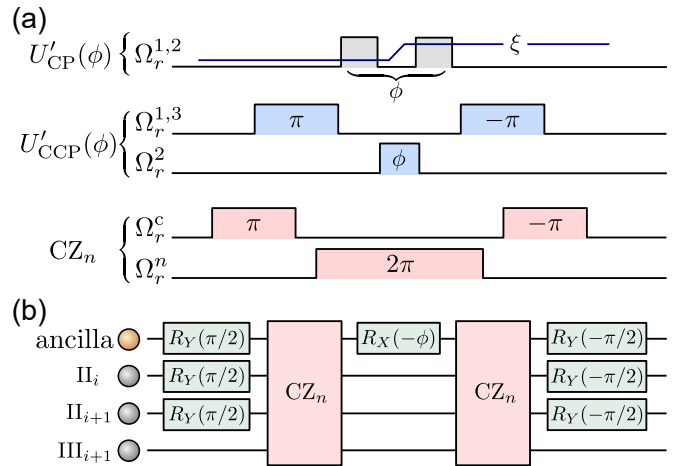

Figure 2. (a) Rydberg pulse sequence for the elementary quantum gates. (b) Gate sequence for simulating the three-body plaquette evolution $U_{\square}(\phi) = \exp(-i\phi X_i^{\text{II}} X_{i+1}^{\text{II}} Z_{i+1}^{\text{III}})$.

experiences a cycle. A careful choice of ξ will make the single-particle Rabi oscillation follow a symmetric trajectory on the Bloch sphere, i.e., $|00\rangle$ also returns to the initial state at time $t = 2t_1$. The full action is then described by $U'_{\text{CP}}(\phi) = \exp[i\theta(Q_1 + Q_2) - i\phi Q_1 Q_2]$, which, after single-qubit rotations $R_{Z_2}(\theta)R_{Z_1}(\theta)U'_{\text{CP}}(\phi)$ is equivalent to the standard form $U_{\text{CP}}(\phi)$ up to a global phase factor. The strength ϕ is adjustable by tuning the ratio Ω_r/Δ_r . Different from the original gate design of Ref. [50], here we only need a small Trotter step $\phi \ll \pi$, which further reduces the time consumption of the gate operation.

(iii) *Three-qubit controlled phase gate.*—To realize the controlled phase gate $U_{\text{CCP}}(\phi) = e^{-i\phi Q_1 Q_2 Q_3}$ between qubits 1, 2, and 3, we consider a chain of three atoms, where only nearest-neighbor atoms are within the blockade radius. Then, one performs the sequential operation: (a) Apply a Rydberg π pulse to the edge atoms 1 and 3, transferring $|0\rangle$ to $|r\rangle$; (b) Off-resonantly driving the central atom 2, which experiences a detuned Rabi cycle and acquires a phase ϕ ; (c) Apply a Rydberg $-\pi$ pulse to the edge atoms, transferring the Rydberg population back to $|0\rangle$. Such a sequence realizes an operation $U'_{\text{CCP}}(\phi) = \exp[-i\phi(\mathbb{I} - Q_1)Q_2(\mathbb{I} - Q_3)]$, because the phase accumulation is possible only when both edge atoms are in the state $|1\rangle$. The operation can be conveniently transformed to $U_{\text{CCP}}(\phi) = R_{X_3}(\pi)R_{X_1}(\pi)U'_{\text{CCP}}(\phi)R_{X_1}(\pi)R_{X_3}(\pi)$ by single-qubit rotations.

Noting that the on-site projector P_i in the Hamiltonian $\{H_1, H_{Z_2^a}, H_{Z_2^{ab}}, H_{(Z_2^a \times Z_2^b)_\pm}\}$ takes a general form $P_i = aQ_i^I + Q_i^I(bQ_i^{II} + cQ_i^{III}) + dQ_i^I Q_i^{II} Q_i^{III}$, the elementary gates (i-iii) are complete for implementing all possible on-site unitary evolutions.

(iv) *Multi-qubit controlled-Z gate.*—For a system containing n data qubits and one ancillary qubit, the multi-qubit gate operation of interest is

$$\text{CZ}_n = |0\rangle\langle 0|_c \otimes \mathbb{I} + (-1)^n |1\rangle\langle 1|_c \otimes \prod_{i=1}^n Z_i. \quad (\text{B2})$$

Such an operation can be easily accomplished under the scenario where the data qubits do not interact with each other but can only be blockaded by the ancillary qubit, e.g., the dual-species plaquette configuration considered in the main text. Specifically, CZ_n is realized by the sequence: (a) Apply a Rydberg π pulse on the ancillary atom, transferring $|0\rangle_c$ to $|r\rangle_c$; (b) Apply a 2π pulse simultaneously on all data atoms, letting $|0\rangle_i$ do a complete Rabi cycle; (c) Apply a Rydberg $-\pi$ pulse on the ancillary atom, transferring $|r\rangle_c$ back to $|0\rangle_c$.

The multi-qubit gate (iv) can be used to compose the unitary evolution caused by multi-body interactions between data qubits. For example, the unitary operation $U_n^Z(\phi) = \exp(-i\phi \prod_{i=1}^n Z_i)$ can be realized by $R_{Y_c}(-\pi/2)(\text{CZ}_n)R_{X_c}[(-1)^n 2\phi](\text{CZ}_n)R_{Y_c}(\pi/2)$ with the ancillary qubit prepared in $|0\rangle_c$. To understand such a decomposition (e.g., $n = 4$), one can image the action on an initial state $|\psi_0\rangle = (c_+|+\rangle + c_-|-\rangle)$, where $|\pm\rangle$ denotes the eigenstate of the multi-body interaction $B = \prod_{i=1}^4 Z_i$, i.e., $B|\pm\rangle = \pm|\pm\rangle$. Then, the first rotation $R_{Y_c}(\pi/2)$ transforms $|\psi_0\rangle \otimes |0\rangle_c$ into $(c_+|+\rangle + c_-|-\rangle) \otimes (|0\rangle_c + |1\rangle_c)$, which under the action of CZ_n becomes $c_+|+\rangle \otimes (|0\rangle_c + |1\rangle_c) + c_-|-\rangle \otimes (|0\rangle_c - |1\rangle_c)$. Since $(|0\rangle_c \pm |1\rangle_c)$ are eigenstates of X_c , the rotation $R_{X_c}(\phi)$ will make $|\pm\rangle$ pick up a phase $e^{\mp i\phi}$, respectively. The rest of the operation will transform the control qubit back to $|0\rangle_c$, while the data qubits evolve into $c_+e^{i\phi}|+\rangle + c_-e^{-i\phi}|-\rangle = U_4^Z(\phi)|\psi_0\rangle$. The fact that all Pauli operators are transformable in terms of single-qubit rotations, e.g., $X = R_Y(-\pi/2)ZR_Y(\pi/2)$, implies that arbitrary $U_n(\phi) = \exp(-i\phi \prod_{i=1}^n \mathcal{O}_i)$ ($\mathcal{O}_i = X_i, Y_i, Z_i$) can be achieved. For the array configuration considered in the main text, the above discussed gate manifests as a plaquette evolution $U_{\square}(\phi) = \exp(-i\phi \mathcal{O}_i^{II} \mathcal{O}_{i+1}^{II} \mathcal{O}_{i+1}^{III} \mathcal{O}_i^{III})$ with $\mathcal{O}_j^\alpha \in \{\mathbb{I}, X, Y, Z\}_j^\alpha$, which implements each multi-body evolution term in the inter-site evolution $e^{-iH_{i,i+1}\tau}$, e.g., $U_{\square}(\phi) = \exp(-i\phi X_i^{II} X_{i+1}^{II} Z_{i+1}^{III})$ required for the SPT phase [see Fig. 2(b)].