

THE PAINLEVÉ EQUIVALENCE PROBLEM FOR A CONSTRAINED 3D SYSTEM

GALINA FILIPUK¹, MICHELE GRAFFEO², GIORGIO GUBBIOTTI³, AND ALEXANDER STOKES^{1,4}

ABSTRACT. In this paper we propose a geometric approach to study Painlevé equations appearing as constrained systems of three first-order ordinary differential equations. We illustrate this approach on a system of three first-order differential equations arising in the theory of semi-classical orthogonal polynomials. We show that it can be restricted to a system of two first-order differential equations in two different ways on an invariant hypersurface. We build the space of initial conditions for each of these restricted systems and verify that they exhibit the Painlevé property from a geometric perspective. Utilising the Painlevé identification algorithm we also relate this system to the Painlevé VI equation and we build its global Hamiltonian structure. Finally, we prove that the autonomous limit of the original system is Liouville integrable, and the level curves of its first integrals are elliptic curves, which leads us to conjecture that the 3D system itself also possesses the Painlevé property without the need to restrict it to the invariant hypersurface.

CONTENTS

1. Introduction	2
2. Background material	5
3. The system on the hypersurface in the first parametrisation	16
4. The system on the hypersurface in the second parametrisation	20
5. Hamiltonian structure of the 3D system on the hypersurface	26
6. An autonomous limit of the system of three first-order differential equations	34
7. Conclusions	39
Appendix A. Standard realisation of the space of initial conditions for the sixth Painlevé equation	42
Appendix B. Relation of the 3D system with the σ -form of the P_{VI} equation	44
Appendix C. An apparent singularity of the system in the second parametrisation with $\mathbb{P}^1 \times \mathbb{P}^1$ compactification	46
Appendix D. Additional autonomous limits for the 3D system	47

¹INSTITUTE OF MATHEMATICS, UNIVERSITY OF WARSAW, UL. BANACHA 2, 02-097, WARSAW, POLAND. ORCID: 0000-0003-2623-5361. (CORRESPONDING AUTHOR)

²SCUOLA INTERNAZIONALE STUDI SUPERIORI AVANZATI, VIA BONOMEA, 265, 34136 TRIESTE. ORCID: 000-0002-7973-6023.

³DIPARTIMENTO DI MATEMATICA “FEDERIGO ENRIQUES” UNIVERSITÀ DEGLI STUDI DI MILANO, VIA CESARE SALDINI 50, 20133, MILANO AND INFN SEZIONE DI MILANO, VIA GIOVANNI CELORIA 16, 20133, MILANO. ORCID: 0000-0003-0423-3736.

⁴WASEDA INSTITUTE FOR ADVANCED STUDY, WASEDA UNIVERSITY, NISHIWASEDA BUILDING, NISHI-WASEDA 1-21-1, SHINJUKU-KU, TOKYO 169-0051 JAPAN. ORCID: 0000-0001-6874-7141.

E-mail addresses: filipuk@mimuw.edu.pl, mgraffeo@sissa.it, giorgio.gubbiotti@unimi.it, stokes@aoni.waseda.jp.

2020 *Mathematics Subject Classification.* 34M55, 14E05, 14H70, 37J35.

Key words and phrases. Painlevé equations; regularisation; resolution of singularities; space of initial conditions; Hamiltonian systems.

1. INTRODUCTION

At the turn of the 20th century Paul Painlevé and his school carried out a program aiming to classify all second-order differential equations in the complex domain admitting at most movable poles of solutions [32, 34, 64, 65]¹. The main outputs of this program were six equations, nowadays known as the *Painlevé equations* and denoted $P_I, P_{II}, \dots, P_{VI}$, whose solutions are transcendental functions not yet defined at that time. We refer to the book of Edward L. Ince [40] for an extended explanation of the original work of Painlevé and his followers.

During the 20th century Painlevé equations and their discrete counterparts appeared in many problems, both theoretical and applied. In particular, they play a prominent rôle in the theory of semi-classical orthogonal polynomials, see [87] and the numerous references therein. These reasons keep fueling the interest in Painlevé equations nowadays.

One of the main advancements in the theory of Painlevé equations was made in the late 70's by Kazuo Okamoto who proposed a completely new approach by means of the construction of the *space of initial conditions* for each of P_I, \dots, P_{VI} , which allows Painlevé's results to be understood in algebro-geometric terms [60]. After the discrete analogues of Painlevé equations were introduced, see [31, 38, 70], this approach was extended to a unified framework for Painlevé equations and their discrete analogues by Hidetaka Sakai [72]. We call this approach to Painlevé equation the (Okamoto-Sakai) *geometric theory of Painlevé equations*. It allows one to partially bypass the classical complex analytic setting, by associating to a second-order differential equation (or equivalently a system of two first-order differential equations) a complex rational surface [3] obtained from a suitable compactification of the affine plane via a sequence of blow ups. The main idea behind this association is that Painlevé-type equations are related to the so-called generalised Halphen surfaces, see [72], with zero-dimensional anti-canonical linear system whose unique member consists of a configuration of (-2) -curves. This configuration identifies the equation-type uniquely. Moreover, the dynamics is *vertical* on the (-2) -curves. For instance, the “most degenerate” Painlevé equation, i.e. P_I , is associated to a rational surface with a configuration of (-2) -curves intersecting according to the $E_8^{(1)}$ Dynkin diagram, while the “least degenerate” Painlevé equation, i.e. P_{VI} , is associated to the Dynkin diagram $D_4^{(1)}$, see Figure 1, through its configuration of (-2) -curves.

Since its introduction the geometric theory of Painlevé equations has been a valuable tool to describe properties of Painlevé equations such as Lax pairs, Bäcklund transformation symmetries, particular rational and/or hypergeometric solutions, and asymptotics, see the survey [45] and references therein for a complete account of these developments. It is remarkable that the geometric theory of Painlevé equations solves (to a certain extent) a version of the so-called Painlevé equivalence problem [12]. Given a system either known or suspected to be equivalent via birational transformation to one of $P_I, P_{II}, \dots, P_{VI}$, this problem consists in determining which one, and finding the transformation to the standard form of the relevant Painlevé equation explicitly.

¹To be more precise, Painlevé and his school considered equations of the form $x''(t) = F(x(t), x'(t); t)$ where F is polynomial in $x'(t)$, rational in $x(t)$, and analytic in t .

The identification procedure was first formulated in the discrete case in [26] and then adapted to the differential case in [27]. It is based on constructing the minimal space of initial conditions for the system under consideration and matching it with that of a standard form of a Painlevé equation, which consists in building an identification between two generalised Halphen surfaces and their configurations of (-2) -curves. This algorithm was applied successfully to identify different Hamiltonian forms of Painlevé equations [24, 29], and recently extended to the case of Hamiltonian systems with the quasi-Painlevé property in [20], using the results of [46].

In this paper we are interested in a system of three first-order differential equations coming from the work of Chao Min and Yang Chen [56]. Therein the polynomials orthogonal with respect to a measure, called the *degenerate Jacobi unitary measure*, were studied. In particular, in [56] several equations satisfied by their recurrence coefficients, and certain auxiliary functions, were derived, see Section 2 for more details. It is worth mentioning that the results of [56] extend the results of [11, 17] where special cases of the same weight were considered, and connections with particular cases of P_{VI} were presented.

We will show in Section 2 that the results in [56] relate the recurrence coefficients and the auxiliary functions with the solutions of the following system of three non-linear ordinary differential equations in three dependent variables $\mathbf{x}(t) = (x, y, z)(t)$:

$$\begin{aligned} (t-1)tx' &= x(\kappa + \beta - \alpha t - \beta t + 2ty - 2(t-1)z - t) + (t-1)x^2 - \kappa(\beta + 2z), \\ (\kappa-1)t^2xy' &= tx(n(n+\gamma)(x(t-1)+1) + txy(y+2n+\gamma) + (\kappa-\beta-1)y(1-x)) \\ &\quad - z(\beta(\kappa-2)\kappa + x((1-t)\beta + (t(2y+2n+\gamma) + \beta)(x(t-1)+1))) \\ &\quad - z^2((\kappa-2)\kappa - ((t-1)x+1)^2 + 1), \\ (t-1)z' &= ty', \end{aligned} \quad (1.1)$$

where α, β, γ are complex constants, and $\kappa = \alpha + \beta + \gamma + 2n + 1$, such that $\mathbf{x}(t)$ satisfy the following non-linear, time-dependent constraint:

$$S_t := \{h_t := h(x, y, z; t) = 0\} \subset \mathbb{C}_t^3, \quad (1.2)$$

where

$$\begin{aligned} h_t &= txy(2n(\kappa + (t-1)x) + tx(\gamma + y - 2z) + (x - \kappa)(2z - \alpha - \gamma)) \\ &\quad + (\kappa + (t-1)x)(x(nt(\gamma + n) - z(\beta + 2nt + \gamma t) + (t-1)z^2) + \kappa z(\beta + z)). \end{aligned} \quad (1.3)$$

That is, the solutions of the system (1.1) have to satisfy the additional condition:

$$h_t(\mathbf{x}(t); t) \equiv 0, \quad \forall t \in B, \quad (1.4)$$

for a domain $B \subset \mathbb{C}$.

Note that it is not evident if the hypersurface S_t admits a rational parametrisation, so that we can obtain a restriction of the system (1.1) to a system of two rational first-order differential equations. In this paper, we will show that it is possible to obtain such a restriction in at least two different ways: one deduced from results in [56], and another through a purely algebro-geometric analysis of the hypersurface. To be more precise, we will prove the following statement about the system (1.1).

Theorem I (Theorems 3.2 and 4.10 and Propositions 4.2, 5.5 and 6.8). *The system (1.1), complemented with the invariant hypersurface condition (1.2) restricts to a 2D system,*

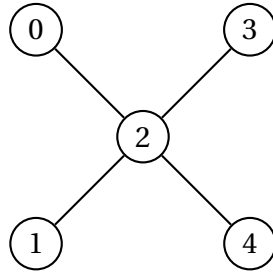

FIGURE 1. The Dynkin diagram of $D_4^{(1)}$.

admitting a space of initial conditions whose (-2) -curves intersect according to the Dynkin diagram $D_4^{(1)}$. In addition, we show:

- the restricted system can be birationally mapped to Painlevé-VI in a Hamiltonian form, and inherits a Hamiltonian structure on its space of initial conditions;
- the polynomial defining the hypersurface S_t (1.3) is a time-dependent Darboux polynomial for the system (1.1), i.e. the hypersurface S_t is a Darboux surface, see Section 4.1;
- the system (1.1) admits a Liouville–Poisson integrable autonomous limit such that the fibration defined by the integrals is given by elliptic curves.

Before presenting the plan of the paper, we give some comments on this main result. First, we observe that as stated in Theorem I (and previously), we will reduce the 3D system (1.1) to two 2D systems. In previous papers, see [23, 25–27, 50], the Painlevé identification procedure was applied to 2D systems coming from orthogonal polynomials theory with respect to various semi-classical weights². So, to the best of our knowledge, this is the first time the geometric theory of Painlevé equations is applied to recognize a higher-dimensional system subject to a constraint as a Painlevé equation. However, it is worth mentioning that the relation between the degenerate Jacobi weight and P_{VI} is not new [56]. The idea of this paper is to develop the tools to identify Painlevé equations appearing as constrained higher-dimensional systems. We also remark that asking that the solutions of the system (1.1) lie on the hypersurface S_t is *stronger* than the existence of the Darboux polynomial.

Finally, we underline that many questions about the full 3D system (1.1) remain open. From our viewpoint, the main open question is whether the system in its full generality possesses the Painlevé property. As stated in Theorem I, we prove that there exists an autonomous limit which is multi-Hamiltonian and it defines an elliptic fibration. So, from the known relationship between elliptic fibrations and Painlevé equations, see e.g. [6, 22, 73, 86], this gives a strong indication for the following conjecture.

Conjecture 1. The 3D system (1.1) possesses the Painlevé property, and it is possible to construct a space of initial conditions for it whose fibres are rational threefolds with zero-dimensional anti-canonical linear system.

Note that, a crucial difference in the surfaces providing spaces of initial conditions between the autonomous and the non-autonomous cases is the following. In the

²The two components of the system usually represent coefficients from the three-term recurrence for the orthogonal polynomials, or some auxiliary functions defined using the method of ladder operators, see, for instance, [87, Chap. 4] and the references therein.

autonomous case (differential or difference equations solved by elliptic functions) the linear system associated to the anti-canonical divisor of the surface constructed after blow up has *positive dimension*, while in the non-autonomous case (Painlevé or discrete Painlevé equations) it has *dimension zero*. See again [5, 36] for examples in the discrete setting.

We defer the study of the 3D system to future research, because the geometry of higher dimensional differential equations seems to be much harder in comparison with the well-known two-dimensional one. Though some examples of differential equations in higher dimensions have been studied geometrically [47–49, 74, 75, 79, 81], the construction of a space of initial conditions relies strongly on knowing that the system under consideration has the Painlevé property. We mention that also in the corresponding discrete case going beyond dimension two greatly increases the difficulty of problem and the involved computations, see e.g. [5, 36, 84, 85].

Outline of the paper. In Section 2 we present a derivation of the system (1.1) and the foundations of the Okamoto-Sakai geometric theory of Painlevé equations. Moreover, we introduce the notion of a space of initial conditions in algebro-geometric language and we recall the notion of symplectic and Hamiltonian atlases for it. In Section 3 we consider a system of two first-order differential equations giving the flow of (1.1) restricted to the hypersurface (1.2) using a parametrisation derived from the results of Min-Chen [56], construct a space of initial conditions for it, and build an identification with the standard P_{VI} equation. In Section 4 we show that the hypersurface (1.2) is in fact the zero locus of a (time dependent) Darboux polynomial [35] for the system (1.1). Then, using ideas from resolution of singularities we obtain another parametrisation of the hypersurface, and we construct a space of initial conditions for the restriction of the system (1.1) in this parametrisation. Also, we play again the identification game compactifying the rational parametrisation to the Hirzebruch surface $\mathbb{F}_1 = \text{Bl}_p \mathbb{P}^2$. In the subsequent Section 5 we end our study of the restricted system by discussing its Hamiltonian structure in both parametrisations. In Section 6 we prove, in the same spirit as [1] does for the P_{VI} equation, that system (1.1) admits a Liouville–Poisson integrable autonomous limit, with the particular properties described above. We give some conclusions and an outlook as complete as possible on the prospective future developments in Section 7. In Appendix A, we review some results on the geometry of P_{VI} . Then, in Appendix B we highlight some analogy between system (1.1) and the σ -form of P_{VI} . In Appendix C, we explain issues which can arise in the construction of a space of initial conditions from a non-optimal choice of compactification, namely the appearance of apparent singularities which should not be blown up. Finally, in Appendix D we present two autonomous exponential limits of system (1.1).

2. BACKGROUND MATERIAL

In this section, we give the basic tools we need in the paper. First, in Section 2.1 we show how to derive the system (1.1) using the results in [56], and in Section 2.2 we provide a general introduction to the geometric theory of Painlevé equations. Later, in Section 2.3 we recall the main properties of the intersection pairing on smooth projective surfaces and how Hirzebruch surfaces are related by elementary transformations. Then, in Sections 2.4 and 2.5 we introduce the notion of space of initial conditions, and we explain Okamoto’s models in terms of Sakai surfaces. Finally, in Section 2.6 we recall the notion of symplectic and Hamiltonian atlases necessary to prove the

existence of global Hamiltonian structures of Painlevé equations on their spaces of initial conditions.

We will keep our discussion to a minimum, and we will introduce additional tools as needed to complete specific steps of the proof of Theorem I later.

Notation 2.1. From now on, throughout the paper for the sake of simplicity, we will refer to systems of first-order differential equations simply as “systems”. Moreover, we sometimes omit the explicit dependence on the independent variable t , e.g. $x = x(t)$, when no possibility of confusion arises.

2.1. The 3D model. In this subsection we shall present the system of three first-order differential equations which will be the main object of study of this paper, and explain how it can be derived from various relations in [56].

Consider the space $L^2([0, 1], d\mu)$ where:

$$d\mu = w(x, t)dt, \quad (2.1)$$

with the following weight function:

$$w(x, t) = x^\alpha(1-x)^\beta|x-t|^\gamma(A+B\theta(x-t)), \quad x, t \in [0, 1], \quad \alpha, \beta, \gamma > 0, \quad (2.2)$$

where $\theta(x)$ is the *Heaviside step function*, and $A \geq 0$, $A+B \geq 0$, and $t \in \mathbb{C}$ are parameters. The orthogonal polynomials with respect to this weight are called the *degenerate Jacobi unitary polynomials*, and are denoted by $P_n(z)$, where the non-negative integer $n \geq 0$ is the degree of $P_n(z)$, see [56].

Using the theory of ladder operators, see again [87, Chap. 4], one defines two functions $A_n(z)$ and $B_n(z)$ such that they satisfy the so-called *lowering operator equation*:

$$\left(\frac{d}{dz} + B_n(z)\right)P_n(z) = \beta_n A_n(z)P_{n-1}(z), \quad (2.3)$$

and the *raising operator equation*:

$$\left(\frac{d}{dz} - B_n(z) - v'_0(z)\right)P_{n-1}(z) = -A_{n-1}(z)P_n(z), \quad (2.4)$$

where

$$v_0(x) = -\alpha \ln x - \beta \ln(1-x), \quad \alpha, \beta > 0. \quad (2.5)$$

The expansions as $z \rightarrow \infty$ of the functions A_n and B_n are governed by six auxiliary functions $R_n(t)$, $r_n(t)$, $x_n(t)$, $y_n(t)$, $\alpha_n(t)$, $\beta_n(t)$, where $\alpha_n(t)$ and $\beta_n(t)$ are recurrence coefficients for the sequence of the associated monic orthogonal polynomials. This is the content of the following theorem.

Theorem 2.2 ([56, Theorem 2.4]). *As $z \rightarrow \infty$, $A_n(z)$ and $B_n(z)$ have the following series expansions:*

$$\begin{aligned} A_n(z) &= \frac{\gamma + (t-1)R_n - tx_n}{z^2} + \frac{\gamma(t + \alpha_n) + (t^2-1)R_n - t^2x_n}{z^3} \\ &\quad + \frac{\gamma(t^2 + \alpha_n^2 + t\alpha_n + \beta_n + \beta_{n+1}) + (t^3-1)R_n - t^3x_n}{z^4} + O\left(\frac{1}{z^5}\right), \\ B_n(z) &= -\frac{n}{z} + \frac{(t-1)r_n - ty_n - nt}{z^2} + \frac{\gamma\beta_n - nt^2 + (t^2-1)r_n - t^2y_n}{z^3} \\ &\quad + \frac{\gamma\beta_n(t + \alpha_n + \alpha_{n-1}) + t^3(r_n - y_n - n) - r_n}{z^4} + O\left(\frac{1}{z^5}\right). \end{aligned} \quad (2.6)$$

There are numerous difference (with respect to n) and differential-difference relations among the auxiliary functions $R_n(t)$, $r_n(t)$, $y_n(t)$ and the recurrence coefficients $\alpha_n(t)$, $\beta_n(t)$. The relations relevant to our discussion are summarised in the following theorem which collects some of the results in [56].

Theorem 2.3. *The variables α_n and β_n satisfy the following Toda-like equations:*

$$\begin{aligned} t\alpha'_n &= \alpha_n + r_n - r_{n+1}, \\ t\beta'_n &= \beta_n(2 - R_n + R_{n-1}). \end{aligned} \quad (2.7)$$

Furthermore, the recurrence coefficients α_n and β_n have the following expressions in terms of r_n , y_n and R_n :

$$\begin{aligned} (\kappa + 1)\alpha_n &= 2(t-1)r_n - 2ty_n - (t-1)R_n + t\alpha + (t-1)\beta + t, \\ \kappa(\kappa - 2)\beta_n &= [ty_n - (t-1)r_n]^2 - (t-1)(2nt + \gamma t + \beta)r_n \\ &\quad + t[(t-1)(2n + \gamma) - \alpha]y_n + n(n + \gamma)(t^2 - t), \end{aligned} \quad (2.8)$$

and the following relation between the variables r_n and y_n holds:

$$(t-1)r'_n(t) = ty'_n(t). \quad (2.9)$$

Finally, the coefficient y_n satisfies:

$$\begin{aligned} y_n &= \frac{1}{2tR_n} \left\{ t(t-1)R'_n - (t-1)R_n^2 \right. \\ &\quad \left. + [2(t-1)r_n + (\alpha + \beta + 1)t - \kappa - \beta]R_n + \kappa(2r_n + \beta) \right\}, \end{aligned} \quad (2.10)$$

and there is a polynomial equation relating r_n with R_n and R'_n of the form:

$$\mathcal{N}(R_n, R'_n)r_n - \mathcal{D}(R_n, R'_n) = 0. \quad (2.11)$$

Theorem 2.3 summarises the results of [56, Sec. 3]. In particular, equations (2.7) are [56, Eqs. (3.5) and (3.2)], equations (2.8) are the content of [56, Prop. 3.1], relation (2.9) is [56, Eq. (3.6)], while equation (2.10) is [56, Eq. (3.21)], and the final relation (2.11) is [56, Eq. (3.22)]. We omit the explicit expressions of the two polynomials \mathcal{N} , \mathcal{D} because they are too cumbersome, see [56, p. 9180].

From this we get the following result.

Proposition 2.4. *Relabel the variables in Theorem 2.3 as:*

$$x(t) = R_n(t), \quad z(t) = r_n(t), \quad y(t) = y_n(t). \quad (2.12)$$

Then, the relations in Theorem 2.3 imply that these three variables satisfy the system (1.1) subject to the condition (1.2).

Proof. Solve (2.8) with respect to $\alpha_n(t)$, $\beta_n(t)$ and substitute them and their derivatives into the Toda-type equations (2.7). Solve the resulting equations with respect to $r'_n(t)$ and $y'_n(t)$ in terms of $R_n(t)$, $r_n(t)$, $y_n(t)$ and $R'_n(t)$. Substituting $R'_n(t)$ from (2.10) and using equation (2.9) gives the desired equations. Finally, the constraint can be derived from (2.10) and (2.11) by eliminating R'_n and substituting (2.12). \square

Remark 2.5. We remark that in [56, Prop. 3.2, Thm. 3.4, and Thm. 3.5] it was proved by a direct computation that the functions $r_n(t)$ and $y_n(t)$ are related to the σ -form of P_{VI} , see [44] and Appendix B, and the function $R_n(t)$ is related to a particular solution of P_{VI} . From our perspective, it is more natural to consider the system (1.1), together

with the invariant hypersurface condition (1.2). As anticipated in the Introduction we consider the restriction of system (1.1) to a two-dimensional one and relate it to P_{VI} via a geometric argument. Moreover, we will comment in Appendix B, on how to relate system (1.1) to the σ -form of P_{VI} .

2.2. Painlevé equations. The celebrated six Painlevé equations $P_I, P_{II}, \dots, P_{VI}$ naturally arise in numerous problems in mathematics and mathematical physics. They have many remarkable properties, including Hamiltonian structures, symmetries forming affine Weyl groups, and relation with isomonodromic deformation of linear differential equations [13, 30, 39, 58]. Recall that the only singularities of solutions of the Painlevé equations which are movable, i.e. their locations in the complex plane depend on initial conditions, are poles. This is usually referred to as the *Painlevé property*, and P_I, \dots, P_{VI} are characterised by the fact that they have this property but are not solvable in general in terms of elementary functions or classical special functions which satisfy linear differential equations.

Recall that the sixth Painlevé equation in its standard scalar form is given by:

$$f'' = \frac{1}{2} \left(\frac{1}{f} + \frac{1}{f-1} + \frac{1}{f-t} \right) (f')^2 - \left(\frac{1}{t} + \frac{1}{t-1} + \frac{1}{f-t} \right) f' + \frac{f(f-1)(f-t)}{t^2(t-1)^2} \left(A + B \frac{t}{f^2} + C \frac{t-1}{(f-1)^2} + D \frac{t(t-1)}{(f-t)^2} \right), \quad (2.13)$$

where A, B, C, D are arbitrary (complex) parameters. The Painlevé property of equation (2.13) means that any (locally defined) solution $f(t)$ can be continued to a single-valued meromorphic function on the universal covering space of $B = \mathbb{C} \setminus \{0, 1\}$, where the need to take the universal cover arises because solutions may be branched about fixed singularities.

One of the standard forms of P_{VI} as a system of two first-order equations appears in the survey [45] of Kajiwara, Noumi and Yamada (KNY):

$$\begin{aligned} f' &= \frac{(f-1)f(f-t)}{t(t-1)} \left(\frac{2g}{f} - \frac{a_0-1}{f-t} - \frac{a_3}{f-1} - \frac{a_4}{f} \right), \\ g' &= -\frac{f^2(g+a_2)(g+a_1+a_2) - tg(g-a_4)}{t(t-1)f}, \end{aligned} \quad (2.14)$$

where a_0, \dots, a_4 are complex parameters subject to the single constraint

$$a_0 + a_1 + 2a_2 + a_3 + a_4 = 1. \quad (2.15)$$

The two forms (2.13) and (2.14) are equivalent, via elimination of g , up to the following identification of parameters:

$$A = \frac{a_1^2}{2}, \quad B = -\frac{a_4^2}{2}, \quad C = \frac{a_3^2}{2}, \quad D = \frac{1-a_0^2}{2}. \quad (2.16)$$

The system (2.14) is of Hamiltonian form

$$\frac{f'}{f} = \frac{\partial H_{VI}^{KNY}}{\partial g}, \quad \frac{g'}{f} = -\frac{\partial H_{VI}^{KNY}}{\partial f}, \quad (2.17)$$

with Hamiltonian given by

$$H_{VI}^{KNY} = \frac{(f-1)(f-t)g}{t(t-1)} \left(\frac{g}{f} - \frac{a_0-1}{f-t} - \frac{a_3}{f-1} - \frac{a_4}{f} \right) + \frac{a_2(a_1+a_2)(f-t)}{t(t-1)}. \quad (2.18)$$

2.3. Intersection form and elementary transformations. Given a smooth projective surface S denote by $\text{Div}(S)$ its divisor group, i.e. the free abelian group generated by its irreducible codimension-one subvarieties. In this subsection we recall the main properties of the intersection product on $\text{Div}(S)$, see [3] for more details. Moreover, we will briefly explain how elementary transformations relate different Hirzebruch surfaces, see [41, Example V-5.7.1].

Recall [41, Theorem V-1.1] that there is a unique symmetric bilinear form

$$\begin{aligned} \text{Div}(S) \times \text{Div}(S) &\longrightarrow \mathbb{Z} \\ (C, D) &\longmapsto C.D, \end{aligned}$$

named *intersection pairing*, such that:

- if $C, D \subset S$ are non-singular curves meeting transversally then $C.D = |C \cap D|$;
- it only depends on linear equivalence classes, i.e. if $C, D, D' \in \text{Div}(S)$ are divisors then $C.D = C.D'$ whenever $D \sim D'$.

The following lemma is a direct consequence of the defining properties of the intersection pairing.

Lemma 2.6. *Let $\varepsilon : \text{Bl}_p S \rightarrow S$ be the blow up of a smooth projective surface S centered at a point $p \in S$. Then, the exceptional curve $L = \varepsilon^{-1}(p)$ is a smooth rational curve of self-intersection $L^2 = -1$.*

Let also $p \in C \subset S$ be an irreducible curve passing through p , and smooth at p . Consider its proper transform $D = \varepsilon^{-1}(C \setminus \{p\})$. Then, we have $C^2 = D^2 - 1$.

Recall the definition of Hirzebruch surface.

Definition 2.7 (Hirzebruch surface). *A Hirzebruch surface is the datum of a smooth projective surface S and a morphism $S \rightarrow \mathbb{P}^1$ with all fibres isomorphic to \mathbb{P}^1 .*

Remark 2.8. Hirzebruch surfaces are naturally indexed by non-negative integers. Under this identification, the k -th Hirzebruch surface is the projectivisation of the rank-two vector bundle $\mathcal{O}_{\mathbb{P}^1} \oplus \mathcal{O}_{\mathbb{P}^1}(k)$, i.e.

$$\mathbb{F}_k \cong \text{Proj}_{\mathbb{P}^1}(\mathcal{O}_{\mathbb{P}^1} \oplus \mathcal{O}_{\mathbb{P}^1}(k)).$$

For instance, we have $\mathbb{F}_0 = \mathbb{P}^1 \times \mathbb{P}^1$ and $\mathbb{F}_1 = \text{Bl}_p \mathbb{P}^2$. Moreover, the fibration $\mathbb{F}_k \rightarrow \mathbb{P}^1$ has two sections C_+, C_- such that $C_+^2 = -C_-^2 = k$. More details on Hirzebruch surfaces can be found in [41, Chapter V].

Any two Hirzebruch surfaces are birational to each other. The birational transformations relating them are sequences of the so-called *elementary transformations*.

Figure 2 describes the elementary transformation relating \mathbb{F}_k and \mathbb{F}_{k+1} . Each curve is labeled by its self-intersection. Notice that at each step self-intersections are computed via Lemma 2.6.

2.4. Spaces of initial conditions and the Painlevé property. The fact that the sixth Painlevé equation (2.13) has the Painlevé property is closely related to the existence of a space of initial conditions, as defined and constructed for P_I, \dots, P_{VI} by Okamoto [60]. His construction consists in considering an equivalent system of two first-order differential equations and then, through a combination of compactification and birational transformations, constructing an augmented phase space of which the flow of the

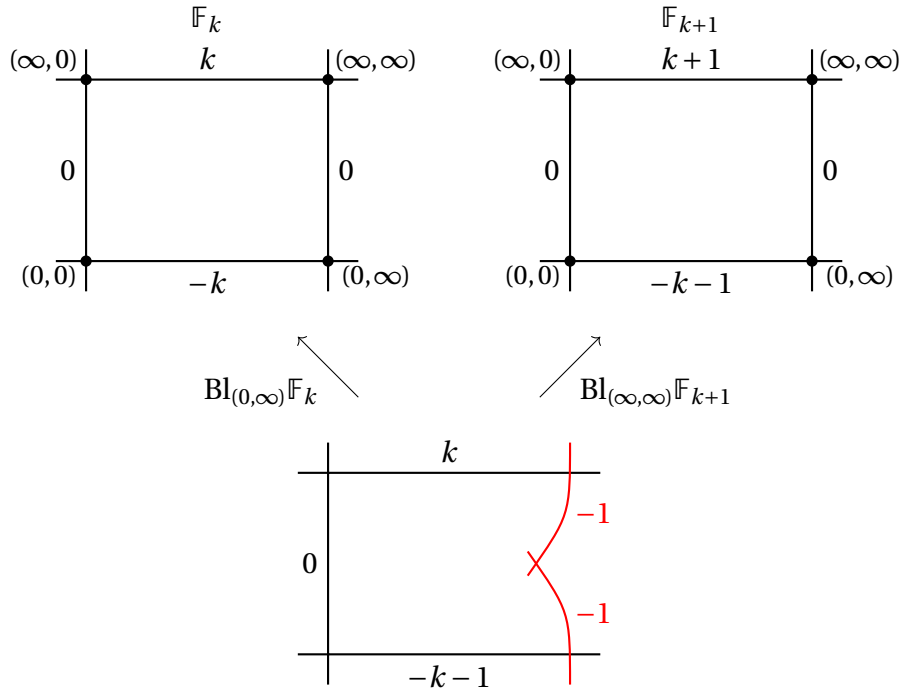

FIGURE 2. The elementary transformation relating \mathbb{F}_k and \mathbb{F}_{k+1} .

system defines a uniform foliation. Okamoto worked with polynomial first-order systems with meromorphic t -dependence of coefficients. Since we will be working with rational systems we give a formal definition of a space of initial conditions in algebro-geometric language. Before that, recall the notion of uniform foliation as used in the context of Painlevé equations [47, 60, 78].

Definition 2.9 (Uniform foliation). Consider a triple (E, π, B) consisting of a complex manifold E with a surjective holomorphic map $\pi : E \rightarrow B$ onto some domain $B \subset \mathbb{C}$. A uniform foliation of (E, π, B) is a nonsingular foliation \mathcal{F} of E into complex one-dimensional analytic subsets called leaves such that

- each leaf of \mathcal{F} intersects every fibre $E_t = \pi^{-1}(t)$, for $t \in B$, transversally;
- any path ℓ in B with starting point $t_* \in B$ and any point $p \in E_{t_*}$, can be lifted to the leaf passing through p .

Consider a non-autonomous system of two first-order differential equations

$$q' = F(q, p; t), \quad p' = G(q, p; t), \quad (2.19)$$

where F, G are rational in q, p with coefficients being rational functions of t regular on some domain $B \subset \mathbb{C}$. Regarding q, p as coordinates on \mathbb{C}^2 , the system (2.19) defines a rational vector field on $\mathbb{C}^2 \times B$. We will sometimes refer to B as the *independent variable space* for the system (2.19).

Definition 2.10 (Indeterminacy point). A point $b = (q_*, p_*)$ in $\mathbb{C}^2 \times \{t_*\}$ such that both the numerator and denominator of F or G in equation (2.19) vanish is said to be an *indeterminacy point*.

If equation (2.19) admits a one-parameter family of local holomorphic solutions $(q_\mu(t), p_\mu(t))$, parametrised by $\mu \in \mathbb{C}$, all passing through the same point at $t = t_*$, i.e. $(q_\mu(t_*), p_\mu(t_*)) = (q_*, p_*)$, then (q_*, p_*) is an indeterminacy point.

Remark 2.11. Since we are working with smooth projective surfaces, the intersections of the zero loci of the numerator and the denominator of F or G in equation (2.19) consist of a finite number of points. In order to regularise the system the main strategy consists in resolving these indeterminacy points and separating the solution curves passing through them to achieve a nonsingular foliation. The correct tool for this is the blow up of the surface at the intersection points. Indeed, roughly speaking this procedure decreases the tangency multiplicity of the two curves at meeting points. For instance, transversal curves are separated by blow ups.

Definition 2.12 (Space of initial conditions). A *space of initial conditions*, or *space of initial values*, for the system (2.19) is a commutative diagram

$$\begin{array}{ccccc}
 D & \hookrightarrow & X & \overset{\varphi_X}{\dashrightarrow} & \mathbb{C}^2 \times B \\
 & \searrow & \pi_X \searrow & & \swarrow \pi_B \\
 & & & & B \\
 & \searrow \pi_D & & &
 \end{array} \tag{2.20}$$

where

- π_X is a proper morphism, φ_X is a birational map and π_B is the natural projection,
- X is a smooth variety and the fibres X_t of π_X over each $t \in B$ are complex smooth rational projective surfaces,
- the restrictions $(\varphi_X)|_{X_t}$ are birational for all $t \in B$,
- $D \hookrightarrow X$ is a closed immersion, and the restriction $D_t \subset X_t$ defines a non-empty codimension 1 subvariety³,
- the restriction to $E = X \setminus D$ of the pullback via φ_X of the system (2.19) defines a uniform foliation of $(E, \pi_X|_E, B)$, regarding E as a complex manifold.

Notation 2.13. Whenever no confusion arises we will encode the data in (2.20) in a pair (X, D) omitting the morphisms. Sometimes, with abuse of notation we will also refer to the variety X as a space of initial conditions. In what follows $D = \sum_i m_i D_i$ will be a divisor, but by abuse of notation we will sometimes use the same symbol to indicate the underlying subvariety $D = \cup_i D_i$.

Definition 2.14. We say that a space of initial conditions is minimal if any birational projective morphism to another space of initial conditions is an isomorphism.

Remark 2.15. In a space of initial conditions X , the pullback of the system is devoid of indeterminacy points on $X \setminus D$. However it is important to note that achieving this kind of regularisation of a system does not alone guarantee that it defines a uniform foliation, and it must be shown that solutions do not reach D , usually by invoking the Painlevé property of the equation, though to some extent this can be done from knowledge of (X, E) [82].

Remark 2.16. We also remark, the condition of being minimal for a space of initial conditions says that there are no curves that can be contracted without introducing new singularities. In the discrete setting, that is when dealing with iterations of birational maps, one requires that the pullbacks to X of the original map and its iterates has no divisorial contractions in the indeterminacy locus. In other terms one asks that the map is algebraically stable, see for instance [5, 36].

³Actually, this is a Cartier divisor, see Section 4.2.

Let us explain Okamoto's construction of a space of initial conditions for P_I, \dots, P_{VI} and how it relates to Definition 2.12. For each Painlevé equation, Okamoto considered an equivalent system of two first-order differential equations, see equation (2.19), with F and G polynomials in q, p with coefficients analytic in t on a domain $B \subset \mathbb{C}$ obtained removing the locations of fixed singularities of the Painlevé equation⁴. The systems in question are the polynomial Hamiltonian forms of the Painlevé equations which were provided by Okamoto [62, 63], though they appeared much earlier in the work of Malmquist [51].

As for a non-autonomous system of two first-order differential equations the phase space of (2.19) can be initially taken to be $\mathbb{C}^2 \times B$. The Painlevé property means that for any path ℓ in B with starting point $t_* \in B$, the solution of any initial value problem for system (2.19) at $t = t_*$ can be meromorphically continued in $\mathbb{C}^2 \times B$ along ℓ .

The system (2.19) defines a nonsingular foliation of $\mathbb{C}^2 \times B$. However the presence of movable singularities of solutions means that solutions may not stay in $\mathbb{C}^2 \times B$ and the foliation is not uniform. This gives rise to the need to compactify the fibres of the phase space.

By compactifying \mathbb{C}^2 to some projective rational surface S (common choices include \mathbb{P}^2 , $\mathbb{P}^1 \times \mathbb{P}^1$ or more generally Hirzebruch surfaces \mathbb{F}_k for any $k \geq 0$) one extends the system (2.19) to the trivial bundle $S \times B$. In general, the flow of the system does not define a nonsingular foliation since there may now be families of infinitely many solutions passing through a common point in the fibre over some $t \in B$, i.e. there can be families of infinitely many solutions with movable poles at the same location. Such families of solutions are parametrised by a free coefficient in the Laurent expansion about such a movable pole, classically known as a *resonant parameter*, see for instance [88, §IV]. To remedy this, one performs a sequence of blow ups of the fibre over $t \in B$ (of possibly t -dependent points). Geometrically, this procedure separates the families of solutions and desingularises the foliation, see Remark 2.11. Finally, in order to reach a minimal space of initial condition, as Okamoto did, one might need to contract some rational curves. For instance in Section 3, we have this necessity, while in Section 4 we do not need further contractions.

This leads to a rational surface X_t on which the system extended from (2.19) defines regular initial value problems everywhere away from a collection $D_t = \bigcup_i D_{t,i}$ of curves. It can be shown using the Painlevé property of system (2.19) that analytic continuations of the solutions of these initial value problems will never reach these curves. Removing from X_t the subvariety D_t yield the fibre E_t of the complex analytic bundle $\pi: E \rightarrow B$. Moreover, the flow of the system defines a uniform foliation of E . In particular, any solution to an initial value problem for the system extended from (2.19) at $t_* \in B$ can be holomorphically continued in E along any path ℓ with starting point t_* . In this sense each fibre E_t parametrises the set of solutions and is called a space of initial conditions.

Remark 2.17. With regards to classical terminology, note that the terms “space of initial conditions”, “initial value space” or “space of initial values” are traditionally used, following Okamoto, to refer to a fibre $E_t = X_t \setminus D_t$ of $\pi_X|_E$ over $t \in B$, i.e. the surface X_t with divisor D_t removed. The divisor D_t or its components in the fibre over t are usually called *vertical leaves* of the foliation of X with respect to the projection of X to B , or *inaccessible divisors* since leaves passing through points in E_t will not reach

⁴For example $B = \mathbb{C} \setminus \{0, 1\}$ in the case P_{VI} .

them. We will sometimes refer to X_t as the *compact surfaces* and $E_t = X_t \setminus D_t$ as the *open surfaces*. In the case of Painlevé equations, the total space E is called a *defining manifold* and has the structure of a complex analytic fibre bundle over B , but this is not algebraic and the isomorphisms between different fibres comes from the flow of the Painlevé equation, which is in general transcendental.

2.5. Generalised Halphen surfaces. For each Painlevé equation, a minimal space of initial conditions is a family of generalised Halphen surfaces, as defined by Sakai [72]. A generalised Halphen surface is a smooth complex projective rational surface X with an effective anti-canonical divisor of canonical type, i.e. $D \in |-K_X|$ whose decomposition into irreducible components $D = \sum_i m_i D_i$ is such that the intersection pairing $K_X \cdot [D_i] = 0$ vanishes for all i , see Section 2.3. A generalised Halphen surface X has anti-canonical linear system $|-K_X|$ of dimension equal to either zero or one. In the latter case X is a rational elliptic surface, with the anti-canonical linear system providing its elliptic fibration, see [77]. In the former case there is a unique effective anti-canonical divisor D , and we call such X a *Sakai surface*.

As anticipated in the introduction there is a strong relation between affine root systems and Sakai surfaces. For a Sakai surface, the intersection graph of the irreducible components of the anti-canonical divisor D is an affine Dynkin diagram of type ADE. In the cases of Sakai surfaces associated with Painlevé differential equations, the irreducible components are the curves removed from the fibre in the last step of Okamoto's construction, see Section 2.4 and Notation 2.13. We list the corresponding types of Dynkin diagrams in Table 1.

P _I	P _{II}	P _{III}			P _{IV}	P _V	P _{VI}
$E_8^{(1)}$	$E_7^{(1)}$	$D_8^{(1)}$	$D_7^{(1)}$	$D_6^{(1)}$	$E_6^{(1)}$	$D_5^{(1)}$	$D_4^{(1)}$

TABLE 1. Dynkin diagrams from intersection graphs of irreducible components of D on Sakai surfaces for differential Painlevé equations

Remark 2.18. Sakai surfaces are minimal as spaces of initial conditions for Painlevé equations, see Definition 2.14. Indeed, in order to contract a curve C on a space of initial conditions without introducing new indeterminacies the curve C has to be a vertical leaf of the foliation, i.e. an inaccessible divisor. On Sakai surfaces associated with differential Painlevé equations the inaccessible divisors are all (-2) -curves, which cannot be contracted on smooth points, see [41, Theorem 5.7 and Remark V-5.7.2].

2.6. Hamiltonian structures of Painlevé equations. We start this subsection by fixing our notation.

Notation 2.19. Throughout this subsection we denote by E a complex analytic fibre bundle $\pi: E \rightarrow B$ over a domain $B \subset \mathbb{C}$, with fibre E_t over $t \in B$ equipped with a holomorphic symplectic form ω_t . Moreover, we will denote by d the exterior derivative on the total space of E , and by d_t the exterior derivative on the fibre E_t , so that $d_t t = 0$.

For each Painlevé equation, the equivalent system, in the form (2.19), considered by Okamoto is of Hamiltonian form, i.e.

$$q' = \frac{\partial H}{\partial p}, \quad p' = -\frac{\partial H}{\partial q}, \quad (2.21)$$

for some Hamiltonian function $H = H(q, p; t)$ which is polynomial in q, p with coefficients analytic in $t \in B$. The Hamiltonian form of the system (2.21) extends to a global Hamiltonian structure of the system on E . Roughly speaking, this means that E admits an atlas such that the system is of Hamiltonian form in all charts. However, the system (2.21) is non-autonomous and the gluing of E is t -dependent since the construction involves blow ups of t -dependent points. As a consequence, a global Hamiltonian structure does not automatically follow from the Hamiltonian form (2.21) in the chart $(q, p; t)$ and, further, it only exists in certain atlases, as we will explain below.

Suppose that in some local coordinates (q, p) for the fibre E_t the symplectic form is written as $\omega_t = d_t q \wedge d_t p$. Then, further suppose that in this chart we have a non-autonomous system of differential equations of Hamiltonian form (2.21). We can extend this system to E , and its Hamiltonian structure is preserved if we have an atlas of canonical coordinates in the sense of the following definition.

Definition 2.20 (Symplectic atlas for E). A symplectic atlas for E is the datum of an atlas \mathcal{U} for E , and a choice of coordinates $(x_U, y_U; t)$, for each $U \in \mathcal{U}$, such that the symplectic form ω_t is written on each $U \in \mathcal{U}$ as

$$\omega_t = d_t x_U \wedge d_t y_U. \quad (2.22)$$

Remark 2.21. Notice that, as a consequence of Definition 2.20, the local coordinates of a symplectic atlas are canonical coordinates for ω_t . They are also called Darboux coordinates.

Consider a chart $U_1 \in \mathcal{U}$ of a symplectic atlas \mathcal{U} . A system of differential equations of Hamiltonian form

$$x_1' = \frac{\partial H_1}{\partial y_1}, \quad y_1' = -\frac{\partial H_1}{\partial x_1} \quad (2.23)$$

in the chart U_1 transforms under the (possibly t -dependent) gluing

$$(x_1, y_1; t) \mapsto (x_2(x_1, y_1; t), y_2(x_1, y_1; t); t) \quad (2.24)$$

to be of Hamiltonian form

$$x_2' = \frac{\partial H_2}{\partial y_2}, \quad y_2' = -\frac{\partial H_2}{\partial x_2}, \quad (2.25)$$

in any other chart $U_2 \in \mathcal{U}$, where the Hamiltonians $H_1(x_1, y_1; t)$ and $H_2(x_2, y_2; t)$ are related under (2.24) by

$$\frac{\partial H_2}{\partial x_1} = \frac{\partial H_1}{\partial x_1} - \left(\frac{\partial x_2}{\partial x_1} \frac{\partial y_2}{\partial t} - \frac{\partial y_2}{\partial x_1} \frac{\partial x_2}{\partial t} \right), \quad \frac{\partial H_2}{\partial y_1} = \frac{\partial H_1}{\partial y_1} - \left(\frac{\partial x_2}{\partial y_1} \frac{\partial y_2}{\partial t} - \frac{\partial y_2}{\partial y_1} \frac{\partial x_2}{\partial t} \right). \quad (2.26)$$

The key difference from the autonomous case is that the Hamiltonians H_1 and H_2 will not necessarily coincide under the gluing if it has non-trivial t -dependence, as can be seen in equation (2.26). The global Hamiltonian structure of a system of differential equations on E is not provided by a single Hamiltonian function. Instead, it is provided by a collection of Hamiltonians, one in each chart U of a symplectic atlas \mathcal{U} , which define a common two-form on E written as

$$\Omega = dx_U \wedge dy_U + dH_U \wedge dt. \quad (2.27)$$

It is possible to relax the requirement that the atlas consists of canonical coordinates such that the system is still of Hamiltonian form with respect to ω_t in each chart. To explain this we make the following definition.

Definition 2.22 (Local Hamiltonian structure of a system of ODEs on E). Let $(x, y; t)$ be a local chart of E in which the symplectic form ω_t on E_t is written as

$$\omega_t = F(x, y; t) d_t x \wedge d_t y, \quad (2.28)$$

where F is a rational function in $(x, y; t)$. We say that a system of ODEs on E has a local Hamiltonian structure with respect to ω_t in the chart $(x, y; t)$ if there exists a Hamiltonian function $H(x, y; t)$ such that in this chart the system reads as follows:

$$F(x, y; t)x' = \frac{\partial H}{\partial y}, \quad F(x, y; t)y' = -\frac{\partial H}{\partial x}. \quad (2.29)$$

When the coefficient function $F(x, y; t)$ does not have t -dependence, the following lemma ensures that a local Hamiltonian structure for a system on E survives under changes of coordinates. The proof is by calculation, and we remark that the case when $F_1(x_1, y_1; t) = 1$, $F_2(x_2, y_2; t) = 1$ appears in [78].

Lemma 2.23. *Consider the non-autonomous Hamiltonian system*

$$F_1(x_1, y_1)x_1' = \frac{\partial H_1}{\partial y_1}, \quad F_1(x_1, y_1)y_1' = -\frac{\partial H_1}{\partial x_1}, \quad (2.30)$$

with Hamiltonian function $H_1(x_1, y_1; t)$ rational in x_1, y_1 , with coefficients rational in t and regular on B . Let $\varphi: \mathbb{C}^3 \rightarrow \mathbb{C}^3$ be a transformation between copies of \mathbb{C}^3 , with coordinates $(x_1, y_1; t)$ and $(x_2, y_2; t)$ respectively, given by

$$\varphi: (x_1, y_1; t) \mapsto (x_2(x_1, y_1; t), y_2(x_1, y_1; t); t), \quad (2.31)$$

and denote its restriction to $\mathbb{C}^2 \times \{t\}$ by φ_t . Suppose that it satisfies the condition:

$$F_1(x_1, y_1) d_t x_1 \wedge d_t y_1 = \varphi_t^* (F_2(x_2, y_2) d_t x_2 \wedge d_t y_2), \quad (2.32)$$

for rational functions F_1, F_2 whose coefficients are independent of t . Then, there exists $H_2(x_2, y_2; t)$, unique up to functions of only t , such that

$$F_1(x_1, y_1) d x_1 \wedge d y_1 + d H_1 \wedge d t = \varphi^* (F_2(x_2, y_2) d x_2 \wedge d y_2 + d H_2 \wedge d t). \quad (2.33)$$

Further, the system (2.30) is transformed under φ to

$$F_2(x_2, y_2)x_2' = \frac{\partial H_2}{\partial y_2}, \quad F_2(x_2, y_2)y_2' = -\frac{\partial H_2}{\partial x_2}. \quad (2.34)$$

Therefore for a local Hamiltonian structure to extend to the whole of E we require an atlas such that the symplectic form is independent of t in all charts.

Definition 2.24 (Hamiltonian atlas for E). A Hamiltonian atlas for E is the datum of an atlas \mathcal{U} , and a choice of coordinates $(x_U, y_U; t)$, for each $U \in \mathcal{U}$, such that on each $U \in \mathcal{U}$ the symplectic form ω_t is written as

$$\omega_t = F_U(x_U, y_U) d_t x_U \wedge d_t y_U, \quad (2.35)$$

with F_U independent of t .

Having a Hamiltonian atlas guarantees that a local Hamiltonian structure of a system of ODEs in a single chart extends to all charts of the atlas by Lemma 2.23.

Definition 2.25 (Global Hamiltonian structure of a system of ODEs on E). Given a Hamiltonian atlas \mathcal{U} on E , a global Hamiltonian structure of a system on E is a collection of Hamiltonian functions H_U on each $U \in \mathcal{U}$ defining a two-form Ω on E via

$$\Omega = F_U(x_U, y_U) d x_U \wedge d y_U + d H_U \wedge d t. \quad (2.36)$$

In the case of the Painlevé equations, the divisor associated to the symplectic form ω_t , i.e. the form with respect to which the Hamiltonian structure is defined, is the unique effective anti-canonical divisor $D_t \in |-\mathcal{K}_{X_t}|$, see Section 2.5. After Okamoto's construction for $P_{\text{II}}, \dots, P_{\text{VI}}$, Kyoichi Takano and his collaborators constructed symplectic atlases for E in the sense of Definition 2.20 [53, 55, 78]. The system extended from Okamoto's Hamiltonian form of the corresponding Painlevé equation then has a global Hamiltonian structure and all Hamiltonians $H = H_U(x_U, y_U; t)$, for $U \in \mathcal{U}$, are polynomial functions of x_U, y_U . Further, Takano's school showed that this is the unique holomorphic global Hamiltonian structure extending meromorphically to X , so in this sense the manifold E determines the Painlevé equation uniquely.

We will present the space of initial conditions, symplectic atlas and global Hamiltonian structure for the sixth Painlevé equation in Appendix A.

3. THE SYSTEM ON THE HYPERSURFACE IN THE FIRST PARAMETRISATION

In this section we provide our first example of a system of two first-order differential equations governing the restriction of system (1.1) to the hypersurface (1.2). The main result of this section is Theorem 3.2 where we show that the restriction considered possesses the Painlevé property, which is part of Theorem I.

3.1. The first parametrisation and the associated 2D system. In this subsection we show how to derive a system of two first-order equations from (1.1). We adopt the notation $\tilde{x}(t) = x(t) = R_n(t)$ and $\tilde{y}(t) = R'_n(t)$.

In order to eliminate all the derivatives but $\tilde{y}'(t)$, we start by differentiating the first equation of system (1.1) with respect to t and use other equations of the system to eliminate the derivatives. Now, $\tilde{y}'(t)$ is expressed as a function of $r_n(t)$, $y_n(t)$ and $\tilde{x}(t)$. The first equation of the system is also linear in $y_n(t)$, and we can use it to solve with respect to $y_n(t)$. Substituting it into the expression for $\tilde{y}'(t)$ writes $\tilde{y}'(t)$ only in terms of $r_n(t)$ and $\tilde{x}(t)$. Finally, from (2.11), we get the following system of two first-order differential equations:

$$\tilde{x}' = \tilde{y}, \quad \tilde{y}' = \frac{\phi(\tilde{x}, \tilde{y}; t)}{2(t-1)^2 t^2 \tilde{x}(\kappa - \tilde{x})(\kappa + (t-1)\tilde{x})}, \quad (3.1)$$

where, ϕ is the polynomial:

$$\begin{aligned} \phi = & -(t-1)\tilde{x}^4 (6\kappa^2 - \beta^2 + 4n(t^2 - 6t)(\kappa - n) + t^2(\alpha + \beta + 1)(\alpha + \beta + 2\gamma + 1) \\ & - t(2\alpha(\kappa - 2n) + 2\beta(\gamma + 1) + 2\gamma + 5(\kappa - 2n)^2)) \\ & - \tilde{x}^2 (\kappa^2 (-\kappa^2 + 6\beta^2 + 4nt(\kappa - n) + t^2(\beta^2 - \alpha^2 + 1) + t(2\alpha(\kappa - 2n) \\ & - 5\beta^2 + 2\beta(\gamma + 1) + 2\gamma)) + 3t^2(t-1)^3 \tilde{y}^2 + 2\kappa t(t^3 - 5t^2 + 6t - 2)\tilde{y}) \\ & + 2(t-1)\tilde{x}^3 ((t-1)^2 t \tilde{y} - 2\kappa(\beta^2 - \kappa^2 + 2nt(\beta + \gamma + n) + \beta\gamma t + (\kappa - 1)(\alpha + 1)t)) \\ & - 2\kappa \tilde{x} (-((t-2)(t-1)^2 t^2 \tilde{y}^2) + \kappa t(2t^2 - 3t + 1)\tilde{y} + \beta^2 \kappa^2 (t-2)) \\ & - \kappa^2 (\beta^2 \kappa^2 - (t-1)^2 t^2 \tilde{y}^2) - (t-1)^3 \tilde{x}^6 + 2\kappa(t-2)(t-1)^2 \tilde{x}^5. \end{aligned} \quad (3.2)$$

Note that we also have the parametrisation of the invariant hypersurface in terms of \tilde{x} and \tilde{y} .

3.2. Space of initial conditions. We now construct a space of initial conditions for the system (3.1). Moreover, by proceeding as in [27] we identify it with the KNY Hamiltonian form (2.14) for the sixth Painlevé equation. As outlined in Section 2.4, we consider the system as a rational vector field on $\mathbb{C}^2 \times B$, where $B = \mathbb{C} \setminus \{0, 1\}$ has coordinate t .

Now, to construct the space of initial conditions, see Section 2.4, we compactify the fibres of the canonical projection $\pi_B : \mathbb{C}^2 \times B \rightarrow B$ to the product $\mathbb{P}^1_{[x_0:x_1]} \times \mathbb{P}^1_{[y_0:y_1]}$ by considering the following identification:

$$\tilde{x} = \frac{x_0}{x_1}, \quad \tilde{y} = \frac{y_0}{y_1}, \quad (3.3)$$

where as usual we have omitted the t -dependence from \tilde{x}, \tilde{y} and x_i, y_i for $i = 0, 1$.

Precisely, each fibre $(\mathbb{P}^1 \times \mathbb{P}^1)_t$, over $t \in B$, is covered by the four coordinate charts:

$$(\tilde{x}, \tilde{y}), \quad \left(\tilde{x}, \frac{1}{\tilde{y}}\right) = \left(\frac{x_0}{x_1}, \frac{y_1}{y_0}\right), \quad \left(\frac{1}{\tilde{x}}, \tilde{y}\right) = \left(\frac{x_1}{x_0}, \frac{y_0}{y_1}\right), \quad \left(\frac{1}{\tilde{x}}, \frac{1}{\tilde{y}}\right) = \left(\frac{x_1}{x_0}, \frac{y_1}{y_0}\right). \quad (3.4)$$

After compactification the phase space for system (3.1) is then the trivial bundle $(\mathbb{P}^1 \times \mathbb{P}^1) \times B$ over B . We perform a sequence of blow ups of the fibres over each $t \in B$, of points where the rational vector field defining the system has indeterminacies. We perform the blow up at a point $(x, y) = (a, b)$ as prescribed in [28, Propositions IV-21 & IV-25]. This procedure introduces two charts whose coordinates we denote by (u, v) and (U, V) . In this setting the blow up map is given by

$$(u, v) \longmapsto (a + uv, b + v) = (x, y), \quad (3.5)$$

$$(U, V) \longmapsto (a + V, b + UV) = (x, y).$$

In these coordinates, the exceptional divisor of the blow up has local equations $v = V = 0$.

We initially find the following points of indeterminacy on $(\mathbb{P}^1 \times \mathbb{P}^1)_t$ for the system (3.1):

$$\begin{aligned} p_1 &= ([0 : 1], [\beta\kappa : t(1-t)]), & p_2 &= ([0 : 1], [\beta\kappa : t(t-1)]), \\ p_3 &= ([\kappa : 1-t], [(1-\alpha)\kappa : (t-1)^2]), & p_4 &= ([\kappa : 1-t], [(1+\alpha)\kappa : (t-1)^2]), \\ p_5 &= ([\kappa : 1], [\gamma\kappa : 1-t]), & p_6 &= ([\kappa : 1], [\gamma\kappa : t-1]), \\ p_7 &= ([1 : 0], [1 : 0]). \end{aligned} \quad (3.6)$$

A direct computation shows that the indeterminacies at p_1, \dots, p_6 are resolved after a single blow up. After blowing up p_7 , the system still has an indeterminacy point on the corresponding exceptional curve. Precisely, adopting as usual the coordinates coming from [28, Propositions IV-21 & IV-25] the indeterminacy point is

$$p_8 : (U_7, V_7) = (0, 0). \quad (3.7)$$

Then, if we blow up also p_8 we find two further indeterminacies:

$$p_9 : (u_8, v_8) = (-t, 0), \quad p_{10} : (u_8, v_8) = (t, 0). \quad (3.8)$$

Finally, the blow up of these two points regularises the system.

Denote by S_t the blow up of the fibre $(\mathbb{P}^1 \times \mathbb{P}^1)_t$ with center at the points p_i , $i = 1, \dots, 10$. The inaccessible divisors on S_t are the proper transforms of the lines

$$\{\tilde{x} = 0\}, \left\{ \tilde{x} = \frac{\kappa}{1-t} \right\}, \{\tilde{x} = \kappa\}, \{\tilde{x} = \infty\}, \{\tilde{y} = \infty\},$$

and of the exceptional divisors over the points p_8, p_7 , see Figure 3. Denote by D_t their union. Then, system (3.1) defines a uniform foliation of $S_t \setminus D_t$, assuming D_t is inaccessible. Rather than establishing this directly by analysis of equation (3.1) on S_t , we will deduce this via the transformation to the Hamiltonian form (2.14) of P_{VI} . Therefore, we have constructed a space of initial conditions for system (3.1).

Remark 3.1. We remark that, with abuse of notation, in Figure 3 we have denoted by the same symbol L_i the exceptional divisor over the point p_i , for $i = 1, \dots, 10$, and its proper transforms under blow up.

If we want to run the identification procedure, we need now to reach a minimal space of initial conditions, i.e. a Sakai surface (see Remark 2.18). A direct computation shows that S_t is not minimal as we can contract two curves without introducing new indeterminacies, see Remark 2.16.

The first is the proper transform in S_t of the coordinate line $\{\tilde{x} = \infty\}$, which has self-intersection -1 and is inaccessible. The second is the image under the first contraction of the exceptional line coming from the blow up of p_7 , which similarly is inaccessible and it has self-intersection -1 , see Lemma 2.6. Denote by D_t the union of the (-2) -curves on the resulting surface X_t . Again a direct computation shows that the induced system on X_t has no indeterminacies and any contraction onto a smooth surface does. Then we get a family X over B , and after removal of D_t from each fibre we have $\pi_X|_E : E \rightarrow B$ with fibre $E_t = X_t \setminus D_t$ such that the system (3.1) defines regular initial value problems everywhere on E and a uniform foliation assuming D_t is inaccessible as will be confirmed below (see Remark 3.3). Summing up, this procedure leads to a minimal space of initial conditions (X, D) in the sense of Definition 2.12 and Definition 2.14.

We depict the configuration of (-2) -curves of X_t in the bottom-right corner of Figure 3. Precisely, curves of self-intersection $-1, -2$ are coloured in red, blue respectively, see Section 2.3.

3.3. Relation between the first 2D system and P_{VI} . Following the procedure in [27], we can obtain a change of variables between the system (3.1) and the Hamiltonian form (2.14) of P_{VI} . This is the content of the following theorem and it is a part of Theorem I.

Theorem 3.2. *System (3.1) transforms to the Hamiltonian form (2.14) of the sixth Painlevé equation with parameters*

$$a_0 = -\gamma, a_1 = \kappa, a_2 = -n - \alpha, a_3 = -\beta, a_4 = \alpha, \quad (3.9)$$

via the transformation

$$f = \frac{\kappa + (t-1)\tilde{x}}{\kappa}, \quad (3.10)$$

$$g = \frac{(t-1)(\alpha - \beta - \gamma - 1)\tilde{x}^2 - \kappa(1 - \alpha + 2\beta + \gamma + (\alpha - \beta - 1)t)\tilde{x} + \kappa(\beta\kappa + (t-1)t\tilde{y})}{2(t-1)(\tilde{x} - \kappa)\tilde{x}}. \quad (3.11)$$

The inverse transformation is given by

$$\tilde{x} = \frac{\kappa(f-1)}{t-1}, \quad (3.12)$$

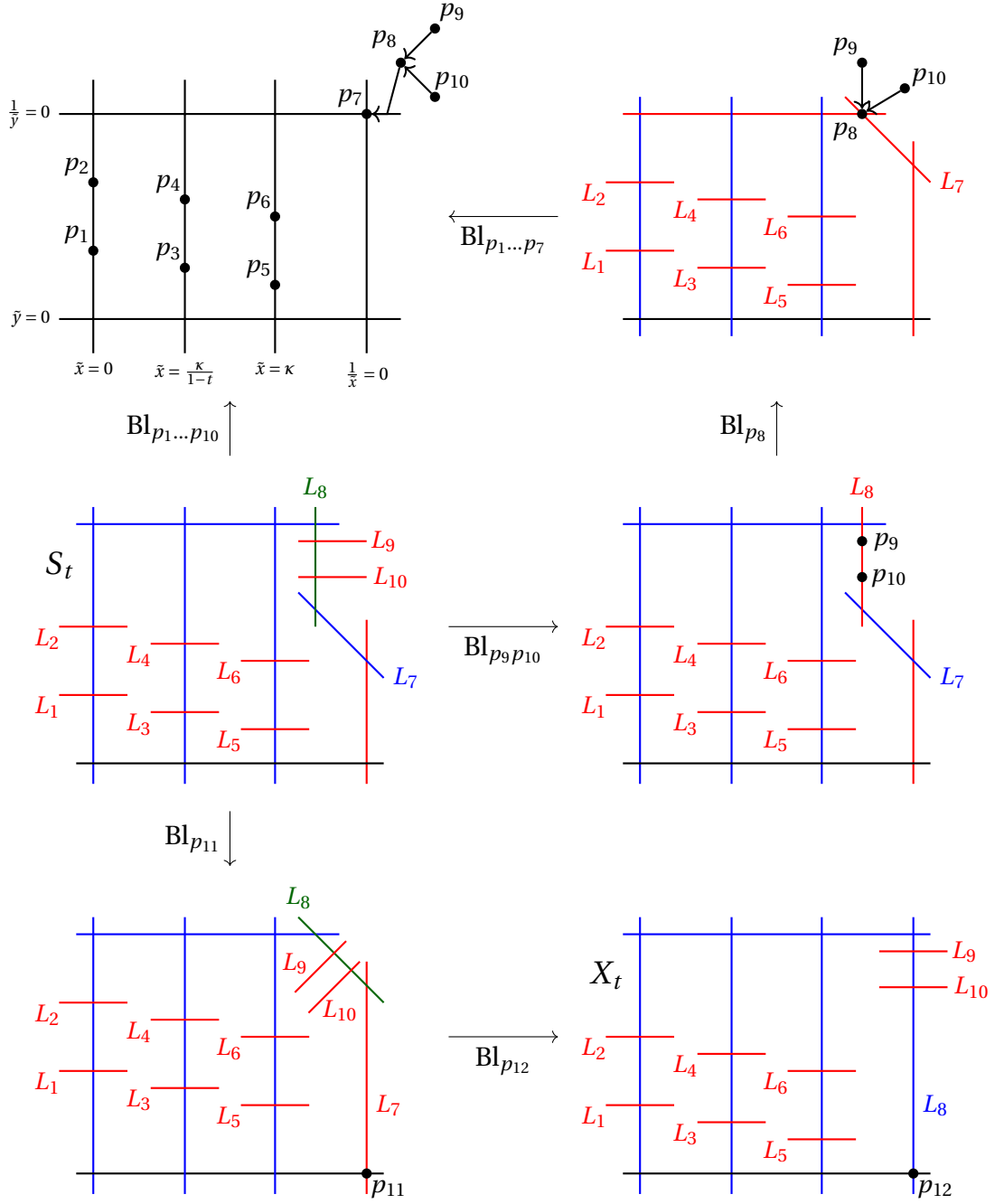

FIGURE 3. Sequence of blow ups and contraction from $(\mathbb{P}^1 \times \mathbb{P}^1)_t$ to X_t . Curves of self-intersection $-1, -2, -3$ are coloured in red, blue, green respectively. See Remark 3.1 for notation.

$$\tilde{y} = \frac{\kappa [(1-\alpha)t + (\alpha-\gamma-1+(\alpha-\beta-1)t)f + (1-\alpha+\beta+\gamma)f^2 + 2(f-1)(f-t)g]}{(t-1)^2 t}. \quad (3.13)$$

This result comes from an isomorphism between X constructed in subsection 3.2 and the space of initial conditions X^{KNY} for the KNY form of P_{VI} in Appendix A. Interpreting the transformation (3.10-3.11) as a birational map $\mathbb{C}_{\tilde{x}, \tilde{y}}^2 \times B \dashrightarrow \mathbb{C}_{f, g}^2 \times B$, this

pulls back to a birational map $X \rightarrow X^{\text{KNY}}$, which is verified to be an isomorphism by checking in charts. Then D and D^{KNY} coincide under the pullback, as do the rational vector fields defined by systems (3.1) and (2.14).

Remark 3.3. The identification in Theorem 3.2 also confirms that $D_t \subset X_t$ from the space of initial conditions constructed above for system (3.1) are inaccessible, since D_t^{KNY} are for system (2.14) on X^{KNY} .

In particular, the function f defined in terms of the solution (\tilde{x}, \tilde{y}) of the system (3.1) solves the sixth Painlevé equation (2.13) with parameters

$$A = \frac{\kappa^2}{2}, B = -\frac{\alpha^2}{2}, C = \frac{\beta^2}{2}, D = \frac{1}{2}(1 - \gamma^2). \quad (3.14)$$

Thus, we recover [56, Th. 3.5].

Remark 3.4. We remark that the identification of the system (3.1) with the Hamiltonian form (2.14) of P_{VI} presented in Theorem 3.2 is not unique. Indeed, the identification is up to the action of the extended affine Weyl group of Bäcklund transformations leaving P_{VI} invariant. In Theorem 3.2 as a target representative we choose the same copy of P_{VI} as in [56], i.e. with parameters (3.14). We observe, that this is not the only possible choice. In particular, in the theory of orthogonal polynomials there might be additional considerations to choose a representative properly. For instance, matching the evolution in n of the recurrence coefficients with some standard example of a discrete Painlevé equation, or relating initial conditions for the recurrence coefficients with the solutions of the Riccati equation which solves the sixth Painlevé equation for a particular choice of parameters.

4. THE SYSTEM ON THE HYPERSURFACE IN THE SECOND PARAMETRISATION

In this section we analyse the system (1.1) subject to the constraint (1.4) as its restriction to a Darboux surface. First, in Proposition 4.2 we prove the existence of a Darboux surface and then, in Theorem 4.10, we identify the restriction with P_{VI} , so proving part of Theorem I.

4.1. The algebraic Darboux hypersurface S_t . In Section 2.1 we recalled how the system (1.1) and the invariant algebraic surface S_t (1.2) arise from the theory of degenerate Jacobi unitary polynomials. In this subsection we show that the hypersurface S_t (1.2) is defined by a *Darboux polynomial* for the system (1.1).

We recall that, given a system of (non-autonomous) first-order differential equations:

$$\mathbf{x}' = \mathbf{F}_t(\mathbf{x}), \quad (4.1)$$

a Darboux function $P_t = P_t(\mathbf{x})$ is a scalar function such that, on each solution of (4.1), we have:

$$P_t'(\mathbf{x}) = C_t(\mathbf{x})P_t(\mathbf{x}), \quad (4.2)$$

for some function C_t , see [19, 67] and the book [35, Section 2.5] for a modern account of this theory. The function C_t is usually called the *cofactor* of P_t . Moreover, when P_t is a polynomial, it is usually called a *Darboux polynomial*, and its zero locus is said to be a *Darboux hypersurface*.

Remark 4.1. We observe that looking for Darboux polynomials is a non-trivial task. In the autonomous setting the problem of finding Darboux polynomials of an assigned degree can be reduced to a problem of solving some polynomial equations, which can

be addressed using tools from computational algebra, see e.g. [2]. On the other hand, in the non-autonomous setting finding Darboux polynomials of an assigned degree is a much harder problem involving the solution of a system of algebraic differential equations.

The following proposition guarantees the existence of a Darboux polynomial for the system (1.1), and it is part of Theorem I.

Proposition 4.2. *The polynomial h_t in (1.3) is a Darboux polynomial for the system (1.1), i.e.:*

$$h'_t = C_t h_t, \quad (4.3)$$

where the cofactor C_t is a rational function of t and \mathbf{x} .

Proof. The proof consists of a direct computation which can be carried out with a computer algebra system, e.g. Maple [52] or Mathematica [54]. For the sake of readability we omit the explicit expression of C_t . \square

We observe that the existence of a Darboux surface gives information about the solutions of the system (1.1).

First of all, let us notice that given a solution $\mathbf{x}(t) = (x, y, z)(t)$ of the system (1.1), we can write the general solution of (4.3) as

$$h_t = h_* \eta_t, \quad \eta_t = \exp\left(\int^t C_\xi(\mathbf{x}(\xi)) d\xi\right), \quad (4.4)$$

where h_* is a constant of integration. Clearly, if $h_* \equiv 0$ then the solution $\mathbf{x}(t)$ belongs to the surface for all $t \in \mathbb{C} \setminus \{0, 1\}$.

Second, the asymptotic behaviour near a movable singularity can be used to determine whether or not a solution stays in the surface. Indeed, let us assume that we have a solution $\mathbf{x}_*(t)$ of the system (1.1), admitting a pole-like movable singularity at $t = t_*$. Then, since h_t is a polynomial we have $h_t \sim (t - t_*)^\lambda$ for $\lambda \in \mathbb{Z}$ in a neighbourhood of t_* . So, if a solution of the system (1.1) is devoid of essential singularities then the functions h_t and η_t are the same up to a potentially vanishing constant factor, i.e. $h_t \sim \eta_t$ or $h_t = 0$. On the other hand, this forces $C_t = \mu(t - t_*)^{-1} + O(1)$ with $\mu \in \mathbb{Z}$. If, near a movable singularity $t = t_*$, the cofactor C_t has a different asymptotic behaviour, then $h_t \equiv 0$ along $\mathbf{x}_*(t)$.

For instance, the system (1.1) admits a class of solutions $\mathbf{x}_*(t)$ with the following behaviour in a neighbourhood of a movable singularity at $t = t_*$:

$$\begin{aligned} x_*(t) &= t_*(t - t_*)^{-1} + a_0 + A(a_0)(t - t_*) + O((t - t_*)^2), \\ y_*(t) &= \frac{t_*(t_* - 1)^2}{\kappa - 1}(t - t_*)^{-2} + \frac{2t_*(t_* - 1)}{\kappa - 1}(t - t_*)^{-1} + O(1), \\ z_*(t) &= \frac{t_*^2(t_* - 1)}{\kappa - 1}(t - t_*)^{-2} + \frac{2t_*(t_* - 1)}{\kappa - 1}(t - t_*)^{-1} + O(1). \end{aligned} \quad (4.5)$$

Here a_0 is an arbitrary constant and $A(a_0)$ is a known rational function of a_0 that can be computed with a computer algebra system, e.g. Maple [52] or Mathematica [54], but whose expression we omit for the sake of readability. Then, in a neighbourhood of $t = t_*$ the cofactor C_t with respect to the solution (4.5) behaves as:

$$C_t = -\frac{\kappa - 3}{\kappa - 1} \frac{1}{t - t_*} + O(1), \quad (4.6)$$

implying $\eta_t \sim (t - t_*)^{-\frac{\kappa-3}{\kappa-1}}$. Since for generic values of κ the behaviour of η_t gives rise to a branch point, we conclude that, for the class of solutions in (4.5) we have $h_* \equiv 0$. Hence, the family is entirely contained in the surface S_t .

As stated in the Introduction, in what follows we will prove that the system (1.1) restricts to S_t in such a way that the resulting two-dimensional system possesses the Painlevé property. Whether or not the “full” system (1.1) might possess the Painlevé property remains an open problem, see Conjecture 1. We postpone its study to subsequent works. However, in Section 6 we will present some strong evidence for it. That is, we will prove that there exists an algebraically integrable autonomous limit of the system (1.1) whose dynamics is associated to an elliptic fibration. This is a strong indication that the system (1.1) possesses the Painlevé property since the two-dimensional Painlevé equations can be constructed as de-autonomisations of two-dimensional systems admitting an invariant elliptic fibration [73].

4.2. Parametrisation of the hypersurface. In this section, we produce a parametrisation for the surface S_t . The study of the singularities of S_t is crucial in our construction. The issue in finding the parametrisation is that this surface is singular making it hard to find a rational parametrisation. Our strategy to overcome this problem is to blow up the surface S_t along a non-Cartier divisor in order to make it less singular and then to look for a parametrisation, see [28, Example IV-27] and [21, App. A].

Definition 4.3. Let X be a quasi-projective variety. Recall that a Weil divisor is a formal \mathbb{Z} -linear combination of irreducible codimension-one subvarieties of X .

Remark 4.4. Recall that, when a codimension-one subvariety $Y \subset X$ is Zariski locally defined by one equation it is a Cartier divisor, see [41, Section II.6]. Similarly given a Cartier divisor $G = \{f_1^{m_1} \cdots f_s^{m_s} = 0\}$, with f_i prime for all $i = 1, \dots, s$, we can cook up the Weil divisor

$$D_G = \sum_{i=1}^s m_i \cdot \{f_i = 0\}.$$

We will often implicitly make use of this identification.

Remark 4.5. Whenever X is smooth, the notions of Weil and Cartier divisors agree. For an example of a Weil divisor which is non-Cartier, consider the line $\{x = z = 0\}$ on the quadric cone $\{xy - z^2 = 0\} \subset \mathbb{C}^3$.

Definition 4.6. Let $Y \subset X$ be a variety and a Weil divisor. The blow up of X centered at Y is a birational projective morphism of varieties

$$\mathrm{Bl}_Y X \xrightarrow{\varepsilon} X \tag{4.7}$$

such that the preimage⁵ $\varepsilon^{-1}Y$ is a Cartier divisor, called the *exceptional divisor*, and such that any other morphism having the same property factors through ε .

Remark 4.7. The blow up of a Weil divisor always exists and it is unique up to unique isomorphism, see [28]. As for the basic case of the blow up of a singular point on a surface, the blow up of a non-Cartier divisor is a powerful tool in the theory of resolution of singularities.

⁵Here the notion of preimage is purely algebraic and the precise definition can be found in [41, Caution II-7.12.2]. However, we omit it as it is unnecessary for our purpose.

All the instances we consider will be blow ups of X with center Y , where Y is a complete intersection in the ambient space where X is located. In this case the blow up can be computed as explained in [28, Propositions IV-21 & IV-25].

We start by considering a suitable compactification \bar{S}_t of S_t . Namely, first we consider the inclusion

$$\begin{aligned} S_t &\hookrightarrow \mathbb{P}_{[y_0:y_1:y_2]}^2 \times \mathbb{P}_{[x_0:x_1]}^1 \\ (x, y, z) &\longmapsto ([y : z : 1], [x : 1]) \end{aligned} \quad (4.8)$$

and then we consider the closure $\bar{S}_t \subset \mathbb{P}_{[y_0:y_1:y_2]}^2 \times \mathbb{P}_{[x_0:x_1]}^1$.

Remark 4.8. We stress that, as in previous sections, we omit the t -dependence implicitly assuming we are working with the fibres of a trivial B -bundle, e.g. in the case $(\mathbb{C}^2 \times \mathbb{P}^1) \times B$, we write $\mathbb{C}^2 \times \mathbb{P}^1$ in place of $(\mathbb{C}^2 \times \mathbb{P}^1)_t$ to denote the fibre over $t \in B$.

In technical terms, the equation of the surface \bar{S}_t can be obtained by replacing

$$y = \frac{y_0}{y_2}, \quad z = \frac{y_1}{y_2}, \quad x = \frac{x_0}{x_1} \quad (4.9)$$

in h_t , see (1.3). A direct check shows that the hypersurface \bar{S}_t has only isolated singularities.

We focus now on the affine chart

$$S_{1,1,t} = \left\{ ([y_0 : y_1 : y_2], [x_0 : x_1]) \in \bar{S}_t \mid x_1, y_1 \neq 0 \right\} \subset \bar{S}_t. \quad (4.10)$$

The surface $S_{1,1,t}$ is singular at

$$P_1 = \left\{ x_0 + \frac{\kappa}{t-1} = y_0 = y_2 = 0 \right\}, \quad P_2 = \left\{ x_0 - \kappa = y_0 - 1 = y_2 = 0 \right\}. \quad (4.11)$$

We blow up now the non-Cartier divisor

$$Y = \left\{ x_0(1-t+ty_0) - \kappa = y_2 = 0 \right\} \subset S_{1,1,t} \quad (4.12)$$

passing through both P_1 and P_2 . A direct check shows that this blow up resolves the two singularities $P_1, P_2 \in S_{1,1,t}$. We also remark that the curve Y is an indeterminacy of system (1.1). The surface $S_{1,1,t}$ lives in the affine space \mathbb{C}^3 with coordinates y_0, y_2, x_0 . Hence, the blow up $\text{Bl}_Y S_{1,1,t}$ lives in $\text{Bl}_Y \mathbb{C}^3$ [28, Propositions IV-21]. We have

$$\text{Bl}_Y \mathbb{C}^3 = \left\{ ((y_0, y_2, x_0)(t), [u : v](t)) \in \mathbb{C}^3 \times \mathbb{P}^1 \mid \text{rank} \begin{pmatrix} u & v \\ y_2 & x_0(1-t+ty_0) - \kappa \end{pmatrix} \leq 1 \right\}. \quad (4.13)$$

Since we look for a rational parametrisation, it is worth restricting to the chart $\tilde{S}_t \subset \text{Bl}_Y S_{1,1,t}$ given by

$$\tilde{S}_t = \left\{ (y_0, y_2, x_0, [u : v]) \in \text{Bl}_Y S_{1,1,t} \mid u \neq 0 \right\}. \quad (4.14)$$

The equation of \tilde{S}_t is derived by replacing

$$y_2 = v(x_0(1-t+ty_0) - \kappa) \quad (4.15)$$

in the equation of $S_{1,1,t}$ and dividing by the equation of the exceptional divisor in $\text{Bl}_Y \mathbb{C}^3$.

Finally, we notice that y_0 is a rational function of x_0 and v . This gives us the surface parametrisation. Explicitly:

$$y_0 = \frac{(\kappa + (t-1)x_0)(1 + nt v^2 x_0(\gamma + n)(\kappa + (t-1)x_0) - v(\beta\kappa - x_0(\beta + 2nt + \gamma t)))}{tx_0(nt v^2 x_0(\gamma + n)(\kappa + (t-1)x_0) + v(\kappa(\kappa - \beta - 1) + x_0(-\alpha + (2n + \gamma)(t-1))) + 1)}. \quad (4.16)$$

4.3. The 2D system in the second parametrisation. Now, we study the restriction, to the hypersurface \tilde{S}_t , of the lift to the blow up $\text{Bl}_Y \mathbb{C}^3$ of the system (1.1). Via the parametrisation obtained above, it consists of two equations in the variables x_0 and v . Namely, by direct computation from equation (4.16) the system reads:

$$\begin{aligned} x_0' &= \frac{v(((t-1)x_0 + \kappa)(x_0 - \beta) - tx_0(\alpha + 1)) + 2}{(t-1)tv}, \\ v' &= -\frac{\eta(x_0, v, t)}{(t-1)tx_0(\kappa - x_0)(\kappa + (t-1)x_0)}, \end{aligned} \quad (4.17)$$

where

$$\begin{aligned} \eta(x_0, v, t) &= \kappa^2 - nt v^2 x_0^2(\gamma + n)(\kappa + (t-1)x_0)^2 \\ &\quad + v(x_0(x_0((t-1)x_0(-2(\kappa + \beta) + t(2\alpha + 2\beta + 1) - (t-1)x_0) \\ &\quad - \kappa(5\beta + \kappa + t(\alpha(t-2) + \beta(t-6) - 1))) \\ &\quad - 2\beta\kappa^2(t-2) - \beta\kappa^3) + 2\kappa(t-2)x_0 - 3(t-1)x_0^2). \end{aligned} \quad (4.18)$$

Remark 4.9. The birational transformation between \tilde{S}_t and S_t is

$$\begin{aligned} \tilde{S}_t &\dashrightarrow S_t \\ (x_0, v) &\longmapsto \left(x_0, \frac{-y_0}{v(\kappa + x_0(t-1 - ty_0))}, \frac{-1}{v(\kappa + x_0(t-1 - ty_0))} \right) \end{aligned} \quad (4.19)$$

and it has inverse

$$\begin{aligned} S_t &\dashrightarrow \tilde{S}_t \\ (x, y, z) &\longmapsto \left(x_0, \frac{1}{x(ty - tz + z) - \kappa z} \right). \end{aligned} \quad (4.20)$$

Now, Theorem 3.2 implies that given a solution (f, g) of system (2.14) with parameters chosen according to (3.9), the triple x, y, z defined by

$$\begin{aligned} x &= \frac{\kappa(f-1)}{(t-1)}, \\ y &= \frac{(f^2 - g(1+t))(\alpha + n - g)^2 + t(\alpha - g)(\kappa - 1 - g) - g(\alpha + n - g)(\gamma + \beta)}{(\kappa - 1)t}, \\ z &= \frac{(f-1)\left(f^2(\alpha + n - g)^2 + tg(g - \alpha) - f(g - \alpha - n)((n + \gamma) - (1-t) - t\alpha + (t+1)g)\right)}{(t-1)(\kappa - 1)f}, \end{aligned} \quad (4.21)$$

is a solution of the system (1.1) lying on S_t , and we have

$$f = \frac{\kappa + (t-1)x}{\kappa}, \quad g = n + \alpha + \frac{\kappa((\kappa + (t-1)x)z - tx(n+y))}{(t-1)(\kappa - x)x}. \quad (4.22)$$

Note that the birational transformations

$$\begin{aligned} \mathbb{C}_t^2 &\overset{\Psi}{\dashrightarrow} S_t & S_t &\overset{\Phi}{\dashrightarrow} \mathbb{C}_t^2 \\ (f, g) &\longmapsto (x, y, z) & (x, y, z) &\longmapsto (f, g) \end{aligned} \quad (4.23)$$

defined in (4.21) and (4.22) are inverse to each other, i.e. they satisfy

$$\Phi \circ \Psi = \text{Id}_{\mathbb{C}_t^2} \text{ and } \Psi \circ \Phi = \text{Id}_{S_t}. \quad (4.24)$$

Summing up, we obtain the following equivalence between system (4.17) and the Hamiltonian form of P_{VI} , which is part of Theorem I.

Theorem 4.10. *The systems (4.17) and (2.14) are related by the change of variables*

$$f = \frac{(t-1)x_0 + \kappa}{\kappa}, \quad g = \frac{\kappa + x_0 v ((\alpha + n)(x_0(t-1) + \kappa) - \alpha t \kappa)}{(t-1)x_0(x_0 - \kappa)v}, \quad (4.25)$$

with parameters identified in the same way as in Theorem 3.2, i.e. according to

$$a_0 = -\gamma, \quad a_1 = \kappa, \quad a_2 = -n - \alpha, \quad a_3 = -\beta, \quad a_4 = \alpha. \quad (4.26)$$

Remark 4.11. The change of variables inverse to (4.25) is

$$x_0 = \frac{\kappa(f-1)}{(t-1)}, \quad v = -\frac{1-t}{\kappa(f-1)(f(\alpha+n-g) + t(g-\alpha))}. \quad (4.27)$$

Remark 4.12. The transformations to the KNY Hamiltonian form (2.14) from system (3.1) in Theorem 3.2 and from system (4.17) in Theorem 4.10 lead to the following relation between the two parametrisations:

$$\tilde{x} = x_0, \quad \tilde{y} = \frac{2 + v((t-1)x_0^2 + (\kappa + \beta - t(\alpha + \beta + 1))x_0 - \beta\kappa)}{t(t-1)v}. \quad (4.28)$$

4.4. Space of initial conditions. We now turn to the problem of constructing the space of initial conditions for the system (4.17). For the sake of readability, first we rescale the variable x_0 as $x_0 \rightarrow \kappa x_0$ in system (4.17), and abuse notation rather than introduce a new symbol. Then, for convenience we compactify the parametrisation to the first *Hirzebruch surface* \mathbb{F}_1 [43] instead of the more common compactification to $\mathbb{P}^1 \times \mathbb{P}^1 = \mathbb{F}_0$, see Section 2.3.

Following, for instance, [83] the surface \mathbb{F}_1 can be defined as the gluing of four affine charts with coordinates:

$$\left\{ \begin{aligned} (\xi_0, v_0) &= \left(\frac{1}{\xi_1}, \xi_1 v_1 \right) = \left(\frac{1}{\xi_2}, \frac{\xi_2}{v_2} \right) = \left(\xi_3, \frac{1}{v_3} \right) \\ (\xi_1, v_1) &= \left(\frac{1}{\xi_0}, \xi_0 v_0 \right) \\ (\xi_2, v_2) &= \left(\frac{1}{\xi_0}, \frac{1}{\xi_0 v_0} \right) \\ (\xi_3, v_3) &= \left(\xi_0, \frac{1}{v_0} \right). \end{aligned} \right. \quad (4.29)$$

Notice that, in (4.29), we have given some transition functions of the given atlas. Note also that the lines $C_+ = \{v_2 = 0\} \cup \{v_3 = 0\}$ and $C_- = \{v_0 = 0\} \cup \{v_1 = 0\}$ have self intersection 1 and -1 respectively, see Section 2.3. This can be seen by noting that the union of the first and the second chart (resp. the third and the fourth chart) is isomorphic to the total space of the line bundle $\mathcal{O}_{C_+}(1)$ (resp. $\mathcal{O}_{C_-}(-1)$), see Section 2.3.

Let us rewrite the system (4.17) in terms of the coordinates of the zeroth chart of \mathbb{F}_1 via $(x_0, v) = (\xi_0, v_0)$:

$$\begin{aligned}\xi_0' &= \frac{v_0(\xi_0(\beta + \kappa - t(\alpha + \beta + 1) + (t-1)\xi_0) - \beta\kappa) + 2}{(t-1)tv_0}, \\ v_0' &= -\frac{\eta(\xi_0, v_0, t)}{(t-1)t\xi_0(\kappa - \xi_0)(\kappa + (t-1)\xi_0)},\end{aligned}\tag{4.30}$$

where $\eta(\xi_0, v_0, t)$ is the function in (4.18) evaluated at $(x_0, v, t) = (\xi_0, v_0, t)$.

Then, the system (4.30) has the following indeterminacy points:

$$\begin{aligned}\pi_1 : (\xi_3, v_3) &= (0, 0), & \pi_2 : (\xi_3, v_3) &= (0, \kappa\beta), \\ \pi_3 : (\xi_3, v_3) &= (1, -tn), & \pi_4 : (\xi_3, v_3) &= (1, -(\gamma + n)t), \\ \pi_5 : (\xi_3, v_3) &= \left(-\frac{1}{t-1}, 0\right), & \pi_6 : (\xi_3, v_3) &= \left(-\frac{1}{t-1}, -\frac{t\alpha}{t-1}\right) \\ \pi_7 : (\xi_1, v_1) &= (0, 0).\end{aligned}\tag{4.31}$$

The first six are contained in the third chart and resolved after a single blow up, while indeterminacy point π_7 is located at the origin of the first chart and it requires one further blow up to be resolved.

Adopting the same notation as in Section 3, we denote by (u_i, v_i) and (U_i, V_i) the coordinate charts covering the exceptional divisor over the point π_i , for $i = 1, \dots, 7$, see (3.5). In these coordinates, the eighth indeterminacy point is given by:

$$\pi_8 : (u_7, v_7) = (\kappa(1-t), 0).\tag{4.32}$$

After blowing up the point π_8 we get a surface X_t whose configuration of (-2) -curves $D_{t,i}$, for $i = 0, \dots, 4$ is depicted in the bottom picture in Figure 4. Precisely, they intersect according to the $D_4^{(1)}$ configuration associated with P_{VI} and their union $D_t = \bigcup_{i=0}^4 D_{t,i}$ is the inaccessible divisor. After removing D_t from X_t , we get the space E over B , with fibre $E_t = X_t \setminus D_t$, of which the system defines a uniform foliation.

Note that the surface obtained after blowing up the eight points π_i , $i = 1, \dots, 8$ is minimal, in the sense of Definition 2.14. Theorem 4.10 provides an isomorphism between X constructed from system (4.17) and X^{KNY} in Appendix A.

Remark 4.13. We observe that we could resolve the indeterminacy points of the system (4.17) considering the more common compactification $\mathbb{F}_0 = \mathbb{P}^1 \times \mathbb{P}^1$. However, in this particular case we have to underline that compactifying the system (4.17) inside \mathbb{F}_0 present an additional difficulty: *a seemingly infinite cascade* of indeterminacy points. This fact underlines again the importance of the choice of compactification: albeit the final results will be equivalent upon minimisation, the number of steps to reach it can be different. See Appendix C for an extended discussion of this phenomenon and its solution.

5. HAMILTONIAN STRUCTURE OF THE 3D SYSTEM ON THE HYPERSURFACE

In this section we construct the Hamiltonian structures of the system (1.1) of differential equations restricted to the hypersurface (1.2), as considered in Sections 3 and 4. In Theorem 3.2 and Theorem 4.10 we identified the systems (3.1) and (4.17) with a Hamiltonian form of the sixth Painlevé equation. The systems having as spaces of initial conditions the ones constructed in Sections 3.2 and 4.4 and system (2.14) from [45] are related by a birational equivalences of the associated surfaces with X_t^{KNY} after

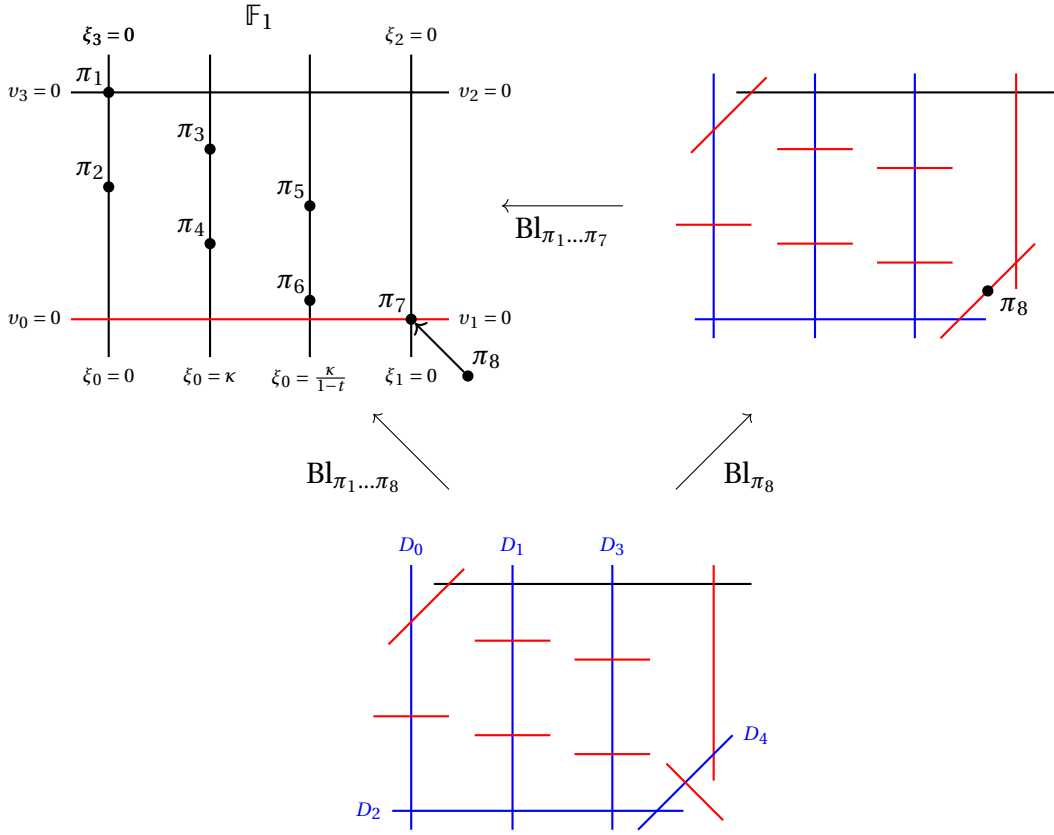

FIGURE 4. Sequence of blow ups and surface for system (4.17) with \mathbb{F}_1 compactification, with (-1) -curves in red and (-2) -curves in blue.

appropriate matching of parameters, see Appendix A. Moreover, the birational transformations relating them allow us to pull back the Hamiltonian atlas in Appendix A from E^{KNY} to the respective manifolds. Then, both systems have a global Hamiltonian structure, which is exactly that of the sixth Painlevé equation. We will present this structure in Proposition 5.5 which is part of Theorem I of the Introduction.

Remark 5.1. The systems in the coordinates (\tilde{x}, \tilde{y}) and (x_0, v) , in (3.1) and (4.17) respectively, do not have a local Hamiltonian structure, because the symplectic form associated with the anti-canonical divisor is t -dependent when written in these charts. We expand on this in the next section.

5.1. Local Hamiltonian structures. In this subsection we provide a local Hamiltonian structure for the second system (4.17) by considering the compactification \mathbb{F}_1 . A similar approach also works for the first system (3.1), as we will explain at the end of this subsection.

In the chart (x_0, v) the rational two-form ω_t providing the anti-canonical divisor D_t as its divisor of poles is given by

$$\omega_t = \frac{k d_t x_0 \wedge d_t v}{x_0(x_0 - \kappa)((1-t)x_0 - \kappa)v^2}, \quad (5.1)$$

uniquely up to the non-zero constant $k \in \mathbb{C}^*$. Indeed, in these coordinates we cannot find a local Hamiltonian structure for the system (4.17) with respect to ω_t , because of the t -dependence in (5.1). That is, there is no function $H(x_0, v, t)$ rational in x_0 and v

with coefficients analytic in t such that system (4.17) is written as

$$\frac{\kappa x_0'}{x_0(x_0 - \kappa)((1-t)x_0 - \kappa)v^2} = \frac{\partial H}{\partial v}, \quad \frac{\kappa v'}{x_0(x_0 - \kappa)((1-t)x_0 - \kappa)v^2} = -\frac{\partial H}{\partial x_0}. \quad (5.2)$$

Indeed, equations (5.2) are incompatible when regarded as a pair of partial differential equations for H , i.e. $\frac{\partial^2 H}{\partial x_0 \partial v} \neq \frac{\partial^2 H}{\partial v \partial x_0}$.

Therefore, for the system (4.17) we aim to find coordinates in which the symplectic form is t -independent.

Recall the atlas for the Hirzebruch surface $\mathbb{F}_1 \cong \text{Bl}_p \mathbb{P}^2$ as in the previous section, i.e. the four charts (ξ_i, v_i) , for $i = 0, 1, 2, 3$, with gluing defined by (4.29).

Again regarding the variables x_0 and v from the system (4.17) as the coordinates for the chart (ξ_0, v_0) via $\xi_0 = x_0$, $v_0 = v$, the rational two-form (5.1) is written in these coordinates as

$$\omega_t = \frac{k d_t \xi_0 \wedge d_t v_0}{\xi_0(\xi_0 - \kappa)((1-t)\xi_0 - \kappa)v_0^2}, \quad (5.3)$$

where k is possibly t -dependent and will be chosen appropriately later. We need to remedy the t -dependence in the factor $((1-t)\xi_0 - \kappa)$, and we do this by obtaining a change of our atlas for \mathbb{F}_1 such that the problematic t -dependent divisor is not visible in one of the new charts, and in this chart the system will have a local Hamiltonian structure. We represent this procedure to find the coordinate change in Figure 5.

First contract the (-1) -curve C_- on \mathbb{F}_1 , with local equations $v_0 = 0$, $v_1 = 0$, to get \mathbb{P}^2 , denoting by $\pi: \mathbb{F}_1 \rightarrow \mathbb{P}^2$ the contraction, see Remark 2.8. For \mathbb{P}^2 take the following homogeneous coordinates

$$[Z_0 : Z_1 : Z_2] = [\xi_0 v_0 : v_0 : 1] = [v_1 : \xi_1 v_1 : 1] \quad (5.4)$$

so that the point $p = \pi(C_-)$ is at the origin in the coordinates

$$(r, s) = \left(\frac{Z_0}{Z_2}, \frac{Z_1}{Z_2} \right) = (\xi_0 v_0, v_0) = (v_1, \xi_1 v_1). \quad (5.5)$$

The two-form (5.3) pushed forward under π is then given by

$$\pi_*(\omega_t) = \frac{k d_t r \wedge d_t s}{r(r - \kappa s)((1-t)r - \kappa s)}. \quad (5.6)$$

Consider the linear system of lines in \mathbb{P}^2 passing through p , which is written in coordinates

$$\mathcal{L} = \{L_\lambda : \lambda_0 Z_0 + \lambda_1 Z_1 = 0 \mid \lambda = [\lambda_0 : \lambda_1] \in \mathbb{P}^1\} \cong \mathbb{P}^1. \quad (5.7)$$

The poles of $\pi_*(\omega_t)$ then correspond to the lines

$$L_{[1:0]} = \{Z_0 = 0\}, \quad L_{[1:-\kappa]} = \{Z_0 = \kappa Z_1\}, \quad L_{[t-1:\kappa]} = \{(1-t)Z_0 = \kappa Z_1\}. \quad (5.8)$$

We look for a change of homogeneous coordinates for \mathbb{P}^2 , say

$$[Z_0 : Z_1 : Z_2] \leftrightarrow [\hat{Z}_0 : \hat{Z}_1 : \hat{Z}_2], \quad (5.9)$$

corresponding to a Möbius transformation of \mathcal{L} , that fixes the origin in the (r, s) chart as well as the line at infinity $\{Z_2 = 0\}$. We want this to be such that in the linear system

$$\{\hat{L}_{\hat{\lambda}} : \hat{\lambda}_0 \hat{Z}_0 + \hat{\lambda}_1 \hat{Z}_1 = 0 \mid \hat{\lambda} = [\hat{\lambda}_0 : \hat{\lambda}_1] \in \mathbb{P}^1\} \quad (5.10)$$

the lines on which the two-form has poles are given by

$$\hat{L}_{[1:0]} = \{\hat{Z}_0 = 0\}, \quad \hat{L}_{[1:-1]} = \{\hat{Z}_0 = \hat{Z}_1\}, \quad \hat{L}_{[0:1]} = \{\hat{Z}_1 = 0\}. \quad (5.11)$$

A direct calculation shows that this is achieved by a change of coordinates

$$\begin{aligned} Z_0 &= A\hat{Z}_0, & \hat{Z}_0 &= \frac{1}{A}Z_0, \\ Z_1 &= \frac{A}{\kappa}((1-t)\hat{Z}_0 + t\hat{Z}_1), & \hat{Z}_1 &= \frac{1}{At}((t-1)Z_0 + \kappa Z_1), \\ Z_2 &= B\hat{Z}_2, & \hat{Z}_2 &= \frac{1}{B}Z_2, \end{aligned} \quad (5.12)$$

where A, B are nonzero and possibly t -dependent, and will be chosen appropriately below. Now, taking the coordinates $(\hat{r}, \hat{s}) = \left(\frac{\hat{Z}_0}{\hat{Z}_2}, \frac{\hat{Z}_1}{\hat{Z}_2}\right)$, we blow up the origin $(\hat{r}, \hat{s}) = (0, 0)$ reaching a new copy of \mathbb{F}_1 . The projection $\hat{\pi} : \mathbb{F}_1 \rightarrow \mathbb{P}^2$ is given in coordinates by $\hat{\pi} : (\hat{\xi}_0, \hat{v}_0) \mapsto (\hat{r}, \hat{s}) = (\hat{\xi}_0\hat{v}_0, \hat{v}_0)$, and we have the new coordinates $(\hat{\xi}_i, \hat{v}_i)$, $i = 0, 1, 2, 3$, defined by

$$\hat{\xi}_0 = \frac{t\xi_0}{\kappa + (t-1)\xi_0}, \quad \hat{v}_0 = \frac{B}{At}v_0(\kappa + (t-1)\xi_0), \quad (5.13)$$

and the remaining $\hat{\xi}_i, \hat{v}_i$ with the same gluing as before, i.e. (4.29) with hats.

By design, the problematic t -dependent pole of ω_t is not visible in the chart $(\hat{\xi}_0, \hat{v}_0)$. Indeed, we have

$$\omega_t = \frac{-B}{A\kappa t} \frac{kd_t\hat{\xi}_0 \wedge d_t\hat{v}_0}{\hat{\xi}_0(\hat{\xi}_0 - 1)\hat{v}_0^2}, \quad (5.14)$$

so we choose $A = 1$, $B = \kappa t$. We also choose $k = \kappa$ for neater matching with the Hamiltonian system for (f, g) through Theorem 4.10, but this is without loss of generality. Then the system becomes Hamiltonian in these coordinates as follows.

Proposition 5.2. *In the coordinates*

$$\hat{\xi}_0 = \frac{t\xi_0}{\kappa + (t-1)\xi_0}, \quad \hat{v}_0 = \kappa v_0(\kappa + (t-1)\xi_0), \quad (5.15)$$

the system (4.17) has a local Hamiltonian structure with respect to ω_t . Explicitly,

$$\begin{aligned} \frac{\kappa\hat{\xi}'_0}{\hat{\xi}_0(1-\hat{\xi}_0)\hat{v}_0^2} &= \frac{\partial H}{\partial \hat{v}_0}, & \frac{\kappa\hat{v}'_0}{\hat{\xi}_0(1-\hat{\xi}_0)\hat{v}_0^2} &= -\frac{\partial H}{\partial \hat{\xi}_0}, \\ H &= \frac{\kappa(\beta\hat{v}_0 - \kappa)}{(t-1)\hat{\xi}_0\hat{v}_0^2} + \frac{(\kappa + n\hat{v}_0)(\kappa + (n+\gamma)\hat{v}_0)}{t(t-1)(1-\hat{\xi}_0)\hat{v}_0^2} + \frac{\alpha\kappa}{t\hat{v}_0}. \end{aligned} \quad (5.16)$$

This Hamiltonian structure coincides with that of the KNY form (2.14) of P_{VI} under the identification in Theorem 4.10. The identification induces a birational transformation $\varphi : \mathbb{C}^2 \times B \dashrightarrow \mathbb{C}^2 \times B$, for $B = \mathbb{C} \setminus \{0, 1\}$, defined in coordinates $(\hat{\xi}_0, \hat{v}_0; t) \mapsto (f, g; t)$ explicitly as

$$\hat{\xi}_0 = \frac{t(f-1)}{(t-1)f}, \quad \hat{v}_0 = \frac{\kappa(t-1)f}{(f-1)(f(\alpha+n-g) + t(g-\alpha))}, \quad (5.17)$$

or conversely

$$f = \frac{t}{t - (t-1)\hat{\xi}_0}, \quad g = \frac{t\kappa + \hat{\xi}_0(\kappa(1-t) + (n+\alpha(t-1)(\hat{\xi}_0-1))\hat{v}_0)}{(t-1)(\hat{\xi}_0-1)\hat{\xi}_0\hat{v}_0}. \quad (5.18)$$

Under φ we have the equality of rational two-forms

$$\varphi^*(\omega^{\text{KNY}} + dH_{VI}^{\text{KNY}} \wedge dt) = \omega + dH \wedge dt, \quad (5.19)$$

where

$$\omega^{\text{KNY}} = \frac{df \wedge dg}{f}, \quad \omega = \frac{\kappa d\hat{\xi}_0 \wedge d\hat{v}_0}{\hat{\xi}_0(1-\hat{\xi}_0)\hat{v}_0^2}, \quad (5.20)$$

and $H_{\text{VI}}^{\text{KNY}}$ is given by (2.18).

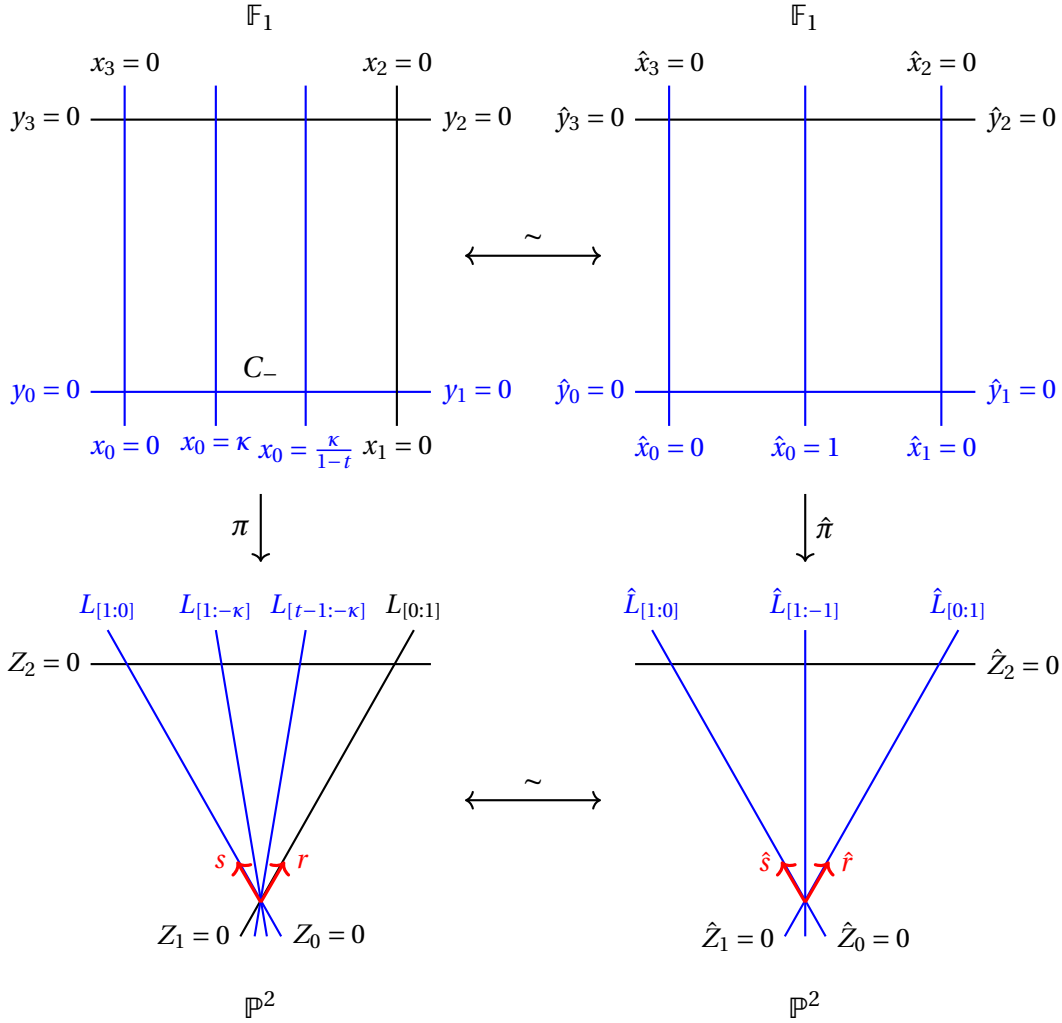

FIGURE 5. Coordinate change for \mathbb{F}_1 in order to obtain a local Hamiltonian structure for system (4.17), with locations of poles of ω_t in blue.

A similar trick can be employed in the case of system (3.1) in the first parametrisation studied in Section 3, to obtain coordinates, related in a relatively simple way to \tilde{x}, \tilde{y} , in which the system (3.1) has a local Hamiltonian structure.

Recall the sequence of blow ups and blow downs performed to construct a minimal space of initial conditions for system (3.1) from the $\mathbb{P}^1 \times \mathbb{P}^1$ compactification, as shown in Figure 3. In this case the rational two-form with respect to which the Hamiltonian structure should be defined is given in coordinates \tilde{x}, \tilde{y} by

$$\omega_t = \frac{k d_t \tilde{x} \wedge \tilde{y}}{\tilde{x}(\tilde{x} - \kappa)((1-t)\tilde{x} - \kappa)}, \quad (5.21)$$

again unique up to the choice of the possibly t -dependent constant k . This is similar to the two-form considered above in the (x_0, ν) -chart as in (5.1), but with the $\mathbb{P}^1 \times \mathbb{P}^1$ compactification this has not only poles along the lines $\{\tilde{x} = 0\}$, $\{\tilde{x} = \kappa\}$ and $\{\tilde{x} = \frac{\kappa}{1-t}\}$, but also zeroes along $\{\tilde{x} = \infty\}$. These zeroes are an artifact of the contractions $\text{Bl}_{p_{12}} \circ \text{Bl}_{p_{11}}$ as in Figure 3 required to arrive at a minimal space of initial conditions on which the two-form has only poles.

The problematic t -dependent factor $((1-t)\tilde{x} - \kappa)$ in the two-form (5.21) can be dealt with by a combination of elementary transformations and the same trick as above. After the blow up of $\mathbb{P}^1 \times \mathbb{P}^1$ centred at $p_7 : (\tilde{x}, \tilde{y}) = (\infty, \infty)$, if we contract the proper transform of the line $\{\tilde{x} = \infty\}$ we arrive at a copy of \mathbb{F}_1 , i.e. we have performed an elementary transformation $\mathbb{P}^1 \times \mathbb{P}^1 = \mathbb{F}_0 \dashrightarrow \mathbb{F}_1$ as in Figure 2. Then we are in a similar situation to that considered above, with three lines along which the two-form has poles, one of which is t -dependent. We make a coordinate change for \mathbb{F}_1 then go back to $\mathbb{P}^1 \times \mathbb{P}^1$ via another elementary transformation. The result is the following counterpart to Proposition 5.2.

Proposition 5.3. *After making the birational change of variables from (\tilde{x}, \tilde{y}) to (\hat{x}, \hat{y}) according to*

$$\hat{x} = \frac{t\tilde{x}}{\kappa + (t-1)\tilde{x}}, \quad \hat{y} = \frac{t(t-1)\tilde{y}}{2(\kappa + (t-1)\tilde{x})}, \quad (5.22)$$

the system (3.1) has a local Hamiltonian structure with respect to

$$\omega_t = \frac{d_t \hat{x} \wedge d_t \hat{y}}{\hat{x}(\hat{x}-1)}. \quad (5.23)$$

Explicitly, the system (3.1) after the change (5.22) reads

$$\frac{\hat{x}'}{\hat{x}(\hat{x}-1)} = \frac{\partial H}{\partial \hat{y}}, \quad \frac{\hat{y}'}{\hat{x}(\hat{x}-1)} = -\frac{\partial H}{\partial \hat{x}}, \quad (5.24)$$

where $H = H(\hat{x}, \hat{y}; t)$ is a Hamiltonian function, rational in its arguments, that can be computed explicitly.

Let us give more details of the geometric meaning of the transformation (5.22), as depicted in Figure 6. After arriving at the copy of \mathbb{F}_1 as explained above, we contract the (-1) -curve given in coordinates by $\{\tilde{y} = 0\} \cup \left\{ \frac{\tilde{x}}{\tilde{y}} = 0 \right\}$. We then arrive at \mathbb{P}^2 with homogeneous coordinates $[Z_0 : Z_1 : Z_2] = [1 : \tilde{x} : \tilde{y}]$, perform an appropriate change $[Z_0 : Z_1 : Z_2] \mapsto [\hat{Z}_0 : \hat{Z}_1 : \hat{Z}_2]$, then blow back up to \mathbb{F}_1 , similarly to in Figure 5. This provides a genuine change of atlas for \mathbb{F}_1 , with (\hat{x}, \hat{y}) as set of affine coordinates corresponding to (ξ_3, ν_3) in the atlas as shown in the top-left picture from Figure 4. We then perform the same steps in reverse, i.e. blow up the point $(\frac{1}{\tilde{x}}, \frac{\tilde{y}}{\tilde{x}}) = (0, 0)$, then contract the proper transform of the curve $\{\frac{1}{\tilde{x}} = 0\}$ to a point $\hat{p}_7 : (\hat{x}, \hat{y}) = (\infty, \infty)$. This leads to $\mathbb{P}^1 \times \mathbb{P}^1$ with (\hat{x}, \hat{y}) as an affine chart, and we regard the transformation $(\tilde{x}, \tilde{y}) \mapsto (\hat{x}, \hat{y})$ in (5.22) as a birational mapping between two copies of $\mathbb{P}^1 \times \mathbb{P}^1$. The problematic t -dependent line $\{\tilde{x} = \frac{\kappa}{1-t}\}$ is sent under this to \hat{p}_7 , so it is not visible in the (\hat{x}, \hat{y}) coordinates. This explains the form of the transformation (5.22), in particular the denominators of the rational functions giving \hat{x}, \hat{y} .

Remark 5.4. The propositions above can also be obtained analytically. However, an appropriate Ansatz is needed. For the system (4.17) in the second parametrisation one can search for a transformation in the form

$$\hat{\xi}_0 = \frac{f_1(t)\xi_0}{\kappa + (t-1)\xi_0}, \quad \hat{\nu}_0 = f_2(t)\nu_0(\kappa + (t-1)\xi_0)$$

with functions f_1 and f_2 to be determined. Notice that choosing $f_1(t) = t$ causes the factor $(t\hat{\xi}_0 - f_1)$ in the denominator of the rational expression for $\hat{\nu}'_0$ to factorise, and f_2 can be taken as a constant. Then the system for $\hat{\xi}_0$ and $\hat{\nu}_0$ can be written in

Hamiltonian form with respect to the two-form as above. For the system (3.1) in the first parametrisation, taking a similar Ansatz

$$\hat{x} = \frac{f_1(t)\tilde{x}}{\kappa + (t-1)\tilde{x}}, \hat{y} = \frac{f_2(t)\tilde{y}}{\kappa + (t-1)\tilde{x}}$$

and similar considerations yield $f_1(t) = t$. Then f_2 is chosen according to the compatibility condition of the pair of partial differential equations for the Hamiltonian function, which gives $(1-2t)f_2 + (t-1)tf_2' = 0$.

5.2. Global Hamiltonian structure. As remarked above, the identification of the system on the hypersurface in either parametrisation with the Okamoto Hamiltonian form of P_{VI} means that it inherits a global Hamiltonian structure on the space of initial conditions. Using the identifications in Theorem 3.2 and Theorem 4.10, the global Hamiltonian structure of P_{VI} in Appendix (A.2) is inherited by systems (3.1) and (4.17). This is the content of Proposition 5.5 which is part of Theorem I in the Introduction.

Proposition 5.5. *The coordinates (x_i, y_i) , $i = 0, 1, \dots, 5$, of the symplectic atlas in Proposition A.2 for E^{KNY} from the KNY Hamiltonian form of P_{VI} can be pulled back under the identification in Theorem 4.10 to provide a symplectic atlas for the space E constructed in Section 4 from the system in the second parametrisation (4.17).*

Similarly they can be pulled back under the identification in Theorem 3.2 to provide a symplectic atlas for the space constructed in Section 3 from the system in the first parametrisation (3.1).

Further, the system on the hypersurface in either parametrisation has a global Hamiltonian structure provided by the pullback of Ω^{KNY} in Corollary A.3 under the corresponding identification.

Proof. The proof consists of a direct check comparing the coordinates $(x_i, y_i; t)$ with those introduced according to the convention (3.5). This can be done using a computer algebra system, e.g. Maple [52] or Mathematica [54]. Concretely, note that the coordinates (x_0, y_0) from the symplectic atlas for E^{KNY} in Proposition A.2 are related to the variables (\tilde{x}, \tilde{y}) from system (3.1) via the identification in Theorem 3.2 by

$$\begin{aligned} x_0 &= 1 + \frac{(t-1)\tilde{x}}{\kappa}, \\ y_0 &= \frac{\kappa \left[(t-1)(\alpha - \beta - \gamma - 1)\tilde{x}^2 + \kappa(\beta\kappa + t(t-1)\tilde{y}) - \kappa(1 - \alpha + 2\beta + \gamma + t(\alpha - \beta - 1))\tilde{x} \right]}{2(t-1)\tilde{x}(\tilde{x} - \kappa)(\kappa - (t-1)\tilde{x})}, \end{aligned} \tag{5.25}$$

with the remaining coordinates (x_i, y_i) , $i = 1, \dots, 5$, related to \tilde{x}, \tilde{y} via the gluing in Proposition A.2 together with (5.25). It can be directly checked that these provide an atlas for E as constructed in Section 3.

Similarly the charts from the symplectic atlas are related to the variables (ξ_0, v_0) in system (4.17) via Theorem 4.10 by

$$\begin{aligned} x_0 &= 1 + \frac{(t-1)\xi_0}{\kappa}, \\ y_0 &= \frac{\kappa \left[\kappa + \kappa(n + \alpha - t\alpha)\xi_0 v_0 + (t-1)(\alpha + n)\xi_0^2 v_0 \right]}{(t-1)\xi_0(\xi_0 - \kappa)(\kappa + (t-1)\xi_0)v_0}, \end{aligned} \tag{5.26}$$

with the remaining coordinates (x_i, y_i) , $i = 1, \dots, 5$, related to ξ_0, v_0 via the gluing in Proposition A.2 together with (5.26). It can be directly checked that these provide an atlas for E as constructed in Section 4.

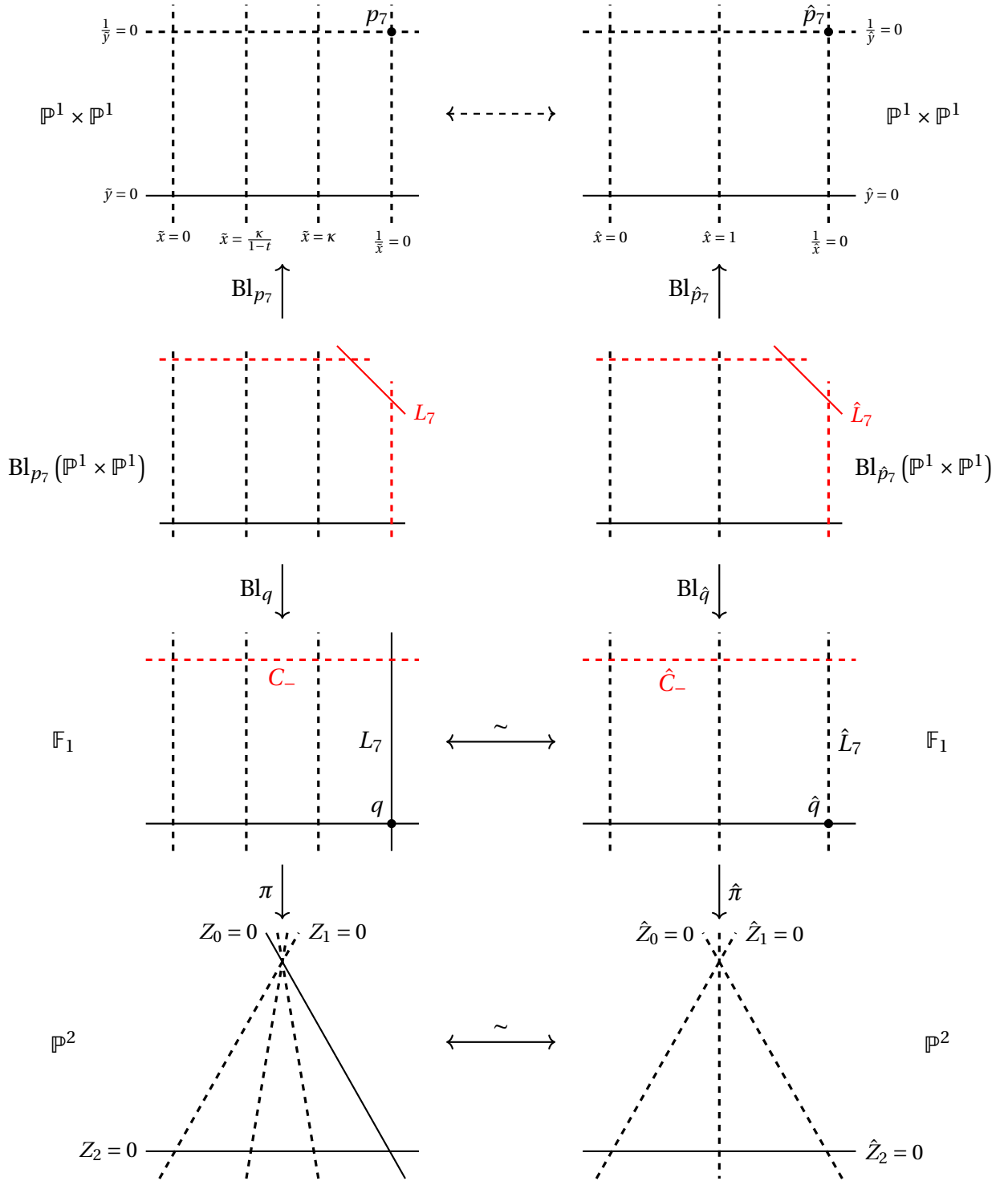

FIGURE 6. Construction of the birational map $\mathbb{P}^1 \times \mathbb{P}^1 \dashrightarrow \mathbb{P}^1 \times \mathbb{P}^1$, $(\tilde{x}, \tilde{y}) \mapsto (\hat{x}, \hat{y})$ in Proposition 5.3. (-1) -curves are coloured in red, and components of $\text{div}(\omega_t)$ are indicated by dashed lines.

□

6. AN AUTONOMOUS LIMIT OF THE SYSTEM OF THREE FIRST-ORDER DIFFERENTIAL EQUATIONS

In this section we examine in details an autonomous limit of the three-dimensional system (1.1) which reduces to autonomous, i.e. time-independent, system of three ODEs and we prove part of Theorem I in Proposition 6.8. In particular, we show the existence of an integrable autonomous limit whose orbits are elliptic curves. This suggests that the full three-dimensional system might possess the Painlevé property.

We recall that in the case of second-order Painlevé differential equations similar autonomous limits are integrable in terms of elliptic functions. The same is true in the case of discrete Painlevé equations whose autonomous limits, including QRT maps [68, 69], have spaces of initial conditions consisting of rational elliptic surfaces [6, 22, 86].

Remark 6.1. We remark that also the opposite procedure is possible, i.e. the deautonomisation of differential and difference equations. We recall the Painlevé α -test [13, 37, 88] for the continuous case, and the preservation of singularity patterns [37, 38] in the discrete setting. We just mention that those methods usually become unpractical for systems in dimension higher than two, due to the complexity of the calculations involved.

We start this section by reviewing some key tools to build the associated Poisson tensor and prove Liouville integrability for the autonomous system.

6.1. Construction of a Poisson bracket from first integrals. Recall that a system of (autonomous) first-order ODEs (4.1) is said to be *volume preserving* if there exists a volume form Ω , such that the Lie derivative of Ω along the vector field defined by the system vanishes. More explicitly, let $\mathbf{F}_t = \mathbf{F} = (F_1(\mathbf{x}), \dots, F_n(\mathbf{x}))$ be the right-hand side of (4.1). Then the associated vector field is:

$$\Gamma = \sum_{i=1}^n F_i(\mathbf{x}) \partial_{x_i}, \quad (6.1)$$

and a volume form has the coordinate expression $\Omega = w(\mathbf{x}) dx_1 \wedge \dots \wedge dx_n$. So, denoting by \mathcal{L}_Γ the Lie derivative, the condition of being volume preserving is $\mathcal{L}_\Gamma \Omega = 0$. In coordinates, one has the expression:

$$\mathcal{L}_\Gamma \Omega = \sum_{i=1}^n \frac{\partial}{\partial x_i} (w(\mathbf{x}) F_i(\mathbf{x})) = 0. \quad (6.2)$$

Remark 6.2. Throughout this section, when no confusion is possible, we omit the subscript t on a function not depending explicitly on time.

In what follows, we will make extensive use of the following results regarding autonomous systems.

Theorem 6.3 ([4, Proposition 3]). *Consider a system of autonomous first-order ODEs. Assume that:*

- *the system preserves the volume form Ω ;*
- *there exist I_1, \dots, I_{n-2} functionally independent first integrals.*

Then, choosing the n -multivector τ such that $\tau \lrcorner \Omega = 1$, the 2-tensor:

$$J = \tau \lrcorner dI_1 \lrcorner \dots \lrcorner dI_{n-2}, \quad (6.3)$$

is a Poisson tensor for the system of autonomous first-order ODEs.

In particular, in the case of integrable three-dimensional systems we have the following statement.

Corollary 6.4 ([4, Corollary 16]). *Consider a three-dimensional system of autonomous first-order ODEs. Assume that the system is integrable, in the sense that it admits two functionally independent first integrals I_1, I_2 , and a preserved volume Ω . Then, the system is multi-Poissonian with Poisson structures $J_1 = \tau \lrcorner dI_1$ and $J_2 = \tau \lrcorner dI_2$ where the n -multivector τ satisfies $\tau \lrcorner \Omega = 1$.*

The most delicate point in Theorem 6.3 is to find a preserved volume, a problem for which, in general, there is no finite algorithm. However, there are cases where an algorithmic construction is possible, as highlighted in the following result.

Lemma 6.5. *Consider a system of autonomous first-order ODEs. Let P be a Darboux function whose cofactor satisfies:*

$$C = \sum_{i=1}^n \frac{\partial F_i}{\partial x_i}. \quad (6.4)$$

Then, the volume form:

$$\Omega_P = \frac{1}{P(\mathbf{x})} dx_1 \wedge \dots \wedge dx_n \quad (6.5)$$

is preserved by the ODE system.

Proof. By the condition of volume invariance written as in equation (6.2) we have:

$$\mathcal{L}_\Gamma \Omega_P = \sum_{i=1}^n \frac{\partial}{\partial x_i} \left(\frac{F_i(\mathbf{x})}{P(\mathbf{x})} \right) = \frac{1}{P^2(\mathbf{x})} \sum_{i=1}^n \left(P(\mathbf{x}) \frac{\partial F_i}{\partial x_i} - F_i(\mathbf{x}) \frac{\partial P}{\partial x_i} \right). \quad (6.6)$$

Using the defining property of a Darboux function whose cofactor is given by (6.4) we obtain the vanishing of the last sum. This ends the proof. \square

6.2. Autonomous limit of P_{VI} . As noted above, constructing autonomous limits is in general a tricky task, as there is no algorithm for it. So, before proceeding to discuss autonomous limits of system (1.1), we review some known autonomous limits of P_{VI} .

One such limit is given for instance in [1, Eqs. (14), (15)]. In our notation, let the function $f(t)$ solve equation (2.13) with parameters A, B, C, D . Let us denote, with abuse of notation, by $f(s)$ the composition $f(a + \varepsilon s)$, for $a \neq 0, 1$. Then, fixing parameters

$$A = \frac{(a-1)^2 a^2 b}{\varepsilon^2}, \quad B = \frac{ac(a-1)^2}{\varepsilon^2}, \quad C = \frac{a^2 d(a-1)}{\varepsilon^2}, \quad D = \frac{ae(a-1)}{\varepsilon^2} \quad (6.7)$$

and taking the limit $\varepsilon \rightarrow 0$, the function $f(s)$ solves the so-called I_{49} equation, see [40], given by

$$f'' = \frac{1}{2} \left(\frac{1}{f-a} + \frac{1}{f} + \frac{1}{f-1} \right) (f')^2 + f(f-1)(f-a) \left(b + \frac{c}{f^2} + \frac{d}{(f-1)^2} + \frac{e}{(f-a)^2} \right). \quad (6.8)$$

Equation (6.8) can be solved in terms of elliptic functions. This equation is variational with the following Lagrangian:

$$L_{49} = \frac{(f')^2}{2f(f-1)(f-a)} - bf + \frac{e}{f-a} + \frac{d}{f-1} + \frac{c}{f} + \frac{d\Delta}{dt}, \quad (6.9)$$

where $\Delta = \Delta(t, f)$ is an arbitrary function (gauge function). It is worth mentioning that in [18] this Lagrangian is derived through the Jacobi Last Multiplier.

We can argue similarly with the two-dimensional differential system (2.14). Indeed, taking the same change of the independent variable $t = a + \varepsilon s$, scaling the dependent variables as $(f(t), g(t)) \rightarrow (f(s), g(s)/\varepsilon)$, and rescaling the parameters as

$$\alpha \rightarrow \frac{\tilde{\alpha}}{\varepsilon}, \quad \beta \rightarrow \frac{\tilde{\beta}}{\varepsilon}, \quad \gamma \rightarrow \frac{\tilde{\gamma}}{\varepsilon}, \quad n \rightarrow \frac{\tilde{n}}{\varepsilon} \quad (6.10)$$

in the limit $\varepsilon \rightarrow 0$ yields the following autonomous analogue of the two-dimensional differential system (2.14):

$$\begin{aligned} f' &= \frac{f(\tilde{\alpha}(a+1) - a\tilde{\beta} - \tilde{\gamma} + (\tilde{\gamma} + \tilde{\beta} - \tilde{\alpha})f) + 2(f-1)(f-a)g - \tilde{\alpha}a}{a(a-1)}, \\ g' &= -\frac{ag(g-\tilde{\alpha}) + f^2(\tilde{n} + \tilde{\alpha} - g)(\tilde{n} + \tilde{\beta} + \tilde{\gamma} + g)}{a(a-1)f}, \end{aligned} \quad (6.11)$$

where the differentiation is with respect to s . System (6.11) gives equation (6.8) with parameters:

$$b = \frac{\tilde{\kappa}^2}{2a^2(a-1)^2}, \quad c = -\frac{\tilde{\alpha}^2}{2a(a-1)^2}, \quad d = \frac{\tilde{\beta}^2}{2a^2(a-1)}, \quad e = -\frac{\tilde{\gamma}^2}{2a(a-1)}, \quad (6.12)$$

where

$$\tilde{\kappa} = \tilde{\alpha} + \tilde{\beta} + \tilde{\gamma} + 2\tilde{n}. \quad (6.13)$$

In fact the system (6.11) is still Hamiltonian with the same symplectic form as the original symplectic structure, see equation (2.17):

$$H_{49} = \frac{(g - \tilde{n} - \tilde{\alpha})(\tilde{n} + \tilde{\beta} + \tilde{\gamma} + g)f + ((\tilde{\alpha} - \tilde{\beta})a + \tilde{\alpha} - \tilde{\gamma} - (a+1)g)gf}{a(a-1)} + \frac{g(g-\tilde{\alpha})}{(a-1)f}, \quad (6.14)$$

see for instance (2.18). We observe that this Hamiltonian formalism does not arise as the one obtained from the variational formalism (6.9) (up to the additional gauge function).

Remark 6.6. The autonomous limit proposed in [1] is not the only possible one for the P_{VI} equation. For instance, in [42] the exponential-like limit $t \rightarrow 0$ was considered by replacing $t \rightarrow e^t$ and taking $e^t \rightarrow 0$. A similar reasoning can be done near $t = 1$. It is possible to take similar limits of the 3D system (1.1), but we will not give a full treatment of these two cases, since they are *singular*, i.e. the system collapses to a two-dimensional one. For the sake of completeness, a short description of the result obtained in such singular cases, is reported in Appendix D.

6.3. Integrable autonomous limit of system (1.1). Following the construction in [1] for P_{VI} with the scaling on the dependent variables:

$$\mathbf{x}(t) \rightarrow \frac{1}{\varepsilon} \mathbf{x}(s), \quad t = a + \varepsilon s, \quad (6.15)$$

and the scaling (6.10) of the parameters, the system (1.1) becomes:

$$\begin{aligned} x' &= \frac{(\tilde{\kappa} + \tilde{\beta} + 2ay - a(\tilde{\alpha} + \tilde{\beta}) - 2(a-1)z)x - \tilde{\kappa}(\tilde{\beta} + 2z) + (a-1)x^2}{(a-1)a}, \\ y' &= \frac{\left[a((a-1)\tilde{n}(\tilde{\gamma} + \tilde{n}) + ((a-1)\tilde{\gamma} + 2(a-1)\tilde{n} - \tilde{\alpha})y + ay^2)x^2 \right.}{a^2\tilde{\kappa}x} \\ &\quad \left. - ((a-1)x^2(a(\tilde{\gamma} + 2\tilde{n}) + \tilde{\beta} + 2ay) + \tilde{\beta}\tilde{\kappa}^2)z - (\tilde{\kappa}^2 - (a-1)^2x^2)z^2 \right], \\ z' &= \frac{ay'}{a-1}. \end{aligned} \quad (6.16)$$

This system is clearly autonomous. The associated hypersurface S_t degenerates to the following time-independent surface:

$$S_a = \{h_a(x, y, z) = 0\}, \quad (6.17)$$

where

$$h_a = axy((a\tilde{\gamma} + 2a\tilde{n} - \tilde{\alpha} - \tilde{\gamma} - 2\tilde{n} + ay - 2(a-1)z)x + \tilde{\kappa}(\tilde{\alpha} + \tilde{\gamma} + 2\tilde{n} - 2z)) \\ + (\tilde{\kappa} + (a-1)x)(x(a\tilde{n}(\tilde{\gamma} + \tilde{n}) - (a\tilde{\gamma} + 2a\tilde{n} + \tilde{\beta}))z + (a-1)z^2) + \tilde{\kappa}(\tilde{\beta} + z)z = 0. \quad (6.18)$$

Moreover, its defining polynomial h_a is still a Darboux polynomial, and it has cofactor:

$$C_a = \frac{(\tilde{\kappa} + \tilde{\beta} + 2ay - a(\tilde{\alpha} + \tilde{\beta}) - 2(a-1)z)x - \tilde{\kappa}(\tilde{\beta} + 2z) + (a-1)x^2}{(a-1)ax}. \quad (6.19)$$

Remark 6.7. We remark that in the singular limit $a \rightarrow 0$, the Darboux surface S_a becomes reducible:

$$S_0 = \{z(\tilde{\beta} + z)(\tilde{\kappa} - x)^2 = 0\}. \quad (6.20)$$

This already highlights why one has to carefully deal with the value of the parameters in the autonomous limits. A similar occurrence will be displayed in Appendix D while analysing other possible autonomous limits.

The existence of the Darboux polynomial is crucial in the proof of the following proposition which constitutes part of Theorem I in the Introduction.

Proposition 6.8. *The system (6.16) has the following properties:*

- (1) *it admits two functionally independent first integrals given by:*

$$\mathcal{I}_1 = ay - (a-1)z, \quad \mathcal{I}_2 = \frac{h_a(x, y, z)}{x}; \quad (6.21)$$

- (2) *it preserves the following volume forms:*

$$\Omega_a^{(1)} = \frac{dx \wedge dy \wedge dz}{x}, \quad \Omega_a^{(2)} = \frac{dx \wedge dy \wedge dz}{h_a(x, y, z)}; \quad (6.22)$$

- (3) *the level curves of the invariants form an elliptic fibration;*
 (4) *the system admits two pairs of Poisson structures, which we denote by $J_{a,j}^{(i)}$, for $i, j = 1, 2$.*

Proof. The two invariants in point (1) can be obtained as follows.

For \mathcal{I}_1 integrate the third equation in (6.16) with respect to s . While, for \mathcal{I}_2 note that the ratio of h_a and x is a first integral as both are Darboux polynomials with the same cofactor C_a , see equation (6.19).

Point (2) follows from Lemma 6.5. Indeed, the volume forms $\Omega_a^{(i)}$, for $i = 1, 2$, are obtained by noting that the cofactor C_a satisfies the condition of Lemma 6.5. As a consequence, again by Lemma 6.5, the system preserves both $\Omega_a^{(1)}$ and $\Omega_a^{(2)}$.

Let us now prove point (3). First, fix an admissible initial condition (x_0, y_0, z_0) . To it is assigned a value of the two first integrals $\mathcal{I}_1 = \iota_1$ and $\mathcal{I}_2 = \iota_2$ where $\iota_i = \iota_i(x_0, y_0, z_0)$. Since \mathcal{I}_1 is linear, we can solve it with respect to z and plug the solution into \mathcal{I}_2 . After

clearing the denominators we see that the variables (x, y) satisfy the following relation:

$$\begin{aligned}
& (\tilde{n}(\tilde{n} + \tilde{\gamma})a^2 - a\tilde{\kappa}y + ((\tilde{\kappa} + \iota_1 - \tilde{\alpha})\iota_1 - \tilde{n}(\tilde{n} + \tilde{\gamma}))a)(a-1)^2x^2 \\
& + 2 \left[((\tilde{\beta} + \tilde{\alpha})a - 2\iota_1 - \tilde{\kappa} - \tilde{\beta})\frac{a\tilde{\kappa}}{2}y + (\tilde{n} + \tilde{\gamma})\frac{\tilde{n}\tilde{\kappa}}{2}a^2 \right. \\
& \quad + \left((\tilde{\kappa} - \tilde{\beta})\left(\tilde{n} + \frac{\tilde{\gamma}}{2}\right)\iota_1 - \frac{\iota_1(\tilde{\beta} + \tilde{\alpha}) + \tilde{n}(\tilde{n} + \tilde{\gamma})}{2}\tilde{\beta} - \tilde{n}^3 \right. \\
& \quad \left. \left. - \frac{(\tilde{\alpha} + 3\tilde{\gamma})\tilde{n}^2 + \tilde{\gamma}(\tilde{\alpha} + \tilde{\gamma})\tilde{n} + \iota_2}{2} \right) a + \iota_1\tilde{\kappa}(\tilde{\beta} + \iota_1) + \frac{\iota_2}{2} \right] (a-1)x \\
& + (ay - \iota_1)(a\tilde{\beta} + ay - \tilde{\beta} - \iota_1)\tilde{\kappa}^2 = 0,
\end{aligned} \tag{6.23}$$

depending on ι_i , for $i = 1, 2$. Using the command `genus` from the Maple package `algcurves` [52] we check that the curve (6.23) has genus one, i.e. it is an elliptic curve. As a consequence, generically the level curves of \mathcal{S}_2 are elliptic curves possibly degenerating to singular ones. Indeed, the orbits of the system (6.16) are exactly given as the intersections of the planes $\{ay - (a-1)z = \iota_1\}$ with the hypersurface S_a . The fibration is given by varying the values of ι_1, ι_2 .

Finally, the proof of point (4) follows from Theorem 6.3 and Corollary 6.4 applied to the two volume forms $\Omega_a^{(i)}$ and the first integrals \mathcal{S}_i , for $i = 1, 2$. For instance, the Poisson structure associated to $\Omega_a^{(1)}$ and \mathcal{S}_1 , has the following matrix form:

$$J_{a,1}^{(1)} = -\frac{x}{6} \begin{pmatrix} 0 & a-1 & a \\ 1-a & 0 & 0 \\ -a & 0 & 0 \end{pmatrix}. \tag{6.24}$$

The other Poisson structures can be derived analogously and their explicit expressions are rather cumbersome. For this reason, and as their computation consists of a standard computer routine, we omit them. This ends the proof of the proposition. \square

Remark 6.9. We give some final remarks on Proposition 6.8.

- It is possible to prove points (1) and (3) also with a different approach. Indeed, after noting that the invariant \mathcal{S}_1 is trivial, one can use it to reduce immediately to a two-dimensional system. It is then straightforward to show that the system is variational with a Lagrangian of the form:

$$L = \frac{\mu(x)}{2}(x')^2 - V(x, \mathcal{S}_1). \tag{6.25}$$

Through E. Noether's theorem [57] one immediately gets the other invariant, and the statements follow.

- Using the construction in point (4), it is possible to find multiple Hamiltonian functions for the system (6.16). That is, we have:

$$\mathbf{x}' = J_{a,j}^{(i)} \nabla H_j^{(i)}, \tag{6.26}$$

where:

$$\begin{aligned}
H_1^{(1)} &= \frac{6}{a^2(a-1)\tilde{\kappa}} \mathcal{S}_2, & H_1^{(2)} &= \frac{6}{a^2(a-1)\tilde{\kappa}} \log \mathcal{S}_2, \\
H_2^{(1)} &= -\frac{6}{a^2(a-1)\tilde{\kappa}} \mathcal{S}_1, & H_2^{(2)} &= -\frac{6}{a^2(a-1)\tilde{\kappa}} \frac{\mathcal{S}_1}{\mathcal{S}_2}.
\end{aligned} \tag{6.27}$$

6.4. Projection of the autonomous limit in 2D. We conclude this section showing that we can restrict the three-dimensional autonomous system (6.16) to an autonomous system in 2D. Indeed, the autonomous versions of the transformations (4.21) and (4.22) are

$$\begin{aligned} x &= \frac{\tilde{\kappa}(f-1)}{a-1}, \\ y &= \frac{\left[f^2(\tilde{n} + \tilde{\alpha} - g)^2 + a(\tilde{\alpha} - g)(\tilde{\kappa} - g) - f(\tilde{n} + \tilde{\alpha} - g)(\tilde{n}(a+1) + \tilde{\alpha}(a+1) + \tilde{\beta} + a\tilde{\gamma} - (a+1)g) \right]}{a\tilde{\kappa}}, \\ z &= \frac{(f-1) \left[f^2(\tilde{n} + \tilde{\alpha} - g)^2 - f(\tilde{n} + \tilde{\alpha} - g)((a-1)\tilde{n}) + ag(g - \tilde{\alpha}) + a\tilde{\alpha} + (a-1)\tilde{\gamma} - (a+1)g \right]}{\tilde{\kappa}(a-1)f} \end{aligned} \quad (6.28)$$

and

$$f = \frac{(a-1)x}{\tilde{\kappa}} + 1, \quad g = \tilde{n} + \tilde{\alpha} + \frac{\tilde{\kappa}((\tilde{\kappa} + (a-1)x)z - ax(\tilde{n} + y))}{(a-1)x(\tilde{\kappa} - x)}, \quad (6.29)$$

respectively. We stress the fact that they establish a birational equivalence between S_a and the affine plane.

The associated system is as follows:

$$\begin{aligned} f' &= \frac{(\tilde{\beta} - \tilde{\alpha} + \tilde{\gamma} + 2g)f^2 + ((\tilde{\alpha} - \tilde{\beta})a - 2(a+1)g + \tilde{\alpha} - \tilde{\gamma})f - a(\tilde{\alpha} - 2g)}{(a-1)a}, \\ g' &= \frac{(\tilde{n} + \tilde{\alpha} - g)(\tilde{n} + \tilde{\beta} + \tilde{\gamma} + g)f^2 - ag(\tilde{\alpha} - g)}{(a-1)af}. \end{aligned} \quad (6.30)$$

The system keeps integrability, because the invariant \mathcal{I}_1 upon substitution of (6.28) becomes (up to an inessential multiplicative factor and an additive constant):

$$\begin{aligned} (a-1)a\tilde{\mathcal{I}}_1 &= (g - \tilde{n} - \tilde{\alpha})(\tilde{n} + \tilde{\beta} + \tilde{\gamma} + g)f - (a+1)g^2 \\ &\quad + (a(\tilde{\alpha} - \tilde{\beta}) + \tilde{\alpha} - \tilde{\gamma})g + \frac{ag(g - \tilde{\alpha})}{f}, \end{aligned} \quad (6.31)$$

which is a first integral for the system (6.29). Moreover, the first integral (6.31) is a Hamiltonian function for the system (6.29) with respect to the same symplectic form as the original symplectic structure, see equation (2.17).

7. CONCLUSIONS

In this paper, we studied the 3D system of first-order differential equations (1.1). This system is constrained on an invariant hypersurface (1.2) obtained from the results of [56] on the asymptotic expansion as $z \rightarrow \infty$ of the coefficients of ladder operators for degenerate Jacobi unitary polynomials.

We showed in Sections 3 and 4 that this system can be restricted to a 2D system of first-order differential equations in two different ways. In both cases, we were able to reduce these systems to the standard Hamiltonian form of the sixth Painlevé equation. Then, we turned to the study of an autonomous version of the 3D system and found out that it admits many properties akin to the equations of Painlevé type. This justifies Conjecture 1 about the non-autonomous 3D system.

From our perspective, the main ideas behind our work are the following two:

- (1) in some cases, it can be easier to derive higher-dimensional differential equations from the theory of orthogonal polynomials, together with appropriate invariant surfaces, rather than looking directly for 2D systems;
- (2) the relation between the obtained higher-dimensional systems and the Painlevé equations can be obtained through parametrisation of the invariant surface followed by the application of the geometric theory of Painlevé equations.

However, both points raise several further open and very interesting general questions, which we will outline in the following paragraphs.

First of all, for our result it is crucial that we are able to parametrise the hypersurface. As far we are aware, this is a very complicated problem in algebraic geometry named the *rationality problem*, see [66]. For smooth surfaces in \mathbb{C}^3 , there is a classical criterion, known as the *Castelnuovo criterion* [7], which characterises the rationality of the surface. Practical algorithms to construct the parametrisation were introduced only recently in [76]. In the case of singular surfaces we are not aware neither of the existence of a general rationality criteria, nor of algorithms capable of producing a parametrisation. These two are clearly challenging problems that could be addressed in the context of algebraic geometry and computational algebra.

Another open problem, is whether the construction of a space of initial conditions for the general 3D system (1.1) is possible, see Conjecture 1. Indeed, despite the success obtained with autonomous limits, the problem in three dimensions is much harder. The difficulty of this problem can be understood also by considering the step that we made to obtain a parameterisation in Section 4. The choice of the “good” compactification therein made was not evident at all. The same consideration applies to the choice of compactification to make for the full system. From some preliminary computations, we assess that choosing different compactifications presents a sort of trade-off between the number of charts and the number of singularities. To be more specific, compactifying the system (1.1) to $(\mathbb{P}^1)^{\times 3}$ gives rise to a “less singular” system in comparison to the choice of compactifying it to \mathbb{P}^3 . The picture is also complicated by the presence of indeterminacies of different natures, i.e. points and potentially intersecting lines, rather than just points as in the two-dimensional case. In Figure 7 are depicted the configurations of the indeterminacies of the system with respect two different compactifications. Another complication is a consequence of the fact that the counterparts of minimal surfaces for threefolds are in general singular [71]. A complete geometric study of these singularities, their resolution, and the precise relationship with the ones of the two-dimensional system will be the object of further research.

In general, we hope that this kind of research on the geometry of the three-dimensional systems could pave the way to a theory similar to the one of Okamoto-Sakai for two-dimensional systems. Indeed, a classification of Painlevé-like equations in three or more components via spaces of initial conditions is currently lacking, though sporadic examples are known in the literature, see for instance [14–16, 33, 59, 80]. The reason for this absence is that systems with three or more components exhibit a more complicated and varied behavior than two-dimensional ones, as highlighted by Chazy’s equation, which possesses a movable singularity that serves as a natural boundary for its solutions [9, 10]. In particular, we expect that a geometric description of Painlevé-like equations in higher dimensions may be used to classify differential equations reducible to Painlevé equations. For instance, treating equations similar to the σ -forms of the standard Painlevé equations. Looking at appropriate autonomous limits, as we did in Section 6, might help in the classification problem.

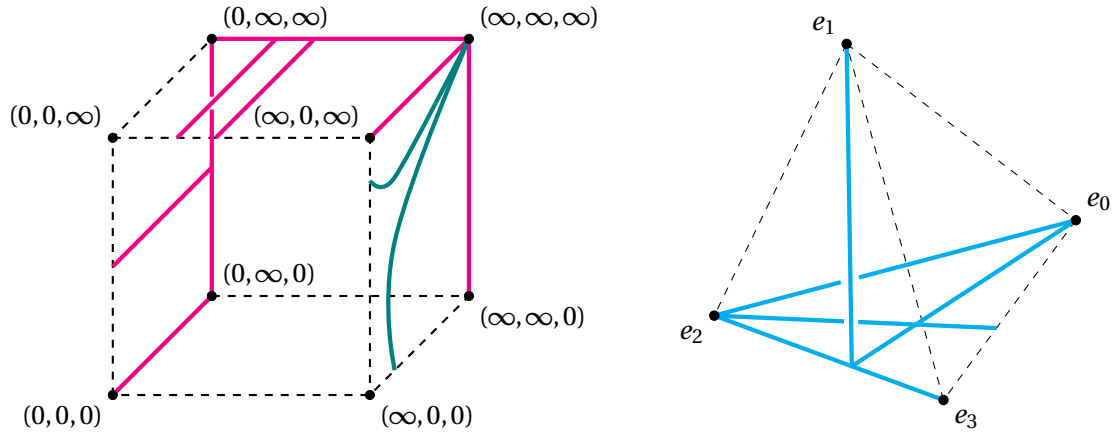

FIGURE 7. Configurations of the indeterminacies of the system with respect the compactifications $(\mathbb{P}^1)^{\times 3}$ and \mathbb{P}^3 .

We conclude by mentioning that another possible research direction is to determine if phenomena similar to the ones we unveiled in this paper can arise also in the case of discrete systems. For instance, given that the notion of Darboux polynomials, and hence of Darboux surfaces, is available also in the discrete setting [8], it would be interesting to see whether or not there are 3D non-autonomous discrete systems that can be put in relation with discrete Painlevé equations through restriction on Darboux surfaces.

ACKNOWLEDGEMENTS

GF would like to thank Gleb Pogudin (Institute Polytechnique de Paris) for illuminating discussions.

MG is member of the group GNSAGA of the Istituto Nazionale di Alta Matematica (INdAM) from 2024.

STATEMENTS AND DECLARATIONS

Competing interests. On behalf of all authors, the corresponding author states that there is no conflict of interest.

Funding. GF acknowledges support of the grant entitled “Geometric approach to ordinary differential equations” (01.03.2023-29.02.2024) funded under New Ideas 3B competition within Priority Research Area III implemented under the “Excellence Initiative – Research University” (IDUB) Programme (University of Warsaw) (nr 01/IDUB/2019/94). The work of GF is also partially supported by the project PID2021-124472NB-I00 funded by MCIN/AEI/10.13039/501100011033 and by “ERDF A way of making Europe”.

GG’s research was partially supported by GNFM of the Istituto Nazionale di Alta Matematica (INdAM), and the research project Mathematical Methods in Non-Linear Physics (MMNLP) by the Commissione Scientifica Nazionale – Gruppo 4 – Fisica Teorica of the Istituto Nazionale di Fisica Nucleare (INFN).

AS acknowledges the support of Japan Society for the Promotion of Science (JSPS) KAKENHI grant number 24K22843.

Author's contributions. All authors equally contributed to the study conception, performed relevant computations and analysed the results. The first draft of the manuscript was written jointly and all authors commented on previous versions of the manuscript and edited it. All authors read and approved the final manuscript.

Data availability statement. The manuscript has no associated or generated data.

Ethical conduct. The authors and the manuscript comply with all ethical standards and guidelines. The authors provided correct citations as needed and have no conflict of interest.

Compliance with ethical standards. The manuscript is not submitted to more than one journal for simultaneous consideration. The submitted work is original and has not been published elsewhere in any form or language.

APPENDIX A. STANDARD REALISATION OF THE SPACE OF INITIAL CONDITIONS FOR THE SIXTH PAINLEVÉ EQUATION

In this appendix we recall the construction of the minimal space of initial conditions for P_{VI} coming from the standard model of Sakai surfaces of type $D_4^{(1)}$, see [45]. Most of the contents were also provided in [26, Appendix], but we include this in order to make the present paper self-contained.

A.1. Surfaces. The usual construction of the space of initial conditions for system (2.14) proceeds as follows. For the compactification, take $\mathbb{P}_{[f_0:f_1]}^1 \times \mathbb{P}_{[g_0:g_1]}^1$ with f, g providing an affine chart via $[1 : f] = [f_0 : f_1]$, $[1 : g] = [g_0 : g_1]$. The standard atlas for $\mathbb{P}_{[f_0:f_1]}^1 \times \mathbb{P}_{[g_0:g_1]}^1$ is then provided by the four charts (f, g) , (F, g) , (f, G) , (F, G) defined by

$$[f_0 : f_1] = [1 : f] = [F : 1], \quad [g_0 : g_1] = [1 : g] = [G : 1], \quad (\text{A.1})$$

so $F = 1/f$ and $G = 1/g$ on the overlaps of coordinate patches. The eight indeterminacy points of the system are given in (A.2), where we use arrows to indicate infinitely near points. In this case the points b_4 and b_8 lie on the exceptional divisors of the blow ups of b_3 and b_7 respectively. We express their locations according to the convention established in Sections 3.2 and 4.4 and given explicitly in equation (3.5).

$$\begin{aligned} b_1 : (F, g) &= (0, -a_2), & b_2 : (F, g) &= (0, -a_1 - a_2), \\ b_3 : (f, G) &= (t, 0) \quad \leftarrow & b_4 : (u_3, v_3) &= (ta_0, 0), \\ b_5 : (f, g) &= (0, 0), & b_6 : (f, g) &= (0, a_4), \\ b_7 : (f, G) &= (1, 0) \quad \leftarrow & b_8 : (u_7, v_7) &= (a_3, 0). \end{aligned} \quad (\text{A.2})$$

Blowing up these points, and denoting by L_i the exceptional divisors over the point b_i , for $i = 1, \dots, 8$, we get for fixed $\mathbf{a} = (a_0, a_1, a_2, a_3, a_4)$ the surface X_t^{KNY} , as shown in the right hand side of Figure 8.

The unique effective anti-canonical divisor of the surface X_t^{KNY} has irreducible components $D_{0,t}, D_{1,t}, D_{2,t}, D_{3,t}, D_{4,t}$, where $D_{0,t}$ is the proper transform of L_3 , $D_{1,t}$ is the proper transform of $\{f = \infty\}$, $D_{2,t}$ is the proper transform of $\{g = \infty\}$, $D_{3,t}$ is the proper transform of L_7 and $D_{4,t}$ is the proper transform of $\{f = 0\}$. This is the pole divisor of the rational two-form ω_t defined in the (f, g) -chart by $\omega_t = \frac{d_t f \wedge d_t g}{f}$. We then get a bundle E^{KNY} over B with fibre, over the point $t \in B$, the open surface $E_t^{\text{KNY}} = X_t^{\text{KNY}} \setminus D_t^{\text{KNY}}$, where $D_t^{\text{KNY}} = \bigcup_{i=0}^4 D_{t,i}$ on which the system of differential equation (2.14) defines a uniform foliation. Summarising all of this, we have the following.

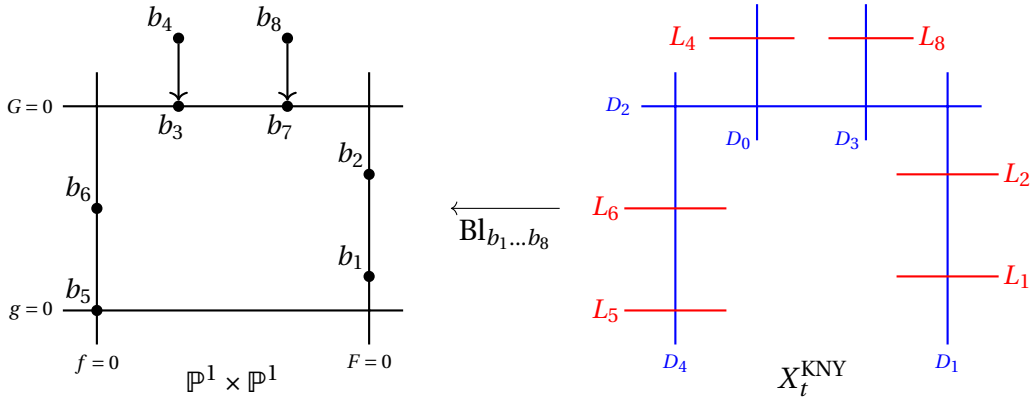

FIGURE 8. Graphic depiction of the construction of X^{KNY} . In blue (-2) -curves, in red (-1) -curves.

Lemma A.1. *We have a space of initial conditions for (2.14) in the sense of Definition 2.12 with*

- $B = \mathbb{C} \setminus \{0, 1\}$ being the independent variable space of (2.14);
- $X = X^{\text{KNY}}$ being the family of surfaces parametrised by B , where $\pi_X^{-1}(t) = X_t^{\text{KNY}}$, for $t \in B$;
- $D = D^{\text{KNY}}$ being the locus in X cut out by D_t^{KNY} in X_t^{KNY} ;
- φ_X being the composition $\varphi_X|_{X_t^{\text{KNY}}}: X_t^{\text{KNY}} \rightarrow \mathbb{P}^1 \times \mathbb{P}^1 \dashrightarrow \mathbb{C}^2$, where the first map is the blow up of b_1, \dots, b_8 and the second corresponds to taking the affine coordinate chart (f, g) ;
- $E = E^{\text{KNY}}$ being the family of open surfaces $E_t^{\text{KNY}} = X_t^{\text{KNY}} \setminus D_t^{\text{KNY}}$ over B , for $t \in B$.

A.2. Symplectic atlas and global Hamiltonian structure. If we introduce coordinates as usual on the blow up $\text{Bl}_{b_1, \dots, b_8}(\mathbb{P}^1 \times \mathbb{P}^1)$, the resulting atlas for E is neither Hamiltonian nor symplectic, which can be verified by direct calculation, see Section 2.6. We use instead the symplectic atlas constructed by Takano et al in [78]. Rather than starting from the system (2.14) in coordinates (f, g) and compactifying to $\mathbb{P}^1 \times \mathbb{P}^1$, this requires first changing variables to $(q, p) = (f, g/f)$. The resulting system is, up to a relabelling of parameters, the Hamiltonian form of P_{VI} due to Okamoto [62], explicitly

$$q' = \frac{\partial H^{\text{Ok}}}{\partial p}, \quad p' = -\frac{\partial H^{\text{Ok}}}{\partial q}, \quad (\text{A.3})$$

where:

$$H^{\text{Ok}} = \frac{q(q-1)(q-t)p^2 + ((a_1 + 2a_2)q(q-1) + a_3(t-1)q + a_4t(q-1))p}{t(t-1)} + \frac{a_2(a_1+1)q}{t(t-1)}. \quad (\text{A.4})$$

We then have the following symplectic atlas for E^{KNY} , which up to relabeling of the parameters is the same as that constructed by Takano et al [78].

Proposition A.2. *The bundle E^{KNY} admits the symplectic atlas $\mathcal{U} = \{U_0, \dots, U_5\}$, where U_i are coordinate patches with coordinates $(x_i, y_i; t)$, for $i = 0, \dots, 5$, with gluing and*

relation to the original variables f, g given as follows:

$$\begin{aligned}
x_0 &= q = f, & y_0 &= p = \frac{g}{f}, \\
x_1 &= f(g + a_2) = a_2 x_0 + y_0, & y_1 &= \frac{1}{f} = \frac{1}{x_0}, \\
x_2 &= f(g + a_1 + a_2) = (a_1 + a_2)x_0 + y_0, & y_2 &= \frac{1}{f} = \frac{1}{x_0}, \\
x_3 &= \frac{g(a_0 f + t g - f g)}{f^2} = \frac{y_0(a_0 x_0^2 - x_0 y_0 + t y_0)}{x_0^4}, & y_3 &= \frac{f}{g} = \frac{x_0^2}{y_0}, \\
x_4 &= \frac{g(a_4 - g)}{f} = \frac{y_0(a_4 x_0 - y_0)}{x_0^3}, & y_4 &= \frac{f}{g} = \frac{x_0^2}{y_0}, \\
x_5 &= \frac{g(g + a_3 f - f g)}{f^2} = \frac{y_0(a_3 x_0^2 + y_0 - x_0 y_0)}{x_0^4}, & y_5 &= \frac{f}{g} = \frac{x_0^2}{y_0}.
\end{aligned} \tag{A.5}$$

Corollary A.3. *The system on E^{KNY} extended from (2.14) has a global Hamiltonian structure with respect to the two-form ω_t^{KNY} on the fibre given in the original coordinates (f, g) by*

$$\omega_t^{\text{KNY}} = \frac{d_t f \wedge d_t g}{f}. \tag{A.6}$$

This is defined by the two-form Ω^{KNY} on E^{KNY} written in each chart $U_i \in \mathcal{U}$ of the symplectic atlas from Proposition A.2 as

$$\Omega^{\text{KNY}} = dx_i \wedge dy_i + dH_i \wedge dt, \tag{A.7}$$

where

$$\begin{aligned}
H_0(x_0, y_0; t) &= \frac{x_0(x_0 - 1)(x_0 - t)y_0^2 + a_2(a_1 + a_2)x_0}{t(t - 1)} \\
&+ \frac{(x_0^2(a_1 + 2a_2) + x_0 t(a_3 + a_4) - x_0(a_1 + 2a_2 - a_3) - t a_4)y_0}{t(t - 1)},
\end{aligned} \tag{A.8}$$

and the remaining H_i are determined according to Lemma 2.23.

APPENDIX B. RELATION OF THE 3D SYSTEM WITH THE σ -FORM OF THE P_{VI} EQUATION

In [56, Prop. 3.2, Th. 3.3, Th. 3.4] a connection between the solution of the system (1.1) coming from the degenerate Jacobi weight and the σ -form of the sixth Painlevé equation was established. The authors present only how $r_n(t)$ and $y_n(t)$ (that is, $z(t)$ and $y(t)$ in our notation) are related to an auxiliary function $H(t)$ and its derivatives (see formulas in [56, Prop. 3.2]). This function satisfies a non-linear second-order differential equation of degree two [56, Th. 3.3] which is then related to the σ -form of the sixth Painlevé equation [56, Th. 3.4] via an affine transformation. We give more details below following [56].

The σ -form of the sixth Painlevé equation is given by [61, p. 346]

$$\begin{aligned}
&\sigma'(t(t-1)\sigma'')^2 + (2\sigma'(t\sigma' - \sigma) - (\sigma')^2 - \nu_1\nu_2\nu_3\nu_4)^2 \\
&- (\sigma' + \nu_1^2)(\sigma' + \nu_2^2)(\sigma' + \nu_3^2)(\sigma' + \nu_4^2) = 0,
\end{aligned} \tag{B.1}$$

where $\sigma = \sigma(t)$, $\sigma' = \frac{d}{dt}\sigma$, and v_1, \dots, v_4 are parameters. In our notation, the parameters of the σ -form and the parameters in the weight are related by [56]:

$$v_1 = \frac{\alpha + \beta}{2}, \quad v_2 = \frac{\beta - \alpha}{2}, \quad v_3 = \frac{2n + \alpha + \beta}{2}, \quad v_4 = \frac{2n + \alpha + \beta + 2\gamma}{2}. \quad (\text{B.2})$$

The function $H = H(t)$ defined by

$$\sigma = H - \left(n(n + \alpha + \beta + \gamma) + \frac{(\alpha + \beta)^2}{4} \right) t + \frac{2n(n + \alpha + \beta + \gamma) + (\alpha + \beta)\beta - (\alpha - \beta)\gamma}{4} \quad (\text{B.3})$$

satisfies a second-order second-degree differential equation [56, Th. 3.3] of the form

$$\mathfrak{H}(H, H', H''; t) = 0, \quad (\text{B.4})$$

where \mathfrak{H} is a polynomial functions of its arguments, of degree two in H'' , which we do not reproduce here for the sake of brevity. This is equivalent to the σ -form (B.1) via the relation (B.3).

If one differentiates equation (B.4) with respect to t , the result is a non-autonomous third-order differential equation for H of degree one. We rewrite this as a first-order system by taking $(H_0, H_1, H_2) = (H, H', H'')$, so $H'_0 = H_1$, $H'_1 = H_2$, and $H'_2 = H'''$ is known from the third-order equation. We shall refer to this as the 3D system for H , and similarly refer to the differentiated σ -form, recast as a first-order system, as the 3D system for σ . For the sake of readability we do not present either of these here.

By construction the 3D system for H has the first integral $\mathfrak{H}(H_0, H_1, H_2; t)$, with \mathfrak{H} as in (B.4), and the level sets

$$\Gamma_c := \{ \mathfrak{H}(H_0, H_1, H_2; t) = c \} \subset \mathbb{C}_t^3, \quad c \in \mathbb{C}, \quad (\text{B.5})$$

are invariant hypersurfaces for the 3D system for H . The second-degree equation (B.4) corresponds to the restriction of the 3D system for H to the particular level set Γ_0 .

We will show that this restriction of the 3D system for H to Γ_0 , or equivalently the 3D system for σ subject to (B.1), can be identified with the system (1.1) subject to the constraint (1.4).

As remarked above, [56] provides expressions for y and z in terms of H and its derivatives, so we just require the expression for x , which was not given in [56]. This can be obtained from the 3D system for H in addition to the second-order second-degree equation (B.4). However, the computations and the final expression is extremely cumbersome, so we only outline the steps involved so that the results can be reproduced in any computer algebra system. One needs to first substitute the expressions

$$z = \frac{H - tH' + n(n + \alpha + \gamma)}{2n + \alpha + \beta + \gamma}, \quad y = \frac{H - (t-1)H' - n(n + \beta + \gamma)}{2n + \alpha + \beta + \gamma}, \quad (\text{B.6})$$

from [56, Prop. 3.2] into the system (1.1). From the second of the resulting equations, one can obtain x^2 in terms of x, H, H' and H'' . Then one differentiates this expression with respect to t and substitutes H''' as a rational function of H, H', H'' according to the third-order equation for H . Then restriction to the level set Γ_0 is imposed by replacing $(H'')^2$ by a polynomial in H, H' with coefficients rational in t according to (B.4). Finally, using the first equation of the system (1.1) for x' , with y and z replaced according to (B.6), and replacing the powers of x using the known expression for x^2 one can finally find the cumbersome rational expression for x in terms of H, H', H'' . It can be checked that this, together with the expressions (B.6) for y and z , provides a birational transformation between the copies of \mathbb{C}^3 with coordinates x, y, z and H_0, H_1, H_2 respectively. This restricts to a birational transformation between the

hypersurface (1.2) and the particular level set Γ_0 . Under this restriction the 3D system (1.1) on the hypersurface (1.2) is transformed to the 3D system for H on Γ_0 , or similarly via (B.3) to the 3D system for σ subject to (B.1). This provides an additional description of the connection to the σ -form of P_{VI} identified in [56].

APPENDIX C. AN APPARENT SINGULARITY OF THE SYSTEM IN THE SECOND
PARAMETRISATION WITH $\mathbb{P}^1 \times \mathbb{P}^1$ COMPACTIFICATION

In this appendix we exhibit how the choice of the compactification might lead to complications in the identification procedure.

Consider the system (4.17), and choose as compactification $\mathbb{P}^1 \times \mathbb{P}^1$ rather than \mathbb{F}_1 as was done in Section 4.4. With this choice, we find the following eight indeterminacy points given in coordinates as follows:

$$\begin{aligned} c_1 &= ([0 : 1], [1 : \kappa\beta]), & c_2 &= ([\kappa : 1], [1 : -n\kappa t]), \\ c_3 &= ([\kappa : 1], [1 : -(n + \gamma)\kappa t]), & c_4 &= ([\kappa : 1 - t], [1 - t : \alpha\kappa t]), \\ c_5 &= ([0 : 1], [1 : 0]), & c_6 &= ([\kappa : 1 - t], [1 : 0]), \\ c_7 &= ([1 : 0], [0 : 1]), & c_8 &= ([1 : 0], [1 : -n(n + \gamma)t]), \end{aligned} \tag{C.1}$$

where, the standard affine chart centred at $([0 : 1], [0 : 1])$ has coordinates (x_0, v) . All of them but two, namely c_7, c_8 , require only one blow up to resolve, i.e. that the system is free of indeterminacy points on the exceptional divisors of these blow ups introduced according to (3.5). The indeterminacy point c_7 is resolved after three blow ups in total, first of c_7 then of two further indeterminacy points given in coordinates by

$$c_9 : (U_7, V_7) = (0, 0), \quad c_{10} : (u_9, v_9) = \left(\frac{1}{1-t}, 0 \right).$$

After blowing up c_8 , if one proceeds to then repeatedly look for further indeterminacy points on the exceptional divisor and blow these up, one observes that this procedure does not terminate after a reasonable number of iterations. In fact, the indeterminacy point c_8 constitutes an *apparent singularity* and should not be blown up at all, as we shall explain next. We give a schematic representation of the surface obtained by the blowing up $c_1, \dots, c_7, c_9, c_{10}$ and indicate the indeterminacy point c_8 in Figure 9.

Consider a non-autonomous 2D system of the form (2.19) as a rational vector field on $\mathbb{C}^2 \times B$, and assume that this has the Painlevé property in the sense that it has a space of initial conditions. Then, choose some compactification Σ of the fibre \mathbb{C}^2 and consider the system as a rational vector field on $\Sigma \times B$. The blow ups that must be performed in order to achieve a uniform foliation are centred at the points in the fibre Σ through which infinitely many solutions pass. Such points are always indeterminacy points of the system but the converse is not true.

It might be possible that an indeterminacy point does not require blowing up. Two possible reasons for this follow. The first is that there are actually no solutions passing through the point and it should be removed as part of the inaccessible divisors, see [27] for such a case. The second is that there is only one solution passing through the point. The latter is what is happening in the case of c_8 , which can be seen as follows.

Consider the proper transform on $\text{Bl}_{c_1 \dots c_{10}} \mathbb{P}^1 \times \mathbb{P}^1$ of the line $x_0 = \infty$, on which the problematic indeterminacy point $\text{Bl}_{c_1 \dots c_{10}}^{-1}(c_8)$ lies. This is a (-1) -curve and we can contract it to a point, say p , at the origin of the chart with coordinates (x, y) given by $x = \frac{1}{x_0 v}$, $y = \frac{1}{x_0}$. Pushing the rational vector field forward under the contraction to one in local coordinates (x, y) , we see that it becomes regular at p . Then existence

and uniqueness theorems for ordinary differential equations give a unique solution in (x, y) coordinates passing through this point for a fixed t_* , which when lifted back up to $\text{Bl}_{c_1 \dots c_{10}} \mathbb{P}^1 \times \mathbb{P}^1$ must be the single solution passing through the point c_8 . Indeed it can be verified by direct calculation in this case that the unique solution of the regular initial value problem for the system (4.17) transformed to coordinates $(x, y) = \left(\frac{1}{x_0 v}, \frac{1}{x_0}\right)$ with initial condition $(x(t_*), y(t_*)) = (0, 0)$ corresponds to one passing through c_8 at $t = t_*$.

We must remark that care must be taken of apparent singularities such as c_8 only when performing blow ups based purely on consideration of indeterminacy points.

In his original work, Okamoto have chosen the centres of blow up by studying infinite families of solutions passing trough points. In this way there would be no risk of confusion regarding what needs to be blown up, but this requires a preliminary analysis.

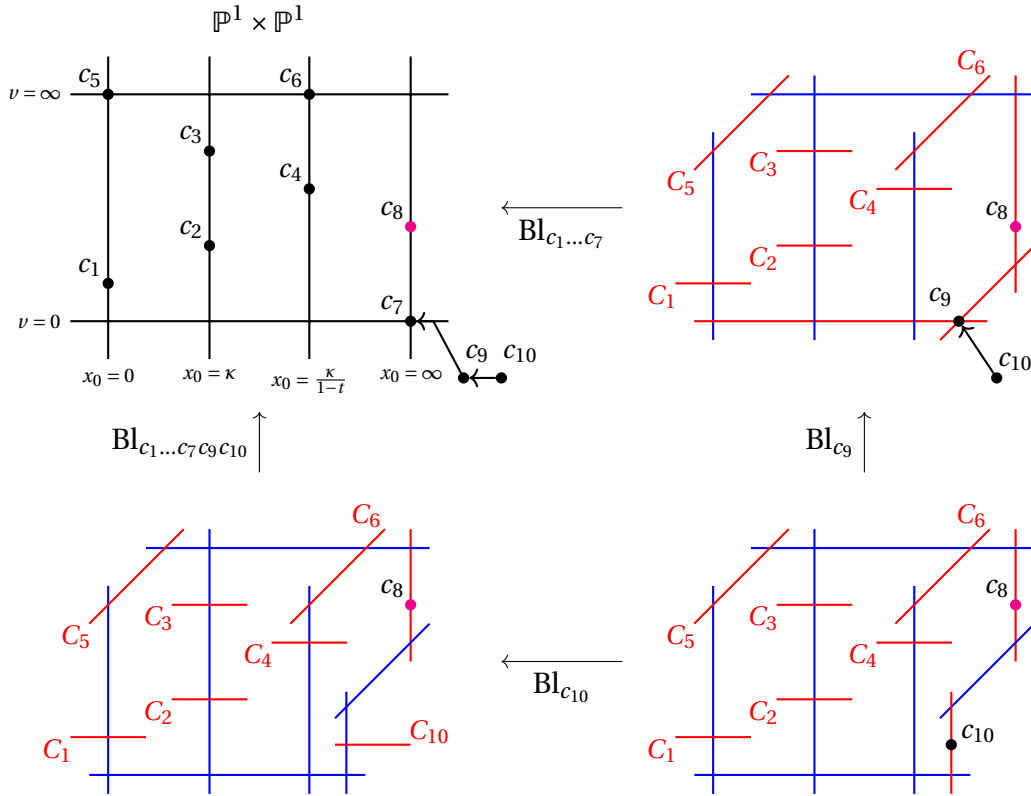

FIGURE 9. Sequence of blow ups and surface for system (4.17) with $\mathbb{P}^1 \times \mathbb{P}^1$ compactification. In red (-1) -curves and in blue (-2) -curves.

APPENDIX D. ADDITIONAL AUTONOMOUS LIMITS FOR THE 3D SYSTEM

In this appendix we discuss the exponential-type autonomous limits for the system (1.1). We recall that, following [42], this autonomous limits are obtained through the change of independent variable:

$$t \rightarrow e^t + t_0, \quad t_0 \in \{0, 1\}, \quad (\text{D.1})$$

then taking $e^t \rightarrow 0$.

D.1. Exponential type autonomous limit as $t \rightarrow 0$. Consider the case $t_0 = 0$ in (D.1). Then, in the limit above, system (1.1) collapses to the following system of algebro-differential equations:

$$\begin{aligned} x' &= (\kappa - x)(\beta - x + 2z), \\ z' &= \frac{z(\kappa - x)(\beta + z)(\kappa + x - 2)}{x(\kappa - 1)} = 0, \end{aligned} \quad (\text{D.2})$$

where differentiation is with respect to τ . Note that we had to multiply both sides of the second equation of the non-autonomous system by e^τ and then let $e^\tau \rightarrow 0$. We see that the variable y completely disappeared.

Then z must be constant $z = z_*$ and the hypersurface S_t degenerates to a double plane:

$$S_0 : z_*(z_* + \beta)(\kappa - x)^2 = 0, \quad (\text{D.3})$$

which is consistent with S_a from the first subsection when $a = 0$ and $\varepsilon \rightarrow 0$ by taking (6.15) and (6.10), that is, with (6.20).

In the end, we see that this autonomous system is trivial, in the sense that it admits only the trivial solutions:

$$\begin{aligned} x &= \kappa, \quad z = z_*, \\ x &= -\alpha - \beta - \gamma - 2n + 1, \quad z = -\frac{1}{2}\alpha - \beta - \frac{1}{2}\gamma - n + \frac{1}{2}, \\ x &= \frac{\kappa e^{(\beta - \kappa)(\lambda + \tau)} - \beta}{e^{(\beta - \kappa)(\lambda + \tau)} - 1}, \quad z_* = 0, \\ x &= -\frac{\beta e^{(\beta + \kappa)(\lambda + \tau)} + \kappa}{e^{(\beta + \kappa)(\lambda + \tau)} - 1}, \quad z_* = -\beta, \end{aligned} \quad (\text{D.4})$$

where λ is an arbitrary constant.

D.2. Exponential type autonomous limit as $t \rightarrow 1$. Consider now $t_0 = 1$ in (D.1). Then, in the limit described above the system (1.1) becomes the following:

$$\begin{aligned} x' &= x(\kappa - \alpha - 1 + 2y) - \kappa(\beta + 2z), \quad y' = 0, \\ (\kappa - 1)xz' &= x^2y(y - \alpha) + x(n(\gamma + 2y - 2z + n) + y(\alpha + \gamma - 2z) - z(\beta + \gamma)) \\ &\quad - z(\beta + z)((\kappa - 1)^2 - 1), \end{aligned} \quad (\text{D.5})$$

where the differentiation is with respect to τ . From the second equation of (D.5), we see that y is constant. This system has the following invariant algebraic hypersurface:

$$S_1 = \{h_1(x, y, z) = 0\}, \quad (\text{D.6})$$

where

$$h_1 = \kappa x(n^2 + n(\gamma + 2y - 2z) + y(\alpha + \gamma - 2z) - z(\beta + \gamma)) + x^2y(y - \alpha) + \kappa^2z(\beta + z). \quad (\text{D.7})$$

Note that the hypersurface S_1 is obtained from the hypersurface S_a in (6.17) as $a \rightarrow 1$, and $\varepsilon \rightarrow 0$ by taking (6.15) and (6.10). Division by x of the defining polynomial of the hypersurface does not give the first integral as before.

Let us now discuss the properties of the solutions of the system (D.5). We observe, that using the constancy of y we obtain a single second-order equation for x . This equation has the following form:

$$x'' + \frac{(\kappa - 2)(x')^2}{2(\kappa - 1)x} + V_3'(x) = 0, \quad (\text{D.8})$$

where V_3 is an assigned function, of which we omit the explicit expression for the sake of brevity. From its shape, it is evident that equation (D.8) has the first integral \mathcal{I} defined by

$$x^{1-\frac{1}{\alpha+\beta+\gamma+2n}} \mathcal{I} = \beta^2 \kappa^2 + x^2 ((\beta + \gamma)^2 + 4n(n + \beta + \gamma) + 4y(\kappa - 1)) - 2x\kappa (\beta(\beta + \gamma) + 2n(n + \beta + \gamma) + 2y(\kappa - 1)) - (x')^2. \quad (\text{D.9})$$

For generic values of the parameters the level curves of the function \mathcal{I} are not algebraic curves. For this reason, in general, the system (D.8) will not possess the Painlevé property.

REFERENCES

- [1] V. C. C. Alves, *New coalescences for the Painlevé equations*, arXiv:2103.02697 [nlin.SI] (2021).
- [2] V. Antonov, W. Fernandes, V. G. Romanovski, and N. L. Shcheglova, *First integrals of the May–Leonard asymmetric system*, *Mathematics* 7(3) (2019), 292.
- [3] A. Beauville, *Complex Algebraic Surfaces*, 2nd edition, London Mathematical Society Student Texts, Vol. 34, Translated from the 1978 French original by R. Barlow, with assistance from N. I. Shepherd-Barron and M. Reid, Cambridge University Press, Cambridge, 1996.
- [4] G. B. Byrnes, F. A. Haggard, and G. R. W. Quispel, *Sufficient conditions for dynamical systems to have pre-symplectic or pre-implectic structures*, *Physica A* 272 (1999), no. 1-2, 99–129.
- [5] A. S. Carstea and T. Takenawa, *Space of initial conditions and geometry of two 4-dimensional discrete Painlevé equations*, *J. Phys. A: Math. Theor.* 52 (2019) 275201, 25pp.
- [6] A. S. Carstea and T. Takenawa, *A classification of two-dimensional integrable mappings and rational elliptic surfaces*, *J. Phys. A: Math. Theor.* 45 (2012), no. 15, 155206, 15 pp.
- [7] G. Castelnuovo, *Sulle superficie di genere zero*, *Memorie della Soc. It. delle Scienze (detta dei XL)*, ser. III 10 (1896), 7.
- [8] E. Celledoni, C. Evripidou, D. McLaren, B. Owren, R. Quispel, and B. Tapley, *Detecting and determining preserved measures and integrals of birational maps*, arXiv:1902.04685 [math.NA] (2019).
- [9] J. Chazy, *Sur les équations différentielles dont l'intégrale générale est uniforme et admet des singularités essentielles mobiles*, *C. R. Acad. Sci. Paris* 149 (1909).
- [10] J. Chazy, *Sur les équations différentielles du troisième ordre et d'ordre supérieur dont l'intégrale générale a ses points critiques fixes*, *Acta Math.* 34 (1911), 317–385.
- [11] Y. Chen and L. Zhang, *Painlevé VI and the unitary Jacobi ensembles*, *Stud. Appl. Math.* 125 (2010), 91–112.
- [12] P. A. Clarkson, *Open problems for Painlevé equations*, *SIGMA Symmetry Integrability Geom. Methods Appl.* 15 (2019), Paper no. 006, 20pp.
- [13] R. Conte and M. Musette, *The Painlevé Handbook*, Springer, Dordrecht, 2008.
- [14] C. M. Cosgrove, *Higher-order Painlevé equations in the polynomial class. I. Bureau symbol P2*, *Stud. Appl. Math.* 104 (2000), no. 1, 1–65.
- [15] C. M. Cosgrove, *Higher-order Painlevé equations in the polynomial class. II. Bureau symbol P1*, *Stud. Appl. Math.* 116 (2006), no. 4, 321–413.
- [16] C. M. Cosgrove, *Chazy's second-degree Painlevé equations*, *J. Phys. A* 39 (2006), no. 39, 11955–11971.
- [17] D. Dai and L. Zhang, *Painlevé VI and Hankel determinants for the generalized Jacobi weight*, *J. Phys. A: Math. Theor.* 43 (2010), 055207.
- [18] G. D'Ambrosi and M. C. Nucci, *Lagrangians for equations of Painlevé type by means of the Jacobi Last Multiplier*, *J. Nonlinear Math. Phys.* 16, Suppl. (2009), 61–71.
- [19] G. Darboux, *Mémoire sur les équations différentielles algébriques du premier ordre et du premier degré (Mélanges)*, *Bull. Sci. math.* 2ème série 2 (1878), 60–96; 123–144; 151–200.
- [20] M. Dell'Atti and T. Kecker, *Geometric approach for the identification of Hamiltonian systems of quasi-Painlevé type*, arXiv:2402.19053.
- [21] M. De Marco, M. Del Zotto, M. Graffeo, and A. Sangiovanni, *5d conformal matter*, *J. High En. Phys.* 2024(5) (2024), 1–68.
- [22] J. J. Duistermaat, *Discrete Integrable Systems: QRT Maps and Elliptic Surfaces*, Springer, New York, 2010.

- [23] A. Dzhamay, G. Filipuk, A. Ligeża, and A. Stokes, *Hamiltonian structure for a differential system from a modified Laguerre weight via the geometry of the modified third Painlevé equation*, Appl. Math. Lett. 120 (2021), 107248.
- [24] A. Dzhamay, G. Filipuk, A. Ligeża, and A. Stokes, *Different Hamiltonians for differential Painlevé equations and their identification using a geometric approach*, J. Differential Equations 399 (2024), 281–334.
- [25] A. Dzhamay, G. Filipuk, and A. Stokes, *On differential systems related to generalized Meixner and deformed Laguerre orthogonal polynomials*, Integral Transforms and Special Functions 32 (5–8) (2021), 483–492.
- [26] A. Dzhamay, G. Filipuk, and A. Stokes, *Recurrence coefficients for discrete orthogonal polynomials with hypergeometric weight and discrete Painlevé equations*, J. Phys. A: Math. Theor. 53 (2020), no. 49, 495201, 29 pp.
- [27] A. Dzhamay, G. Filipuk, and A. Stokes, *Differential equations for the recurrence coefficients of semiclassical orthogonal polynomials and their relation to the Painlevé equations via the geometric approach*, Stud. Appl. Math. 148 (2022), no. 4, 1656–1702.
- [28] D. Eisenbud and J. Harris, *The Geometry of Schemes*, Springer, New York, 1991.
- [29] G. Filipuk, A. Ligeża, and A. Stokes, *Relations between different Hamiltonian forms of the third Painlevé equation*, in Recent Trends in Formal and Analytic Solutions of Diff. Equations (Providence, RI) (G. Filipuk, A. Lastra, and S. Michalik, eds.), Contemp. Math., vol. 782, Amer. Math. Soc., November 2023, pp. 37–42.
- [30] A. S. Fokas, A. R. Its, A. A. Kapaev, and V. Yu. Novokshenov, *Painlevé Transcendents: The Riemann-Hilbert Approach*, Math. Surveys Monogr., 128, American Mathematical Society, Providence, RI, 2006.
- [31] A. S. Fokas, A. R. Its, and A. V. Kitaev, *Discrete Painlevé equations and their appearance in quantum gravity*, Comm. Math. Phys. 142 (1991), 313–344.
- [32] R. Fuchs, *Sur quelques équations différentielles linéaires du second ordre*, Comptes Rendus 141 (1906), 555–558.
- [33] K. Fuji and T. Suzuki, *Higher order Painlevé system of type $D_{2n+2}^{(1)}$ arising from integrable hierarchy*, Int. Math. Res. Not. 2008.9 (2008), rnm129–rnm129.
- [34] B. Gambier, *Sur les équations différentielles du second ordre et du premier degré dont l'intégrale générale est à points critiques fixes*, Acta Math. 33 (1910), 1–55.
- [35] A. Goriely, *Integrability and Nonintegrability of Dynamical Systems*, World Scientific, 2001.
- [36] M. Graffeo and G. Gubbiotti, *Growth and integrability of some birational maps in dimension three*, Ann. Henri Poincaré 25 (2024), no. 3, 1733–1793.
- [37] B. Grammaticos and A. Ramani, *Painlevé equations: continuous, discrete and ultradiscrete*, in *Symmetries and Integrability of Difference Equations* (D. Levi, P. Olver, Z. Thomova, and P. Winternitz, eds.), pp. 83–114, London Mathematical Society Lecture Notes series, Cambridge, Cambridge University Press, 2011.
- [38] B. Grammaticos, A. Ramani, and V. Papageorgiou, *Do integrable mappings have the Painlevé property?* Phys. Rev. Lett. 67 (1991), 1825.
- [39] V. I. Gromak, I. Laine, and S. Shimomura, *Painlevé Differential Equations in the Complex Plane*, De Gruyter Stud. Math. 28, Walter de Gruyter & Co., Berlin, 2002.
- [40] E. L. Ince, *Ordinary Differential Equations*, Dover, New York, 1956.
- [41] R. Hartshorne, *Algebraic Geometry*, Springer, New York, 2013.
- [42] V. Heu, N. Joshi, and M. Radnović, *Global asymptotics of the sixth Painlevé equation in Okamoto's space*, Forum Math, Sigma 11:e17 (2023), 1–38.
- [43] F. Hirzebruch, *Über eine Klasse von einfachzusammenhängenden komplexen Mannigfaltigkeiten*, Math. Ann. 124 (1951), 77–86.
- [44] M. Jimbo and T. Miwa, *Monodromy preserving deformation of linear ordinary differential equations with rational coefficients. II*, Physica D. 2 (1981), 407–448.
- [45] K. Kajiwara, M. Noumi, and Y. Yamada, *Geometric aspects of Painlevé equations*, J. Phys. A: Math. Theor. 50 (2017), no. 7, 073001, 164 pp.
- [46] T. Kecker and G. Filipuk, *Regularising transformations for complex differential equations with movable algebraic singularities*, Math. Phys. Anal. Geom. 25 (2022), no.1, Paper no. 9, 43 pp.
- [47] H. Kimura, *Uniform foliation associated with the Hamiltonian system \mathcal{H}_n* , Ann. Scuola Norm. Sup. Pisa Cl. Sci. (4) 20 (1993), no. 1, 1–60.

- [48] H. Kimura, *Uniform foliation associated with the Garnier system*, Sūgaku Expositions 8 (1995), no. 1, 103–123.
- [49] H. Kimura, *Initial value spaces of degenerate Garnier systems* (Japanese), Painlevé systems, hypergeometric systems and asymptotic analysis (Japanese) (Kyoto, 1999), Sūrikaiseikikenkyūsho Kōkyūroku (2000), no. 1133, 18–27.
- [50] X. Li, A. Dzhamay, G. Filipuk, and D.J. Zhang, *Recurrence relations for the generalized Laguerre and Charlier orthogonal polynomials and discrete Painlevé equations on the $D_6^{(1)}$ Sakai surface*, arXiv:2202.11263 [nlin.SI], submitted.
- [51] J. Malmquist, *Sur les équations différentielles du second ordre dont l'intégrale générale a ses points critiques fixes*, Ark. Mat. Astron. Fys. 17 (1922-23), no. 8, 1–89.
- [52] Maple User Manual. Maplesoft, a division of Waterloo Maple Inc., 1996–2023.
- [53] T. Matano, A. Matumiya, and K. Takano, *On some Hamiltonian structures of Painlevé systems. II*, J. Math. Soc. Japan 51 (1999), no. 4, 843–866.
- [54] Mathematica, Wolfram Research, Inc., Version 14.1, Champaign, IL, 2024.
- [55] A. Matumiya, *On some Hamiltonian structures of Painlevé systems. III*, Kumamoto J. Math. 10 (1997), 45–73.
- [56] C. Min and Y. Chen, *Painlevé VI, Painlevé III, and the Hankel determinant associated with a degenerate Jacobi unitary ensemble*, Math. Methods Appl. Sci. 43 (2020), no. 15, 9169–9184.
- [57] E. Noether, *Invariante Variationsprobleme*, Nachr d König Gesellsch d. Wiss. zu Göttingen Math-phys Klasse (1918), 235–57.
- [58] M. Noumi, *Painlevé Equations Through Symmetry*, Transl. Math. Monogr. 223, American Mathematical Society, Providence, RI, 2004.
- [59] M. Noumi, and Y. Yamada, *Higher order Painlevé equations of type $A_1^{(1)}$* , Funkcial. Ekvac. 41 (1998), 483–503.
- [60] K. Okamoto, *Sur les feuilletages associés aux équations du second ordre à points critiques fixes de P. Painlevé*, (French) [On foliations associated with second-order Painlevé equations with fixed critical points], Japan. J. Math. (N.S.) 5 (1979), no. 1, 1–79.
- [61] K. Okamoto, *Studies on the Painlevé equations. I. Sixth Painlevé equation PVI*, Ann. Mat. Pura Appl. (4) 146 (1987), 337–381.
- [62] K. Okamoto, *Polynomial Hamiltonians associated with Painlevé equations. I*, Proc. Jpn. Acad., Ser. A, Math. Sci. 56 (1980), no. 6, 264–268.
- [63] K. Okamoto, *Polynomial Hamiltonians associated with Painlevé equations. II. Differential equations satisfied by polynomial Hamiltonians*, Proc. Jpn. Acad., Ser. A, Math. Sci. 56 (1980), no. 8, 367–371.
- [64] P. Painlevé, *Mémoire sur les équations différentielles dont l'intégrale générale est uniforme*, Bull. Soc. Math. Phys. France 28 (1900), 201–261.
- [65] P. Painlevé, *Sur les équations différentielles du second ordre et d'ordre supérieur dont l'intégrale générale est uniforme*, Acta Math. 25 (1902), 1–85.
- [66] R. Pardini and G. P. Pirola (Ed.) *Rationality Problems in Algebraic Geometry – Levico Terme, Italy 2015*, Lecture Notes in Mathematics, Springer Cham, 2016.
- [67] M.J. Prellé and M.F. Singer, *Elementary first integrals of differential equations*, Trans. Amer. Math. Soc. 279 (1983), 613–636.
- [68] G. R. W. Quispel, J. A. G. Roberts, and C. J. Thompson, *Integrable mappings and soliton equations*, Phys. Lett. A 126 (1988), no. 7, 419–421.
- [69] G. R. W. Quispel, J. A. G. Roberts, and C. J. Thompson, *Integrable mappings and soliton equations II*, Phys. D 34 (1989), no. 1–2, 183–192.
- [70] A. Ramani, B. Grammaticos, and J. Hietarinta, *Discrete versions of the Painlevé equations*, Phys. Rev. Lett. 67 (1991), no. 14, 1829–1832.
- [71] M. Reid, *Young person's guide to canonical singularities*, in *Algebraic geometry, Bowdoin, 1985* (Brunswick, Maine, 1985), Proc. Sympos. Pure Math., 46, Part 1, American Mathematical Society, Providence, RI, 1987, 345–414.
- [72] H. Sakai, *Rational surfaces associated with affine root systems and geometry of the Painlevé equations*, Comm. Math. Phys. 220 (2001), no. 1, 165–229.
- [73] H. Sakai, *Ordinary differential equations on rational elliptic surfaces*, in *Symmetries, integrable systems and representations* (K. Iohara, S. Morier-Genoud, and B. Rémy, eds.), pp. 515–541, Springer Proc. Math. Stat. 40, Springer, Heidelberg, 2013.

- [74] Y. Sasano, *Coupled Painlevé II systems in dimension four and the systems of type $A_4^{(1)}$* , Tohoku Math. J. (2) 58 (2006), no. 4, 529–548.
- [75] Y. Sasano, *Coupled Painlevé V systems in dimension 4*, Funkcial. Ekvac. 49 (2006), no. 1, 133–161.
- [76] J. Schicho, *Rational parametrization of surfaces*, J. Symbolic Computation 26 (1998), 1–29.
- [77] M. Schütt and T. Shioda, *Mordell–Weil Lattices*, Ergebnisse der Mathematik und ihrer Grenzgebiete. 3. Folge / A Series of Modern Surveys in Mathematics, Springer Nature Singapore, 2019.
- [78] T. Shioda and K. Takano, *On some Hamiltonian structures of Painlevé systems. I*, Funkcial. Ekvac. 40 (1997), no. 2, 271–291.
- [79] M. Suzuki, *Spaces of initial conditions of Garnier system and its degenerate systems in two variables*, J. Math. Soc. Japan 58 (2006), no. 4, 1079–1117.
- [80] T. Suzuki and K. Fuji, *Higher order Painlevé systems of type A, Drinfeld–Sokolov hierarchies and Fuchsian systems*, RIMS Kôkyûroku Bessatsu B30 (2012), 181–208.
- [81] N. Tahara, *An augmentation of the phase space of the system of type $A_4^{(1)}$* , Kyushu J. Math. 58 (2004), no. 2, 393–425.
- [82] K. Takano, *Defining manifolds for Painlevé equations*, Toward the exact WKB analysis of differential equations, linear or non-linear (Kyoto, 1998), 261–269, Kyoto University Press, Kyoto, 2000.
- [83] T. Takenawa, *Discrete dynamical systems associated with root systems of indefinite type*, Comm. Math. Phys. 224 (2001), no. 3, 657–681.
- [84] T. Takenawa, *Space of initial conditions for the four-dimensional Fuji–Suzuki–Tsuda system*, RIMS Kôkyûroku Bessatsu B87 (2021), 99–112.
- [85] T. Takenawa, *Space of initial conditions for the four-dimensional Garnier system revisited*, RIMS Kôkyûroku Bessatsu B96 (2024), 117–130.
- [86] T. Tsuda, *Integrable mappings via rational elliptic surfaces*, J. Phys. A 37 (2004), no. 7, 2721–2730.
- [87] W. Van Assche, *Orthogonal Polynomials and Painlevé Equations*, Austral. Math. Soc. Lect. Ser. 27, Cambridge University Press, Cambridge, 2018.
- [88] J. Weiss, M. Tabor, and G. Carnevale, *The Painlevé property for partial differential equations*, J. Math. Phys. 24 (1983), 522–526.