

10-list Recoloring of Planar Graphs

Daniel W. Cranston*

November 4, 2024

Abstract

Fix a planar graph G and a list-assignment L with $|L(v)| = 10$ for all $v \in V(G)$. Let α and β be L -colorings of G . A recoloring sequence from α to β is a sequence of L -colorings, beginning with α and ending with β , such that each successive pair in the sequence differs in the color on a single vertex of G . We show that there exists a constant C such that for all choices of α and β there exists a recoloring sequence σ from α to β that recolors each vertex at most C times. In particular, σ has length at most $C|V(G)|$. This confirms a conjecture of Dvořák and Feghali. For our proof, we introduce a new technique for quickly showing that many configurations are reducible. We believe this method may be of independent interest and will have application to other problems in this area.

1 Introduction

A recoloring sequence transforms one specified k -coloring of a graph G into another by recoloring one vertex at a time. We also require that each recoloring step yields an intermediate proper k -coloring of G . We typically ask whether every k -coloring can be transformed (or “reconfigured”) to every other. If so, we seek to bound as a function of $|G|$ the maximum number of recoloring steps needed, over all pairs of k -colorings.

Analogues of this paradigm have been applied to a broad range of structures including independent sets, dominating sets, solutions to 3-SAT, triangulations of a planar point set, and non-crossing spanning trees, to name a few. This general topic of study is called *reconfiguration*, and we recommend to the interested reader the surveys [8] and [9] and the introduction of [2]. Perhaps the most widely studied area within reconfiguration is graph coloring, and that is our focus here.

Cereceda conjectured that if a graph G is d -degenerate and we fix $k \geq d+2$, then each k -coloring α of G can be reconfigured to each other k -coloring β of G with a recoloring sequence of length $O(|G|^2)$. This problem has attracted much interest and work, including some impressive partial results. Nonetheless, the problem remains wide open, even in the case $d = 2$.

In this paper, we consider a list-coloring variant of this conjecture, and we make the lists large enough to guarantee a recoloring sequence with length $O(|G|)$. Specifically, we focus on graph classes \mathcal{G} and sizes k such that there exists a constant $C_{k,\mathcal{G}}$ satisfying the following: For every graph $G \in \mathcal{G}$ and every k -assignment L and every two L -colorings α and β , there exists a recoloring sequence from α to β that recolors each vertex at most $C_{k,\mathcal{G}}$ times. Typically, we take \mathcal{G} to be a hereditary class. To prove such a length bound of $O(|G|)$ by induction, we find a “good subgraph”

*Department of Computer Science, Virginia Commonwealth University, Richmond, VA, USA; dcranston@vcu.edu

H in G , claim the result for the smaller graph $G - H$, by the induction hypothesis, and then show that we can extend the result to G precisely because we chose H to be “good”. For these types of arguments, the following Extension Lemma is invaluable.

Lemma 1 (Extension Lemma). *Let G be a graph, L be a list assignment for G , and α and β be L -colorings for G . Fix $v \in V(G)$. Let $G' := G - v$, and let α' and β' be the restrictions to G' of α and β . Suppose there exists a recoloring sequence σ' that recolors G from α' to β' . If σ' recolors vertices in $N(v)$ a total of s times, then σ' extends to a recoloring sequence σ for G from α to β that recolors v at most $\left\lceil \frac{s}{|L(v)|-d(v)-1} \right\rceil + 1$ times.*

Proof. Let c_1, \dots, c_s denote the colors that are used by σ' to recolor $N(v)$, with multiplicity and in order. We show how to extend σ' to σ . Each time that σ will recolor $N(v)$ with some c_i that is currently used on v , we must first recolor v before we can continue with the recoloring step in σ' . Let $a := |L(v)| - d(v) - 1$. We must avoid all colors currently used on $N(v)$, as well as c_i , so we have at least a choices. We choose a color that does not appear among $c_i, c_{i+1}, \dots, c_{i+a-1}$. Thus, the number of times that we must recolor v , due to its current color being needed on $N(v)$, is at most $\left\lceil \frac{s}{|L(v)|-d(v)-1} \right\rceil$. To conclude, we may need one more step to recolor v to match $\beta(v)$. \square

The Extension Lemma has been used implicitly in many papers; it was first stated explicitly for coloring in [1], and generalized to list-coloring (with the same proof) in [5]. We note also that the same proof works in the more general context of “correspondence” coloring; however, we omit the definitions needed to make this formal, since including them would only add more abstraction without adding any more interesting ideas. (In fact, nearly all of the arguments in this paper work equally well for correspondence coloring. However, we will not mention this in what follows.)

For a graph G and list assignment L , let $\mathcal{C}_L(G)$ denote the graph with a node for each L -coloring of G and an edge between each pair of nodes that differ only in the color of a single vertex of G . Bousquet and Perarnau [3] used the Extension Lemma to prove the following pretty result.

Lemma 2 ([3]). *If G is a d -degenerate graph and L is a list assignment with $|L(v)| \geq 2d + 2$ for all $v \in V(G)$, then $\text{diam } \mathcal{C}_L(G) \leq (d + 1)|G|$.*

Proof. Let L be a list assignment as in the lemma, and fix L -colorings α and β . We prove that G can be recolored from α to β such that each vertex is recolored at most $d + 1$ times. Pick v such that $d(v) \leq d$. Let $G' := G - v$, and let α' and β' denote the restrictions to G' of α and β . By hypothesis, there exists a sequence σ' that recolors G from α' to β' and recolors each vertex at most $d + 1$ times. By the Extension Lemma, we can extend σ' to a sequence σ that recolors v at most $\left\lceil \frac{|N(v)|(d+1)}{2d+2-(d+1)} \right\rceil + 1 = |N(v)| + 1 \leq d + 1$ times. \square

Conjecture 3. *Let k, d be positive integers with $k \geq d + 3$. There exists a constant¹ C_d such that if G is a d -degenerate graph and L a k -assignment for G , then $\text{diam } \mathcal{C}_L(G) \leq C_d|G|$.*

The conjecture above was posed in [1] only for coloring (the case when $L(v) = \{1, \dots, k\}$ for all v), but here we extend it to list-coloring. In fact, we propose the following meta-conjecture.

¹A priori, we might want to allow C_d to also depend on k , but the stated version is equivalent, as follows. If the weaker version is true, then C_d^k exists for each $k \geq d + 3$. Let $C_d := \max\{d + 1, \max_{d+3 \leq k \leq 2d+1} C_d^k\}$. This suffices by the previous lemma.

Conjecture 4. For every “natural” graph class \mathcal{G} and positive integer k , if there exists $C_{k,\mathcal{G}}$ such that $\text{diam } \mathcal{C}_L(G) \leq C_{k,\mathcal{G}}|G|$ for all $G \in \mathcal{G}$ when $L(v) = \{1, \dots, k\}$ for all v , then also there exists $C'_{k,\mathcal{G}}$ such that $\text{diam } \mathcal{C}_L(G) \leq C'_{k,\mathcal{G}}|G|$ for all $G \in \mathcal{G}$ for every k -assignment L .

In particular, we pose this conjecture when \mathcal{G} is (i) the class of all graphs with maximum average degree less than a and (ii) the class of all planar graphs with girth at least g . As evidence in support of Conjecture 4 holding in case (ii), we summarize below how many colors are needed to imply that $\text{diam } \mathcal{C}_L(G) = O(|G|)$ for planar graphs with various lower bounds on girth.

# colors	10	7	6	5	4
girth \geq	3	4	5	6	11

Table 1: Best known bounds on list sizes needed for planar graphs of various girths to ensure $\text{diam } \mathcal{C}_L(G) = O(|G|)$.

In the case of coloring (without lists), the first two columns were proved by Dvořák and Feghali [6, 7]. They also conjectured the third column. Furthermore, they conjectured that the first two columns also hold in the more general context of list coloring.

In [1], its authors proved the fourth column. And their proof also works for list-coloring. In the same paper, they revisited the analogue of the first column for list-coloring. Since planar graphs are 5-degenerate, Lemma 2 implies the desired bound for lists of size 12. The authors extended this result to lists of size 11 using the Extension Lemma and the following result of Borodin: If G is planar with minimum degree 5, then G has a 3-face vwx with $d(v) + d(w) + d(x) \leq 17$.

In [5], the present author proved the third and fifth columns, even for list-coloring. The same paper proved the list-coloring analogue of the second column. However, the problem of a list-coloring analogue of the first column, as conjectured by Dvořák and Feghali [7], remained open. The authors of [4] proved the conjecture for certain planar graphs with maximum average degree less than $5.\overline{3}$. Our main contribution in this paper confirms this conjecture for all planar graphs.

Main Theorem. *There exists a constant C such that if G is a planar graph with a 10-assignment L and with L -colorings α and β , then there exists a recoloring sequence from α to β that recolors each vertex at most C times.*

A *configuration* is a subgraph H along with prescribed values of $d_G(v)$ for each vertex v in H . A configuration is *reducible* if it cannot appear in a k -minimal counterexample G (see Definition 1, at the start of the next section). Our proof of the Main Theorem uses the discharging method, with 35 reducible configurations. At first glance, verifying reducibility for so many configurations seems to be a daunting task. However, we introduce a new technique to handle most of the configurations in just over 4 pages, without any reliance on computer verification. We believe this technique will be of independent interest, and will likely have application to other problems in this area. In Section 2 we show that various configurations are reducible, and in Section 3 we use discharging to show that every plane triangulation contains at least one of these reducible configurations, and hence cannot be a k -minimal counterexample.

Our terminology and notation are standard, however we highlight a few terms. If $d(v) = k$, for some vertex v , then v is a k -vertex; if $d(v) \geq k$ or $d(v) \leq k$, then v is respectively a k^+ -vertex or a k^- -vertex. If v is a k -vertex and v is a neighbor of some vertex w , then v is a k -neighbor; analogously, we define k^+ -neighbor and k^- -neighbor. A *planar graph* is one that can be embedded in the plane with no edge crossings. A *plane graph* is a fixed plane embedding of a planar graph.

2 Reducibility

Definition 1. Fix a positive integer k . A recoloring sequence is k -good if every vertex is recolored at most k times. We aim to prove the follow: Fix a plane graph G and a 10-assignment L for G . For any two L -colorings α and β of G , there exists a k -good recoloring sequence σ from α to β . A k -minimal counterexample (to this statement) is a graph such that the statement is false, but the statement is true for every plane graph H with fewer vertices than G .

A *reducible configuration* (for some fixed k) is a subgraph H , with prescribed values $d_G(v)$ for all $v \in V(H)$, that cannot appear in a k -minimal counterexample. In this section, we compile a large set of reducible configurations. In the next section, we use a counting argument (via the discharging method) to show that every plane graph contains at least one of those reducible configurations. Thus, no plane graph G is a k -minimal counterexample. So the Main Theorem holds.

Recall that in the proof of the Extension Lemma, we might need a single step at the end to recolor the deleted vertex v to agree with β . In the present more general context, this final recoloring phase is handled by our next proposition.

Proposition 5. Fix a plane graph G , a subgraph H , a 10-assignment L , and L -colorings α and β that differ only on H . (i) Now G has a recoloring sequence from α to β that recolors each vertex of H at most twice (and recolors no other vertices) whenever there exists an order σ of $V(H)$ such that $d_G(v) + d_\sigma(v) \leq 9$ for all $v \in V(H)$, where $d_\sigma(v)$ is the number of neighbors of v that follow v in σ . (ii) In particular, this is true whenever H is 2-degenerate and $d_G(v) \leq 7$ for all $v \in V(H)$.

Proof. We use induction on $|H|$, and the base case, $|H| = 1$, is trivial. For the induction step, let v be the first vertex in σ and let $H' := H - v$. Recolor v to avoid all colors currently used on its neighbors, as well as all colors used on its neighbors in β . (This is possible because $d_G(v) + d_H(v) = d_G(v) + d_\sigma(v) \leq 9$, by hypothesis.) By the induction hypothesis, recolor H' to agree with β , treating v as a vertex of G . Finally, recolor v to agree with β . (ii) Since H is 2-degenerate, there exists σ such that $d_\sigma(v) \leq 2$ for all $v \in V(H)$. Thus, $d_G(v) + d_\sigma(v) \leq 7 + 2 = 9$. So we are done by (i). \square

Remark 6. Throughout this paper, in various subgraphs H we use vertex shapes to denote vertex degrees in a larger graph G , as follows; see Figure 1. Degree 5 is a square, degree 6 is a circle, degree 7 is a pentagon, and degree 8 is a hexagon. If only a lower bound on degree is known, then the corresponding node is drawn as dashed. For example, a vertex of degree at least 6 is drawn as a dashed circle. If no nontrivial degree bound is known (or our argument does not depend on such a bound), then we simply do not draw a shape for the node. This (absence of shape) will not occur in the present section on reducibility, but will occur frequently in the section on unavoidability. In Figure 10, vertex v is a 5-vertex, w_4 is a 7-vertex, w_1 is an 8^+ -vertex; for each remaining vertex, either it is a 6-vertex, or we claim no bound on its degree.

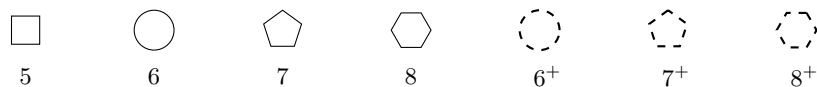

Figure 1: Vertex degree as denoted by shape

Before introducing our general approach, we first illustrate it on one particular small configuration. The general outline of the proof draws heavily on ideas from the proof of the Extension Lemma. However, that lemma is not well-suited for the case of k -assignments when k is even (such as 10). And it is easy to check that we cannot use it directly to prove reducibility of any of our reducible configurations. So, rather than deleting a single vertex at a time, we instead delete all vertices in the configuration H at once. When we extend our recoloring sequence from $G - H$ to G , we generally do not have any of the vertices of H “defer” to each other. That is, for vertices $v, w \in H$ with $vw \in E(H)$, if vertex v must be recolored due to some upcoming recoloring in $N_G(v) \setminus N_H(v)$, then v must avoid the color currently on w . But also w will need to avoid the color used on v when roles are reversed. (But still there are some exceptions to this general rule.)

Lemma 7. *The subgraph in Figure 2 appears in no k -minimal counterexample with $k \geq 416$.*

Proof. Suppose the lemma is false. Fix a plane graph G , an integer $k \geq 416$, a 10-assignment L , and L -colorings α and β witnessing this. Denote $V(H)$ by v, w, x, y, z , as shown in Figure 2. Let $G' := G - V(H)$. Let α' and β' denote the restrictions to G' of α and β . Since G is k -minimal, there exists a k -good recoloring sequence σ' from α' to β' . We show how to extend σ' to a k -good recoloring sequence for G from α to β . By Proposition 5, once we have recolored G to match β on $V(G) \setminus V(H)$, we can recolor the vertices of H to match β by recoloring each vertex of H at most 2 times.

Let a_1, \dots denote the sequence of colors that appear on $N_G(v) \setminus N_H(v)$, in order, during σ' . Similarly, we define b_1, \dots for w ; c_1, \dots for x ; d_1, \dots for y ; and e_1, \dots for z . To extend σ' to σ , each time that the current color on v , call it $\varphi(v)$ appears as some a_i on some vertex in $N_G(v) \setminus N_H(v)$, we first recolor vertex v , and possibly some other vertices in H to avoid a_i . When we are recoloring v to avoid a_i , we must avoid the colors currently used on all neighbors of v (both outside and inside H). However, since $|L(v)| \geq 10$ and $d(v) = 5$, we have at least 5 available colors for v , and we can choose one to avoid $\{a_i, a_{i+1}, a_{i+2}, a_{i+3}\}$. By hypothesis, each neighbor of v is recolored at most k times in σ' , so when we extend σ' to H vertex v is recolored at most $4k/4 = k$ times. However, we may need 2 more recoloring steps at the end of this sequence to get the correct colors on H . So we need something slightly more subtle.

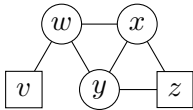

Figure 2: This configuration appears in no k -minimal counterexample with $k \geq 416$.

While $i \leq 40$, when we need to recolor vertex v to avoid color a_i , we do not require that v avoid the color currently on w ; thus v will have at least 6 available colors, and can avoid the colors on $N_G(v) \setminus \{w\}$, as well as $a_i, a_{i+1}, a_{i+2}, a_{i+3}, a_{i+4}$. If we want to recolor v with the color $\varphi(w)$ on w , then we first recolor w to avoid $\varphi(w)$ and all colors currently used on $N(w)$, as well as b_{j+1} and b_{j+2} , the next two colors that appear in $N(w) \setminus N_H(w)$. After recoloring w , we recolor v with $\varphi(w)$ as desired. Thus, the number of times we recolor v is at most $(4k - 40)/4 + 40/5 + 2 = k$.

Now we do something similar for w . In general, when we need to recolor w to avoid b_i , we do it to avoid each color currently on $N(w)$, as well as to avoid b_i, b_{i+1}, b_{i+2} . However, when $i \leq 120$ we do not require that w avoid the color $\varphi(x)$ currently on x . As above, if we want to recolor w with $\varphi(x)$, then we first recolor x to avoid each color currently on $N[x]$, as well as c_{j+1} and c_{j+2} . After recoloring x , we recolor w with $\varphi(x)$. Thus, the number of times we recolor w is at most $(3k - 120)/3 + 120/4 + 40/5 + 2 = k$.

For x , in general when we need to recolor x to avoid c_i , we do it to avoid each color currently on $N(x)$, as well as to avoid c_i, c_{i+1}, c_{i+2} . However, when $i \leq 384$ we do not require that x avoids

the color $\varphi(z)$ currently on z ; and we recolor z first if we want to recolor x with $\varphi(z)$. Thus, the number of times we recolor x is at most $(3k - 384)/3 + 384/4 + 120/4 + 2 = k$.

For y , in general when we need to recolor y to avoid d_i , we do it to avoid each color currently on $N(y)$, as well as to avoid d_i, d_{i+1}, d_{i+2} . However, when $i \leq 24$ we do not require that y avoids the color $\varphi(z)$ currently on z ; and we recolor z first if we want to recolor d with $\varphi(z)$. Thus, the number of times we recolor y is at most $(3k - 24)/3 + 24/4 + 2 = k$.

For z , whenever we need to recolor z to avoid e_i , we do it to avoid each color currently on $N(z)$, as well as to avoid $e_i, e_{i+1}, e_{i+2}, e_{i+3}$. Thus, the number of times we recolor z is at most $\lceil 3k/4 \rceil + 384/4 + 24/4 + 2 \leq k$; here we use that $k \geq 416$.

We remark that it is possible that some vertex u outside H is about to be recolored with a color currently used on two vertices of H . In that case, we can break the tie arbitrarily. For example if the color is currently used on vertices v and y , then we first remove it from v and later remove it from y , or vice versa. (The proof also works if vertices v and z are identified, but we defer these details to the end of the proof of Lemma 9.) \square

Lemma 8. *A 7^- -vertex with no 7^+ -neighbor is k -reducible (for all $k \geq 44$).*

Proof. Suppose that our k -minimal counterexample G contains a 7^- -vertex v with only 6^- -neighbors. Denote these neighbors by $w_1, \dots, w_{d(v)}$. As in the previous lemma, we get a recoloring sequence σ' for $G - N[v]$ and extend it to $N[v]$. For each of the first 24 colors that appears in $N_G(w_1) \setminus N_{N[v]}(w_1)$ if we want to recolor w_1 with the color currently on v , then we do so, after first recoloring v to avoid all colors currently used on $N[v]$. Thus, the number of times that w_1 is recolored is at most $(3k - 24)/3 + 24/4 + 2 = k$. We handle each other w_i identically. Thus, the number of times that v is recolored is at most $(24/4)d(v) + 2 = 44$. \square

For convenience, we record the reducible configurations from Lemma 8 in Figure 3(14,25,26), along with all the configurations that we handle in our next lemma.

The argument provings Lemmas 7 and 8 works much more generally, and we will use it (in a more general form) to show that another 30 configurations are k -reducible for $k \geq 416$. For these remaining configurations our proofs will be more terse, somewhat closer to just a certificate of reducibility.

Lemma 9. *Each of (RC1)–(RC30), shown in Figure 3, is k -reducible for all $k \geq 416$.*

Proof. For a connected subgraph H to be reducible, we require (a) that

$$d_H(v) \geq 2d_G(v) - 9 \tag{*}$$

for all vertices $v \in V(H)$. The H that we show reducible will have $d_G(v) \in \{5, 6, 7\}$ for each $v \in V(H)$. We also require (b) that there exists some vertex v such that inequality $(*)$ holds with strict inequality. Every such subgraph H will be k -reducible for sufficiently large k . We highlight that this criteria is easy to quickly check by hand. So it is simple for a person to identify reducible configurations while constructing a discharging proof. The exact value of k is not so important; the key conclusion of our proof will be that G has a recoloring sequence of length $O(|G|)$. However, as mentioned above we will show that (for all the configurations in Figure 3) we can let $k = 416$.

A *well*, in a subgraph H of G , is a vertex v such that the inequality in $(*)$ is strict. To prove that a configuration is reducible, we exhibit a directed acyclic graph in which each component is

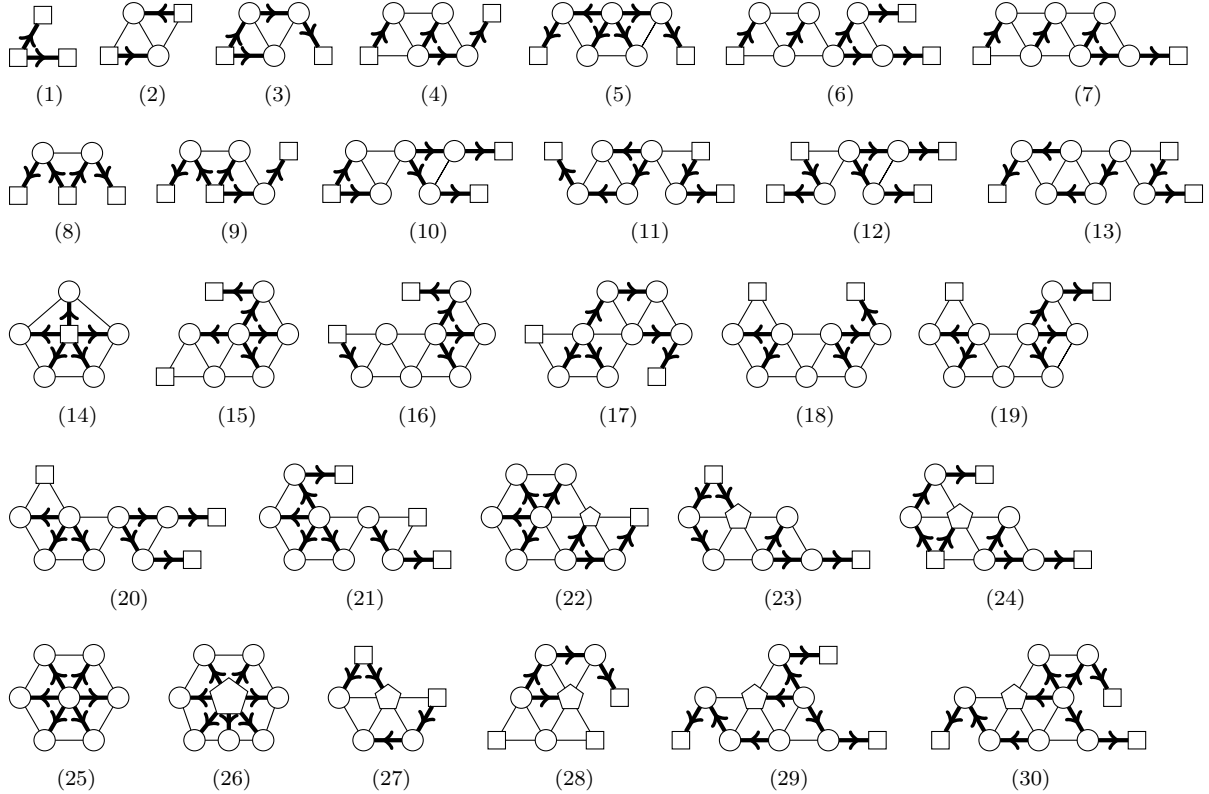

Figure 3: 30 configurations shown reducible by Lemmas 7, 8, and 9

an out-tree (a tree directed outward from a root) that is rooted at some well. Intuitively, the well provides support to each other vertex in its out-tree. As the order (and diameter) of the out-tree \vec{T} increase, so does the smallest k for which \vec{T} can be used to prove a configuration is k -reducible.

We write r_s to denote a vertex of degree r in G and degree s in H . Our wells will typically be 5_2 -vertices and 6_4 -vertices, although we occasionally use 5_3 -, 5_4 -, 5_5 -, 6_5 -, or 6_6 -vertices. For example, Figure 4(4) shows a 6_4 -vertex with four 6_3 -neighbors, two of which each have their own 5_2 -neighbors. Our calculations will consider together all the vertices in a single out-tree, showing that each is recolored at most k times.

When an out-tree has an isomorphism mapping two vertices to each other, the calculations we perform for each of these two vertices will be identical. So we typically label them with the same letter, and different subscripts, to highlight this; and we only perform the calculations once.

A key advantage of this approach is that we can perform the calculations for distinct out-trees independently. What is more, we can reuse these same calculations to prove the reducibility of many configurations. It is easy to check that if a calculation works for an out-tree \vec{T} , then it also works for any out-tree \vec{T}' that results by deleting a leaf from \vec{T} . Similarly, we can replace any r_s -vertex in an out-tree with either an r_{s+1} -vertex or an $(r-1)_s$ -vertex; both types of modification reduce the number of constraints on our recoloring sequence, so the calculations for the original out-tree also certify the new out-tree. It is also helpful to note that we can replace any 5_2 -vertex root of an out-tree with a 6_4 -vertex root (the computation allowing this replacement essentially rests on the fact that $(6-4)/(10-6-1) = 2/3 < 3/4 = (5-2)/(10-5-1)$). Furthermore, we can replace

any 5_1 -vertex leaf in an out-tree with a 6_3 -vertex leaf, and we can replace any 6_3 -vertex leaf with a 7_5 -vertex leaf (the validity of these replacements use the fact that $1/(3 \times 2) > 1/(4 \times 3) > 1/(5 \times 4)$). Finally, if a 6_3 -vertex supports only a single leaf 5_1 -vertex, then the $(6_3(5_1))$ can be replaced by a single 5_1 . We call any tree resulting from a sequence of zero or more of any combination of these operations a *pruning* of \vec{T} . In this paper, all of our out-trees have radius at most 3, although in principle the same technique could be applied to out-trees of arbitrary (but bounded) radius.

We now proceed with the calculations for four specific out-trees, shown in Figure 4; we call the set of these \mathcal{J} , and we denote the set of prunings of \mathcal{J} by $\text{prune}(\mathcal{J})$. As we have done previously, we denote each 5-vertex by a square and each 6-vertex by a circle. Pendant half-edges denote edges to vertices in subgraph H , but do not specify the other endpoints of these edges. Afterwards, we list most of our reducible configurations. Given the calculations preceeding the configurations, to prove reducibility for a configuration H it suffices to cover the vertices of H with out-trees in $\text{prune}(\mathcal{J})$. We do this in Figure 3.

(1) We have w_1 defer to x_1 for the first 40 colors that appear in $N_G(x_1) \setminus N_H(x_1)$. So the number of times that x_1 is recolored is at most $\lceil (4k - 40)/4 \rceil + (40/5) + 2 = k$. We have v defer to w_1 for the first 120 colors that appear in $N_G(w_1) \setminus N_H(w_1)$. So the number of times that w_1 is recolored is at most $\lceil (3k - 120)/3 \rceil + (120/4) + (40/5) + 2 = k$. The calculations for w_2 and x_2 are identical to those for w_1 and x_1 . Finally, the number of times that v is recolored is at most $\lceil 3k/4 \rceil + 120/4 + 120/4 + 2$. This expression is at most k when $k \geq 4(30 + 30 + 2) = 248$.

(2) The calculations for x and y are identical to those for w_1 and x_1 in (1). Recall that x may be recolored up to $120/4 = 30$ times due to y . We have v defer to w for the first 384 colors that appear in $N_G(w) \setminus N_H(w)$. So the number of times that w is recolored is at most $\lceil (3k - 384)/3 \rceil + (384/4) + (120/4) + 2 = k$. We also have v defer to z for the first 24 colors that appear in $N_G(z) \setminus N_H(z)$. So the number of times that z is recolored is at most $\lceil (3k - 24)/3 \rceil + (24/4) + 2 = k$. Thus, the number of times that v is recolored is at most $\lceil 3k/4 \rceil + (384/4) + (24/4) + 2$. This expression is at most k when $k \geq 4(96 + 6 + 2) = 416$.

(3) The calculations are the same as in (1) for w_1, w_2, x_1, x_2 . And the calculations for y is the same as for z in (iv). Thus, the number of times that v is recolored is at most $\lceil 2k/4 \rceil + (120/4) + (120/4) + (24/4) + 2$. This expression is at most k when $k \geq 2(30 + 30 + 6 + 2) = 136$.

(4) The calculations are the same as in (3) for $w_1, w_2, x_1, x_2, y_1, y_2$. Thus, the number of times that v is recolored is at most $\lceil 2k/3 \rceil + (120/4) + (120/4) + (24/4) + (24/4) + 2$. This expression is at most k when $k \geq 3(30 + 30 + 6 + 6 + 2) = 222$.

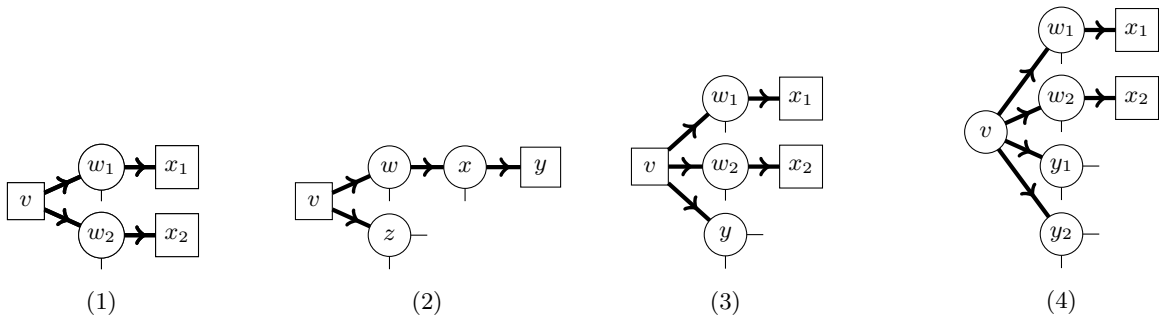

Figure 4: The 4 configurations in the proof of Lemma 9

We note that our reducibility proof does not require that these configurations appear as induced subgraphs. The argument works equally well for subgraphs that are not induced. The proofs also work when vertices at pairwise distance 3 or more are identified, as long as all but one of the identified vertices is a leaf in its out-tree. For example, if a 5_2 - and a 5_1 -vertex are identified, the result is a 5_3 -vertex. So in the collection of out-trees witnessing the configuration's reducibility, we can simply prune the 5_1 -vertex from its out-tree. (Note that each 5_1 -vertex is necessarily a leaf in its out-tree.) One other case of possible vertex identification is worth noting. Suppose that a configuration has two 6_3 -vertices, at least one of which supports only a 5_1 -vertex. If these vertices are identified, then we simply delete the 5_1 -vertex from the resulting configuration. The identified vertex is now a 6_5 -vertex, and the 6_3 -vertex that was supporting the (now deleted) 5_1 -vertex can be deleted from its out-tree, along with the deleted 5_1 -vertex. \square

2.1 One More Wrinkle

The technique we introduced to prove Lemma 9 is powerful. However, to handle a few more reducible configurations, we will need to extend it a bit. Rather than stating this extension in a general form, we only state the particular special cases that we need for our 4 remaining reducible configurations. However, the reader should find that generalizing it is straightforward.

Lemma 10. *If G is a k -minimal counterexample, then G has none of the configurations in Figure 5.*

Proof. (1) Suppose the contrary. Let G, L, α, β be a counterexample, let $H := G[\{v_1, v_2, w\}]$, let $G' := G - \{v_1, v_2\}$, and let $G'' := G - V(H)$. Let α' and β' denote the restrictions of α and β to G' , let α'' and β'' denote the restrictions of α and β to G'' , and let σ'' denote a k -good reconfiguration sequence from α'' to β'' . By the Extension Lemma, we can extend σ'' to a k -good reconfiguration sequence σ' in G' from α' to β' . Furthermore, w is recolored at most $\lceil 4k/5 \rceil + 1$ times.

Now we extend σ' to a k -good recoloring sequence from α to β . Neither v_1 nor v_2 defers to the other. So the number of recolorings in $N(v_1)$ that might cause us to recolor v_1 is at most $3k + \lceil 4k/5 \rceil + 1$. Since $|L(v_1)| - d_G(v_1) - 1 = 10 - 5 - 1 = 4$, the total number of recolorings of v_1 is at most $\lceil (3k + \lceil 4k/5 \rceil + 1)/4 \rceil + 2 \leq k$. The same argument works for v_2 .

(2) The argument is nearly identical to that for (1): First we extend to w , then to v_1 and v_2 , and finally to v_3 and v_4 , with the same analysis as for v_1 and v_2 .

For each of (3)–(5), we use the same approach. It is similar to what we did in (a), but also reuses aspects of our approach in the proof of Lemma 9.

(3) Let $G' := G - \{v_1, v_2\}$ and $G'' := G' - \{w_1, w_2, w_3\}$. Define $\alpha', \beta', \alpha'', \beta''$ analogously to above. By minimality, we have a k -good recoloring sequence σ'' for G'' from α'' to β'' . We extend σ'' simultaneously to $\{w_1, w_2, w_3\}$. Most of the time, none of w_1, w_2, w_3 defers to each other. But for the first 40 colors that appear in $N_G(w_1) \setminus \{w_2\}$, we have vertex w_2 defer to w_1 ; that is, w_2 will be recolored if w_1 wants to use the color currently on w_2 . So the number of times w_1 is recolored is at most $(4k - 40)/4 + 40/5 + 2 = k$. Similarly, w_2 defers to w_3 for the first 40 colors that appear in $N_G(w_3) \setminus \{w_2\}$. Thus, the number of times that w_2 is recolored is at most $\lceil 3k/4 \rceil + 40/5 + 40/5 + 2 \leq 3k/4 + 19 \leq k - 8$, since $k \geq 108$. Finally, we extend σ' to v_1 and v_2 , with neither deferring to the other. So the number of times that v_1 is recolored is at most $(4k - 8)/4 + 2 = k$, as desired. The analysis for v_2 is identical.

(4) We just provide a sketch. We get a k -good recoloring sequence for $G - \{v_1, v_2, w_1, w_2, w_3\}$. We extend it simultaneously to w_1, w_2, w_3 . We have w_2 defer to w_1 for the first 200 colors that appear

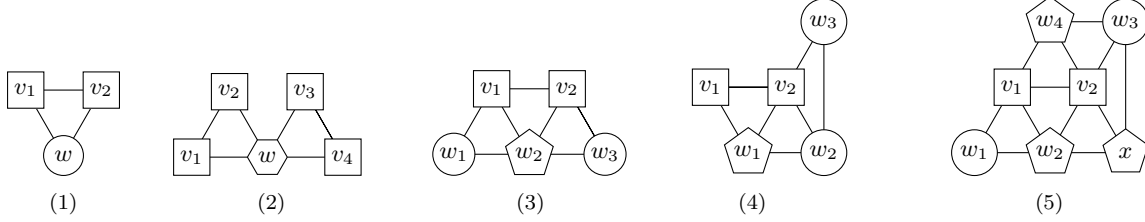

Figure 5: 5 more reducible configurations

in $N_G(w_1) \setminus \{w_2\}$. So the number of times that w_1 is recolored is at most $(4k - 200)/4 + 200/5 + 2 = k - 50 + 40 + 2 = k - 8$. Similarly, w_2 defers to w_3 for the first 40 colors that appear in $N_G(w_3) \setminus \{w_2\}$. So the number of times that w_3 is recolored is at most $(4k - 40)/4 + 40/5 + 2 = k - 10 + 8 + 2 = k$. And the number of times that w_2 is recolored is at most $\lceil 3k/4 \rceil + 200/5 + 40/5 + 2 \leq \lceil 3k/4 \rceil + 50 \leq k$, since $k \geq 200$. Finally, we extend this recoloring sequence to v_1 and v_2 , with neither deferring to the other. Now the number of times that v_1 is recolored is at most $(4k - 8)/4 + 2 = k$, as desired. The analysis for v_2 is identical.

(5) Again, we just provide a sketch. We first get a k -good recoloring sequence for $G - \{v_1, v_2, w_1, w_2, w_3, w_4, x\}$. By the Extension Lemma, we extend it to x . So the number of times x gets recolored is at most $\lceil 4k/5 \rceil + 2 \leq k - 72$, since $k \geq 5(74) = 370$. Now we simultaneously extend to w_1 and w_2 , except that w_2 defers to w_1 for the first 40 colors appearing in $N_G(w_1) \setminus \{w_2\}$. So the number of times w_2 is recolored is at most $(4k - 72)/4 + 40/5 + 2 = k - 8$. And the number of times w_1 is recolored is at most $(4k - 40)/4 + 40/5 + 2 = k$. When we simultaneously extend to w_3 and w_4 , the analysis is identical, so we omit it. Finally, we extend to v_1 and v_2 . The number of times v_1 is recolored is at most $(4k - 8)/4 + 2 = k$. And the analysis for v_2 is identical. \square

3 Discharging

In this section, we prove the Main Theorem. To do so, we assume it is false, and let G be a k -minimal counterexample (with $k = 416$, say). We use the discharging method to prove that G must contain one of the configurations from the previous section, all of which we showed cannot appear in a k -minimal counterexample. This contradiction proves the Main Theorem. Before describing our discharging argument, we make the following easy observation.

Observation 11. *Our graph G has minimum degree at least 5.*

Proof. This follows directly from the Extension Lemma, analogous to the proof of Lemma 2. \square

Among all k -minimal counterexamples G , we choose one to maximize the number of edges. Thus, G is a plane triangulation. We assign to each vertex v in G a “charge” $d(v) - 6$. By Euler’s formula, $\sum_{v \in V(G)} (d(v) - 6) = 2|E(G)| - 6|G| = 2(3|G| - 6) - 6|G| = -12$. Assuming that G contains none of the configurations in the previous section, we redistribute charge so that each vertex v ends with nonnegative charge; we say that such a vertex v *ends happy*. This yields an obvious contradiction, since the sum of nonnegative quantities is equal to -12 . (And this contradiction proves our Main Theorem.) To redistribute charge, we use the following 6 discharging rules, applied successively.

- (R1) Let v be a 7-vertex and w be a 5-neighbor of v . If vw lies on a $(7, 5, 5)$ -face, then v sends $1/4$ to w ; otherwise, v sends $1/3$ to w .
- (R2) If v is a 7-vertex and w is a 6-neighbor of v and vw does not lie on a $(7, 6, 5)$ -face, then v sends $1/6$ to w .
- (R3) If v is an 8^+ -vertex and w is a 5-neighbor of v , then v sends $1/2$ to w .
- (R4) If v is an 8^+ -vertex and w is a 6-neighbor of v and vw does not lie on an $(8^+, 6, 5)$ -face, then v sends $1/4$ to w .
- (R5) If a 6-vertex v has charge, but has no 5-neighbor, then v splits its charge equally among its 6-neighbors (if any) that do have 5-neighbors.
- (R6) Each 6-vertex with a 5-neighbor splits its charge equally among its 5-neighbors.

In the rest of the section, we show that every vertex ends happy (finishes with nonnegative charge). We first handle the 6^+ -vertices, which requires only a straightforward case analysis, based on (R1)–(R4). The bulk of our work in this section goes to handling 5-vertices. For this we consider a number of cases based on the degrees of the neighbors of the 5-vertex. Since G has no copy of (RC14), every 5-vertex has at least one 7^+ -neighbor. Note that a vertex receiving more charge than claimed never hinders that vertex from ending happy. Thus, we focus on proving lower bounds on the charge that each 5-vertex receives. With this in mind, we typically write that “ v gives μ to w ” to mean that vertex v gives vertex w charge at least μ .

Lemma 12. *Each 6^+ -vertex ends happy.*

Proof. Each 6-vertex starts with 0. By (R5) and (R6), each 6-vertex also ends with at least 0 (and gives each 5-neighbor nonnegative charge).

Let v be a 7-vertex. Let s be the number of 5-neighbors of v ; we consider the following cases for s . First, $s = 0$: If v has seven 6-neighbors, then G has (RC26); so v has at most six 6-neighbors. Thus, v ends with at least $(7 - 6) - 6(1/6) = 0$. Next, $s = 1$: Now two 6^+ -neighbors of v each have a common (successive) 5-neighbor with v , so cannot get charge from v . Thus, v ends with at least $1 - 1/3 - (7 - 1 - 2)(1/6) = 1 - 1/3 - 4(1/6) = 0$.

Next, $s = 2$: Suppose v has successive 5-neighbors. They each get $1/4$ from v by (R1). Also, two 6-neighbors of v have a common (successive) 5-neighbor with v , so do not receive charge from v . Thus, v ends with at least $1 - 2(1/4) - (7 - 2 - 2)(1/6) = 1 - 2(1/4) - 3(1/6) = 0$. Suppose instead that the 5-neighbors of v are not successive. Now each gets $1/3$, and at least three 6^+ -neighbors of v get no charge from v by (R3) because they have a common (successive) 5-neighbor with v . So v ends with at least $1 - 2(1/3) - (7 - 2 - 3)(1/6) = 0$.

Finally, $s = 3$: If the three 5-neighbors of v are pairwise non-successive, then they each get $1/3$, and no other neighbor of v gets charge by (R3). So v ends with $1 - 3(1/3) = 0$. Suppose instead that two 5-neighbors of v are successive. Each gets $1/4$ from v . (Each 5-vertex has at most one 5-neighbor, or G contains (RC1).) The other 5-neighbor of v gets $1/3$. Finally, at most one 6^+ -neighbor of v gets charge $1/6$ from v . So v ends with at least $1 - 2(1/4) - 1/3 - 1/6 = 0$.

Now let v be an 8-vertex. Again, let s be the number of 5-neighbors of v . If $s = 0$, then v ends with at least $8 - 6 - 8(1/4) = 0$. If $s = 1$, then v ends with at least $2 - 1/2 - (8 - 2 - 1)(1/4) = 2 - 1/2 - 5(1/4) > 0$. If $s = 2$, then v ends with at least $2 - 2(1/2) - 4(1/4) = 0$. If $s = 3$, then

not all three of its 5-neighbors are consecutive, so v ends with at least $2 - 3(1/2) - 2(1/4) = 0$. Finally, if $s = 4$, then v cannot have three successive 5-neighbors, or G contains (RC1); and v also cannot have two pairs of successive 5-neighbors, or G contains (RC2). So each 6^+ -neighbor of v has a successive common 5-neighbor with v . Thus, no 6^+ -neighbors of v get charge by (R4). Hence, v ends with $2 - 4(1/2) = 0$.

Finally, let v be a 9^+ -vertex. If we consider any three successive neighbors of v , then at most two of them are 5-neighbors, or G contains (RC1). And if two of these are 5-neighbors, then the third gets no charge from v by (R4). Thus, the average charge that v gives to any three consecutive neighbors is at most $(1/2 + 1/2 + 0)/3 = 1/3$. As a result, the average charge that v gives to all of its neighbors is at most $1/3$. So v ends with at least $d(v) - 6 - d(v)/3 = 2(d(v) - 9)/3 \geq 0$. \square

Lemma 13. *Each pair of adjacent 5-vertices ends happy.*

Proof. Let v_1 and v_2 be adjacent 5-vertices and label the vertices of $N[\{v_1, v_2\}]$ as in Figure 6. Note that w_1 must be a 7^+ -vertex; otherwise, $G[\{v_1, v_2, w_1\}]$ is (RC1). Similarly, w_4 is a 7^+ -vertex.

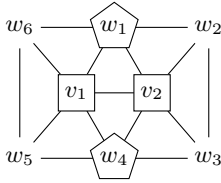

Figure 6: Adjacent 5-vertices

First suppose w_1 is an 8^+ -vertex. If w_4 is also an 8^+ -vertex, then v_1 and v_2 each receive at least $2(1/2) = 1$, so we are done. Suppose instead that w_4 is a 7-vertex. Now one of w_2 and w_3 is a 7^+ -vertex, or $N[w_4]$ contains (RC4). Similarly, one of w_5 and w_6 is a 7^+ -vertex. Now v_1 and v_2 each receive at least $1/2 + 1/3 + 1/6 = 1$, and we are done.

Instead assume w_1 and w_4 are both 7-vertices. First suppose w_2, w_3, w_5, w_6 are all 7^- -vertices. Now we show that at least three of w_2, w_3, w_5, w_6 are 7-vertices. If w_2 and w_3 are both 6-vertices, then $G[\{v_1, v_2, w_1, w_2, w_3\}]$ is (RC4). Similarly, if w_2 and w_6 are both 6-vertices, then $G[\{v_1, v_2, w_1, w_2, w_6\}]$ is (RC3). Thus, at least one vertex in $\{w_2, w_3\}$ is a 7-vertex. Similarly for $\{w_3, w_5\}$; and $\{w_5, w_6\}$; and $\{w_6, w_2\}$. If at most two of w_2, w_3, w_5, w_6 are 7-vertices, then by symmetry we assume w_2, w_5 are 6-vertices and w_3, w_6 are 7-vertices. But now $G[\{v_1, v_2, w_1, w_2, w_3, w_4, w_5\}]$ is (RC5).

Assume instead that w_2 is an 8^+ -vertex. If any of w_3, w_5, w_6 is an 8^+ -vertex, then in total v_1 and v_2 get $2(1/2) + 4(1/4) = 2$. So assume w_3, w_5, w_6 are 7^- -vertices. If at least two of them are 7-vertices, then in total v_1 and v_2 get $1/2 + 4(1/4) + 2(1/3) > 2$. So assume two of w_3, w_5, w_6 are 6-vertices and one is a 7-vertex. If w_3 and w_5 are 6-vertices, then $G[\{v_1, v_2, w_3, w_4, w_5\}]$ is (RC3). If w_5 and w_6 are 6-vertices, then $G[\{v_1, v_2, w_4, w_5, w_6\}]$ is (RC4). So assume w_3 and w_6 are 6-vertices, and w_5 is a 7-vertex. Now $G[\{v_1, v_2, w_1, w_3, w_4, w_5, w_6\}]$ is (RC5). \square

Lemma 14. *Each 5-vertex with three (or more) 7^+ -neighbors ends happy.*

Proof. By Lemma 13, we assume v has no 5-neighbor. So v ends with at least $-1 + 3(1/3) = 0$. \square

Before we start handling various possibilities for the neighborhood of a 5-vertex v , we first prove a few lemmas about how much charge reaches v from vertices at distance 2.

Lemma 15. *Let v be a 5-vertex, and let w_2, w_3, x_3 be 6-vertices, such that v, w_2, w_3, x_3 have all edges among them shown in Figure 7. If w_2 and w_3 each have no 5-neighbor but v , then x_3 sends v at least $1/6$ via w_2 and w_3 .*

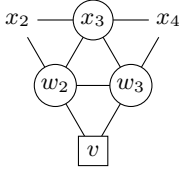

Figure 7: Vertex x_3 gives $1/6$ to v via w_2 and w_3

Proof. First note that x_3 has no 5-neighbor y , since then $G[\{v, w_2, w_3, x_3, y\}]$ contains (RC3). Note also that x_3 must have at least one 7^+ -neighbor; otherwise, $G[N[x_3]]$ contains (RC25). If x_3 has at least two 7^+ -neighbors, then they each give $1/6$ to x_3 (since x_3 has no 5-neighbors). Now x_3 has at least $1/3$ and splits it among at most four vertices by (R5), two of which are w_2 and w_3 . Since w_2 and w_3 each have no 5-neighbor but v , they send all of this charge to v . So v gets $1/6$, as desired.

Finally, suppose that x_3 has a single 7^+ -neighbor, a vertex other than x_2 and x_4 ; call it y . (Here x_2 and x_4 are as shown in Figure 7.) If x_2 has a 5-neighbor y' , then $G[\{v, w_2, w_3, x_2, x_3, y'\}]$ contains (RC4). So x_2 has no 5-neighbor; likewise for x_4 . A similar argument works for the neighbors of x_3 outside of $\{w_2, w_3, x_2, x_4\}$, or else G contains (RC5). Furthermore, if x_i is a 7^+ -vertex, with $i \in \{2, 4\}$, and a 6-neighbor y of x_3 (outside $\{w_2, w_3, x_2, x_4\}$) has a 5-neighbor y' , then $G[N[x_3] \cup \{v, y'\}] - x_i$ contains (RC5) or (RC15). \square

A 6-vertex is *needy* if it has at least one 5-neighbor.

needy

Lemma 16. *Let v be a 5-vertex, let w_2, w_3, x_3 be 6-vertices and suppose that v, w_2, w_3, x_2, x_3 induce all edges shown among them in Figure 8. If w_2 has v as its only 5-neighbor, then x_2 gives $1/6$ to v via w_2 .*

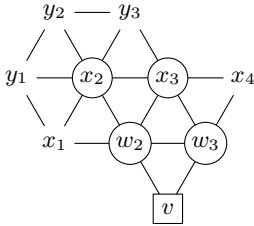

Figure 8: Vertex x_2 gives $1/6$ to v via w_2

Proof. The proof is similar to that of Lemma 15 above. If x_2 is a 7^+ -vertex, then it gives $1/6$ to v via w_2 . So assume x_2 is a 6-vertex.

None of x_1, x_3, y_3 is needy, or G contains (RC3) or (RC5). Similarly, at most one of y_1 and y_2 is needy, or G contains (RC6). If at least two of x_1, y_1, y_2, y_3 is a 7^+ -vertex, then x_2 gets at least $2(1/6)$ and gives at least half of this to w_2 , and on to v . Suppose instead that exactly one of x_1, y_1, y_2, y_3 is a 7^+ -vertex. Now no neighbors of x_2 are needy except for w_2 , or else G contains (RC7), (RC16), (RC17), or (RC23). So x_2 gets at least $1/6$ and passes that all to w_2 , and on to v . \square

Lemma 17. *Each 5-vertex with a 7^+ -neighbor and another 8^+ -neighbor ends happy.*

Proof. If a 5-vertex v has at least two 8^+ -neighbors, then v gets $2(1/2) = 1$, and we are done. So assume that the 7^+ -neighbor is a 7-neighbor.

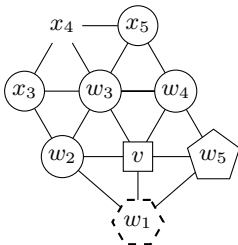

Figure 9: A 5-vertex with an 8^+ -neighbor, a 7-neighbor, and three successive 6-neighbors

Suppose that w_1 is an 8^+ -vertex, w_5 is a 7-vertex, and w_2, w_3, w_4 are all 6-vertices; see Figure 9. Note that x_3 is a 6^+ -vertex, or else $G[\{v, w_2, w_3, x_3\}]$ contains (RC2). Similarly, x_5 is a 6^+ -vertex. Suppose that x_3 is a 7^+ -vertex. If x_4 is a 6^+ -vertex, then x_3 gives $1/6$ to w_3 and all of that charge continues to v . So v gets $1/2 + 1/3 + 1/6 = 1$, and we are done. But if x_4 is a 5-vertex, then w_2 has no 5-neighbor y , or $G[\{v, w_2, w_3, x_4, y\}]$ contains (RC8). So x_3 gives $1/6$ to w_2 , and this all reaches v . So we instead assume x_3 is a 6-vertex. Similarly, we assume x_5 is a 6-vertex. If x_4 is a 6^- -vertex, then $N[w_3]$ contains (RC25); so assume x_4 is a 7^+ -vertex. But now x_4 gives $1/6$ to v via w_3 , so we are done.

Suppose instead that w_1 is an 8^+ -vertex, that w_4 is a 7-vertex, and that w_2, w_3, w_5 are all 6-vertices; see Figure 10. Note that x_3 is a 6^+ -vertex, or else $G[\{v, w_2, w_3, x_3\}]$ contains (RC2). If x_3 is a 7^+ -vertex, then at most one of w_2 and w_3 has a 5-neighbor other than v , or G contains (RC8). So x_3 gives at least $1/6$ to w_2 or w_3 that all continues on to v ; now v gets at least $1/2 + 1/3 + 1/6 = 1$. Thus, we assume x_3 is a 6-vertex.

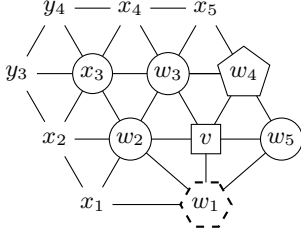

Figure 10: A 5-vertex with an 8^+ -neighbor, a 7-neighbor, and three non-successive 6-neighbors

Note that x_3 has no 5-neighbor y , or $G[\{v, w_2, w_3, x_3, y\}]$ contains (RC3). Note also that one of x_2, x_4, y_3, y_4 must be a 7^+ -vertex, or else $G[N[x_3]]$ contains (RC25). We show that x_3 gives at least $1/6$ to v via w_2 or w_3 . First note that neither x_2 nor x_4 is needy, or else G contains (RC4). If both y_3 and y_4 are needy, say with 5-neighbors z' and z'' , then $G[\{v, w_2, w_3, x_3, y_3, y_4, z', z''\}]$ contains (RC10). So at most one of y_3 and y_4 is needy.

Suppose that at least two of x_2, x_4, y_3, y_4 are 7^+ -vertices. Each of these 7^+ -vertices gives $1/6$ to x_3 , so x_3 gets $1/3$. This $1/3$ is split among at most 3 vertices, two of which are w_2 and w_3 . As noted above, at most one of w_2 and w_3 has a 5-neighbor other than v (and at most one such 5-neighbor). So $1/9$ goes to w_2 or w_3 and on to v . Another $1/9$ goes to the other of w_2 and w_3 , and at least one half of it continues to v . Thus, v receives from x_3 (via w_2 and w_3) at least $1/9 + (1/9)/2 = 2/18 + 1/18 = 1/6$. Hence v gets at least $1/2 + 1/3 + 1/6 = 1$.

Assume instead that exactly one of x_2, x_4, y_3, y_4 is a 7^+ -vertex. If neither w_2 nor w_3 has a 5-neighbor, then x_3 gives at least $1/6$ to v (via w_2 and w_3) by Lemma 15. We handle the case that x_5 is a 5-vertex, but the argument is similar when x_1 is a 5-vertex. Now x_4 is a 7^+ -vertex, or else $N[w_3]$ contains (RC4). Thus, x_2 is a 6-vertex (since x_3 has exactly one 7^+ -neighbor). But now x_2 has no 5-neighbor y , or else $G[\{v, w_2, w_3, x_3, x_2, y\}]$ contains (RC4). By Lemma 16, vertex x_2 gives $1/6$ to v via w_2 . Thus, v gets at least $1/2 + 1/3 + 1/6 = 1$, and we are done. \square

Lemma 18. *Each 5-vertex with a 7^+ -neighbor and four 6-neighbors ends happy.*

Proof. Let v be a 5-vertex with neighbors w_1, \dots, w_5 in clockwise order. Assume that w_1 is a 7^+ -vertex and w_2, w_3, w_4, w_5 are 6-vertices. We label the remaining vertices as in Figure 11. Note that x_3, x_5, x_7 are all 6^+ -vertices, or G contains (RC2). If at least two of w_2, w_3, w_4, w_5 have 5-neighbors other than v , then G contains (RC5), (RC8), or (RC9). So, by symmetry, we assume that w_2 and w_3 both have v as their only 5-neighbor.

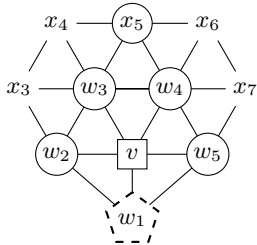

Figure 11: A 5-vertex with a 7^+ -neighbor and four 6-neighbors

Case 1: x_5 is a 6-vertex. Note that x_4 is a 6^+ -vertex, or else $G[\{v, w_3, w_4, x_4, x_5\}]$ contains (RC3). Similarly, x_6 is a 6^+ -vertex. Either x_6 or x_7 is a 7^+ -vertex, or else $G[N[w_4]]$ contains (RC25); so x_6 or x_7 gives $1/6$ to v via w_4 . By Lemma 15, vertex x_5 gives $1/6$ to v via w_3 and w_4 . If x_3 is a 7^+ -vertex, then it gives $1/6$ to v via each of w_2 and w_3 . In this case, we are done, since v gets $1/3 + 1/6 + 1/6 + 1/3 = 1$. Assume instead that x_3 is a 6-vertex. So w_4 is a 7^+ -vertex, or else $G[N[w_3]]$ contains (RC25). But now w_4 gives $1/6$ to v via w_3 . And w_3 also gives $1/6$ to v via w_2 and w_3 , by Lemma 15. Now we are done, since v gets $1/3 + 1/6 + 1/6 + 1/6 + 1/6 = 1$.

Case 2: x_5 is a 7^+ -vertex. We first show that v gets a total of $1/3$ from x_5 and x_7 via w_3, w_4 , and w_5 . If x_6 is a 6^+ -vertex, then

x_5 gives $1/6$ to v via each of w_3 and w_4 . So assume instead that x_6 is a 5-vertex. Now x_7 must be a 7^+ -vertex. If x_8 is a 5-vertex, then $G[\{v, w_4, w_5, x_6, x_8\}]$ contains (RC8); so assume x_8 is a 6^+ -vertex. But now x_5 gives $1/6$ to v via w_3 and x_7 gives $1/6$ to v via w_5 .

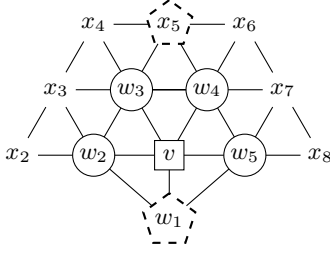

Figure 12: A 5-vertex with a 7^+ -neighbor and four 6-neighbors

6-vertices. We label the remaining vertices as in Figure 13. Both x_3 and x_5 are 6^+ -vertices, or else G contains (RC2).

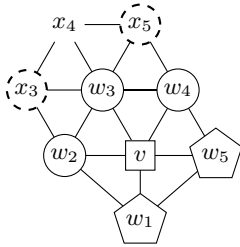

Figure 13: A 5-vertex with two adjacent 7-neighbors and three successive 6-neighbors

But now Lemma 15 implies that x_5 gives $1/6$ to v via w_3 and w_4 ; so x gets $1/3 + 1/3 + 1/6 + 1/6$, and we are done.

Case 3: x_4 is a 7^+ -vertex. If w_2 and w_4 both have 5-neighbors besides v , say y' and y'' , then $G[\{v, w_2, w_3, w_4, y', y''\}]$ contains (RC9). So, assume by symmetry that w_2 has no 5-neighbor but v . Thus, by Lemma 15, vertex x_3 gives a total of $1/6$ to v via w_2 and w_3 . Since x_4 also gives $1/6$ to v via w_3 , vertex v gets $1/3 + 1/3 + 1/6 + 1/6 = 1$. \square

The next lemma is our last, and will conclude our proof.

Lemma 20. *Each 5-vertex with two non-adjacent 7-neighbors ends happy.*

Proof. Assume that v is a 5-vertex with neighbors w_1, \dots, w_5 in order, and that w_2 and w_5 are 7-vertices. By Lemma 13, we assume that v has no 5-neighbors. If v has another 7^+ -neighbor, then v gets $1/3$ from each and we are done. So we assume w_1, w_3, w_4 are 6-vertices. We label the remaining vertices as in Figure 14. Note that x_5 is a 6^+ -vertex, or else G contains (RC2).

We now show that v gets a total of $1/3$ from x_2 and x_3 . If x_3 is a 7^+ -vertex, then it gives $1/6$ to v via each of w_2 and w_3 . So assume x_2 is a 6-vertex. By Lemma 15, vertex x_3 gives $1/6$ to v via w_2 and w_3 . By Lemma 16, vertex x_2 gives $1/6$ to v via w_2 . So v gets $1/3 + 1/3 + 1/3 = 1$. \square

Lemma 19. *Each 5-vertex with two adjacent 7-neighbors ends happy.*

Proof. Assume that v is a 5-vertex with neighbors w_1, \dots, w_5 in order, and that w_1 and w_5 are 7-vertices. By Lemma 13, we assume that v has no 5-neighbors. If v has another 7^+ -neighbor, then v gets $1/3$ from each and we are done. So we assume w_2, w_3, w_4 are

Case 1: x_4 is a 5-vertex. Now x_3 and x_5 are both 7^+ -vertices, or else $G[N[w_3]]$ contains (RC3). Furthermore, w_2 and w_4 both have v as their unique 5-neighbor. So now x_3 gives $1/6$ to w_2 , and on to v ; similarly, x_5 gives $1/6$ to w_4 , and on to v . Thus, we are done.

Case 2: x_4 is a 6-vertex. Either x_3 or x_5 is a 7^+ -vertex, or else $G[N[w_3]]$ contains (RC25); by symmetry, assume that x_3 is a 7^+ -vertex. So x_3 gives $1/6$ to v via w_3 . If x_5 is also a 7^+ -vertex, then we are done; so assume that x_5 is a 6-vertex. If w_2 has no 5-neighbor other than v , then w_2 also gets $1/6$ from x_3 , and gives this all to v . Thus, we assume w_2 has a 5-neighbor other than v . This implies that w_4 has v as its unique 5-neighbor, or G contains (RC9).

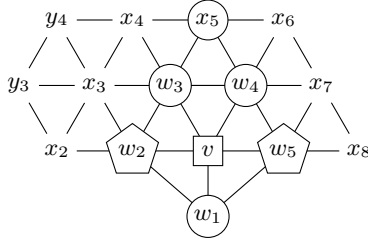

Figure 14: A 5-vertex with two non-adjacent 7-neighbors and three non-successive 6-neighbors

gives $1/6$ to v via w_3 by Lemma 16.

Since x_3, x_4, x_5 are all 6-vertices, vertex x_3 has no 5-neighbor, or else G contains (RC5). Further, at most one of x_2 and y_3 is needy, or G has a reducible configuration (e.g., if x_2 and y_3 are 6-vertices with 5-neighbors y' and y'' , then $G[\{v, w_3, w_4, x_2, x_3, x_4, x_5, y_3, y', y''\}]$ contains (RC20)). Also, y_4 is not needy or else G contains (RC23). Thus, x_3 has at most two needy neighbors: w_3 and at most one of x_2 and y_3 . Furthermore, if x_3 has w_2 as its unique 7^+ -neighbor, then neither x_2 nor y_3 is needy, or else G contains (RC18) or (RC19). Thus, x_3 sends $1/6$ to v via w_3 , and we are done.

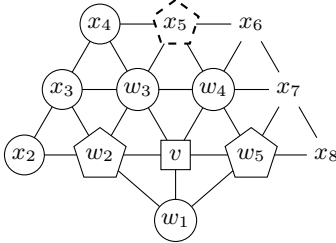

Figure 15: A 5-vertex with two non-adjacent 7-neighbors and three non-successive 6-neighbors

gives $1/12$ to v via w_3 . If x' has at least two 7^+ -neighbors, then it receives at least $2(1/6)$, and splits it at most four ways, giving w_3 at least $1/12$. But if x' has only a single 7^+ -neighbor, then none of its neighbors but w_3 and $\{x_3, x_4\} \setminus \{y'\}$ is needy, or else G contains (RC11) or (RC13) or (RC21). So x' gets $1/6$ from its 7^+ -neighbor and sends at least half to v via w_3 .

If x_5 is an 8^+ -vertex, then it sends $1/4$ to v via w_3 . So v gets $1/3 + 1/3 + 1/4 + 1/12 = 1$. So assume x_5 is a 7-vertex. Also x_6 is a 5-vertex; otherwise x_5 sends $1/6$ to w_4 and $1/12$ to v .

Suppose that x_4 is not needy (and x_3 is possibly needy). Now we show that x_4 sends $1/6$ to v via w_3 . If x_4 has at least three 7^+ -neighbors, then it receives $3(1/6)$ and sends $1/6$ to w_3 . And if x_4 has x_5 as its only 7^+ -neighbor, then $G[N[\{x_4, x_5\}]]$ contains (RC22). Finally, suppose that x_4 has exactly two 7^+ -neighbors. Now w_3 is needy, and possibly so is x_3 ; but no other neighbors of x_4 are needy, or else G contains (RC23) or (RC28) or (RC13) or (RC11). As an example, if y_4 is a 7^+ -vertex and y_5 is needy, with 5-neighbor z , then $G[\{v, w_3, w_4, x_4, x_5, x_6, y_5, y_6, z\}]$ contains (RC23). Thus, x_4 sends $1/6$ to v via w_3 , as desired.

Finally, assume that x_3 is not needy (and x_4 is needy); see Figure 16. If y_6 is a 5-vertex, then $G[N[x_5]]$ contains (RC27). So assume y_6 is a 6^+ -vertex. Since x_4 is needy, y_5 is a 5-vertex. Thus,

Case 1: x_5 is a 6-vertex. Now x_4 and x_6 are both also 6^+ -vertices, or else G contains (RC3). Suppose that w_3 and w_4 both have v as their unique 5-neighbor. By Lemma 15, vertex x_5 gives $1/6$ to v via w_3 and w_4 . If x_3 or x_4 is a 7^+ -vertex, then it gives $1/6$ to v via w_3 , and we are done; so we assume that x_3 and x_4 are both 6-vertices. Since w_3 has v as its only 5-neighbor, by Lemma 16 vertex x_4 gives $1/6$ to v via w_3 .

So we assume instead that either w_3 or w_4 has a 5-neighbor other than v . They cannot both have second 5-neighbors, say y' and y'' , or else $G[\{v, w_3, w_4, y', y''\}]$ contains (RC8). So we assume by symmetry that w_3 has v as its unique 5-neighbor. Again, x_4

Case 2: x_5 is a 7^+ -vertex. See Figure 15. If both w_3 and w_4 have v as their unique 5-neighbor, then x_5 gives $1/6$ to v via each of w_3 and w_4 , and we are done. So assume that w_3 or w_4 has another 5-neighbor. If both have second 5-neighbors, say y' and y'' , then $G[\{v, w_3, w_4, y', y''\}]$ contains (RC8). So assume that w_3 has v as its unique 5-neighbor, but w_4 has a 5-neighbor other than v ; call it y' . So x_5 sends $1/6$ to v via w_3 . If x_3 or x_4 is a 7^+ -vertex, then it gives $1/6$ to v via w_3 and we are done. So assume that x_3 and x_4 are both 6-vertices.

If x_3 and x_4 are both needy, say with 5-neighbors y'' and y''' , then $G[\{v, w_3, w_4, x_3, x_4, y', y'', y'''\}]$ contains (RC12). So let x' be a vertex among x_3 and x_4 that is not needy. We first show that x'

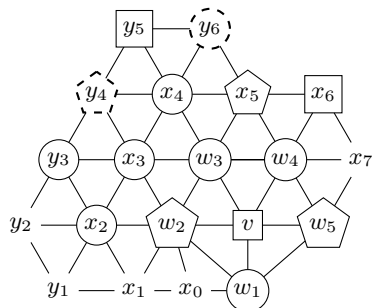

Figure 16: A 5-vertex with two non-adjacent 7-neighbors and three non-successive 6-neighbors

contains (RC26); so assume that x_1 is a 7^+ -vertex. Now x_0 gets at least $2(1/6)$ and gives v at least $1/12$ via w_1 . So v gets at least $1/3 + 1/3 + 1/6 + 1/12 + 1/12 = 1$, and we are done. \square

y_4 is a 7^+ -vertex, or else $G[\{v, w_3, x_3, x_4, y_4, y_5\}]$ contains (RC4). Now x_3 gets $1/6$ from each of w_2 and y_4 . If neither x_2 nor y_3 is needy, then x_3 sends $1/6$ to v via w_3 , and we are done. Similarly, if either x_2 or y_3 is a 7^+ -vertex, then x_3 again sends $1/6$ to v via w_3 . So assume that both x_2 and y_3 are 6-vertices and at least one of them is needy, with 5-neighbor z' .

If w_1 has a 5-neighbor z'' other than v , then $G[\{v, w_1, w_2, w_3, x_2, x_3, x_4, y_3, y_5, z', z''\}]$ contains (RC29) or (RC30); so assume not. And if w_1 has a 7^+ -neighbor other than w_2 and w_5 , then it gets $1/6$ and sends it to v , and we are done. So we assume that x_0 is a 6-vertex. If x_0 is needy, then G contains (RC24), since x_4 is needy. So we assume x_0 is not needy. If x_1 is a 6-vertex, then $G[N[w_2]]$

References

- [1] V. Bartier, N. Bousquet, C. Feghali, M. Heinrich, B. Moore, and T. Pierron. Recoloring planar graphs of girth at least five. *SIAM J. Discrete Math.*, 37(1):332–350, 2023, [arXiv:2112.00631](#).
- [2] H. B. Bjerkevik, L. Kleist, T. Ueckerdt, and B. Vogtenhuber. Flipping non-crossing spanning trees. 2024, [arXiv:2410.23809](#). An extended abstract appears at SODA 2025.
- [3] N. Bousquet and G. Perarnau. Fast recoloring of sparse graphs. *European J. Combin.*, 52(part A):1–11, 2016. doi:10.1016/j.ejc.2015.08.001.
- [4] L. S. Chandran, U. K. Gupta, and D. Pradhan. List recoloring of planar graphs. 2022, [arXiv:2209.05992](#).
- [5] D. W. Cranston. List-recoloring of sparse graphs. *European J. Combin.*, 105:Paper No. 103562, 11, 2022, [arXiv:2201.05133](#).
- [6] Z. Dvořák and C. Feghali. An update on reconfiguring 10-colorings of planar graphs. *Electron. J. Combin.*, 27(4):Paper No. 4.51, 21, 2020. doi:10.37236/9391.
- [7] Z. Dvořák and C. Feghali. A Thomassen-type method for planar graph recoloring. *European J. Combin.*, 95:Paper No. 103319, 12, 2021, [arXiv:2006.09269](#).
- [8] N. Nishimura. Introduction to reconfiguration. *Algorithms (Basel)*, 11(4):Paper No. 52, 25, 2018.
- [9] J. van den Heuvel. The complexity of change. In *Surveys in combinatorics 2013*, volume 409 of *London Math. Soc. Lecture Note Ser.*, pages 127–160. Cambridge Univ. Press, Cambridge, 2013.