

THE MAGIC AND MYSTERY OF COMPONENT TABLEAUX.

YASMINE FITTOUHI AND ANTHONY JOSEPH

Department of Mathematics
The Weizmann Institute of Science
Rehovot, 7610001, Israel
fittouhiyasmine@gmail.com

Donald Frey Professional Chair
Department of Mathematics
The Weizmann Institute of Science
Rehovot, 7610001, Israel
anthony.joseph@weizmann.ac.il

Key Words: Invariants, Parabolic adjoint action, Composition Tableaux.

AMS Classification: 17B35

Abstract.

Let G be a simple algebraic group over the complex field \mathbb{C} , B a fixed Borel subgroup, P a parabolic subgroup containing B , P' its derived group and \mathfrak{m} the Lie algebra of its nilradical.

The nilfibre \mathcal{N} for this action is the zero locus of the augmentation \mathcal{I}_+ of the semi-invariant algebra $\mathcal{S} := \mathbb{C}[\mathfrak{m}]^{P'}$.

Although the Lasker-Noether theorem allows one to define the components of an algebraic variety, their determination is notoriously difficult, especially for \mathcal{N} as it is homogeneous. Even for $G = SL(n)$ practically nothing was known previously. The only result of comparable, but lesser complexity, is for $\mathcal{V} := \mathcal{O} \cap \mathfrak{n}$, with \mathcal{O} a nilpotent G orbit and \mathfrak{n} the set of strictly upper triangular matrices. Then \mathcal{V} is equidimensional, with components, known as orbital varieties, parameterised by standard tableaux whose shape is dictated by \mathcal{O} . This result is made relatively easy through Bruhat decomposition.

Here the components of \mathcal{N} are studied for $G = SL(n)$. They increase exponentially in n with no a priori discernable pattern. Nor is it possible to use Bruhat decomposition.

The composition of n defined by the Levi block sizes in P defines a standard tableau \mathcal{T} . For each choice of numerical data \mathcal{C} , a semi-standard tableau $\mathcal{T}^{\mathcal{C}}$, is

Date: July 9, 2024.

constructed from \mathcal{I} . A *delicate and tightly interlocking* analysis constructs a set of excluded root vectors from \mathfrak{m} such that the complementary space $\mathfrak{u}^{\mathcal{C}}$ has the following properties. First it is a subalgebra of \mathfrak{m} . Secondly $\mathcal{C} := \overline{B \cdot \mathfrak{u}^{\mathcal{C}}}$ lies in \mathcal{N} to which, thirdly, a Weierstrass section can be associated. Fourthly $\dim \mathcal{C} = \dim \mathfrak{m} - \mathfrak{g}$, where \mathfrak{g} is the number of generators of the polynomial algebra \mathcal{I} . Fifthly the Weierstrass section, is shown to imply that \mathcal{C} an irreducible component of \mathcal{N} , yet \mathcal{C} is *only sometimes* an orbital variety closure.

The resulting ‘‘component map’’ $\mathcal{I}^{\mathcal{C}} \mapsto \mathcal{C}$ is shown to be injective. Evidence for its surjectivity is given.

Acknowledgements.

The work of the first author was supported by ISF grant 1957/21 jointly held by M. Gorelik, Weizmann Institute and S. Reif, Bar-Ilan University and by ISF grant 1781/23 held by D. Gourevich, Weizmann Institute.

The main results described here were the subject of two invited talks, one by Y. Fittouhi and one by A. Joseph in the program ‘‘Algebraic and Combinatorial Methods in Representation Theory’’, held during November 13-24, 2023 in the Tata Institute, Bangalore, India. We would like to thank the organisers for the invitation and for their hospitality.

Following this meeting we spent the best of 8 months writing up the proofs and so it would appropriate to add that this research was also significantly aided by the International Centre for Theoretical Sciences (ICTS) through participation in the program - Algebraic and Combinatorial Methods in Representation Theory (code: ICTS/ACMRT2023/11).

1. INTRODUCTION

The base field is assumed to be algebraically closed and of characteristic zero. It will simply be denoted as \mathbb{C} . Given $m \leq n$ is positive integers, set $[m, n] := \{m, m+1, \dots, n\}$. If m, n , or both are omitted we note this respectively as $]m, n]$, $[m, n[$, $]m, n[$.

1.1. The Nilfibre. Let Q be a connected algebraic group acting linearly on a vector space \mathfrak{m} . Let \mathcal{I} be the algebra $\mathbb{C}[\mathfrak{m}]^Q$ of Q invariant functions on \mathfrak{m} . The nilfibre \mathcal{N} (for this action) is the zero variety of the augmentation \mathcal{I}_+ of \mathcal{I} .

In general the nilfibre is not irreducible and it is hardly ever known how to describe its components (meaning here and henceforth - irreducible components).

This is the problem we propose to solve for a particular family $\mathcal{N}(n) : n \in \mathbb{N}^+$, of exponentially growing cardinality.

1.2. Associated Weierstrass Sections. Let \mathcal{C} be a component of \mathcal{N} . A Weierstrass section $e + V$ is a pair $e \in \mathcal{C}$ and a subspace $V \subset \mathfrak{m}$ such the restriction of \mathcal{S} to $e + V$ induces an isomorphism of \mathcal{S} onto $\mathbb{C}[e + V]$.

The existence of a Weierstrass section implies that \mathcal{S} is polynomial. Moreover the generators of \mathcal{S} are then simultaneously linearized to become a basis for V , which is quite an accomplishment.

Geometrically an orbit of Q can meet a Weierstrass section $e + V$ at only one point, because invariants are constant on orbits and the map is surjective.

We may wish to demand more of a Weierstrass section. For example

(i). That the pair e, V determines \mathcal{C} .

(ii). That Qe is dense in \mathcal{C} , so of maximal dimension $\dim \mathcal{C}$, thereby called a regular orbit.

(iii). That every element of $e + V$ generates a regular Q orbit in \mathfrak{m} .

(iv). That every regular Q orbit in \mathfrak{m} meets $e + V$.

Generally (iv) will fail unless \mathcal{N} is irreducible.

1.3. Coadjoint Action. Suppose Q is a connected, simply-connected, simple algebraic group G acting on its Lie algebra \mathfrak{g} . Through the classical work of Kostant [19], a Weierstrass section exists and (i) – (iv) all hold. This had some importance for the Toda lattice and its higher dimensional versions. The key point in Kostant’s work was to use the principal s-triple, though it is enough to extract from it an “adapted pair”, [14]. This concept has been extensively investigated by the second author in papers too numerous to mention.

The results of Kostant were extended for example for $G = SL(3)$ acting on its 10 dimensional representation by Popov and Vinberg [23]. Here one can view the regular orbits as being the elliptic curves in \mathbb{P}^2 and then (iv) above, recovers Weierstrass canonical form. For this reason Popov and Vinberg assigned the epithet - Weierstrass sections. Because there are two invariant generators (written down by Weierstrass himself) it is not quite obvious that \mathcal{N} is irreducible, but this is proved in [16, Lemma 2.5].

In [14] adapted pairs were constructed for the coadjoint action of a parabolic subgroup¹ on the nilradical of its Lie algebra in type A . However in this case \mathcal{N} may fail to be irreducible and some components of \mathcal{N} may fail to admit regular elements. No attempt was made to classify the components of \mathcal{N} . Outside type

¹Even for a biparabolic subgroup.

A , and particularly in type E_6, E_7 for the ‘‘Heisenberg’’ parabolic, the existence of an adapted pair leads to an ‘‘improved upper bound’’ [15, Lemma 6.11, 6.14] showing that \mathcal{S} is polynomial! Notably this method has been extended By Fauquant-Millet [7] for other parabolics in classical type. The original intention had been to recover the result of Yakimova [27] (proved partly by computer calculations) that polynomiality fails for the Heisenberg parabolic in type E_8 .

1.4. Adjoint Action. Let \mathfrak{g} be the Lie algebra of G . Fix a Borel subgroup B of G and let \mathfrak{n} be the nilradical of the Lie algebra \mathfrak{b} of B . Fix a standard parabolic subgroup P of G , that is to say one containing B , and let \mathfrak{m} be the nilradical of the Lie algebra \mathfrak{p} of P . Let H be a Cartan subgroup for B and \mathfrak{h} its Lie algebra. Let W be the Weyl group for the pair (G, H) . Let P' be the derived group of P .

A theorem of Richardson asserts that P has a dense orbit in \mathfrak{m} . This implies [8, 2.2.2] that $\mathcal{S} := \mathbb{C}[\mathfrak{m}]^{P'}$ is polynomial. One calls \mathcal{S} the semi-invariant subalgebra for the adjoint action of P (or \mathfrak{p}) on \mathfrak{m} . It, and the nilfibre \mathcal{N} it defines, will be the main objects of our study.

One may take the generators of \mathcal{S} to be H eigenvectors which are irreducible as polynomials. Thus \mathcal{S}_+ is stable under P and so is \mathcal{N} . Since P is connected, the components of \mathcal{N} are also P stable. However a P' orbit through a point of $e + V$, need not be a P orbit, and the latter could even be dense in \mathfrak{m} .

In the present paper we restrict our attention to G being of type A_{n-1} , that is when $G = SL(n)$.

1.5. Type A. For the adjoint action of a parabolic subalgebra on its nilradical, the method of adapted pairs fails miserably even in Type A . First of all, a component of \mathcal{N} may fail to admit a dense P orbit [9, Lemma 6.10.7] (though examples are not easy to find). Even when a dense orbit exists, an adapted pair need not exist (such examples are easy to find). This means here that (ii) of 1.2 will fail and we must be more clever in establishing (i). This was carried out for the ‘‘canonical component’’ as a consequence of [9, Prop. 6.10.4(iii)] - the possible generalisation of which we shall not attempt here.

In [8, Thm. 2] we proved the existence of a Weierstrass in type A . This was clarified in [9],[10] but not made any simpler. Yet these papers led in [11] to a dramatic simplification through the construction of a ‘‘composition tableau’’. This came entirely out of the blue and surely could not have been achieved without the help of our preliminary work.

1.6. Primary decomposition. Recall that the (irreducible) components of an affine algebraic variety \mathcal{V} are defined as follows.

First the ideal \mathfrak{a} of definition of \mathcal{V} is an ideal in a polynomial ring R , so in particular noetherian.

Yet in a noetherian ring R every ideal \mathfrak{a} admits a primary decomposition², that is to say is a finite intersection of primary ideals [1, Lemmas 7.11, 7.12]. The radicals of these primary ideals are prime and are independent of the primary decomposition of \mathfrak{a} [1, Thm. 4.5]. Those which are minimal (primes over \mathfrak{a}) define the (irreducible) components of \mathcal{V} . (Although a noetherian ring does not satisfy the descending chain condition, its prime ideals do by virtue of Krull dimension (see for example [4, Lemma 3.5.1]). Thus for an ideal of a noetherian ring one may directly define the minimal primes over it.)

This beautiful general theory tells us little of how to find the irreducible components - just as we do not know how to decompose a number into its prime factors.

1.7. Component Tableaux. Let \mathcal{N} be defined as in 1.4.

Here we propose a method for finding the irreducible components of \mathcal{N} involving the generalisation of the composition tableau. These are the component tableaux. Their construction is given in Section 3.

We believe the component tableaux to be completely new. They surely could not have found without our preliminary work in [8],[9],[10],[11]³.

In Section 4 we assign to any component tableau a selected set of excluded roots. Then the required component is the B saturation set of the space spanned by the complement of the excluded root vectors.

Here the choice of excluded roots is rather delicate for otherwise the said B saturation set would be too small, but it also must be large enough so that the Benlolo-Sanderson invariants vanish when these excluded roots are set equal to zero.

This last result requires showing that a triply infinite sequence of determinants, growing exponentially in n , all vanish, when the excluded roots are set equal to zero.

The construction of the excluded roots and the resulting vanishing is mainly due to the first author, with the second author following her intuition with blind faith.

In Section 5 we show that each component tableau also gives rise to a Weierstrass section.

In 6.4, we construct as indicated above, a map from component tableaux to components, which we call the component map.

In Section 7 we prove an Exchange Lemma 7.2. Combined with partial linearity, Corollary 7.4, this proves that the component map is injective, Proposition 7.5. In Section 8, surjectivity is also verified in a number of special cases. Yet it is a quite different task wisely postponed to a further paper.

²Here of course we only need to know this for a polynomial ring which is due to Lasker, whilst for a noetherian ring it is due to Noether.

³Even using chatGPT!

1.8. Orbital Varieties. A co-adjoint G orbit \mathcal{O} for which $\mathcal{O} \cap \mathfrak{n}$ is non-empty is called a nilpotent orbit. After Spaltenstein [24], the intersection $\mathcal{O} \cap \mathfrak{n}$ is equidimensional of dimension $\frac{1}{2} \dim \mathcal{O}$. Its components are called orbital varieties. Orbital varieties are Lagrangian subvarieties for the Kirillov-Kostant symplectic form on \mathcal{O} and as such can in principle be quantized as highest weight modules, an open problem of some difficulty, partly because quantization can sometimes fail (see 2.3.4).

1.9. Hypersurface Orbital Varieties. When we take the generators of $\mathbb{C}[\mathfrak{m}]^{P'}$ to be H eigenvectors which are irreducible as polynomials, they determine a hypersurface in \mathfrak{m} which is an orbital variety closure [8, 2.3.4]. We call this a hypersurface orbital variety. Further details may be found in [8, 2.3.4] and references therein.

Through the Steinberg triple variety one may show that there is a surjective map $w \mapsto \overline{B \cdot (\mathfrak{n} \cap \mathfrak{n})^w}$ of W onto the set of orbital variety closures. In type A , the Robinson-Schensted correspondence gives a rather precise description of the fibres of this map. This description was given by Steinberg [25] (see also references therein) though rather belatedly as the fibres had already been described by Spaltenstein via a result of Knuth who admitted (privately to my colleague A. Melnikov) to having proved this last result just for fun.

Thus in type A orbital varieties can be viewed as being known.

Those which are hyper-surfaces orbital varieties are less well-known, particularly outside type A and certainly in type E .

1.10. Components as Orbital Varieties. *Not* all the components of the nilfibre are orbital variety closures. Perhaps the simplest example arises for the composition $(2, 1, 1, 1, 2)$. In this case (see 8.2) the nilfibre has exactly three components, one is an orbital variety closure, the other two are not!

1.11. Components as Orbital Varieties. We claim that our proofs are as tight and intricate as Chinese wooden box puzzles which seem impossible to take apart⁴. Indeed it was already noted in 1.7 that the choice of the set of excluded roots is rather delicate. Again to define a Weierstrass section (see Section 5) for a given component, we select a rather special monomial in each Benlolo-Sanderson invariant. Each factor must be labelled by a 1 or by a * and just the latter are in the set of excluded root vectors. Yet again every excluded root vector which is not a root labelled by a * must have (see 6.2.7) to its left a root vector labelled by a 1, whilst a certain root vector labelled by a 1 must have no excluded roots in the upper right hand quadrant it defines (see 7.3), so in particular no excluded roots to its right.

It is surely magical that all this can be accomplished for all (standard) parabolics in Type A_n , which grow exponentially in n and then rather mysteriously through a set of tableaux, duly earning the designation “magical and mysterious”. In view of

⁴Even making the proofs fit for human consumption was a major challenge.

the remarks in 4.7 we could well add “miraculous”. This should surely arouse the admiration and curiosity of even the most disparaging reader.

Finally we need few technical devices, familiarity with the notion of a determinant and intersection theory in projective space.

2. THE MAIN PLAYERS.

Assume \mathfrak{g} of type A_{n-1} that is to say $\mathfrak{sl}(n)$.

2.1. Columns.

2.1.1. *Column Notation.* In type A_{n-1} , a (standard) parabolic subalgebra is given by the composition (c_1, c_2, \dots, c_k) of n with the $c_i : i \in [1, k]$ being the successive sizes of the Levi factors (see [8, 4.1.1], which of course sum to n). This gives rise to a diagram \mathcal{D} having columns C_1, C_2, \dots, C_k of $\text{ht } C_i = c_i : i \in [1, k]$.

Let $R_i : i = 1, 2, \dots$, denote the rows \mathcal{D} . We view them as *descending* down the diagram. Set $R^s = \cup_{i=1}^s R_i$. Set $b_{i,j} := C_i \cap R_j$, called the ij^{th} box of \mathcal{D} .

2.1.2. *Adjacent and Neighbouring Columns.* Successive columns of \mathcal{D} are said to be adjacent. Two boxes in the same row, in not necessarily adjacent columns of \mathcal{D} , with no boxes between them are called adjacent.

Two columns of \mathcal{D} are said to be neighbouring [8, 4.1.2] of height s , if they are both of height s and there are no columns of height s strictly between them. After Melnikov [21], the set of hyper-surface orbital varieties is in bijection with set of neighbouring columns.

The set of columns of height $s \in \mathbb{N}^+$ in \mathcal{D} is denoted $C_1^s, C_2^s, \dots, C_{r_s}^s$, going from left to right as the subscript increases.

2.1.3. *Intervals.* If C, C' are columns of \mathcal{D} we shall always mean C to lie to the left of C' . Denote by $[C, C']$ the set of columns of \mathcal{D} between C, C' . If C, C' , or both are omitted, then we denote the resulting set as $]C, C'], [C, C'[$, $]C, C'[$.

2.1.4. *Rectangles.* If C, C' are neighbouring columns of height s , we set $R_{C,C'}^s = R^s \cap [C, C']$ viewed as a union of boxes with entries from $[1, n]$, often referred to as the rectangle defined by the columns.

2.2. Tableaux.

2.2.1. *Matrix Notation.* Let \mathbf{M} denote set of all $n \times n$ matrices. As a Lie algebra under commutation it is $\mathfrak{gl}(n)$, whilst $\mathfrak{sl}(n)$ is the (simple) Lie subalgebra of matrices of trace zero. As is customary we shall barely distinguish between the two.

The Levi factor \mathfrak{r} of \mathfrak{p} is just $\bigoplus_{i=1}^k \mathbf{B}_i$, where \mathbf{B}_i is the i^{th} Levi block of size c_i centered on the diagonal.

For each column C_i , let \mathbf{C}_i denote the rectangular block in \mathfrak{m} lying above \mathbf{B}_i . We call it the i^{th} column block. Its width is c_i and its height $\sum_{j < i} c_j$. In particular $\mathbf{C}_1 = 0$.

Then $\mathfrak{m} := \bigoplus_{i=2}^k \mathbf{C}_i$ is the nilradical of \mathfrak{p} .

Let $x_{i,j}$ denote the ij^{th} entry of \mathbf{M} . They form its standard basis.

2.2.2. *Number Insertion.* A tableau \mathcal{T} is obtained from \mathcal{D} by inserting in the boxes the entries $1, 2, \dots, n$, going down columns and then from left to right.

If i' and j' occur in boxes of strictly successive columns, then $x_{i',j'} \in \mathfrak{m}$, and these elements form a basis for \mathfrak{m} . Likewise $x_{i',j'}$, with i', j' entries joined in the same column C_i , form a basis for \mathbf{B}_i , properly speaking in $\mathfrak{gl}(n)$.

If $i' \in [1, n]$, then it lies in a unique column (resp. row) of \mathcal{T} which we denote by $C_{(i')}$ (resp. $R_{(i')}$).

2.3. **The Benlolo-Sanderson Invariants.** Fix a pair of neighbouring columns C, C' of height s . Through the reduction of [8, 3.2, 4.1.2] the invariant assigned to a pair of neighbouring columns is obtained by ignoring all the columns outside the given neighbouring pair and is then given by the construction of Benlolo and Sanderson [2]. All this is detailed in [8, Sect. 3, Sect. 5] where some independent proofs are given. Here we note a slight refinement in the lemma below,

2.3.1. *Construction.* Assume that $C = C_1, C' = C_k$, then \mathbf{B}_1 (resp. \mathbf{B}_k) are the first (resp. last) Levi blocks and both have size s . Let \mathbf{M}_s^* be the $n - s \times n - s$ minor in the lower left hand corner of \mathbf{M} . It fits in \mathbf{M} snugly between these first and last Levi blocks. It is semi-invariant for the opposed subalgebra \mathfrak{p}^- of \mathfrak{p} .

Through the Killing form we may regard \mathbf{M}_s^* as a (polynomial) function on \mathfrak{g} . Amazingly when \mathbf{M}_s^* is restricted to \mathfrak{m} it becomes a \mathfrak{p} semi-invariant. In this one only has to check invariance under $x_{s-1,s}, x_{n-s,n-s+1}$.

However if we apply this recipe blindly, the resulting invariant is zero whenever the Levi has a block size $> s$.

2.3.2. *The Cure for Vanishing.* The trick (motivated by quantum groups) is to evaluate \mathbf{M}_s^* instead on $\mathfrak{m} + a \text{Id}$. Then it is non-zero, a polynomial in a but not a semi-invariant!

Let $d_{\mathcal{D}}^{R_s^{C,C'}}$ (or simply, $d_{\mathcal{D}}$) be the number of boxes in \mathcal{D} strictly below R_s between the pair C, C' .

With respect to [8, 3.4.10], one easily checks that $d_{\mathcal{D}} = \sum_{i=1}^k \max(c_i - s, 0)$.

The restriction of \mathbf{M}_s^* is a polynomial of degree $\sum_{i=1}^{k-1} \min(c_i, c_1)$. One checks that the leading term is semi-invariant and is just $a^{d_{\mathcal{D}}}$ times what is then the Benlolo-Sanderson invariant $I_{C,C'}^s$ [2]. It is an irreducible polynomial [8, 5.3]. If C, C' have height s but are not neighbouring, then the resulting polynomial is still semi-invariant but is a product [9, 1.10] of the factors coming from the pairs of neighbouring columns of height s , sandwiched between C, C' .

2.3.3. The Variables in a Benlolo-Sanderson Invariant. Let \mathfrak{m}^- be the transpose of \mathfrak{m} . We may identify $\mathbb{C}[\mathfrak{m}]$ with $S(\mathfrak{m}^-)$ through the Killing form. Then $I_{C_1, C_k}^s \in S(\mathfrak{m}^-)$. More generally $I_{C,C'}^s$ is a polynomial in the co-ordinate functions $x_{i,j}^* : x_{i,j} \in \mathfrak{m}$. Not every co-ordinate function need occur in $I_{C,C'}^s$ (as indicated just below).

2.3.4. Quantization. Consider the composition $(1, 2, 1)$. In this case $I_{C_1, C_3}^1 = x_{1,2}^* x_{2,4}^* + x_{1,3}^* x_{3,4}^*$. Its zero locus is a hypersurface orbital variety in \mathfrak{m} . On the other hand the term which multiplies a^2 in the above construction, namely $x_{1,4}^*$ is *not* a semi-invariant.

Consider the $x_{j,i} : x_{i,j} \in \mathfrak{m}$. They commute in $S(\mathfrak{m}^-)$. Some may wish to consider them in the enveloping algebra $U(\mathfrak{m}^-)$, where they do not commute. Then one may ask if there is a highest weight module, whose highest weight vector is annihilated by a suitably ordered form of this expression. Thereby Kostant [20] first constructed a non-trivial ‘‘quantization’’ in type A_3 which turned out to be a unitarizable highest weight module for a suitable real form.

The problem of quantization of hypersurface orbital varieties in type A was solved in [18] with the help of the Jantzen sum formula. This drastically simplified and generalized the work of Kostant mentioned above [20], though these modules are unitarizable if and only if the \mathfrak{m} is commutative and then can be uniformly presented [6], a rarity in the theory of unitarizable modules.

The work in [18] was generalized to classical type in by Elena Perelman [22], for which one has to weaken the definition of quantization. Elena was a doctoral student of the second named author but sadly she followed family tradition and left her superb work unpublished. It has barely been approached let alone surpassed for now more than twenty years.

A component of \mathcal{N} is not in general an orbital variety closure, therefore not Lagrangian and so cannot be quantized. However it can be an orbital variety even if it is not a hypersurface. The quantization of such orbital varieties has not been considered, other than in the general context of the quantization of all orbital varieties which is a difficult problem and is not always possible [17].

2.3.5. *The Distribution of the a factors.* The formula for $d_{\mathcal{D}}$ suggests that each Levi block of size $t > s$ contributes a factor of a^{t-s} . This is shown through the following relatively easy lemma in which we can assume $C = C_1, C' = C_k$ without loss of generality.

Lemma. *Let $\text{Id}_{>s}$ be the diagonal matrix with only a in the entries of the blocks of size $> s$. Then the restriction of \mathbf{M}_s^* to $\mathfrak{m} + a \text{Id}_{>s}$ has leading term $a^{d_{\mathcal{D}}} I_{C,C'}^s$. Moreover in this the i^{th} Levi block contributes a factor of $a^{\max(0, c_i - s)}$.*

Proof. The number of rows (resp. columns) of \mathfrak{m}^- meeting the first j (resp. $j - 1$) Levi blocks is $\sum_{i=2}^j c_i$ (resp. $\sum_{i=1}^{j-1} c_i$). Suppose $c_j > s$ and choose j minimal with this property. Then the sum of the rows exceeds the sum of the columns by $c_j - s > 0$. Consequently the restriction of \mathbf{M}_s^* to the direct sum of the first j column blocks $\bigoplus_{i=1}^j \mathbf{B}_i$ is zero. However if we add to this direct sum the diagonal matrix $a \text{Id}$ in the place of the j^{th} Levi factor, then the restriction is non-zero with leading term having a factor of $a^{c_j - s}$. Moreover in this leading term, the number of columns below the j^{th} Levi factor has been reduced from c_j to s .

Thus the above argument may be repeated, reducing j by 1 and eventually gives the assertion of the lemma. □

3. THE COMPONENT TABLEAUX.

Assume $\mathfrak{g} = \mathfrak{sl}(n)$, that is of type A_{n-1} . Recall (2.2.2) that a (standard) parabolic subalgebra \mathfrak{p} determines a tableau \mathcal{T} . The latter gives a basis for the nilradical \mathfrak{m} and encodes the Benlolo-Sanderson generators of the polynomial algebra $\mathbb{C}[\mathfrak{m}]^{P'}$, whose common zero loci define the nilcone \mathcal{N} . Our aim is determine the components of the latter through “component tableaux”.

In this section a component tableau $\mathcal{T}^{\mathcal{C}}$ will be constructed from \mathcal{T} by a simple procedure which extends the construction of the composition tableau [11, 4.7]. A main difference is that we can make several choices at each step, incorporated as numerical data \mathcal{C} - 3.1.5.

In 4.1.4 we use $\mathcal{T}^{\mathcal{C}}$ to define a Lie subalgebra $\mathfrak{u}^{\mathcal{C}}$ of \mathfrak{n} , setting $\mathcal{C} := \overline{B \cdot \mathfrak{u}^{\mathcal{C}}}$.

3.1. Generalities and Notation.

3.1.1. *An Overview of the Sequential Construction of a Component Tableau.* As in [11, 4.2,4.7] we augment the columns of \mathcal{D} by increasing their height through adjoining empty boxes. We denote this augmented diagram by \mathcal{D}' . Since we are just lengthening existing columns, there are no empty boxes in the first row, that is in $R_1 \cap \mathcal{D}'$.

Modifying slightly the notation of [11, 4.7], set $\mathcal{T}(1) = \mathcal{T}$ and for each $t \in \mathbb{N}^+$, let $\mathcal{T}(t)$ denote the tableau in which entries have been successively inserted into empty boxes of the first t rows of \mathcal{D}' .

Set $\mathcal{T}(t, 1) = \mathcal{T}(t - 1)$ and let $\mathcal{T}(t, r + 1) : r \in [1, k[$ be obtained by putting an entry from C_r into C_{r+1} and down by ≥ 0 rows, following the rules to be announced in 3.2. (This may leave a “gap” in each row R_t on its left (cf [11, Fig. 2]), which can increase in length with t . It is of no particular importance.)

The construction in 3.2.2 implicitly selects elements in “batches” and may be carried out in *several different ways* leading to *several different choices* for $\mathcal{T}(t)$, for each $t \in \mathbb{N}^+$.

Fixing for the moment just one particular selection in each batch, $\mathcal{T}(t)$ is a sub-tableau of $\mathcal{T}(t + 1)$ and we denote their direct limit by $\mathcal{T}(\infty)$. Our rules imply that $\mathcal{T}(t) = \mathcal{T}(\infty)$, for all t sufficiently large.

Given C a column of \mathcal{T} . View $C(t)$ (resp. $C(t, r), C(\infty)$), as the corresponding column of $\mathcal{T}(t)$ (resp. $\mathcal{T}(t, r), \mathcal{T}(\infty)$).

The rows R_t of C coincide with those of $C(t)$ (resp. $C(\infty)$) for $t \leq \text{ht } C$. One has $\text{ht } C(t) \geq t$ and correspondingly $\text{ht } C(t, r) \geq t - 1$ to the right of the above mentioned gap. Notice that this is a strict inequality if and only if $\text{ht } C \geq t$.

3.1.2. *The Vav Conversive.* It is extremely inconvenient and not particularly informative to carry, with studious diligence, the notation $\mathcal{T}(t), \mathcal{T}(t, r)$ throughout.

To avoid this as much as possible we shall use the principle of the Vav Conversive [5, p.95] used in ancient texts, which arose from an intermingling of past and future as might result from sojourning in the desert when every day seems the same. Moreover here ambiguity is reduced because the past does not change.

Thus instead of referring to $\mathcal{T}(t)$ being filled to give $\mathcal{T}(t + 1)$, we shall view the rows of $\mathcal{T}(\infty)$ as having been successively completed. Since “past” rows are never changed the possible confusion is limited.

Yet of *prime* importance is to distinguish the column C of \mathcal{T} with the corresponding column $C(\infty)$ of $\mathcal{T}(\infty)$ which may have added entries.

3.1.3. *Surrounding Columns.* Recall the notation of 2.1.1. Two adjacent columns $C := C_r, C' := C_{r+1} : r \in [1, k - 1]$ of \mathcal{D} are said to be surrounded by a pair of neighbouring columns $C(s), C(s)'$ of \mathcal{D} of height s if $C, C' \in [C(s), C(s)']$.

This may arise for a finite set S of values of s simultaneously. Here *we do not* impose any condition on the relative order of the columns $C(s) : s \in S$ (resp. $C(s)' : s \in S$). Generally we take S of the form $[m_1, m_2] : m_1 \leq m_2 \in \mathbb{N}^+$.

3.1.4. *Batches.* In the following (particularly in 3.2.2) we observe that *several different* $\mathcal{T}(\infty)$ can be constructed and specified by a choice of numerical data \mathcal{C} . In the language of 3.1.2 although the past is fixed, the future need not be, creating

several different tableaux $\mathcal{T}^c(\infty)$ in the limit⁵. This might lead to confusion, so we postpone the use of the vav conversive up to the end of 3.2.2.

Unlike [11, 4.7] we shall *not* insert the elements of $[1, n]$ with the smallest first for the (linear) order relation \preceq defined in [11, 4.7].

Instead we define disjoint subsets of $R_t \cap \mathcal{T}(t, r)$, called batches, used to pass from $\mathcal{T}(t, r)$ to $\mathcal{T}(t, r+1)$ (in one of several ways). Here we regard the pair (t, r) as being fixed at least up to the end of 3.2.2.

Let C, C' be neighbouring columns of height t . As indicated in 3.1.1 a given row of $\mathcal{T}(t, r)$ may admit repeated entries having the same value.

The batch $\mathcal{B}_{C, C'}^s : s \leq t$ is defined to consist of the rightmost entries having a given value j in R_s in $[C, C']$ in $\mathcal{T}(t, r)$.

In the notation of 2.1.2, for all $u \in [1, r_s - 1]$, we shall write $\mathcal{B}_{C_u^t, C_{u+1}^t}^s$ as \mathcal{B}_u^s . Set $\mathcal{B}^s = \cup_{u=1}^{r_s-1} \mathcal{B}_u^s$, which we call the batches of \mathcal{B}^s .

3.1.5. Choices in Batches. Through our construction every batch will provide exactly one entry.

This provides the numerical data collated in \mathcal{C} given by the ordered sequence of entries as one descends rows. Within a row no ordering is necessary.

Definition. A pair of neighbouring columns is said to be free if it has not been used in a previous step.

3.2. Detailing our Rules.

3.2.1. Stopped Entries.

Definition. An entry of $C_r(\infty)$ is said to be stopped at C_r if it does not appear in any column strictly to the right of C_r in $\mathcal{T}(\infty)$.

3.2.2. Generalizing [11, 4.7].

Recall the notation of 2.1.1 and take $r+1 \in [1, k]$.

Rule (1).

(a). Take $i \in R_{t'} \cap C_r(t, r)$ for some $t' \leq t$ and $\text{ht } C_{r+1}(t, r) = t$. (Here i is *not necessarily* the lowest element of $C_r(t, r)$.)

(b). Assume that the adjacent pair C_r, C_{r+1} is surrounded by free pairs of neighbouring columns of heights $s \in [t', t]$.

Then put i in $R_{t+1} \cap C_{r+1}(t, r)$, that is to say put i down by $t - t' + 1$ rows into $C_{r+1}(t, r)$, to obtain $C_{r+1}(t, r+1)$.

⁵Just as certain theoretical physicists have been known to postulate parallel universes, even infinitely many! In our case there will only be finitely many $\mathcal{T}^c(\infty)$ choices for a given \mathcal{T} .

Rule (2). Suppose (b) fails in Rule (1), then i is stopped at C_r .

Rule (3). If in Rule (1) one has $\text{ht } C_{r+1}(t, r) \leq t - 1$, so equality holds by the last paragraph of 3.1.1. Then put i in $R_t \cap C_{r+1}(t, r)$ to obtain $\mathcal{T}(t, r + 1)$.

Comments.

Rule (1) puts i in the batches $\mathcal{B}_{u_s}^s : s \in [t', t]$ given by the *uniquely determined* pairs of neighbouring columns $C_{u_s}^s, C_{u_s+1}^s$ surrounding C_r, C_{r+1} .

Rule (1) is the same as [11, 4.7(iii)], if $\text{ht } C_{r+1} = t$ and has a left neighbour of height t and that $t = t'$. Yet if $\text{ht } C_{r+1} = t + 1$, Rule (1) is not [11, 4.7(ii)] which says that i is stopped at C_r .

Rule (2) incorporates (part of) [11, 4.7(ii),(iv)].

Rule (3) just moves i horizontally by one column and rightwards in the row R_{t+1} . It is rule [11, 4.7(i)].

Notice that unlike [11, 4.7] we have put this Rule (3) *last*. Doing this incorporates the ordering \preceq used in loc cit.

Observations.

(i). As (b) of Rule (1) requires *free* pairs of neighbouring columns, it is *automatic* that only one entry in each box is chosen.

(ii). There is *always* one entry in each batch $\mathcal{B}_u^t : t \in \mathbb{N}^+, u \in [1, r_s - 1]$ that can be used in Rule (1), namely when $i \in \mathcal{B}_u^t$ is farthest to the right. Recalling the last sentence of 3.1.2, $\text{ht } C_{u+1}^t = t$ in \mathcal{T} , so i can be inserted into $R_{t+1} \cap C_{u+1}^t$.

Example 1. Consider the composition $(1, 2, 1)$. We must first lower 3 from C_2 into $R_2 \cap C_3$. Then 3 can be translated horizontally into $R_2 \cap C_3$. Yet if we do the second operation first, then 2 is blocked *and we fail to use the neighbouring columns of height 1 and so fail to incorporate the corresponding Benlolo-Sanderson invariant*. This example was also noted in [11, 4.7] and there \preceq was used to prevent “blockage”.

In our new set-up, one may have $\text{ht } C(\infty) > \text{ht } C$, for some columns C , for two different reasons. First if $t > t'$ in (b) of Rule 3.2.2.

Example 2. Consider the composition $(2, 1, 2, 1)$. Then 3 belongs to both $\mathcal{B}_{2,4}^1$ and $\mathcal{B}_{1,3}^2$. In view of the available surrounding columns, 3 may be lowered by two rows into R_3 below 5. This differs from the composition tableau in which 4 is lowered into R_4 below 6 and then 2 is moved horizontally into C_2 and then into R_3 below 5.

Secondly if already $\text{ht } C_{r+1}(t, r) > \text{ht } C_{r+1}$.

Example 3. Consider the composition $(1, 2, 1, 2)$. The two possible component tableaux are given in Figure 2 with (momentarily looking ahead to 3.1.4, the decoration of lines given in Figure 3.

N.B. 1. By Rules (1) – (3), the entry i of $R_{t'} \cap C_r(t, r) : t' \leq t$ may only be placed in the first empty box of $C_{r+1}(t, r)$. Thus in $\mathcal{T}(\infty)$ only one integer can fill a given box of \mathcal{D}' .

Again there are no gaps in columns of $\mathcal{T}(\infty)$ and no gaps in rows except the gap to the left mentioned already in 3.1.1. Finally $\mathcal{T}(\infty)$ is semi-standard, though not quite in the usual sense [11, 4.8].

N.B. 2 All the batches of $\mathcal{B}^s : s \in [t', t]$ are only fully determined when $\mathcal{T}(t)$ is completed, because as entries are lowered batches change. This makes it difficult to compute $|\mathcal{C}|$, except algorithmically case by case.

The limiting tableau $\mathcal{T}(\infty)$ depends on \mathcal{C} and should be more fully denoted by $\mathcal{T}^{\mathcal{C}}(\infty)$, though we shall generally desist from doing so to avoid cumbersome notation.

(**). Since a pair of neighbouring columns has to be free, it can be used only once in the above construction.

All this may seem complicated to some readers. Actually it is very natural. Moreover we believe it well-nigh impossible to imagine these component tableaux otherwise and in the process to gain a horde of components, without some pain.

Remark. Notice that entries in $\mathcal{T}(\infty)$ are always translated to right adjacent columns. As a consequence the boxes in a given column $C(\infty)$ have distinct entries, whilst this is false of rows.

3.2.3. Summarising the Passage from $\mathcal{T}(t)$ to $\mathcal{T}(t+1)$.

Fix $t \in \mathbb{N}^+$.

Consider $\mathcal{T}(t)$ to have been constructed. Then complete the $(t+1)^{\text{th}}$ row of $\mathcal{T}(t+1)$.

Recall the allowed choices of i in the batches of $\mathcal{B}^s : s \in [t', t] : t' \leq t$, given in Rule (1) of 3.2.2. In this each $i \in R_{t'}$ moves to the right across one column and down $t - t' + 1$ rows, or by Rule (2) may be stopped.

After that the remaining entries in the $(t+1)^{\text{th}}$ row of \mathcal{T} (so in $\mathcal{T}(t)$) are moved horizontally to the right sequentially starting from the leftmost one into the available empty boxes of \mathcal{D}' , through Rule (3) of 3.2.2). This last step is completely determined by the entries which have been lowered into R_{t+1} by the steps in the paragraph above.

We shall see (Lemma 3.2.5) that this moving down by $t-t'+1$ rows for an initial choice of $i \in \mathcal{B}^s : s \in [t', t]$ corresponds to there being $t-t'+1$ invariant generators defined by an appropriate set of $t-t'+1$ pairs of neighbouring columns surrounding the column C containing i and its right adjacent column C' (see (ii) below).

3.2.4. *Rules for the Construction of labelled lines in $\mathcal{T}^c(\infty)$.* As in [11, 6.5] the tableau $\mathcal{T}^c(\infty)$ is to be decorated by lines, each line $\ell_{i',j'}$ joining distinct entries of boxes. These were obtained in loc. cit. by examining the composition map (see [11, 5.3]). Here we merely *impose* similar rules given below. Of course we are doing this for each choice of $\mathcal{T}^c(\infty)$. The miracle is that this procedure leads to a Weierstrass section (see Section 5) for each component of \mathcal{N} in the image of the component map (so conjecturally for every component).

N.B. To $\ell_{i',j'}$ we may associate the basis element $x_{i',j'} \in \mathbf{M}$ and the root $\alpha_{i',j'}$. In all what follows we shall barely distinguish between the three. *Yet we shall never add roots only root vectors.*

3.2.5. *Lines with label $*$.* Recall that in the *composition* tableau every “step” produces a vertical line which we decorate with a $*$. There a step meant that if C_r, C_{r+1} are adjacent tableaux with $\text{ht } C_{r+1} = t$ and $i \in R_t \cap C_r(t, r)$, then i is moved right and downward by *one row* into the empty box below the lowest box in C_{r+1} through [11, 4.7(ii)].

Then a vertical line labelled with a $*$ is drawn from $i \in R_{t+1} \cap C_{r+1}(t, r+1)$ to the entry j of the *lowest* box in C_{r+1} .

However there is a novelty here which arises because [11, 4.7(ii)] has been replaced by Rule (1) of 3.2.2. The latter allows *three new* possibilities.

First it can happen that $i \in R_{t'} \cap C_r(t, r)$ is moved right and downward by $t-t'+1$ rows into the first empty box below the lowest box $R_t \cap C_{r+1}$ in C_{r+1} through Rule (1) of 3.2.2.

Then draw a vertical line labelled by a $*$ from $i \in R_{t+1} \cap C_{r+1}(\infty)$ to each of the $t-t'+1$ entries j_k in $R_k \cap C_{r+1} : k \in [t', t]$. Recalling that $\text{ht } C_{r+1} = t$, one observes that these are the lowest $t-t'+1$ entries of C_{r+1} .

Example 4. Consider the composition $(2, 1, 1, 2, 1)$. Then $\mathcal{B}_{2,3}^1 = \{3\}$, $\mathcal{B}_{3,5}^1 = \{4, 5\}$. Then in the first step 3, 5 are lowered into R_2 as shown in Figure 4. Then

$\mathcal{B}_{1,4}^2 = \{2, 3, 4\}$. This gives three tableaux as illustrated in Figure 4. In this, the second is the canonical tableau and in the third, 4 is lowered by $t - t' + 1 = 2$ rows from R_1 into R_3 .

Secondly this may be repeated, but only in a more modest fashion. Indeed $\text{ht } C_{r+1} = t$ and (to avoid cumbersome terminology) we shall simply say its height has been increased by one by placing i in the first empty box below C_{r+1} , so in row R_{t+1} .

In this the neighbouring columns of heights $s \in [t', t]$ surrounding C_r, C_{r+1} have been used. As a consequence the entries of $C_r(\infty)$ in rows $R_u : u \in [t' + 1, t]$ are stopped at C_r . On the other hand the new C_{r+1} obtained from the step described in the previous paragraph has height t . This means the entry of $R_{t+1} \cap C_r(\infty)$ need not be stopped at C_r and then by Rule (1) of 3.2.2 may have gone (down by just one row) into $R_{t+2} \cap C_{r+1}(\infty)$ using the pair of neighbouring columns of height $t + 1$ surrounding C_r, C_{r+1} .

Thirdly this last step may be repeated several times. This was already illustrated in Example 3.

Example 5. Consider the composition $(3, 2, 1, 2, 2, 1, 3)$. Then $7 \in \mathcal{B}_{3,6}^1 \cap \mathcal{B}_{4,5}^2$ and so can be lowered by two rows below 10. Then $\mathcal{B}_{2,4}^2 = \{5\}$, $\mathcal{B}_{4,5}^2 = \{8\}$. In this we have already used the pair C_4, C_5 of neighbouring columns of height 2 and so 8 is stopped at C_4 .

Yet we can move 5 by one row under 8 in C_4 . Then $\mathcal{B}^3 = \{3, 5, 7\}$, so 5 can be lowered one row below 7 in C_5 . This exemplifies the second part with $t' = 1, t = 2$, as illustrated in Figure 6.

Lemma. *The number of lines in $\mathcal{T}^e(\infty)$ with label $*$ is the number of pairs of neighbouring columns.*

Proof. This is essentially obvious except for one subtle point. First every pair of neighbouring columns is used at most once by (**) of 3.2.2 and each produce a vertical line in $\mathcal{T}(\infty)$ labelled by a $*$.

Conversely we must show for all $s \in \mathbb{N}^+$ that every pair of neighbouring columns C, C' is used in constructing a given component tableau. Indeed by Observation (ii) of 3.2.2 there is always one entry of $\mathcal{B}_{C,C'}^s$ which is a possible choice in 3.2.2, Rule (1). Such a choice is not excluded by 3.2.2, Rule (3) which is performed after 3.2.2, Rule (1). (See also Example 1.)

□

3.2.6. *The lines with label 1.* Consider $C_r(\infty), C_{r+1}(\infty)$ as adjacent columns in $\mathcal{T}(\infty)$.

The lines with label 1 are deemed to arise when a box in $C_r(\infty)$ has been stopped at some C_r . Then the entry i of that box is defined to be the left end-point of the resulting line ℓ . It is the rightmost appearance of $i \in \mathcal{T}(\infty)$. The right end-point of ℓ is *chosen* to be an element of C_{r+1} defined inductively by descending its rows. It is the highest available entry of the box in C_{r+1} whose entry is not already a right end-point of a line starting higher up in $C_r(\infty)$, whose left-end point is stopped at C_r . One easily checks that these lines are right and up-going.

We also obtain lines joining boxes in adjacent columns of $\mathcal{T}(\infty)$ with the *same* entry i . We call these lines neutral, or having a neutral label.

Trailer. A preview of the labelled lines we obtain between $C_r(\infty)$ and $C_{r+1}(\infty)$ may be obtained from Figure 1.

Notation. Given a column C of \mathcal{T} and $p \in \mathbb{N}^+$, let $C^{>p}$, be the partial column formed from the rows $R_{p'} : p' > p$ of C . Let $C^{\leq p}$ be the truncated column obtained from C by removing $C^{>p}$. A similar notation is used for a column $C(\infty)$ of $\mathcal{T}(\infty)$.

Let us make four observations concerning the lines joining boxes in $C_r(\infty), C_{r+1}(\infty)$ with label 1, which result from the above construction.

(i). Suppose for all $t', t \in \mathbb{N}^+ : t \geq t'$ that $C_r(\infty) \cap R_{t'}$ and $C_{r+1}(\infty) \cap R_t$ do not have a common entry.

By the rules in 3.2.2, it follows that $\text{ht } C_{r+1} \geq t$ and an entry $i_{t'}$ of $C_r(\infty) \cap R_{t'} : t' \leq t$ is stopped at C_r giving a horizontal line with label 1 in $\mathcal{T}(\infty)$ to the entry $j_{t'}$ of $C_{r+1} \cap R_{t'}$.

In other words we just obtain a set of horizontal lines with label 1 joining $R_{t'} \cap C_r(\infty)$ to $R_{t'} \cap C_{r+1}$, for all $t' \in [1, t]$.

Otherwise

(ii). let t' be minimal such that $R_{t'} \cap C_r(\infty)$ and $R_{t+1} \cap C_{r+1}(\infty)$ for some $t \geq t'$, share a common entry $i_{t'}$, so are joined by a neutral line.

In this recall 3.2.2, Rule (1) that we must have had $\text{ht } C_{r+1} = t$. Then for all $m \in [t' + 1, t]$ the entry i_m of $R_m \cap C_r(\infty)$ is stopped at C_r , because as noted in 3.2.5 the pairs of neighbouring columns of heights $s \in [t', t]$ are no longer free.

If $t > t'$, this gives for all $m \in [t' + 1, t]$, a line with label 1 from i_m to the entry j_{m-1} of $R_{m-1} \cap C_{r+1}$.

On the other hand as noted in 3.2.5, the entry i_{t+1} of $R_{t+1} \cap C_r(\infty)$ need not be stopped at C_r and may go down by one row entering $R_{t+2} \cap C_{r+1}(\infty)$. Again these boxes are joined by neutral lines. Moreover “this going down by one row” may be repeated several times, or not at all. In the latter case the entry i_{t+1} (if it exists) of $R_{t+1} \cap C_r(\infty)$ is joined by a line with label 1 to the entry j_t of $R_t \cap C_{r+1}$. Otherwise

(iii). Let t'' be maximal such that for all $s \in [t, t'']$ the boxes $R_s \cap C_r(\infty)$ and $R_{s+1} \cap C_{r+1}(\infty)$ share a common entry $i_s \in [1, n]$.

The entry $i_{t''+1}$ of $R_{t''+1} \cap C_r(\infty)$ (if it exists) is stopped at C_r (because the box $R_{t''+1} \cap C_{r+1}(\infty)$ is filled by $i_{t''}$ and by hypothesis $i_{t''+1}$ does not enter $C_{r+1}(\infty) \cap R_{t''+2}$). Let j_t be the entry of $R_t \cap C_{r+1}$. This produces (at most) one right up-going line $\ell_{i_{t''+1}, j_t}$ labelled by 1 from $R_{t''+1} \cap C_r(\infty)$ to $R_t \cap C_{r+1}$.

(iv). For $t'' > t + 1$, the entries of $R_{t''} \cap C_r(\infty)$ and of $R_{t''} \cap C_{r+1}(\infty)$ coincide (so are joined by neutral lines) or are both empty. Thus there are no right-going lines with label 1 from $C_r(\infty)$ to $C_{r+1}(\infty)$ other than those described in (i) – (iii) above.

In the above notation we obtain

Corollary. *In $\mathcal{T}^c(\infty)$ right going lines with label 1 join adjacent columns $C_r(\infty), C_{r+1}(\infty)$. They are horizontal through (i), (ii) with the exception of the lines $\ell_{i_m, j_{m-1}}$ which are right and up-going by one row and the line $\ell_{i_{t''+1}, j_t}$ which is right and up-going by $t'' - t + 1$ rows. Moreover*

(i). *The lines with label 1 and the composition of a neutral line with a line having label $*$ joining boxes in $C_r(\infty), C_{r+1}(\infty)$ cannot have both the same start and end points. In other words the label on a line (if it has one) is determined by its end-points.*

(ii). *Distinct lines with label 1 can neither have the same start-point in $C_r(\infty)$ nor the same end-point in C_{r+1} .*

Recall 3.2.4 and set $\text{ht } C_{r+1} = t$. Consider a neutral line from $b := R_{t'+j} \cap C_r(\infty)$ to $R_{t+1+j} \cap C_{r+1}(\infty)$ with either $m := t + 1 - t' > 1$ and $j = 0$, or $m = 1$ and $j \in \mathbb{N}$, composed with a line labelled by a $*$ from the latter box to a box in $C_{r+1}^{>t-m}$.

(iii). *The entries of $C_r(\infty)$ lying strictly above b are either this composed line to $C_{r+1}^{>t-m}$, or are stopped at C_r . In the latter case, the resulting line with label 1 has right end-point in $C_{r+1}^{\leq(t-m)}$, so having entry strictly smaller than those of $C_{r+1}^{>t-m}$.*

Proof. It remains to prove (i) – (iii).

(i). A line ℓ with label 1 (resp. $*$) from $C_r(\infty)$ to C_{r+1} arises when the entry i_m is stopped (resp. not stopped) at C_r . Hence (i).

(ii) is by construction. Indeed if $i_m \in C_r(\infty)$ is stopped at C_r , then its right end-point is uniquely specified and has an entry not already being the right end-point of a further line with label 1.

(iii). Of course (iii) is a mouthful. Hopefully it can be easily read off from Figure 1 and its caption, following its notation using m_1, m_2, m_3 . In this $t = \text{ht } C_{r+1} = m_1 + m_2$.

Suppose $m > 1$. In terms of Figure 1, we must take $m = m_1$ and $b := R_{m_1+1} \cap C_r(\infty)$. Then the entries strictly above b lie in $C_r(\infty)^{\leq m_1}$. They are stopped at C_r , giving horizontal lines with label 1 having entries in $C_{r+1}^{\leq m_1}$, whilst $t - m = m_1 + m_2 - m_2 = m_1$. Yet the entries of C_{r+1} increase down the rows and so an entry of $C_{r+1}^{\leq m_1}$ is strictly less than one of $C_{r+1}^{> t-m}$.

Suppose $m = 1$. In terms of Figure 1, we must either take $b \in R_j \cap C_r(\infty) : j \in [m_1 + 2, m_1 + m_2]$ and then its entries are stopped at C_r and the resulting line with label 1 has right end-point strictly above the largest entry in C_{r+1} , namely $j_{m_1+m_2}$, or we must take $b \in R_j \cap C_r(\infty) : j \in [m_1 + m_2 + 1, m_1 + m_2 + m_3 - 1]$ and the corresponding entries are joined to the entry $j_{m_1+m_2}$ of C_{r+1} by a line labelled by a $*$.

Finally the neutral horizontal lines lie in $R_{t''} : t'' > m_1 + m_2 + m_3$. Thus their common end-points lie strictly below the right hand end-point of any line with label 1, as can be easily read off from Figure 1. \square

Remarks. Added to (i), (ii), one can have right going lines from a box, one having label 1 and one being a neutral line composed with a line with label $*$. For example take the composition $(1, 1, 2)$. Then 1 is not stopped at C_1 and we obtain a composed line $\ell_{1,2}$ with label $*$, whilst it is stopped at C_2 and we obtain a line $\ell_{1,4}$ with label 1. Again (see Figure 1) we can have left going lines from a box one with label 1 and one with label $*$ and there may be several left (resp. right) going lines with label $*$ from a box.

(iii) is used to prove Proposition 6.2.4.

Overview. Let us spell out in detail the family of lines between $C_r(\infty), C_{r+1}(\infty)$, described by the Corollary. They are illustrated in Figure 1. In this the vertical lines are rounded for clarity.

First there can be m_1 horizontal lines with label 1 between the first m_1 rows of C_r, C_{r+1} .

Then there can be m_2 vertical lines with label $*$ from the *first new* entry i of $C_{r+1}(\infty) \setminus C_{r+1}$ to each of the last m_2 entries of C_{r+1} . In this there can be up to m_2 lines with label 1 from $C_r(\infty)$ going up by one row to C_{r+1} to its last m_2 entries.

After that there can be m_3 vertical lines with label $*$ from the m_3 new entries of $C_{r+1}(\infty)$ to the lowest entry of C_{r+1} . In this there can be at most one line with label 1 from $C_r(\infty)$ to the lowest entry of C_{r+1} going up by m_3 rows.

All non-negative integer values of m_1, m_2, m_3 are permitted.

The result is illustrated in Figure 1. It has a notable up-down symmetry.

3.2.7. Translation to lines in \mathcal{T} . A labelled line in $\mathcal{T}(\infty)$ joins boxes with entries in $[1, n]$. If it is labelled by a $*$, its upper end point lies in \mathcal{T} but its lower end-point does not lie in \mathcal{T} . If it is labelled by a 1 then its right hand end-point lies in \mathcal{T} , whilst its left-hand end point may or may not lie in \mathcal{T} . However there are unique boxes in \mathcal{T} with any given entry and such a line determines a unique line in \mathcal{T} , with the same entries as end-points.

Notation. The numerical data \mathcal{C} which defines the limiting tableau $\mathcal{T}^{\mathcal{C}}(\infty)$ is thus transferred to a tableau $\mathcal{T}^{\mathcal{C}}$ with lines joining boxes in distinct columns and labelled by 1 or by $*$. The $\mathcal{T}^{\mathcal{C}}$ is called the component tableau defined by the numerical data \mathcal{C} . We denote it by $\mathcal{T}^{i,j,\dots}$ when i, j, \dots is a sequential choice of positive integers in batches so defining \mathcal{C} . We recommend some practice in computing $\mathcal{T}^{\mathcal{C}}$. In this the examples at the end of the main text may be helpful,

N.B. It is of course no longer true that the lines with label $*$ are vertical in $\mathcal{T}^{\mathcal{C}}$. Rather they are right and up or down going (or horizontal). Again as in [11, Lemma 6.2(i)] there can be several right going lines labelled by a $*$ from a given box of $\mathcal{T}^{\mathcal{C}}$. However there is a novelty here. Unlike [11, Lemma 6.2(ii)] there can be several left going lines labelled by $*$ from a given box of $\mathcal{T}^{\mathcal{C}}$. All this is already illustrated by two possible choices of \mathcal{C} for the composition $(2, 1, 1, 2)$.

On the other hand it is still true (Corollary 3.2.6(ii)) that a box in $\mathcal{T}^{\mathcal{C}}$ can have at most one left going line and at most one right going line labelled by a 1.

Again in \mathcal{T} the right-going lines with label 1 need not only be up-going. This is because by the rules of 3.2.2 the above entry of $R_s \cap C_j(\infty)$ might have come from a column to its left in row $R_{s'} : s' \leq s$. Consequently the right going lines with label 1 being down-going and then up-going by $t - t' + 1$ (with $t \geq t'$ defined in (ii) – (iii) of 3.2.4. For the composition tableau one always has $t' = t$ (if t exists) so the right going lines with label 1 are down-going or up-going by at most one row (as we concluded in [11, Lemma 5.3.2]).

One might add that the rather complicated rules in 3.2.2 introduce some symmetry in the set $\mathcal{T}^{\mathcal{C}}$ and ultimately some symmetry in the set of components constructed

through component tableaux, whilst the canonical component tableau had a built-in asymmetry [8, 4.2.2]. In particular for the composition $(2, 1, 1, 2)$ we obtained just one component of \mathcal{N} using only the canonical component tableau; but trivially there is a second component obtained through the Dynkin diagram automorphism.

Directly recovering this “symmetry” is not too easy in general.

For the composition tableau described in [11, 4.7], the transition from $\mathcal{T}^c(\infty)$ to \mathcal{T}^c is illustrated by going from Figure 2 to Figure 1 in [11].

4. THE EXCLUDED ROOTS AND B SATURATION SETS

It is convenient to adopt the convention of **N.B.** of 3.2.4 conflating roots, root vectors and lines in \mathcal{T}^c .

4.1. General Remarks. Our aim is to define for each component tableau \mathcal{T}^c a subalgebra \mathfrak{u}^c (or simply, \mathfrak{u}) spanned by root vectors of \mathfrak{m} such that the component corresponding to \mathcal{T}^c is $\overline{B.\mathfrak{u}^c}$. The remaining positive roots of \mathfrak{m} are called the excluded roots. They will need to satisfy, *for starters*, three properties. In this the component tableau is to specify a sum e_c (or simply, e) of root vectors given by the lines carrying a 1 and a vector space V_c (or simply, V) spanned by the root vectors given by the lines carrying a $*$.

However to ensure that a component tableau gives a component of \mathcal{N} they will also have to satisfy a minimality property and *this is far more delicate*. For example we could have chosen the excluded roots to be all those not labelled by a 1. However this fails to give correct dimension (see 4.3.1) because $P.e$ need not be dense [9, 6.10.7] in a component of \mathcal{N} .

4.1.1. *Initially Required Properties.*

(i). A root corresponding to a line given by a line carrying a $*$, is an excluded root. This implies that $V \cap \mathfrak{u} = 0$.

(ii). A root corresponding to a line given by a line carrying a 1 is not an excluded root. This implies that $e \in \mathfrak{u}$.

(iii). \mathfrak{u} is stable under the action of L^- . This implies that $\overline{B.\mathfrak{u}}$ is P stable.

(iv). \mathfrak{u} is a subalgebra of \mathfrak{m} .

Of course in (iv) one can ask what class of subalgebras? For orbital varieties we obtain subalgebras of \mathfrak{n} complemented⁶ by a subalgebra of \mathfrak{n} .

In exceptional cases the span of the excluded root vectors also form a subalgebra of \mathfrak{n} . This is a sufficient condition for $\overline{B.\mathfrak{u}}$ to be an orbital variety closure. It is not a necessary condition because $\overline{B.\mathfrak{u}}$ does not determine \mathfrak{u} . In general $\dim B.\mathfrak{u} \leq \frac{1}{2} \dim G.\mathfrak{u}$. The necessary and sufficient condition for $\overline{B.\mathfrak{u}}$ to be an orbital variety closure is that equality holds.

Ultimately our procedure for constructing (algorithmically) a composition tableau \mathcal{T}^c gives rise to a subalgebra \mathfrak{u}^c of \mathfrak{m} such that $\mathcal{C} := \overline{B.\mathfrak{u}^c}$ is a component of \mathcal{N} . We have absolutely no idea of how else a component could have been written down, or even how to have guessed otherwise a suitable choice of \mathfrak{u}^c . At present even \mathfrak{u}^c is given only algorithmically and some might say by an arduous procedure.

4.1.2. *Labelling.* We use the same convention as in [9, 6.9.3], namely in \mathbf{M} we encircle the excluded roots in \mathfrak{m} .

Again we recall our convention [9, 4.1] that the roots in \mathfrak{m} corresponding to lines in \mathcal{T} with a label 1 (resp. $*$) are given the same labels in \mathbf{M} .

Then (cf [9, 6.9.3]) (i),(ii) of 4.1.1 become, in the special case of the canonical component (alias: composition) tableau, the following.

- (i) Every $*$ is encircled.
- (ii) No 1 is encircled.

We prove these assertions here for all component tableaux by a *different* method than that used in [9, 6.9.3], for the special case of the composition tableau. Notably in the special case of the composition tableau this will give much less excluded roots than before. In a weak sense (see 4.3.11) the present choice is a minimal choice.

4.1.3. *Constructing the set of excluded roots.* Our recipe for constructing the excluded roots is close to the simplest which recovers (i), modified to obtain vanishing 4.3. In this we shall follow closely but not exactly the construction and notations of [9, Sect. 2].

The excluded roots are constructed from the lines labelled by $*$ described in 3.2.5. Here recall the labelling of the columns of \mathcal{D} defined in 2.1.1 and consider a column C_{r+1} strictly to the right of C_1 . Set $t = \text{ht } C_{r+1}$. Recall that in $\mathcal{T}(\infty)$, a line ℓ labelled by a $*$ is vertical and may join the $m \geq 1$ entries $j_{r+1}^m := \{j - k + 1\}_{k=1}^m$ of the partial column $C_{r+1}^{>t-m}$, to the box $R_{t+1} \cap C_{r+1}(\infty)$ with entry i_1 . Moreover

⁶The French would say supplemented, which is perhaps better terminology.

this may be repeated finitely many times, yet with only $m = 1$, joining the entries $i_u : u \in [1, v]$ of $R_{t+u} \cap C_{r+1}(\infty)$ to the entry j of $R_t \cap C_{r+1}$, as illustrated in Figure 1.

Notation. j_{r+1}^m viewed often as the partial column $C_{r+1}^{>(t-m)}$ is abbreviated as \mathbf{j} , or simply j if it is a singleton.

Yet in the notation of 2.2.2, i_u also appears in a unique column $C_h := C_{(i_u)}$ of \mathcal{T} with $h < r + 1$ and in a unique row $R_f := R_{(i_u)}$. Thus in particular $i_u < j$, for all $j \in \mathbf{j}$.

In what follows we generally drop the subscript on i , using also the simplified notation of the previous paragraph for the unique box $R_f \cap C_h$ of \mathcal{T} containing i .

N.B. 1. Since $\ell_{i,j}$ is labelled by a $*$, it follows by 3.2.3 that i appears in $C_{r+1}(\infty)$ in a row *strictly* lower than R_f . That is to say that i goes non-trivially downwards as it progresses in $\mathcal{T}(\infty)$ through the rules of 3.2.2.

Claim. $\text{ht } C_g = f$, for some (unique) largest $g \in [1, h]$. Moreover it admits a right neighbouring column C'_g necessarily to the right of C_h .

Recall the construction 3.2.2, 3.2.3 of $\mathcal{T}(t + 1)$ and **N.B.1** above.

For the entry $i \in C_h \cap R_f$ to appear in $C_{r+1}(\infty)$ on going rightwards from C_h to $C_{r+1}(\infty)$ it must have gone in some first step strictly from R_f to $R_{f'}$ into a column $C_{h'}(\infty)$ to the right of C_h and to the left (not necessary strictly) of $C_{r+1}(\infty)$.

By 3.2.2, Rules (1), (2), this is only possible if the pair $C_h, C_{h'}$ is surrounded by a pair of neighbouring columns of height f .

The left-hand column of this pair (which cannot be C_h) is the required column C_g of height f .

This proves the claim.

By construction C_g lies to the left of C_h . It is C_h itself if perchance $\text{ht } C_h = f$. Otherwise let $C_{g_s}, C_{g_{s-1}}, \dots, C_{g_1} : h =: g_s > g_{s-1} > \dots \geq g_1$ be the columns of height $> f$ between C_h, C_g . Set $g = g_0$.

Recall the notation of 3.2.6 for partial and truncated columns.

Define \mathbf{j} above. Recall that \mathbf{j} forms the entries of the partial column $C_{r+1}^{>(t-m)}$ and that i is joined to each entry of \mathbf{j} by a vertical line labelled by a $*$. (See Figure 1).

Let $\mathcal{T}_{(i,\mathbf{j})}$ be the tableau obtained from \mathcal{T} by moving $C_{r+1}^{>(t-m)}$ directly below i in C_h and if $C_h^{>f}$ is not empty, successively making $C_{g_k}^{>f} : k = s, s-1, \dots, 1$ replace $C_{g_{k-1}}^{>f}$, in this skipping over the columns of height $< f$.

Definition. We refer to the former (resp. latter) operation as the **primary** (resp. **secondary**) shifting of columns. The latter is absent if $\text{ht } C_h = f$, equivalently if i is the lowest entry of C_h .

($*$). Since $\text{ht } C_g = t$ and is the first with this property, this process ends exactly when C_g is reached.

N.B. 2. Thus the columns which are altered are C_{r+1} and those which lie in $[C_g, C_h]$ of height $\geq f$.

This construction is a refinement of that used in [9, 2.6]. In particular an example of this manipulation can be viewed in [9, Figures 1,2].

Some readers may find this complicated, but it is deeply and mysteriously intertwined with the construction of a component of \mathcal{N} .

4.1.4. *The Excluded Roots.* One has the following standard result (cf. [9, Lemma 2.5]).

($*$). For a given $w \in W$ the root subspaces of \mathfrak{m} which do *not* lie in $\mathfrak{n} \cap w\mathfrak{n}$ are the $x_{i,j} : i < j$ with i after j in the word form of w .

Recall the notation of 4.1.3.

Let $w_{\mathcal{T}}$ (resp. $w_{\mathcal{T}_{i,\mathbf{j}}}$ or simply $w_{i,\mathbf{j}}$) be the Weyl group element obtained from \mathcal{T} (resp. $\mathcal{T}_{i,\mathbf{j}}$) with word form given as in [9, 2.5], that is to say we define its word form by reading the columns of \mathcal{T} (resp. $\mathcal{T}_{i,\mathbf{j}}$) from bottom to top, starting from the leftmost column and moving rightwards.

Let \mathfrak{l}^+ (resp. \mathfrak{l}^-) be the span of the positive (resp. negative) root vectors in the Levi factor \mathfrak{l} of \mathfrak{p} .

Set $\underline{\mathbf{u}}_{i,\mathbf{j}} := \mathfrak{n} \cap w_{i,\mathbf{j}}\mathfrak{n}$. It is a subalgebra of \mathfrak{n} complemented by a subalgebra of \mathfrak{n} and so $B.\underline{\mathbf{u}}_{i,\mathbf{j}}$ is an orbital variety closure.

Definition. The set of positive root vectors $X_{i,\mathbf{j}}$ of \mathfrak{m} *not* appearing in $\mathfrak{u}_{(i,\mathbf{j})}$, is called the set of excluded root vectors defined by the pair (i, \mathbf{j}) . (This means that excluded roots lying in the Levi factor are ignored.) Let $\mathbf{X}_{i,\mathbf{j}}$ denote the span of the excluded root vectors defined by $X_{i,\mathbf{j}}$.

Lemma.

(i). $(\mathfrak{n} \cap w_{\mathcal{T}}\mathfrak{n}) \cap \mathfrak{l}^+ = 0$.

(ii). $\mathfrak{u}_{(i,\mathbf{j})} \cap \mathfrak{l}^+ = 0$.

(iii). $\mathfrak{u}_{(i,\mathbf{j})}$ is stable under the action of \mathfrak{l}^- .

Proof. If $k, l : k < l$ are in a fixed column of \mathcal{T} , then k lies above l and hence after l in the word from of $w_{\mathcal{T}}$, through the definition of the latter. Thus (i) follows from (*).

In the construction of $\mathfrak{u}_{(i,\mathbf{j})}$ entire lower parts of columns are moved to the left. Then comparing $w_{\mathcal{T}}$ and $w_{(i,\mathbf{j})}$, one immediately deduces that the property required for (i) is not upset. Hence (ii).

(iii) follows from (ii). Indeed fix a simple root α of the Levi factor \mathfrak{l} . Then the roots of \mathfrak{m} lie in α -strings, that is to say form simple $\mathfrak{sl}(2)$ modules with one dimensional weight spaces with weights which are a fixed translate by integers multiples of α . By (ii), the intersection of an α -string with $\mathbf{X}_{i,\mathbf{j}}$ is stable under x_{α} and therefore its complement is stable under $x_{-\alpha}$, in other words $\mathfrak{u}_{(i,\mathbf{j})}$ is stable under $x_{-\alpha}$. Since these root vectors generate \mathfrak{l}^- , this proves (iii). □

Definition. Recall 4.1.3. It is convenient to distinguish between the excluded roots $X_{i,\mathbf{j}}$ called **primary** which arise from the primary shifting of columns and those called **secondary** which arise from the secondary shifting of columns.

Observations.

(1) The second co-ordinate j' of a primary excluded root $x_{i',j'}$ of $X_{i,\mathbf{j}}$ lies in $C_{r+1}^{>(t-m)}$, The first co-ordinate i' is an entry in $C_{(i)}$ strictly above i or lying in a column strictly to the right of $C_{(i)}$ and to the left of C_{r+1} , subject to the condition $i' < j'$.

(2). There are no secondary excluded roots in $X_{i,\mathbf{j}}$, if i is the unique lowest entry in $C_{(i)}$.

(3). In the notation of 4.1.3, the second co-ordinate j' of a secondary excluded root $x_{i',j'}$ lies in $C_{g_k}^{>f}$ for some $k \in [1, s]$ and then its first co-ordinate i' lies in $[C_{g_{k-1}}^{\leq f}, C_{g_k}[$. Then those with first co-ordinate $i' \in C_{g_k}$ lie in the Levi factor and can be ignored. Since the columns in $]C_{g_{k-1}}, C_{g_k}[$ are of height $< f$, we obtain $i' \in R^f \cap [C_{g_{k-1}}, C_{g_k}[$. In particular the row containing j' is strictly below that containing i' .

4.1.5. *The Definition of $\mathfrak{u}^{\mathcal{C}}$.* Fix a component tableau $\mathcal{T}^{\mathcal{C}}$. Let \mathbf{L} denote the set of all pairs (i, \mathbf{j}) defined in 4.1.3.

Set $\mathfrak{u}^{\mathcal{C}} := \cap_{i,\mathbf{j} \in \mathbf{L}} \mathfrak{u}_{(i,\mathbf{j})}$. Of course it is again a subalgebra of \mathfrak{n} but *not* in general complemented by a subalgebra in \mathfrak{n} .

Thus 4.1.1(iv) holds. Again by Lemma 4.1.4(iii) above, we obtain 4.1.1(iii). It remains to prove 4.1.1 (i), (ii). They are re-expressed as 4.1.2 (i), (ii) of 4.1.2, and established below.

Thus $\overline{B.\mathfrak{u}^{\mathcal{C}}}$ is not in general an orbital variety closure, though it can be even if $\mathfrak{u}^{\mathcal{C}}$ is not complemented by a subalgebra in \mathfrak{n} . Indeed it is a closed subvariety of $\overline{G.\mathfrak{u}^{\mathcal{C}}}$ which itself admits a unique dense nilpotent orbit \mathcal{O} . By Spaltenstein [24] for any nilpotent orbit \mathcal{O} the intersection $\mathcal{O} \cap \mathfrak{n}$ is equi-dimensional of dimension $\frac{1}{2} \dim \mathcal{O}$, which is a union of orbital varieties. By definition all orbital varieties so obtain.

Thus $B.\mathfrak{u}^{\mathcal{C}} \subset G.\mathfrak{u}^{\mathcal{C}} \cap \mathfrak{n}$ and so has dimension $\leq \frac{1}{2} \dim \mathcal{O}$ with equality if and only if $\overline{B.\mathfrak{u}^{\mathcal{C}}}$ is an orbital variety closure.

Definition. The excluded root vectors X defining the complement of $\mathfrak{u}^{\mathcal{C}}$ in \mathfrak{m} is the union of the excluded root vectors $X_{i,\mathbf{j}} : (i, \mathbf{j}) \in \mathbf{L}$. Let \mathbf{X} denote the space they span.

The excluded root vectors of $\mathfrak{u}^{\mathcal{C}}$ will be enclosed in a circle, particularly when they are presented in \mathbf{M} . See Figure 12.

(*). Recall in $\mathcal{T}(\infty)$, that i is joined to each entry of \mathbf{j} by a vertical line labelled by a $*$, and that all lines in $\mathcal{T}(\infty)$ labelled by a $*$ occur as (i, \mathbf{j}) runs over \mathbf{L} .

Lemma. *Every $*$ is enclosed in a circle.*

Proof. Suppose $(i, \mathbf{j}) \in \mathbf{L}$. For all $j \in \mathbf{j}$, one has $i < j$ and by the construction \mathbf{j} appears directly below i in $\mathcal{T}_{i,\mathbf{j}}$, consequently i is after j in the word form of $w_{i,\mathbf{j}}$. Thus the assertion follows from (*) and the definition of the excluded roots of $\mathfrak{u}^{\mathcal{C}}$. \square

4.2. **Verifying** (ii). This is much more difficult and we need some preliminaries.

4.2.1. *Non-crossing.* Recall that in $\mathcal{T}^c(\infty)$, there can be multiple entries of a given $i \in [1, n]$ and at least one. Moreover the entries occur in adjacent columns either in the same row or on passing from left to right go down by one or possibly several rows (see 3.2.2).

Definition. The set of entries of i in $\mathcal{T}(\infty)$ is called an i -string and denoted by $S(i)$.

Notice by the **N.B.1** of 3.2.2 an i -string can pass through at most one box of a column $C(\infty)$ of $\mathcal{T}^c(\infty)$ (being then the unique box in $C(\infty)$ with entry i).

Lemma. (Notation 2.1.1)

(i). For each $i \in [1, n]$, there exists a unique i -string. It is determined by (and determines) the unique entry of $i \in \mathcal{T}$ and the label on the lines $\ell_{i,i'}$ with right end-point in $C_{r+1} : r \in [1, k]$.

The lines $\ell_{i,i'}$ in \mathcal{T}^c are labelled by a $*$ or by a 1.

(ii). For $i_1, i_2 \in [1, n]$ distinct, the strings $S(i_1), S(i_2)$ cannot cross.

Proof. (i). Recall that \mathcal{T} is a sub-tableau of $\mathcal{T}^c(\infty)$. Then $S(i)$ starts at the unique box of \mathcal{T} containing i . Then by 3.2.2 either i moves rightwards from a column $C_r(\infty)$ to a right adjacent column of $C_{r+1}(\infty)$ of $\mathcal{T}^c(\infty)$ and downwards by $m \geq 1$ rows by a neutral line, or i is stopped at C_r .

In the first case by Corollary 3.2.6 (see Figure 1) it is joined by exactly m up-going vertical lines all having a label $*$ to (successive and distinct) entries of C_{r+1} , so determining m . This may be repeated for larger values of $r \in [1, k]$.

Again i may be stopped at C_r and then it is joined by a line with label 1 to an entry of C_{r+1} .

If i is not stopped for any $r \in [1, k]$ then $S(i)$ reaches the last column of \mathcal{D} .

(ii). Let $C_r, C_{r+1} : r \in [1, k]$ be adjacent columns, where a crossing first occurs in $\mathcal{T}^c(\infty)$. We can assume that on reaching $C_r(\infty)$ that $S(i_2)$ lies below $S(i_1)$. In particular $i_1 \in R_{r_1} \cap C_r(\infty), i_2 \in R_{r_2} \cap C_r(\infty)$ with $r_2 > r_1$. Then the assertion can be read off from Figure 1 which shows that none of the neutral lines from $C_r(\infty)$ to $C_{r+1}(\infty)$ cross. □

4.2.2. *Starting Places.* Recall that \mathcal{T} is a sub-tableau of any $\mathcal{T}^c(\infty)$ constructed from \mathcal{T} .

The starting place of an s -string is defined to be the unique box of $\mathcal{T}(\infty)$ in which s appears in \mathcal{T} . It is the leftmost entry of $s \in \mathcal{T}(\infty)$.

Suppose that $S(i_1), S(i_2)$ pass through a common column $C'(\infty)$. Then by Lemma 4.2.1 it makes sense to say that $S(i_2)$ lies strictly below $S(i_1)$ in $\mathcal{T}^c(\infty)$.

Lemma. *Under the above hypothesis, the starting place of $S(i_2)$ is to the left of $S(i_1)$.*

Proof. In the notation of 2.2.2, $C_{(i_1)}$ (resp. $C_{(i_2)}$) is the column of \mathcal{T} containing the starting place of i_1 (resp. i_2). The lemma amounts to saying that $C_{(i_2)}$ lies to the left of $C_{(i_1)}$.

Let $C_{r+1}(\infty)$ be the leftmost column through which $S(i_1), S(i_2)$ both pass and suppose C_{r+1} lies strictly to the right of $C_{(i_1)}$.

Let C_r be the left adjacent column to C_{r+1} . Then $i_1 \in C_r(\infty)$ and since by hypothesis it enters $C_{r+1}(\infty)$, it must enter $C_{r+1}(\infty) \setminus C_{r+1}$, by 3.2.2. Since by hypothesis i_2 lies in $C_{r+1}(\infty)$ strictly below i_1 , necessarily $i_2 \in C_{r+1}(\infty) \setminus C_{r+1}$. Then by 3.2.2 again, we must have had $i_2 \in C_r(\infty)$, contradicting the choice of C_{r+1} .

This contradiction forces $C_{r+1} = C_{(i_1)}$ and so $C_{(i_2)}$ lies to the left of $C_{(i_1)}$, as required. \square

4.2.3. *Primary Excluded Roots.* Recall the lines with label $*$ described in 3.2.5 and the lines with label 1 described in Corollary 3.2.6 with respect to the pair C_r, C_{r+1} of $\mathcal{T}(\infty)$. Below we use Figure 1 whose notation we adopt.

Observations.

(1). By Observation (1) of 4.1.4 the second co-ordinate j' of a primary excluded root defined by the pair C_r, C_{r+1} lies in C_{r+1} .

(2). On the other hand if i' is an entry of $C_{r'}(\infty)$ stopped at $C_{r'}$, then by Corollary 3.2.6, the second co-ordinate j' of the root vector $x_{i',j'}$ so defined lies in $C_{r'+1}$.

(3). Observe that the entries of C_{r+1} label the columns of the column block \mathbf{C}_{r+1} .

Lemma. *Fix a component tableau $\mathcal{T}^c(\infty)$. The roots vectors defined by the pairs (i', j') , where i' is an entry of $C_{r'}(\infty)$ stopped at $C_{r'}$ is not excluded by any one of the primary excluded roots of $\mathbf{u}_{i,j}$ defined by a vertical line joining $i \in C_{r+1}(\infty)$ to $j \in \mathbf{j} \subset C_{r+1}$.*

Proof. By (1), (2) we can assume $r = r'$ without loss of generality. Even more convincingly, if $r \neq r'$, then by (3) these two sets of vectors lie in different column blocks of \mathbf{M} .

The remainder of the proof may be visualized through Figure 1 and this should make the proof transparent.

In Figure 1, there are m_1 horizontal lines from $R_i \cap C_r(\infty)$ to $R_i \cap C_{r+1}$ with label 1. These cannot be primary excluded roots for the pair (i, \mathbf{j}) since their right end-points are left in place in constructing $\mathcal{T}_{i, \mathbf{j}}$.

In the first step following the appearance of the said m_1 horizontal lines, the entry i_{m_1+1} of $R_{m_1+1} \cap C_r(\infty)$ is joined by a neutral line to the entry of $R_{m_1+m_2+1} \cap C_{r+1}(\infty)$ which is then joined by vertical lines with label $*$ to the lowest m_2 entries of C_{r+1} , ending at its lowest point in row $R_{m_1+m_2}$.

Apart from the end-points of these horizontal lines, disposed of above, an entry i' of $C_r(\infty)$ stopped at C_r lies in up to m_2 places *below* i_{m_1+1} .

Set $i_{m_1+1} = i$.

On the other hand i' lies in a unique box of \mathcal{T} , which by Lemmas 4.2.1, 4.2.2, lies either, strictly below i in the unique column $C := C_{(i)}$ of \mathcal{T} containing i , or in a column strictly to the left of C . It is the first co-ordinate i' of a root $x_{i', j'}$ labelled by a 1.

Yet by Observation (1), 4.1.4, the first co-ordinate i' of an excluded root $x_{i', j'}$ of $\mathbf{u}_{(i, \mathbf{j})}$ is an entry in C strictly above i or lying in a column strictly to the right of C .

Then by the last two paragraphs, a root with label 1 coming from the first step and a primary excluded root cannot coincide.

For the second step, set $t = m_1 + m_2$ still using the notation of Figure 1.

Then $i_k : k \in [t + 1, t + m_3 - 1]$ is an entry of $R_k \cap C_r(\infty)$ joined by a neutral line to $R_{k+1} \cap C_{j+1}(\infty)$ which is further joined by a vertical line with label $*$ to the unique lowest box in $R_t \cap C_{r+1}$. Then there is at most a line ℓ with label 1 from $i' = i_{t+m_3}$ to the entry j' of $R_t \cap C_{r+1}$.

The corresponding root defined by this possibly new line labelled by a 1 is not excluded by the primary excluded roots from the new lines labelled by a $*$. Indeed $i' = i_{t+m_3}$ lies strictly below $i = i_{t+k} : k \in [1, m_3 - 1]$, so we may apply Lemmas 4.2.1, 4.2.2 and proceed just as in the first part.

Yet there is one more subtle point! Why don't the roots with label $*$ coming from the first step exclude the root with label 1 coming from the second step, since i_{t+m_3} of the second part lies strictly below the $i_{m_1+k} : k \in [1, m_2]$ of the first part?

Now in the first step, the resulting primary excluded roots lie in the rightmost m_2 columns of the column block \mathbf{C}_{r+1} in \mathbf{M} and in rows given by the entries below i in $C_{(i)}$ or in a column to the right of $C_{(i)}$.

On the other hand in \mathbf{M} the line ℓ coming from the second step (if it exists) lies in the last column of the column block \mathbf{C}_{r+1} , but in a row defined by an entry of a column of \mathcal{T}^c strictly to the left of $C_{(i)}$.

□

4.2.4. Secondary Excluded Roots.

Lemma. *No element of 1 can be encircled by a secondary excluded root.*

Proof. Fix some component tableau \mathcal{T}^C .

A secondary excluded root is created by a line $\ell_{i,j}$ labelled by a $*$. Following the notation of 4.1.3, let $R_f \cap C_h$ be the unique box in \mathcal{T} containing i . As noted in Claim 4.1.3 there is a column $C_{h'}$ strictly to the right of C_h in \mathcal{T} such that i enters $C_{h'}(\infty)$ strictly below R_f and this forces there to be a pair of neighbouring columns C_g, C'_g surrounding $C_h, C_{h'}$ with $i \in \mathcal{B}_{C_g, C'_g}^f$.

By Observation (3) of 4.1.4 the co-ordinates of a secondary excluded root $x_{i',j'}$ satisfy $i' \in R^f \cap [C_g, C_h[, j' \in R_{f'} \cap C_{r+1}$ for some $f' > f$ and column $C_{r+1} \in]C_g, C_h]$.

Now suppose $\ell_{i'',j''}$ is labelled by a 1. It is enough to show that i'' cannot equal i' . Of course $x_{i'',j''} \in \mathfrak{m}$, so i'' lies in a column strictly to the left of C_{r+1} . Moreover $i'' \in \mathcal{T}^C(\infty)$ must be stopped at C_r and must lie in $R_{f''} \cap C_r(\infty)$ with $f'' \geq f'$. This is because the line $\ell_{i'',j''}$ is up-going as it passes from $C_r(\infty)$ to C_{r+1} (see Figure 1).

We conclude that the i'' -string descends strictly from R^f to $R_{f''}$.

This means in particular that i'' belongs to a batch $\mathcal{B}_{C,C'}^f$, obviously to the left of $\mathcal{B}_{C_g, C'_g}^f$. These batches must be distinct because the first (resp. second) is used to lower i'' (resp. i) whilst 5.2.2(1) allows only entry of each batch to be used for a given component tableau.

We conclude that C' lies to the left of C_g , though not necessarily strictly.

Yet we saw above for $\ell_{i',j'}$ to be a secondary excluded root one must have $i' \in [C_g, C_h[$ and for $\ell_{i'',j''}$ to be labelled by a 1 one must have $i'' \in [C, C'[$. Yet by the previous paragraph these two sets have null intersection, so we cannot have $i'' = i'$.

Hence the assertion of the lemma. □

Example 6. Consider composition $(1, 2, 2, 1, 3, 2)$ and take $i = 8, j = 11$. Then $f = 2$ and $C_h = C_5$. Consequently $C_{h'} = C_6$ and $C_g = C_3, C'_g = C_6$.

The excluded roots obtain from $\mathcal{T}_{8,11}$ drawn in Figure 8. Those which are secondary are $\alpha_{i',9}$ with $i' \in \{4, 5, 6\}$. (Those which are primary are $\alpha_{i',11}$ with $i' \in \{7, 8\}$). Thus $f' = 3, r = 4$.

The second batch $\mathcal{B}_{C,C'}^f$ in the lemma is obtained by taking $C = C_2, C' = C_4$ and necessarily $f = 2$. This forces $i'' = 3$, so the resulting line $\ell_{3,9}$ with label 1 cannot give a secondary excluded root coming from the line $\ell_{8,11}$ with label $*$.

Remark. Some readers might complain that this is a rather “degenerate” example, since many columns of the lemma coincide and particularly the i -chain is

reduced to a singleton. Yet the proof itself only depends on the box containing i , the subsequent peregrinations of the i -chain being unimportant for secondary excluded roots⁷, and the rather simple secondary shifting of partial columns. What is important is condition 4.1.3(*), that this shifting does not go beyond C_g , whilst the second author greedy for zeros to obtain “vanishing”, wanted it to push further, but finally desisted.

4.2.5. Combining the above two lemmas we obtain.

Proposition. *In no component tableau is a 1 encircled.*

Proof. The construction of 4.1.3 gives by definition *all* the excluded roots. These are encircled (in \mathbf{M}). Then Lemmas 4.2.3, 4.2.4 can be interpreted as saying that no circle encloses a 1. This holds for every component tableau. Hence the assertion. \square

Remark. This proof, though not so short, is easier (and more general) than that given in [9, 6.9.2, 6.9.3] for which the reader was advised to take a deep breath.

4.3. A Vanishing Theorem.

4.3.1. *Meaning of the excluded roots.* Let $\mathcal{T}^{\mathcal{C}}$ be a component tableau. Recall that \mathcal{C} is numerical data specifying $\mathcal{T}^{\mathcal{C}}$ through selection of entries in batches.

Define $\mathbf{u}^{\mathcal{C}}$ as in 4.1.5. Recall (4.1) that $\mathbf{u}^{\mathcal{C}}$ is complemented in \mathfrak{m} by the direct sum of the excluded root vectors.

As before set $\mathcal{C} := \overline{B \cdot \mathbf{u}^{\mathcal{C}}}$. It is an irreducible closed subvariety of \mathfrak{m} . Let \mathbf{g} be the number of generators of $S(\mathfrak{m})^{\mathcal{C}}$. We wish to show that \mathcal{C} lies in \mathcal{N} , is of dimension $\dim \mathfrak{m} - \mathbf{g}$ and is a component of \mathcal{N} .

Recall that $e_{\mathcal{C}}$ (resp. $V_{\mathcal{C}}$) denotes the sum of the root vectors (resp. root subspaces) defined by the lines with label 1 (resp. *). By Proposition 4.2.5 one has $e_{\mathcal{C}} \in \mathbf{u}^{\mathcal{C}}$. On the other hand 4.1.2(i) holds by construction (cf 4.1.3) and so $V_{\mathcal{C}} \cap \mathbf{u}^{\mathcal{C}} = 0$.

We may present the excluded roots with respect to a given $\mathbf{u}^{\mathcal{C}}$ as being represented by a 0 in \mathfrak{m} rather than an O .

In the former role we may consider the generating Benlolo-Sanderson invariants being evaluated on \mathfrak{m} by setting all the entries of the excluded roots equal to zero. Since the Benlolo-Sanderson invariants are B invariant and homogeneous their vanishing means that $\mathcal{C} \subset \mathcal{N}$.

The proof of vanishing is given below. We must do this for all choices of parabolics of $\mathfrak{sl}(n)$, all components \mathcal{C} and all Benlolo-Sanderson invariants $I_{\mathcal{C}, \mathcal{C}'}^s$.

This is equivalent to proving that a triply infinite sequence of determinants growing exponentially in n , all vanish when the excluded roots are set equal to zero.

⁷Yet important for the primary excluded roots.

Considering this the proof is rather easy! Its proof is due to the first author and is also her inspired choice of excluded roots which are practically a minimal set. A larger set of excluded roots is possible but there is a danger here that the resulting zero locus \mathcal{Z} defined by this bigger set of excluded roots may be too small. For example the second author had suggested that one might choose the set of all excluded roots to be those not labelled by a 1. Through the existence of a Weierstrass section it is immediate for this choice that \mathcal{Z} is contained in \mathcal{N} . Yet by [9, 6.10.7], the sum e of the root vectors labelled by a 1 need *not* be regular, that is generate a P orbit of codimension \mathfrak{g}). As in consequence \mathcal{Z} has in general too small a dimension⁸.

We start with some preliminaries.

4.3.2. Chains of Roots. Let $l_1 < l_2 < \dots < l_k$ be elements of $[1, n]$ in \mathcal{D} . It gives a chain of roots $\alpha_{l_i, l_{i+1}} : i \in [1, k-1]$ forming a system of type A_{k-1} . The corresponding monomial $\prod_{i=1}^{k-1} x_{l_i, l_{i+1}}$ is said to form a monomial chain (of type A_{k-1}).

The Benlolo-Sanderson invariants are polynomials in the $x_{i,j}^*$ which by definition are the co-ordinate functions on $x_{i,j} \in \mathfrak{m}$. We call these the dual vectors.

A composite line \mathcal{L} is a concatenation of lines $\ell_{i,j}$, with $i < j$, joining boxes in \mathcal{T} which we call constituents (or constituent lines) of \mathcal{L} . We say that a composite line \mathcal{L} is directed if every constituent line passes strictly from left to right. Then the entries of the boxes satisfy $l_1 < l_2 < \dots < l_k$. Thus a directed composite line gives a monomial chain of type A .

If two composite lines are disjoint (pass through no common boxes) then the roots in the different chains are orthogonal and the monomial chains are said to be disjoint.

Fix a pair of neighbouring columns C, C' of height s . By a slight and temporary modification of the notation of 2.1.1 the columns in $[C, C']$ will be denoted by $C =: C_1, C_2, \dots, C_k := C'$. Set $c_i = \text{ht } C_i$.

Define $d_{\mathcal{D}}$ as in 2.3.2. It is exactly the number of boxes in $[C, C']$ strictly below R_s .

As noted in [8, 4.1.6], after [2] the lowest degree coefficient of the restriction of \mathbf{M}_s^* to $\mathfrak{m} + a \text{Id}$ starts as $a^{d_{\mathcal{D}}} I_{C, C'}^s$. Miraculously this is a \mathfrak{p}' invariant.

Lemma. *The Benlolo-Sanderson invariant $I_{C, C'}^s$ is a sum (with appropriate signs) of products of s monomial chains of dual vectors. The products are given by all possible sets of s disjoint directed composite lines starting from C and ending in C' such that every chain passes through all possible choices of $\min(c_i, s)$ boxes in $C_i : i \in [1, k-1]$.*

Proof. The entries in the columns strictly to the left of C and strictly to the right of C' are absent as both the first or last co-ordinate is a root vector occurring in

⁸The second author was heavily censored by his students for explaining proofs that *do not* work. Perhaps this will be true of our readers. Nevertheless we do wish to emphasize the extreme delicacy of the present calculations.

$I_{C,C'}^s$. Thus we can assume without loss of generality that C, C' are the first and last columns of \mathcal{T} , in keeping with our above change of notation.

In this case recall the definition of \mathbf{M}_s^* given in 2.3.1. It is an $(n-s) \times (n-s)$ minor fitting snugly between its first and last matrix blocks of \mathbf{M} of size $s = \text{ht } C = \text{ht } C'$. View the entries of \mathbf{M}_s^* as functions on \mathfrak{m} through the Killing form, that is to say as dual vectors. Here the root vectors in \mathbf{M}_s^* that do not lie in \mathfrak{m}^- are discarded⁹.

By Lemma 2.3.5 the i^{th} Levi block contributes a factor of $a^{\max(0, c_i - s)}$ to the restriction of \mathbf{M}_s^* to $\mathfrak{m} + a \text{Id}$.

This result means that we must place $\max(0, c_i - s)$ copies of a in the diagonal of the i^{th} Levi factor of \mathfrak{p} in any fashion and this for all $i \in]1, k - 1[$. Then the corresponding coefficient of a^{d_\emptyset} , is exactly $I_{C,C'}^s$. Given that \mathbf{M}_s^* is a $(n-s) \times (n-s)$ minor, that is say a determinant of size $n-s$, the multiplication rules for calculating a determinant then give the required assertion. \square

Example 7. Consider the composition $(1, 2, 1)$. View \mathbf{M}_1^* as the 3×3 determinant with entries $x_{i,j}^* : i \in [1, 3], j \in [2, 4]$. Evaluate \mathbf{M}_1^* on $a \text{Id} + \mathfrak{m}$ and just retain the terms for which a appears on either the $(2, 2)$ or $(3, 3)$ entry. The second gives $ax_{1,2}^*x_{2,4}^*$ and corresponds to the composite line $\ell_{1,2,4}$, the first gives $ax_{1,3}^*x_{3,4}^*$ and corresponds to the composite line $\ell_{1,3,4}$. The lowest degree term in the expansion is $a(x_{1,2}^*x_{2,4}^* + x_{1,3}^*x_{3,4}^*) = aI_{C_1, C_2}^1$.

One might add that the second composite line does not leave the rectangle R_{C_1, C_3}^1 . In this special case there is just one. In general the term used in constructing the Weierstrass section (5.2.6) is always one composed from those that do not leave the rectangle $R_{C,C'}^s$.

4.3.3. An Upper Bound on Degree. Let C, C' be neighbouring columns of height s . Recall the notation of 2.1.1 and write $C = C_l, C' = C_m$, for some $l, m \in [1, k]$.

Now let the columns in $]C, C'[$ have arbitrary height. Set $c_i = \text{ht } C_i$.

Lemma. *Let M be a monomial which is a product of s disjoint directed composite lines starting from C and ending in C' . Then*

$$\deg M \leq \left(\sum_{i=l}^m \min(s, c_i) \right) - s. \quad (*)$$

Proof. Indeed the disjointness of the s lines means that can pass through at most s boxes of C_i and of course at most c_i boxes of C_i . Thus the total number of boxes

⁹As noted in [8, 3.6.3] this leads to *huge* economy of notation and thought since we not need to make \mathbf{M}_s^* depend on the sizes of the intermediate blocks. This is likely to be even more significant [8, 3.6.2] outside type A .

which these s lines meet is at most $\sum_{i=l}^m \min(s, c_i)$. Since there are s component lines from which one must subtract s to obtain the number of constituent lines. \square

Clearly $I_{C,C'}^s$ has degree $n - s - d_{\mathcal{Q}}$, which in turn one checks is the right hand side (*). We define this to be the true degree $\deg I_{C,C'}^s$ of $I_{C,C'}^s$, that is to say we set

$$\deg I_{C,C'}^s := \left(\sum_{i=l}^m \min(s, c_i) \right) - s. \quad (1)$$

Remark. Notice we obtain the same result for the true degree of $I_{C,C'}^s$ if we suppress all the numbers not occurring in the rectangle $R_{C,C'}^s$ but sum over all the columns of \mathcal{T} .

4.3.4. *Virtual Degree.* We define in 4.3.6 a new tableau $\hat{\mathcal{T}}$ with respect to $I_{C,C'}^s$ by shifting some boxes to the left.

In addition following the Remark 4.3.4 we suppress all entries not in $[C, C']$.

It is clear that there will still be exactly s disjoint monomial chains, and that the monomials defined by the chains are unchanged. The only difference is a composite line need not be directed. Indeed a constituent $l_{i,j} : i < j$ of this composite line may either join boxes in the same column or the composite line may zig-zag, that is say admit a constituent also going strictly from right to left. We call these constituent lines, *exceptional*.

Let \hat{C}_i be the column of $\hat{\mathcal{T}}$ corresponding to the column C_i of \mathcal{T} , by shifting some boxes to the left, as made explicit in 4.3.6. Set $\hat{c}_i := \text{ht } \hat{C}_i$. We define the virtual degree $\deg \hat{I}_{C,C'}^s$ of $I_{C,C'}^s$ to be

$$\deg \hat{I}_{C,C'}^s = \left(\sum_{i=l}^m \min(s, \hat{c}_i) \right) - s. \quad (2)$$

Lemma. *Suppose $\deg \hat{I}_{C,C'}^s < \deg I_{C,C'}^s$, and that every exceptional constituent is an excluded root. Then $I_{C,C'}^s$ is zero when all the excluded roots are set equal to zero.*

Proof. If there are no exceptional constituents, then the composite lines are directed and by Lemma 4.3.3 the virtual degree is an upper bound on $\deg I_{C,C'}^s$. Through the hypothesis of the lemma we obtain the required contradiction. \square

Remark 1. This is easy because we have swept under the carpet all the difficulties, which we must now tackle.

Remark 2. Permit us to preview a consequence of the existence of a Weierstrass section. It defines (Theorem 5.2.5) a monomial in $I_{C,C'}^s$ of degree $\deg I_{C,C'}^s$ by Proposition 5.1.1(i) and of virtual degree exactly one less than this through Proposition

5.1.1(ii), taking account of 4.1.2. Thus we have no option but to prove the *very tight assertion* that

$$\deg \hat{I}_{C,C'}^s = \deg I_{C,C'}^s - 1. \quad (3)$$

4.3.5. *Attaching Excluded Roots to a Fixed Invariant.* Fix a component tableau \mathcal{T}^c .

Lemma. *With respect to \mathcal{T}^c and $I_{C,C'}^s$, there is a unique i -string starting in $R_u \cap [C, C'[,$ for some minimal $u \leq s$ and passing to $R_{s'} \cap C''(\infty)$, with $s' > s$ and $C'' \in]C, C']$.*

Moreover if i lies strictly to the right of the rightmost column of height $s' > s$ in $]C, C'[,$ then $s' = s + 1$ and i enters $R_{s+1} \cap C'$.

Proof. Recall $\mathcal{B}_{C,C'}^s$ is a single batch and take i in that batch as specified by the choice of \mathcal{T}^c .

Consider the corresponding i string in $\mathcal{T}^c(\infty)$. By 3.2.2, Rule 1, it passes into empty boxes of adjacent columns in $]C, C'[,$ as $\mathcal{T}^c(\infty)$ is built from \mathcal{T} . Then since $\text{ht } C = s$ it cannot cross C and so starts in $R_{C,C'}^s$ in some row $R_u := R_{(i)}$, where $u \leq s$. Finally it enters $R_{s'} \cap]C, C']$, for some $s' > s$.

Hence the first part of the lemma.

Let $C_{\geq s}$ be the rightmost column of $]C, C'[,$ of height $\geq s$ (possibly C itself) The columns in $]C_{\geq s}, C'[,$ have height $< s$. Thus an entry in $]C_{\geq s}, C'[,$ must lie in $R_t : t < s$. Then by 3.2.2 such an entry cannot be moved strictly below R_{s+1} until it leaves $]C_{\geq s}, C'[,$. Moreover when it does enter $R_{s+1} \cap]C_{\geq s}, C'[,$ it translates horizontally into $R_{s+1} \cap C'$.

Hence the second part of the lemma. □

Remarks. It can happen that $s' > s + 1$ - see the bottom tableau in Figure 4. Here $i = 4$ whilst $s = 1, s' = 3$. It can also happen that i is “blocked” from entering $R_{s'+1} \cap C'$. In this example blockage occurs if one introduces a column of height 3 between C_4 and C_5 .

Definition and Notation. The unique i -string associated by the lemma to the pair of neighbouring columns C, C' (of height s) and component data \mathcal{C} is called the i -string of penetration, or penetrating i -string. In this we set $i = i_{C,C'}^{\mathcal{C}}$.

4.3.6. *The Definition of $\hat{\mathcal{T}}_{I,\mathcal{C}}$.* Fix $s \in \mathbb{N}$ and a pair C, C' of neighbouring columns C, C' of height s . Set $I = I_{C,C'}^s$. To I and some component data \mathcal{C} we may associate an i -string of penetration by Lemma 4.3.5.

To this data we associate a new tableau $\hat{\mathcal{T}}_{I,\mathcal{C}}$ (or simply, $\hat{\mathcal{T}}$) as follows.

First the i string of penetration starts in a unique box of \mathcal{T} in the rectangle $R_{C,C'}^s$. In \mathcal{T}^c , this i -string moves to right, possibly just horizontally, but possibly also downwards by “steps”, in going from a column to an adjacent column in $\mathcal{T}^c(\infty)$.

Label the steps (defined by i moving strictly downwards) by $u \in [1, t]$. This means that i goes from a column $C_{r_u}(\infty)$ to an adjacent column $C_{r_{u+1}}(\infty)$ and goes down by $m_u \geq 1$ rows.

Set $t_u = \text{ht } C_{r_{u+1}}$, for all $u \in [1, t]$. Let $j_{r_{u+1}}$ (or simply, j) be the unique lowest element in $C_{r_{u+1}}$ and set $j_{r_{u+1}}^{m_u} = \{j - m_u + 1, j - m_u + 2, \dots, j\}$. In the notation of 4.1.3, these are the entries of the partial column $C_{r_{u+1}}^{>t_u-m_u}$. Observe that $C_{r_{u+1}}^{>t_u-m_u}$ is a partial column with m_u rows. Expressed briefly $\text{ht } C_{r_{u+1}}^{>t_u-m_u} = m_u$.

Now form the partial column $C^{\hat{m}}$ with $\hat{m} = \sum_{u=1}^t m_u$ rows by empling the partial columns $C_{r_{u+1}}^{>t_u-m_u} : u \in [1, t]$, the first going on top and so downwards as u increases. As we shall see partly below and in 4.3.9, the above order is vital to preserve the set of primary excluded roots.

On the other hand, i appears in $C_h := C_{(i)}$ in some unique row $R_f = R_{(i)}$ of \mathcal{T} .

By the claim of 4.1.3 applied to the case $u = 1$, there exists a column C_g of height f for some unique largest $g \leq h$.

If $\text{ht } C_h > f$, let $C_{g_v}, C_{g_{v-1}}, \dots, C_{g_1} : h =: g_v > g_{v-1} > \dots \geq g_1$ be the columns of height $> f$ between C_h, C_g . Set $g = g_0$.

In a manner similar to the construction in 4.1.3, define $\hat{\mathcal{T}}$ by first removing $C_{r_{u+1}}^{>t_u-m_u}$ from $C_{r_{u+1}}$ for all $u \in [1, t]$ and then forming $C^{\hat{m}}$ as in the fifth paragraph above. Then $C^{\hat{m}}$ is placed below $i \in R_f \cap C_h$, displacing the partial columns $C_{g_s}^{>f} : s = v, v-1, \dots, 1$ successively to the left skipping over the columns of height $< f$, till C_{g_0} is reached.

For any column C of \mathcal{T} , let \hat{C} be the column of $\hat{\mathcal{T}}$ replacing C in the above construction. In particular \hat{C}_{g_v} is obtained by placing $C^{\hat{m}}$ on top of $C_{g_v}^{\leq f}$ and by our choice of ordering in $C^{\hat{m}}$ its entries decrease strictly on going up the rows.

Thus the only difference between $\hat{\mathcal{T}}$ and any one of the $\mathcal{T}_{i,j}$ is that $C_{(i)}^{>f}$ has been replaced by the “amalgamated” partial column $C^{\hat{m}}$ instead of one of the partial columns $C_{r_{u+1}}^{>t_u-m_u} : u \in [1, t]$.

Let \hat{w} denote the Weyl group element defined by $\hat{\mathcal{T}}$ as in 4.1.4 with respect to which one further defines as in 4.1.4 the excluded roots associated to $\hat{\mathcal{T}}$.

Thus the primary excluded roots coming from pairs $(i, j) : i < j$ with both i, j in \hat{C}_{g_v} , exactly arise when i is above j in \hat{C}_{g_v} . (Some may define root vectors in Γ^+ and are ignored - see Definition 4.1.4).

(*). For all $i \in [1, v-1]$, $\hat{C}_{g_{i-1}}$ is the composite column with $C_{g_{i+1}}^{>f}$ placed below $C_{g_i}^{\leq f}$.

Remark. The above amalgamation is *mandatory* to show, by our present method, that the present *triplely infinite exponentially growing family* of determinants all become zero on setting the excluded roots equal to zero. We believe the proof is short, rather elegant and certainly much simpler than anything else imaginable.

4.3.7. *Changes of column heights.* Recall that the i -string of 4.3.6 is penetrating and so passes from $R^s \cap C_{r_u}(\infty)$ into $R_{s'} \cap C_{r_{u+1}}(\infty)$ for some $s' \geq s+1$ at the last step.

The following lemma describes the changes in column heights on going from \mathcal{T} to $\hat{\mathcal{T}}$.

Lemma.

(i). $\text{ht } \hat{C}_{r_{u+1}} = \text{ht } C_{r_{u+1}} - m_u$, for all $u \in [1, t]$.

(ii). $\text{ht } \hat{C}_{g_v} = \text{ht } C_{g_0} + \hat{m}$.

(iii). $\text{ht } \hat{C}_{g_{i-1}} = \text{ht } C_{g_i}$, for all $i \in [1, v-1]$.

(iv). $\text{ht } \hat{C}_{g_v} = s'$.

Proof. (i) is an immediate consequence of removing a partial column of height m_u from the bottom of $C_{r_{u+1}}$.

(ii) is an immediate consequence of placing a partial column of height \hat{m} below $C_{g_v}^{\leq f}$, the latter having height $f = \text{ht } C_{g_0}$.

(iii) follows from 4.3.6(*).

(iv). The i -string passes from $R_f \cap C_{g_v}$ penetrating into $R_{s'} : s' \geq s+1$ at the last step. Thus $\hat{m} = s' - f = s' - \text{ht } C_{g_0}$, so by (ii) we obtain $\text{ht } \hat{C}_{g_v} = s' \geq s+1$. \square

Remarks. When we delete the entries not between C, C' then this just effects the heights of the columns C_i lying strictly to left of C and the corresponding modified columns \hat{C}_i .

Concerning the columns strictly to the left of C , we claim that their contributions cancel out when entries strictly to the left are also deleted.

Indeed with respect to *just the entries lying strictly to the left of C* , the heights of columns of height $\geq f$ are cyclically permuted as we pass from C_i to \hat{C}_i . This follows as in the proof of 4.3.6(*).

Thus in calculating the difference between the virtual and real degrees, the result is the same had we neither deleted the columns strictly to the left of C , nor their entries. However *a priori* this is an incorrect procedure!

Example 8. Consider the composition $(1, 3, 2, 1, 2)$ and the component in which 5 goes down one step below 7 and then one step below 9. Then C_1, C_2 have entries $\{1\}, \{2, 3, 4\}$ respectively whilst \hat{C}_1, \hat{C}_2 have entries $\{1, 3, 4\}, \{2, 6\}$ respectively. Retaining only the entries $\{1, 2, 3, 4\}$ which lie strictly to the left of C , it is immediate that the last assertion of the Remark holds, namely that heights are cyclically permuted (in this case just swapped) as the columns acquire a hat.

4.3.8. *Verifying Equation (3).*

Lemma. *Equation (3) holds.*

Proof. Retain the notation of 4.3.7 and recall the conclusion of Lemma 4.3.7.

The contribution of (iii) of the lemma to $\deg \hat{I}_{C, C'}^s - \deg I_{C, C'}^s$ is zero, since sums are just permuted.

Again the total decrease in column heights from (i) Lemma 4.3.7 is \hat{m} which is exactly compensated by the increase of the column height coming from (ii).

Yet we still must take account of having to compare minima with respect to s .

Indeed $\min(\text{ht } \hat{C}_{g_v}, s) = s$, which is a drop of $s' - s$ from $\text{ht } \hat{C}_{g_v}$.

On the other hand the penetrating i -string only penetrates the rectangle $R_{C, C'}^s$ at the last step, that is when $u = t$. Thus we obtain $\text{ht } C_{r_u+1} < s$, for $u \in [1, t-1]$, whilst $\text{ht } C_{r_t+1} = s' - 1 \geq s$.

Combined these combined contributions to $\deg \hat{I}_{C, C'}^s - \deg I_{C, C'}^s$ sum to -1 , even when $s' - 1 > s$. This recovers (3). □

Example 9. Consider the composition $(2, 1, 2, 1)$ and the invariant which comes from the pair C_2, C_4 of neighbouring columns of height 1.

There is a component in which 4 goes down one step below 6. Here $s = 1, s' = 2$.

There is a second component in which 3 goes below 5. Here $s = 1, s' = 3$.

In both cases one recovers Equation (3).

4.3.9. *Primary Excluded Roots.* Recall Definition 4.1.4 and the notation of 4.3.6.

Lemma. *The primary excluded roots defined by $\hat{\mathcal{F}}$ are the same as those coming from the $\{\mathcal{T}_{(i,j)} : j \in C^{\hat{m}}\}$.*

Proof. This is because the primary excluded roots coming from $j \in C^{\hat{m}}$ being placed below r in $C_{(r)}$ as a part $C^{\hat{m}}$, are the same as those when we just place j below r in $C_{(r)}$.

In the notation of 4.3.6, take $u, u' \in [1, t]$ with $u < u'$. Then with respect to the first paragraph above, in the first (resp. second) case using $\hat{\mathcal{F}}$ (resp. $\hat{\mathcal{F}}_{i,j}$), $i' \in C_{r_u+1}^{>t_u-m_u}$ lies strictly above (resp. to the right) of $j' \in C_{r_{u'}+1}^{>t_{u'}-m_{u'}}$.

Recalling Observation (1) of 4.1.4 in either case $\alpha_{i',j'}$ is a primary excluded root through 4.1.4(*) and the way that the word form of a Weyl group element is constructed from the columns of $\hat{\mathcal{T}}$ (resp. $\hat{\mathcal{T}}_{i,j}$).

□

Example 10. Consider the composition $(2, 1, 1, 2)$ and the canonical component tableau in which 3 goes down twice by one row. The construction of 4.1.4 gives two tableaux $\mathcal{T}_{3,4}$ and $\mathcal{T}_{3,6}$, with excluded roots $\alpha_{3,4}$ (resp. $\alpha_{3,6}, \alpha_{4,6}$), all primary in both cases. (Here $\alpha_{5,6}$ is not counted since it is a root of the Levi factor.) These are combined in $\hat{\mathcal{T}}$, which has a column in which 4 is placed below 3 and then 6 below 4, but this fails if the latter order is reversed, where crucially $\alpha_{4,6}$ given by a vertical line fails to be an excluded root.

4.3.10. Secondary Excluded Roots.

Lemma. *The secondary excluded roots defined by $\hat{\mathcal{T}}$ are the same as those coming from the $\{\mathcal{T}_{i,j} : j \in C^{\hat{m}}\}$.*

Proof. This is because the same column $C_{(r)}$ is entered into for all cases. □

4.3.11. *Warning.* Yet the set of excluded roots in $\mathcal{T}^{\mathcal{C}}$ can still be strictly decreased in the presence of several pairs of neighbouring columns, as noted below.

Example 11. Consider the composition $(1, 2, 1, 2)$. For $\mathcal{T}^{\mathcal{C}}$ put 2 below 4 in C_3 and further put 3 below this new appearance of 2 in C_3 . Then $\mathcal{T}_{3,4}$ gives enough excluded roots so that *both* I_{C_1, C_3}^1 and I_{C_2, C_4}^2 vanish. Yet our general recipe includes the excluded roots coming from $\mathcal{T}_{2,4}$ which introduces an extra secondary excluded root $\alpha_{1,3}$ superfluous for vanishing but which does not give the wrong dimension for $\overline{B \cdot \mathbf{u}^{\mathcal{C}}}$, as one may check! (This also follows in a more general context from Proposition 6.2.4, since $\ell_{1,2}$ “covers” this secondary excluded root.)

On the other hand had we taken the canonical component, then the excluded root $\alpha_{1,3}$ *not* needed for the vanishing of I_{C_2, C_4}^2 *is* needed for the vanishing of I_{C_1, C_3}^1 .

The purist might ask “is there a minimal set of excluded roots”. This can be tricky. Indeed consider the

Example 12. Take the composition $(3, 2, 2, 1, 1, 2, 3)$ and 8 being moved under 9 and then 11, and 5 being moved under 7 and then under 8. Then the excluded roots coming from the 5-string ensure the vanishing of all the invariants except I_{C_4, C_5}^1 , for which we need to move 9 under 8.

4.3.12. *Exclusion of Exceptional Constituents.* Consider a monomial chain (i_1, i_2, \dots, i_u) of strictly increasing integers occurring in boxes of \mathcal{T} . In $\hat{\mathcal{T}}$ some of these boxes are moved to the left. This can cause the resulting chain to admit an

exceptional constituent, that is to say for some pair (i_u, i_{u+1}) the box containing i_{u+1} lies to the left (not necessarily strictly) of that containing i_u . This can only happen if in the notation of 4.3.6 one has $i_{u+1} \in \hat{C}_{g_t}$ for some $t \in [1, v]$, and i_u lies in a column of $\hat{\mathcal{T}}$ to the right (not necessarily strictly) of \hat{C}_{g_t} . However these roots are excluded roots (primary if $t = v$ and secondary if $t < v$) and so this monomial chain in $\hat{\mathcal{T}}$ is zero when the excluded roots are evaluated to zero. Thus in Lemma 4.3.4 a monomial in $I_{C, C'}^s$ is set to zero if it admits an exceptional constituent.

4.4. Specific Vanishing. Let $E_{C, C'}^{\mathcal{C}}$ be the set of excluded root vectors coming from the penetrating i -string $i_{C, C'}^{\mathcal{C}}$ defined for the Benlolo-Sanderson invariant $I_{C, C'}^s$.

Proposition. $I_{C, C'}^s$ vanishes when the $E_{C, C'}^{\mathcal{C}}$ are set equal to zero.

Proof. Combine Lemmas 4.3.4 and Lemmas 4.3.8-4.3.10 and the observation in 4.3.12. \square

4.5. Global Vanishing. Since Proposition 4.4 applies to any Benlolo-Sanderson invariant we obtain the

Theorem. *For all parabolics in type A and for all component tableaux, all the Benlolo-Sanderson invariants become zero when all the excluded root vectors are set equal to zero.*

Recall (4.3.1) the subvariety \mathcal{C} of \mathfrak{m} .

4.6. Containment in \mathcal{N} .

Corollary. *One has $\mathcal{C} \subset \mathcal{N}$.*

4.7. Limits to Amalgamation. Not all the tableaux $\mathcal{T}_{i, \mathbf{j}} : i, \mathbf{j} \in \mathbf{L}$ can be amalgamated into a single tableau. Since the latter defines $w \in \overline{W}$ such that the resulting component is $\overline{B \cdot (\mathfrak{n} \cap w\mathfrak{n})}$, this is possible if and only if $\overline{B \cdot \mathfrak{u}^{\mathcal{C}}}$ is an orbital variety closure which is not always the case. Indeed we believe that components which are orbital variety closures will be on average rare. Example 13 describes a case where full amalgamation is not possible. The calculation is indicated in Figures 9, 10.

Thus it is already a miracle that we only need the roots coming from the penetrating i -string to prove vanishing because had we needed to adjoin further roots, we could not have reduced our analysis to a single tableau $\hat{\mathcal{T}}$.

A second even bigger miracle is that Proposition 4.4 holds. This result is crucial to proving the injectivity of the component map (7.3).

4.8. **Example 14.** It is highly advisable to compute some examples of the labelling of the root vectors in \mathbf{M} by 1, * and their encirclement. In Example 14 we give the result in Figure 12 for the five different component tableaux which result from the parabolic defined by the composition $(2, 1, 2, 1, 2, 1)$. The reader may also wish to show that the all the six Benlolo-Sanderson invariants vanish on converting the circles to zeros, for each of the five component tableaux - an easy computation but not so easy when n is large (see Section 4.3).

4.9. **Precursor.** The origins of 4.4 lay in the following observation. Fix a pair of neighbouring columns C, C' of *maximal* height s and a component tableau T^c . Let $F_{C,C'}^c$ be the subset of *primary* excluded roots given by the lines with label * coming from the penetrating $i = i_{C,C'}^c$ string in $T^c(\infty)$. It is a subset of $E_{C,C'}^c$. Let τ be the involution on columns of \mathcal{T} defined by reversing the order of entries in each column. Let $C_{(i)}$ be the unique column of \mathcal{T} containing i and set $j := \tau(i), m = n - s$. Let \mathbf{M}_s be the $m \times m$ sub-matrix of \mathbf{M} in the upper right hand corner. It contains \mathfrak{m} . Evaluate to zero all the entries of \mathbf{M}_s not in \mathfrak{m} as well as those in $F_{C,C'}^c$. A simple exercise shows that the resulting matrix has j columns with $\leq j - 1$ rows with non-zero entries.

If $j = 1$, then $\det \mathbf{M}_s = 0$ trivially. Thus assume $j > 1$.

Now set $j' = m - j$. By the above \mathbf{M}_s has a $(j' + 1) \times (j - 1)$ sub-matrix in its lower left hand corner all of whose entries are 0. Thus $\det \mathbf{M}_s$ factors as the product of the $(j - 1) \times (j - 1)$ minor in its upper left hand corner and a $(j' + 1) \times (j' + 1)$ minor in its lower right hand corner, whose first column has only 0 entries. Thus $\det \mathbf{M}_s = 0$, in this case too.

This gives the conclusion of Proposition 4.4 with respect to the Benlolo-Sanderson invariant corresponding to a pair of neighbouring columns of maximal height.

As an example consider the left hand matrix in Figure 19. One has $i = 7, \tau(7) = 8$ Ignore the zeros lying in column 8 of \mathbf{M} , because these do not come from the penetrating i -string. Then columns 1 – 7, 11 of \mathbf{M}_s have only zeros in rows 7, 9 – 14. Notice that in this $x_{8,14}$ is *not* an excluded root and indeed putting 14 under 7 pushes 8 strictly to the left. All this underlies the very tight nature of our vanishing result.

We attempted unsuccessfully to reduce to the above case by using the secondary excluded roots.

5. WEIERSTRASS SECTIONS

5.1. **General Remarks.** Let \mathcal{T}^c be a component tableau. Let e_c (resp. V_c) be the sum of the root vectors (resp. the sum of the root subspaces) labelled by a 1 (resp. by a *) in \mathcal{T}^c .

We shall often drop the subscript.

We aim to show that to \mathcal{T}^c we may associate a component \mathcal{C} of \mathcal{N} containing e_c with $e_c + V_c$ being a Weierstrass section.

For the latter we need the two conditions described below.

5.1.1. Composite lines.

Definition.

A directed composite line is a concatenation of lines joining boxes in \mathcal{T} all going strictly from left to right. Composite lines are said to be disjoint if they do not go through the same boxes. The individual lines which make up the composite lines are called its constituents. (They are directed by the concatenation going from left to right.)

N.B.. In contrast to section 4.3, we *only* consider throughout Section 5 composite lines in $\mathcal{T}(\infty)$ (resp. in \mathcal{T}) whose constituents have neutral labels or are labelled by 1 or $*$ and are directed. We shall see from 5.2.4 that this corresponds to selecting just one monomial in each Benlolo-Sanderson invariant.

To obtain a Weierstrass section (for the action of a parabolic on its nilradical in type A) we will prove the following.

Proposition. *Between any two neighbouring columns C, C' of height s there is*

(i). *A unique disjoint union of composite lines passing through all the boxes in $R_{C,C'}^s$.*

(ii). *The constituent lines which make up the disjoint union, exactly one $\ell_{C,C'}^*$ is labelled by a $*$, the rest are labelled by a 1.*

Remarks. Evaluate the Benlolo-Sanderson invariant $I_{C,C'}$ on $\mathbf{1}+e+V$ by replacing $x_{i,j}$ by 1, if $\ell_{i,j}$ is labelled by a 1, by $v_{i,j}$, if $\ell_{i,j}$ is labelled by a $*$ and if $\ell_{i,j}$ has no label 0. Then by (i),(ii) its evaluation is $v_{i,j}$ [8, Lemma 4.2.5].

Condition (i) on its own is easy to satisfy. It results for example by just joining all adjacent boxes in \mathcal{D} by a horizontal line and taking the sum e of the root vectors (which all lie \mathfrak{m}). The nilpotency class for this choice of e is easy to compute from which one obtains $\dim G.e = 2 \dim \mathfrak{m}$. Yet (borrowing a trick from the proof of Richardson's theorem) one has $\dim G/P = \dim \mathfrak{m}$ and so $\dim P.e \geq \dim G.e - \dim \mathfrak{m} = \dim \mathfrak{m}$. This means that $P.e$ is dense in \mathfrak{m} , that is to say e is a Richardson element. This construction (of an explicit Richardson element in \mathfrak{m}) in Type A is due Ringel et al [3]. It caused quite a stir at the time and was generalised to biparabolics in all types [13], except curiously it fails for at least one biparabolic in type E_8 .

In more generality, if $e \in \mathfrak{m}$, then $G.e \cap \mathfrak{m} \supset P.e$ and so after Spaltenstein (cf [8, Eq. (1)]) one has $\dim P.e \leq \frac{1}{2} \dim G.e$, yet equality can fail [9, 6.10.9. Example 4].

In [9, Sect. 5] we gave a horrifically complicated procedure to modify the Ringel et al lines so that (ii) also held. Then in [11, Sect. 5] we found a *much* simpler (but totally mysterious) way to recover this result using the “composition tableau”. Now by modifying the construction we include the composition tableau in a rich new family of “component tableaux”, with magical, mysterious and miraculous properties.

5.1.2. *Separation.* Proposition 5.1.1 is not quite enough on its own to obtain a Weierstrass section because it could happen that the same co-ordinate of V is obtained twice. What we need is:

(*). The $\ell_{C,C'}^*$ are pairwise distinct.

Remark This can be satisfied [8, (P_2)] by requiring that exactly one of the lines joining boxes in $R_{C,C'}^s$ labelled by a $*$ meets R_s and we used this property to define $\ell_{C,C'}^*$ and thereby obtain a Weierstrass section for the canonical component [11]. Yet this property can fail for an arbitrary component tableau. We shall replace disjoint composite lines in \mathcal{T} by disjoint composite lines in $\mathcal{T}(\infty)$ and then miraculously the whole analysis in the proof of the Proposition 5.1.1 drastically simplifies and in this new context we also obtain (*).

Example 15. Consider the composition $(2, 1, 1, 1, 2)$. In this $\mathcal{B}_{C_1, C_5}^2 = \{2, 3, 4\}$ giving three tableaux and corresponding to Benlolo-Sanderson invariant I_{C_1, C_5}^2 . The first and last have indeed a line with a $*$ which meets R_2 , but for the middle one the lines labelled by a $*$ lie entirely in R_1 .

5.2. Collapsing.

5.2.1. *Composite and Special Composite lines in $\mathcal{T}(\infty)$.* Recall that in 3.2.6 we defined a neutral line between adjacent columns to be one joining boxes with the same entries. These are exactly the lines which form an i -string in $\mathcal{T}(\infty)$.

By 3.2.4 - 3.2.6 the right end-point of an i string may end with a vertical line in $\mathcal{T}(\infty)$ with label $*$ at a box with an entry $\psi_*(i)$ or with a line to a left adjacent column in $\mathcal{T}(\infty)$ with label 1 ending in a box (different by Corollary 3.2.6(i)), with an entry $\psi_1(i)$, different to $\psi_*(i)$ (though beware that we shall often drop the subscript on ψ). The constituents of such a composite line \mathcal{L} have all but one a neutral label.

A line with a neutral label in such a composite line \mathcal{L} may be collapsed, that is to say its end-points identified. Then \mathcal{L} becomes a line ℓ in \mathcal{T} joining (distinct) boxes with end-points $i, \psi_*(i)$ (resp. $i, \psi_1(i)$) and labelled by a $*$ (resp. by a 1). These

boxes will never be in the same column and indeed may lie in columns which are quite far apart.

Then collapsing neutral lines of such a composite line in $\mathcal{T}(\infty)$ joining boxes with entries $i, \psi(i)$ in $\mathcal{T}(\infty)$ gives a composite line \mathcal{L} in \mathcal{T} joining (unique) boxes with entries $i, \psi(i)$.

To avoid the resulting flying across possibly far-distant columns, it is highly advantageous to stay in $\mathcal{T}(\infty)$ for part of the calculation.

We may further concatenate such lines \mathcal{L} to form composite lines in $\mathcal{T}(\infty)$ still (cf [8, 4.2.3]) requiring that concatenated lines pass from left to right or down to up.

Finally the constituents of a composite lines may only have neutral labels (joining boxes with entries i) and such a line collapses to a single box with entry i .

Definition. A special composite line in $\mathcal{T}(\infty)$ is one consisting of only neutral lines or lines labelled by a 1. Examples are easy to find.

5.2.2. *Lines Between Neighbouring Columns.* Consider now a pair of neighbouring columns C, C' of height s and the rectangle $R_{C, C'}^s$ they define.

For all $i \in [1, s]$, let b_i be the entry of $R_i \cap C$.

Label the columns between C, C' as $\{C_i : i \in [1, k]\}$.

Fix numerical data \mathcal{C} to define $\mathcal{T}^{\mathcal{C}}(\infty)$. (Here we shall mainly drop the superscript.)

Recall that \mathcal{T} is a sub-tableau of $\mathcal{T}(\infty)$.

Proposition.

(i). *From every box in C except exactly one, to be denoted by b_m , there is a unique special composite line $\mathcal{L}_i : i \in [1, s] \setminus \{m\}$ in $R^s \cap \mathcal{T}(\infty)$ to a box in C' .*

(ii). *There is a special composite line from b_m which first goes into $R_{t'} \cap C_r(\infty) : t' \leq s, r \in [1, k-1]$, and then by a neutral line into $R_{t+1} \cap C_{r+1}(\infty) : t \geq s$ and some column $C_r \in [C, C']$. It can then be joined by a line $\ell_{C, C'}^*$ with label $*$ to an entry in $b'' := R_{t'} \cap C_{r+1}$, with $t'' \leq s$.*

(iii). *One may choose $\ell_{C, C'}^*$ so that the $\mathcal{L}_i : i \neq m$ do not pass through b'' .*

(iv). *One may form the composite line \mathcal{L}_m by concatenating the composite line from b_m to b'' and then by a special composite line to C' .*

(v). *The composite lines in (i),(iv) collapse to disjoint composite lines passing through every box of $R_{C, C'}^s$ in \mathcal{T} .*

(vi). Either (Case one), $\ell_{C,C'}^*$ has right end-point in $R_s \cap C_{r+1}$, or (Case two) $\text{ht } C_{r+1} \leq s$ and $\ell_{C,C'}^*$ joins $R_{s+1} \cap C_{r+1}(\infty)$ to the lowest entry of C_{r+1} .

Proof. (i). For all $t \in [1, s]$, $l \in [1, k-1]$, the unique u -string defined by the entry of $R_t \cap C_l$, either enters $R^s \cap C_{l+1}(\infty)$, or is stopped at C_l defining a unique line with label 1 to $R^s \cap C_{l+1}$ having right end-point $u' := \psi_1(u)$, or by Lemma 4.3.5, for some unique value r of l (specified by \mathcal{C}) u enters strictly below R_s . The uniqueness of this evolution proves (i) and specifies b_m as the unique starting box of C for which a u -string descends strictly below R_s .

(ii). Note that there exist $t' \leq s, t \geq s$, a unique special composite line from b_m to $R_{t'} \cap C_r(\infty)$ and a neutral line to $R_{t+1} \cap C_{r+1}(\infty)$ (with end-points u) going down by $t+1-t'$ rows.

Then there are two cases to consider.

Case one. This is when $t-t' > 0$, that is the common entry u goes down by $t+1-t' > 1$ rows to R_{t+1} . In this by 3.2.2 we must have $\text{ht } C_{r+1} = t$.

Then (see 3.2.4) there is a vertical line labelled by a $*$ from $R_{t+1} \cap C_{r+1}(\infty)$ to each of the boxes $R_{t''} \cap C_{r+1} : t'' \in [t, t']$. Choose that with $t'' = s$ and let v be the entry of $R_s \cap C_{r+1}$.

(*). By the last sentence of 3.2.6(ii) there *might* also be a right-going line¹⁰ with label 1 having right end-point in $R_s \cap C_{r+1}$, but then its left end-point must lie in $R_{s'} \cap C_r(\infty) : s' > s$, so by (i), it is not joined by any special composite line to $C \setminus \{b_m\}$.

Case two. This is when $t' = t = s$, that is the entry goes down by exactly one row. Then (see 3.2.4) there is a unique vertical line from $R_{s+1} \cap C_{r+1}(\infty)$ to $R_{t''} \cap C_{r+1}$, where $t'' = \text{ht } C_{r+1}$, so whose entry v is the lowest entry of C_{r+1} .

(**). Again by the last sentence of 3.2.6(iii), there *might* also be a right-going line¹¹ with label 1 having end-point in $R_{t''} \cap C_{r+1}$, but then its left end-point must lie in $R_{s'} \cap C_r(\infty) : s' > s$, so by (i), it is not joined by the special composite line to $C \setminus \{b_m\}$.

This gives (ii) with (*), (**) giving (iii). Again Case one (resp. Case two) of the proof of (ii) gives Case one (resp. Case two) of (vi).

¹⁰Namely, the upper dashed/dotted blue line in Figure 1.

¹¹Namely, the lower dashed/dotted blue line in Figure 1.

(iv) follows as in (i) noting that the special composite lines cannot pass (a second time) strictly below R_s .

(v). By Corollary 3.2.6(ii), no two distinct lines with label 1 may have the same right end-point. Then (v) follows from (i), (iv). \square

Remark. After collapsing $\ell_{C,C'}^*$ joins uniquely determined boxes in the rectangle $R_{C,C'}^s$.

5.2.3. *Uniqueness.* Again recall the **N.B.** of 5.1.1

Corollary. *There is a unique disjoint union of composite lines in $R_{C,C'}^s$ passing through all the elements of $R_{C,C'}^s$ given that the only constituent line labelled by a $*$ is $\ell_{C,C'}^*$.*

Proof. Let us first show that one cannot find a disjoint union of composite lines going through all the boxes in $R_{C,C'}^s$, with no constituent line labelled by a $*$. Such lines must be obtained by collapsing special composite lines \mathcal{L}_i in $R_{C,C'}^s$. As in the proof of Proposition 5.2.2(i) these are uniquely determined by their starting points in $R^s \cap C$ and ending points in $R^s \cap C'$. Disjointness would then force there to be a line with label 1 having the *same* starting and end points in $\mathcal{T}(\infty)$ as $\ell_{C,C'}^*$. This is excluded by Corollary 3.2.6(i), or by inspecting Figure 1.

Finally admitting that $\ell_{C,C'}^*$ does belong to the composite lines in the disjoint union and is the only one, forces the $\mathcal{L}_i : i \neq m$ to be the special composite lines of Proposition 5.2.2 and then the assertion of the Corollary obtains from the conclusion of Proposition 5.2.2. \square

5.2.4. *Disjointness.* We want to show that the above lemma remains valid if we omit the last condition, that is to say.

Proposition. *There is a unique disjoint union of composite lines in $R_{C,C'}^s$ passing through all the boxes of $R_{C,C'}^s$.*

Proof. Retain the notation of 5.2.2. The special composite lines $\mathcal{L}_i : i \in [1, s]$ are uniquely determined in $\mathcal{T}(\infty)$ up to C_r and must be disjoint. Hence they pass through all the boxes in $R^s \cap \mathcal{T}(\infty)$ in $[C, C_r]$. Now the lines in $\mathcal{T}(\infty)$ labelled by a $*$ are vertical. Then disjointness successively precludes a box joining lines in $R^s \cap \mathcal{T}(\infty) \cap [C, C_r]$ to be labelled by a $*$.

If $\ell_{C,C'}^*$ is one of the constituent lines of our unique disjoint union of composite lines, then in $\mathcal{T}(\infty)$, the subset $R^s \cap [C, C_{r+1}]$ can only be formed by the union of the $\mathcal{L}_i : i \in [1, s]$ and then by the first paragraph this also holds in $R^s \cap [C, C']$. Thus the only way the conclusion of the proposition can fail is for $\ell_{C,C'}^*$ to be absent.

Now any continuation of the composite lines $\mathcal{L}_i : i \neq m$ from $R^s \cap C_r(\infty)$ to $R^s \cap C_{r+1}(\infty)$ must leave empty one entry of $R^s \cap C_{r+1}(\infty)$. Of course this must be filled with the end point of \mathcal{L}_m which enters $C_r(\infty)$ in $R_{s'} : s' > s$. Let ℓ be the required additional constituent line from $R_{s'} \cap C_r(\infty)$. It cannot be a line with label 1 for such a line would then form the continuation of some $\mathcal{L}_i : i \neq m$. Thus it can only be a line with a neutral label to $C_{r+1}(\infty)$ concatenated with a vertical line ℓ^* labelled by a $*$.

Recover the notation of the proof of (ii) of Proposition 5.2.2

Suppose that $t - t' > 0$, so the common entry of \mathcal{L}_m goes down by $t + 1 - t' > 1$ rows. Then $\text{ht } C_{r+1} \geq s$ and by 3.2.5 this precludes any vertical lines in the continuation of the $\mathcal{L}_i : i \neq m$ at C_{r+1} . Thus ℓ^* and $\ell_{C,C'}^*$ must have the same upper end points so coincide.

Suppose that $t = t' = s$. Then there is just one vertical line from $R_{s+1} \cap C_{r+1}(\infty)$ and so again ℓ^* and $\ell_{C,C'}^*$ must coincide.

This completes the proof of the proposition. □

5.2.5. *Separation.* Let \mathcal{P} denote the set of pairs of neighbouring columns in \mathcal{D} .

Fix a component tableau \mathcal{T}^c and retain the notation of 5.2.2.

Lemma. *The $\ell_{C,C'}^* : (C, C') \in \mathcal{P}$ are pairwise distinct.*

Proof. Recall Remark 5.2.2 and view $\ell_{C,C'}^*$ as joining entries boxes of the rectangle $R_{C,C'}^s$ viewed as lying in \mathcal{T}^c .

Take $i \in [1, 2]$ and $(C_i, C'_i) \in \mathcal{P}$ of height s_i . If $s_1 = s_2$, the assertion is trivial since $[C_1, C'_1] \cap [C_2, C'_2]$ is at most one column so there are no common lines at all joining boxes in $[C_1, C'_1]$ and joining boxes in $[C_2, C'_2]$.

Thus we can suppose $s_1 > s_2$.

Now view $\ell_{C,C'}^*$ as constructed in Proposition 5.2.2(ii).

Recall (vi) of Proposition 5.2.2 and cases one and two of its conclusion.

In the first case the right hand end-point of ℓ_{C_1, C'_1}^* meets R_{s_1} (in \mathcal{T}), so it cannot equal ℓ_{C_2, C'_2}^* whose right hand end-point lies in R^{s_2} (in \mathcal{T}).

In the second case the composite line in $\mathcal{T}(\infty)$ joining boxes of C_1 to those of C'_1 with constituent ℓ_{C_1, C'_1}^* stays in R^{s_1} with the one exception that it may enter $R_{s_1+1} \cap C_{r+1}(\infty)$ and then re-enter C_{r+1} (necessarily of height $< s$) at its unique lowest element by a vertical line labelled by a $*$. Thus s_1 is determined by ℓ_{C_1, C'_1}^* and so again $\ell_{C_i, C'_i}^* : i = 1, 2$ are distinct. □

Example 16. Consider the composition $(2, 1, 1, 1, 2)$. When 3 is chosen from \mathcal{B}_{C_1, C_5}^2 of Example 15 all the lines in \mathcal{T} labelled by $*$ join boxes in R_1 , so it is not

so obvious that they are distinct, except when one draws the lines! On the other hand in $\mathcal{T}(\infty)$ two of the lines with label $*$ join boxes in distinct columns of height 1 in R^2 (which is the case $s_1 = s_2 = 1$ in the proof) whilst the third meets R_{s+1} in $\mathcal{T}(\infty)$, with s being the common height of the pair C_1, C_5 , namely 2.

5.2.6. *Weierstrass Sections.* It is clear that Proposition 5.2.2 implies Proposition 5.1.1, whilst 5.1.2(*) is just the conclusion of Lemma 5.2.5.

Hence

Theorem. *Let \mathcal{T}^c be a component tableau. Then $e_c + V_c$ is a Weierstrass section. In particular $\dim V_c = g$.*

6. COMPONENTS

Throughout this section fix a component tableau \mathcal{T}^c .

In 4.1.5, we described a subalgebra \mathfrak{u}^c spanned by positive root vectors defined by \mathcal{C} . It is complemented in \mathfrak{m} by a set of positive root vectors whose roots are called the excluded roots X (from \mathfrak{u}^c). Presented in \mathfrak{m} (or in \mathbf{M}) the excluded roots are encircled.

Recall that in 4.3.1 we defined the irreducible closed subvariety $\mathcal{C} = \overline{B \cdot \mathfrak{u}^c}$ of \mathfrak{m} . Our present goal is to show that it is a component of \mathcal{N} . By Corollary 4.6 we already have the inclusion $\mathcal{C} \subset \mathcal{N}$.

6.1. **Using Intersection Theory in Projective Space.** Assume that

$$\dim \mathcal{C} \geq \dim \mathfrak{m} - g. \quad (*)$$

Given a conical affine algebraic variety \mathcal{V} , let $[\mathcal{V}]$ denote its projectivisation, that is to say suppress $0 \in V$ and identify all multiples of a given non-zero vector.

Theorem. *\mathcal{C} is a component of \mathcal{N} of dimension $\dim \mathfrak{m} - g$.*

Proof. We use the argument of [9, 6.9.8] which we sketch for completeness.

Let \mathcal{V}^e denote the set of all non-zero scalar multiples of $e_c + v : v \in V_c \setminus \{0\}$. It is a conical.

Let $\hat{\mathcal{C}}$ be an irreducible component of \mathcal{N} containing \mathcal{C} . As noted [9, 6.9.8] $\hat{\mathcal{C}}$ is conical. By (*), it suffices to show that $\dim \hat{\mathcal{C}} = \dim \mathfrak{m} - g$.

Assume that $\dim \hat{\mathcal{C}} > \dim \mathfrak{m} - g$, so then $\dim[\hat{\mathcal{C}}] > \dim[\mathfrak{m}] - g$.

By Theorem 5.2.6 one has $\dim V_c = g$ and so $\dim[\mathcal{V}^e] = g - 1$.

Then by the intersection theory of closed projective subvarieties in projective space [26, Chap. 1, Section 5, Thm. 6], we conclude that $[\hat{\mathcal{C}}] \cap [\mathcal{V}^e]$ is non-empty. Translated back to affine space this means that $\hat{\mathcal{C}}$ contains an element of the form $e_c + v : v \in V_c \setminus \{0\}$.

Yet $e_C + V_C$ is a Weierstrass section by Theorem 5.2.6, so there exists a Benlolo-Sanderson generator I such that $I(e_C + v)$ is a non-zero scalar. On the other hand $e_C + v \in \hat{\mathcal{C}} \subset \mathcal{N}$ and so $I(e_C + v) = 0$. this contradiction proves the assertion. \square

6.2. Covering. We establish 6.1(*) by adapting the method used in [9, 6.9.6] to all component tableaux.

6.2.1. Excluded Roots not Labelled by a *. Recall 3.2.5, 3.2.6. Recall that X is the set of excluded root vectors. These are encircled.

Let Y (resp. S) be the set of root vectors which carry a * (resp. 1). Recall that $Y \subset X$ by Lemma 4.1.3. Set $Z = X \setminus Y$.

Recall 3.2.6 that these roots are constructed from adjacent columns C_r, C_{r+1} with $\text{ht } C_{r+1} = t$ and an element $i \in R_{t'} \cap C_r(\infty)$ which has been lowered by $m := t + 1 - t' \geq 1$ rows into $R_{t+1} \cap C_{r+1}(\infty)$, illustrated in Figure 1 by a neutral line.

Recall the partial column $C_{r+1}^{>(t-m)}$ and \mathbf{j} its set of entries. Denote \mathbf{j} simply by j if the latter is a singleton. In the latter case j is just the lowest entry of C_{r+1} .

This gives a subset of $Y_{i,\mathbf{j}}$ of roots labelled by a *, joining i to $j \in \mathbf{j}$. (They are described in 3.2.5 and recalled in the proof of the proposition below). In \mathbf{M} the corresponding root vectors appear in the last $m = |\mathbf{j}|$ columns on the right of the column block \mathbf{C}_{r+1} , in its i^{th} row.

The subset $X_{i,\mathbf{j}}$ of excluded roots resulting from $Y_{i,\mathbf{j}}$ (defined in 4.1.4 and recalled briefly below) are called the excluded roots defined by the pair (i, \mathbf{j}) .

6.2.2. Covering. Consider a root vector $x_{i',j'}$. Here we are just concerned with those in \mathbf{m} so we require $i' < j'$ and that i', j' do not lie in the same column of \mathcal{T} .

Given root vectors $x_{i',j'}, x_{k',l'}$ in \mathbf{m} , we say that $x_{i',j'}$ covers $x_{k',l'}$ if $i' = k'$ and $j' < l'$, that is they lie in the same row of \mathbf{M} with the former to the left.

The set of root vectors which cover $Z_{i,\mathbf{j}} := X_{i,\mathbf{j}} \setminus Y_{i,\mathbf{j}}$ is denoted by $S_{i,\mathbf{j}}$. The $Z_{i,\mathbf{j}}$ (resp. $S_{i,\mathbf{j}}$) are not necessarily disjoint for distinct pairs.

6.2.3. Recalling the Construction of $X_{i,\mathbf{j}}, Y_{i,\mathbf{j}}$.

Case 1. Here $m = t + 1 - t' > 1$ and $\text{ht } C_{r+1} = t$. The adjacent pair must be surrounded by m (free) pairs of neighbouring columns of heights $k \in [t', t]$. This gives m vertical lines labelled by a * from $R_{t+1} \cap C_{r+1}(\infty)$ with entry i , to each of the boxes of $C_{r+1}^{>(t-m)}$, that is the $R_{t-k+1} \cap C_{r+1}$, with entry $j_k = j - k + 1 : k \in [1, m]$.

The entries joined by these vertical lines define $Y_{(i,\mathbf{j})}$.

Following this recall 4.1.3 that $C_{r+1}^{>(t-m)}$ is placed below i in the unique column $C_h := C_{(i)}$ in which i appears in \mathcal{T} . Let $R_f := R_{(i)}$ be the unique row in which i appears in \mathcal{T} . Then $\text{ht } C_h \geq f$. If this is a strict inequality the partial column

$C_h^{>f}$ is moved leftwards displacing similar partial columns until the first column C_g of height f is reached, as detailed in 4.1.3.

Case 2. Here $m = 1$ and $\text{ht } C_{r+1} \leq t$. It is brought to height t in $\mathcal{T}(t)$ - see 3.1.1, 3.2.2. The adjacent pair must be surrounded by a (free) pair of neighbouring columns of height t . This gives a vertical line labelled by a $*$ from $R_{t+1} \cap C_{r+1}(\infty)$ with entry i , to the lowest box of C_{r+1} with entry j .

In this case $Y_{i,j}$ is the singleton defined by $\ell_{i,j}$.

Following this, as in case 1, the entry j is placed below i in $C_h := C_{(i)}$ and similarly partial columns are moved leftwards.

6.2.4. *The Covering Proposition-Primary Excluded Roots.*

Recall the notation of 4.1.3. Consider the left movement of partial columns, described in 4.1.3 and referred to in 6.2.3.

Given a column C between C_g and C_h , let $\tilde{C}^{>f}$ be the partial column that replaces $C^{>f}$ in the said leftward movement of partial columns. We call \tilde{C} the displacing column.

Both cases described in 6.2.3 are the same except for the specification of the first displacing column \tilde{C}_h , which in the first case is C_{r+1} . In both cases $x_{k',l'} \in X_{i,j}$ is obtained by taking $l' \in \tilde{C}^{>f}$ and $k' \in [C^{\leq f}, \tilde{C}]$ such that $k' < l'$.

When $C = C_h = C_{(i)}$ (resp. when C lies strictly to the left of $C_{(i)} = C_h$) these roots were referred to 4.1.4 as the primary $Z_{i,j}^P$ (resp. secondary $Z_{i,j}^S$) excluded roots in $Z_{i,j}$.

In the notation of 4.1.4, let $Z^P = \cup_{i,j \in \mathbf{L}} Z_{i,j}^P$ (resp. $Z^S = \cup_{i,j \in \mathbf{L}} Z_{i,j}^S$) denote the subset of Z of primary (resp. secondary) excluded roots.

Proposition. *The roots of S cover Z^P .*

Proof.

It is enough to prove this assertion for each choice of i defining a $Z_{i,j}^P$, in the notation and hypotheses of 6.2.3. Recall (3.2.5) that in this i moves down from $C_r(\infty)$ to $C_{r+1}(\infty)$ by $m \geq 1$ steps. Fix $x_{i',l'} \in Z_{i,j}^P$.

Consider $i \in R_f$, in the notation of 6.2.1. Take $C = C_{(i)} = C_h$. The i -string must descend strictly (see proof of Claim in 4.1.3) and perhaps in several steps to reach $C_{r+1}(\infty)$. Moreover at each downward step it always enters an *empty* box in $[C, \tilde{C}]$ - as specified in 3.2.2.

By Observation 1, 4.1.5, i' (as an element of \mathcal{T}) lies in C strictly above i or lies in a column strictly to the right of C and to the left of $\tilde{C} = C_{r+1}$.

View \mathcal{T} as a sub-tableau of $\mathcal{T}(\infty)$. Then by the two paragraphs above, $i' \in \mathcal{T}$ must be distinct from i and lie strictly above $i \in \mathcal{T}(\infty)$ in the column of $[C_{(i)}, C_{r+1}]$

in which they both appear. Then by Lemma 4.2.1(ii) the i' -string lies strictly above the i -string, in any column of $\mathcal{T}(\infty)$ through which they both pass.

This condition on strings puts i strictly below i' in $C_r(\infty)$. Then if i' is stopped at C_r , there is a line $\ell_{i',j'}$ labelled by a 1 with $j' < l'$ by Corollary 3.2.6(iii). In this case $x_{i',j'} \in S$ and covers $x_{i',l'} \in Z$. If not by Figure 1, 3.2.6, this can only happen if $m = 1$ (with m as defined in the first paragraph of the proof) then $x_{i',j'} \in Y$. \square

6.2.5. *The Covering of Secondary Excluded Roots.* None of the secondary excluded roots lie in Y , so the argument is less convoluted. Again we need only consider the covering of some $Z_{i,j}^S$, and we drop the subscript.

For a secondary excluded root $x_{k',l'}$ the displacing column \tilde{C} is the rightmost column in C_g, C_h of height $> f$. Thus $l' \in \tilde{C}^{>f}$, and $k' \in [C, \tilde{C}]$, with of course $k' < l'$.

Recall the notation of 4.1.3. Recall that a subset Z^S of secondary excluded roots occur when partial columns are displaced to the left starting from $C_{(i)}$ and ending in the left hand column C_g of a pair of columns C_g, C'_g of height f surrounding $C_{(i)}$. In this ht $C_{(i)} \geq f$ and moreover a strict inequality is needed otherwise Z^S is empty.

Recall that in the notation of 4.1.3 the co-ordinates of the secondary excluded roots lie in $[C_{g_{k-1}}, C_{g_k}] : k \in [1, s]$ with $g_0 = g$. Moreover the columns in $]C_{g_{k-1}}, C_{g_k}[$ all have height $< f$, by choice of notation.

6.2.6. *A Key Lemma.* In above fix $i \in [1, s]$ and set $C_{k_1} = C_{g_{i-1}}, C_{k_2} = C_{g_i}$. They are columns of height $\geq f$ with at most C_{g_0} of height s . Strictly between them there are only columns of height $< f$.

Here the entries of the $C_l : l \in [k_1, k_2]$ are those given by the numbering of \mathcal{T} and the lines between boxes in $[C_{k_1}, C_{k_2}]$ are those coming from the given component tableau $\mathcal{T}^{\mathcal{C}}$ chosen.

Observe that

(*). A neutral line from $R_{t_1} : t_1 \leq f$ to $R_{t_2} : t_2 > f$ must have at least one entry outside $[C_{k_1}, C_{k_2}]$. In other words a neutral line cannot penetrate R_s in $[C_{k_1}, C_{k_2}]$.

This is because the pair of neighbouring columns C_g, C'_g of height f is used to lower $i \in C_{(i)} = C_{g_s}$ strictly below R_f , as noted in the paragraph following the claim in 4.1.3 and so is not free to be used to allow a neutral line to penetrate R_s in $[C_{k_1}, C_{k_2}]$.

Lemma. *There is a disjoint union of special composite lines going through all the boxes of $R^s \cap [C_{k_1}, C_{k_2}]$ in $\mathcal{T}(\infty)$.*

Proof. The proof is similar to that of Proposition 5.2.2(i).

For all $t \in [1, s], l \in [k_1, k_2 - 1]$, the unique u -string in $\mathcal{T}(\infty)$ defined by the entry of $R_t \cap C_l(\infty)$, either enters $R^s \cap C_{l+1}(\infty)$, or is stopped at C_l defining a unique line with label 1 to $R^s \cap C_{l+1}$ having right end-point u' . Indeed the third possibility arising in Proposition 5.2.2(i) of a neutral line penetrating R_s in $[C_{k_1}, C_{k_2}]$ is excluded by (*).

As in Proposition 5.2.2, the existence and uniqueness of the evolution of the special composite lines starting from boxes in $R^f \cap C_{k_1}$ and ending in $R^f \cap C_{k_2}$, proves the lemma. □

6.2.7. The Covering Roots. For all $k \in [1, s]$, let $Z^S(k)$ denote the subset Z^S coming from the pair $C_{g_{k-1}}, C_{g_k}$. By 4.1.4, Observation 3, the first co-ordinate k' of $x_{k',l'}$ lies in $R^f \cap [C_{g_{k-1}}^{\leq f}, C_{g_k}]$.

Let $S(k)$ be the subset of S obtained by collapsing the disjoint composite lines of Lemma 6.2.6.

Lemma. *The elements of S cover those of Z^S .*

Proof. It is enough to show that the elements of $S(k)$ cover those of $Z^S(k)$ for all $k \in [1, s]$. Through Lemma 6.2.6 we conclude that to a box in $R^f \cap [C_{g_{k-1}}, C_{g_k}]$, with label i' there exists a strictly right going line $\ell_{i',j'} \in S'_k$ with label 1 to a box in $R^f \cap [C_{g_{k-1}}, C_{g_k}]$ with label j' , with necessarily $j' > i'$.

On the other hand the elements of $Z^S(k)$ take the form $\ell_{k',l'}$ with first co-ordinate in $[C_{g_{k-1}}, C_{g_k}] \cap R^f$ and second co-ordinate in $C_{g_k}^{>f}$. Thus $l' > j'$, with l' defined in the first paragraph. Since i' in the first paragraph is an arbitrary element of $[C_{g_{k-1}}, C_{g_k}] \cap R^f$ we can take $i' = k'$ and then $x_{i',j'} \in S'_k$ covers $x_{k',l'} \in Z'_k$, as required. □

6.3. Tangent Spaces. We now generalize the claim in [9, 6.9.7] to any component tableau \mathcal{T}^c , to obtain a proof of 6.1(*).

Let $\mathbf{S}, \mathbf{X}, \mathbf{Y}, \mathbf{Z}$ be the linear span of the $x_{k,l} \in S, X, Y, Z$, respectively. Then by definition of \mathbf{u}, e_C and the latter subspaces we have

$$e_C = \sum_{\alpha \in S} x_\alpha \in \mathbf{u}, \quad \mathbf{m} = \mathbf{u} \oplus \mathbf{X}, \quad \mathbf{X} = \mathbf{Z} \oplus \mathbf{Y}. \quad (1)$$

In addition $V_C = \mathbf{Y}$. Then by Theorem 5.2.6, $e_C + V_C$ is a Weierstrass section in \mathbf{m} . In particular $\dim \mathbf{Y}$ equals the number \mathbf{g} of Benlolo-Sanderson generators of the polynomial ring $\mathbb{C}[\mathbf{m}]^{P'}$.

Proposition.

(i). $(\mathbf{u} + \mathbf{n}.e) + \mathbf{Y} = \mathbf{m}$.

(ii). $\mathfrak{n}.e \cap \mathbf{Y} = \{0\}$.

(iii). $\dim B.\mathbf{u} = \dim(\mathbf{u} + \mathfrak{n}.e) = \dim \mathfrak{m} - \mathbf{g}$.

(iv). $(\mathbf{u} + \mathfrak{n}.e) \oplus \mathbf{Y} = \mathfrak{m}$.

(v). $\mathcal{C} = \overline{B.\mathbf{u}}$ is an irreducible component of \mathcal{N} .

Proof. (i). Take $(k, l) \in Z$. By the Proposition 6.2.4 there exists $(i, j) \in S$ with $i = k, j < l$. Moreover by Corollary 3.2.6(ii) this element of S is uniquely determined by i . Again since $j < l$ one has $x_{j,l} \in \mathfrak{n}$. Then $x_{i,l} \in \mathfrak{n}.x_{i,j}$.

Just as in [9, 6.9.7] this is not quite the end of the story. Indeed there can be a second pair $(l, m) \in S$, which if it exists is uniquely determined by l . Then $[x_{j,l}, x_{l,m}] = x_{j,m}$, whilst the asserted uniqueness gives

$$x_{j,l}.e = x_{j,m} - x_{i,l}. \quad (2)$$

Moreover generally for *any* root vector $x \in \mathfrak{n}$ the expression $x.e$ is at most the sum of two root vectors¹².

In the above we note that $l < m$, so in \mathbf{M} and the two terms in the right hand side of (2) must belong to distinct column blocks of \mathbf{M} with the first term in a column block strictly to the right of that containing the second term. In particular if the first term lies in the last column block, then the second term does not appear.

Now $\mathbf{u}, \mathbf{Y}, \mathfrak{m}$ are all direct sums of their respective intersections with the column blocks, it follows from (1) that the left hand side of (1) contains the entire last column block of \mathbf{M} .

Then correspondingly (i) obtains by right to left induction on column blocks.

(ii) is essentially [9, Lemma 3.1(ii)] but due to its possible interest we give a more detailed proof.

First given a finite dimensional vector space \mathfrak{m} and c an indeterminate, use $O(c^2)$ to denote a sum of terms which multiply $c^m : m \geq 2$.

Now take $p \in \mathbb{C}[\mathfrak{m}]$, that is to say a polynomial function on \mathfrak{m} , which more particularly is a sum of terms of positive degree. Then given $e, v \in \mathfrak{m}$, one has

$$p(e + cv + O(c^2)) = p(e + cv) + O(c^2). \quad (3)$$

It is enough to prove (3) with p homogeneous of degree $m \geq 1$, that is a product of m linear functions $f_i : i \in [1, m]$. Then the left hand side above equals $\prod_{i=1}^m f_i(e + cv) + O(c^2) = p(e + cv) + O(c^2)$. Hence (3).

Now recall that \mathfrak{n} acts locally nilpotently on \mathfrak{m} , so $(\exp cx)e$ is a polynomial in c with coefficients in \mathfrak{m} .

¹²Indeed this is an advantage of using e whilst for a generic element $\tilde{e} \in \mathbf{u}$, there are many terms in $\mathfrak{n}.\tilde{e}$.

Now take $e = e_c, V = V_c$. Suppose (ii) fails. Then there exists $x \in \mathfrak{n}$ such that $x.e := v \in V \setminus \{0\}$. Choose a linear function ξ on V such that $\xi(v) \neq 0$. By definition of a Weierstrass section, there exists a sum of Benlolo-Sanderson invariants p (hence a polynomial p which is a sum of terms of positive degree) such that $p(e + cv) = c\xi(v) \neq 0$ for all $c \neq 0$.

The invariance of p implies that $p(\exp(cx).e) = p(e) = 0$. Yet the left hand side equals $p(e + cx.e + O(c^2)) = c\xi(v) + O(c^2)$. The latter has derivative at $c = 0$ equal to $\xi(v) \neq 0$ contradicting the previous assertion. Hence (ii).

Let N be the closed irreducible subgroup of B with Lie algebra \mathfrak{n} . One has $B = NH$ and since \mathfrak{u} is H stable we obtain $B.\mathfrak{u} = N.\mathfrak{u}$.

Take a (generic) point $\tilde{e} \in \mathfrak{u}$. The action $N.\mathfrak{u}$ of N on \mathfrak{u} augments its dimension by the dimension of the tangent space through \tilde{e} modulo \mathfrak{u} , in brief from $\dim \mathfrak{u}$ to $\dim(\mathfrak{u} + \mathfrak{n}.\tilde{e})$. Just taking $\tilde{e} = e$ the latter dimension is already $\geq \dim \mathfrak{m} - \dim \mathbf{Y} = \dim \mathfrak{m} - \mathfrak{g}$, by (i).

Thus $\dim B.\mathfrak{u} \geq \dim \mathfrak{u} + \mathfrak{n}.e \geq \dim \mathfrak{m} - \mathfrak{g}$ and so by Theorem 6.1 equality holds throughout. Hence (iii).

(iv) follows from (iii) and (i). (v) follows from (iii) and Theorem 6.1. \square

Remark. it is possible to show *combinatorially* that (ii) implies (iii). However perhaps the reader prefers our present use of intersection theory in projective space, which besides also shows (Theorem 6.1 and Proposition 6.3) that \mathcal{C} is a component of \mathcal{N} .

6.4. The Component Map. By Proposition 6.3 there is map $\mathcal{T}^c \mapsto \mathcal{C}$ of the set of component tableaux to the set of irreducible components of \mathcal{N} . We call it the component map.

7. INJECTIVITY OF THE COMPONENT MAP

Fix a composition hence a tableau \mathcal{T} , and a pair of *distinct* component tableaux $\mathcal{T}^c, \mathcal{T}^{c'}$ associated to this composition.

7.1. Choices in Batches. Recall the notion of a batch 3.1.4, and the notation given there.

Lemma. *There exists s minimal and then u minimal with the following property. There exist $i, i' \in \mathcal{B}_u^s$ distinct with $i \in \mathcal{B}_u^s$ (resp. $i' \in \mathcal{B}_u^s$) defining the construction of \mathcal{T}^c (resp. $\mathcal{T}^{c'}$).*

Proof. Since entries in batches are determined with s increasing and that the order of appearance in a given $\mathcal{B}_u^s : u \in [1, r_{s-1}]$ is immaterial, it would otherwise be true that $\mathcal{T}^c = \mathcal{T}^{c'}$. \square

7.2. An Exchange Lemma. Let C, C' be the neighbouring columns of height s defining \mathcal{B}_u^s and set $I = I_{C, C'}^s$.

Then the rectangle $R_{C, C'}^s$ admits $i := i_{C, C'}^{\mathcal{C}}$ (resp. $i' := i_{C, C'}^{\mathcal{C}'}$) as the penetrating i -string (resp. i' -string) for \mathcal{C} (resp. \mathcal{C}').

Lemma. *There is a line ℓ in $\mathcal{T}^{\mathcal{C}}$ labelled by a $*$, which in $\mathcal{T}^{\mathcal{C}'}$ is labelled by a 1 and vice-versa.*

Proof. By interchanging labels on tableaux, we can assume, so by convention, that $i' > i$.

Since $i \in \mathcal{B}_u^s$ arises for $\mathcal{T}^{\mathcal{C}}$, there exists $r \in [1, k]$ so that by Rule (1) of 3.2.2 applied to $\mathcal{T}^{\mathcal{C}}(\infty)$, i goes from $R_m \cap C_r(\infty)$ down by $m' \geq 1$ rows into $R_{m+m'} \cap C_{r+1}(\infty)$, by a neutral line and then by possibly by several lines labelled by a $*$ each to a different entry of C_{r+1} .

This means in particular that $\text{ht } C_{r+1} = m + m' - 1$. Thus by Rule (2) of 3.2.2 applied to $\mathcal{T}^{\mathcal{C}'}(\infty)$, the entry i is stopped at C_r , giving a line ℓ with label 1.

We claim that the entry of right end point one of the of the lines, say ℓ' , with label $*$ in $\mathcal{T}^{\mathcal{C}}(\infty)$ can be chosen to be the same as the right end point of the line ℓ with label 1 in $\mathcal{T}^{\mathcal{C}'}(\infty)$.

The assertion is trivial if $m' = 1$ because both lines necessarily go to the unique lowest entry of C_{r+1} .

Otherwise take $m = m_1 + 1, m' = m_2$ following assiduously Figure 1. The line ℓ with label 1 in $\mathcal{T}^{\mathcal{C}'}(\infty)$ is horizontal and has right end-point in $R_{m_1+1} \cap C_{r+1}$, whilst in $\mathcal{T}^{\mathcal{C}}(\infty)$ there is a unique (vertical) line with label $*$ to $R_{m_1+1} \cap C_{r+1}$. This gives the required assertion.

Yet this is not quite the end of the story. Indeed the proof makes a choice of component tableau being defined by the choice of $i \in \mathcal{B}_u^m$.

Yet the argument of the first part equally well applies to the second part when $i' > i$, the only difference is that i' goes down by ≥ 1 rows from $C_{r'}(\infty)$ into $C_{r'+1}(\infty)$ with $r' > r$.

□

Example 17. Consider the composition $(2, 1, 1, 2)$. This admits two component tableaux. In both cases 3 enters $\mathcal{T}(\infty)$ below 4. Then the batch \mathcal{B}_{C_1, C_4}^2 has two elements $\{2, 3\}$. Let \mathcal{C}' (resp. \mathcal{C}) be that in which $i' = 3$ is chosen (and placed below 6) (resp. $i = 2$) is chosen and placed below 3 in C_3 . Then in $\mathcal{T}^{\mathcal{C}'}$ (resp. $\mathcal{T}^{\mathcal{C}}$) the line $\ell_{2,4}$ has label 1 (resp. $*$) and comes from the first part of the proof, whilst for $\ell_{3,6}$, the labelling is reversed, as comes from the second part of the proof. Further examples arises from Figures 18-20 where the two root vectors l, l' have been marked in red assuming the printer courteous enough to provide colour! Colour in Figure 1 is not so vital since the different lines are otherwise identified (see Caption to Figure

1). The colour scheme in the remaining figures, indicate repeated entries according to the rules of 3.2.2, is more aesthetic than essential.

7.3. The Rightmost Line. The lines $\ell := \ell_{i,j}, \ell' := \ell_{i',j'}$ in the conclusion of the exchange lemma are to be denoted (as usual) by the entries they join. Notice that in this $i \in C_r(\infty), i' \in C_{r'}(\infty)$ whilst $j \in C_{r+1}, j' \in C_{r'+1}$. In particular the right end point of ℓ' lies strictly to the right of that of ℓ . We call the former the rightmost line (for the given pair of component tableaux). In Example 17 above $r = 2, r' = 3$.

N.B. By our convention above, the rightmost line will be labelled by a 1 in \mathcal{T}^c .

Let x_ℓ (resp. $x_{\ell'}$) be the co-ordinate vector in \mathbf{M} defined by ℓ (resp. ℓ').

Let $X(i_{C,C'}^c)$, be the set of excluded roots vectors constructed as in 4.1.4 *but only* through the lines with label $*$ defined by the steps in the penetrating $i = i_{C,C'}^c$ -string (recall 4.3.5) until just after this i -string leaves the rectangle $R_{C,C'}^s$, at which point we say *by convention* that the i -string is halted, though it may continue! (see Example 19).

Notice that $X(i_{C,C'}^c) \subset X$. This inclusion may be strict and is key in proving the lemma below, through the following observation.

(*). The second co-ordinate l of the root vector $x_{k,l} \in X(i_{C,C'}^c)$ lies to the left of C_{r+1} (but not necessarily strictly).

Definition. Let $\mathbf{u}_{C,C'}^c$ be the complement in \mathbf{m} of the space spanned by the set $X(i_{C,C'}^c)$.

One has $\mathbf{u}^c \subset \mathbf{u}_{C,C'}^c$, because the right hand side has less excluded vectors. By Proposition 4.4 we have $I(\mathbf{u}_{C,C'}^c) = 0$. (A key fact in what follows!)

Recall that $x_{\ell'} = x_{i',j'}$.

Lemma. $Bx_{\ell'} \subset \mathbf{u}_{C,C'}^c$.

Proof. Let \mathbf{Q} be the set of co-ordinate vectors in the upper right-hand quadrant of \mathbf{M} with lower left hand corner at $x_{\ell'} = x_{i',j'}$. Obviously $Bx_{\ell'}$ is contained in the linear span of \mathbf{Q} (but note the former is *not itself* a vector subspace).

Thus we must show that no root vector $x \in \mathbf{Q}$ lies in $X(i_{C,C'}^c)$.

(**). One has $j' \in C_{r'+1}$ which lies strictly to the right of C_{r+1} .

One has $x_{i',j'} \in \mathbf{Q}$, but since it is labelled by a 1 in \mathcal{T}^c so is not an excluded vector (Prop. 4.2.5) and in particular does not lie in $X(i_{C,C'}^c)$.

Take $x_{k,l} \in \mathbf{Q}$.

Suppose $k \leq i', l > j'$. Then $x_{k,l} \notin X(i_{C,C'}^{\mathcal{C}})$, since by (**) this would force a line labelled by a $*$ coming from the penetrating i -string to have its second co-ordinate l lying to the right of $C_{r'+1}$, so strictly to right of C_{r+1} . This is excluded by (*). It is illustrated in Example 19, Figure 14.

Suppose $k < i', l = j'$. Then $x_{k,l} \notin X(i_{C,C'}^{\mathcal{C}})$, as this would have to be created by partial columns shifted to the left starting from a partial column to the right of $C_{r'+1}$ itself lying strictly to the right of C_{r+1} . This is again excluded by (**). It is illustrated in Examples 18, 20, Figures 13, 15. The latter is slightly sharper since the shifting starts already at $C_{r'+1}$, whereas in the former it starts at $C_{r'+2}$. □

7.4. Partial Linearity for the Rightmost Line. Recall the notation of 7.2.

Corollary. $I(x_{\ell'} + \overline{B.u^{\mathcal{C}}}) = 0$.

Proof. Since $x_{\ell'}$ is a point and I is a regular function, we can remove closure in the statement of the lemma. Consider $x_{\ell'} + b.u'$ with $b \in B.u' \in \mathbf{u}^{\mathcal{C}}$. Since $b^{-1}x_{\ell'} = u'' \in \mathbf{u}_{C,C'}^{\mathcal{C}}$, by Lemma 7.3, we obtain $x_{\ell'} + u' = b(b^{-1}x_{\ell'} + u') = b(u'' + u') \in B.u_{C,C'}^{\mathcal{C}}$, by the linearity of $\mathbf{u}_{C,C'}^{\mathcal{C}}$. Then $I(x_{\ell'} + B.u^{\mathcal{C}}) \subset I(B.u_{C,C'}^{\mathcal{C}}) = 0$, by Theorem 4.4. □

Remark. Even under the hypothesis of the lemma, it can be false that $B.x_{\ell'} \subset \mathbf{u}^{\mathcal{C}}$. Thus we may need to restrict co-ordinates following I . For this see Examples 18–20.

7.5. Injectivity. Retain the notation of 7.2. Let $\mathcal{C}, \mathcal{C}'$ be distinct numerical data associated to a fixed composition.

Proposition. *Let $\mathcal{C}, \mathcal{C}'$ be distinct numerical data associated to a fixed composition. Then $\overline{B.u^{\mathcal{C}}} \neq \overline{B.u^{\mathcal{C}'}}$.*

Proof. Define $\ell_{C,C'}^*$, introduced in Proposition 5.1.1(ii).

We claim that $\ell' = \ell_{C,C'}^*$. The choice of $\ell_{C,C'}^*$ is made in Proposition 5.2.2(ii). Here its left end-point is $i = i_{C,C'}^{\mathcal{C}}$. If **Case two** of the proof applies its right end-point is uniquely determined making the claim trivial. Suppose **Case one** holds, then its right-end point is uniquely determined by the condition that its right end point lies in R_s . Since its left end-point $i \in \mathcal{B}_{C,C'}^s \subset R_s$. This forces it to coincide with the horizontal line ℓ labelled by a 1 in $\mathcal{T}^{\mathcal{C}'}$ and hence with ℓ' labelled by a $*$ in $\mathcal{T}^{\mathcal{C}}$.

By definition of a Weierstrass section, this means that the restriction of $I = I_{C,C'}^s$ to $e_{\mathcal{C}'} + V_{\mathcal{C}'}$ is just the linear function on the root vector labelled by a $*$, namely $x_{\ell'}$,

Thus $I(e_{\mathcal{C}'} + x_{\ell'}) \neq 0$, so a fortiori $I(\overline{B.u^{\mathcal{C}'}} + x_{\ell'}) \neq 0$.

Suppose that $\overline{B.u^{\mathcal{C}}} = \overline{B.u^{\mathcal{C}'}}$. Then $I(\overline{B.u^{\mathcal{C}}} + x_{\ell'}) \neq 0$. This contradicts the conclusion of Corollary 7.4, so proving the required assertion. □

Example 18. Consider composition $(3, 2, 1, 3, 2, 1)$. For \mathcal{C} put 5 below 9 which describes the penetrating i string for the rectangle $R_{\mathcal{C}, \mathcal{C}'}$, $C = C_1, C' = C_4$. It is halted at C_4 . (Notice it does not include putting 10 down below 12, which make $x_{7,11}$ a secondary excluded root vector.) For \mathcal{C}' put 8 below 11. The pair $\mathcal{C}', \mathcal{C}$ makes $\ell_{8,11}$ the rightmost line. Now, by the observation in parentheses $x_{7,11}$ lies in $\mathbf{u}_{\mathcal{C}, \mathcal{C}'}$, but not in $\mathbf{u}^{\mathcal{C}'}$. Thus we still have $B.x_{8,11} \in \mathbf{u}_{\mathcal{C}, \mathcal{C}'}$. Here $r = 3, r' = 4$.

Example 19. Consider composition $(3, 2, 1, 2, 2, 1, 3)$. For \mathcal{C} put 7 down below 10 which describes the penetrating i string for the rectangle $R_{\mathcal{C}, \mathcal{C}'}$, where $C = C_4, C' = C_5$. It is halted at C_5 . Now for \mathcal{C}' put 9 below 11 and 8 below 10. The pair $\mathcal{C}', \mathcal{C}$ makes $\ell_{9,11}$ the rightmost line.

Yet the i -string in $\mathcal{F}^{\mathcal{C}'}$ may be continued by putting 7 into C_7 below 14. This makes $x_{9,14}$ a primary excluded root vector. This means that $x_{9,14}$ lies in $\mathbf{u}_{\mathcal{C}, \mathcal{C}'}$ but not in $\mathbf{u}^{\mathcal{C}'}$. Thus we still have $B.x_{9,11} \in \mathbf{u}_{\mathcal{C}, \mathcal{C}'}$. Here $r = 4, r' = 5$.

Example 20. Consider the composition $(3, 2, 1, 3, 1, 2)$. For \mathcal{C} put 5 below 9 which describes the penetrating i -string for the rectangle $R_{\mathcal{C}, \mathcal{C}'}$, where $C = C_2, C' = C_6$, which is halted at C_4 . (This does not include putting 7 below 10 which makes $x_{7,10}$ a primary excluded root vector.) For \mathcal{C}' put 7 below 10, 8 below the new appearance of 7 and 3 below 9. Then the pair $\mathcal{C}', \mathcal{C}$ makes $\ell_{8,10}$ the rightmost line.

This means that $x_{7,10}$ lies in $\mathbf{u}_{\mathcal{C}, \mathcal{C}'}$, but not in $\mathbf{u}^{\mathcal{C}'}$. Thus we still have $B.x_{8,11} \in \mathbf{u}_{\mathcal{C}, \mathcal{C}'}$. Here $r = 3, r' = 4$.

8. TOWARDS SURJECTIVITY

8.1. Surjectivity for Partitions. Our most general result for surjectivity of the component map is when (c_1, c_2, \dots, c_k) is a partition of n . Ironically it is rather boring and indeed paradoxical. Indeed to paraphrase Hilbert, every schoolboy in Cambridge (England!) knows the number of compositions of n to be 2^{n-1} , whilst only the combined genius of Hardy and Ramanujan (working together at Trinity College, Cambridge during the Great War) could give a formula for the number of partitions of n and even that was only asymptotic. Of course the number of partitions of n is just the number of symmetric groups S_n orbits in the set of compositions of n . On the other hand S_n also permutes the weights of the generators of the “semi-invariant” algebra $I = \mathbb{C}[\mathbf{m}]^{P'}$, [8, Prop. 3.4.8, Lemma 4.5]. Yet we hope we have convinced the reader that describing the components of the zero locus \mathcal{N} of I_+ is a hard problem, whilst by contrast we have

Lemma. *For a partition of n , the nilcone \mathcal{N} is irreducible.*

Proof. In the case of a partition, neighbouring columns are adjacent. Thus the Benlolo-Sanderson invariant generators are polynomials in the co-ordinates described by lines joining a pair of adjacent columns and are therefore pairwise distinct for the different pairs. Since every generator is itself an irreducible polynomial [8, Cor, 5.3], it follows that the quotient algebra $Q := \mathbb{C}[\mathfrak{m}]/I_+$ is a tensor product of (finitely generated) commutative domains. This does not quite say that Q is a domain (it could admit nilpotent elements) but it does say that \mathcal{N} is a finite Cartesian product of irreducible closed affine varieties and hence is irreducible [26, Thm. 3, p.35]. \square

8.2. Surjectivity in the Presence of Linear Generators.

Our second less general but more telling result is when I admits “enough” linear generators. This allows “factorisation” by which the components of \mathcal{N} are clearly seen.

Examples comes from the composition $(2, 1^k, 2)$ for $k \geq 2$. All cases are similar but the case $k = 3$ is already interesting. In general there are $k - 1$ linear generators and a generator of degree $2 + k$ which factorises modulo the linear generators as a product of two 2×2 minors (having degree 2 and $k - 2$ further linear factors, whose zero loci give $k - 1$ irreducible components. On the other hand \mathcal{B}_1^2 has cardinality $k = 1$ leading to $k - 1$ component tableaux. Then injectivity implies surjectivity. Even without banal counting one easily links up a componet given by factorisation with a component tableau.

The composition $(2, 1, 1, 1, 2)$ exhibits a further surprising feature. In this case $\mathcal{B}_1^2 = \{2, 3, 4\}$, giving components labelled by 2, 3, 4. (See Example 15). The component labelled by 3, say \mathcal{T}^3 , has an extra linear generator namely $x_{3,5}$. It is the commutator $[x_{3,4}, x_{4,5}]$. Thus \mathfrak{u}^3 is complemented by a (Lie) subalgebra and so the component it defines is an orbital variety closure.

Yet this is false for the other two components! These are interchanged by a Dynkin diagram involution, so it suffices to consider just one.

The image of the (canonical) component tableau \mathcal{T}^4 under the component map is $\mathcal{V} := \overline{B \cdot \mathfrak{u}^4}$. By [9, Lemma 6.9.9] it is enough to show that $\frac{1}{2} \dim G \cdot \mathcal{V} > \dim \mathcal{V}$.

Now the right hand term has dimension $\dim \mathfrak{m} - \mathfrak{g} = \dim \mathfrak{n} - 5$, by Theorems 6.3, 6.1.

On the other hand $G \cdot e_4 \subset G \cdot \mathcal{V}$. Here the lines with label by 1 defining e_4 form monomial chains $(1, 3, 5, 6), (2, 4), 7$. It follows that the nilpotency class of e_4 is $(4, 2, 1)$ whose conjugate partition is $(3, 2, 1, 1)$. Thus $\dim G \cdot \mathcal{V} \geq \dim G \cdot e = 2 \dim \mathfrak{n} - 3.2 - 2.1 = 2(\dim \mathfrak{n} - 4)$, which by the previous paragraph results in the required strict inequality.

By contrast the nilpotency class of e_3 is $(3, 2, 2)$ giving $\dim G \cdot e_3 = \dim \mathcal{N} - 3.2 - 3.2 = 2(\dim \mathfrak{n} - 6)$. All this means is that $P \cdot e_3$ is not dense in $\overline{B \cdot \mathfrak{u}^3}$. This does not mean that we have found a component with no dense P orbit, since $P \cdot (e_3 + x_{3,6})$

is a dense P orbit in $\overline{B.u^3}$. Matters of this nature were studied in [9, 6.10] for the canonical component. We have not extended this theory to all components.

8.3. Further Factorisation via Linear Generators.

Example 21. Consider the composition $(3, 2, 1, 1, 1, 2, 3)$. In this case there are 6 component tableaux. First we lower 6 (resp. 7) below 7 (resp. 8). Then $\mathcal{B}_{2,6}^2 = i : i = 5, 6, 7$. When i is lowered into R_3 we obtain $\mathcal{B}_{3,i}^3$. Then 3 or i can be lowered into R_4 giving $3 \times 2 = 6$ tableaux.

When $i = 6$, each entry of an entire upper part of the 3×3 minor is filled by a $*$. Modulo the generators $x_{6,7}, x_{7,8}, x_{6,8}$, we now have three 3×3 Levi blocks. It follows from [9, Lemma 1.10] that the invariant $I_{1,7}^3$, which has degree 10 by 4.3.3, is a product of two polynomials of degree 5 which by [8, Cor. 5.3] are both irreducible. This describes the components coming from the two tableaux above when $i = 6$.

The cases $i = 5, 7$ are equivalent under a Dynkin diagram involution. Consider just the first. Modulo the invariant $x_{5,7}$ we are reduced to the composition $(3, 2, 2, 1, 2, 3)$ which we want to show yields just two components corresponding to placing 5 below 7. This is no longer possible through factorisation. However it is reasonable to believe the following

Hypothesis. Given a composition with only one entry being 1, then decreasing each entry by one does not change the number of components of \mathcal{N} .

Quite trivially the above operation does not change the number of component tableaux.

Admitting the above hypothesis reduces us to the familiar territory described in 8.2. Keeping the numbering of columns and of boxes, we obtain $\mathcal{B}_{1,7}^3 = 3, 5$ giving two tableaux lowering 3 or 5 below 13. Moreover from the factorisation arising from the three 2×2 Levi blocks, there are no more components.

Thus we obtain surjectivity of the component map for the composition $(3, 2, 1, 1, 1, 2, 3)$ if we admit the above hypothesis.

9. INDEX OF NOTATION AND OF NOTIONS

Notation and notions frequently used are given below in the section where they are first defined and sometimes also first mentioned.

Notations

1. $\mathbb{C}, [m, n],]m, n[, [m, n[,]m, n[.$
- 1.1. $\mathcal{N}.$
- 1.3. $G, \mathfrak{p}.$

- 1.4. $B, \mathbf{n}, \mathbf{b}, P, \mathbf{m}, \mathbf{p}, H, \mathbf{h}, W, P'$.
- 2.1.1. $\mathcal{D}, C_i, c_i, R_i, R^i, b_{i,j}$.
- 2.1.2. C_i^s .
- 2.1.3. $[C, C'], [C, C'[,]C, C'],]C, C'[,$
- 2.1.4. $R_{C,C'}^s$.
- 2.2.1. $\mathbf{M}, \mathbf{r}, \mathbf{B}_i, \mathbf{C}_i, x_{i,j}$.
- 2.2.2. $\mathcal{I}, C_{(i)}, R_{(i)}$.
- 2.3.1. \mathbf{M}_s^* .
- 2.3.2. $d_{\mathcal{D}}^{R^s, C'}, d_{\mathcal{D}}^{R^s, C'}$.
- 2.3.3. $\mathbf{m}^-, x_{i,j}^*$.
- 2.3.5. Id_s .
- 3.1.1. $\mathcal{I}(t), \mathcal{I}(\infty), \mathcal{I}(t, \ell), C(t), C(\infty), C(t, \ell)$.
- 3.1.4. $\mathcal{I}^{\mathcal{C}}(\infty) \mathcal{B}_{C,C'}^t, \mathcal{B}^s$.
- 3.2.4. $\ell_{i',j'}, \alpha_{i',j'}$.
- 3.2.6. $C^{\leq p}, C^{> p}$.
- 3.2.7. $\mathcal{I}^{\mathcal{C}}, \mathcal{I}^{i,j,\dots}$.
- 4.1.3. $C_g, C'_g, \mathcal{I}_{i,j}, \mathcal{I}_{i,j}$.
- 4.1.4. $w_{\mathcal{I}}, w_{i,j}, \mathbf{u}_{i,j}, \mathbf{l}^+$.
- 4.1.5. $\mathbf{u}^{\mathcal{C}}, X, \mathbf{X}$.
- 4.2.1. $S(s)$.
- 4.3.1. \mathcal{C}, \mathbf{g} .
- 4.3.5. $i_{C,C'}^{\mathcal{C}}$.
- 4.9. \mathbf{M}_s .
- 5.1. e_C, V_C .
- 5.1.1. $\ell_{C,C'}^*$.
- 5.2.2. \mathcal{L}_i .
- 6.2.1. $Y, S, Z, Y_{i,j}, X_{i,j}$.
- 6.2.2. $Y_{i,j}, X_{i,j}$.
- 6.3. $\mathbf{S}, \mathbf{X}, \mathbf{Y}, \mathbf{Z}$.

Notions.

- 1.2. Weierstrass Section.
- 1.5. Composition Tableau.
- 1.7. Component Tableau.
- 1.8. Orbital Variety.
- 1.9. Hypersurface Orbital Variety.
- 2.1.2. Adjacent and Neighbouring Columns.

- 2.1.4. Rectangles.
- 2.2.2. Tableau.
- 2.3. Benlolo-Sanderson invariants.
- 2.3.4. Quantization, Unitarizable Highest Weight Modules.
- 3. Component Tableau.
- 3.1.2. The Vav Conversive.
- 3.1.3. Surrounding Columns.
- 3.1.4. Batches.
- 3.2.5. Lines with label $*$.
- 3.2.6. Lines with label 1, lines with a neutral label.
- 4. Excluded Roots.
- 4.1.3. Primary and Secondary shifting of roots.
- 4.1.4. Primary and Secondary excluded roots.
- 4.1.5. Encircling.
- 4.2.1. An s -string.
- 4.2.2. Starting Places.
- 4.2.3. Primary Excluded Roots.
- 4.2.4. Secondary Excluded Roots.
- 4.3.5. The i - string of penetration.
- 5. Weierstrass Sections.
- 5.1.1. Composite lines.
- 5.2. Collapsing.
- 5.2.1. Special Composite Lines.
- 6.4. The Component Map.
- 7.1. The Exchange Lemma.
- 7.3. The Rightmost Line.

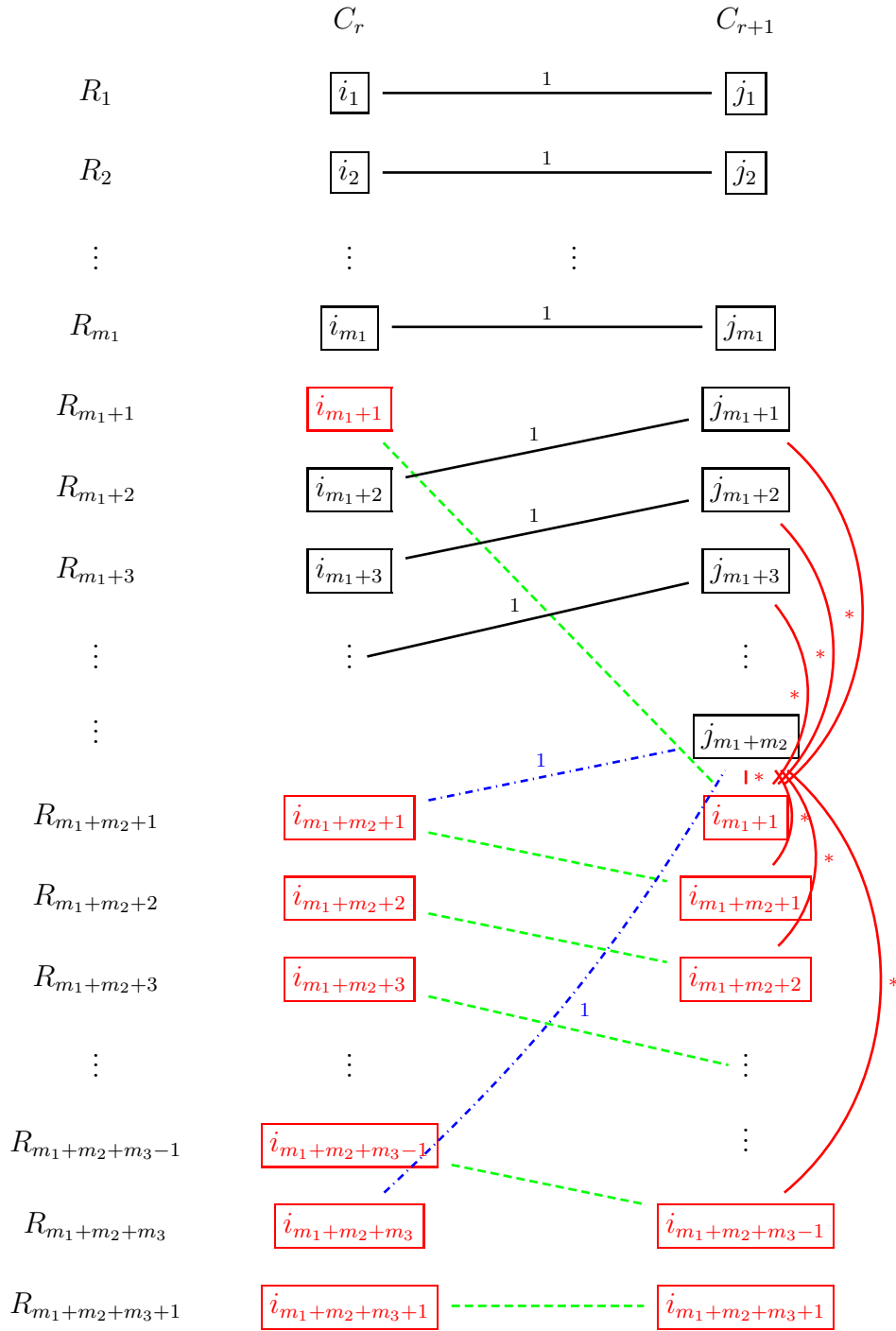

FIGURE 1. This illustrates Overview, 3.2.6. The dashed green lines are neutral lines from $C_r(\infty)$ to $C_{r+1}(\infty)$. The solid black lines with label 1 join an entry in $C_r(\infty)$ to an entry in C_{r+1} . This is also true of the dashed/dotted blue lines, but the latter are conditional on their being an entry in the left hand factor and from which there is no outgoing neutral line. The vertical red lines join an entry of $C_{r+1}(\infty) \setminus C_{r+1}$ to C_{r+1} .

Examples.

Some of the examples of the text are illustrated, with the numbering retained. In this a composition defines the standard parabolic being considered. Less and less details are given as it is presumed that the reader will become joyfully adept at using the rules set out in the main text, particularly 3.2.2, 3.2.6, 4.1.4, 4.3.6, 6.2, 7.3.

Example 3.

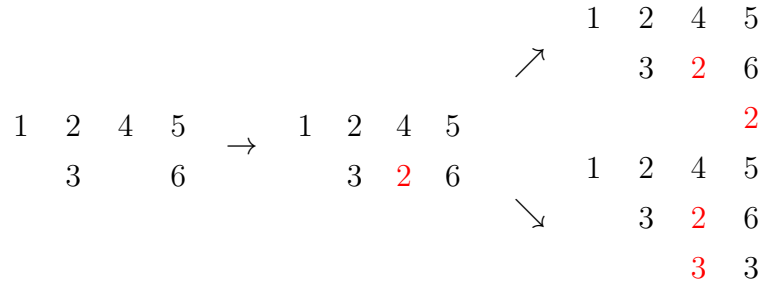

FIGURE 2. Consider the composition $(1, 2, 1, 2)$. There are two component tableaux. Starting from \mathcal{T} , one first moves 2 below 4. Then $\mathcal{B}_{2,4}^2 = \{3, 2\}$. Thus either 2 can be lowered below 6 or 3 below 2 and translated horizontally under 6.

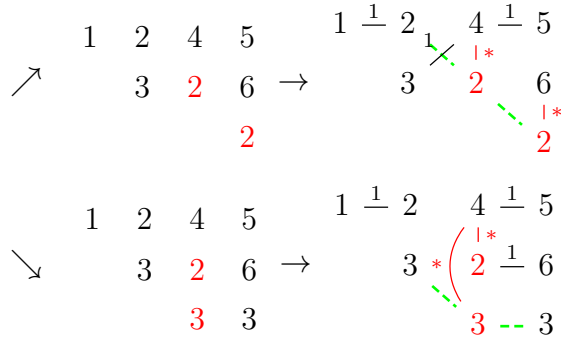

FIGURE 3. This describes the decoration of the lines in $\mathcal{T}(\infty)$ coming from the two component tableaux of Figure 2 following 3.2.6 and Figure 1.

Example 4.

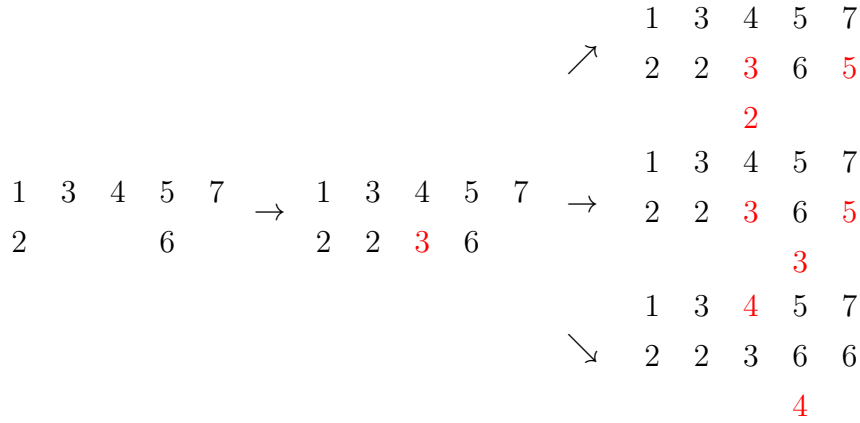

FIGURE 4. This describes the three component tableaux for the composition $(2, 1, 1, 2, 1)$ following assiduously the rules of section 3.2.2. Notably in the bottom tableau 4 is lowered by two rows below 6 using the fact that $4 \in \mathcal{B}_{3,5}^1 \cap \mathcal{B}_{1,4}^2$ and this excludes any further use of these pairs of neighbouring columns.

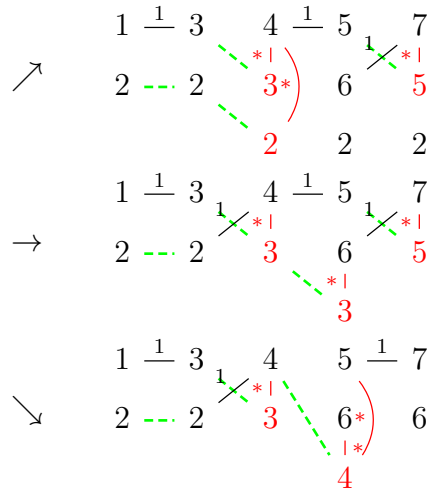

FIGURE 5. This describes the decoration of the lines in Figure 4.

Example 5.

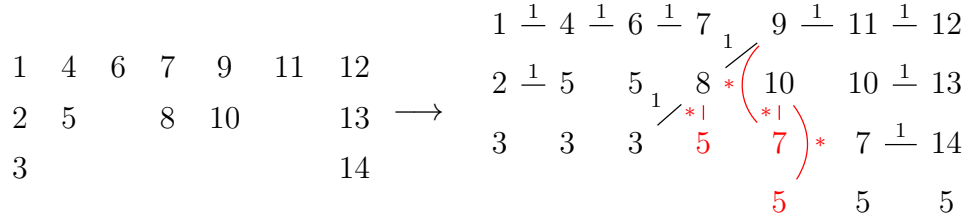

FIGURE 6. This describes *just one* component tableaux for the composition $(3, 2, 1, 2, 2, 1, 3)$. In this 7 is moved down two rows below 10 and 5 by one row below 8 and then by a further one row below 7 illustrating the paragraph just above Lemma 3.2.5. The lines with label 1 resulting from 3.2.6 are also indicated.

Example 6.

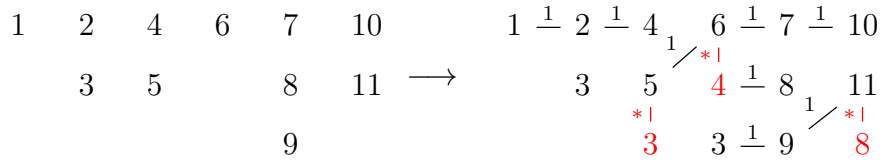

FIGURE 7. Choosing 4, 8, 3 sequentially from the batches in the composition $(1, 2, 2, 1, 3, 2)$ defines the component tableau $\mathcal{T}^{4,8,3}(\infty)$. The resulting lines in the component tableau obtained from Figure 1 are drawn but omitting the neutral lines.

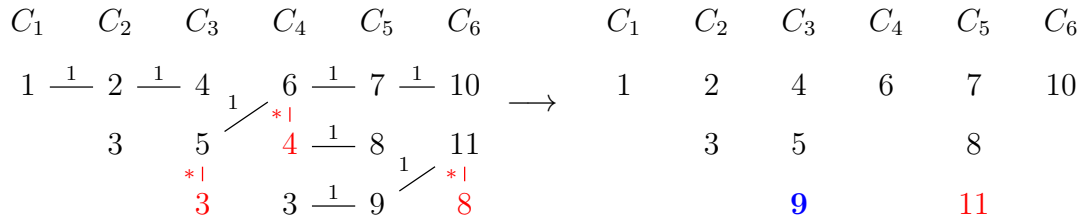

FIGURE 8. The right hand tableau is $\mathcal{T}_{8,11}$ of 4.1.4 with respect to $\mathcal{T}^{4,8,3}(\infty)$. Thus 11 is put under 8 and then 9 is pushed under 6 creating secondary excluded roots $\ell_{i',9}$: with $i' = 4, 5, 6$ which one may observe are not labelled by a 1, so satisfying Lemma 4.2.4.

Example 7

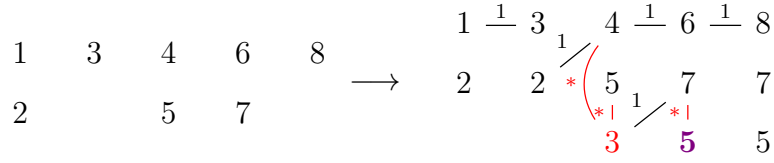

FIGURE 9. This describes $\mathcal{T}^{3,5}$ for the composition $(2, 1, 2, 2, 1)$. Given that 3 labelled in red, belongs to both batches \mathcal{B}^1 and \mathcal{B}^2 , whilst 5 in purple belong only to \mathcal{B}^2 , Therefore 3 can descend by two rows below 5. Then 5 descends one row below 7.

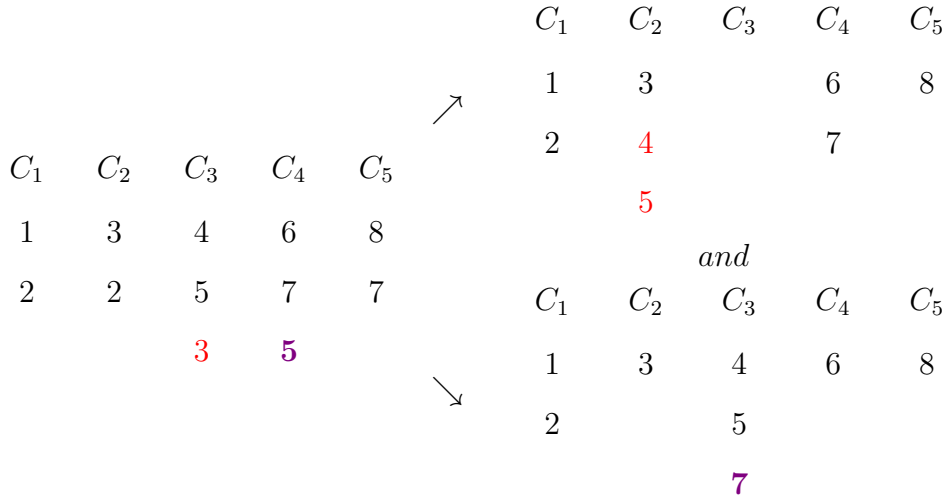
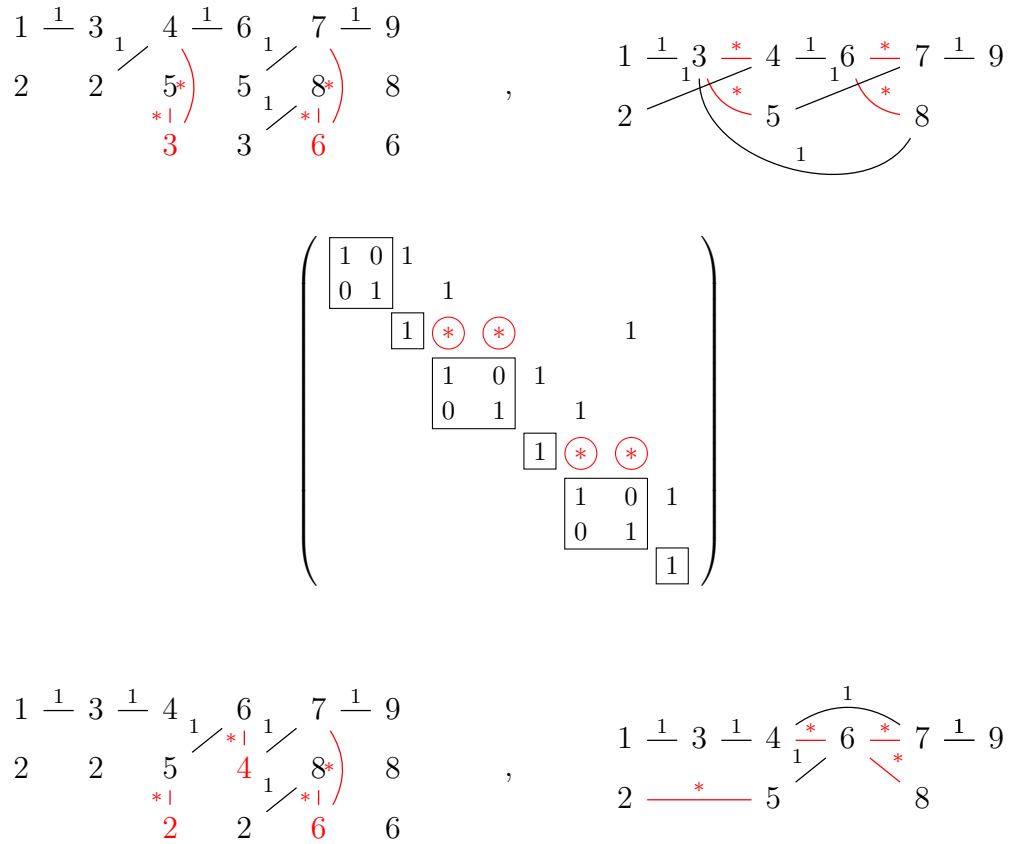

FIGURE 10. The top tableau on the right describes $\mathcal{T}_{3,\mathbf{j}}$. Here $\mathbf{j} := (4, 5)$ which is put below 3. The bottom tableau describes $\mathcal{T}_{5,7}$. In this 7 is put below 5. These two tableaux cannot be amalgamated into a single tableau and so this component is not an orbital variety closure.

Example 8.

	C_1	C_2	C_3	C_4	C_5	C_6
R_1	1	3	4	6	7	9
R_2	2		5		8	

FIGURE 11. This describes \mathcal{T} for the composition $(2, 1, 2, 1, 2, 1)$. All five component tableaux are given below following the rules of 3.2.2, 4.1.4 which the reader will now have no difficulty in applying. Here $\mathcal{T}^{\mathcal{C}}(\infty)$ appears on the left, $\mathcal{T}^{\mathcal{C}}$ appears on the right and below the corresponding matrix \mathbf{M} is given with labels 1, * and the excluded root vectors encircled.



COMPONENT TABLEAUX

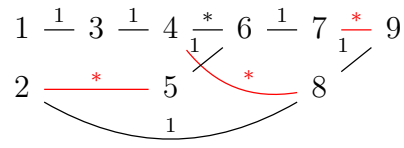
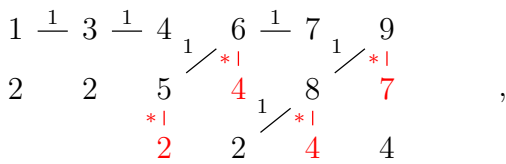
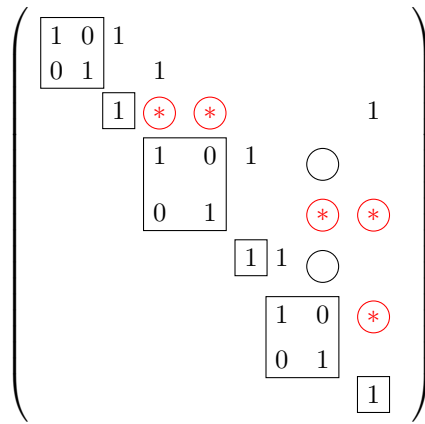
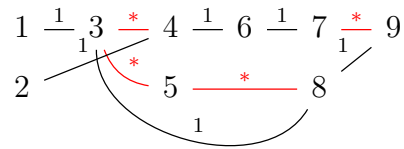
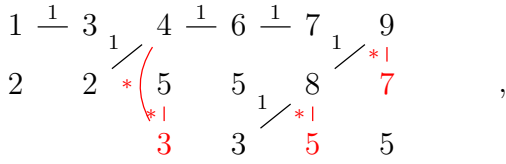
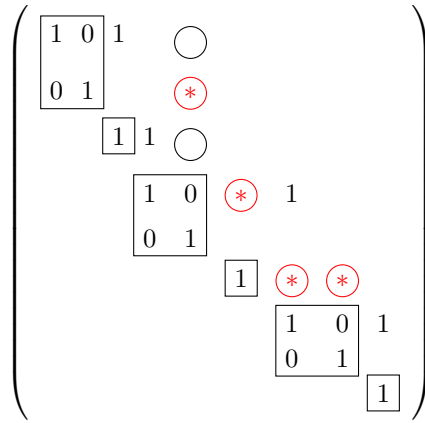

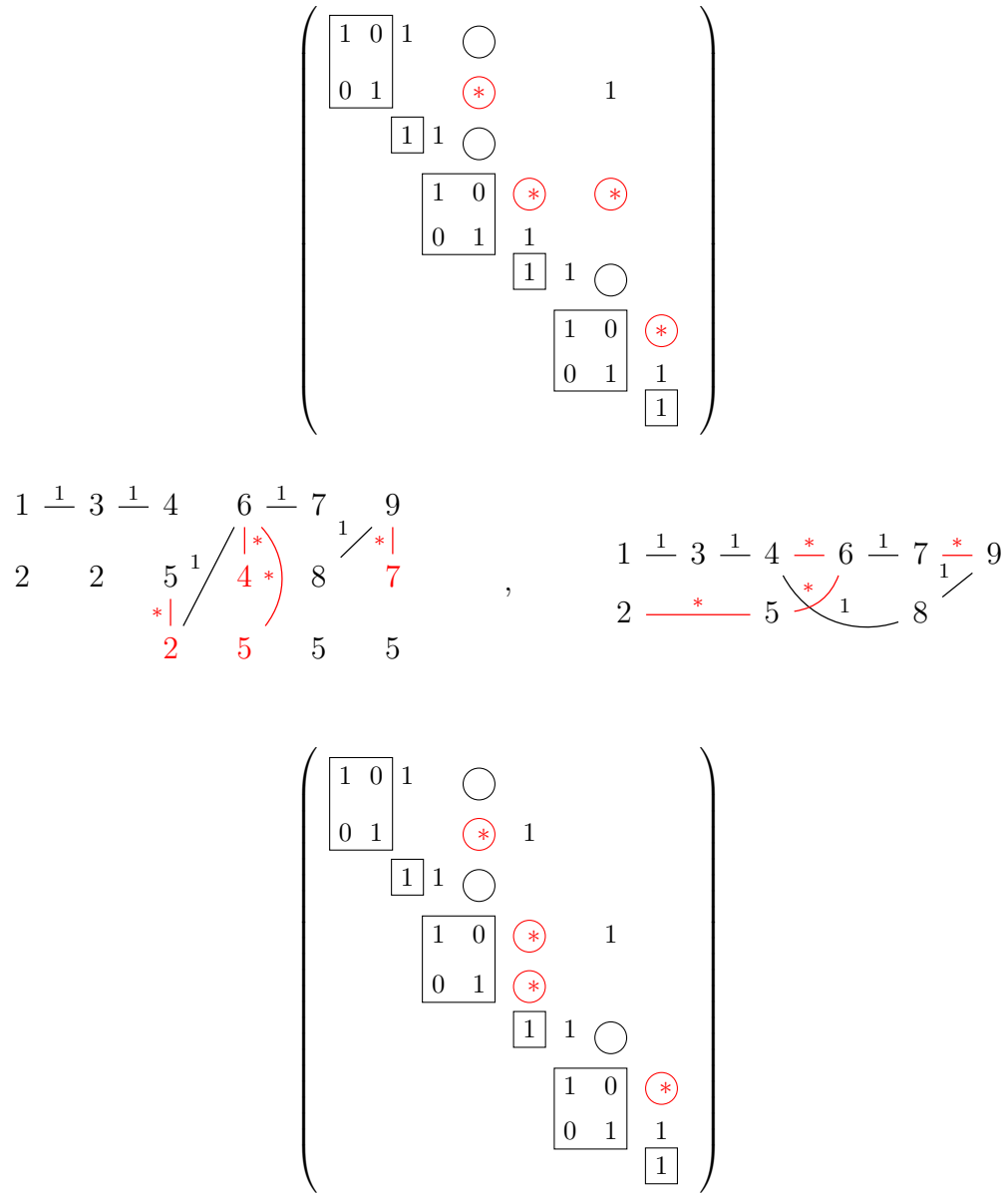

FIGURE 12. From the above one may verify that the Exchange Lemma 7.2 and the criterion for partial linearity Lemma 7.3 hold. There are six Benlolo-Sanderson invariants and the reader may care to verify that each vanish when the encircled roots are set equal to zero as prescribed by Proposition 4.4.

Example 18

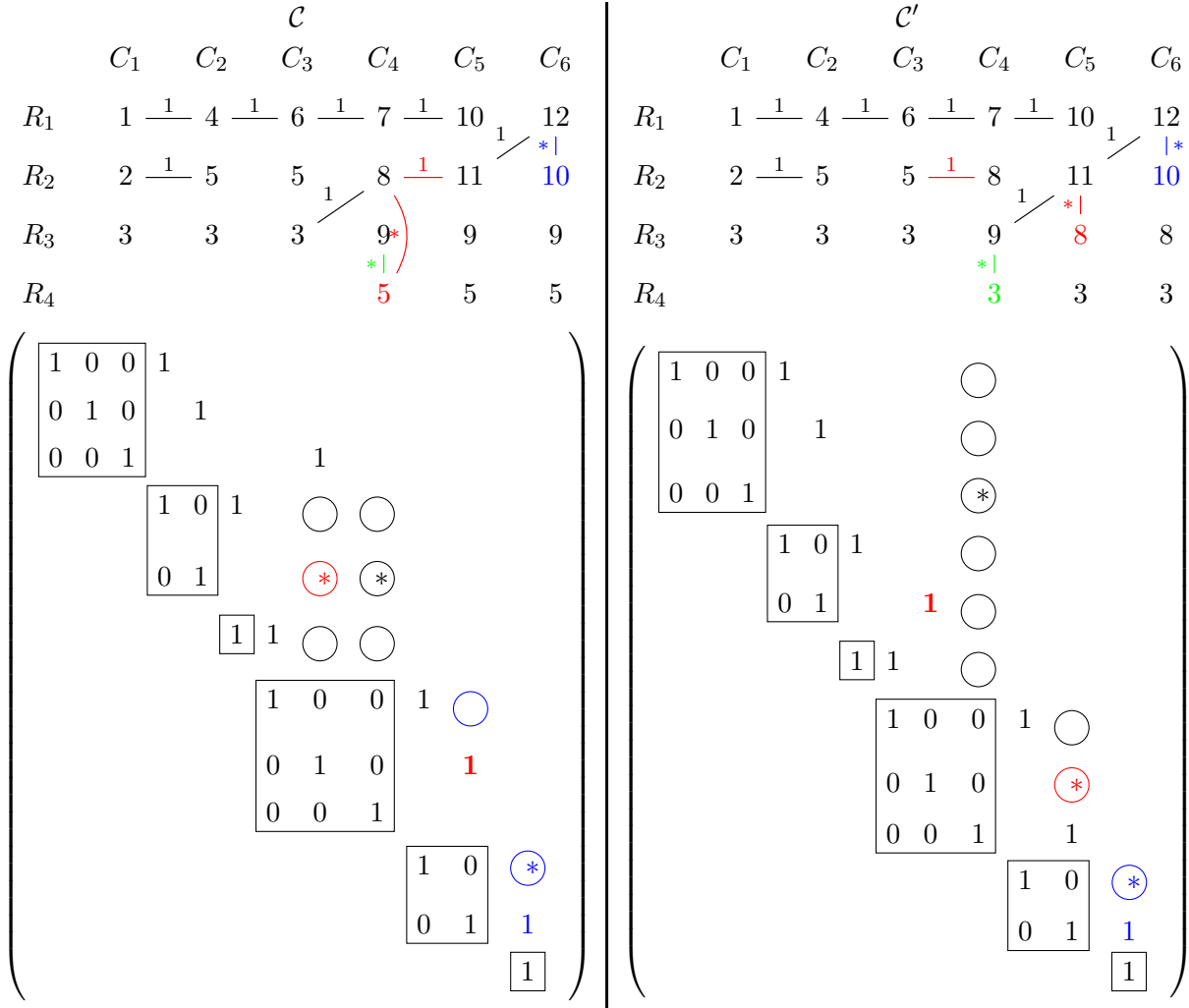

FIGURE 13. The component tableau $\mathcal{T}^{\mathcal{C}}$ (resp. $\mathcal{T}^{\mathcal{C}'}$) on the left (resp. right) is given for the composition $(3, 2, 1, 3, 2, 1)$, with 8 (resp. 5) chosen from \mathcal{B}_{C_2, C_5}^2 . This makes $\ell_{8,11}$ the rightmost line as defined in 7.3. The Benolo-Sanderson is $I := I_{C_2, C_5}^2$. The encircled root vector $x_{7,11}$ is not required for I to vanish, as a consequence of Lemma 7.3, verifiable independently in this case. Thus the condition Corollary 7.4 for partial linearity is satisfied. As a consequence the resulting components \mathcal{C} (resp. \mathcal{C}') of \mathcal{N} are distinct, as predicted by Proposition 7.5.

Example 19

FIGURE 14. The component tableau $\mathcal{T}^{\mathcal{C}}$ (resp. $\mathcal{T}^{\mathcal{C}'}$) on the left (resp. right) is given for the composition $(3, 2, 1, 2, 2, 1, 3)$, with 7 (resp. 8) chosen from \mathcal{B}_{C_2, C_5}^2 . This makes $\ell_{9,11}$ the rightmost line as defined in 7.3. The Benolo-Sanderson is $I := I_{C_3, C_6}^1$. The encircled root vectors in the last column, notably $x_{7,14}, x_{9,14}$, are not needed for I to vanish, as a consequence of Lemma 7.3 verifiable independently in this case. Thus the condition Corollary 7.4 for partial linearity is satisfied. As a consequence the resulting components \mathcal{C} (resp. \mathcal{C}') of \mathcal{N} are distinct.

Example 20.

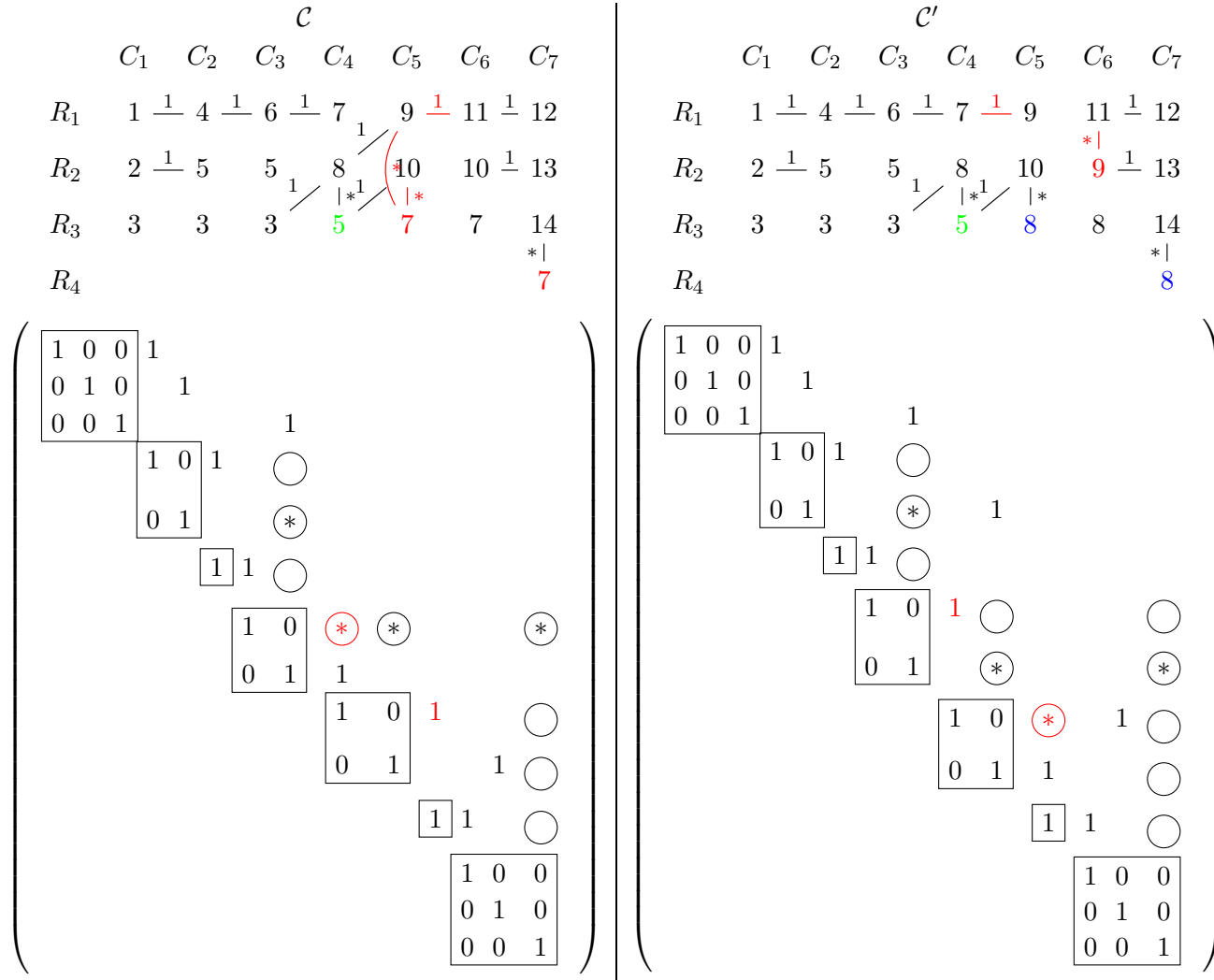
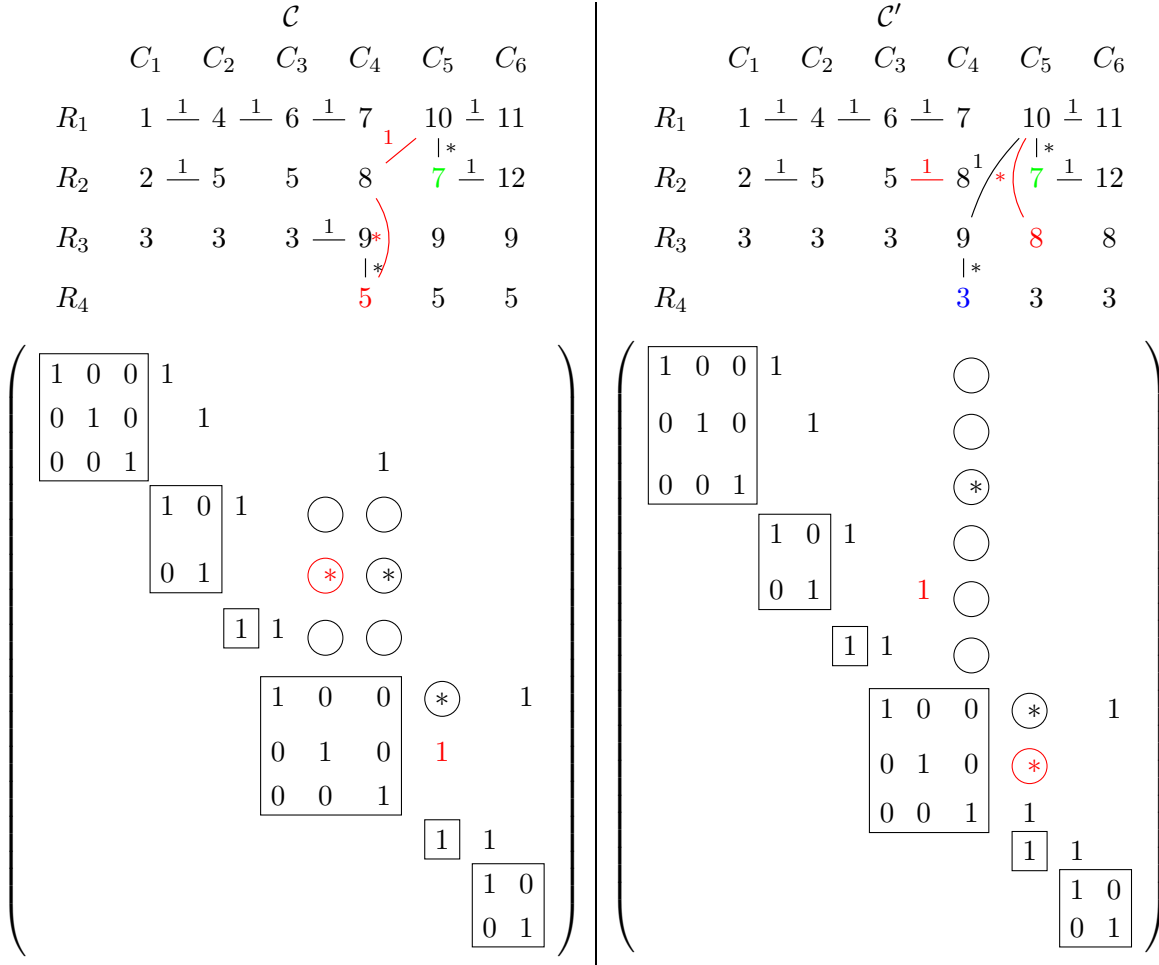

FIGURE 15. The component tableau $\mathcal{T}^{\mathcal{C}}$ (resp. $\mathcal{T}^{\mathcal{C}'}$) on the left (resp. right) is given for the composition $(3, 2, 1, 3, 1, 2)$, with 5 (resp. 8) chosen from \mathcal{B}_{C_2, C_6}^2 . This makes $\ell_{8,10}$ the rightmost line as defined in 7.3. The Benolo-Sanderson is $I := I_{C_2, C_6}^2$. The encircled root vector $x_{7,10}$ is not required for I to vanish, as a consequence of Lemma 7.3 verifiable independently in this case. Thus the condition Corollary 7.4 for partial linearity is satisfied. As a consequence the resulting components \mathcal{C} (resp. \mathcal{C}') of \mathcal{N} are distinct.

REFERENCES

- [1] M. F. Atiyah and I. G. Macdonald, Introduction to commutative algebra, Addison-Wesley Ser. Math. Westview Press, Boulder, CO, 2016.
- [2] E. Benlolo, and Y. B. Sanderson, On the hypersurface orbital varieties of $\mathfrak{sl}(N, \mathbb{C})$. *J. Algebra* 245 (2001), no. 1, 225–246.
- [3] T. Brüstle, L. Hille, C. M. Ringel and G Röhrle, Gerhard The Δ -filtered modules without self-extensions for the Auslander algebra of $k[T]/\langle T^n \rangle$. *Algebr. Represent. Theory* 2 (1999), no. 3, 295–312.
- [4] J. Dixmier, Algèbres enveloppantes. (French) Cahiers Scientifiques, Fasc. XXXVII. Gauthier-Villars Éditeur, Paris-Brussels-Montreal, Que., 1974.
- [5] A. B. Davidson, Hebrew Grammar, Edinburgh T. and T. Clark, 1962.
- [6] T. J. Enright and A. Joseph, An intrinsic analysis of unitarizable highest weight modules, *Math. Ann.* 288 (1990), no. 4, 571–594.
- [7] F. Fauquant-Millet, Weierstrass sections for some truncated parabolic subalgebras. *J. Algebra* 580 (2021), 299–365.
- [8] Y. Fittouhi and A. Joseph, Weierstrass sections for Parabolic adjoint actions in type A, *J. Algebra* 618 (2023), 1–41..
- [9] Y. Fittouhi and A. Joseph, Parabolic adjoint action, Weierstrass sections and components of the nilfibre in type A, *Indag Math.* (to appear).
- [10] Y. Fittouhi and A. Joseph, The canonical compoent of the nilfibre for parabolic adjoint action, Weierstrass sections in type A, *Journal of Algebraic Combinatorics*, online.
- [11] Y. Fittouhi and A. Joseph, The Composition Tableau and Reconstruction of the Canonical Weierstrass Section for Parabolic Adjoint Action in type A, *J. Algebra* 632(2023), 1–30.
- [12] W. M. McGovern, On the Spaltenstein-Steinberg map for classical Lie algebras, *Comm. in Alg.* 27 (1999), 2979–2993.
- [13] B. T. Jensen, X. Su, R.W.T. Yu, Rigid representations of a double quiver to type A , and Richardson elements in seaweed Lie algebras, *Bull. Lond. Math. Soc.* 41 (2009), 1-15.
- [14] A. Joseph, Slices for biparabolic coadjoint actions in type A. *J. Algebra* 319 (2008), no. 12, 5060–5100.
- [15] A. Joseph, Compatible adapted pairs and a common slice theorem for some centralizers. *Transform. Groups* 13 (2008), no. 3-4, 637–669.
- [16] A. Joseph, Some remarks on Weierstrass sections, adapted pairs and polynomiality, *Springer Proc. Math. Stat.*, 36 Springer, Tokyo, 2013, 39–60.
- [17] A. Joseph, Orbital varieties of the minimal orbit, *Ann. Sci. École Norm. Sup. (4)* 31 (1998), no. 1, 17–45.
- [18] A. Joseph and A. Melnikov, Quantization of hypersurface orbital varieties in $\mathfrak{sl}(n)$, *Progr. Math.*, 213, Birkhäuser Boston, Inc., Boston, MA, 2003, 165–196.
- [19] B. Kostant, The principal three-dimensional subgroup and the Betti numbers of a complex simple Lie group. *Amer. J. Math.* 81 (1959), 973–1032.
- [20] B. Kostant, Verma modules and the existence of quasi-invariant differential operators, in *Non-commutative harmonic analysis*. J. Carmona, J. Dixmier and M. Vergne, (eds.) (Lect. Notes Math. Vol. 466). Berlin Heidelberg New York: Springer 1975.
- [21] A. Melnikov, Robinson-Schensted procedure and combinatorial properties of geometric order $\mathfrak{sl}(n)$. *C. R. Acad. Sci. Paris Sér. I Math.* 315 (1992), no. 6, 709–714.

- [22] E. Perelman, Quantization of hypersurface orbital varieties in simple Lie algebras of classical types, Thesis, Weizmann Institute 2003.
- [23] V. L. Popov and E. B. Vinberg, Some open problems in invariant theory. Proceedings of the International Conference on Algebra, Part 3 (Novosibirsk, 1989), 485—497, *Contemp. Math.*, 131, Part 3, Amer. Math. Soc., Providence, RI, 1992.
- [24] N. Spaltenstein, On the fixed point set of a unipotent element on the variety of Borel subgroups. *Topology* 16 (1977), no. 2, 203—204.
- [25] R. Steinberg, An occurrence of the Robinson-Schensted correspondence, *J. Algebra* 113 (1988), no. 2, 523—528.
- [26] I. R. Shafarevich, *Basic algebraic geometry*. Translated from the Russian by K. A. Hirsch. Revised printing of *Grundlehren der mathematischen Wissenschaften*, Vol. 213, 1974. Springer Study Edition. Springer-Verlag, Berlin-New York, 1977.
- [27] O. Yakimova, A counterexample to Premet's and Joseph's conjectures, *Bull. Lond. Math. Soc.* 39 (2007), no. 5, 749—754.