

Quantum circuits for block encoding of structured matrices in ocean acoustics

Chunlin Yang¹, Hongmei Yao¹, Guofeng Zhang², Zhaobing Fan¹, Zexian Li², and Jianshe Liu³

¹School of Mathematical and Sciences, Harbin Engineering University, China

²Department of Applied Mathematics, The Hong Kong Polytechnic University, China

³College of Underwater Acoustic Engineering, Harbin Engineering University, China

Block encoding is a data input model commonly used in a quantum computer. It is a technique that embeds a matrix A satisfying $\|A\| \leq 1$ into a larger unitary matrix U_A . We consider special structured matrices arising from generalized eigenvalue equations in ocean acoustics. We develop their block encoding scheme and further improve it which results lower subnormalisations. And we discuss how to construct quantum circuits of block encoding for the structured matrices. Two numerical examples are used to illustrate the feasibility of our block encoding schemes. The corresponding codes of the quantum circuits in MATLAB are also presented.

Contents

1	Introduction	2
2	Notations and Conventions	4
3	Block encoding of structured matrices	6
3.1	Base scheme	6
3.2	Preamplified scheme	8
3.3	PREP/UNPREP scheme	11
3.4	Hermitian block encoding	14
4	Examples of generalized eigenvalue equation $AV = BV\Sigma$ in ocean acoustics	16
4.1	Block encoding of the matrix B	18
4.1.1	The O_c circuit	18
4.1.2	The O_{rg} circuit	19
4.1.3	The O_{data} circuit	20
4.1.4	The complete quantum circuit	20
4.2	Block encoding of the matrix A	21
4.2.1	The O_c circuit	21
4.2.2	The O_{rg} circuit	22
4.2.3	The O_{data} circuit	22
4.2.4	The complete quantum circuit	23
	Bibliography	24
A	QCLAB codes of quantum circuit	25
A.1	QCLAB codes for the matrix B	25
A.2	QCLAB codes for the matrix A	26

1 Introduction

Quantum algorithms are algorithms running on a quantum computer. It has been found that quantum algorithms can solve some problems efficiently that algorithms on a classical computer cannot do remarkably. Compared to classical algorithms, some quantum algorithms provide exponential speedup, such as Deutsch-Jozsa algorithm[1], Grover's algorithm[2], Shor's algorithm[3] and HHL algorithm[4]. Matrices are data structures that are very commonly used in various quantum algorithms. It leads to the problem of how to implement a non-unitary matrix on a quantum computer efficiently.

One way to encode a matrix into a larger unitary operator is the so-called block encoding [5], i.e., to represent a matrix $A \in \mathbb{C}^{N \times N}$ as the upper-left block of a larger unitary U_A :

$$U_A = \begin{bmatrix} A/\alpha & * \\ * & * \end{bmatrix} \implies A = \alpha(\langle 0| \otimes I)U_A(|0\rangle \otimes I),$$

where $*$ denotes a matrix block yet to be determined. We use α , called subnormalisation, to scale A such that $\|A/\alpha\| \leq 1$, because the singular values of any matrix block of a unitary matrix are not larger than 1. Here, $\|\cdot\|$ is spectral norm. Based on block encoding, the QSVT algorithm[5] has been proposed. According to [6], many quantum algorithms can be reconstructed in the framework of the QSVT.

There has been many research works on block encoding. In [7], Low and Chuang proposed a method to construct a block encoding of a purified density operator. Apeldoorn and Gilyén [8] generalized the result for subnormalized density operators, and proposed an implementation scheme for a POVM operator. In [5], Gilyén et al. implemented a block encoding of sparse matrices and its preamplified scheme. Kerenidis and Prakash [9], and Chakraborty et al.[10] showed how to implement block encodings of matrices stored in quantum data structures efficiently. Based on quantum random access memory (QRAM) query model, Clader et al.[11] developed several methods of block encoding of a dense matrix of classical data. Nguyen et.al. [12] proposed a block-encoding scheme of the hierarchical matrix structure on a quantum computer. In [13], Li et.al. developed a blocked encoding for a rich family of dense operators: the pseudo differential operators (PDOs). For sparse matrices, in [14], Camps, Lin, et al. proposed a block encoding method that embeds a matrix with constraint that each data item should appear in all columns. In [15], Sünderhauf et al. gave a new block encoding method for arithmetically structured matrices without the constraint in [14]. Also, they proposed a figure of merit for block encoding:

$$(T\text{-gate count}) \cdot \text{subnormalisation}, \tag{1.1}$$

which can be simplified by considering

$$(\text{data loading cost}) \cdot \text{subnormalisation}. \tag{1.2}$$

Data loading cost, i.e., the number of data loaded, dominates the cost of T gates, which are more expensive than Clifford gates in the popular surface codes of error correction codes. The subnormalisation is a factor to scale the matrix elements. A lower subnormalisation can increase the probability to measure $|0\rangle$ for the flag qubits and lead to shorter circuits in algorithms with the block encoding. In general, the lower the product (1.2) is, the better the block encoding will be.

In the field of ocean acoustics, acoustic waves are able to propagate over long distances in seawater media, which is currently the main way to obtain underwater information. This makes the calculation and analysis of underwater acoustic propagation become the core content of underwater acoustic information confrontation. Ocean acoustics includes shallow sea acoustics, deep sea acoustics, and polar acoustics. In the field of polar acoustics, for the propagation of sound wave in ice and seawater, according to [16] and [17], the actual measurement in seawater is generally the sound pressure field while in ice the actual measurement is the displacement field. To solve these two fields, we use normal-mode method developed by Pekeris [18], which is a mathematical and physical tool used to describe the vibrational behavior of multi-body systems. It involves decomposing the system's vibrations into normal modes, which represent the fundamental independent modes of vibration within the system. Each normal mode has specific frequencies and

amplitudes, and the overall system vibration can be considered as a combination of these modes. By the normal-mode method, on one hand, the sound pressure field $p(r, z)$ can be computed from the sound pressure modes $\varphi_m(z)$ [16]:

$$p(r, z) = \frac{i}{\rho(z_s)\sqrt{8\pi r}} e^{-i\pi/4} \sum_m \varphi_m(z_s) \varphi_m(z) \frac{e^{ik_m r}}{\sqrt{k_m}}, \quad (1.3)$$

where r is the horizontal distance, z is the depth, z_s is the depth of sound source, $\rho(z_s)$ is the density at z_s , k_m is the horizontal wave number and $i^2 = -1$. On the other hand, the displacement field contains the horizontal displacement field $u(r, z)$ and the vertical displacement field $w(r, z)$, which can be computed from the horizontal displacement modes $d_m^{(1)}(z)$ and the vertical displacement modes $d_m^{(2)}(z)$ [17]:

$$u(r, z) = \sum_m \frac{d_m^{(1)}(z)}{8c_m U_m I_m} \sqrt{\frac{2}{\pi k_m r}} e^{i(k_m r - \frac{\pi}{4})} \left\{ k_m d_m^{(1)}(z_s) + \left. \frac{d d_m^{(2)}(z)}{dz} \right|_{z_s} \right\}, \quad (1.4)$$

$$w(r, z) = \sum_m \frac{d_m^{(2)}(z)}{8c_m U_m I_m} \sqrt{\frac{2}{\pi k_m r}} e^{i(k_m r + \frac{\pi}{4})} \left\{ k_m d_m^{(1)}(z_s) + \left. \frac{d d_m^{(2)}(z)}{dz} \right|_{z_s} \right\}, \quad (1.5)$$

where $U_m = \frac{d\omega}{dk_m}$ is the group velocity of the displacement mode, $c_m = \frac{\omega}{k_m}$ is the phase velocity of the displacement mode and $I_m = \frac{1}{2} \int \rho(z) \left(d_m^{(1)2}(z) + d_m^{(2)2}(z) \right) dz$. Therefore, the sound field can be solved if we know the modes $\varphi_m(z)$, $d_m^{(1)}(z)$ and $d_m^{(2)}(z)$. By finite difference methods, the problem of solving these modes can be transformed into the problem of solving generalized eigenvalue equations (GEEs)

$$AV = BV\Sigma, \quad (1.6)$$

where A and B are structured sparse matrices, V is a matrix composed of generalized eigenvectors and Σ is a diagonal matrix composed of generalized eigenvalues.

In quantum computing, solving GEEs on a quantum computer has attracted many researchers' interest. Parker and Joseph [19] showed quantum phase estimation (QPE) can be applied to generalized eigenvalue problems (GEPs). In [20], the generalized eigenvalues of GEEs can be found by running a quantum gradient descent algorithm. Using ordinary differential equations, Shao and Liu [21] proposed a new quantum algorithm for solving symmetric GEPs with a low complexity, and matrices in their GEEs have an assumption of block encoding. In [22], Garcia-Escartin gave a variational quantum eigenvector finding method which is adapted to solve GEPs. By developing the Euclidean time method of the variational quantum eigensolver (VQE), Hwang et al.[23] also investigated the GEEs.

In this paper, we will develop some improved block encoding schemes which have lower figure of merit (1.2) based on [14]. See Table 1. Using examples in polar acoustics, we will show explicit implementations of their quantum circuits using the QCLAB[24] Toolbox, which can construct and draw quantum circuits for block encodings of matrices in MATLAB. The QCLAB Toolbox can be downloaded from <https://github.com/QuantumComputingLab/explicit-block-encodings>.

Block encoding schemes (this work)	Data loading cost	Subnormalisation	Flag qubits
Base (sec. 3.1, Theorem 3.2)	s_0	$s A $	$2 + \log_2 s$
Preamplified (sec. 3.2, Theorem 3.5)	$s_0 \cdot \text{amp}_{\gamma_L, \gamma_R}$	$\sqrt{2} \beta_p(A)$	$3 + \log_2 s$
\hookrightarrow with optimal $p = \frac{1}{2}$	$s_0 \cdot \text{amp}_{\gamma_L, \gamma_R}$	$\sqrt{2} \beta_{\frac{1}{2}}(A) = \sqrt{2} \sum_{l=0}^{s_0-1} A_l $	$3 + \log_2 s$
PREP/UNPREP (sec. 3.3, Theorem 3.6)	$2s$	$\alpha_p(A)$	$1 + \log_2 s$
\hookrightarrow with optimal $p = \frac{1}{2}$	$2s$	$\alpha_{\frac{1}{2}}(A) = \sum_{l=0}^{s_0-1} A_l $	$1 + \log_2 s$
$\hookrightarrow p = \frac{1}{2}, A \in \mathbb{R}^{N \times N}$	s	$\alpha_{\frac{1}{2}}(A)$	$1 + \log_2 s$
Block encoding schemes ([15])			
Base	s_0	$\sqrt{S_c S_r} A $	$2 + \log_2 s$
Preamplified	$s_0 \cdot \text{amp}_{\gamma_c, \gamma_r}$	$\sqrt{2} \mu_p(A)$	$5 + \log_2 s$
PREP/UNPREP (for $s \leq S_c, S_r$)	$2s$	$\alpha_p(A)$	$1 + \log_2 s$
\hookrightarrow with optimal $p = \frac{1}{2}$	$2s$	$\frac{\sqrt{S_c S_r}}{s} \alpha_{\frac{1}{2}}(A) = \frac{\sqrt{S_c S_r}}{s} \sum_{l=0}^{s_0-1} A_l $	$1 + \log_2 s$
$\hookrightarrow p = \frac{1}{2}, A \in \mathbb{R}^{N \times N}$	s	$\frac{\sqrt{S_c S_r}}{s} \alpha_{\frac{1}{2}}(A)$	$1 + \log_2 s$

$$\alpha_p(A) = \sqrt{\sum_{l=0}^{s_0-1} |A_l|^{2p} \sum_{l=0}^{s_0-1} |A_l|^{2-2p}} \quad \mu_p(A) = \sqrt{\max_i \sum_j |A_{ij}|^{2p} \max_j \sum_i |A_{ij}|^{2-2p}}$$

$$\beta_p(A) = \sqrt{\left(\sum_{l=0}^{s_0-1} |A_l|^{2p} + (s - s_0) |A|^{2p} \right) \left(\sum_{l=0}^{s_0-1} |A_l|^{2-2p} + (s - s_0) |A|^{2-2p} \right)}$$

$$\text{amp}_{\gamma_L, \gamma_R} \approx 3 \left(\frac{\gamma_L}{\delta} \log \frac{\gamma_L}{\delta} + \frac{\gamma_R}{\delta} \log \frac{\gamma_R}{\delta} \right) \quad \text{amp}_{\gamma_c, \gamma_r} \approx 3 \left(\frac{\gamma_c}{\delta} \log \frac{\gamma_c}{\delta} + \frac{\gamma_r}{\delta} \log \frac{\gamma_r}{\delta} \right)$$

$$\gamma_L = \frac{\sqrt{s} |A|^p}{\sqrt{\sqrt{2} \sum_{l=0}^{s_0-1} |A_l|^{2p}}} \quad \gamma_R = \frac{\sqrt{s} |A|^{1-p}}{\sqrt{\sqrt{2} \sum_{l=0}^{s_0-1} |A_l|^{2-2p}}}$$

$$\gamma_c = \frac{\sqrt{S_c} |A|^p}{\sqrt{\sqrt{2} \max_i \sum_j |A_{ij}|^{2p}}} \quad \gamma_r = \frac{\sqrt{S_r} |A|^{1-p}}{\sqrt{\sqrt{2} \max_j \sum_i |A_{ij}|^{2-2p}}}$$

Table 1: Comparison of block encoding schemes for a matrix $A \in \mathbb{C}^{N \times N}$ with s_0 data items, where $N = 2^n$ and $2^{m-1} < s_0 \leq s = 2^m$. S_c and S_r are the maximum column and row sparsities, respectively. We compare our results with Sünderhauf et.al.[15]'s results. If $s < \sqrt{S_c S_r}$, our base scheme has a lower figure of merit. If $s > \sqrt{S_c S_r}$, Sünderhauf's base scheme has a lower figure of merit. But for PREP/UNPREP scheme, the figure of merit of ours is lower if $s < \sqrt{S_c S_r}$ because their PREP/UNPREP scheme has a constraint of $s \leq \sqrt{S_c S_r}$.

2 Notations and Conventions

In this section, we introduce the conventions used in this article. Let $[m, n] = \{m, m+1, \dots, n\}$, especially, $[n] = [1, n]$. $|0\rangle$ is used to represent the vector $e_0 = [1, 0]^T$ and $|1\rangle$ represents the vector $e_1 = [0, 1]^T$. The tensor product of m $|0\rangle$'s, i.e., $|0\rangle \otimes |0\rangle \otimes \dots \otimes |0\rangle$, is represented by $|0\rangle^{\otimes m}$. We use I_N to denote the $N \times N$ identity matrix and the $(j+1)$ th column of I_N is denoted by $|j\rangle$, where $j \in [0, N-1]$. $|A|$ denotes the maximum module of elements in matrix A . For an integer $j \in [0, 2^n - 1]$, it has a binary representation

$$j = [j_{n-1} \dots j_1 j_0] = j_{n-1} \times 2^{n-1} + \dots + j_1 \times 2^1 + j_0 \times 2^0,$$

where $j_k \in \{0, 1\}$, $k \in [0, n-1]$.

The letters H , X , Y , and Z are used to represent the Hadamard, Pauli- X , Pauli- Y , and Pauli- Z matrices, respectively, which are as follows.

$$H = \frac{1}{\sqrt{2}} \begin{bmatrix} 1 & 1 \\ 1 & -1 \end{bmatrix}, X = \begin{bmatrix} 0 & 1 \\ 1 & 0 \end{bmatrix}, Y = \begin{bmatrix} 0 & -i \\ i & 0 \end{bmatrix}, Z = \begin{bmatrix} 1 & 0 \\ 0 & -1 \end{bmatrix}. \quad (2.1)$$

Rotation matrices with rotation angle θ along the Pauli- X , Pauli- Y and Pauli- Z axes are denoted below,

$$R_X(\theta) \equiv e^{-i\theta X/2} = \begin{bmatrix} \cos(\theta/2) & -i \sin(\theta/2) \\ -i \sin(\theta/2) & \cos(\theta/2) \end{bmatrix}, \quad (2.2)$$

$$R_Y(\theta) \equiv e^{-i\theta Y/2} = \begin{bmatrix} \cos(\theta/2) & -\sin(\theta/2) \\ \sin(\theta/2) & \cos(\theta/2) \end{bmatrix}, \quad (2.3)$$

$$R_Z(\theta) \equiv e^{-i\theta Z/2} = \begin{bmatrix} e^{-i\frac{\theta}{2}} & 0 \\ 0 & e^{i\frac{\theta}{2}} \end{bmatrix}. \quad (2.4)$$

When it comes to draw quantum circuit diagrams, we follow the standard conventions. As is shown in Figure 1, we use a horizontal line to represent a single qubit or multiple qubits. The rectangular box is used to represent a single qubit or multi-qubit gate. The state of a qubit is a superposition of $|0\rangle$ and $|1\rangle$, so that a set of quantum states $|j_{n-1}\rangle \cdots |j_1\rangle |j_0\rangle$ can map to a binary representation of an integer j , see Figure 2.

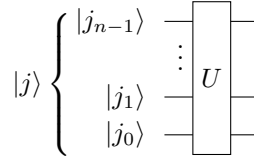
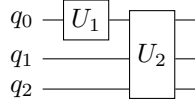

Figure 1: Quantum circuit for operators U_1 and U_2 . Figure 2: The binary representation of qubits of $|j\rangle$.

The controlled gates are important quantum gates, which use one or more qubits to control some operations of other qubits. Figure 3 is the controlled NOT (C-NOT) gate. The control

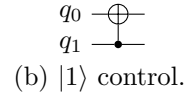
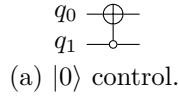

Figure 3: C-NOT gates.

operation is represented by a vertical line that connect the control qubit(s) to the target gate, where the control qubits are marked by either an open or solid circle. For a C-NOT gate, if the number of control qubits is more than 1, then such controlled NOT gate is called multi-controlled NOT (MC-NOT) gate. The circuit of operator U controlled by one or more qubits are shown in Figure 4.

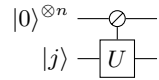

Figure 4: Quantum circuit of U controlled by one or more qubits.

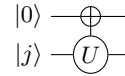

Figure 5: The operator U consists of some C-NOT or MC-NOT gates.

When a sequence of C-NOT and MC-NOT gates are controlled by the same register and act on the same qubit, we use a circle or oval to denote the operator consisting of these gates, see Figure 5. Using MC-NOT gates, a C-NOT gate and a Pauli- X gate, we can respectively construct the quantum circuits for the addition $+2^k$ and subtraction -2^k arithmetic operations, called L^k -shift and R^k -shift operators[14], see Figure 6. In this way, for any arithmetic expression $+j$, it has binary representation and can be decomposed into $+j = +\sum_{k=0}^{n-1} j_k 2^k$ or $+j = +2^n - \sum_{k=0}^{n-1} l_k 2^k$, where $j_k, l_k \in \{0, 1\}$. Then $+j$ operator can be implemented by a combination of some L^k -shift and R^k -shift operators $\prod_{k=0, j_k=1}^{n-1} L^k$ or $L^n \prod_{k=0, l_k=1}^{n-1} R^k$. More discussions can be found in [14].

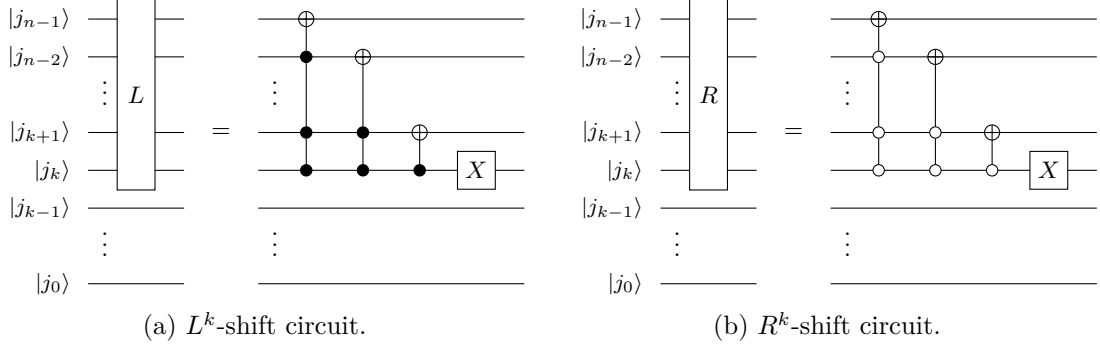

Figure 6: The L^k -shift and R^k -shift circuits.

3 Block encoding of structured matrices

In this section, we propose some block encoding methods which have low figures of merit. The definition of block encoding is as follows.

Definition 3.1 (Block encoding). *Suppose that A is an n -qubit operator, $N = 2^n, \alpha, \epsilon \in \mathbb{R}_+$ and $a \in \mathbb{N}$, then we say that the $(n + a)$ -qubit unitary U_A is an (α, a, ϵ) -block-encoding of A , if*

$$\left\| A - \alpha \left(\langle 0 |^{\otimes a} \otimes I_N \right) U_A \left(| 0 \rangle^{\otimes a} \otimes I_N \right) \right\| \leq \epsilon.$$

3.1 Base scheme

Let $A \in \mathbb{C}^{N \times N}$ be a matrix. We classify all non-zero matrix elements in A into s_0 sets such that:

- (1) All elements in each set have the same value.
- (2) All row(column) indices of elements in the l -th set ($l \in [0, s_0 - 1]$) can be obtained by their corresponding column(row) indices through the same function.

The value of elements in the l -th set ($l \in [0, s_0 - 1]$) is called the l -th data item, denoted by A_l . The following theorem is the base scheme of block encoding.

Theorem 3.2. *Let $A = (a_{ij}) \in \mathbb{C}^{N \times N}$ be a matrix with s_0 data items, where $N = 2^n, 2^{m-1} < s_0 \leq s = 2^m$. Let $S_c(l)$ be a set that includes all column indices of the l -th data item in A , and $c_l(j)$ be a function that gives row indices according to column indices $j \in S_c(l)$ for the l -th data item of A and remains the same function if $j \notin S_c(l)$, where $l \in [0, s_0 - 1]$. If there exists an out-of-range oracle O_{rg} such that*

$$O_{\text{rg}} | 0 \rangle_{\text{del}} | l \rangle | j \rangle = \begin{cases} | 0 \rangle | l \rangle | j \rangle, & \text{if } l \in [0, s_0 - 1] \text{ and } j \in S_c(l), \\ | 1 \rangle | l \rangle | j \rangle, & \text{if } l \in [s_0, s - 1] \text{ or } j \notin S_c(l), \end{cases}$$

a column oracle O_c such that

$$O_c | l \rangle | j \rangle = \begin{cases} | l \rangle | c_l(j) \rangle, & \text{if } l \in [0, s_0 - 1], \\ | l \rangle | j \rangle, & \text{if } l \in [s_0, s - 1], \end{cases}$$

and a data loading oracle O_{data} such that

$$O_{\text{data}} | 0 \rangle_{\text{data}} | l \rangle = \begin{cases} \left((A_l / |A|) | 0 \rangle + \sqrt{1 - |A_l / |A||^2} | 1 \rangle \right) | l \rangle, & \text{if } l \in [0, s_0 - 1], \\ | 0 \rangle | l \rangle, & \text{if } l \in [s_0, s - 1], \end{cases}$$

then

$$U_A = (I_2 \otimes I_2 \otimes D_s^\dagger \otimes I_N) (O_{\text{data}} \otimes I_{N+2}) (I_2 \otimes I_2 \otimes O_c) (I_2 \otimes O_{\text{rg}}) (I_2 \otimes I_2 \otimes D_s \otimes I_N)$$

block encodes A with the data loading cost s_0 , the subnormalisation $s|A|$ and $2 + \log_2 s$ flag qubits, shown in Table 1. Here, D_s , called a diffusion operator, is defined as

$$D_s = \underbrace{H \otimes H \otimes \cdots \otimes H}_m.$$

Proof. Applying U_A to $|0\rangle_{\text{data}} |0\rangle_{\text{del}} |0\rangle^{\otimes m} |j\rangle$ and then measuring it with $\langle 0| \langle 0| \langle 0|^{\otimes m} \langle i|$, we obtain

$$\begin{aligned} & \langle 0| \langle 0| \langle 0|^{\otimes m} \langle i| U_A |0\rangle_{\text{data}} |0\rangle_{\text{del}} |0\rangle^{\otimes m} |j\rangle \\ &= \langle 0| \langle 0| \langle 0|^{\otimes m} \langle i| (I_2 \otimes I_2 \otimes D_s^\dagger \otimes I_N) (O_{\text{data}} \otimes I_{N+2}) \\ & \quad (I_2 \otimes I_2 \otimes O_c) (I_2 \otimes O_{\text{rg}}) (I_2 \otimes I_2 \otimes D_s \otimes I_N) |0\rangle_{\text{data}} |0\rangle_{\text{del}} |0\rangle^{\otimes m} |j\rangle \\ &= \frac{1}{s} \sum_{l, l'=0}^{s-1} \langle 0| \langle 0| \langle l'| \langle i| (O_{\text{data}} \otimes I_{N+2}) (I_2 \otimes I_2 \otimes O_c) (I_2 \otimes O_{\text{rg}}) |0\rangle_{\text{data}} |0\rangle_{\text{del}} |l\rangle |j\rangle \\ &= \frac{1}{s} \sum_{l, l'=0}^{s-1} \langle 0| \langle l'| \langle i| \delta_j^l (O_{\text{data}} \otimes I_{N+2}) (I_2 \otimes I_2 \otimes O_c) |0\rangle_{\text{data}} |l\rangle |j\rangle \\ &= \frac{1}{s} \sum_{l, l'=0}^{s-1} \langle 0| \langle l'| \langle i| \delta_j^l (O_{\text{data}} \otimes I_{N+2}) |0\rangle_{\text{data}} |l\rangle |c_l(j)\rangle \\ &= \frac{1}{s} \sum_{l'=0}^{s-1} \sum_{l=0}^{s_0-1} \langle l'| \langle i| \frac{A_l}{|A|} |l\rangle |c_l(j)\rangle \\ &= \frac{1}{s} \sum_{l'=0}^{s-1} \sum_{l=0}^{s_0-1} \frac{A_l}{|A|} \delta_{l, l'} \delta_{i, c_l(j)} \\ &= \frac{a_{ij}}{s|A|}, \end{aligned}$$

where

$$\delta_j^l = \begin{cases} 1, & \text{if } l \in [0, s_0 - 1] \text{ and } j \in S_c(l), \\ 0, & \text{if } l \in [s_0, s - 1] \text{ or } j \notin S_c(l). \end{cases}$$

The data loading cost coming from O_{data} is s_0 and the subnormalisation is $\alpha = s|A|$. So the figure of merit is $s_0 s |A|$. \square

The Figure 7 shows the quantum circuit for the block encoding defined in Theorem 3.2. Our block encoding is more suitable for $s \leq N$.

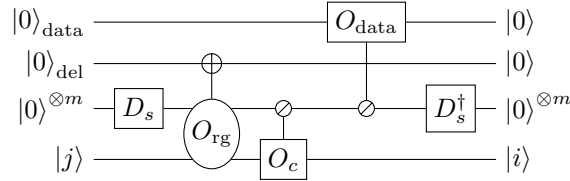

Figure 7: Quantum circuit for the block encoding of Theorem 3.2.

The oracle O_{rg} , controlled by registers $|0\rangle^{\otimes m}$ and $|j\rangle$, acts on register $|0\rangle_{\text{del}}$. The oracle O_{data} , controlled by register $|0\rangle^{\otimes m}$, acts on register $|0\rangle_{\text{data}}$. The oracle O_c , controlled by register $|0\rangle^{\otimes m}$, acts on register $|j\rangle$. Therefore, the oracle O_{data} can commute arbitrarily among the three oracles and the oracle O_{rg} should be in front of the oracle O_c .

The oracle O_{rg} is used to flag $l \in [s_0, s - 1]$ and out-of-range column indices j for $l \in [0, s_0 - 1]$, where the corresponding positions are made unneeded embeddings. At the end of the measurement, such the out-of-range embeddings will be deleted. Naturally, the oracle O_{rg} can be constructed with MC-NOT gates. We consider the function $c_l(j)$ simply as arithmetic expressions, so that we

can use a sequence of L^k -shift and R^k -shift operators to implement. Thus, the oracle O_c can be constructed.

The function of the oracle O_{data} is putting the data items into the amplitudes of quantum states. The value can be a complex number. For any $c = \text{Re}(c) + i \cdot \text{Im}(c) = \left(\frac{\text{Re}(c)}{|c|} + i \frac{\text{Im}(c)}{|c|} \right) |c| \in \mathbb{C}$ with $0 < |c| \leq 1$, there exists two angles

$$\theta = -2 \arccos \frac{\text{Re}(c)}{|c|}, \varphi = 2 \arccos |c|, \quad (3.1)$$

such that

$$c = \text{Re}(c) + i \cdot \text{Im}(c) = e^{-i\frac{\theta}{2}} \cos \frac{\varphi}{2}.$$

It inspires us to use two rotations to construct the oracle O_{data} , i.e.,

$$R_Y(\varphi) R_Z(\theta) |0\rangle = e^{-i\frac{\theta}{2}} \cos \frac{\varphi}{2} |0\rangle + e^{-i\frac{\theta}{2}} \sin \frac{\varphi}{2} |1\rangle, \quad (3.2)$$

or

$$R_X(\varphi) R_Z(\theta) |0\rangle = e^{-i\frac{\theta}{2}} \cos \frac{\varphi}{2} |0\rangle - e^{-i\frac{\theta}{2}} \sin \frac{\varphi}{2} |1\rangle.$$

Similarly, we have the following theorem, which is a counterpart of Theorem 3.2.

Theorem 3.3. *Let $A \in \mathbb{C}^{N \times N}$ be a matrix with s_0 data items, where $N = 2^n$, $2^{m-1} < s_0 \leq s = 2^m$. Let $S_r(l)$ be a set that includes all row indices of the l -th input data in A , and $r_l(i)$ be a function that gives column indices according to row indices $i \in S_r(l)$ for the l -th data item of A and remains the same function if $i \notin S_r(l)$, where $l \in [0, s_0 - 1]$. If there exists an out-of-range oracle O_{rg} such that*

$$O_{\text{rg}} |0\rangle_{\text{del}} |l\rangle |i\rangle = \begin{cases} |0\rangle |l\rangle |i\rangle, & \text{if } l \in [0, s_0 - 1] \text{ and } i \in S_r(l), \\ |1\rangle |l\rangle |i\rangle, & \text{if } l \in [s_0, s - 1] \text{ or } i \notin S_r(l), \end{cases}$$

a row oracle O_r such that

$$O_r |l\rangle |i\rangle = \begin{cases} |l\rangle |r_l(i)\rangle, & \text{if } l \in [0, s_0 - 1], \\ |l\rangle |i\rangle, & \text{if } l \in [s_0, s - 1], \end{cases}$$

and a data loading oracle O_{data} such that

$$O_{\text{data}} |0\rangle_{\text{data}} |l\rangle = \begin{cases} \left((A_l/|A|) |0\rangle + \sqrt{1 - |A_l/|A||^2} |1\rangle \right) |l\rangle, & \text{if } l \in [0, s_0 - 1], \\ |0\rangle |l\rangle, & \text{if } l \in [s_0, s - 1], \end{cases}$$

then

$$U_A = (I_2 \otimes I_2 \otimes D_s^\dagger \otimes I_N) (I_2 \otimes I_2 \otimes O_r^\dagger) (I_2 \otimes O_{\text{rg}}) (O_{\text{data}} \otimes I_{N+2}) (I_2 \otimes I_2 \otimes D_s \otimes I_N)$$

block encodes A with the data loading cost s_0 , the subnormalisation $s|A|$ and $2 + \log_2 s$ flag qubits.

Proof. The proof is similar to that of Theorem 3.2. \square

3.2 Preamplified scheme

In this section, we will use a method, i.e., preamplification [5], to improve the base scheme presented in the previous section. Such an improvement is effective in the case of a strongly varying magnitude in matrix values. It is because that by performing singular value amplification [5], the subnormalisation will be reduced but the data loading cost will increase.

Lemma 3.4 ([5]). *Let U be a block encoding of a matrix A , $\gamma > 1$, and $0 < \delta, \epsilon < \frac{1}{2}$, whose block-encoded matrix A has singular values $0 \leq \zeta_i \leq \frac{1-\delta}{\gamma}$. Then there is an efficiently computable polynomial of degree*

$$O\left(\frac{\gamma}{\delta} \log \frac{\gamma}{\delta}\right)$$

whose application to U by QSVT results in a block encoding \tilde{U} encoding \tilde{A} , an ϵ -approximation of γA . In particular, each amplified singular value $\tilde{\zeta}_i$ of \tilde{A} has relative accuracy $\epsilon: \left| \frac{\tilde{\zeta}_i}{\gamma \zeta_i} - 1 \right| \leq \epsilon$.

The first step is to split the oracle O_{data} into two parts O_{data}^p in Equation (3.3) and O_{data}^{1-p} in Equation (3.4) up to a set of $0 \leq p \leq 1$. It is due to the commutativity of the oracle O_{data} with the oracles O_{rg} and O_c .

$$O_{\text{data}}^p |0\rangle_{\text{data0}} |l\rangle = \begin{cases} \left((A_l^p / |A|^p) |0\rangle + \sqrt{1 - |A_l^p / |A|^p|^2} |1\rangle \right) |l\rangle, & \text{if } l \in [0, s_0 - 1], \\ |0\rangle |l\rangle, & \text{if } l \in [s_0, s - 1], \end{cases} \quad (3.3)$$

$$\langle 0 |_{\text{data1}} \langle l | O_{\text{data}}^{1-p} = \begin{cases} \left((A_l^{1-p} / |A|^{1-p}) \langle 0| + \sqrt{1 - |A_l^{1-p} / |A|^{1-p}|^2} \langle 1| \right) \langle l|, & \text{if } l \in [0, s_0 - 1], \\ \langle 0| \langle l|, & \text{if } l \in [s_0, s - 1]. \end{cases} \quad (3.4)$$

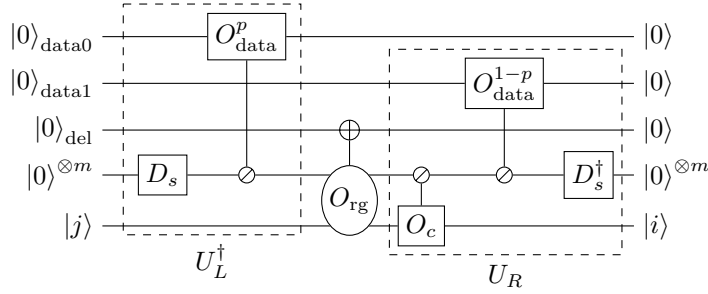

Figure 8: Split the oracle O_{data} . The left and right parts are U_L^\dagger and U_R , respectively.

As is shown in Figure 8, U_L^\dagger consists of oracles D_s and O_{data}^p while oracles O_c , O_{data}^{1-p} and D_s^\dagger form U_R . Here, the subnormalisation is not changed:

$$(\sqrt{s} |A|^p) (\sqrt{s} |A|^{1-p}) = s |A|.$$

It can be seen that both U_L^\dagger and U_R are all block encodings. The matrices that U_L^\dagger and U_R encode can be obtained in the following way:

$$\begin{aligned} & \langle 0 |_{\text{data0}} \text{Tr}_{\text{data1,del}} \left(U_L^\dagger \right) |0\rangle_{\text{data0}} |0\rangle^{\otimes m} \\ &= \langle 0 |_{\text{data0}} (O_{\text{data}}^p \otimes I_N) (I_2 \otimes D_s \otimes I_N) |0\rangle_{\text{data0}} |0\rangle^{\otimes m} \\ &= \sum_{j=0}^{N-1} \sum_{l=0}^{s-1} \frac{1}{\sqrt{s}} \langle 0 |_{\text{data0}} (O_{\text{data}}^p \otimes I_N) |0\rangle_{\text{data0}} |l\rangle |j\rangle \langle j| \\ &= \sum_{j=0}^{N-1} \left(\sum_{l=0}^{s_0-1} \frac{A_l^p}{\sqrt{s} |A|^p} |l\rangle + \sum_{l=s_0}^{s-1} \frac{|A|^p}{\sqrt{s} |A|^p} |l\rangle \right) |j\rangle \langle j| \\ &= \sum_{j=0}^{N-1} \left(\sum_{l=0}^{s_0-1} \frac{A_l^p}{\sqrt{s} |A|^p} |l\rangle |j\rangle + \sum_{l=s_0}^{s-1} \frac{|A|^p}{\sqrt{s} |A|^p} |l\rangle |j\rangle \right) \langle j| \\ &\equiv \sum_{j=0}^{N-1} |x_j\rangle \langle j|, \end{aligned} \quad (3.5)$$

and

$$\begin{aligned}
& \langle 0 |_{\text{data1}} \langle 0 |^{\otimes m} \text{Tr}_{\text{del}}(U_R) | 0 \rangle_{\text{data1}} \\
&= \langle 0 |_{\text{data1}} \langle 0 |^{\otimes m} (I_2 \otimes D_s^\dagger \otimes I_N) (O_{\text{data}}^p \otimes I_N) (I_2 \otimes O_c) | 0 \rangle_{\text{data1}} \\
&= \sum_{i=0}^{N-1} \sum_{l=0}^{s-1} \sum_{l'=0}^{s-1} \sum_{j=0}^{N-1} \frac{1}{\sqrt{s}} |i\rangle \langle 0 |_{\text{data1}} \langle l | \langle i | (O_{\text{data}}^p \otimes I_N) (I_2 \otimes O_c) | 0 \rangle_{\text{data1}} |l'\rangle |j\rangle \langle l' | \langle j | \\
&= \sum_{i=0}^{N-1} \sum_{l=0}^{s_0-1} \sum_{l'=0}^{s-1} \sum_{j=0}^{N-1} |i\rangle \langle l | \langle i | \frac{A_l^{1-p}}{\sqrt{s} |A|^{1-p}} O_c |l'\rangle |j\rangle \langle l' | \langle j | \\
&\quad + \sum_{i=0}^{N-1} \sum_{l=s_0}^{s-1} \sum_{l'=0}^{s-1} \sum_{j=0}^{N-1} |i\rangle \langle l | \langle i | \frac{|A|^{1-p}}{\sqrt{s} |A|^{1-p}} O_c |l'\rangle |j\rangle \langle l' | \langle j | \\
&= \sum_{i=0}^{N-1} |i\rangle \left(\sum_{l=0}^{s_0-1} \frac{A_l^{1-p}}{\sqrt{s} |A|^{1-p}} \langle l | \langle c_l(j) | + \sum_{l=s_0}^{s-1} \frac{|A|^{1-p}}{\sqrt{s} |A|^{1-p}} \langle l | \langle c_l(j) | \right) \\
&\equiv \sum_{i=0}^{N-1} |i\rangle \langle y_i |.
\end{aligned} \tag{3.6}$$

It can be seen that Equations (3.5) and (3.6) are in the form of singular value decomposition, whose singular values are

$$\zeta_j = \sqrt{\langle x_j | x_j \rangle} = \frac{\sqrt{\sum_{l=0}^{s_0-1} |A_l|^{2p} + (s - s_0) |A|^{2p}}}{\sqrt{s} |A|^p} = \zeta', \text{ for all } j \in [0, N - 1], \tag{3.7}$$

$$\xi_i = \sqrt{\langle y_i | y_i \rangle} = \frac{\sqrt{\sum_{l=0}^{s_0-1} |A_l|^{2-2p} + (s - s_0) |A|^{2-2p}}}{\sqrt{s} |A|^{1-p}} = \xi', \text{ for all } i \in [0, N - 1], \tag{3.8}$$

respectively. We choose the amplification factors following the method in [5]:

$$\gamma_L = \frac{1}{\sqrt[4]{2} \max_j \zeta_j} = \frac{\sqrt{s} |A|^p}{\sqrt[4]{2} \sqrt{\sum_{l=0}^{s_0-1} |A_l|^{2p} + (s - s_0) |A|^{2p}}}, \tag{3.9}$$

$$\gamma_R = \frac{1}{\sqrt[4]{2} \max_i \xi_i} = \frac{\sqrt{s} |A|^{1-p}}{\sqrt[4]{2} \sqrt{\sum_{l=0}^{s_0-1} |A_l|^{2-2p} + (s - s_0) |A|^{2-2p}}}. \tag{3.10}$$

Then, we perform singular value amplification on U_L^\dagger and U_R with amplification factors γ_L and γ_R respectively. It renders that the singular values in (3.7) and (3.8) become

$$\tilde{\zeta}' \approx \gamma_L \zeta' = \frac{1}{\sqrt[4]{2}},$$

$$\tilde{\xi}' \approx \gamma_L \xi' = \frac{1}{\sqrt[4]{2}},$$

which yields $\delta = 1 - \gamma_L \zeta' = 1 - \gamma_L \xi' = 1 - \frac{1}{\sqrt[4]{2}} \approx 0.16$. The subnormalisation now is

$$\begin{aligned}
\alpha &= \frac{(\sqrt{s} |A|^p) \cdot (\sqrt{s} |A|^{1-p})}{\gamma_L \cdot \gamma_R} \\
&= \sqrt{2 \left(\sum_{l=0}^{s_0-1} |A_l|^{2p} + (s - s_0) |A|^{2p} \right) \left(\sum_{l=0}^{s_0-1} |A_l|^{2-2p} + (s - s_0) |A|^{2-2p} \right)}.
\end{aligned}$$

Note that for $0 \leq p \leq q \leq 1$, $\beta_{\frac{1}{2}}(A) \leq \beta_p(A) \leq \beta_q(A)$. By Lemma 3.4, the data loading cost is

$$s_0 \cdot \text{amp}_{\gamma_L, \gamma_R} \approx s_0 \cdot 3 \left(\frac{\gamma_L}{\delta} \log \frac{\gamma_L}{\delta} + \frac{\gamma_R}{\delta} \log \frac{\gamma_R}{\delta} \right),$$

where the prefactor 3 is determined according to [15]. Hence, we can have the following theorem of block encoding.

Theorem 3.5. Let $A \in \mathbb{C}^{N \times N}$ be a matrix with s_0 data items, where $N = 2^n$, $2^{m-1} < s_0 \leq s = 2^m$. Let $S_c(l)$ be a set that includes all column indices of the l -th data item in A , and $c_l(j)$ be a function that gives row indices according to column indices $j \in S_c(l)$ for the l -th data item of A and remains the same function if $j \notin S_c(l)$, where $l \in [0, s_0 - 1]$. If there exists an out-of-range oracle O_{rg} such that

$$O_{\text{rg}} |0\rangle_{\text{del}} |l\rangle |j\rangle = \begin{cases} |0\rangle |l\rangle |j\rangle, & \text{if } l \in [0, s_0 - 1] \text{ and } j \in S_c(l), \\ |1\rangle |l\rangle |j\rangle, & \text{if } l \in [s_0, s - 1] \text{ or } j \notin S_c(l), \end{cases}$$

and two oracles U_L^\dagger, U_R defined in Figure (8), $\text{Amp}(U_L^\dagger)$ and $\text{Amp}(U_R)$ are obtained from U_L^\dagger and U_R by performing singular value amplification with the amplification factors γ_L in Equation (3.9) and γ_R in Equation (3.10), respectively, then U_A represented by the circuit shown in Figure 9 is a block encoding of A with the data loading cost $s_0 \cdot \text{amp}_{\gamma_L, \gamma_R}$, the subnormalisation

$$\sqrt{2}\beta_p(A) = \sqrt{2} \sqrt{\left(\sum_{l=0}^{s_0-1} |A_l|^{2p} + (s - s_0) |A|^{2p} \right) \left(\sum_{l=0}^{s_0-1} |A_l|^{2-2p} + (s - s_0) |A|^{2-2p} \right)}$$

and $3 + \log_2 s$ flag qubits, shown in Table 1. Especially, if $p = \frac{1}{2}$, then $\gamma_L = \gamma_R = \gamma$ and the figure of merit $\sqrt{2}s_0 \cdot \text{amp}_{\gamma, \gamma} \cdot \beta_{\frac{1}{2}}(A)$ is the smallest in this scheme.

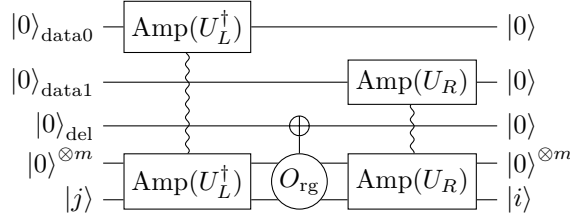

Figure 9: Quantum circuit for block encoding of the preamplified scheme.

3.3 PREP/UNPREP scheme

In this section, we will use another method of state preparation to improve the base scheme in sec. 3.1. For a pure state $|\psi\rangle = \frac{1}{\sqrt{\sum_{i=0}^{s-1} |A_i|^2}} \sum_{i=0}^{s-1} A_i |i\rangle$ with arbitrary coefficients in $s = 2^m$ dimensions, we can use a sequence of multiplexed rotations to prepare it, where the rotation angles can be computed from the amplitudes ([25], [26]). For example, for a state

$$|\psi\rangle = \frac{1}{\sqrt{|A_0|^2 + |A_1|^2 + |A_2|^2 + |A_3|^2}} (A_0 |0\rangle |0\rangle + A_1 |0\rangle |1\rangle + A_2 |1\rangle |0\rangle + A_3 |1\rangle |1\rangle), \quad (3.11)$$

where $A_0, A_1, A_2, A_3 \in \mathbb{C}$, there exists angles $\theta_0, \theta_1, \theta_2, \theta_3, \varphi_1, \varphi_2, \varphi_3$ and we can construct the circuit in Figure 10 to prepare the state.

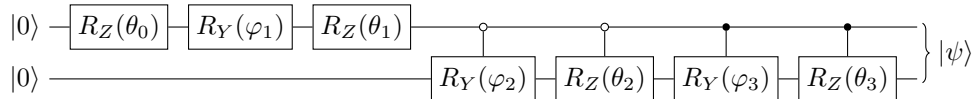

Figure 10: Quantum circuit of state preparation for the state in Equation (3.11).

And the multiplexed rotations on s values with angles θ_i can be decomposed into s C-NOT gates and s single qubit rotations with angles $\tilde{\theta}_i$, which can be computed from θ_i through a Wash-Hadamard transformation ([25], [27]). An example is shown in Figure 11.

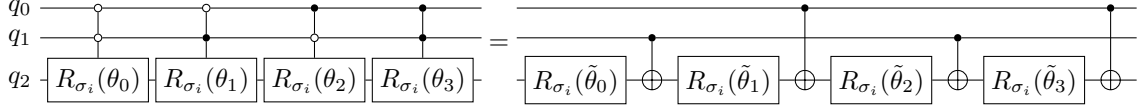

Figure 11: The decomposition of multiplexed rotations on 4 values, where $\sigma_i \in \{X, Y, Z\}$.

Thus, the circuit in Figure 10 can be decomposed into 4 single qubit R_Z rotations, 3 single qubit R_Y rotations and 4 C-NOT gates. For the preparation of a state with $s = 2^m$ ($m \geq 2$) complex values, one needs s single qubit R_Z rotations, $s - 1$ single qubit R_Y rotations and $2s - 4$ C-NOT gates. By state preparation, the resulting subnormalisation of block encoding can be reduced. Similarly, selecting $0 \leq p \leq 1$, we can split the oracle O_{data} into two parts:

$$O_{\text{data}}^p |0\rangle_{\text{data0}} |l\rangle = \begin{cases} \left((A_l^p / |A|^p) |0\rangle + \sqrt{1 - |A_l^p / |A|^p|^2} |1\rangle \right) |l\rangle, & \text{if } l \in [0, s_0 - 1], \\ |0\rangle |l\rangle, & \text{if } l \in [s_0, s - 1], \end{cases}$$

$$\langle 0 |_{\text{data1}} \langle l | O_{\text{data}}^{1-p} = \begin{cases} \left((A_l^{1-p} / |A|^{1-p}) \langle 0 | + \sqrt{1 - |A_l^{1-p} / |A|^{1-p}|^2} \langle 1 | \right) \langle l |, & \text{if } l \in [0, s_0 - 1], \\ \langle 0 | \langle l |, & \text{if } l \in [s_0, s - 1]. \end{cases}$$

Then we combine each part with operator D_s . Note that

$$\begin{aligned} \langle 0 | O_{\text{data}}^p (I_2 \otimes D_s) |0\rangle_{\text{data0}} |0\rangle^{\otimes m} &= \frac{1}{\sqrt{s}} \left(\sum_{l=0}^{s_0-1} \frac{A_l^p}{|A|^p} |l\rangle + \sum_{l=s_0}^{s-1} |l\rangle \right) \\ &= \frac{\sqrt{\sum_{l=0}^{s_0-1} |A_l|^{2p}}}{\sqrt{s} |A|^p} \cdot \frac{1}{\sqrt{\sum_{l=0}^{s_0-1} |A_l|^{2p}}} \sum_{l=0}^{s_0-1} A_l^p |l\rangle + \frac{1}{\sqrt{s}} \sum_{l=s_0}^{s-1} |l\rangle \\ &\equiv X_1 \cdot \frac{1}{\sqrt{\sum_{l=0}^{s_0-1} |A_l|^{2p}}} \sum_{l=0}^{s_0-1} A_l^p |l\rangle + \frac{1}{\sqrt{s}} \sum_{l=s_0}^{s-1} |l\rangle, \end{aligned} \quad (3.12)$$

$$\begin{aligned} \langle 0 |_{\text{data1}} \langle 0 |^{\otimes m} (I_2 \otimes D_s^\dagger) O_{\text{data}}^{1-p} |0\rangle &= \frac{1}{\sqrt{s}} \left(\sum_{l=0}^{s_0-1} \frac{A_l^{1-p}}{|A|^{1-p}} \langle l | + \sum_{l=s_0}^{s-1} \langle l | \right) \\ &= \frac{\sqrt{\sum_{l=0}^{s_0-1} |A_l|^{2-2p}}}{\sqrt{s} |A|^{1-p}} \cdot \frac{1}{\sqrt{\sum_{l=0}^{s_0-1} |A_l|^{2-2p}}} \sum_{l=0}^{s_0-1} A_l^{1-p} \langle l | + \frac{1}{\sqrt{s}} \sum_{l=s_0}^{s-1} \langle l | \\ &\equiv X_2 \cdot \frac{1}{\sqrt{\sum_{l=0}^{s_0-1} |A_l|^{2-2p}}} \sum_{l=0}^{s_0-1} A_l^{1-p} \langle l | + \frac{1}{\sqrt{s}} \sum_{l=s_0}^{s-1} \langle l |. \end{aligned} \quad (3.13)$$

In the right-hand sides of Equations (3.12) and (3.13), $\frac{1}{\sqrt{s}} \sum_{l=s_0}^{s-1} |l\rangle$ and $\frac{1}{\sqrt{s}} \sum_{l=s_0}^{s-1} \langle l |$ are out-of-range embeddings. What we need are

$$\frac{1}{\sqrt{\sum_{l=0}^{s_0-1} |A_l|^{2p}}} \sum_{l=0}^{s_0-1} A_l^p |l\rangle$$

and

$$\frac{1}{\sqrt{\sum_{l=0}^{s_0-1} |A_l|^{2-2p}}} \sum_{l=0}^{s_0-1} A_l^{1-p} \langle l |,$$

which are all normalised quantum states with zero amplitudes for $l \in [s_0, s-1]$. Therefore, using state preparation, we can construct oracles PREP and UNPREP with some multiplexed rotations to replace oracles O_{data} and D_s :

$$\begin{aligned} \text{PREP } |0\rangle^{\otimes m} &= \frac{1}{\sqrt{\sum_{l=0}^{s_0-1} |A_l|^{2p}}} \left(\sum_{l=0}^{s_0-1} A_l^p |l\rangle + \sum_{l=s_0}^{s-1} 0 |l\rangle \right), \\ \langle 0|^{\otimes m} \text{UNPREP} &= \frac{1}{\sqrt{\sum_{l=0}^{s_0-1} |A_l|^{2-2p}}} \left(\sum_{l=0}^{s_0-1} A_l^{1-p} \langle l| + \sum_{l=s_0}^{s-1} 0 \langle l| \right). \end{aligned}$$

It can be seen that the subnormalisations are reduced. By state preparation, we obtain the following theorem.

Theorem 3.6. *Let $A \in \mathbb{C}^{N \times N}$ be a matrix with s_0 data items, where $N = 2^n$, $2^{m-1} < s_0 \leq s = 2^m$. Let $S_c(l)$ be a set that includes all column indices of the l -th data item in A , and $c_l(j)$ be a function that gives row indices according to column indices $j \in S_c(l)$ for the l -th data item of A and remains the same function if $j \notin S_c(l)$, where $l \in [0, s_0 - 1]$. If there exists an out-of-range oracle O_{rg} such that*

$$O_{\text{rg}} |0\rangle_{\text{del}} |l\rangle |j\rangle = \begin{cases} |0\rangle |l\rangle |j\rangle, & \text{if } l \in [0, s_0 - 1] \text{ and } j \in S_c(l), \\ |1\rangle |l\rangle |j\rangle, & \text{if } l \in [s_0, s - 1] \text{ or } j \notin S_c(l), \end{cases}$$

a column oracle O_c such that

$$O_c |l\rangle |j\rangle = \begin{cases} |l\rangle |c_l(j)\rangle, & \text{if } l \in [0, s_0 - 1], \\ |l\rangle |j\rangle, & \text{if } l \in [s_0, s - 1], \end{cases}$$

and two state preparation oracles PREP, UNPREP such that

$$\begin{aligned} \text{PREP } |0\rangle^{\otimes m} &= \frac{1}{\sqrt{\sum_{l=0}^{s_0-1} |A_l|^{2p}}} \left(\sum_{l=0}^{s_0-1} A_l^p |l\rangle + \sum_{l=s_0}^{s-1} 0 |l\rangle \right), \\ \langle 0|^{\otimes m} \text{UNPREP} &= \frac{1}{\sqrt{\sum_{l=0}^{s_0-1} |A_l|^{2-2p}}} \left(\sum_{l=0}^{s_0-1} A_l^{1-p} \langle l| + \sum_{l=s_0}^{s-1} 0 \langle l| \right), \end{aligned}$$

where $0 \leq p \leq 1$, then

$$U_A = (I_2 \otimes \text{UNPREP} \otimes I_N) (I_2 \otimes O_c) O_{\text{rg}} (I_2 \otimes \text{PREP} \otimes I_N)$$

block encodes A with the data loading cost $2s$, the subnormalisation

$$\alpha_p(A) = \sqrt{\sum_{l=0}^{s_0-1} |A_l|^{2-2p} \sum_{l=0}^{s_0-1} |A_l|^{2p}}$$

and $1 + \log_2 s$ flag qubits, shown in Table 1. Especially, if $p = \frac{1}{2}$, then the figure of merit is the smallest, i.e., $2s \cdot \alpha_{\frac{1}{2}}(A)$, in this scheme and it is more smaller, i.e., $s \cdot \alpha_{\frac{1}{2}}(A)$, for $A \in \mathbb{R}^{N \times N}$.

Proof. Applying U_A to $|0\rangle_{\text{del}}|0\rangle^{\otimes m}|j\rangle$ and then measuring it with $\langle 0|\langle 0|^{\otimes m}\langle i|$, we obtain

$$\begin{aligned}
& \langle 0|\langle 0|^{\otimes m}\langle i|U_A|0\rangle_{\text{del}}|0\rangle^{\otimes m}|j\rangle \\
&= \langle 0|\langle 0|^{\otimes m}\langle i|(I_2 \otimes \text{UNPREP} \otimes I_N)(I_2 \otimes O_c)O_{rg}(I_2 \otimes \text{PREP} \otimes I_N)|0\rangle_{\text{del}}|0\rangle^{\otimes m}|j\rangle \\
&= \frac{1}{\sqrt{\sum_{l'=0}^{s_0-1}|A_{l'}|^{2-2p}}\sqrt{\sum_{l=0}^{s_0-1}|A_l|^{2p}}}\sum_{l',l=0}^{s_0-1}\langle 0|\langle l'|\langle i|A_{l'}^{1-p}A_l^p(I_2 \otimes O_c)O_{rg}|0\rangle_{\text{del}}|l\rangle|j\rangle \\
&= \frac{1}{\sqrt{\sum_{l'=0}^{s_0-1}|A_{l'}|^{2-2p}}\sqrt{\sum_{l=0}^{s_0-1}|A_l|^{2p}}}\sum_{l',l=0}^{s_0-1}\langle l'|\langle i|A_{l'}^{1-p}A_l^p\delta_j^l(I_2 \otimes O_c)|l\rangle|j\rangle \\
&= \frac{1}{\sqrt{\sum_{l'=0}^{s_0-1}|A_{l'}|^{2-2p}}\sqrt{\sum_{l=0}^{s_0-1}|A_l|^{2p}}}\sum_{l',l=0}^{s_0-1}\langle l'|\langle i|A_{l'}^{1-p}A_l^p\delta_j^l|l\rangle|c_l(j)\rangle \\
&= \frac{1}{\sqrt{\sum_{l'=0}^{s_0-1}|A_{l'}|^{2-2p}}\sqrt{\sum_{l=0}^{s_0-1}|A_l|^{2p}}}\sum_{l',l=0}^{s_0-1}A_{l'}^{1-p}A_l^p\delta_j^l\delta_{l',l}i_{c_l(j)} \\
&= \frac{1}{\sqrt{\sum_{l=0}^{s_0-1}|A_l|^{2-2p}}\sqrt{\sum_{l=0}^{s_0-1}|A_l|^{2p}}}\cdot a_{ij}.
\end{aligned}$$

Since oracles PREP and UNPREP need data loading, the data loading cost is $2s$. The subnormalisation is the product of two factors in PREP and UNPREP:

$$\alpha_p(A) = \sqrt{\sum_{l=0}^{s_0-1}|A_l|^{2-2p}\sum_{l=0}^{s_0-1}|A_l|^{2p}} \leq s_0|A|.$$

Note that for $0 \leq p \leq q \leq 1$, $\alpha_{\frac{1}{2}}(A) \leq \alpha_p(A) \leq \alpha_q(A)$. Taking $p = \frac{1}{2}$, if $A \in \mathbb{R}^{N \times N}$, then the oracle UNPREP can be replaced by PREP[†]. Thus, the data loading cost only need s and the subnormalisation $\alpha_{\frac{1}{2}}(A) = \sum_{l=0}^{s_0-1}|A_l|$ is the smallest. \square

If $A \in \mathbb{R}^{N \times N}$, it is better to choose the PREP/UNPREP scheme with $p = \frac{1}{2}$ rather than the base scheme in sec. 3.1 due to the lower figure of merit of the former. In [15], their PREP/UNPREP scheme of block encoding has a figure of merit $2\sqrt{S_r S_c} \alpha_p(A)$ while it is only feasible for $s \leq S_r, S_c$. Therefore, their figure of merit is larger than ours. The quantum circuit for block encoding in Theorem 3.6 is shown in Figure 12.

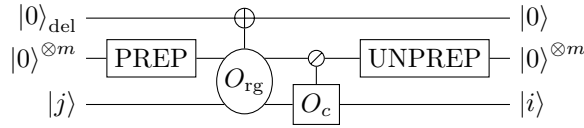

Figure 12: Quantum circuit for block encoding of the PREP/UNPREP scheme.

3.4 Hermitian block encoding

A Hermitian block encoding is a block encoding whose U_A is not only unitary but also Hermitian. This requires that the encoded matrix A also needs to be Hermitian.

Definition 3.7 (Hermitian block encoding([28])). *Let U_A be an (α, a, ϵ) -block-encoding of A . If U_A is also Hermitian, then it is called an (α, a, ϵ) -Hermitian-block-encoding of A . When $\epsilon = 0$, it is called an (α, a) -Hermitian-block-encoding. The set of all (α, a, ϵ) -Hermitian-block-encoding of A is denoted by $\text{HBE}_{\alpha,a}(A, \epsilon)$, and we define $\text{HBE}_{\alpha,a}(A) = \text{HBE}_{\alpha,a}(A, 0)$.*

Since the base scheme, preamplified scheme and PREP/UNPREP scheme are not Hermitian in general, we need a method to make them Hermitian. Thanks to the framework of Hermitian

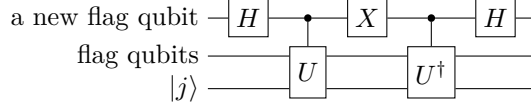

Figure 13: The framework of Hermitian block encoding.

block encoding in [15], see Figure 13, a simple way to construct the Hermitian block encodings is replacing U in the framework with our block encoding schemes. However, as analyzed in [15], it needs a new flag qubit and doubles the gate complexity / data loading cost while the controlling of U and U^\dagger add extra cost. When $s \leq N$, Camps et.al [14] gave a Hermitian block encoding of Hermitian matrices with the constraint that each input data should appear in all columns, whose figure of merit is $s^2 |A|$. By adding a new flag qubit and the oracle O_{rg} , we make the Hermitian block encoding scheme in [14] without the constraint.

Theorem 3.8. *Let $A \in \mathbb{C}^{N \times N}$ be a Hermitian matrix with s_0 data items, where $2^{m-1} < s_0 \leq s = 2^m \leq N = 2^n$. Let $S_c(l)$ be a set that includes all column indices of the l -th data item in A , and $c_l(j)$ be a function that gives row indices according to column indices $j \in S_c(l)$ for the l -th data item of A and remains the same function if $j \notin S_c(l)$, where $l \in [0, s_0 - 1]$. If there exists an out-of-range oracle O_{rg} such that*

$$O_{\text{rg}} |0\rangle_{\text{del}} |l\rangle |j\rangle = \begin{cases} |0\rangle |l\rangle |j\rangle, & \text{if } l \in [0, s_0 - 1] \text{ and } j \in S_c(l), \\ |1\rangle |l\rangle |j\rangle, & \text{if } l \in [s_0, s - 1] \text{ or } j \notin S_c(l), \end{cases}$$

a column oracle O_c such that

$$O_c |l\rangle |j\rangle = \begin{cases} |l\rangle |c_l(j)\rangle, & \text{if } l \in [0, s_0 - 1], \\ |l\rangle |j\rangle, & \text{if } l \in [s_0, s - 1], \end{cases}$$

and a data oracle O_{data} such that

$$O_{\text{data}} |0\rangle_{\text{data1}} |i\rangle |j\rangle = \left(\left(\sqrt{|a_{ij}| / |A|^{1/2}} \right) |0\rangle + \sqrt{1 - |a_{ij}| / |A|} |1\rangle \right) |i\rangle |j\rangle,$$

then U_A represented by the circuit shown in Figure 14 is a Hermitian block encoding of A with the data loading cost s_0 , the subnormalisation $s |A|$ and $3 + \log_2 N$ flag qubits. Here, D_s is defined as

$$D_s = I_2 \otimes \cdots \otimes I_2 \otimes \underbrace{H \otimes \cdots \otimes H}_m. \quad (3.14)$$

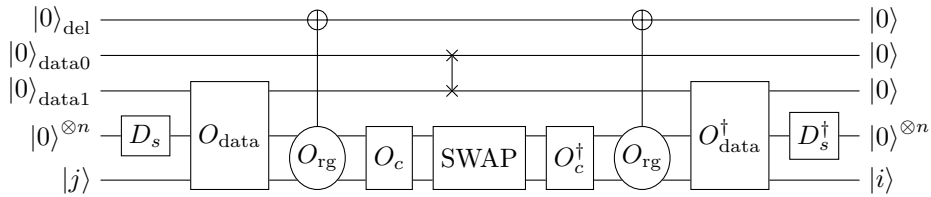

Figure 14: Quantum circuit for the Hermitian block encoding of Theorem 3.8.

In Figure 14, the oracle O_c acts on the register $|0\rangle^{\otimes n}$, so that only oracles O_{data} and O_{rg} commute. Combining D_s and the oracle O_{data} together, it can be viewed as a form of singular value decomposition and then we perform by singular value amplification. Do the same to D_s and the oracle O_{data}^\dagger . After that, the subnormalisation is reduced to $\sqrt{2}\beta_{1/2}(A)$. The data loading cost is $s_0 \cdot \frac{1}{2} \text{amp}_{\gamma_L, \gamma_R}$ because the left-hand and right-hand sides only differ by a conjugate transpose. The total improvement is not heavy. Now, we use the method of state preparation to further improve it. Similarly, in Figure 14, it is already the case of $p = \frac{1}{2}$. We can replace D_s and the

oracles O_{data} in the left with PREP while D_s and the oracle O_c^\dagger in the right side are replaced with PREP^\dagger , since both sides have the relationship of conjugate transpose.

$$\text{PREP } |0\rangle^{\otimes n} = \frac{1}{\sqrt{\sum_{l=0}^{s_0-1} |A_l|}} \left(\sum_{l=0}^{s_0-1} \sqrt{A_l} |l\rangle + \sum_{l=s_0}^{s-1} 0 |l\rangle \right).$$

$$\langle 0|^{\otimes n} \text{PREP}^\dagger = \frac{1}{\sqrt{\sum_{l=0}^{s_0-1} |A_l|}} \left(\sum_{l=0}^{s_0-1} \sqrt{A_l^*} \langle l| + \sum_{l=s_0}^{s-1} 0 \langle l| \right).$$

Theorem 3.9. *Let $A \in \mathbb{C}^{N \times N}$ be a matrix with s_0 data items, where $2^{m-1} < s_0 \leq s = 2^m \leq N = 2^n$. Let $S_c(l)$ be a set that includes all column indices of the l -th data item in A , and $c_l(j)$ be a function that gives row indices according to column indices $j \in S_c(l)$ for the l -th data item of A and remains the same function if $j \notin S_c(l)$, where $l \in [0, s_0 - 1]$. If there exists an out-of-range oracle O_{rg} such that*

$$O_{\text{rg}} |0\rangle_{\text{del}} |l\rangle |j\rangle = \begin{cases} |0\rangle |l\rangle |j\rangle, & \text{if } l \in [0, s_0 - 1] \text{ and } j \in S_c(l), \\ |1\rangle |l\rangle |j\rangle, & \text{if } l \in [s_0, s - 1] \text{ or } j \notin S_c(l), \end{cases}$$

a column oracle O_c such that

$$O_c |l\rangle |j\rangle = \begin{cases} |l\rangle |c_l(j)\rangle, & \text{if } l \in [0, s_0 - 1], \\ |l\rangle |j\rangle, & \text{if } l \in [s_0, s - 1], \end{cases},$$

and a state preparation oracle PREP such that

$$\text{PREP } |0\rangle^{\otimes n} = \frac{1}{\sqrt{\sum_{l=0}^{s_0-1} |A_l|}} \left(\sum_{l=0}^{s_0-1} \sqrt{A_l} |l\rangle + \sum_{l=s_0}^{s-1} 0 |l\rangle \right),$$

then U_A represented by the circuit shown in Figure 15 is a Hermitian block encoding of A with the data loading cost $2s$, the subnormalisation $\alpha_{\frac{1}{2}}(A)$ and $1 + \log_2 N$ flag qubits. And D_s is defined in Equation (3.14).

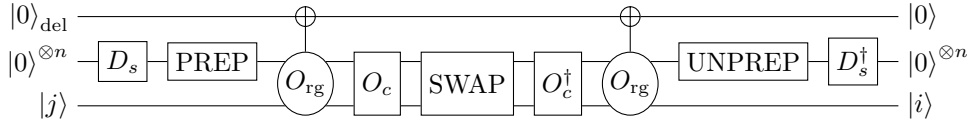

Figure 15: Quantum circuit of the Hermitian PREP/UNPREP scheme in Theorem 3.9.

4 Examples of generalized eigenvalue equation $AV = BV\Sigma$ in ocean acoustics

The problem of solving sound fields arising from ocean acoustics becomes the problem of solving GEEs $AV = BV\Sigma$. And we obtain concrete matrices A, B whose dimensions are related to the gridding of depth of ice and seawater. In practice, the dimensions are quite large. For simplicity, we give two specific matrices $A, B \in \mathbb{C}^{32 \times 32}$ and show how to block encoding them by the base

scheme and implement their quantum circuits. Below are the form of the matrices A and B .

$$B = (b_{ij}) = \begin{bmatrix} 0 & 0 & 0 & 0 & 0 & 0 & \cdots & 0 & 0 & 0 \\ 0 & 0 & 0 & 0 & 0 & 0 & \cdots & 0 & 0 & 0 \\ 0 & 0 & 0 & 0 & 0 & 0 & \cdots & 0 & 0 & 0 \\ b_1 & 0 & 0 & 0 & b_1 & 0 & \cdots & 0 & 0 & 0 \\ b_2 & 0 & 0 & 0 & b_2 & 0 & \cdots & 0 & 0 & 0 \\ 0 & 0 & b_3 & 0 & 0 & 0 & \cdots & 0 & 0 & 0 \\ \vdots & \vdots & \vdots & \vdots & \vdots & \vdots & & \vdots & \vdots & \vdots \\ 0 & 0 & 0 & 0 & 0 & 0 & \cdots & b_2 & 0 & 0 \\ 0 & 0 & 0 & 0 & 0 & 0 & \cdots & 0 & 0 & b_3 \\ 0 & 0 & 0 & 0 & 0 & 0 & \cdots & 0 & 0 & 0 \end{bmatrix} \oplus \text{diag}(0, b_4, b_5, \dots, b_5, b_6), \quad (4.1)$$

$$A = (a_{ij}) = \begin{bmatrix} A_1 & A_3 \\ A_3^T & A_2 \end{bmatrix}, \quad (4.2)$$

$$A_1 = \begin{bmatrix} 0 & 0 & a_4 & 0 & 0 & \cdots & 0 & 0 & 0 & 0 \\ 0 & 0 & 0 & a_4 & 0 & \cdots & 0 & 0 & 0 & 0 \\ a_1 & a_3 & a_5 & 0 & a_8 & \cdots & 0 & 0 & 0 & 0 \\ 0 & a_1 & 0 & a_6 & 0 & \cdots & 0 & 0 & 0 & 0 \\ a_2 & 0 & a_1 & a_7 & a_2 & \cdots & 0 & 0 & 0 & 0 \\ \vdots & \vdots & \vdots & \vdots & \vdots & & \vdots & \vdots & \vdots & \vdots \\ 0 & 0 & 0 & 0 & 0 & \cdots & a_2 & 0 & a_8 & 0 \\ 0 & 0 & 0 & 0 & 0 & \cdots & 0 & a_4 & 0 & 0 \\ 0 & 0 & 0 & 0 & 0 & \cdots & 0 & 0 & a_4 & a_4 \\ 0 & 0 & 0 & 0 & 0 & \cdots & a_9 & 0 & 0 & a_{10} \end{bmatrix}, \quad (4.3)$$

$$A_2 = \begin{bmatrix} a_{11} & a_4 & \cdots & 0 & 0 & 0 \\ a_4 & a_{11} & \cdots & 0 & 0 & 0 \\ \vdots & \vdots & & \vdots & \vdots & \vdots \\ 0 & 0 & \cdots & a_{11} & a_4 & 0 \\ 0 & 0 & \cdots & a_4 & a_{11} & a_4 \\ 0 & 0 & \cdots & 0 & a_{12} & a_{13} \end{bmatrix}, \quad A_3 = \begin{bmatrix} 0 & 0 & \cdots & 0 \\ \vdots & \vdots & & \vdots \\ 0 & 0 & \cdots & 0 \\ a_4 & 0 & \cdots & 0 \end{bmatrix},$$

where

$$b_{ij} = \begin{cases} b_1 \in \mathbb{R}, & (i, j) \in \{(i, j) : i = j + 3, j \in [1, 17], j \bmod 4 = 1\} \\ & \cup \{(i, j) : i = j - 1, j \in [5, 21], j \bmod 4 = 1\} \\ b_2 \in \mathbb{C}, & (i, j) \in \{(i, j) : i = j + 4, j \in [1, 17], j \bmod 4 = 1\} \\ & \cup \{(i, j) : i = j, j \in [5, 21], j \bmod 4 = 1\} \\ b_3 \in \mathbb{R}, & (i, j) \in \{(i, j) : i = j + 3, j \in [3, 19], j \bmod 4 = 3\} \\ & \cup \{(i, j) : i = j - 1, j \in [7, 23], j \bmod 4 = 3\} \\ b_4 \in \mathbb{R}, & (i, j) = (25, 25) \\ b_5 \in \mathbb{R}, & (i, j) \in \{(i, j) : i = j, j \in [26, 31]\} \\ b_6 \in \mathbb{R}, & (i, j) = (32, 32) \end{cases}. \quad (4.4)$$

$$a_{ij} = \begin{cases} a_1 \in \mathbb{R}, & (i, j) \in \{(i, j) : i = j + 2, j \in [1, 20]\} \\ a_2 \in \mathbb{C}, & (i, j) \in \{(i, j) : i = j + 4, j \in [1, 18], j \bmod 4 = 1 \text{ or } 2\} \\ & \cup \{(i, j) : i = j, j \in [5, 22], j \bmod 4 = 1 \text{ or } 2\} \\ a_3 \in \mathbb{R}, & (i, j) \in \{(i, j) : i = j + 1, j \in [2, 18], j \bmod 4 = 2\} \\ & \cup \{(i, j) : i = j - 3, j \in [6, 22], j \bmod 4 = 2\} \\ a_4 \in \mathbb{R}, & (i, j) \in \{(i, j) : i = j - 1, j \in [25, 32]\} \cup \{(i, j) : i = j + 1, j \in [25, 30]\} \\ & \cup \{(1, 3), (2, 4), (23, 23), (24, 24)\} \\ a_5 \in \mathbb{C}, & (i, j) \in \{(i, j) : i = j, j \in [3, 19], j \bmod 4 = 3\} \\ & \cup \{(i, j) : i = j - 4, j \in [7, 23], j \bmod 4 = 3\} \\ a_6 \in \mathbb{C}, & (i, j) \in \{(i, j) : i = j, j \in [4, 20], j \bmod 4 = 0\} \\ & \cup \{(i, j) : i = j - 4, j \in [8, 24], j \bmod 4 = 0\} \\ a_7 \in \mathbb{R}, & (i, j) \in \{(i, j) : i = j + 1, j \in [4, 20], j \bmod 4 = 0\} \\ & \cup \{(i, j) : i = j - 3, j \in [8, 24], j \bmod 4 = 0\} \\ a_8 \in \mathbb{R}, & (i, j) \in \{(i, j) : i = j - 2, j \in [5, 24]\} \\ a_9 \in \mathbb{R}, & (i, j) = (25, 22) \\ a_{10} \in \mathbb{R}, & (i, j) = (25, 25) \\ a_{11} \in \mathbb{R}, & (i, j) \in \{(i, j) : i = j, j \in [26, 31]\} \\ a_{12} \in \mathbb{R}, & (i, j) = (32, 31) \\ a_{13} \in \mathbb{R}, & (i, j) = (32, 32) \end{cases} . \quad (4.5)$$

4.1 Block encoding of the matrix B

In this section, we will show how to construct the explicit circuits of oracles O_c , O_{rg} and O_{data} to implement the block encoding for the matrix B .

4.1.1 The O_c circuit

Rather than using an l to mark b_6 , we treat b_6 as b_5 and make a correction in the end. This reduces the number of qubits needed to represent l and leads to that the number of input data is 8. Hence, we can use 3 qubits to encode l in the function $c_l(j)$. And the function $c_l(j)$ and set $S_c(l)$, which define the row index of the l th nonzero element in the j th column and the set including all column indices of the l nonzero element, respectively, can be written as

$$c_l(j) = \begin{cases} j + 3, & j \in S_c(0) = \{j \in [0, 16] : j \bmod 4 = 0\}, & l = 0 & (b_1) \\ j - 1, & j \in S_c(1) = \{j \in [4, 20] : j \bmod 4 = 0\}, & l = 1 & (b_1) \\ j + 3, & j \in S_c(2) = \{j \in [2, 18] : j \bmod 4 = 2\}, & l = 2 & (b_3) \\ j - 1, & j \in S_c(3) = \{j \in [6, 22] : j \bmod 4 = 2\}, & l = 3 & (b_3) \\ j + 4, & j \in S_c(4) = \{j \in [0, 16] : j \bmod 4 = 0\}, & l = 4 & (b_2) \\ j, & j \in S_c(5) = \{j \in [4, 20] : j \bmod 4 = 0\}, & l = 5 & (b_2) \\ j, & j \in S_c(6) = \{24\}, & l = 6 & (b_4) \\ j, & j \in S_c(7) = \{j \in [25, 31]\}, & l = 7 & (b_5, b_6) \end{cases} \quad (4.6)$$

where j and l have binary representations $[j_8 \dots j_1 j_0]$ and $[l_2 l_1 l_0]$, respectively. Note that the range of j in (4.4) is $[1, 32]$, but the range of j in (4.6) is $[0, 31]$. In this function, there are operations implementing $j - 1$, $j + 3$ and $j + 4$. We firstly perform the $j + 4$ operation for $l \in \{0, 2, 4, 6\}$, then do the $j - 1$ operation for $l \in \{0, 1, 2, 3\}$. After that, the $j - 4$ operation is done for $l = 6$ to make a modification. Therefore, we implement the O_c circuit in Figure 16. And the corresponding QCLAB code is shown in Appendix A.1.

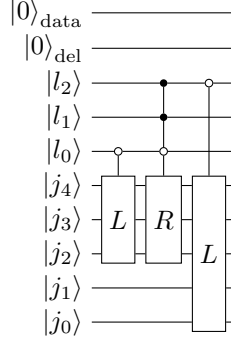

Figure 16: The O_c circuit for the matrix B in Equation (4.1).

4.1.2 The O_{rg} circuit

The function of the O_{rg} circuit is flag column indices $j \notin S_c(l)$ for $l \in [0, s_0 - 1]$ by introducing a flag qubit $|0\rangle_{\text{del}}$ and using MC-NOT gates. Because the column sparsity of non-zero matrix elements in B , first, we can flip $|0\rangle_{\text{del}}$ if $j \in S_c(l)$. Then, perform the Pauli- X operation on the $|0\rangle_{\text{del}}$. Therefore, the positions which are made out-of-range embeddings are flagged. If $|0\rangle_{\text{del}} = |1\rangle$, the data of corresponding positions are unneeded and deleted after measurement. It's clear that the construction of the O_{rg} circuit depends on how $c_l(j)$ and $S_c(l)$ are constructed.

According to the function (4.6), if $j \bmod 4 = 0$ ($j \bmod 4 = 1$ or $j \bmod 4 = 2$ or $j \bmod 4 = 3$) and the binary representation of j is $[j_n \cdots j_1 j_0]$, then $(j_1, j_0) = (0, 0)$ ($(j_1, j_0) = (0, 1)$ or $(j_1, j_0) = (1, 0)$ or $(j_1, j_0) = (1, 1)$). The circuits are shown in Figure 17.

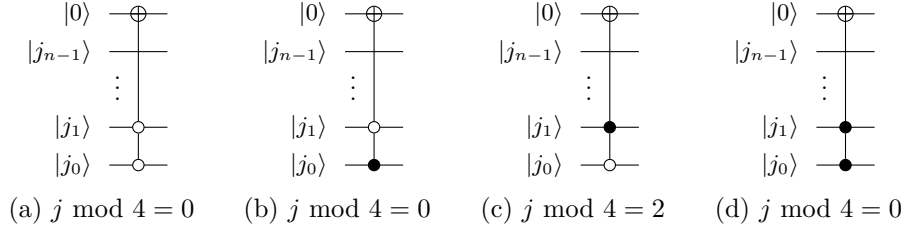

Figure 17: The quantum circuits for $j \bmod 4 = 0$, $j \bmod 4 = 1$, $j \bmod 4 = 2$ and $j \bmod 4 = 3$.

Therefore, the complete O_{rg} circuit can be constructed in Figure 18. The first MC-NOT gate means that if $l = 0$ or 8 , $j \in [0, 15]$ and $j \bmod 4 = 0$, flip the flag qubit $|0\rangle_{\text{del}}$. The second MC-NOT gate means that if $l = 0$ or 8 and $j = 16$, flip $|0\rangle_{\text{del}}$. The third MC-NOT gate means that if $l = 1$ or 9 , $j \in [0, 31]$ and $j \bmod 4 = 0$, $|0\rangle_{\text{del}}$ is flipped. The same goes for the rest of MC-NOT gates. The O_{rg} circuit can be implemented in QCLAB presented in Appendix A.1.

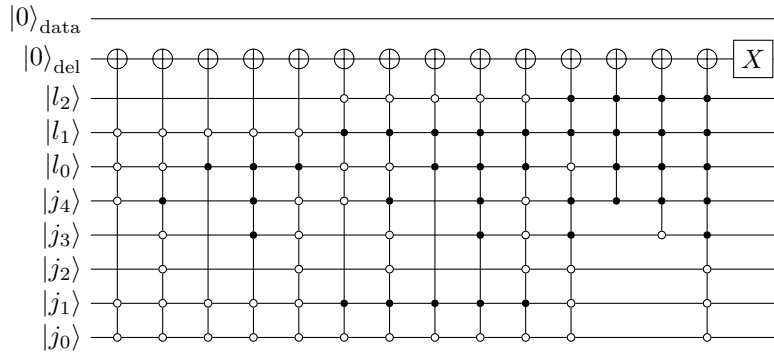

Figure 18: The O_{rg} circuit for the matrix B in Equation (4.1).

4.1.3 The O_{data} circuit

Since we use rotations R_Y and R_Z to implement the oracle O_{data} , the rotation angles can be computed easily by Equations (3.1) and (3.2), which are

$$\varphi_1 = 2 \arccos b_1, \varphi_2 = 2 \arccos |b_2|, \theta_2 = -2 \arccos \frac{\text{Re}(b_2)}{|b_2|}, \varphi_3 = 2 \arccos b_3,$$

$$\varphi_4 = 2 \arccos b_4, \varphi_5 = 2 \arccos b_5, \varphi_6 = 2 \arccos b_6.$$

Therefore, the O_{data} circuit can be constructed as follows:

1. Controlled by $(l_2, l_1) = (0, 0)$, the rotation angle φ_1 is used to place b_1 for $j \in S_c(0) \cup S_c(1)$.
2. Controlled by $(l_2, l_1) = (0, 1)$, the rotation angles φ_2 and θ_2 are used to place b_2 for $j \in S_c(2) \cup S_c(3)$.
3. Controlled by $(l_2, l_1) = (1, 0)$, the rotation angle φ_3 is used to place b_3 for $j \in S_c(4) \cup S_c(5)$.
4. Controlled by $l = 6$, the rotation angle φ_4 is used to place b_4 for $j \in S_c(6)$.
5. Controlled by $l = 7$, the rotation angle φ_5 is used to place b_5 for $j \in S_c(7)$.
6. We use rotation angle $-\varphi_5 + \varphi_6$ controlled by $(l, j) = (7, 31)$ to correct the root to b_6 .

This approach leads to an O_{data} circuit that has the structure in Figure 19. We use $O_{\text{data}0}$ (the first six controlled rotations) and $O_{\text{data}1}$ (the last controlled rotation) to refer the rotations only controlled by register $|l\rangle$ and rotations controlled by registers $|l\rangle, |j\rangle$ in O_{data} respectively. The function of $O_{\text{data}0}$ is to embed values, while $O_{\text{data}1}$ is used to correct values. We implement the O_{data} circuit in QCLAB shown in Appendix A.1.

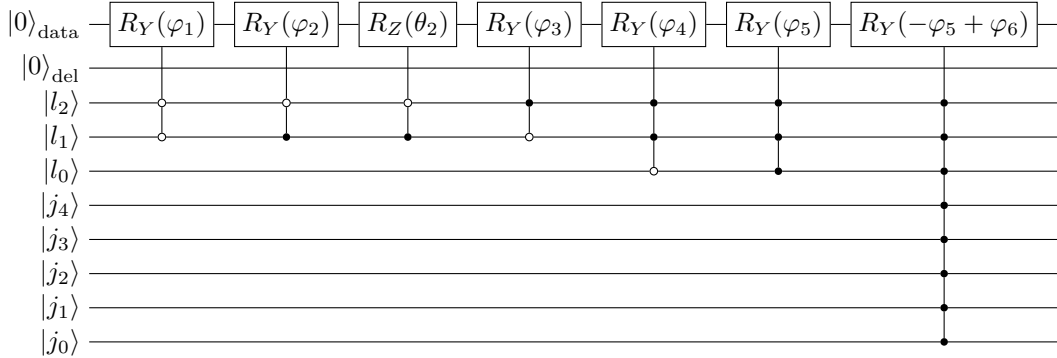

Figure 19: The O_{data} circuit for the matrix B in Equation (4.1).

All $R_Y(\varphi_i)$ rotations in the $O_{\text{data}0}$ can be decomposed into 8 C-NOT gates and 8 single qubit $R_Y(\tilde{\varphi}_j)$ rotations, whose angles $\tilde{\varphi}_j$ can be computed from φ_i through a Wash-Hadamard transformation ([25], [27]). Since $R_X(\theta), R_Y(\theta), R_Z(\theta) \in \text{SU}(2)$, the $R_Y(-\varphi_5 + \varphi_6)$ rotation in the $O_{\text{data}1}$ can be decomposed into three single qubit gates and two MC-NOT gates while the MC-NOT gates can be further decomposed into some C-NOT gates ([29], [30], [31]).

4.1.4 The complete quantum circuit

Combining O_c , O_{del} and O_{data} circuits giving previously, the complete quantum circuit for a block encoding of the matrix B in Equation (4.1) is given in Figure 20.

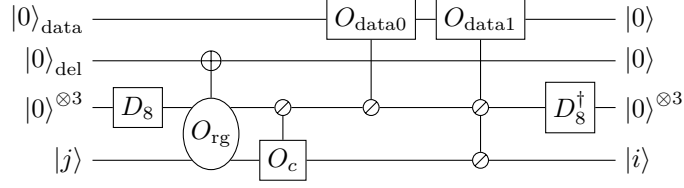

Figure 20: The complete quantum circuit for the matrix B in Equation (4.1).

4.2 Block encoding of the matrix A

In this section, we will construct the explicit circuit of block encoding for the matrix A in Equations (4.2) and (4.3).

4.2.1 The O_c circuit

We take a_4, a_{10}, a_{13} on the diagonal of matrix A as a_{11}, a_4 at the positions of $(i, j) \in \{(1, 3), (2, 4)\}$ as a_8 , and a_{12} as a_3 . And the resulting errors will be corrected at last. Thus, we can use 4 and 9 qubits to encode l and j , respectively. The set $S_c(l)$ and function $c_l(j)$ associated with A are denoted below.

$$c_l(j) = \begin{cases} j-4, & j \in S_c(0) = \{j \in [7, 23] : j \bmod 4 = 3\}, & l = 0 & (a_6) \\ j-3, & j \in S_c(1) = \{j \in [7, 23] : j \bmod 4 = 3\}, & l = 1 & (a_7) \\ j+1, & j \in S_c(2) = \{j \in [1, 17] : j \bmod 4 = 1\}, & l = 2 & (a_3) \\ j-3, & j \in S_c(3) = \{j \in [5, 21] : j \bmod 4 = 1\}, & l = 3 & (a_3) \\ j, & j \in S_c(4) = \{j \in [2, 18] : j \bmod 4 = 2\}, & l = 4 & (a_5) \\ j-4, & j \in S_c(5) = \{j \in [6, 22] : j \bmod 4 = 2\}, & l = 5 & (a_5) \\ j+1, & j \in S_c(6) = \{j \in [24, 30]\}, & l = 6 & (a_4, a_{12}) \\ j-1, & j \in S_c(7) = \{j \in [24, 31]\}, & l = 7 & (a_4) \\ j+4, & j \in S_c(8) = \{j \in [0, 17] : j \bmod 4 = 0 \text{ or } 1\}, & l = 8 & (a_2) \\ j, & j \in S_c(9) = \{j \in [4, 21] : j \bmod 4 = 0 \text{ or } 1\}, & l = 9 & (a_2) \\ j+2, & j \in S_c(10) = \{j \in [0, 19]\}, & l = 10 & (a_1) \\ j-2, & j \in S_c(11) = \{j \in [2, 23]\}, & l = 11 & (a_4, a_8) \\ j, & j \in S_c(12) = \{j \in [3, 19] : j \bmod 4 = 3\}, & l = 12 & (a_6) \\ j+1, & j \in S_c(13) = \{j \in [3, 19] : j \bmod 4 = 3\}, & l = 13 & (a_7) \\ j+3, & j \in S_c(14) = \{j = 21\}, & l = 14 & (a_9) \\ j, & j \in S_c(15) = \{j \in [22, 31]\}, & l = 15 & (a_4, a_{10}, a_{11}, a_{13}) \end{cases} \quad (4.7)$$

We can implement the O_c circuit for $c_l(j)$ in Equation (4.7) as follows. The corresponding QCLAB code is presented in Appendix A.2.

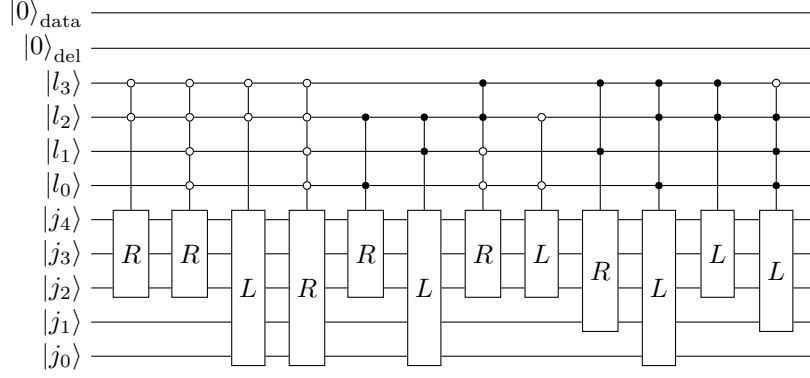

Figure 21: The O_c circuit for the matrix A in Equation (4.2).

4.2.2 The O_{rg} circuit

We use a flag qubit $|0\rangle_{\text{del}}$ and MC-NOT gates to judge whether $j \in S_c(l)$ for each l . According to $c_l(j)$ and $S_c(l)$ defined in Equation (4.7), we can construct the explicit O_{rg} circuit in Figure 22. And the corresponding QCLAB code is shown in Appendix A.2.

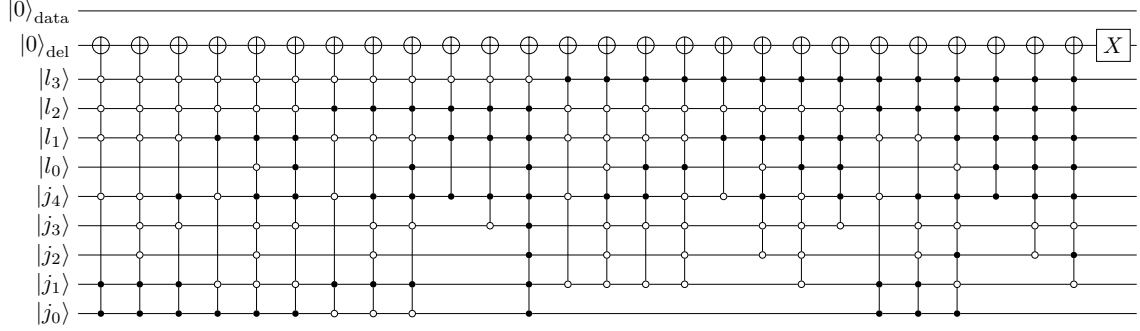

Figure 22: The O_{rg} circuit for the matrix A in Equation (4.2).

4.2.3 The O_{data} circuit

By Equations (3.1) and (3.2), we can obtain the rotation angles

$$\begin{aligned} \varphi_1 &= 2 \arccos(a_1), \varphi_2 = 2 \arccos|a_2|, \theta_2 = -2 \arccos \frac{\text{Re}(a_2)}{|a_2|}, \varphi_3 = 2 \arccos(a_3), \\ \varphi_4 &= 2 \arccos(a_4), \varphi_5 = 2 \arccos|a_5|, \theta_5 = -2 \arccos \frac{\text{Re}(a_5)}{|a_5|}, \varphi_6 = 2 \arccos|a_6|, \\ \theta_6 &= -2 \arccos \frac{\text{Re}(a_6)}{|a_6|}, \varphi_7 = 2 \arccos(a_7), \varphi_8 = 2 \arccos(a_8), \varphi_9 = 2 \arccos(a_9), \\ \varphi_{10} &= 2 \arccos(a_{10}), \varphi_{11} = 2 \arccos(a_{11}), \varphi_{12} = 2 \arccos(a_{12}), \varphi_{13} = 2 \arccos(a_{13}). \end{aligned}$$

Therefore, the construction process of the O_{data} circuit is shown as follows:

1. The first step is to embed the values for each l in (4.7). We use rotation angles φ_6 and θ_6 , controlled by $l = 0$, to place a_6 ; use rotation angle φ_7 , controlled by $l = 1$, to place a_7 ; use rotation angle φ_3 , controlled by $(l_3, l_2, l_1) = (0, 0, 1)$, to place a_3 ; use rotation angles φ_5 and θ_5 , controlled by $(l_3, l_2, l_1) = (0, 1, 0)$, to place a_5 ; use rotation angle φ_4 , controlled by $(l_3, l_2, l_1) = (0, 1, 1)$, to place a_4 ; use rotation angles φ_2 and θ_2 , controlled by $(l_3, l_1, l_1) = (1, 0, 0)$, to place a_2 ; use rotation angle φ_1 , controlled by $l = 10$, to place a_1 ; use rotation angle φ_8 , controlled by $l = 11$, to place a_8 ; use rotation angle φ_6 , controlled by $l = 12$, to place a_6 ; use rotation angle φ_7 , controlled by $l = 13$, to place a_7 . use rotation angle φ_9 , controlled by $l = 14$, to place a_9 ; use rotation angle φ_{11} , controlled by $l = 15$, to place a_{11} .

- The second step is to correct the values of some positions. We use rotation angles $-\varphi_4 + \varphi_{12}$, controlled by $(l, j) = (6, 30)$, to correct a_4 to a_{12} ; use rotation angles $-\varphi_8 + \varphi_4$, controlled by $(l, j_4, j_3, j_2, j_1) = (11, 0, 0, 0, 1)$, to correct a_8 to a_4 ; use rotation angles $-\varphi_{11} + \varphi_4$, controlled by $(l, j_4, j_3, j_2, j_1) = (15, 1, 1, 0, 0)$, to correct a_{11} to a_4 ; use rotation angles $-\varphi_{11} + \varphi_{10}$, controlled by $(l, j) = (15, 24)$, to correct a_{11} to a_{10} ; use rotation angles $-\varphi_{11} + \varphi_{13}$, controlled by $(l, j) = (15, 31)$, to correct a_{11} to a_{13} .

Hence, the circuits of $O_{\text{data}0}$ in Figure 23 whose rotations are only controlled by register $|l\rangle$ and $O_{\text{data}1}$ in Figure 24 whose rotations are controlled by registers $|l\rangle$ and $|j\rangle$ can be implemented by the following. The corresponding QCLAB code is given in Appendix A.2.

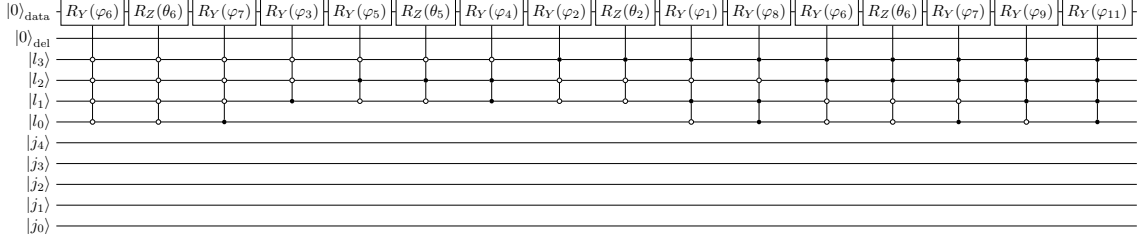

Figure 23: The $O_{\text{data}0}$ circuit for the matrix A in Equation (4.2).

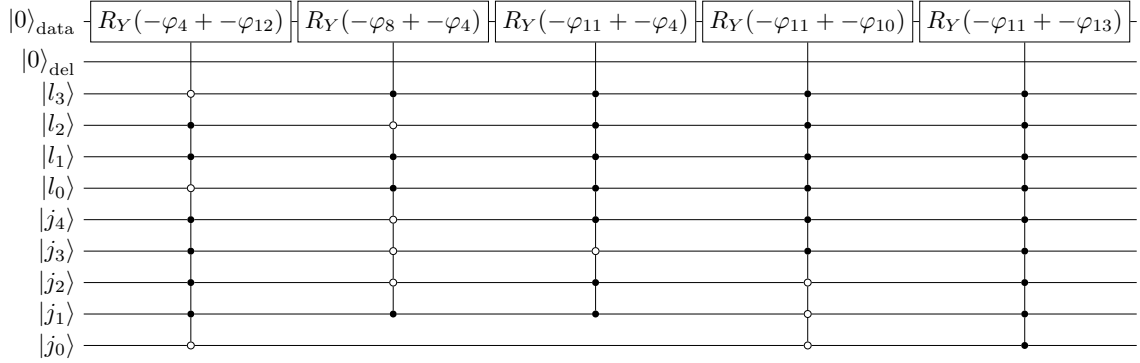

Figure 24: The $O_{\text{data}1}$ circuit for the matrix A in Equation (4.2).

Similarly, all $R_Y(\varphi_i)$ rotations in the $O_{\text{data}0}$ can be decomposed into 16 C-NOT gates and 16 single qubit $R_Y(\tilde{\varphi}_j)$ rotations with angles $\tilde{\varphi}_j$ computed from φ_i through a Wash-Hadamard transformation ([25], [27]). And all R_Y rotations in the $O_{\text{data}1}$ can be decomposed into C-NOT gates and single qubit gates in $SU(2)$ ([29], [30], [31]).

4.2.4 The complete quantum circuit

Combining the O_{rg} , O_{data} and O_c circuits giving previously, we obtain the complete circuit of block encoding for the matrix A in Equation (4.2) shown in Figure 25.

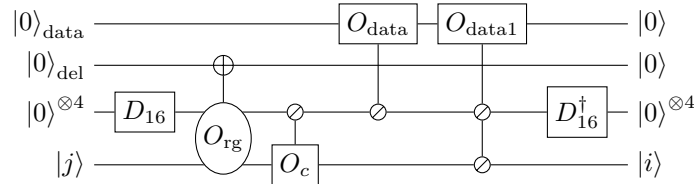

Figure 25: The complete quantum circuit for the matrix A in Equation (4.2).

Acknowledgments

This work is supported by the Stable Supporting Fund of Acoustic Science and Technology Laboratory JCKYS2024604SSJS001, JCKYS2023604SSJS017.

Bibliography

- [1] David Deutsch and Richard Jozsa. Rapid solution of problems by quantum computation. *Proceedings of the Royal Society of London. Series A: Mathematical and Physical Sciences*, 439(1907):553–558, 1992. DOI: [10.1016/j.asoc.2022.109844](https://doi.org/10.1016/j.asoc.2022.109844).
- [2] Lov K Grover. Quantum mechanics helps in searching for a needle in a haystack. *Physical review letters*, 79(2):325, 1997. DOI: [10.1103/PhysRevLett.79.325](https://doi.org/10.1103/PhysRevLett.79.325).
- [3] P. Shor. Algorithms for quantum computation: discrete logarithms and factoring. In *Proceedings 35th Annual Symposium on Foundations of Computer Science*, pages 124–134, 1994. DOI: [10.1109/SFCS.1994.365700](https://doi.org/10.1109/SFCS.1994.365700).
- [4] Aram W Harrow, Avinatan Hassidim, and Seth Lloyd. Quantum algorithm for linear systems of equations. *Physical review letters*, 103(15):150502, 2009. DOI: [10.1103/PhysRevLett.103.150502](https://doi.org/10.1103/PhysRevLett.103.150502).
- [5] András Gilyén, Yuan Su, Guang Hao Low, and Nathan Wiebe. Quantum singular value transformation and beyond: exponential improvements for quantum matrix arithmetics. In *Proceedings of the 51st Annual ACM SIGACT Symposium on Theory of Computing*, STOC 2019, page 193–204, New York, NY, USA, 2019. Association for Computing Machinery. ISBN 9781450367059. DOI: [10.1145/3313276.3316366](https://doi.org/10.1145/3313276.3316366).
- [6] John M Martyn, Zane M Rossi, Andrew K Tan, and Isaac L Chuang. Grand unification of quantum algorithms. *PRX quantum*, 2(4):040203, 2021. DOI: [10.1103/PRXQuantum.2.040203](https://doi.org/10.1103/PRXQuantum.2.040203).
- [7] Guang Hao Low and Isaac L Chuang. Hamiltonian simulation by qubitization. *Quantum*, 3: 163, 2019. DOI: [10.22331/q-2019-07-12-163](https://doi.org/10.22331/q-2019-07-12-163).
- [8] Joran van Apeldoorn and András Gilyén. Improvements in Quantum SDP-Solving with Applications. In *46th International Colloquium on Automata, Languages, and Programming (ICALP 2019)*, volume 132, pages 99:1–99:15. Schloss Dagstuhl – Leibniz-Zentrum für Informatik, 2019. DOI: [10.4230/LIPIcs.ICALP.2019.99](https://doi.org/10.4230/LIPIcs.ICALP.2019.99).
- [9] Iordanis Kerenidis and Anupam Prakash. Quantum gradient descent for linear systems and least squares. *Physical Review A*, 101(2):022316, 2020. DOI: [10.1103/PhysRevA.101.022316](https://doi.org/10.1103/PhysRevA.101.022316).
- [10] Shantanav Chakraborty, András Gilyén, and Stacey Jeffery. The Power of Block-Encoded Matrix Powers: Improved Regression Techniques via Faster Hamiltonian Simulation. In *46th International Colloquium on Automata, Languages, and Programming (ICALP 2019)*, volume 132, pages 33:1–33:14. Schloss Dagstuhl – Leibniz-Zentrum für Informatik, 2019. DOI: [10.4230/LIPIcs.ICALP.2019.33](https://doi.org/10.4230/LIPIcs.ICALP.2019.33).
- [11] B. David Clader, Alexander M. Dalzell, Nikitas Stamatopoulos, Grant Salton, Mario Berta, and William J. Zeng. Quantum resources required to block-encode a matrix of classical data. *IEEE Transactions on Quantum Engineering*, 3:1–23, 2022. DOI: [10.1109/TQE.2022.3231194](https://doi.org/10.1109/TQE.2022.3231194).
- [12] Quynh T. Nguyen, Bobak T. Kiani, and Seth Lloyd. Block-encoding dense and full-rank kernels using hierarchical matrices: applications in quantum numerical linear algebra. *Quantum*, 6:876, 2022. DOI: [10.22331/q-2022-12-13-876](https://doi.org/10.22331/q-2022-12-13-876).
- [13] Haoya Li, Hongkang Ni, and Lexing Ying. On efficient quantum block encoding of pseudo-differential operators. *Quantum*, 7:1031, 2023. DOI: [10.22331/q-2023-06-02-1031](https://doi.org/10.22331/q-2023-06-02-1031).
- [14] Daan Camps, Lin Lin, Roel Van Beeumen, and Chao Yang. Explicit quantum circuits for block encodings of certain sparse matrices. *SIAM Journal on Matrix Analysis and Applications*, 45(1):801–827, 2024. DOI: [10.1137/22M1484298](https://doi.org/10.1137/22M1484298).
- [15] Christoph S underhauf, Earl Campbell, and Joan Camps. Block-encoding structured matrices for data input in quantum computing. *Quantum*, 8:1226, 2024. DOI: [10.22331/q-2024-01-11-1226](https://doi.org/10.22331/q-2024-01-11-1226).
- [16] Finn B Jensen, William A Kuperman, Michael B Porter, Henrik Schmidt, and Alexandra Tolstoy. *Computational ocean acoustics*, volume 2011. Springer, 2011. DOI: [10.1007/978-1-4419-8678-8](https://doi.org/10.1007/978-1-4419-8678-8).

- [17] Keiiti Aki and Paul G Richards. *Quantitative Seismology, Second Edition*. University Science Books, 2002. DOI: [10.1007/978-1-4419-8678-8](https://doi.org/10.1007/978-1-4419-8678-8).
- [18] C. Pekeris. Theory of propagation of explosive sound in shallow water. *Geological Society of America Memoirs*, 27:1–116, 1948. DOI: [10.1130/MEM27-2-p1](https://doi.org/10.1130/MEM27-2-p1).
- [19] Jeffrey B Parker and Ilon Joseph. Quantum phase estimation for a class of generalized eigenvalue problems. *Physical Review A*, 102(2):022422, 2020. DOI: [10.1103/PhysRevA.102.022422](https://doi.org/10.1103/PhysRevA.102.022422).
- [20] Jin-Min Liang, Shu-Qian Shen, Ming Li, and Shao-Ming Fei. Quantum algorithms for the generalized eigenvalue problem. *Quantum Information Processing*, 21:1–22, 2022. DOI: <https://doi.org/10.1007/s11128-021-03370-z>.
- [21] Changpeng Shao and Jin-Peng Liu. Solving generalized eigenvalue problems by ordinary differential equations on a quantum computer. *Proceedings of the Royal Society A*, 478(2262):20210797, 2022. DOI: [10.1098/rspa.2021.0797](https://doi.org/10.1098/rspa.2021.0797).
- [22] Juan Carlos Garcia-Escartin. Finding eigenvectors with a quantum variational algorithm. *arXiv preprint arXiv:2311.13543*, 2023. DOI: [10.48550/arXiv.2311.13543](https://doi.org/10.48550/arXiv.2311.13543).
- [23] Mi-Ra Hwang, Eylee Jung, MuSeong Kim, and DaeKil Park. Euclidean time method in generalized eigenvalue equation. *Quantum Information Processing*, 2024. DOI: [10.1007/s11128-024-04275-3](https://doi.org/10.1007/s11128-024-04275-3).
- [24] Daan Camps and Roel Van Beeumen. QCLAB, 2021. URL <https://github.com/QuantumComputingLab/qclab>.
- [25] V.V. Shende, S.S. Bullock, and I.L. Markov. Synthesis of quantum-logic circuits. volume 25, pages 1000–1010, 2006. DOI: [10.1109/TCAD.2005.855930](https://doi.org/10.1109/TCAD.2005.855930).
- [26] Guang Hao Low, Vadym Kliuchnikov, and Luke Schaeffer. Trading t-gates for dirty qubits in state preparation and unitary synthesis. *arXiv preprint arXiv:1812.00954*, 2018. DOI: [10.48550/arXiv.1812.00954](https://doi.org/10.48550/arXiv.1812.00954).
- [27] Mikko Möttönen, Juha J Vartiainen, Ville Bergholm, and Martti M Salomaa. Quantum circuits for general multiqubit gates. *Physical review letters*, 93(13):130502, 2004. DOI: [10.1103/PhysRevLett.93.130502](https://doi.org/10.1103/PhysRevLett.93.130502).
- [28] Lin Lin. Lecture notes on quantum algorithms for scientific computation. *arXiv preprint arXiv:2201.08309*, 2022. DOI: [10.48550/arXiv.2201.08309](https://doi.org/10.48550/arXiv.2201.08309).
- [29] Adriano Barenco, Charles H. Bennett, Richard Cleve, David P. DiVincenzo, Norman Margolus, Peter Shor, Tycho Sleator, John A. Smolin, and Harald Weinfurter. Elementary gates for quantum computation. *Phys. Rev. A*, 52:3457–3467, Nov 1995. DOI: [10.1103/PhysRevA.52.3457](https://doi.org/10.1103/PhysRevA.52.3457).
- [30] Baptiste Claudon, Julien Zylberman, César Feniou, Fabrice Debbasch, Alberto Peruzzo, and Jean-Philip Piquemal. Polylogarithmic-depth controlled-not gates without ancilla qubits. *arXiv preprint arXiv:2312.13206*, 2023. DOI: [10.48550/arXiv.2312.13206](https://doi.org/10.48550/arXiv.2312.13206).
- [31] Rafaella Vale, Thiago Melo D. Azevedo, Ismael C. S. Araújo, Israel F. Araujo, and Adenilton J. da Silva. Circuit decomposition of multicontrolled special unitary single-qubit gates. *IEEE Transactions on Computer-Aided Design of Integrated Circuits and Systems*, 43(3):802–811, 2024. DOI: [10.1109/TCAD.2023.3327102](https://doi.org/10.1109/TCAD.2023.3327102).

A QCLAB codes of quantum circuit

In this section, we will present the QCLAB codes of quantum circuits for matrices A, B encoded in sec.

4. The QCLAB Toolbox can be downloaded from <https://github.com/QuantumComputingLab/explicit-block-encodings>.

A.1 QCLAB codes for the matrix B

QCLAB code of the O_c circuit in Figure 16:

```
circuit = qclab.QCircuit(10);
circuit.push_back(leftshift(10, [5, 6, 7], 4, 0));
circuit.push_back(rightshift(10, [5, 6, 7], [2, 3, 4], [1, 1, 0]));
circuit.push_back(rightshift(10, [5, 6, 7, 8, 9], 2, 0));
circuit.draw();
```

QCLAB code of the O_{rg} circuit in Figure 18:

```

circuit = qclab.QCircuit(10);
circuit.push_back(qclab.qgates.MCX([3,4,5,8,9],1,[0,0,0,0,0]));
circuit.push_back(qclab.qgates.MCX([3,4,5,6,7,8,9],1,[0,0,1,0,0,0,0]));
circuit.push_back(qclab.qgates.MCX([3,4,8,9],1,[0,1,0,0]));
circuit.push_back(qclab.qgates.MCX([3,4,5,6,8,9],1,[0,1,1,1,0,0]));
circuit.push_back(qclab.qgates.MCX([3,4,5,6,7,8,9],1,[0,1,0,0,0,0,0]));
circuit.push_back(qclab.qgates.MCX([2,3,4,5,8,9],1,[0,1,0,0,1,0]));
circuit.push_back(qclab.qgates.MCX([2,3,4,5,6,7,8,9],1,[0,1,0,1,0,0,1,0]));
circuit.push_back(qclab.qgates.MCX([2,3,4,8,9],1,[0,1,1,1,0]));
circuit.push_back(qclab.qgates.MCX([2,3,4,5,6,8,9],1,[0,1,1,1,1,0]));
circuit.push_back(qclab.qgates.MCX([2,3,4,5,6,7,8,9],1,[0,1,1,0,0,0,1,0]));
circuit.push_back(qclab.qgates.MCX([2,3,4,5,6,7,8,9],1,[1,1,0,1,1,0,0,0]));
circuit.push_back(qclab.qgates.MCX([2,3,4,5],1,[1,1,1,1]));
circuit.push_back(qclab.qgates.MCX([2,3,4,5,6],1,[1,1,1,1,0]));
circuit.push_back(qclab.qgates.MCX([2,3,4,5,6,7,8,9],1,[1,1,1,1,1,0,0,0]));
circuit.push_back(qclab.qgates.PauliX(1));
circuit.draw();

```

QCLAB code of the O_{data} circuit in Figure 19:

```

circuit = qclab.QCircuit(14);
circuit.push_back(qclab.qgates.MCRotationY([2,3],0,[0,0],phi1));
circuit.push_back(qclab.qgates.MCRotationY([2,3],0,[0,1],phi2));
circuit.push_back(qclab.qgates.MCRotationZ([2,3],0,[0,1],theta2));
circuit.push_back(qclab.qgates.MCRotationY([2,3],0,[1,0],phi3));
circuit.push_back(qclab.qgates.MCRotationY([2,3,4],0,[1,1,0],phi4));
circuit.push_back(qclab.qgates.MCRotationY([2,3,4],0,[1,1,1],phi5));
circuit.push_back(qclab.qgates.MCRotationY([2,3,4,5,6,7,8,9],0,...
[1,1,1,1,1,1,1,1],-phi5+phi6));
circuit.draw();

```

A.2 QCLAB codes for the matrix A

QCLAB codes of the O_c circuit in Figure 21:

```

circuit = qclab.QCircuit(11);
circuit.push_back(rightshift(11,[6,7,8],[2,3],[0,0]));
circuit.push_back(rightshift(11,[6,7,8],[2,3,4,5],[0,0,0,0]));
circuit.push_back(leftshift(11,[6,7,8,9,10],[2,3],[0,0]));
circuit.push_back(rightshift(11,[6,7,8,9,10],[2,3,4,5],[0,0,0,0]));
circuit.push_back(rightshift(11,[6,7,8],[3,5],[1,1]));
circuit.push_back(leftshift(11,[6,7,8,9,10],[3,4],[1,1]));
circuit.push_back(rightshift(11,[6,7,8],[2,3,4,5],[1,1,0,0]));
circuit.push_back(leftshift(11,[6,7,8],[3,5],[0,0]));
circuit.push_back(rightshift(11,[6,7,8,9],[2,4],[1,1]));
circuit.push_back(leftshift(11,[6,7,8,9,10],[2,3,5],[1,1,1]));
circuit.push_back(leftshift(11,[6,7,8],[2,3],[1,1]));
circuit.push_back(leftshift(11,[6,7,8,9],[2,3,4,5],[0,1,1,1]));
circuit.draw();

```

QCLAB code of the O_{rg} circuit in Figure 22:

```

circuit = qclab.QCircuit(11);
circuit.push_back(qclab.qgates.MCX([2,3,4,6,9,10],1,[0,0,0,0,1,1]));
circuit.push_back(qclab.qgates.MCX([2,3,4,6,7,8,9,10],1,...
[0,0,0,0,0,0,1,1]));
circuit.push_back(qclab.qgates.MCX([2,3,4,6,7,9,10],1,[0,0,0,1,0,1,1]));
circuit.push_back(qclab.qgates.MCX([2,3,4,6,9,10],1,[0,0,1,0,0,1]));
circuit.push_back(qclab.qgates.MCX([2,3,4,5,6,7,8,9,10],1,...
[0,0,1,0,1,0,0,0,1]));
circuit.push_back(qclab.qgates.MCX([2,3,4,5,6,7,9,10],1,...

```

```

        [0,0,1,1,1,0,0,1]));
circuit.push_back(qclab.qgates.MCX([2,3,4,6,9,10],1,[0,1,0,0,1,0]));
circuit.push_back(qclab.qgates.MCX([2,3,4,6,7,8,9,10],1,...
        [0,1,0,1,0,0,1,0]));
circuit.push_back(qclab.qgates.MCX([2,3,4,5,6,7,9,10],1,...
        [0,1,0,1,1,0,1,0]));
circuit.push_back(qclab.qgates.MCX([2,3,4,6],1,[0,1,1,1]));
circuit.push_back(qclab.qgates.MCX([2,3,4,6,7],1,[0,1,1,1,0]));
circuit.push_back(qclab.qgates.MCX([2,3,4,5,6,7,8,9,10],1,...
        [0,1,1,1,1,1,1,1]));
circuit.push_back(qclab.qgates.MCX([2,3,4,6,9],1,[1,0,0,0,0]));
circuit.push_back(qclab.qgates.MCX([2,3,4,5,6,7,8,9],1,[1,0,0,0,1,0,0,0]));
circuit.push_back(qclab.qgates.MCX([2,3,4,5,6,7,9],1,[1,0,0,1,1,0,0]));
circuit.push_back(qclab.qgates.MCX([2,3,4,5,6,7,8,9],1,[1,0,0,1,0,0,0,0]));
circuit.push_back(qclab.qgates.MCX([2,3,4,6],1,[1,0,1,0]));
circuit.push_back(qclab.qgates.MCX([2,3,4,5,6,7,8],1,[1,0,1,0,1,0,0]));
circuit.push_back(qclab.qgates.MCX([2,3,4,5,6,7,8,9],1,[1,0,1,1,0,0,0,0]));
circuit.push_back(qclab.qgates.MCX([2,3,4,5,6,7],1,[1,0,1,1,1,0]));
circuit.push_back(qclab.qgates.MCX([2,3,4,6,9,10],1,[1,1,0,0,1,1]));
circuit.push_back(qclab.qgates.MCX([2,3,4,6,7,8,9,10],1,...
        [1,1,0,1,0,0,1,1]));
circuit.push_back(qclab.qgates.MCX([2,3,4,5,6,7,8,9,10],1,...
        [1,1,1,0,1,0,1,0,1]));
circuit.push_back(qclab.qgates.MCX([2,3,4,5,6],1,[1,1,1,1,1]));
circuit.push_back(qclab.qgates.MCX([2,3,4,5,6,7,8],1,[1,1,1,1,1,0,0]));
circuit.push_back(qclab.qgates.MCX([2,3,4,5,6,7,8,9],1,[1,1,1,1,1,0,1,0]));
circuit.push_back(qclab.qgates.PauliX(1));
circuit.draw();

```

QCLAB code of the O_{data} circuit in Figure 23 and 24:

```

circuit = qclab.QCircuit(11);
circuit.push_back(qclab.qgates.MCRotationY([2,3,4,5],0,[0,0,0,0],phi6));
circuit.push_back(qclab.qgates.MCRotationZ([2,3,4,5],0,[0,0,0,0],theta6));
circuit.push_back(qclab.qgates.MCRotationY([2,3,4,5],0,[0,0,0,1],phi7));
circuit.push_back(qclab.qgates.MCRotationY([2,3,4],0,[0,0,1],phi3));
circuit.push_back(qclab.qgates.MCRotationY([2,3,4],0,[0,1,0],phi5));
circuit.push_back(qclab.qgates.MCRotationZ([2,3,4],0,[0,1,0],theta5));
circuit.push_back(qclab.qgates.MCRotationY([2,3,4],0,[0,1,1],phi4));
circuit.push_back(qclab.qgates.MCRotationY([2,3,4],0,[1,0,0],phi2));
circuit.push_back(qclab.qgates.MCRotationZ([2,3,4],0,[1,0,0],theta2));
circuit.push_back(qclab.qgates.MCRotationY([2,3,4,5],0,[1,0,1,0],phi1));
circuit.push_back(qclab.qgates.MCRotationY([2,3,4,5],0,[1,0,1,1],phi8));
circuit.push_back(qclab.qgates.MCRotationY([2,3,4,5],0,[1,1,0,0],phi6));
circuit.push_back(qclab.qgates.MCRotationZ([2,3,4,5],0,[1,1,0,0],theta6));
circuit.push_back(qclab.qgates.MCRotationY([2,3,4,5],0,[1,1,0,1],phi7));
circuit.push_back(qclab.qgates.MCRotationY([2,3,4,5],0,[1,1,1,0],phi9));
circuit.push_back(qclab.qgates.MCRotationY([2,3,4,5],0,[1,1,1,1],phi11));
circuit.push_back(qclab.qgates.MCRotationY([2,3,4,5,6,7,8,9,10],0,...
        [0,1,1,0,1,1,1,1,0],...
        -phi4+phi12));
circuit.push_back(qclab.qgates.MCRotationY([2,3,4,5,6,7,8,9],0,...
        [1,0,1,1,0,0,0,1],-phi8+phi4));
circuit.push_back(qclab.qgates.MCRotationY([2,3,4,5,6,7,8,9],0,...
        [1,1,1,1,1,0,1,1],-phi11+phi4));
circuit.push_back(qclab.qgates.MCRotationY([2,3,4,5,6,7,8,9,10],0,...
        [1,1,1,1,1,1,0,0,0],...
        -phi11+phi10));
circuit.push_back(qclab.qgates.MCRotationY([2,3,4,5,6,7,8,9,10],0,...
        [1,1,1,1,1,1,1,1,1],...
        -phi11+phi13));
circuit.draw();

```