

Data Authorisation and Validation in Autonomous Vehicles: A Critical Review

Reem Alhabib, and Poonam Yadav

Abstract—Autonomous systems are becoming increasingly prevalent in new vehicles. Due to their environmental friendliness and their remarkable capability to significantly enhance road safety, these vehicles have gained widespread recognition and acceptance in recent years. Automated Driving Systems (ADS) are intricate systems that incorporate a multitude of sensors and actuators to interact with the environment autonomously, pervasively, and interactively. Consequently, numerous studies are currently underway to keep abreast of these rapid developments.

This paper aims to provide a comprehensive overview of recent advancements in ADS technologies. It provides in-depth insights into the detailed information about how data and information flow in the distributed system, including autonomous vehicles and other various supporting services and entities. Data validation and system requirements are emphasised, such as security, privacy, scalability, and data ownership, in accordance with regulatory standards. Finally, several current research directions in the AVs field will be discussed.

Index Terms—Network reliability, Autonomous vehicles, data sharing, and data validation.

I. INTRODUCTION

An Automated Driving System (ADS) is an integrated system within vehicles that utilises various in-vehicle technologies and sensors to navigate autonomously from a starting point to a predefined destination. Due to its significant contribution to safety and overall economic growth, leading car companies have heavily invested in several Autonomous Vehicle (AV) technologies that are able to improve safety, efficiency, and cost savings. The technology is evolving through inter-industry alliances and technological contributions across the globe.

Famous technological firms and car manufacturers have recently invested billions of dollars in this major transformation of the automobile industry; several sources estimate that the self-driving car market share will take between 15 and 20 years to reach 25 percent globally [1]. In line with this trend and industrial development, governments worldwide are providing guidance that allows and encourages on-road Autonomous Vehicle (AV) trials. For example, the UK published a code of practice (2019) that specifies certain on-road trials [2]. Subsequently, in early 2022, the government changed the Highway Code to ensure the first self-driving vehicles are introduced safely on the roads [3].

AVs have various control units that design a system to complete all driving tasks without human intervention. Cameras, GPS, and other sensors are connected to exchange data to facilitate independent driving decisions [4]. Due to dynamic road scenarios, data comes from external roadsides and other vehicles to the on-board sensors, which need to make continuous control decisions. In general, making automated driving systems trustworthy mainly centres around this halo of data.

Thus, for the safety of the whole environment, this data must be preserved securely and not accessible to tampering. This is one of the most critical challenges due to the various networks and communications in this environment. In addition, in case of an accident, this data becomes significant to reconstruct the event for analysis and investigation.

This paper aims to provide an understanding of data/information flow in autonomous vehicles and their supporting services and infrastructure. Most current surveys investigate the ADS as a whole and explore the ADS techniques from the system level; with a study conducted on ADS that focuses on the data perspective. This detailed information provides a holistic view of the autonomous vehicle's ecosystem, which helps design efficient and secure data storing and validation solutions. In this survey, the aim to explore several critical data aspects of Autonomous Vehicles (AV) by answering the following fundamental questions:

- **What is AV?**

The definition and conceptual understanding of Autonomous Vehicles to establish a clear foundation are explored.

- **What is its Structure?**

The architecture and components that constitute an Autonomous Vehicle are analysed, providing insight into its intricate design.

- **What is the Data Flow?** The flow of data is explained within the Autonomous Vehicle ecosystem, from data acquisition to processing and utilisation.

- **Who Owns the AV Data?**

The ownership and control dynamics surrounding the data generated by Autonomous Vehicles are explored, including legal and ethical considerations.

- **What are the concerns and challenges?**

The concerns and challenges associated with Autonomous Vehicles are highlighted, ranging from safety and privacy to regulation.

Section II provides a brief overview of Autonomous Driving Systems (ADS), describing the information required to understand the structure and installation of these vehicles and all related technologies. Section III provides an overview of the potential benefits and costs of ADS. Section IV discusses various data management issues, with each subsection addressing the requirements, current problems, and gaps, and presenting solutions for each stage of the data lifecycle. Section V addresses other related concerns, such as safety, security, privacy, and ethics. Section VI considers open questions and future work in ADS.

II. AUTONOMOUS DRIVING SYSTEM (ADS)

Here is a fixed version of your English text:

Since the invention of the automobile, there has been continuous innovation towards autonomous vehicles (AVs). Figure 1 briefly illustrates the timeline of AV evolution, highlighting the main developments from the 1950s to 2022.

Driving assistance systems (DAS) at all levels have been and continue to be the most critical component in AVs. The first generation of DAS utilised sensors that assessed a car's internal condition. In the 1980s, Traction Control Systems (TCS) and Anti-lock Braking Systems (ABS) were utilised for dynamic vehicle stabilization, as the early era of DAS. Following this, Electronic Stability Control (ESC) was introduced in 1995 for the same function. Additionally, in the early 1990s, sensors that were practically classified as exteroceptive were presented as the second generation. The most recent generation of DAS, also known as Advanced Driver Assist Systems (ADAS), has been developed to prevent collisions.

Autonomous refers to systems that are able to change their behavior in response to unanticipated events during operation [5]. The National Highway Traffic Safety Administration (NHTSA)[4] defines autonomous vehicles as "those vehicles in which at least aspects of a safety-critical control function (e.g., steering, throttle, or braking) occur without direct driver input". Vehicles, however, that provide safety warnings to drivers (e.g., forward crash signs) but do not perform a control function are not considered automated.

In September 2018, the NHTSA performed an extensive literature review of all the generic AV system features to identify the attributes that define the operational design domain (ODD). The comprehensive review resulted in 24 ADS features, specifically describing functionality and proposed timelines for commercial deployment across the different Society of Automotive Engineers (SAE) International levels of driving automation. Accordingly, the SAE's six-level taxonomy has become the widespread industry standard[6]:

Level 1: Driver Assistance requires the driver to remain in control of the driving tasks, with the exception of certain driving modes where assistance tools may take over.

Level 2: "Partial Driving Automation" refers to a driving mode in which the vehicle system takes over certain driving functions, such as acceleration, while the driver remains responsible for monitoring the driving situation.

Level 3: Conditional Driving Automation. While the vehicle system is responsible for some driving modes and monitoring the entire environment, at this level, the driver must be prepared to take control at all times and be responsive to alerts.

Level 4: High Driving Automation. While the vehicle system is designed to perform all driving tasks for specific dynamic driving tasks, the driver may take control.

Level 5: "Full driving automation" refers to a driving mode where the vehicle system undertakes all driving tasks in all conditions, thereby relieving the driver of any responsibility to monitor the environment or take control of the vehicle.

A. AV Architecture

Researchers studying autonomous vehicles (AVs) focus on two main areas: identifying their components and defining their functional perspective. Some papers focus on the technical aspects of AV components, while others take a functional approach [7], [8]. From a technical perspective, AVs have two main layers: hardware and software. Each layer is comprised of several subcomponents. There is some disagreement among researchers about how to categorise the core competencies of different subsystems when defining the functional perspective of AVs. However, in general, AV systems are made up of three to five primary functions: perception, localisation, planning, control and navigation, and system management [9], [10], as illustrated in Figure 2.

1) AV Main Operations:

- a) **Perception** refers to collecting data and extracting relevant understanding from the environment such as the detection of road signs, as well as object detection and classification [11], [12]. These detection tasks are performed by various sensors such as cameras and Radio Detection And Ranging (RADAR).
- b) **Localisation** refers to the ability of the AV system to determine the vehicle's position and orientation relative to the environment.
- c) **Planning** consists of three stages:
 - Using algorithms, the path planner calculates the most efficient geometric path.
 - The behaviour planner determines the optimal behaviour based on the path planned by the path planner.
 - The estimation of the best possible route subject to vehicle dynamics and environmental constraints [7].
- d) **Control** refers to executing planned actions and managing the vehicle's motions, such as changing lanes [9], [11].
- e) **System management** includes all the functions related to event data recorders, human-machine interactions involving in-vehicle interfaces [9], and external human-machine interfaces.

2) *Sensors and Sensors Fusion*: For an AV vehicle to have a high-quality and real-time understanding of its surrounding environment, it must quickly and accurately detect, comprehend, and track all objects. As a result, relying on a single source to generate all necessary data is impossible. Multiple sensors are equipped to provide both perceptual and location views of the environment, allowing the vehicle to make real-time decisions [13]. Sensors are devices that translate detected objects or changes in the surrounding environment into quantitative measurements for processing [8].

Sensors Types

AV systems, while having some variations, all consist of two primary types of sensors based on their operational principle: Exteroceptive and Proprioceptive. Exteroceptive sensors are external state sensors that are utilised to perceive the environment, such as calculating the distance to objects or light intensity from the surroundings of the system. Examples of these sensors include cameras, radio detection and ranging

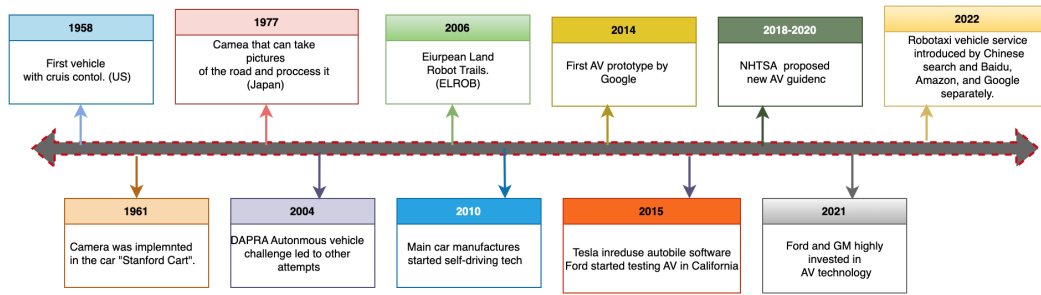

Fig. 1. The advancement of autonomous vehicles in the last few decades.

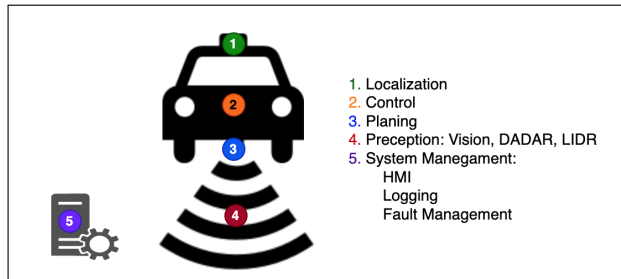

Fig. 2. Autonomous Vehicle Components.

(RADAR), etc. Proprioceptive sensors, on the other hand, are internal state sensors that capture the dynamic state and measure the internal values of a dynamic system. Examples of this type of sensor include Global Positioning Systems (GPS), encoders, accelerometers, etc.[8], [14]. The most commonly used sensors for autonomous vehicles are listed in table I. In addition, Ahangar et al. [15] provided a detailed comparison of sensors and their individual challenges. As each sensor has different advantages and limitations in other aspects, integrating sensors is necessary to obtain an optimal perspective, and this operation is known as "sensor fusion".

Sensor Fusion

The advantage of this operation is to combine the data originating from different sources to complete each other's functions in order to provide an improved outcome in some specific criteria and data aspects for decision tasks [16]. The best example to explain the benefit of this method is to fuse RADAR sensors and camera images where these sensors have different strengths and weaknesses. RADAR is not affected by the illumination of the environment, but it is not able to provide accurate data regarding an object's body. On the other side, the Camera's image could provide these data, however, it may provide conflicting data under some illumination conditions [13]. The initial step in data fusion is sensor calibration, which means notifying the ADS regarding the sensors' position and orientation to collect and associate the data in space and time [17]. While the various sensors capture data in relation to the same object, the produced data could be combined to obtain different information in order to

achieve higher-quality output. Other explicit examples with details and fusion techniques are discussed by Campbell et al. [13] and Fayyad et al. [14].

B. Communication in Autonomous Vehicle

AVs are able to communicate with any compatible systems, including other AVs, infrastructure, and pedestrians[18], [19]. This communication is known as Vehicle to Everything (V2X) technology, referring how the vehicle communicates to everything. The network must be continuously fast, reliable, and secure to achieve an efficient cooperative environment with minimal delay (latency). Specifically, there are two main tendencies used all over the world: the wireless standard 802.11p or mobile networks, especially 5G [20], [21], [22]. In the near future, sixth-generation (6G) wireless systems will be crucial for V2X communications in autonomous vehicles. [23]

The differences between conventional and self-driving cars are evident; nonetheless, the connected car is a different phrase in-car technology. In the literature, there is sometimes no distinction made between connected and autonomous vehicles. However, they are considered as a main step toward a fully AV. The connected car's concept is part of the Internet of Things (IoT) where the vehicle exchanges data, updates software, and connects with other vehicle devices. In this smart vehicle, all the electronic control units ECUs and onboard units (OBUs) are all connected across several digital buses such as Control Area Network (CAN), Ethernet, FlexRay, Local Interconnect Network (LIN), Media Oriented Systems Transport (MOST) and Bluetooth [24], [25]. Such capabilities along with sensing, communicating with the surroundings, and controlling the driving tasks represent the AV. A connected and Automated Vehicle (CAV) is a vehicle that performs automated driving tasks and connectivity with other vehicles, road users, the road infrastructure, and the cloud [26].

There is no doubt that conventional cars constitute the vast majority on today's roads. However, some strong expectations state that the number of connected cars will reach 700 million by 2030, while the number of AVs will exceed 90 million [24]. Correspondingly, Zhang et al. [27] address the problem of optimally controlling CAVs under mixed traffic conditions where both CAVs and conventional are together on the roads.

1) Communication Technologies:

TABLE I
MOST COMMONLY USED SENSORS

Exteroceptive Sensors	
Sensor	Function
LiDAR (Light Detection and Ranging)	Uses light beams to provide 360-degree distance between an object and the car.
Radar (Radio Detection and Ranging)	Uses Radio waves to determine the distance between an object and a car.
Camera	To provide images of the environment to interpret data.
Ultrasonic	Uses for a short distance determining object such as parking.
Proprioceptive Sensors	
GPS (Global Positioning System)	To locate the vehicle.
IMU (Inertial Measurement Unit)	To measure acceleration, angular rate
Encoders	To provide feedback signals used in speed and/or position control.
Accelerometers	To measure acceleration

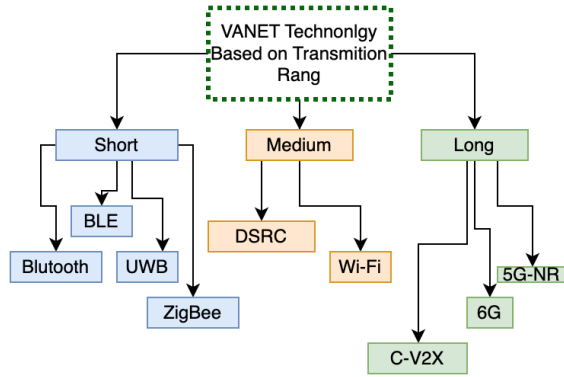

Fig. 3. VANET technologies based on transmission Range [15].

- **Vehicular Ad-Hoc Networks (VANETs):**
these consists of a group of vehicles connected via a wireless network [28]. This network is a basic part of the Intelligent Transportation System (ITS) framework [18] to assist various connections:
 - 1) **Vehicle-to-vehicle (V2V)** communication that allows the vehicles to communicate with each other and share the necessary information such as traffic jamming. To establish V2V communication, vehicles should have an On Board Unit (OBU), Omnidirectional antennas, sensors and actuators, and a Global Positioning System (GPS) [29].
 - 2) **Vehicle-to-Infrastructure (V2I)** communication enables the vehicles to interact with the roadside units RSUs which are fixed devices installed next to the road covering a dedicated area [29]. These communications are mostly conducted by using wireless dedicated short-range communications (DSRC), which aims to provide active safety and convenience services [26].
 - 3) **Vehicle-To-Everything (V2X)** Communication allows the vehicle to communicate with other entities using technologies such as Cellular V2X (C-V2X) including 5G and 6G.

Different VANET technologies are based on transmission range (see Figure 3). Ahangar et al. presented a comprehensive survey regarding different vehicle communication technologies, their application, limitations, and advantage [15].

5G is suitable for long-range transmission to meet the high-mobility demand architecture; while 6G is still in its conceptualisation phase, although the technology-driven key performance indicators extremely serves the AV's communication requirements [30]. In general, various regions prefer DSRC over C-V2X (e.g., USA) due to the heavily deployed infrastructure around the country, however, this recently changed when Europe decided to move with cellular-based technology for CAVs [31].

In Brussels (2018), the 5G Infrastructure Public Private Partnership (5G PPP) which is a cooperative combined initiative between the European Commission and the European ICT industry (ICT manufacturers, telecommunications operators, service providers, SMEs, and researcher Institutions, launched to deliver solutions, architectures, and standards for the next generation communication infrastructures [32]. The survey provided by Hakak et al. [33] highlights and summarises the key projects related to the 5G autonomous vehicles.

III. AUTONOMOUS VEHICLE POTENTIAL BENEFITS AND COSTS

Self-driving technology is a promising future in safety, mobility, environment, and luxury. It may reduce crash risks by avoiding human error and distracted driving. Many conventional vehicle crashes occur due to human error and distracted driving. For example, partially automated crash avoidance features could reduce the severity of as many as 1.3 3 million crashes in the USA every year, including 133,000 injury crashes and 10,100 fatal crashes [34]. Thus, traffic will disregard poor human driving conduct and improve performance in terms of road safety and traffic congestion. In addition, self-driving cars contribute significantly to reducing emissions (worldwide goal to achieve net-zero by 2050 [35]). Other benefits and advantages are summarised in Table III. Comparatively, even though adopting self-driving will increase safety, there are particular safety in relation to its development. Its total or partial dependence on driving assistance systems results in a serious risk with both hardware and software issues. Additionally, sensors may be compromised due to environmental conditions such as dangerous weather. Another significant concern is through cyber attacks that an automobile and/or its technological environment may be subject to causing grave privacy and security issues. For example, Networks,

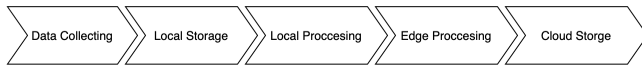

Fig. 4. Data Flow in AV System.

range sensors, and cameras could be infiltrated by terrorist hackers, leading to numerous collisions.

TABLE II
PROS AND CONS OF APPLYING AUTONOMOUS VEHICLES.

Pros	Cons
<p>Increased safety Accidents will be greatly avoided due to the various assistance systems, ongoing connection, and connectivity between vehicles.</p>	<p>Increased infrastructure costs AVs require higher standards for road maintenance and design.</p>
<p>Reduced energy consumption and pollution Since these vehicles are supposed to run on sustainable energy, carbon and emissions of greenhouse gases will be almost nonexistent.</p>	<p>System failures risks Hardware/software failures, wrong data, feeding/processing, faster traffic speeds, and increased overall vehicle travel are additional collision causes that may be on the rise.</p>
<p>Reduce traffic congestion Although AVs move at a slower speed in cities, the traffic efficiency will be higher because of the efficient connection between vehicles.</p>	<p>Data protection issues The network's environment causes security and privacy issues.</p>

IV. DIFFERENT DATA FLOW

In this section, the current open issues and solutions are discussed in terms of data management in AV systems. This massive collection of data moves through different paths under varied processing and storage stages; starting from real-time data collecting until data at rest reaches its final destination in the backed cloud servers(see figure 4).

A. Data Collection

The vehicle hardware and software equipment generates large amounts of data. For example, in each second, cameras generate 20-40 MB, and LiDAR generates 10-70 MB data [36]. The complexity of the AV systems begins with the multiple data sources which have different data types and formats that the AVS needs to deal with. In Figure 5 these data sources are illustrated, which can be summarised as follows:

- 1) Data about the owner (Number 1 in the Figure)
- 2) Data comes from the vehicle's status; for example, if the tank or battery is almost empty. (Number 1 in the Figure)
- 3) Data comes from the vehicle itself by its sensors. (Number 1 in the Figure)
- 4) Data from other vehicles presenting their surroundings, such as other vehicles sharing information about traffic jams or accidents. That also includes data from smart road units or traffic lights in smart cities. (Number 2, 3 ,4 and 5, respectively; V2I vehicle to infrastructure; V2V vehicle to vehicle; V2P vehicle to

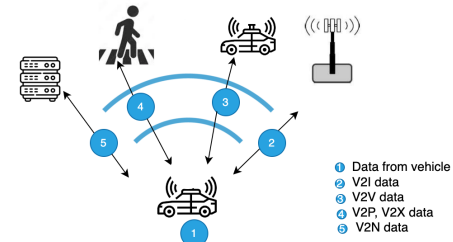

Fig. 5. Data Sources in AV.

pedestrian; V2X vehicle to everything; and V2N vehicle to network communications)

The collected data feeds the onboard diagnostics which are part of the ADS function, i.e. driving decision-making, analysis of crashes, or technical failures. However, a privacy breach is a serious challenge for the vehicle owner, producers, the public, and lawmakers. Autonomous vehicles may track the owner or passengers of the vehicle, including settings, such as synced contacts, addresses entered into the navigation system, fingerprints, facial recognition, etc. In addition, sensors on AVs allow them to gather data regarding the whole environment of the surroundings. This includes other vehicles' shared information, real-time traffic info, and pedestrians' faces and locations.

Furthermore, in terms of security, ransomware, IoT attacks, and DDoS, are such recent cyberattacks in addition to the more classic ones that affect information and the operation of the vehicle. Accordingly, safety systems need real-time detection and accuracy from non-deterministic AI models with complex computing on a combination of large amounts of data and communication restrictions. These systems must accurately function in a variety of weather situations, with varying visibility, and quality of the infrastructure and environment. These requirements, though, can place a heavy real-time and scale burden on these systems.

B. Local Data storing

Based on sensors and cameras positioned in various regions both inside and outside the automobile, data is created and maintained by the vehicle. According to how many ignition cycles the car goes through, the majority of them will maintain their data for a while before replacing it with fresh data. Besides the data sent to the back-end servers and cloud, an Event Data Recorder (EDR), and Data Storage System for Automated Driving (DSSAD) are the main tools for storing significant event data. The rest of this section focuses on these technologies, their functions, gaps, and current solutions proposed.

1) **EDR**: : A recording device inside the vehicle that can capture information regarding an event [37] in a readily usable manner. Its concept is the same for both AV and conventional vehicles; there is list of all the vehicles that have EDR in [38]. Such devices would support real crash investigations and analyses of performance due to their data capturing of a few

seconds both pre- and post-crash. Useful and meaningful data is stored, such as vehicle speed and brake status. For example, the Tesla Model 3 (Autopilot) is designed to record data such as: how various systems in the vehicle were operating; whether or not the driver and passenger safety belts were fastened; how far (if at all) the driver was depressing the accelerator and/or brake pedal; and, how fast the vehicle was travelling [39]. Table III is an example of such recorded data in detail. The technique behind this device generally stores data with the airbag control module once it has been deployed. Other recording techniques and event data recorders, which have been explained comprehensively [37].

In December 1996, the National Highway Traffic Safety Administration (NHTSA) and the National Aeronautics Space Administration (NASA) cooperated to improve airbag safety. Consequently, NASA recommended that NHTSA encourage installing and obtaining crash data for safety analyses from crash recorders on vehicles [37]. It is worth indicating, however, that (EDR- AV) EDR for automated vehicles must considerably exceed the performance of EDR for conventional vehicles (EDR-CV) [40]. Publications around the world seek to provide “guidelines for the development of automated driving functions”, including identifying the technical requirements for EDR-AV.

The Regulation (EU) 2019/2144 sets rules on technical requirements for new types of motor vehicles to maintain safety and environmental protection [41]. According to that regulation, in June 2022, the EDR is supposed to become mandatory for all vehicles with SAE Level 3/Level 4 functions[40]. In addition, The IWG EDR/DSSAD deals with the definition of the technical requirements as a prerequisite for the corresponding UN regulations for both EDR systems (conventional/autonomous) [42].

All crash data is required to be stored, be available, and retrieved for crash reconstruction purposes, even for testing, in order to understand the crash circumstances [43]. However, for AV level 3 and above where the system can perform the whole driving tasks for a certain time, EDR is unhelpful in terms of responsibility and liability without the Data Storage System for Automated Driving (DASSD) system to indicate who was in control during the accident.

2) *DASSD*: : A storage device that determines whether the system or the driver has controlled the vehicle [44]. This provides information regarding who was actually controlling the driving task at a particular time in order to decide the responsibility and consequently liability issues. Examples of the stored data elements have been shown to be position and time-stamped switches of the ADS from one mood to another [45]. These may contain data regarding whether the system is activated, manually, or automatically deactivated. Therefore, it also records time and position, and when the driver is requested to drive; position and time-stamped override through brake control by the driver; position and time-stamped transition demand by the ADS. Thus, the nature of the reasons for a transition demand or deactivation is able to be determined such as:

- Driver not available or lack of driver attention.
- Driver override.

TABLE III
EDR PARAMETERS EXAMPLE [39]

Data Event	Value
Maximum Delta-V. Longitudinal (km/h)	-61
Time To Maximum Delta-V. Longitudinal(ms)	95.0
Maximum Delta-V Lateral (km/h)	-1
Time To Maximum Delta-V Lateral (ms)	72.5
Time To Maximum Delta-V Resultant (ms)	95.0
Ignition Cycle At Event	271
Ignition Cycle Runtime (minutes)	10.3
Odometer At Event Time Zero (km)	30.5
Airbag Warning Lamp Status	Off
ABS Warning Indicator Status	Off
Vehicle Drive Mode	Natural
Driver Safety Belt Status	Buckled
Passenger Safety Belt Status	Buckled
Occupant Classification Status in Front Passenger Seat	Small Adult
Driver Seat Track Position	Rearward
2nd Row Left Safety Belt Status	Not Buckled
2nd Row Left Seat Occupant	Not Occupied
2nd Row Center Safety Belt Status	Not Buckled
2nd Row Center Seat Occupant	Not Occupied
2nd Row Right Safety Belt Status	Buckled
2nd Row Right Seat Occupant	Not Occupied
3rd Row Left Safety Belt Status	Not Available
3rd Row Left Seat Occupant	Not Available
3rd Row Right Safety Belt Status	Not Available
3rd Row Right Seat Occupant	Not Available
Driver Airbag Deployment 2nd Stage Disposal	Yes
Right Front Passenger Airbag Deployment 2nd Stage Disposal	Yes
Complete File Recorded	Yes

- System failure.
- Unplanned event (ex: bad weather).

While EDR is event-based storage, DASSD is thr continuous storage of specific AD data sets. All this data shall be recognised without any possible confusion.

3) *State of the art for traffic accident data records*: The first practical transportation data recorder was introduced in 1921. It records vehicle speed, engine RPM and distance moved onto a rotating circular chart [37]. Figure 6 shows the current development movement of the existing national and regional activities on this technology.

Despite the large role that these tools play in supporting investigations, they have the following limitations:

- 1) Due to storage limitations and the large number of continuously variable parameters required for analysis. EDR stores only specific data parameters for a specific short time in specific events, basically events with airbag deployment.
- 2) DSSAD is able to store a specific period, with older data able to be erased when this storage is full [45].
- 3) If the EDR system does not have sufficient space to record an event, the current event data will overwrite the previous event data.
- 4) In addition, many accidents involving pedestrians and cyclists, in particular, are not recognised as significant events, with no airbag deployed, meaning no event data is stored. Even for the systems that activate EDR for crashes (airbag deployment) or near-crash event (hitting small object), there are events that are considered a crime; however, the EDR indicates that it is an inefficient event, such as a traffic offense [45]. This is useless from the perspective of some regulators.

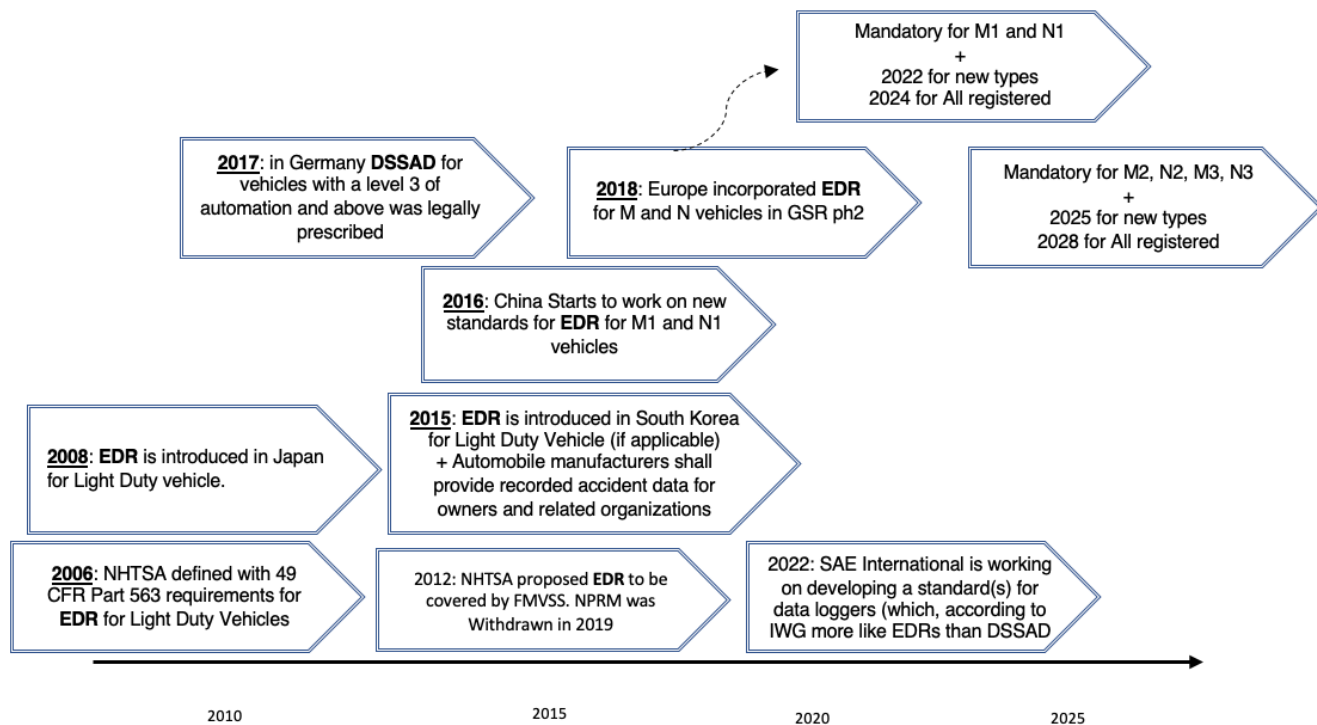

Abbreviations	
M1	Passenger Car
M2, M3	Busses and Coaches
N1	Light Goods vehicles
N2, N3 vehicles	Heavy Goods Vehicles
IWG	Informal Working Groups (IWGs) under GRVA (Working Party on. Automated/Autonomous and Connected Vehicles) The United Nations Economic Commission for Europe (UNECE)

Fig. 6. State of the art for traffic accident data records and their issues [45],[44], and [2].

- According to [40], There are five classes of data that are typically required for forensic analysis: firmware, communication data, user data, safety-related data, and security-related data which these devices lack.
- Even continuous recording and storage of video, location, speed, and/or surroundings of a vehicle appear to be contradictory with the regulations addressing privacy protection. Therefore, laws related to this matter need to be enacted before it is adopted.
- DSSAD would need consumers' approval for recording and/or access to data [45].
- Manufacturers keep creating new generations of EDR however, there is an urgent need for international standards.

The current Event Data Recording has to be refined to provide sufficient data for liability purposes [46]. A survey in which 173 international experts in accident analysis participated depicted that a considerable number of traffic accidents

involving ADAS cannot be reconstructed [47]. According to that paper, the main reason is that the information gathered independently from the manufacturer is relatively poor. They emphasise that the solution is a Forensic Event Data Recorder (FEDR) which is an EDR that meets all the requirements from the investigator's perspective.

4) *The way forward for EDR-AV/DSSAD:* A number of current attempts around the world aspire to correct the shortages surrounding these technologies, including:

- For automated vehicles, AHEAD recommends data recording from 30 seconds before to 10 seconds after the collision. This time proves to be sufficient for the individual EDR-relevant claims of the present claims collective [20].
- As pedestrians and cyclists are involved in a lot of accidents, the Netherlands intends to extend the scope of the EDR with pedestrians and cyclists immediately.
- governments, for example, in the UK, would apply a two-

step method. Firstly, to introduce the USA’s standards for EDRs in a relatively short timeframe; then, the second step applies more extensive requirements, if a single-step approach were not possible [48].

4) Many researchers have proposed schemes for enhancing the storage of EDR data, section IV-B6 discusses some.

5) *The legal issues:* The EDR data belongs to the owner because the data describes driving and accident conditions [49]. In the USA, ownership of the EDR data is a matter of State law. However, NHTSA considers the owner of the vehicle to be the owner of the data collected from an EDR. In addition, courts are able to acquire EDR data through court orders[43]. In addition to this ownership dilemma, the accessibility of much of the data is another unstable issue. For example, for EDR data, some companies recently allowed the owner to access all the EDR data by using some special hardware and software, such as Tesla and BMW (until 2017 they were the only part that could reach it). Furthermore, the original equipment manufacturer (OEM) may also access the EDR remotely in some crash circumstances [39].

These issues represent obstacles in the way of accessing this data by various stakeholders. Allowing stakeholders who may have different purposes to access the data could be extremely valuable. Thus, legislators, regulators, and manufacturers play a significant role in forming what data should be recorded, how the AI could select the useful data, how to increase the record device size, how to access them, and who has the ability to access them.

6) *Current Solutions:* Various safety analysis models, including CAST [29] and FRAM [50], are used for accident investigation. CAST employs system theory to identify failure causes and propose preventive measures. FRAM assesses complex interactions in socio-technical systems. These models lack a unified framework covering all causal factors, and manual analysis remains costly and inefficient.

Data integrity preservation for AVs has been a goal for several studies that have presented various frameworks based on various forms of technology for investigation purposes. Hoque and Hasan have also proposed a forensic investigation framework for AVs; AVGuard tool [51] is supposed to be integrated with the AD system. In addition, it assumes that the AV has local storage to store the log provenance. The AV can also communicate with a remote cloud server and publish the newly created log provenance. A robot operating system (ROS) node collects all the logs from different AD modules. Oham et al have proposed a distributed digital forensics framework [52], which is based on the evidence reported by the nearby witness AVs if an AV is involved in an accident. Digital signatures, along with a corresponding certificate are used to protect data integrity. Data exchanges between entities in the framework are stored in a blockchain and used for later decision-making. DIAT [53] is another Attestation framework, which preserves the integrity of data generated by a program/device by ensuring the detection of a large number of run-time attacks based on control-flow attestation. It has a lower overhead relatively compared to the other attestation-based solutions however it is not able to

detect sophisticated data-only attacks. Further, T-Box [54] is a trusted real-time data recording system, which consists of an automotive data recording system with a network monitor, generator, and recorder. It assumes that the gateway could be used as the network monitor. The generator reconstructs data provided by the monitor and delivers it to the recorder which in turn stores data. The recorder stores an individual data entry into a block and these data blocks can be stored in local or external storage or transmitted to a remote server. Even though this could be considered a trusted automotive data recording system that operates in real-time, however, it does not present significant consideration for privacy issues. Buquerin et al [55] provides a general concept for automotive forensics. Using Ethernet, their implementation uses the on-board diagnostics interface, the diagnostics over internet protocol, as well as the unified diagnostic services for communication. Liu et al aim to store EDR data safely and away from manipulation. In their scheme [56], data is not only sent to the manufacturer’s server as normal, but the vehicle also uploads the EDR data to a cloud server and sends the evidence of storage to the nearby vehicle through a vehicular ad hoc network.

C. Local and Edge Processing

There are three approaches for processing in the cloud: centralised location, edge-based processing offers flexibility; and the Hybrid approach solution which is the most preferred. The very low-rate data are regularly transmitted to the manufacturer’s cloud where all processing occurs at a centralised location. The high latency-sensitive data, however, needs high-speed data processing distributed architecture. The edge-based cloud data centre performs many tasks at the edge instead of the cloud leading to faster access than cloud computing. Edge and Fog computing plays a critical role here for the data require high network bandwidth, which provides data processing and local storage capabilities [57].

Even though clouds are crucial for the success of AVs, there are several challenges facing the vehicular cloud community that are not facing traditional cloud computing. In addition to the privacy, security, authorisation, and authentication issues in any cloud computing, the dynamic resource allocation in the vehicles and the lack of a central authority make addressing these issues more challenging[58], [59]. In this era, several studies have been provided in table IV.

TABLE IV
TABLE OF MOBILE EDGE COMPUTING (MEC) SOLUTION STUDIES

Scheme	Minimising computation time	Minimising energy consumption	Optimising resource	Maximising privacy
[60]	✓	✓	✓	x
[61]	✓	x	✓	x
[62]	✓	x	✓	x
[63]	✓	x	x	x
[64]	✓	x	x	x
[65]	✓	x	x	✓
[66]	✓	x	✓	x

D. Backend Cloud Computing

Most companies acknowledge and state through their official websites that they keep a lot of data regarding the vehicle owner, the vehicle itself, and its in-vehicle hardware and software products [39]. There is a great current dilemma that requires research and balance about how much of the data must be stored on-board versus instantly dismissed. The analyst Christian Renaud in a talk with Blocks & Files states that 78% of OEMs plan to have between 50-70 % of all that data analysed on the vehicles, while the rest are sent off the vehicle [67]. The period of retention of this data varies from one company to another. It also differs in the way of obtaining this data, some transfer them to the back-end servers physically, and others transfer them remotely through networks. In addition, they differ in the format of data; companies such as Tesla use raw sensor data, whereas some other companies ask Original Design Manufacturing(ODM) to provide processed data. Captured and stored data requires large storage architecture; for instance Cloud, or on-premises servers. The majority of automakers are utilizing cloud-based capabilities via connected-car services. For example, in 2019, Ford publicised about its connected-vehicle collaboration with AWS. In addition, Toyota announced its engineering ecosystem to develop and deploy the next generation of its cloud-connected vehicle in 2020. These examples and others are available in [68].

Indeed, in a promising attempt to address the data management challenges in AVs, Cloud technology is the scalable solution in the automotive industry. Therefore, this different source data is being classified to be onboard or sent to the cloud or stored in servers and hard drives as long-term storage. Local function data and V2X data that has a 4ms response time requirement and has to go off-vehicle will not be sent to clouds [67]. In contrast, model training data, for example, includes when a new object has been detected, and the data regarding this disparity will be used to formulate patterns and reports, and thus, will be sent to the cloud for future algorithm improvements [69], [70].

E. The Need for Data Sharing

Even though some vehicle manufacturers accept to share in-vehicle data with the other service providers by accessing data directly through the vehicle manufacturer's server or via "neutral" servers that would gather the data. However, the service providers ask for direct real-time access to in-vehicle-produced data and functions through an in-vehicle interoperable, standardised, secure, and open-access platform [71]. Besides any law party, Tesla states that the data could be shared with their service providers, business partners, and affiliates; in addition to any third parties, the owner has also been authorised[39]. Some stakeholders suggest that car manufacturers allow tier 1 suppliers to access the data directly [72] to maintain and improve their products. Figure 7 illustrates the levels of tiers of any manufacturer.

Various situations are defined in the literature where different stakeholders need to access accurate AV data such as causes of

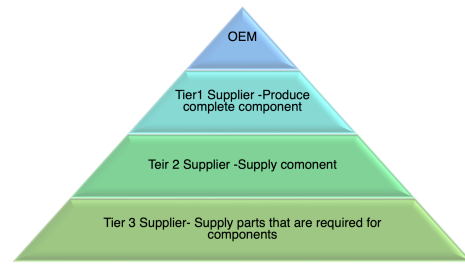

Fig. 7. The Levels of Tiers of Any Manufacturer.

accidents and failure data. In traditional vehicles, human error is the critical cause of 94% of vehicle accidents [73]. However, in the case of an accident with a self-driving car, there are clear differences in liability. In particular, the interaction of many factors in AV and its ability to make some or all driving decisions disrupt the adjudication process. The liability subjects of AV accidents may include vehicles, vehicle assistant drivers, manufacturers, vehicle owners, and insurance companies [74].

In the literature, authors and organisations differed in the identification of stakeholders and their techniques to identify. NHTSA states that motor vehicle accidents may be investigated through various entities, and they listed them [37]. In another example in the article [9], the authors fragmented stakeholders into three general classes: A) containing all types of end-users and society; B) containing all technical groups; and C) for all regulatory parties including insurers. However, the most frequent entities in literature are as the following:

- 1) Government and the legal authority: The accident data collected from the involved AV are necessary as facts and evidence in criminal courts to determine liability. Another possible scenario for government use is to take advantage of data to reduce the possibility of accidents in the future and thus reduce losses and assess roadside safety.
- 2) Original Equipment Manufacturer(OEM): The Manufacturers may analyse the collected data and use it to monitor system performance and improve their products. Another possible scenario is to reconstruct the accident to assess the causes in order to reduce the possibility of accidents in the future.
- 3) Suppliers: The potential scenario is to analyse and improve the products or services that are involved in a vehicle manufactured by the OEM.
- 4) The owner: In a possible scenario the owner might use the data as evidence to absolve him/her of any criminal liability. In addition, the provided data could be used for insurance amounts and services.
- 5) Insurance: The stored data present accurate evidence to resolve insurance disputes and a fair solution that ensures that no party is tampered with.
- 6) The testing and certification: the testing organisation needs the data to reconstruct the accident in order to analyse and update the technical and legal requirements.
- 7) Road authorities: Data can support assessing and improving the infrastructure and roadside safety.
- 8) Researchers: To analyse and assess the AV crashes to assist in the development of vehicles, infrastructure, and

the whole environment's components.

Due to the significance of saving the data received and issued by this system, it is clear that sharing this data with all relevant parties is essential.

Secure multi-party data sharing is not a brand-new area of study. In the literature, several authors propose sharing data frameworks confidentially and integrally. One approach to mitigate privacy concerns is by using Federated Learning (FL), which is a distributed collaborative AI approach that allows multiple devices to coordinate data training with a central server without sharing actual datasets [75]. With a trusted server (aggregator), parties can learn a shared machine learning model locally and separately, as well as share only the resulting insights from each analysis. This technology is an active era adopted recently in various applications and research.

In financial application, Byrd and Polychroniadou [76] proposed federated learning with differential privacy and secure multiparty computation to a problem of collective interest in finance. As one of the main limitations of FL is the reconstruction attacks and re-identification from correlated data sets, they apply Differential Privacy, which adds noise to the input data set. What is for mobile applications, a protocol has been proposed by Bonawitz et al. for FL [77]. Even though their secure aggregation protocol resulted in high communication costs, it proved that the central server could not see any local updates. Sotthiwat et al. propose a partially encrypted Multi-Party Computation (MPC) solution by encrypting only the critical parts of model parameters to reduce local computation and communication costs. In particular, their work only encrypts the first layer of local models with MPC strategy [78]. In biomedical research, the FAMHE framework relies on Multiparty Homomorphic Encryption (MHE) to perform privacy-preserving FA by using the advantages of both interactive protocols and homomorphic encryption HE [79]. The approach enables several sites to compute their local patient-level data and then encrypt and homomorphically combine their local results under MHE Collective Aggregation (CA). The collectively encrypted and aggregated final result is eventually switched from encryption under the collective public key to encryption under the querier's public key; thus, only the querier can decrypt.

Several Blockchain-based FL designs have been provided recently. For example, [80] is a distributed on-vehicle machine learning model that aims to improve vehicular networks. Data could be trained and models could be exchanged in a distributed manner. Zeng et al [81] also designed an autonomous controller to avoid performance deficiencies of traditional learning-based controllers that are trained by each connected vehicle's local data. In their design, the learning models used by the controllers are collaboratively trained among a group of CAVs.

Data management and security are part of Blockchain's most applied research directions for transportation. Based on Blockchain, BIIoVT is a secure storage architecture proposed to ensure the security, confidentiality, and privacy of data stored in the cloud [82]. It assumes that every vehicular network has one Blockchain for distributed secure infrastructure. All city

vehicular networks transferred the secure data to a distributed hash table, which is used at the cloud layer. To address the same gap, Kang et al. establish a secure and distributed vehicular blockchain for data management in vehicular edge computing and network to achieve secure data sharing among vehicles [83]. In addition, Jain et al present A comprehensive survey regarding recent advances in autonomous vehicles and systems and how blockchain is able to help in improving user experiences and improving industry practices [84].

1) *Data validation*: An AD system generates a considerable amount of data, making the extraction of crucial information from the logs of different AD modules a real challenge. In case of a defect, finding the set of influencing factors causing the failure in an automated system is a complex mission. There are two reasons behind this complexity [85]: firstly, the AD functions may not be sufficient for all unexpected conditions, due to the dynamic environment with unlimited contexts; secondly deviation from the intended functionality due to the inductive nature of a system that combines machine learning components. Nested and complex factors of functional insufficiency could lead to an unintended result. Failure in sensor fusion or sensor's reading (e.g.: misdetection of the front vehicle), external environment context (e.g.: weather), or control failure (ex: braking is not initiated in time), or even a combination of some or all of these factors (e.g.: a glare causes misdetection of a pedestrian implying that braking is not initiated in time) are potential factors in critical scenarios for Automated Driving[85], [86]. Within the enormous amount

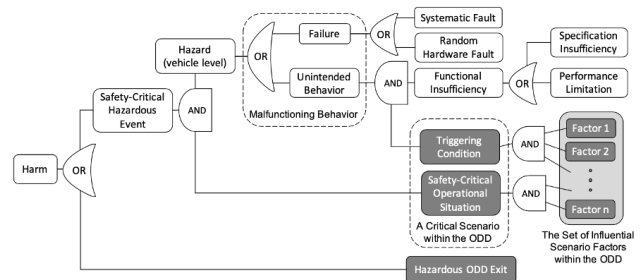

Fig. 8. The Complexity of Finding The Source of Harm[85].

of produced data, searching for meaningful data that could lead to the crash causes, is immensely difficult to locate. All the generated data must be valid and classified as (useful – not useful) before any analysing process. To avoid the accident, it is important to persist with the high-quality training data sets that are used for AI systems that assist the vehicle to be able to make decisions [87]. Finding the exact moment of the failure, the exact wrong data, device, or subsystem is a real obstacle. Figure 8 above explicates the complexity of finding the source of harm.

Furthermore, as crashes are rare events, testing and analysing similar scenarios to find the exact harm that may blame one party or another in this nested system is a real challenge. In 2011 the automotive standard of regulation of the International Standardisation Organization (ISO) ISO 26262:2011 for the

development of safety-critical systems was officially released. However, with the advance of autonomous driving functions and other future systems and technologies, the trend towards fail-operational systems is inevitable in the 2nd edition of ISO 26262 [88]. Koopman and Wagner [89] discuss the main challenge areas for autonomous vehicles in testing according to the V model that ISO 26262 developed it as a framework that ties each type of testing.

V. FURTHER CONCERNS

A. Data Privacy

AV is equipped and will continue to improve the tracing technology to understand failure circumstances for many purposes. However, these forms of technology have a serious impact on not only users' privacy but also on pedestrians whose photos and locations can be captured by vehicles. As the generated data in AV is collected, stored, transferred, and shared, users' privacy could be extremely violated in the following faces:

- 1) User's information: Identifying information regarding the user of the vehicle may be collected and maintained for many purposes for different parties.
- 2) Sensors data The sensors collect data about whatever they see or sense. Cameras could capture people's identities and their locations.
- 3) Location The combination of location data and driver data could provide sensitive private information [24].
- 4) Cloud Data The cloud stores several private data such as driver profiles, car maintenance data, destination data, and financial information [90]

The open wireless access in VANET leads to serious security and privacy issues. For example, [91] is a paper containing survey papers on privacy, security, and authentication in VANETs and the surveys of papers addressing these issues. The design in [92] demonstrates an efficient privacy-preserving authentication scheme for V2G networks to ensure that electric vehicles (EVs) securely access services provided by the grid. 5G radio network architecture is also proposed [93], which leverages multiple radio access technologies and utilises Cloud Radio Access Network (CRAN) functionalities for privacy-preserved and secure CAV networks. To protect the location and trajectory privacy of Vehicular Social Networks (VSNs) based on 5G, [94] design a framework that incorporates Mobile Femtocell technology. They propose the Dynamic Group Division algorithm (DGD) that increases the likelihood of exchanging pseudo-nyms. Nonetheless, the privacy issue is one of the concerns associated with all phases of data flow in AV and must be investigated.

B. Security

Security is a key issue in AVs as any network attack could eventually cost lives. Based on the components of AVs, the attacks could be classified as:

In-vehicle network

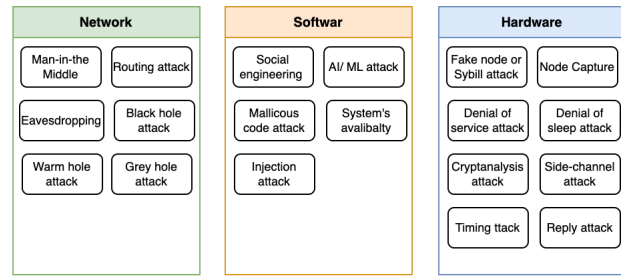

Fig. 9. Attack Taxonomy [98].

Attacks include:

- 1) **ECU engine control units.** An attacker can modify the programming code during design and implementation processing [95]
- 2) **CAN and SEA J1939 busses:** Security issues involving the CAN bus, which connects to all the vehicle's components. A virus could modify the messages delivered by the controller area network (CAN) bus [95]. In [96] the authors developed a mobile application that can control and manipulate such vehicle systems remotely through the Internet.
- 3) **Remote sensors:** External entities can make connections with sensors through existing wireless networks; therefore the attacker may implement remote sensor control [97]. Any tampering with the sensors' data generated and transmitted is able to result in fatal accidents.
- 4) **GPS:** This provides location and time information, which is the core of many functions, such as pseudonym certificates, basic safety messages, and timestamps in messages [97]. The adversary may modify the code to report incorrect GPS location data [95].
- 5) **Wireless communication:** Vulnerabilities may occur by Bluetooth, tire pressure monitoring system (TPMS), or keyless entry and ignition systems [97].

Vehicle to everything network (V2X)

Attacks on V2X typically target:

- 1) VANET or Vehicle ad-hoc networks which use dedicated short-range communications (DSRC) and are based on the IEEE 802.11p standard for wireless access in vehicular environments.
- 2) Another communication structure required for V2X is the mobile cellular network, satellite radio, and Bluetooth

VANET demonstrates the need to address various security and privacy issues. Mansour et al [94] presented the essential security and privacy requirements in VANET; while Gupta et al [98] have provided a taxonomy, based on the architecture of hardware, network, and software (see figure 9).

Several solutions in the vehicular network have been recently proposed. To provide confidentiality and authenticity, Hu Xiong et al [99] designed an identity-based (ID-based) encryption scheme. RTED-SD is a scheme that was developed to detect real-time attacks. In their scheme [100], they use the Fast Quartile Deviation Check algorithm (FQDC) is used to recognise and

locate the attack in the Internet of Vehicles. As an example of a solution that adopts BC in IoVs, [101] uses a consensus mechanism to provide a secure event-sharing protocol for smart cities using IoV and RSUs. Another example is [102] which aims to protect IoV against quantum attacks using the blockchain-based public key infrastructure. In Mobile Ad Hoc Networks, a blockchain-based mechanism [103] is designed to provide security-related data collection and incentivise mobile nodes.

C. Data Integrity

Integrity refers to the fact that the data must be intact and unchanged throughout its lifecycle [18]. AVS is a complex cyber-physical system, which has many interfaces that make its data vulnerable to attack and manipulation. It is possible to distinguish three types of AV data that require solutions that preserve their integrity:

- **Real-Time** on-board data, such as data exchanged between vehicles, RSUs, and stations, and data that reaches the sensors inside the vehicle. Instead of data encryption, Changvala et al proposed a hiding method for the integrity of Lidar and Radar data. [104], [105]. Separately, JAVED et al [106] proposed a protocol to isolate false data in V2X communications messages. Another data integrity verification scheme is proposed in [107]; aligns GPS data with other information regarding passengers in order to make sense of the vehicle's reliability. Using RSU, this data integration is used for integrity checks.
- **Near real-time** data that is sent to the cloud or fog for processing to make decisions inside the car. The security of edge computing includes all data phases: Data collection, Data Processing, and Data Storage [108]. The architecture for both edge and IoV paradigms, as well as the integrity preservation that are present in edge computing are inherited by IoV systems and vice versa. Section 4.2 briefly reviews all the security threats and risks in this networks
- **Batch** data that is eventually sent to the back-end cloud, where different regulators could extract significant information from that huge amount of data for the purposes of analysis and development. This data is also essential for investigation purposes as explained in the motivation scenario in the data sharing section, multiple entities involved in such a system lead to potential motivations to alter the data to escape liability. Thus, it is imperative to ensure that all the data recording system in a vehicle upholds integrity, continuity, and non-repudiation [54]. As current event data recorder systems installed in the AVs do not ensure the integrity of the collected data [51], several researchers have proposed recording data frameworks that preserve the integrity as discussed.

D. Cross-Border Interoperability

Accessing different services and sharing data among the vehicles and infrastructure is the main part of the vehicle decision. However, interconnectivity and interoperability are extensive

issues in our geopolitically partitioned World. Cooperative Intelligent Transportation Systems (C-ITS) is a paradigm that is based on Information and Communication Technologies (ICT), and create stand-alone in-vehicle systems and cooperative systems (V2X) [109]. Despite services provided by C-ITS solution, C-ITS infrastructure, and delivery of C-ITS services often Cooperative Intelligent Transportation Systems (C-ITS) become a territorial issue [110]. In this field, a form of architecture was recently presented in [111], which aims to improve the integration of cooperative intelligent transportation systems in automated driving focusing on cross-border interoperability. This AUTOCITS architecture was implemented in three European cities.

E. Regulation and Standards

Most of the current regulations that relate to human drivers must be changed to proper self-driving vehicles, including testing and deployment, safety standards, data exchanged and security standards, liabilities and insurance, together with personal information privacy standards. For example, much of the current privacy legislation is inappropriate for AVs such as the U.S federal Drivers' Privacy Protection Act, and Electronic Communications Privacy Act [48]. Indeed, some countries have started acting on new regulations; for instance, the Scottish Law Commission's regulation for autonomous vehicles and AV legislation and policies in the USA, the Netherlands, the UK, and Sweden [9],[112]. In addition, EU countries, industry, and the Commission collaborate to achieve the EU's ambitious vision for connected and automated mobility across the EU. The commission will address many current issues such as policies and legislation relating to digital technology, including cybersecurity, liability, data use, privacy, and radio spectrum/connectivity, which are of increasing relevance to the transport sector [113]. This supports the aforementioned 5G PPP; however, there are no international central regulatory bodies existing to regulate the implementation and deployment of autonomous vehicles [114].

VI. CONCLUSION AND FUTURE WORK

In light of the emergence of the 4.0 industry, self-driving cars are considered at the forefront of this revolution. On one side, it provides numerous advantages regarding the environment and road safety. However, very few people would still have enough trust to use those vehicles. This massive amount of data is both extremely important and dangerous, making it extremely delicate to use at this stage. On the one hand, it can be used to extract a wealth of valuable information in order to improve the transportation system and increase safety. Comparatively, if not properly preserved, it may cost us our lives. Beginning with remote-control door locks, hackers may load firmware without authorisation into major ECUs and progress to sensor-based manipulation of cooperative adaptive cruise control (CACC). In addition, user data could be collected specific way, as the GM collects location data and radio listening routines from its users [115]. Due to the open nature of the used networks, safety, security, and privacy become vital issues

The variety of functions will continue to grow leading to an increase in new vulnerabilities. Adopting Cloud technology provides various applications and techniques; however, with more concerns regarding security and privacy. Besides the vast research studies presented in the field of autonomous systems of security and privacy, ADS are still not completely robust and secure.

The AV's sensors are able to capture massive amounts of Real-time data in milliseconds and apply a deep learning algorithm to recognise other objects on the road and transport passengers safely. The problem of scale, though, becomes a challenge with this big data, as it is important to determine how the data will be effectively and safely managed, validated, and shared with the other subjects in the environment. In addition, once it is transferred, validation, and mining of useful information become another challenge. The literature shows that in case of an accident, there are no data collection and analysis protocols where the investigators and regulators are able to access and analyse ADS data. Current EDRs, even the modern version, lack essential data in the investigation and analysis stage. Several parameters regarding to the system performance and the driver's behaviour during the accident are not the only important data.

These vehicles have integrated hardware and software that can provide much more than the data captured by event data recorders. For example, cameras, alongside lidars raw and fusion data can add a lot of clarification of the environment at the time of the accident. Furthermore, the communication data with other vehicles and RDU, in addition to their sensors' data could support the accident evidence in the investigator's view. In addition, data such as updates, fault alerts, periodic maintenance, and insurance are all significant data to obtain before the process of analysis and investigation by regulators and analysts.

It is not only desirable, but also necessary, to make this data available, secure, and accessible. Accessing data in order to provide analysis and investigation is an issue that the researchers tried to address. The current solutions tried to:

- 1) propose on-board data records to store all the logs securely for analysis process (such as [51], [52],[53], [55], [54]), with no efficient accessing mechanism
- 2) or overcome the limitations of EDR by proposing more evidence techniques to extend EDR work such as [56]
- 3) or propose access systems without taking into account the authorisations and confidentiality.

The next step is continued research, along with involving all stakeholders, as there is a need for the data for the crash analyses process to define the stakeholders and data that may be shared.

It will take time for a new revolution to emerge. As a result, adopting one to occur before dealing with serious issues would prove to be unsafe. To make AV reliable, there is the desperate need for an integrated system for to secure manage and share data. Another review paper could also be formulated for data-sharing solutions by focusing on addressing authorisation and confidentiality.

VII. ACKNOWLEDGEMENTS

Alhabib's research is funded by the Saudi Arabian Cultural Bureau and Shaqra University in Saudi Arabia, while Yadav is funded by EPSRC under grants EP/X040518/1 and EP/X525856/1.

REFERENCES

- [1] S. Liu, "The business case for infrastructure-vehicle cooperative autonomous driving," *IEEE Engineering Management Review*, 2022.
- [2] (2022). [Online]. Available: <http://www.gov.uk>
- [3] (2022) Rules on safe use of automated vehicles on gb roads. [Online]. Available: <https://www.gov.uk/>
- [4] E. Thorn, S. C. Kimmel, M. Chaka, B. A. Hamilton *et al.*, "A framework for automated driving system testable cases and scenarios," United States. Department of Transportation. National Highway Traffic Safety ..., Tech. Rep., 2018.
- [5] D. P. Watson and D. H. Scheidt, "Autonomous systems," *Johns Hopkins APL technical digest*, vol. 26, no. 4, pp. 368–376, 2005.
- [6] SAE, "Sae levels of driving automation™ refined for clarity and international audience," *Available from.*, 2021.
- [7] O. Sharma, N. C. Sahoo, and N. Puhan, "Recent advances in motion and behavior planning techniques for software architecture of autonomous vehicles: A state-of-the-art survey," *Engineering applications of artificial intelligence*, vol. 101, p. 104211, 2021.
- [8] D. J. Yeong, G. Velasco-Hernandez, J. Barry, J. Walsh *et al.*, "Sensor and sensor fusion technology in autonomous vehicles: A review," *Sensors*, vol. 21, no. 6, p. 2140, 2021.
- [9] D. Omeiza, H. Webb, M. Jirotko, and L. Kunze, "Explanations in autonomous driving: A survey," *IEEE Transactions on Intelligent Transportation Systems*, 2021.
- [10] J. Vargas, S. Alswiss, O. Toker, R. Razdan, and J. Santos, "An overview of autonomous vehicles sensors and their vulnerability to weather conditions," *Sensors*, vol. 21, no. 16, p. 5397, 2021.
- [11] S. D. Pendleton, H. Andersen, X. Du, X. Shen, M. Meghiani, Y. H. Eng, D. Rus, and M. H. Ang, "Perception, planning, control, and coordination for autonomous vehicles," *Machines*, vol. 5, no. 1, p. 6, 2017.
- [12] T. G. Reid, S. E. Houts, R. Cammarata, G. Mills, S. Agarwal, A. Vora, and G. Pandey, "Localization requirements for autonomous vehicles," *arXiv preprint arXiv:1906.01061*, 2019.
- [13] S. Campbell, N. O'Mahony, L. Krpalcova, D. Riordan, J. Walsh, A. Murphy, and C. Ryan, "Sensor technology in autonomous vehicles: A review," in *2018 29th Irish Signals and Systems Conference (ISSC)*. IEEE, 2018, pp. 1–4.
- [14] J. Fayyad, M. A. Jaradat, D. Gruyer, and H. Najjaran, "Deep learning sensor fusion for autonomous vehicle perception and localization: A review," *Sensors*, vol. 20, no. 15, p. 4220, 2020.
- [15] M. N. Ahangar, Q. Z. Ahmed, F. A. Khan, and M. Hafeez, "A survey of autonomous vehicles: Enabling communication technologies and challenges," *Sensors*, vol. 21, no. 3, p. 706, 2021.
- [16] T. Nguyen and M. Yoo, "Fusing lidar sensor and rgb camera for object detection in autonomous vehicle with fuzzy logic approach," in *2021 International Conference on Information Networking (ICOIN)*. IEEE, 2021, pp. 788–791.
- [17] J. Wishart, S. Como, U. Forgiione, J. Weast *et al.*, "Literature review of verification and validation activities of automated driving systems," *SAE Int. J. Connect. Automat. Veh.*, vol. 3, no. 4, pp. 267–323, 2020.
- [18] J. Cui, L. S. Liew, G. Sabaliauskaite, and F. Zhou, "A review on safety failures, security attacks, and available countermeasures for autonomous vehicles," *Ad Hoc Networks*, vol. 90, p. 101823, 2019.
- [19] J. Jia, P. Zou, F. Hu, Y. Zhao, and N. Chi, "Flexible data rate v2x communication system beyond 1.84 gb/s based on mimo vlc and radar integration," *Applied Sciences*, vol. 10, no. 19, p. 6636, 2020.
- [20] M. Martínez-Díaz and F. Soriguera, "Autonomous vehicles: theoretical and practical challenges," *Transportation Research Procedia*, vol. 33, pp. 275–282, 2018.
- [21] Z. Szalay, D. Ficzer, V. Tihanyi, F. Magyar, G. Soós, and P. Varga, "5g-enabled autonomous driving demonstration with a v2x scenario-in-the-loop approach," *Sensors*, vol. 20, no. 24, p. 7344, 2020.
- [22] S. Guleng, C. Wu, Z. Liu, and X. Chen, "Edge-based v2x communications with big data intelligence," *IEEE Access*, vol. 8, pp. 8603–8613, 2020.

- [23] M. Noor-A-Rahim, Z. Liu, H. Lee, M. O. Khyam, J. He, D. Pesch, K. Moessner, W. Saad, and H. V. Poor, "6g for vehicle-to-everything (v2x) communications: Enabling technologies, challenges, and opportunities," *Proceedings of the IEEE*, vol. 110, no. 6, pp. 712–734, 2022.
- [24] N. R. Fulbright, "The privacy implications of autonomous vehicles," 2017.
- [25] M. Cebe, E. Erdin, K. Akkaya, H. Aksu, and S. Uluagac, "Block4forensic: An integrated lightweight blockchain framework for forensics applications of connected vehicles," *IEEE Communications Magazine*, vol. 56, no. 10, pp. 50–57, 2018.
- [26] J. Guanetti, Y. Kim, and F. Borrelli, "Control of connected and automated vehicles: State of the art and future challenges," *Annual reviews in control*, vol. 45, pp. 18–40, 2018.
- [27] Y. Zhang and C. G. Cassandras, "An impact study of integrating connected automated vehicles with conventional traffic," *Annual Reviews in Control*, vol. 48, pp. 347–356, 2019.
- [28] D. C. Marinescu, *Cloud computing: theory and practice*. Morgan Kaufmann, 2022.
- [29] S. Sharma *et al.*, "Vehicular ad-hoc network: An overview," in *2019 International Conference on Computing, Communication, and Intelligent Systems (ICCCIS)*. IEEE, 2019, pp. 131–134.
- [30] J. He, K. Yang, and H.-H. Chen, "6g cellular networks and connected autonomous vehicles," *IEEE Network*, vol. 35, no. 4, pp. 255–261, 2020.
- [31] M. A. Khan, H. E. Sayed, S. Malik, T. Zia, J. Khan, N. Alkaabi, and H. Ignatiou, "Level-5 autonomous driving—are we there yet? a review of research literature," *ACM Computing Surveys (CSUR)*, vol. 55, no. 2, pp. 1–38, 2022.
- [32] The 5g infrastructure public private partnership (5g ppp). [Online]. Available: <http://www.5g-ppp.eu>
- [33] S. Hakak, T. R. Gadekallu, S. P. Ramu, P. K. R. Maddikunta, C. de Alwis, M. Liyanage *et al.*, "Autonomous vehicles in 5g and beyond: A survey," *arXiv preprint arXiv:2207.10510*, 2022.
- [34] C. D. Harper, C. T. Hendrickson, and C. Samaras, "Cost and benefit estimates of partially-automated vehicle collision avoidance technologies," *Accident Analysis & Prevention*, vol. 95, pp. 104–115, 2016.
- [35] (2021) Net zero by 2050: A roadmap for the global energy sector. [Online]. Available: <https://trid.trb.org/view/1856381>
- [36] L. Liu, S. Lu, R. Zhong, B. Wu, Y. Yao, Q. Zhang, and W. Shi, "Computing systems for autonomous driving: State of the art and challenges," *IEEE Internet of Things Journal*, vol. 8, no. 8, pp. 6469–6486, 2020.
- [37] J. T. Correia, K. A. Iliadis, E. S. McCarron, M. A. Smolej, B. Hastings, and C. C. Engineers, "Utilizing data from automotive event data recorders," in *Proceedings of the Canadian Multidisciplinary Road Safety Conference XII, London Ontario*, 2001, p. 18.
- [38] RIMKUS. Event data recorder supported vehicles. [Online]. Available: <https://rimkus.com/media/pdfs/Event-Data-Recorder-Vehicle-List-Rimkus-1.11.21.pdf>
- [39] (2022) Electric cars. [Online]. Available: https://www.tesla.com/en_gb
- [40] J. Gwehenberger, O. Braxmeier, C. Lauterwasser, M. A. Kreutner, M. Borrack, C. Reinkemeyer, L. Wech, M. Weyde, and P. Salzberger, "Needs and requirements of edr for automated vehicles-analysis based on insurance claims reported to allianz germany."
- [41] Eu approval and market surveillance measures for motor vehicles and their trailers. [Online]. Available: <https://eur-lex.europa.eu/legal-content/EN/TXT/?uri=LEGISSUM:4350062>
- [42] World-wide level. [Online]. Available: <https://www.connectedautomateddriving.eu/regulation-and-policies/world-wide-harmonization/>
- [43] N. H. T. S. Administration, "Url: <http://www.nhtsa.gov/about+nhtsa>," *Press+ Releases/nhtsa-ihscommitment-on-aeb-09112015 on December*, vol. 2, p. 2015, 2015.
- [44] K. Böhm, T. Kubjatko, D. Paula, and H.-G. Schweiger, "New developments on edr (event data recorder) for automated vehicles," *Open Engineering*, vol. 10, no. 1, pp. 140–146, 2020.
- [45] International organization of motor vehicle manufacturers. [Online]. Available: <https://www.oica.net>
- [46] P. Koopman and M. Wagner, "Autonomous vehicle safety: An interdisciplinary challenge," *IEEE Intelligent Transportation Systems Magazine*, vol. 9, no. 1, pp. 90–96, 2017.
- [47] D. Paula, K. Böhm, T. Kubjatko, and H.-G. Schweiger, "Challenges in forensic reconstruction of traffic accidents involving advanced driver assistance systems (adas)," in *29th Annual Congress of the European Association for Accident Research (EVU)*, 2020.
- [48] (2022) Review of the existing national / regional activities and a proposed way forward for edr. [Online]. Available: <https://unece.org/transport/documents/2022/03/informal-documents/edrdsa-iwg-review-existing-national-regional>
- [49] M. Iyoda, T. Trisdale, R. Sherony, D. Mikat, and W. Rose, "Event data recorder (edr) developed by toyota motor corporation," *SAE International journal of transportation safety*, vol. 4, no. 1, pp. 187–201, 2016.
- [50] R. Patriarca, G. Di Gravio, R. Woltjer, F. Costantino, G. Praetorius, P. Ferreira, and E. Hollnagel, "Framing the fram: A literature review on the functional resonance analysis method," *Safety Science*, vol. 129, p. 104827, 2020.
- [51] M. A. Hoque and R. Hasan, "Aguard: A forensic investigation framework for autonomous vehicles," in *ICC 2021-IEEE International Conference on Communications*. IEEE, 2021, pp. 1–6.
- [52] C. Oham, S. S. Kanhere, R. Jurdak, and S. Jha, "A blockchain based liability attribution framework for autonomous vehicles," *arXiv preprint arXiv:1802.05050*, 2018.
- [53] T. Abera, R. Bahmani, F. Brasser, A. Ibrahim, A.-R. Sadeghi, and M. Schunter, "Diat: Data integrity attestation for resilient collaboration of autonomous systems." in *NDSS*, 2019.
- [54] S. Lee, W. Choi, H. J. Jo, and D. H. Lee, "T-box: A forensics-enabled trusted automotive data recording method," *IEEE Access*, vol. 7, pp. 49 738–49 755, 2019.
- [55] K. K. G. Buquerin, C. Corbett, and H.-J. Hof, "A generalized approach to automotive forensics," *Forensic Science International: Digital Investigation*, vol. 36, p. 301111, 2021.
- [56] W. Liu, W. Shen, L. Harn, and M. Luo, "A fast vanet-assisted scheme for event data recorders," *Security and Communication Networks*, vol. 2022, 2022.
- [57] A. Ghansiyal, M. Mittal, and A. K. Kar, "Information management challenges in autonomous vehicles: a systematic literature review," *Journal of Cases on Information Technology (JCIT)*, vol. 23, no. 3, pp. 58–77, 2021.
- [58] S. Olariu, "A survey of vehicular cloud research: Trends, applications and challenges," *IEEE Transactions on Intelligent Transportation Systems*, vol. 21, no. 6, pp. 2648–2663, 2019.
- [59] J. Kang, D. Lin, E. Bertino, and O. Tonguz, "From autonomous vehicles to vehicular clouds: challenges of management, security and dependability," in *2019 IEEE 39th International Conference on Distributed Computing Systems (ICDCS)*. IEEE, 2019, pp. 1730–1741.
- [60] T. X. Tran and D. Pompili, "Joint task offloading and resource allocation for multi-server mobile-edge computing networks," *IEEE Transactions on Vehicular Technology*, vol. 68, no. 1, pp. 856–868, 2018.
- [61] Y. Liu, H. Yu, S. Xie, and Y. Zhang, "Deep reinforcement learning for offloading and resource allocation in vehicle edge computing and networks," *IEEE Transactions on Vehicular Technology*, vol. 68, no. 11, pp. 11 158–11 168, 2019.
- [62] J. Zhao, Q. Li, Y. Gong, and K. Zhang, "Computation offloading and resource allocation for cloud assisted mobile edge computing in vehicular networks," *IEEE Transactions on Vehicular Technology*, vol. 68, no. 8, pp. 7944–7956, 2019.
- [63] J. Ren, G. Yu, Y. He, and G. Y. Li, "Collaborative cloud and edge computing for latency minimization," *IEEE Transactions on Vehicular Technology*, vol. 68, no. 5, pp. 5031–5044, 2019.
- [64] W. Sun, H. Zhang, R. Wang, and Y. Zhang, "Reducing offloading latency for digital twin edge networks in 6g," *IEEE Transactions on Vehicular Technology*, vol. 69, no. 10, pp. 12 240–12 251, 2020.
- [65] K. Gai, M. Qiu, and H. Zhao, "Privacy-preserving data encryption strategy for big data in mobile cloud computing," *IEEE Transactions on Big Data*, vol. 7, no. 4, pp. 678–688, 2021.
- [66] J. Liang, J. Zhang, V. C. Leung, and X. Wu, "Distributed information exchange with low latency for decision making in vehicular fog computing," *IEEE Internet of Things Journal*, 2021.
- [67] (2020) Autonomous vehicle data storage. [Online]. Available: <https://blocksandfiles.com/2020/02/03/autonomous-vehicle-data-storage-is-a-game-of-guesses/>
- [68] (2021) autonomous vehicles and their cloud-computing-networks. [Online]. Available: <https://www.sae.org/news/2021/04/autonomous-vehicles-and-their-cloud-computing-networks>
- [69] (2021) Cars in the clouds. [Online]. Available: <https://www.rackwareinc.com/driving-with-the-cloud>
- [70] Z. Wang, Y. Wu, and Q. Niu, "Multi-sensor fusion in automated driving: A survey," *Ieee Access*, vol. 8, pp. 2847–2868, 2019.
- [71] D. Geradin, "Access to in-vehicle data by third-party service providers: Is there a market failure and, if so, how should it be addressed?" *How Should it be Addressed*, 2020.

- [72] M. McCarthy, M. Seidl, S. Mohan, J. Hopkin, A. Stevens, and F. Ognissanto, "Access to in-vehicle data and resources," *Study commissioned by European Commission CPR2419. Brussels*, p. 10, 2017.
- [73] S. Singh, "Critical reasons for crashes investigated in the national motor vehicle crash causation survey," Tech. Rep., 2015.
- [74] Q. Yuan, Y. Peng, X. Xu, and X. Wang, "Key points of investigation and analysis on traffic accidents involving intelligent vehicles," *Transportation safety and environment*, vol. 3, no. 4, p. tdab020, 2021.
- [75] D. C. Nguyen, M. Ding, P. N. Pathirana, A. Seneviratne, J. Li, and H. V. Poor, "Federated learning for internet of things: A comprehensive survey," *IEEE Communications Surveys & Tutorials*, vol. 23, no. 3, pp. 1622–1658, 2021.
- [76] D. Byrd and A. Polychroniadou, "Differentially private secure multi-party computation for federated learning in financial applications," in *Proceedings of the First ACM International Conference on AI in Finance*, 2020, pp. 1–9.
- [77] K. Bonawitz, V. Ivanov, B. Kreuter, A. Marcedone, H. B. McMahan, S. Patel, D. Ramage, A. Segal, and K. Seth, "Practical secure aggregation for privacy-preserving machine learning," in *proceedings of the 2017 ACM SIGSAC Conference on Computer and Communications Security*, 2017, pp. 1175–1191.
- [78] E. Sothiawat, L. Zhen, Z. Li, and C. Zhang, "Partially encrypted multi-party computation for federated learning," in *2021 IEEE/ACM 21st International Symposium on Cluster, Cloud and Internet Computing (CCGrid)*. IEEE, 2021, pp. 828–835.
- [79] D. Froelicher, J. R. Troncoso-Pastoriza, J. L. Raisaro, M. A. Cuendet, J. S. Sousa, H. Cho, B. Berger, J. Fellay, and J.-P. Hubaux, "Truly privacy-preserving federated analytics for precision medicine with multiparty homomorphic encryption," *Nature communications*, vol. 12, no. 1, pp. 1–10, 2021.
- [80] S. R. Pokhrel and J. Choi, "Federated learning with blockchain for autonomous vehicles: Analysis and design challenges," *IEEE Transactions on Communications*, vol. 68, no. 8, pp. 4734–4746, 2020.
- [81] T. Zeng, O. Semiariy, M. Chen, W. Saad, and M. Bennis, "Federated learning on the road autonomous controller design for connected and autonomous vehicles," *IEEE Transactions on Wireless Communications*, 2022.
- [82] S. K. Singh, P. K. Sharma, Y. Pan, and J. H. Park, "Biov: Blockchain-based secure storage architecture for intelligent internet of vehicular things," *IEEE Consumer Electronics Magazine*, 2021.
- [83] J. Kang, R. Yu, X. Huang, M. Wu, S. Maharjan, S. Xie, and Y. Zhang, "Blockchain for secure and efficient data sharing in vehicular edge computing and networks," *IEEE Internet of Things Journal*, vol. 6, no. 3, pp. 4660–4670, 2018.
- [84] S. Jain, N. J. Ahuja, P. Srikanth, K. V. Bhadane, B. Nagaiah, A. Kumar, and C. Konstantinou, "Blockchain and autonomous vehicles: Recent advances and future directions," *IEEE Access*, vol. 9, pp. 130 264–130 328, 2021.
- [85] X. Zhang, J. Tao, K. Tan, M. Törngren, J. M. G. Sánchez, M. R. Ramli, X. Tao, M. Gyllenhammar, F. Wotawa, N. Mohan *et al.*, "Finding critical scenarios for automated driving systems: A systematic literature review," *arXiv preprint arXiv:2110.08664*, 2021.
- [86] C. Neurohr, L. Westhofen, M. Butz, M. H. Bollmann, U. Eberle, and R. Galbas, "Criticality analysis for the verification and validation of automated vehicles," *IEEE Access*, vol. 9, pp. 18 016–18 041, 2021.
- [87] F. Henao. Why data handling may put a bump on the road to autonomous driving. [Online]. Available: <https://europe.autonews.com/guest-columnist/why-data-handling-may-put-bump-road-autonomous-driving>
- [88] G. Griessnig and A. Schnellbach, "Development of the 2nd edition of the iso 26262," in *European Conference on Software Process Improvement*. Springer, 2017, pp. 535–546.
- [89] P. Koopman and M. Wagner, "Challenges in autonomous vehicle testing and validation," *SAE International Journal of Transportation Safety*, vol. 4, no. 1, pp. 15–24, 2016.
- [90] (2017) white-papers cybersecurity for connected cars exploring risks in 5g, cloud, and other connected technologies. [Online]. Available: https://documents.trendmicro.com/assets/white_papers/wp-cybersecurity-for-connected-cars-exploring-risks-in-5g-cloud-and-other-connected-technologies
- [91] D. Manivannan, S. S. Moni, and S. Zeadally, "Secure authentication and privacy-preserving techniques in vehicular ad-hoc networks (vanets)," *Vehicular Communications*, vol. 25, p. 100247, 2020.
- [92] Y. Zhang, J. Zou, and R. Guo, "Efficient privacy-preserving authentication for v2g networks," *Peer-to-Peer Networking and Applications*, vol. 14, no. 3, pp. 1366–1378, 2021.
- [93] S. Ansari, J. Ahmad, S. Aziz Shah, A. Kashif Bashir, T. Boutaleb, and S. Sinanovic, "Chaos-based privacy preserving vehicle safety protocol for 5g connected autonomous vehicle networks," *Transactions on Emerging Telecommunications Technologies*, vol. 31, no. 5, p. e3966, 2020.
- [94] M. B. Mansour, C. Salama, H. K. Mohamed, and S. A. Hammad, "Vanet security and privacy-an overview," *International Journal of Network Security & Its Applications (IJNSA) Vol*, vol. 10, 2018.
- [95] J. Raiyn, "Data and cyber security in autonomous vehicle networks," *Transport and Telecommunication*, vol. 19, no. 4, pp. 325–334, 2018.
- [96] S. Jafarnejad, L. Codeca, W. Bronzi, R. Frank, and T. Engel, "A car hacking experiment: When connectivity meets vulnerability," in *2015 IEEE globecom workshops (GC Wkshps)*. IEEE, 2015, pp. 1–6.
- [97] X. Sun, F. R. Yu, and P. Zhang, "A survey on cyber-security of connected and autonomous vehicles (cavs)," *IEEE Transactions on Intelligent Transportation Systems*, 2021.
- [98] S. Gupta and C. Maple, "A survey of security mechanisms for edge computing based connected autonomous vehicles," 2022.
- [99] H. Xiong, K.-K. R. Choo, and A. V. Vasilakos, "Revocable identity-based access control for big data with verifiable outsourced computing," *IEEE Transactions on Big Data*, 2017.
- [100] J. Li, Z. Xue, C. Li, and M. Liu, "Rted-sd: A real-time edge detection scheme for sybil ddos in the internet of vehicles," *IEEE Access*, vol. 9, pp. 11 296–11 305, 2021.
- [101] S. K. Dwivedi, R. Amin, S. Vollala, and R. Chaudhry, "Blockchain-based secured event-information sharing protocol in internet of vehicles for smart cities," *Computers & Electrical Engineering*, vol. 86, p. 106719, 2020.
- [102] H. Yi, "A secure blockchain system for internet of vehicles based on 6g-enabled network in box," *Computer Communications*, vol. 186, pp. 45–50, 2022.
- [103] G. Liu, H. Dong, Z. Yan, X. Zhou, and S. Shimizu, "B4sdc: A blockchain system for security data collection in manets," *IEEE Transactions on Big Data*, 2020.
- [104] R. Chagalvala, "Sensor data integrity verification for real-time and resource constrained systems," Ph.D. dissertation, 2021.
- [105] R. Chagalvala, B. Fedoruk, and H. Malik, "Radar data integrity verification using 2d qim-based data hiding," *Sensors*, vol. 20, no. 19, p. 5530, 2020.
- [106] M. A. Javed, M. Z. Khan, U. Zafar, M. F. Siddiqui, R. Badar, B. M. Lee, and F. Ahmad, "Odpv: An efficient protocol to mitigate data integrity attacks in intelligent transport systems," *IEEE Access*, vol. 8, pp. 114 733–114 740, 2020.
- [107] X. Shen, Y. Lu, Y. Zhang, X. Liu, and L. Zhang, "An innovative data integrity verification scheme in the internet of things assisted information exchange in transportation systems," *Cluster Computing*, vol. 25, no. 3, pp. 1791–1803, 2022.
- [108] R. Anusuya, D. K. Renuka, and L. A. Kumar, "Review on challenges of secure data analytics in edge computing," in *2021 International Conference on Computer Communication and Informatics (ICCCI)*. IEEE, 2021, pp. 1–5.
- [109] M. Lu, O. Turetken, O. E. Adali, J. Castells, R. Blokpoel, and P. Grefen, "C-its (cooperative intelligent transport systems) deployment in europe: challenges and key findings," in *25th ITS World Congress, Copenhagen, Denmark*, 2018, pp. 17–21.
- [110] L. Vlacic, "Cross-border, interoperable cooperative intelligent transportation systems: Could we make them operational?[editor's column]," *IEEE Intelligent Transportation Systems Magazine*, vol. 14, no. 4, pp. 3–4, 2022.
- [111] J. Naranjo, F. Jiménez, R. Castiñeira, M. Gil, C. Premevida, P. Serra, A. Valejo, F. Nashashibi, and C. Magalhães, "Cross-border interoperability for cooperative, connected and autonomous driving," *IEEE Intelligent Transportation Systems Magazine*, 2021.
- [112] A. Faisal, M. Kamruzzaman, T. Yigitcanlar, and G. Currie, "Understanding autonomous vehicles," *Journal of transport and land use*, vol. 12, no. 1, pp. 45–72, 2019.
- [113] (2022) Connected and automated mobility. [Online]. Available: [https://digital-strategy.ec.europa.eu/en/policies/connected-and-automated-mobility#:~:text=Connected%20and%20Automated%20Mobility%20\(CAM,guide%20themselves%20without%20human%20intervention\)](https://digital-strategy.ec.europa.eu/en/policies/connected-and-automated-mobility#:~:text=Connected%20and%20Automated%20Mobility%20(CAM,guide%20themselves%20without%20human%20intervention))
- [114] F. Khan, R. L. Kumar, S. Kadry, Y. Nam, and M. N. Meqdad, "Autonomous vehicles: A study of implementation and security," *International Journal of Electrical & Computer Engineering (2088-8708)*, vol. 11, no. 4, 2021.

- [115] B. Eriksson, J. Groth, and A. Sabelfeld, “On the road with third-party apps: Security analysis of an in-vehicle app platform.” in *VEHITS*, 2019, pp. 64–75.