

TWO-BRIDGE LINKS AND STABLE MAPS INTO THE PLANE

KAZUHIRO ICHIHARA AND GAKUTO KATO

ABSTRACT. We give a visual construction of stable maps f from the 3-sphere into the real plane enjoying the following properties; the set of definite fold points of f coincides with a given two-bridge link and f only has certain type of fibers containing two indefinite fold points.

1. INTRODUCTION

For smooth manifolds M and N , let $C^\infty(M, N)$ be the set of smooth maps of M to N with the Whitney topology. A smooth map $f : M \rightarrow N$ is called a *stable map* if there exists a neighborhood U_f of f in $C^\infty(M, N)$ such that, for any map g in U_f , there are diffeomorphisms $\Phi : M \rightarrow M$ and $\phi : N \rightarrow N$ satisfying $g = \phi \circ f \circ \Phi^{-1}$.

For a stable map f from a smooth 3-manifold M to the real plane \mathbb{R}^2 , it is known that the local singularities consist of three types: definite fold points, indefinite fold points and cusp points (for example, see [5]). Moreover, Levine has shown in [5] that the cusp points of any such stable map f can be eliminated by modifying it homotopically. Thus, in the rest of this paper, we will assume that all the stable maps of 3-manifolds into \mathbb{R}^2 has no cusp points. If $f : M \rightarrow \mathbb{R}^2$ is a stable map from a 3-manifold M to \mathbb{R}^2 without cusp points, then $f|_{S_1(f)}$ is an immersion with normal crossings (transverse double points), where $S_1(f)$ denotes the set of the indefinite fold points of f (for example, see [6]). Note that it implies that $f^{-1}(x)$ contains at most two singular points for $x \in \mathbb{R}^2$. In [6], Saeki showed that there exists a stable map f from a smooth 3-manifold M to \mathbb{R}^2 such that $f(S_1(f))$ has no double points if and only if M is a graph manifold (see [6] for the definition of graph manifolds). Due to this result, it is natural to consider such a stable map f such that $f(S_1(f))$ has non-empty crossings. The singular fibers, i.e. the components of the preimage of such double points by f , are classified into the *type* \mathbb{I}^2 and the *type* \mathbb{I}^3 in [5].

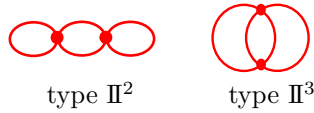

FIGURE 1. The type of the singular fibers.

We denote the set of type \mathbb{I}^2 singular fibers of f (resp. type \mathbb{I}^3 singular fibers of f) by $\mathbb{I}^2(f)$ (resp. $\mathbb{I}^3(f)$). Then, in [3], Ishikawa and Koda characterized the

2020 *Mathematics Subject Classification.* 57R45, 57M99, 57K10.

Key words and phrases. two-bridge link, stable map.

link L in the 3-sphere S^3 such that there exists a stable map f from S^3 to \mathbb{R}^2 satisfying $L \subset S_0(f)$ and $(|\Pi^2(f)|, |\Pi^3(f)|) = (1, 0)$, where $S_0(f)$ denotes the set of the definite fold points of f . Next, Furutani and Koda [1] characterized the link L such that there exists a stable map f from S^3 to \mathbb{R}^2 satisfying $L \subset S_0(f)$ and $(|\Pi^2(f)|, |\Pi^3(f)|) = (0, 1)$.

In this paper, we show that, for some two-bridge link L , there exists a stable map $f : S^3 \rightarrow \mathbb{R}^2$ such that $L = S_0(f)$ and $\Pi^2(f) = \emptyset$ or $\Pi^3(f) = \emptyset$.

Theorem 1.1. *Let L be a two-bridge link in S^3 and $D = C(a_1, b_1, \dots, a_m, b_m, a_{m+1})$ a Conway form of L with non-zero integers $a_1, b_1, \dots, a_m, b_m, a_{m+1}$. If b_i is even for all i , then there exist stable maps f_2 and f_3 from S^3 into \mathbb{R}^2 satisfying that $S_0(f_2) = S_0(f_3) = L$, $\Pi^3(f_2) = \emptyset$ and $\Pi^2(f_3) = \emptyset$.*

It is known that a two-bridge link of two components admits a Conway form $C(a_1, b_1, \dots, a_m, b_m, a_{m+1})$ with all the b_i 's are even. See [4] for example. Thus, as an immediate corollary, we have the following.

Corollary 1.2. *Let L be a two-bridge link of two components in S^3 . Then there exists stable maps f_2 and f_3 from S^3 into \mathbb{R}^2 such that $S_0(f) = S_0(g) = L$, $\Pi^3(f_2) = \emptyset$ and $\Pi^2(f_3) = \emptyset$. \square*

In the following, we recall the definition of two-bridge links and their Conway forms. A link in S^3 is called a *two-bridge link* if it admits a diagram with exactly two maxima and two minima. Actually, for any two bridge link L , there always exists a diagram of L called the *Conway form* $C(a_1, b_1, \dots, a_m, b_m, a_{m+1})$ for $a_i \neq 0$ and $b_j \neq 0$ illustrated in Figure 2.

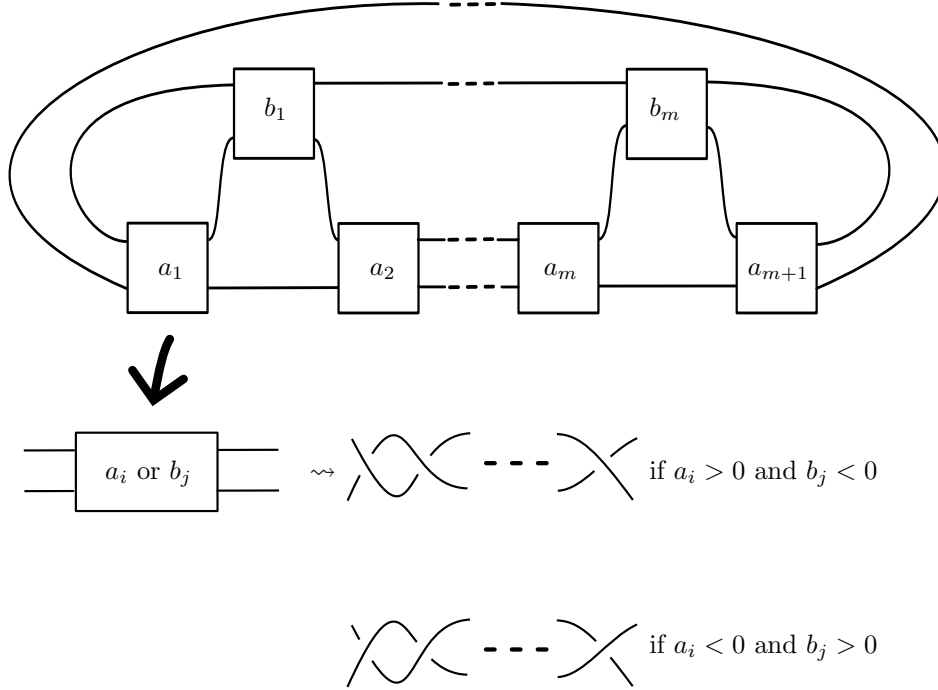

FIGURE 2. Conway form $C(a_1, b_1, \dots, a_m, b_m, a_{m+1})$.

2. A CONSTRUCTION OF f_2

In this section, we give a construction of a stable map $f_2 : S^3 \rightarrow \mathbb{R}^2$ satisfying $S_0(f_2) = L$ and $\Pi^3(f_2) = \emptyset$ for a two-bridge link L when L has a Conway form $C(a_1, b_1, \dots, a_m, b_m, a_{m+1})$ with all the b_i 's are even.

Let L be a two-bridge link in S^3 and $D = C(a_1, b_1, \dots, a_m, b_m, a_{m+1})$ a Conway form of L . We assume that b_i is an even number for all i . Next, we set a rectangular region E on the plane \mathbb{R}^2 which contains D inside. Let C be an immersed curve in E depicted in Figure 3.

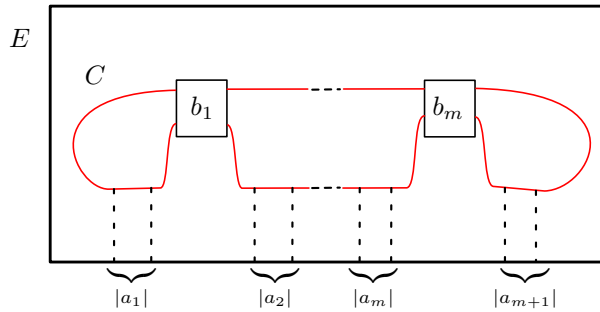

FIGURE 3. The immersed curve C .

In the figure, dotted lines are added to mark the crossings in the twists on D associated to the a_i 's. We take parallel segments $\gamma_1, \gamma_2, \dots, \gamma_n$ on E such that they separate E into strips, say, $T_0, T_1, T_2, \dots, T_n$ so that $T_k \cap C$ looks like a shape depicted in Figure 4 for each $k \in \{0, 1, \dots, n\}$. We refer to the rectangular regions separated by γ_k as Type 1, Type 2, Type 3 and Type 4, as shown in Figure 4.

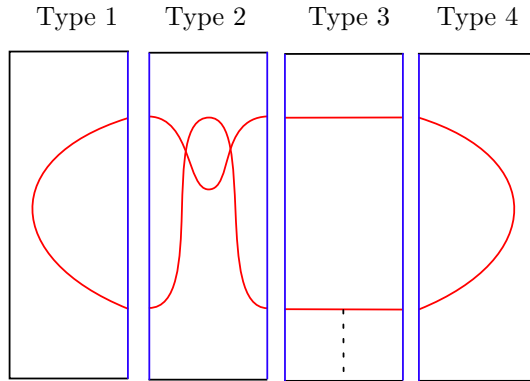

FIGURE 4. The four types of rectangular regions.

For each $k \in \{1, 2, \dots, n\}$, we construct a smooth map $\psi_k : F_k \rightarrow \gamma_k$ whose Reeb graph is the train track τ_k as shown in Figure 5, where F_k is homeomorphic to the 2-sphere S^2 . Note that ψ_k is a Morse function on $F_k \simeq S^2$.

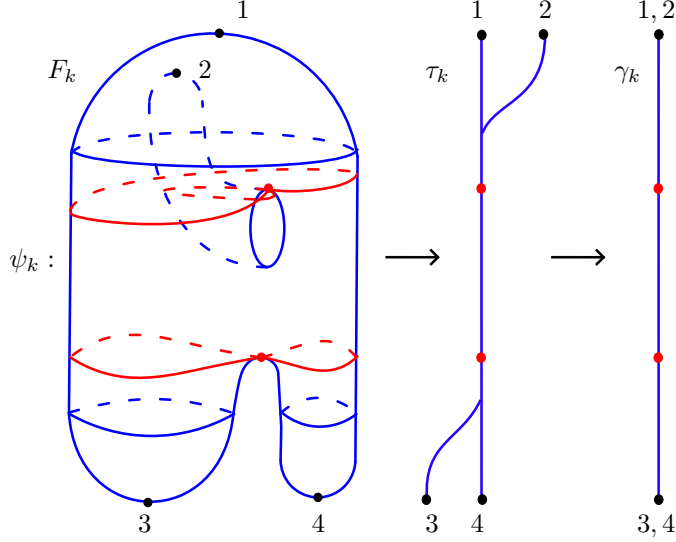

FIGURE 5. A Morse function $\psi_k : F_k \rightarrow \gamma_k \subset E$. The blue and green circles are regular fibers and the red curves are singular fibers.

The preimage of a line containing γ_k by a standard projection $\mathbb{R}^3 \rightarrow \mathbb{R}^2$ to obtain D from L can be regarded as a sphere embedded in S^3 . We identify it with F_k for each $k \in \{1, 2, \dots, n\}$. We decompose S^3 into $N_0, N_1, N_2, \dots, N_n$ by the spheres F_1, \dots, F_n . Here N_0 and N_n are homeomorphic to 3-balls and N_k is homeomorphic to $S^2 \times [0, 1]$ for each $k \in \{0, 1, \dots, n\}$. Then we will construct smooth maps $\Phi_k : N_k \rightarrow T_k$ as natural extensions of ψ_k 's by identifying $N_{k-1} \cap N_k$ with F_k for each type.

At first, for N_0 and for the rectangular region T_0 which is Type 1, we can construct a smooth map $\Phi_0 : N_0 \rightarrow T_0$ as the natural extension of ψ_1 by identifying F_1 with $N_0 \cap N_1$ as depicted in Figures 6 and 7. Also, for N_n and for the rectangular region T_n which is Type 4, we can construct a smooth map $\Phi_n : N_n \rightarrow T_n$ in the same way.

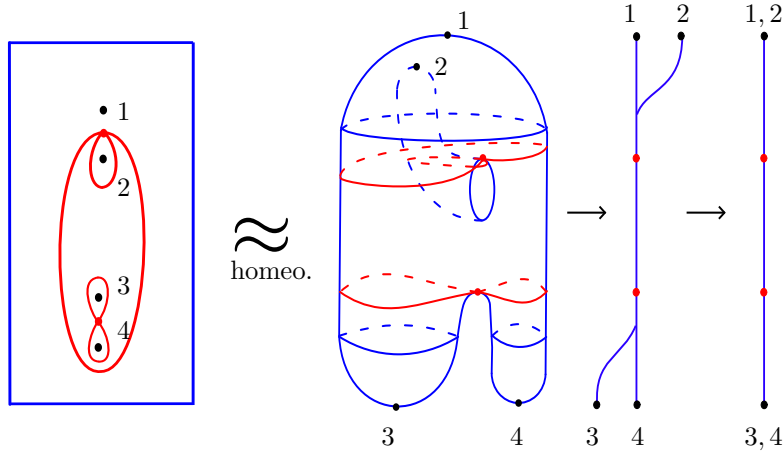

FIGURE 6. The Morse function ψ_1 on $F_1 \cong N_0 \cap N_1 \subset \mathbb{S}^3$. We number the $L \cap F_1$ by 1, 2, 3 and 4.

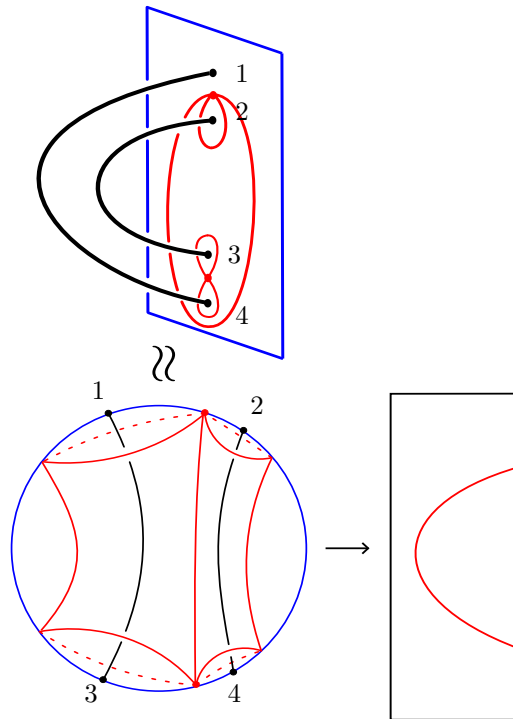

FIGURE 7. A smooth map from N_0 to the region T_0 of Type 1. The black arcs in N_0 are parts of the components of the two-bridge link. Each point on the arcs is a local singularity of definite fold type. The two red curves on F_1 are fibers each containing a singular point of indefinite fold type.

Secondly, for N_k and for the rectangular region T_k which is Type 2, we can construct a smooth map $\Phi_k : N_k \rightarrow T_k$ as natural extensions of ψ_k 's by identifying

F_k with $N_{k-1} \cap N_k$. In Figure 8, we describe a deformation between the Morse functions from ψ_k on $F_k \simeq N_{k-1} \cap N_k$ to ψ_{k+1} on $F_{k+1} \simeq N_k \cap N_{k+1}$.

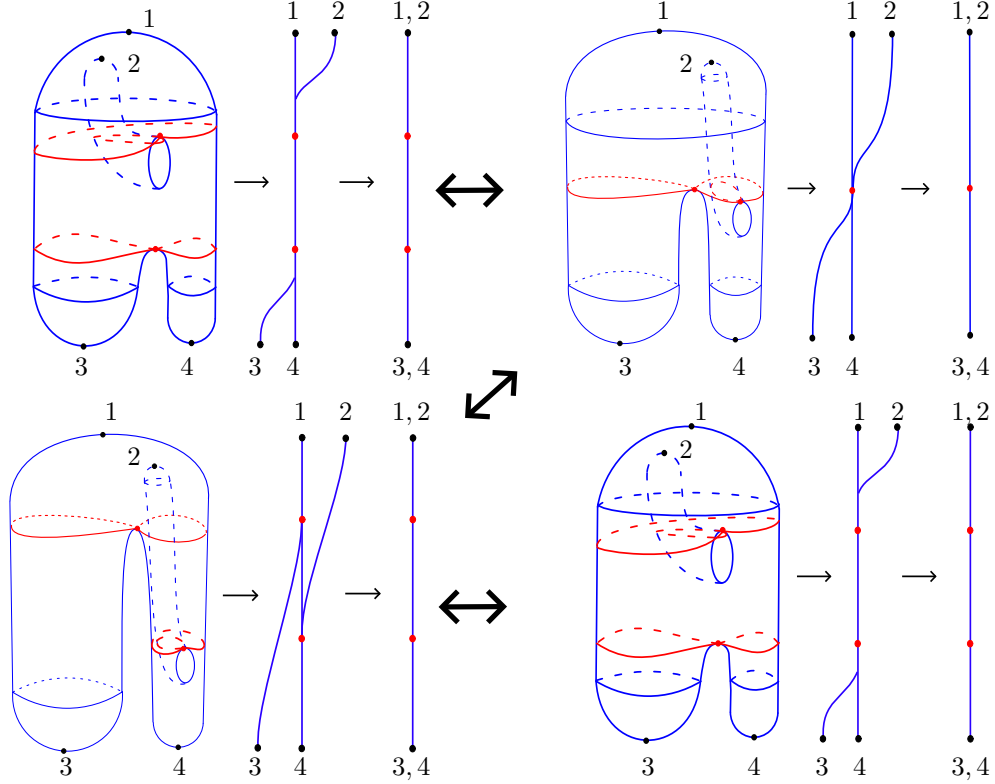

FIGURE 8. A deformation between the Morse functions from ψ_k to ψ_{k+1} . The intermediate F'_k and F'_{k+1} are 2-spheres.

Note that, during the deformation, the black points and the red curves move on the spheres as shown in Figure 9.

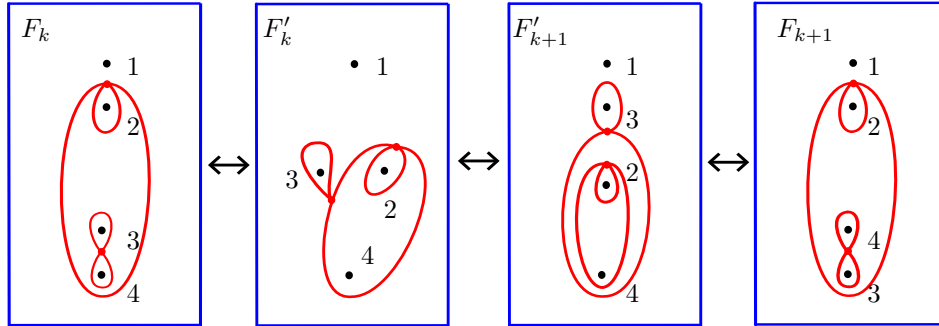

FIGURE 9. Moves of the black points and the red curves on $F_k \simeq N_{k-1} \cap N_k$, F'_k , F'_{k+1} and $F_{k+1} \simeq N_k \cap N_{k+1}$.

Using the deformation given in Figure 8 and moves of the points and curves shown in Figure 9, we can construct a smooth map $\Phi_k : N_k \rightarrow T_k$ as natural extensions of ψ_k 's by identifying F_k with $N_{k-1} \cap N_k$ as illustrated in Figure 10.

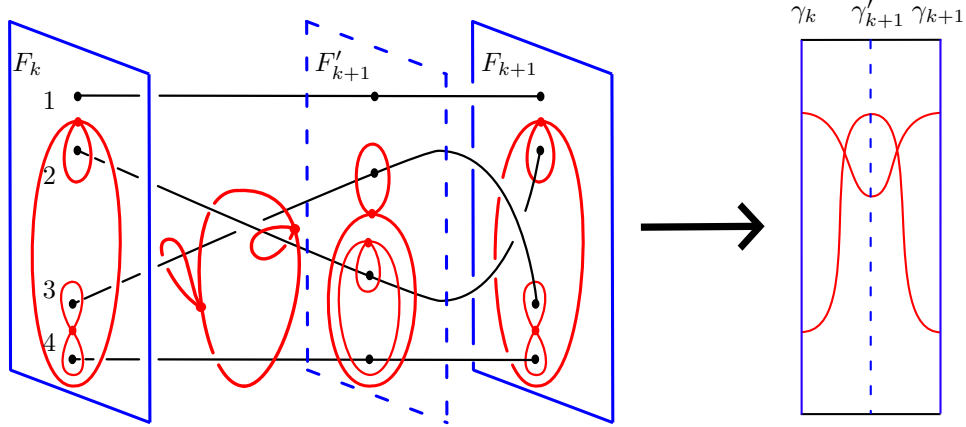

FIGURE 10. a smooth map $\Phi_k : N_k \rightarrow T_k$ for T_k of Type 2.

Thirdly, for N_k and for the rectangular region T_k which is Type 3, we can construct a smooth map $\Phi_k : N_k \rightarrow T_k$ as natural extensions of ψ_k 's by identifying F_k with $N_{k-1} \cap N_k$ as depicted in Figure 11.

Type 3

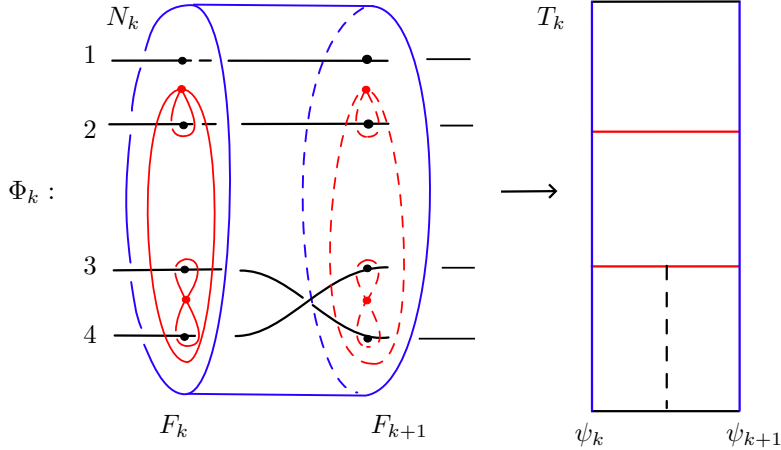

FIGURE 11. A smooth map to the region of type 3.

We connect N_0, N_1, \dots, N_{n-1} and N_n by identifying the boundaries of them to make S^3 . Moreover, we connect T_0, T_1, \dots, T_{n-1} and T_n by identifying $\gamma_1, \dots, \gamma_n$ to make E . Then, a smooth map $f_2 : S^3 \rightarrow \mathbb{R}^2$ satisfying $f_2|_{N_k} = \Phi_k$ for $k \in \{0, 1, 2, \dots, m\}$ is constructed. By construction, this map f_2 is a stable map from S^3 into \mathbb{R}^2 with desired properties. \square

Example 2.1. A stable map f from S^3 with the figure-eight knot as $S_0(f)$ obtained by the construction given in this section is presented in Figure 12.

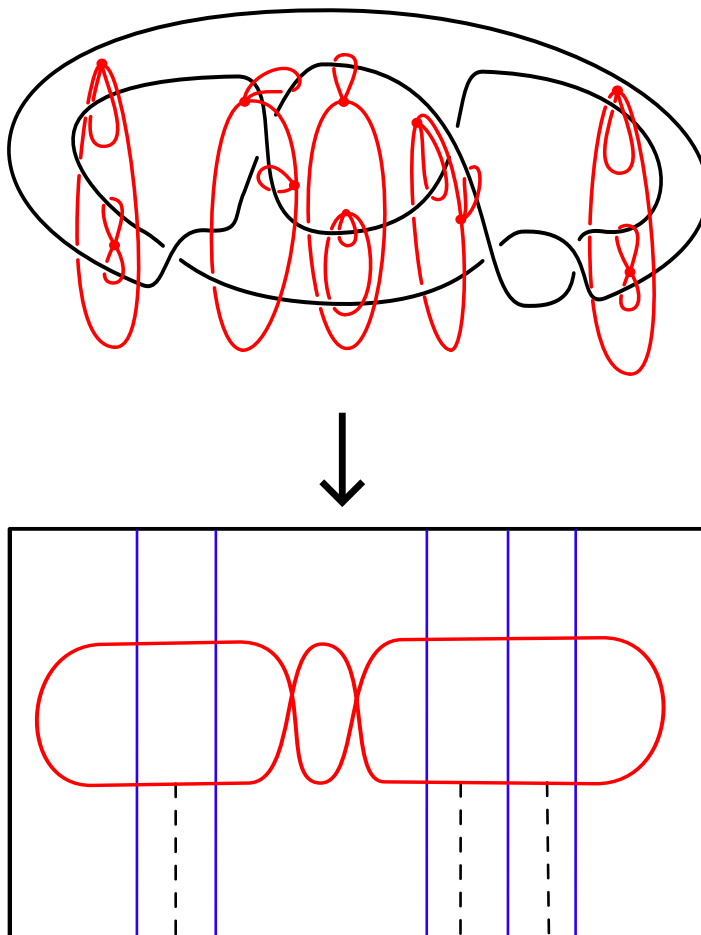

FIGURE 12. The figure eight knot.

Example 2.2. A stable map f from S^3 with the White head link as $S_0(f)$ obtained by the construction given in this section is presented in Figure 13.

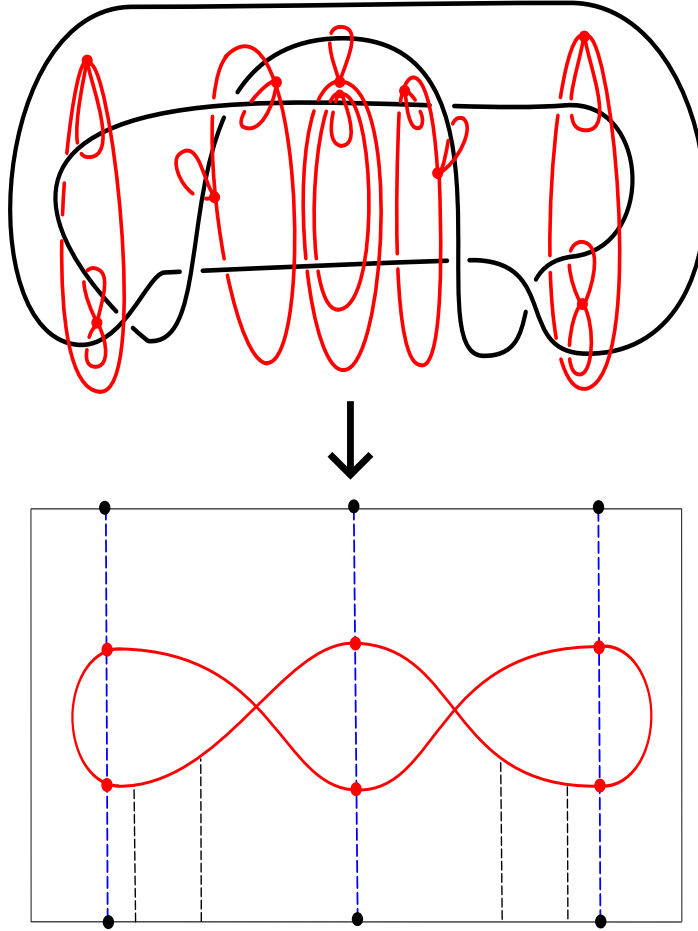

FIGURE 13. The White head link.

3. A CONSTRUCTION OF f_3

In this section, we give a construction of a stable map $f_3 : S^3 \rightarrow \mathbb{R}^2$ satisfying $S_0(f_3) = L$ and $\Pi^2(f_3) = \emptyset$ for a two-bridge link L when L has a Conway form $C(a_1, b_1, \dots, a_m, b_m, a_{m+1})$ with all the b_i 's are even.

Let L be a two-bridge link in S^3 and $D = C(a_1, b_1, \dots, a_m, b_m, a_{m+1})$ a Conway form of L . We assume that b_i is an even number for all i . Again, in the same way as in the previous section, we set a rectangular region E on the plane \mathbb{R}^2 which contains D inside. Let C be the immersed curve on the plane obtained by modifying the one shown in Figure 3 at all the bigon regions as illustrated in Figure 14.

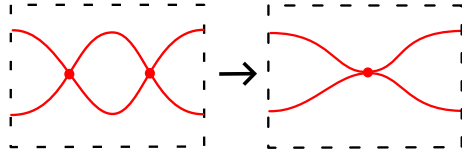

FIGURE 14. modifying the regions.

Similar to Section 2, we separate E including C . In addition to Type 1, Type 3 and Type 4 in Figure 4, we need one more type, say Type 2' shown in Figure 15.

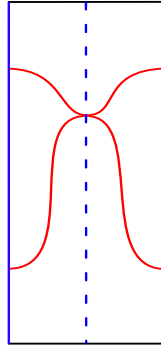

FIGURE 15. Type 2'.

We can construct a stable map f_3 in the same way as for f_2 except on the rectangular regions of Type 2 in Figure 4. For Type 2', we construct Φ_k as shown in Figure 16.

As before, we connect N_0, N_1, \dots, N_{n-1} and N_n by identifying the boundaries of them to make S^3 and connect T_0, T_1, \dots, T_{n-1} and T_n by identifying $\gamma_1, \dots, \gamma_n$ to make E . Then, a smooth map $f_3 : S^3 \rightarrow \mathbb{R}^2$ satisfying $f_3|_{N_k} = \Phi_k$ for $k \in \{0, 1, 2, \dots, m\}$ is obtained. By construction, this map f_3 is a stable map from S^3 into \mathbb{R}^2 with desired properties. \square

Type 2'

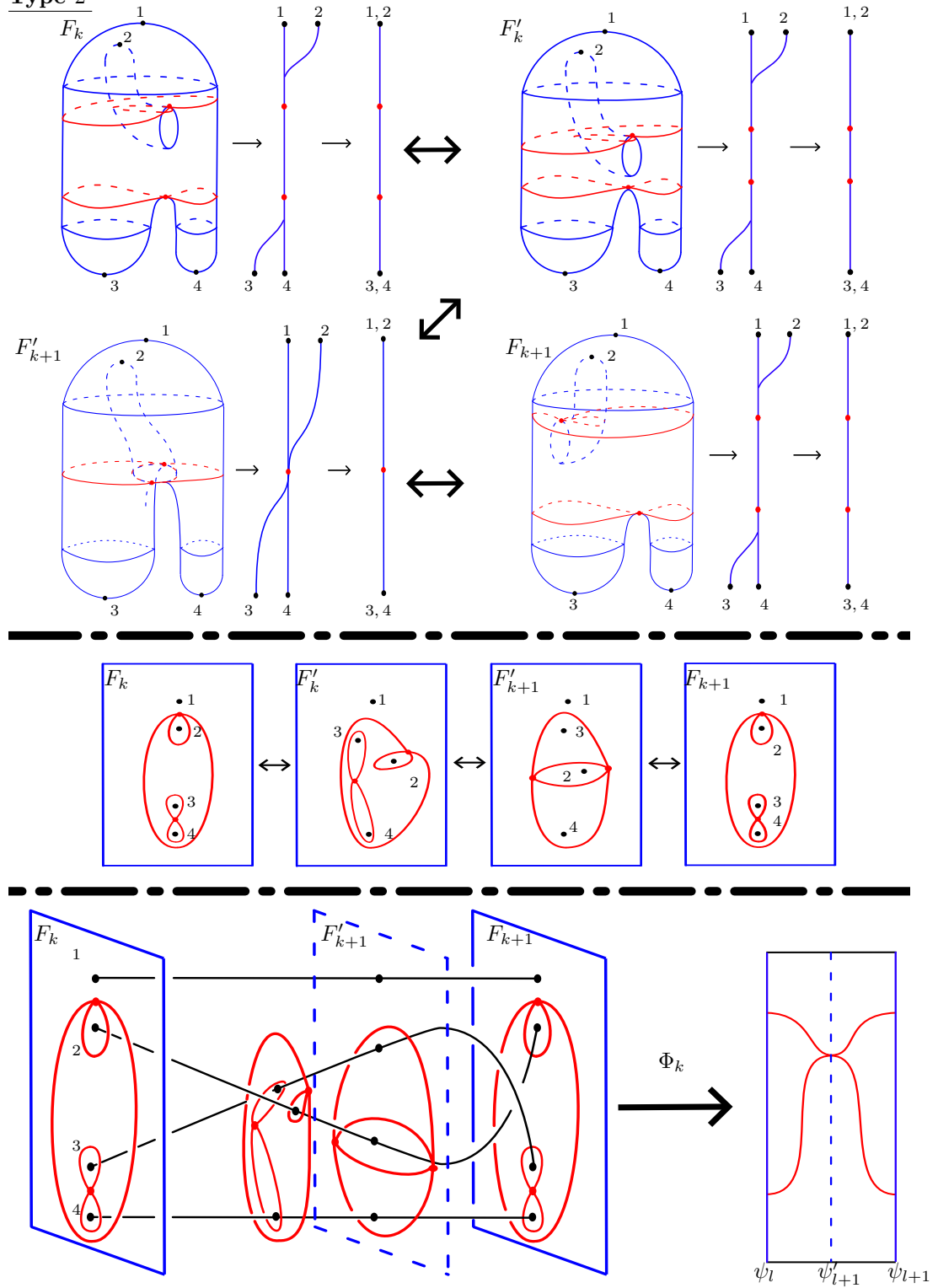

FIGURE 16. A smooth map to the region of type 2'.

Example 3.1. A stable map f from S^3 with the White head link as $S_0(f)$ obtained by the construction given in this section is presented in Figure 17.

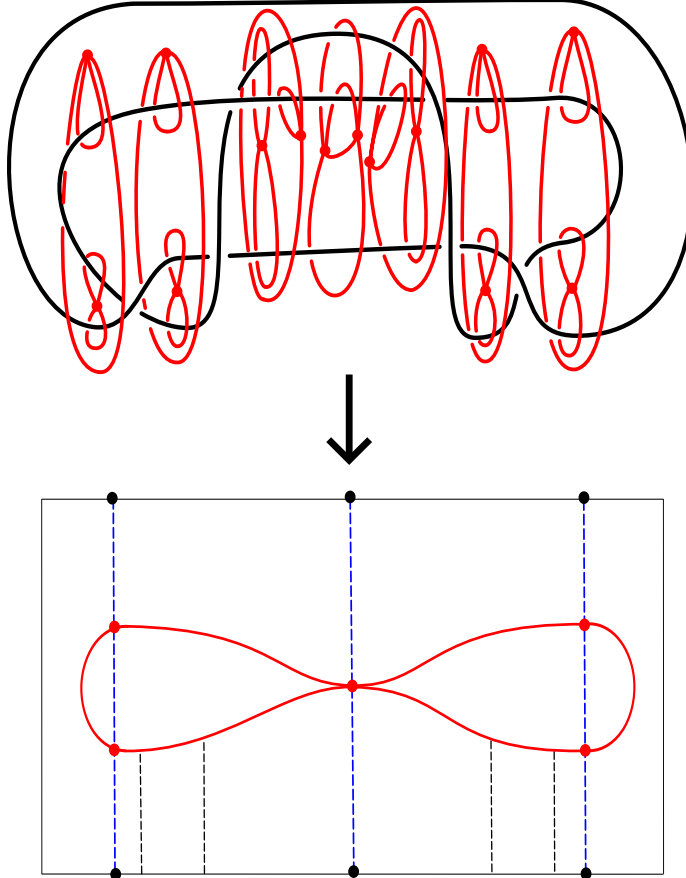

FIGURE 17. Whitehead link.

4. STABLE MAP COMPLEXITIES

In [3, Section 6], the relationship between stable map complexities and hyperbolic volumes for 3-manifolds is discussed. In this section, based on that, we give an estimate on stable map complexities of two-bridge link exteriors by using the constructions given in the previous sections.

In [3], the following relationship between the hyperbolic volumes and the stable map complexities is obtained. Let M be a compact 3-manifold M with (possibly empty) boundary consisting of tori. Suppose that the interior $\text{int}M$ of M admits a complete hyperbolic metric of finite volume. Then,

$$(1) \quad \text{vol}(M) \leq 2V_{oct} \text{smc}(M)$$

holds, where $\text{vol}(M)$ denotes the hyperbolic volume of $\text{int}M$, $\text{smc}(M)$ the *stable map complexity* of M , that is, the minimal number of the weighted sums $|\mathbb{I}^2(f)| + 2|\mathbb{I}^3(f)|$ for any stable map $f : M \rightarrow \mathbb{R}^2$, and V_{oct} the volume of the ideal regular octahedron which is approximately 3.6638.

Let L be a two-bridge link in S^3 which admits a Conway form $C(a_1, b_1, \dots, a_m, b_m, a_{m+1})$ with all the b_i 's are even. Then, by Theorem 1.1, we have a stable map of S^3 to \mathbb{R}^2 with the definite fold point set equals L and $\mathbb{I}^3(f_2) = \emptyset$. From this map, by removing an open tubular neighborhood $N(L)$ of L from S^3 suitably, a stable map $f : E(L) \rightarrow \mathbb{R}^2$ is obtained for the exterior $E(L) = S^3 \setminus N(L)$. This map f satisfies that $|\mathbb{I}^2(f)| = \sum_{i=1}^m b_i$ and $\mathbb{I}^3(f_2) = \emptyset$, and so,

$$|\mathbb{I}^2(f)| + 2|\mathbb{I}^3(f)| = \sum_{i=1}^m b_i.$$

This gives

$$(2) \quad \text{smc}(E(L)) \leq \sum_{i=1}^m b_i$$

for the two-bridge link L .

On the other hand, if the Conway form $C(a_1, b_1, \dots, a_m, b_m, a_{m+1})$ is a reduced alternating diagram, equivalently, all the a_i 's and b_j 's are at least 2, then the following holds by [2, Theorem B.3]. Let $D = C(a_1, b_1, \dots, a_m, b_m, a_{m+1})$ be a reduced alternating diagram of a hyperbolic two-bridge link L . Then

$$(3) \quad 2v_{\text{tetra}}\text{tw}(D) - 2.7066 < \text{vol}(S^3 \setminus L) < 2v_{\text{oct}}\text{tw}(D)$$

holds and actually $\text{tw}(D) = 2m + 1$. Here, the *twist number* $\text{tw}(D)$ denotes the number of equivalence classes of crossings, where two crossings are considered equivalent if there is a loop in the projection plane intersecting D transversely precisely in the two crossings and v_{tetra} the volume of the ideal regular tetrahedron which is approximately 1.0149.

By combining Equations (1), (2), and (3), we have the following.

$$(4) \quad 1.108m - 0.184 < \text{smc}(E(L)) \leq \sum_{i=1}^m b_i.$$

For example, all the b_j 's are equal to 2, then we get

$$1.108m - 0.184 < \text{smc}(E(L)) \leq 2m,$$

and further, if $m = 1$, that is, if L is represented by the Conway form $C(a_1, 2, a_2)$ with $a_1, a_2 \geq 2$, then we have

$$0.924 < \text{smc}(E(L)) \leq 2,$$

that is, $\text{smc}(E(L))$ is 1 or 2. In fact, by the results of [3] and [1], it is shown that $\text{smc}(E(L)) = 2$ in this case.

ACKNOWLEDGEMENTS

We would like to thank Osamu Saeki, Masaharu Ishikawa, Yuya Koda, and Ryoga Furutani for their helpful advice.

REFERENCES

1. Ryoga Furutani and Yuya Koda, *Stable maps and hyperbolic links*, to appear in Comm. Anal. Geom.
2. François Guéritaud, *On canonical triangulations of once-punctured torus bundles and two-bridge link complements*, Geom. Topol. **10** (2006), 1239–1284, With an appendix by David Futer. MR 2255497
3. Masaharu Ishikawa and Yuya Koda, *Stable maps and branched shadows of 3-manifolds*, Math. Ann. **367** (2017), no. 3-4, 1819–1863. MR 3623239
4. A. Kawauchi, *A survey of knot theory*, Birkhäuser Basel, 2012.
5. Harold I. Levine, *Elimination of cusps*, Topology **3** (1965), no. suppl, 263–296. MR 176484
6. Osamu Saeki, *Simple stable maps of 3-manifolds into surfaces*, Topology **35** (1996), no. 3, 671–698. MR 1396772

DEPARTMENT OF MATHEMATICS, COLLEGE OF HUMANITIES AND SCIENCES, NIHON UNIVERSITY,
3-25-40 SAKURAJOSUI, SETAGAYA-KU, TOKYO 156-8550, JAPAN

Email address: `ichihara.kazuhiro@nihon-u.ac.jp`

GRADUATE SCHOOL OF INTEGRATED BASIC SCIENCES, NIHON UNIVERSITY, 3-25-40 SAKURAJOSUI,
SETAGAYA-KU, TOKYO 156-8550, JAPAN