

Naively Sorting Evolving Data is Optimal and Robust

George Giakkoupis*
Inria, Rennes, France
george.giakkoupis@inria.fr

Marcos Kiwi†
Universidad de Chile, Santiago, Chile
mk@dim.uchile.cl

Dimitrios Los‡
University of Cambridge, UK
mail@dimitrioslos.com

Abstract

We study comparison sorting in the *evolving data model* [AKMU11], where the true total order changes *while* the sorting algorithm is processing the input. More precisely, each comparison operation of the algorithm is followed by a sequence of evolution steps, where an evolution step perturbs the rank of a random item by a “small” random value. The goal is to maintain an ordering that remains close to the true order over time. Previous works have analyzed adaptations of classic sorting algorithms, assuming that an evolution step changes the rank of an item by just one, and that a fixed constant number b of evolution steps take place between two comparisons. In fact, the only previous result achieving optimal $O(n)$ total deviation from the true order, where n is the number of items, applies just for $b = 1$ [BVDE⁺18a].

We analyze a very simple sorting algorithm suggested in [Mah14], which samples a random pair of adjacent items in each step and swaps them if they are out of order. We show that the algorithm achieves and maintains, with high probability, optimal total deviation, $O(n)$, and optimal maximum deviation, $O(\log n)$, under very general model settings. Namely, the perturbation introduced by each evolution step is sampled from a general distribution of bounded moment generating function, and we just require that the *average* number of evolution steps between two sorting steps be bounded by an (arbitrary) constant, where the average is over a linear number of steps.

The key ingredients of our proof are a novel potential function argument that inserts “gaps” in the list of items, and a general analysis framework which separates the analysis of sorting from that of the evolution steps, and is applicable to a variety of settings for which previous approaches do not apply. Our results settle conjectures by [AKMU11] and [Mah14], and provide theoretical support for the empirical evidence that simple quadratic algorithms are optimal and robust for sorting evolving data [BVDE⁺18b].

Simple example B

*Supported in part by Agence Nationale de la Recherche (ANR) under project ByBloS (ANR-20-CE25-0002).

†Supported by FB210005, BASAL funds for Centers of Excellence from ANID-Chile, and GrHyDy ANR-20-CE40-0002.

‡Supported by the LMS Early Career Fellowship (ref. 2024-19).

1 Introduction

We consider the problem of sorting in the *evolving data model*, introduced by Anagnostopoulos, Kumar, Mahdian and Upfal [AKMU09, AKMU11]. In this model, the input data are changing slowly while the algorithm is processing them. Changes to the data typically follow some simple stochastic process, and they are not directly communicated to the algorithm when they occur; instead the algorithm has query access to the data. The challenge for the algorithm is then to maintain over time an output close to the correct output for the current state of the data. This model is different from the standard dynamic (graph) algorithm model [DEGH10], which assumes that changes are adversarial but are reported to the algorithm. Also, the focus of the evolving data model is on query complexity rather than computational complexity, in particular, on the rate of queries of the algorithm relative to the rate at which the data are changing.

Several classic problems have been studied in the evolving data model, from stable matching with evolving preferences [KLM16], to community detection [ALL⁺16] and PageRank computation in evolving graphs [BKMU12] (see section Other Related Work). We focus on the problem of sorting a set S of n items, when the true underlying total order ρ of S changes gradually over time. The sorting algorithm, which may only perform pairwise comparisons, is tasked with maintaining an ordering ν on S that is a close approximation to the true order ρ . We will assume, without loss of generality, that $S = [n]$ and thus ρ and ν are permutations on $[n]$.

The above sorting problem arises naturally in various real-life settings where ranks are evolving over time, and comparisons tend to be slow or expensive. For example, ranking tennis or chess players whose abilities change over time, based on head-to-head matches [Gli02]; maintaining a ranking of a set of sports teams, whose competitiveness varies during a season; ranking political candidates, where comparisons involve running a debate or doing a poll; ranking movies, songs, or websites, where comparisons involve an online survey or A/B testing.

Sorting was the first problem to be studied in the evolving data model [AKMU11]. The precise model considered was that each step of the algorithm is followed by b evolution steps, for some constant $b \geq 1$. A step of the algorithm involves a pairwise comparison between the ranks in ρ for two items in S (specified by the algorithm), followed by arbitrary updates to the maintained order ν . An evolution step consists of a *random adjacent rank swap*, i.e., swapping $\rho(i)$ and $\rho(i+1)$ for an index $i \in [n-1]$ sampled uniformly at random. No memory or computational constraints are imposed on the sorting algorithm, which is executed by a central agent.

It was shown in [AKMU11] that repeated application of classic randomized Quicksort achieves, after the first $O(n \log n)$ steps, maximum deviation $\max_{i \in [n]} |\nu(i) - \rho(i)| = O(\log n)$ between the maintained and the true orders with high probability (w.h.p.),¹ and thus total deviation $\sum_{i \in [n]} |\nu(i) - \rho(i)| = O(n \log n)$.² Moreover, a refined algorithm, which runs Quicksort interleaved with copies of Quicksort on smaller ranges of the maintained list, achieves total deviation $O(n \log \log n)$. On the lower bound side, it was shown that for any algorithm the total deviation is $\Omega(n)$ w.h.p., and it was conjectured to be tight for any $b \geq 1$.

Besa Vial et al. [BVDE⁺18a] confirmed the conjecture for the special case of $b = 1$, where each sorting step is followed by exactly one random adjacent rank swap. For this setting, they showed that Insertion Sort achieves $O(n)$ total deviation w.h.p., after the first $O(n^2)$ steps (and combining it with Quicksort reduces the steps required to $O(n \log n)$). Since their analysis relied heavily on the assumption that $b = 1$, they left open the problem of achieving linear total deviation in the general case.

In parallel, experimental work by Besa Vial et al. [BVDE⁺18b] suggested that several quadratic algorithms, namely, Bubble Sort, Cocktail Sort, and Insertion Sort, all achieve linear total deviation for any constant rate b of adjacent rank swaps, and even when random adjacent swaps are replaced by more general,

¹With high probability refers to probability of at least $1 - n^{-c}$ for some constant $c > 0$.

²In fact, the actual bound was expressed in terms of the Kendall-tau distance which is equal to the total deviation within a factor of 2 (see Definition 2 and Eq.(2).)

local rank perturbations (as we discuss below). They posed as an interesting problem to provide theoretical analyses supporting these empirical results.

Our Contributions. Since the problem of evolving sorting was first introduced [AKMU09], it has been suspected that the following basic randomized algorithm is asymptotically optimal, achieving linear total deviation (see, for example, the talk by Mahdian [Mah14]).

Naïve Sort: In each step, chose a uniformly random pair of adjacent items and swap them if they are out of order.³

Naïve Sort has several attractive properties: It is extremely simple; it has minimal memory requirements, in fact, there is no need to maintain any state from one step to the next; and it is inherently parallelizable. Also, it has quadratic comparison complexity (w.h.p.) [GSS23], similarly to Bubble Sort, Cocktail Sort, and Insertion Sort.

We show that Naïve Sort achieves indeed optimal asymptotic deviation, in a robust manner. We analyze Naïve Sort under a general model, which extends the original model in two ways. First, instead of random adjacent rank swaps, we assume more general *local rank perturbations*:

Local rank perturbation step: We sample an integer s from a distribution of zero mean and bounded moment generating function; then we successively swap the rank of a uniformly random item with the ranks of its s succeeding items in ρ if $s > 0$, or with the ranks of its $-s$ preceding items in ρ if $s < 0$ (see formal Definition 3).

Second, rather than assuming that the number of evolution steps between two consecutive sorting steps is a fixed number b , we just assume that it is bounded *on average*, where the averaging is over a linear number of steps.

Bounded average rate of evolution steps: Let b_i , for $i \geq 1$, be the number of evolution steps between the i th and $(i + 1)$ th sorting steps. Then,

$$\sum_{i=t+1}^{t+n} b_i \leq b \cdot n, \quad \text{for all } t \geq 0, \quad (1)$$

where b can be an arbitrary constant (see Definition 4).

Our main result can then be stated as follows.

Theorem 1. *Under evolution steps that are local rank perturbations and occur at bounded average rate, it holds for any $t = \Omega(n^2)$ large enough, that after t steps of Naïve Sort, the maximum deviation between the maintained order ν and the true order ρ is $O(\log n)$ and their total deviation is $O(n)$ w.h.p.*

Our linear bound on the total deviation is optimal due to the lower bound of [AKMU11]. The logarithmic bound on the maximum deviation is also optimal. In fact, we prove a more general bound of $O(b \log n)$ on the maximum deviation, which applies even when b in Eq. (1) is super-constant. It is not difficult to prove that this is optimal (see Lemma 27).

The requirement in Theorem 1 that $t = \Omega(n^2)$, for the number of sorting steps t before the claimed deviation bounds are achieved, is in place to cover the worst-case initialization. We show that a more refined requirement suffices, namely, that $t = \Omega(n \cdot (\Delta + \log n))$, where Δ is the maximum deviation initially (and

³We coined the name ‘Naïve Sort’ after failing to find an established name for this algorithm in the literature.

moreover this is tight—see [Lemma 28](#)). Also, similarly to [\[BVDE⁺18a\]](#), it is possible to combine Naïve Sort with Quicksort to ensure it suffices that $t = \Omega(n \cdot \log n)$, for all initializations.

Prior to our work, no algorithm was known to achieve linear total deviation, even in the original model (with random adjacent rank swaps, and constant number b of evolution steps between sorting steps), when $b \geq 2$. In particular, the algorithms of [\[AKMU11\]](#) achieve super-linear total deviation, and [\[BVDE⁺18a\]](#) prove linear total deviation only for $b = 1$ (and have no upper bounds on the maximum deviation).

Thus, [Theorem 1](#) settles the conjecture of [\[AKMU11\]](#) that there is an algorithm achieving linear total deviation for their original model in the general case of $b \geq 2$, and also the more specific conjecture of [\[Mah14\]](#) that this is achievable by Naïve Sort.

More general models have been considered before only experimentally, in [\[BVDE⁺18b\]](#). In fact, the *hot spot adversary* proposed there is a special case of our model of local rank perturbations, where s is sampled from a geometric distribution with constant success probability and then its sign is flipped with probability $1/2$.⁴ Our results thus provide theoretical support for the empirical evidence in [\[BVDE⁺18b\]](#) that simple quadratic algorithms are optimal and robust for sorting evolving data, even under more general assumptions than considered empirically before.

Technical Overview. We give now an overview of the key ideas used in the proof of [Theorem 1](#). Instead of working with ν and ρ , it suffices to work with a single permutation π on $[n]$ such that $\pi(i) = j$ if $\nu(i) = \rho(j)$. The maximum and total deviation of π (from the identity permutation) are then the same as respectively the maximum and total deviation between ν and ρ , and Naïve Sort under local rank perturbations can be described in terms of π as follows. Let π_t denote the permutation after t steps. If step $t + 1$ is a sorting step, then a random pair $\pi_t(i), \pi_t(i + 1)$ is chosen and is swapped if it is out of order, i.e., if $\pi_t(i) > \pi_t(i + 1)$; while if step $t + 1$ is an evolution step, which we call a *mixing step* from now on, then a random item i and a random perturbation s are picked, and $\pi_t^{-1}(i)$ is swapped with its s succeeding or $-s$ preceding items (if $s < 0$) in the inverse permutation π_t^{-1} .

The first key idea we employ is a novel potential function argument, which relies on inserting ‘gaps’ between the elements of permutation π_t . For Naïve Sort in the non-evolving setting (i.e., in the absence of mixing steps), there is already an elegant potential function argument that shows $\Theta(n^2)$ running time w.h.p., by Gasieniec, Spirakis and Stachowiak [\[GSS23\]](#). Their proof first applies the standard 0/1 principle, which reduces the problem to sorting a list of 0’s and 1’s [\[Knu98, Section 5.3.4\]](#). It then analyzes a potential function where each 1 contributes an exponential term, whose exponent depends on the number of preceding 0’s and the number of succeeding 1’s. Unluckily, the 0/1 principle no longer applies under mixing steps. Yet, it is still instructive to attempt to adapt their potential function for a 0/1 list, to our permutation setting. A natural choice is potential function $\sum_i (2^{|i - \pi_t(i)|} - 1) \cdot 2^{\pi_t(i)}$, where $|i - \pi_t(i)|$ is the deviation of item at position i from its correct position $\pi_t(i)$. We first observe that the simpler potential $\sum_i (2^{|i - \pi_t(i)|} - 1)$ does not work, even without mixing steps. The problem is due to sorted blocks (i.e., maximal contiguous sequences of sorted items) whose contribution to the potential can drop only if the first or last item in the block is selected. E.g., in permutation $\pi_t = (5, 6, 7, 8, 1, 2, 3, 4)$ the potential decreases only if 8 and 1 are swapped, and thus the simpler potential drops in expectation just by a factor of $1 - \Theta(n^{-2})$ (whereas we would like to drop by a factor of $1 - \Omega(n^{-1})$). This issue is handled by the additional factor of $2^{\pi_t(i)}$, which gives more weight to the contribution of larger items. Even though this works fine if there are no mixing steps, it no longer works with mixing steps. Such a step may drastically increase the potential, e.g., by swapping items i and $i + 1$, for a large i , when the two items are already at the right position, thus increasing their contribution to the potential from 0 to $2^i + 2^{i+1}$.

Instead of analyzing directly the evolution of permutation π_t , in our proof we consider a larger list l_t of size roughly nd , for some constant integer $d > 1$. The list is obtained by inserting ‘gaps’, denoted by \perp , to

⁴Actually, the hot spot adversary was an inspiration for our local rank perturbation model.

the permutation list $(\pi_t(1), \pi_t(2), \dots, \pi_t(n))$. The sorted state of l_t is the one where $l_t[d \cdot i] = i$ for each $i \in [n]$, and $l_t[j] = \perp$ for the remaining indices j . In general, the placement of gaps can be arbitrary, subject to satisfying a simple *local invariant*, namely, that there is no gap to the left (right) of item i if its target position $d \cdot i$ is to its left (resp. right). Each sorting and mixing step on π_t translates then directly into a similar step in l_t , involving the same items.

The above elementary transformation of the problem, from sorting a permutation π_t to sorting a list l_t with gaps, serves the following purpose. The natural potential function $\sum_i (2^{|i - \pi_t(i)|} - 1)$, which, as we saw earlier, does not behave as we wanted, works extremely well when applied to l_t ; the precise potential function is now $\sum_{l_t[j] \neq \perp} (e^{\alpha \cdot |j - d \cdot l_t[j]|} - 1)$, where $\alpha > 0$ is a constant. In particular, the problem we had before with sorted blocks is no longer an issue, because now the contribution to the potential function of a sorted block (without gaps) is dominated by the contribution of the first (or last) item of the block. It is then not difficult to show that, in the absence of mixing steps, the exponential function drops by the desirable rate of $1 - \Omega(n^{-1})$. Hence, there is no need for the exponential weight factor used in the approach based on [GSS23], which was a main obstacle to our handling of mixing steps. Further, the simpler potential function facilitates the technique we describe next, for analyzing independently sorting and mixing steps.

The second key idea of the proof is a way to separate the analysis of the sorting steps from that of the mixing steps. The idea is to allow the target position of each item i in the list l_t to *move* during the process. For that, we rely on an additional permutation τ_t on $[n]$, and let the target position of item i in list l_t be $d \cdot \tau_t(i)$. (τ_0 is the identity permutation, thus the initial target position of i is $d \cdot i$.) Each time a mixing step occurs, we modify also τ_t by swapping $\tau_t(i)$ with its s preceding or s succeeding items in τ_t , where i and s are the item and perturbation selected at the mixing step; when a sorting step occurs, τ_t does not change. In addition, in each step we must maintain a basic invariant, called *admissibility condition*, which may require swapping some pairs in τ_t at the end of the step (see Definition 8); but such swaps are favorable for our analysis.

Using $d \cdot \tau_t(l_t[j])$ as the target position for each element $l_t[j]$, instead of $d \cdot l_t[j]$, we can apply the same potential function analysis as in the case without mixing steps; precisely the potential function is $\Phi_t = \sum_{l_t[j] \neq \perp} (e^{\alpha \cdot |j - d \cdot \tau_t(l_t[j])|} - 1)$. In the analysis of Φ_t we can ignore mixing steps because our construction ensures that a mixing step cannot increase Φ_t . And as before we have that Φ_t decreases in expectation by a factor of $1 - \Omega(n^{-1})$ with each sorting step.

We analyze separately the deviation of τ_t using another potential function, $\Psi_t = \sum_i e^{\alpha' \cdot |i - \tau_t(i)|} = \sum_i e^{\alpha' \cdot |\tau_t^{-1}(i) - i|}$. In the absence of sorting steps, and if it were $s = 1$ for all mixing steps, then the differences $\tau_t^{-1}(i) - i$ would evolve similarly to simple (unbiased) random walks. Our construction ensures that sorting steps cannot increase potential Ψ_t , and the assumption that s has bounded MGF means that $\tau_t^{-1}(i) - i$ is still close to a simple random walk. We thus use Ψ_t to show that the maximum deviation of τ_t after $t = k \cdot n$ steps is at most $O(\sqrt{k \log n})$ w.h.p.

From the two results above, for the sorting and mixing steps, we have that starting from a maximum deviation of k for π_0 , and thus $\Phi_0 \leq n \cdot e^{O(k)}$, it takes $t = O(k \cdot n)$ steps before $\Phi_t = O(n)$, and at that point the maximum deviation of τ_t is $O(\sqrt{k \log n})$. It follows that the maximum deviation of π_t at that moment is $O(\log n + \sqrt{k \log n})$. Iterating the argument, we show that for any initialization, after $t = \Theta(n^2)$ steps, the maximum deviation of π_t is $O(\log n)$ w.h.p.

The last key component of the analysis is a method to refine the above argument that bounds the maximum deviation, to establish a linear total deviation bound for π_t . As is, the above argument gives just $O(n \log n)$ total deviation. The problem is that potential Ψ_t can only be used to bound the maximum deviation of τ_t , and provides little information about the total deviation of τ_t .

We show that unlike the maximum deviation of τ_t which grows to $O(\sqrt{k \log n})$ after $t = k \cdot n$ steps, most of the deviation terms $|i - \tau_t(i)|$ are concentrated around \sqrt{k} . In particular, the sum of all deviation terms larger than $k^{2/3}$ is $o(n)$ w.h.p. This facilitates the following approach. Starting from maximum deviation

$k = \Theta(\log n)$ for π_t , and thus $\Phi_t \leq n \cdot e^{O(k)}$, we consider a phase of $O(k \cdot n)$ steps until $\Phi_t = O(n)$. At the end of the phase we perform a “partial target reset,” which roughly amounts to setting $\tau_t(i) = i$ for all i such that $|\tau_t(i) - i| \leq k^{2/3}$ and leaving unchanged the remaining entries. The unchanged entries contribute just $o(n)$ to the total deviation of τ_t , while the partial reset ensures that potential Φ_t drops to $n \cdot e^{O(k^{2/3})}$. We then iterate the above, with the length of the phase reduced from k to $O(k^{2/3})$. After a few such phases we obtain that $\Phi_t = O(n)$ and also the total deviation of τ_t is $O(n)$, which together imply the desired linear total deviation of π_t . We formalize this argument by introducing another permutation σ_t on $[n]$, which is reset to the identity permutation at the beginning of each of the iterations above, and is updated according to the same rules as τ_t (which is only partially reset). Potential Ψ_t is then defined in terms of σ_t rather than τ_t . And the proof proceeds by showing that in each phase, τ_t and σ_t remain close to each other, while potential Φ_t drops to $O(n)$, and potential Ψ_t does not increase much.

Previous techniques were sensitive to the specific settings analyzed. Here, we demonstrate that the use of potential function arguments allows us to overcome several obstacles that hindered those techniques, and analyze an extremely general setting. In this paper, we are focused on the fundamental problem of sorting, and hope that techniques therein extend to other problems with evolving data.

Other Related Work. A problem related to evolving sorting is the well-studied problem of noisy sorting [FRPU94, BM08, GX23]. The assumption there is that there is a fixed underlying total order, but the outcome of pairwise comparisons may be incorrect. Depending on the precise setting, the goal may be to find the most likely total order, e.g., when comparisons are permanently incorrect, or to find the correct order with a small number of comparisons, e.g., when failure probabilities of comparisons are independent. Unlike noisy sorting, in evolving sorting comparisons are accurate but the underlying total order is changing.

The biased shuffling algorithm studied by Benjamini et al. [BBHM05] (see also [DR00]), can be viewed as a noisy version of naïve sorting, where each comparison is faulty independently with probability $f < 1/2$. The mixing time of this noisy naïve sorting was shown to be $O(n^2)$. It would be interesting to study naïve sorting in a setting combining both evolving ranks and noisy comparisons. Our current analysis does not work if we allow for noisy comparisons.

Besides sorting, several problems have been studied in the evolving data model: selecting the k -th element or the top- k elements under evolving rankings [AKMU11, HLSZ17]; stable matching with evolving preferences [KLM16]; label tracking on trees with evolving label-to-vertex mappings [AM22]; and various graph problems on evolving graphs, including (s, t) -connectivity and minimum spanning tree [AKM⁺12], densest subgraph computation [ELS15], community detection on the stochastic block model [ALL⁺16], and PageRank computations [BKMU12, OMK15, ML21]. In these works, the evolution that the graph undergoes typically involves changing the list of edges by adding a new edge or deleting an existing edge at each step, or changing the ranking of the edge weights. The minimum spanning tree algorithm for evolving edge weights proposed in [AKM⁺12], and a generalization of it that finds a basis of minimum weight in an evolving matroid model, both use an evolving sorting algorithm as a component to sort the weights.

Road Map. In Section 2 we introduce some terminology and notation, define the processes and settings we analyze, and provide some auxiliary lemmas. In Sections 3 and 4 we establish Theorem 1. More specifically, in Section 3 we prove the $O(b \cdot \log n)$ bound on the maximum deviation (Theorem 17) and the bound on the convergence time (Corollary 20). In Section 4, we prove the $O(n)$ bound for any constant $b \geq 1$. In Section 5, we complement the upper bounds with some asymptotically tight lower bounds.

2 Preliminaries

2.1 Some Standard Definitions

Let $[n] = \{1, 2, \dots, n\}$. By \mathcal{S}_n we denote the set of permutations of $[n]$, and id_n denotes the identity permutation. For any $\pi \in \mathcal{S}_n$, and $i_1, i_2 \in [n]$, let $\text{swap}(\pi, i_1, i_2)$ be the permutation π' defined as π with $\pi(i_1)$ and $\pi(i_2)$ swapped, i.e.,

$$\pi'(i) = \begin{cases} \pi(i_2), & \text{if } i = i_1, \\ \pi(i_1), & \text{if } i = i_2, \\ \pi(i), & \text{otherwise.} \end{cases}$$

We will use the following distance measures between two permutations.

Definition 2 (Permutation Distances). *For any permutations $\pi, \pi' \in \mathcal{S}_n$, their maximum deviation is*

$$\text{mdev}(\pi, \pi') = \max_{i \in [n]} |\pi(i) - \pi'(i)|,$$

their total deviation (also known as Spearman's footrule [DG18]) is

$$\text{tdev}(\pi, \pi') = \sum_{i \in [n]} |\pi(i) - \pi'(i)|,$$

and their Kendall-tau distance [Ken38] (also known as bubble-sort distance) is

$$K(\pi, \pi') = |\{(i, j) \in [n]^2 : \pi(i) < \pi(j), \pi'(i) > \pi'(j)\}|.$$

Also $\text{mdev}(\pi) = \text{mdev}(\pi, \text{id}_n)$ is just called the maximum deviation of π ; and similarly for the other two distances.

The following close relation between total deviation and Kendall-tau distance was proved in [DG18],

$$K(\pi, \pi') \leq \text{tdev}(\pi, \pi') \leq 2 \cdot K(\pi, \pi'). \quad (2)$$

2.2 Evolving Sorting Model and Naïve Sort

The evolving sorting model we consider in this paper is a generalization of the original model introduced in [AKMU11]. Next we describe the original model before we present its generalization. Then, we give a more concise representation, and apply the model to Naïve Sort.

2.2.1 Original Model.

We have an infinite sequence $(\nu_t, \rho_t)_{t \geq 0}$ on pairs of permutations from \mathcal{S}_n , where ρ_t denotes the underlying total order of set $S = [n]$ after t steps, and ν_t denotes the maintained approximation to ρ_t . Each step is either a sorting step or a mixing step.

A *sorting step* t consists of a single comparison between a pair of items in S , which returns their relative order in ρ_{t-1} , followed by arbitrary modification to ν_{t-1} , which yield ν_t . The pair to be compared and the subsequent modifications to ν_{t-1} are decided by the sorting algorithm. Also, $\rho_t = \rho_{t-1}$.

A *mixing step* t consists of a single *random adjacent rank swap*, which samples a uniformly random index $i \in [n-1]$, and swaps $\rho_{t-1}(i)$ and $\rho_{t-1}(i+1)$, i.e., $\rho_t = \text{swap}(\rho_{t-1}, i, i+1)$. Also, $\nu_t = \nu_{t-1}$.

The order of mixing and sorting steps is such that each sorting step is followed by exactly $b \geq 1$ mixing steps, where b is an integer parameter of the model, that is assumed to be a constant (independent of n).

2.2.2 Generalized Model

We generalize two properties of the original model above. First, we let a mixing step consist of a more general operation, called *local rank perturbation*.

Definition 3 (Local Rank Perturbation). *Let \mathcal{D} be a distribution on the integers that has zero mean and bounded moment generation function (MGF), i.e., if D is a random variable with distribution \mathcal{D} , then $\mathbb{E}[D] = 0$ and for some constants $\lambda, c > 0$,*

$$\mathbb{E} \left[e^{\lambda \cdot |D|} \right] \leq c.$$

We assume that \mathcal{D} is given as a parameter of the model, and is called perturbation distribution. If step t is a mixing step then a uniformly random integer i is sampled from $[n]$, and a random integer s is sampled from distribution \mathcal{D} ; and ρ_t is obtained by successively swapping $\rho_{t-1}(j)$ with $\rho_{t-1}(j+1), \rho_{t-1}(j+2), \dots, \rho_{t-1}(\min\{j+s, n\})$ if $s > 0$, or by successively swapping $\rho_{t-1}(j)$ with $\rho_{t-1}(j-1), \rho_{t-1}(j-2), \dots, \rho_{t-1}(\max\{j+s, 1\})$ if $s < 0$.

If \mathcal{D} is the uniform distribution over $\{-1, 1\}$ then we obtain a random adjacent rank swap. While if s is sampled from a geometric distribution with constant success probability and then its sign is flipped with probability $1/2$, we obtain the *hot spot adversary* proposed and studied empirically in [BVDE⁺18b].

The second generalization is that we allow the number of mixing steps between two sorting steps to vary, as long as the *average* is bounded by a constant. The formal description of this requirement is as follows.

Definition 4 (Bounded Average Rate of Mixing Steps). *Let b_i , for $i \geq 1$, be the number of mixing steps between the i th and $(i+1)$ th sorting steps. Then,*

$$\sum_{i=t+1}^{t+n} b_i \leq b \cdot n, \text{ for all } t \geq 0, \quad (3)$$

*where b is a constant parameter of the model. We also assume that the sequence of b_i is chosen independently of the randomness used in the sorting and evolution steps.*⁵

By letting $b_i = b$ for all i , we obtain the original model of [AKMU11]. Our model also encompasses a wide class of settings, including those with b_i 's chosen independently from any reasonable distribution of bounded mean. Note that since the number of steps in the evolving sorting model is unbounded, it was necessary to restrict the range of the sum in (3) to involve a finite number of sorting steps. Our decision that the number of sorting steps be precisely n was arbitrary, but we need that it is at most $O(n)$ in some parts of the analysis.

2.2.3 Evolving Sorting with Naïve Sort

For each $t \geq 0$, the pair ν_t, ρ_t of permutations gives rise to a permutation $\pi_t \in \mathcal{S}_n$, such that $\pi_t(i) = j$ if $\nu_t(i) = \rho_t(j)$.⁶ Note that the sorted case of $\nu_t = \rho_t$ corresponds to $\pi_t = \text{id}_n$. Since $\text{mdev}(\nu_t, \rho_t) = \text{mdev}(\pi_t)$ and $\text{tdev}(\nu_t, \rho_t) = \text{tdev}(\pi_t)$, it suffices for our analysis to focus on the sequence of π_t instead.

For convenience, below we give the definition of sorting and mixing steps in terms of π_t , when Naïve Sort is used.

- *Sorting step:* sample a uniformly random $i \in [n-1]$; if $\pi_{t-1}(i) > \pi_{t-1}(i+1)$ then $\pi_t = \text{swap}(\pi_{t-1}, i, i+1)$, otherwise $\pi_t = \pi_{t-1}$.

⁵For the purposes of the analysis, we can assume it is fixed in advance, before the process starts.

⁶Or, more concisely, $\pi_t = \rho_t^{-1} \circ \nu_t$.

- *Mixing step*: sample a uniformly random $i \in [n]$, and a random s from distribution \mathcal{D} ; if $s > 0$, then π_t^{-1} is obtained by successively swapping $\pi_{t-1}^{-1}(i)$ with $\pi_{t-1}^{-1}(i+1), \pi_{t-1}^{-1}(i+2), \dots, \pi_{t-1}^{-1}(\min\{i+s, n\})$; and if $s < 0$, π_t^{-1} is obtained by successively swapping $\pi_{t-1}^{-1}(i)$ with $\pi_{t-1}^{-1}(i-1), \pi_{t-1}^{-1}(i-2), \dots, \pi_{t-1}^{-1}(\max\{i+s, 1\})$.⁷

By $(\mathcal{F}_t)_{t \geq 0}$ we denote the natural filtration of the underlying process, where \mathcal{F}_t includes the random choices made in each step $t' \in \{1, \dots, t\}$.

2.3 Auxiliary Lists and Permutations

Next we describe some auxiliary components used in the proof.

2.3.1 Lists with Gaps and Target Permutations

To facilitate the analysis of π_t , we consider a triple l_t, τ_t, σ_t , where l_t is a list and τ_t, σ_t are permutations from \mathcal{S}_n .

List l_t has size roughly nd , for some constant integer $d > 1$, and it is obtained by inserting \perp elements, called *gaps*, to the list $(\pi_t(1), \pi_t(2), \dots)$. Each non-gap element $l_t[j] = i$ has a *target position* indicated by permutation τ_t , which is position $d \cdot \tau_t(i)$. For example, if $\tau_t = \text{id}_n$ is the identity permutation, then the target position of each $l_t[j] \neq \perp$ is position $d \cdot l_t[j]$. As we will see, sorting steps will tend to bring non-gap elements closer to their target position, and l_t will be considered sorted if every element $l_t[j] \neq \perp$ is precisely at its target position, i.e., $d \cdot \tau_t(l_t[j]) = j$. For example, if $\tau_t = \text{id}_n$ then l_t is sorted if $l_t[d \cdot i] = i$ for all $i \in [n]$ (and $l_t[j] = \perp$ for the remaining indices j).

In general, the placement of gaps in l_t can be arbitrary, subject to a simple *local optimality* requirement, which states that there should be no gap to the right (left) of an element if its target position is to its right (resp. left). In other words, we cannot move any single element in l_t closer to its target position without reordering non-gap elements.

To formally describe l_t , we will need the following definitions of a *d-padding* list, and operation lopt that make a list locally optimal.

Definition 5 (*d-Padding & Local Optimality*). *Let $\pi, \tau \in \mathcal{S}_n$ be permutations and $d > 1$ an integer. A d-padding of π is a list l of length $N = (n+1) \cdot d - 1$ such that l contains list $(\pi(1), \dots, \pi(n))$ as a (not necessarily contiguous) subsequence, and the remaining $N - n$ elements are equal to \perp . We will just say that l is a d-padding, to denote that it is a d-padding of some permutation from \mathcal{S}_n .*

We say that l is locally optimal w.r.t. permutation τ , if for all $j \in [N]$ with $l[j] \neq \perp$,

$$(j < d \cdot \tau(l[j]) \implies l[j+1] \neq \perp) \wedge (j > d \cdot \tau(l[j]) \implies l[j-1] \neq \perp). \quad (4)$$

We let $\text{lopt}(l, \tau)$ be the list computed by the following iterative procedure: As long as there is $j \in [N]$ with $l[j] \neq \perp$ that violates condition (4), consider the smallest such j , and if $j < d \cdot \tau(l[j])$ then swap elements $l[j]$ and $l[j+1]$, while if $j > d \cdot \tau(l[j])$ then swap elements $l[j-1]$ and $l[j]$. Once all $j \in [N]$ with $l[j] \neq \perp$ satisfy (4), output the resulting list. It is easy to verify that the procedure terminates, and outputs a locally optimal list w.r.t. τ .

We will use the following notions of maximum and total displacement to measure the distance of list l_t from its sorted state as indicated by the target permutation τ_t .

⁷Equivalently, if $s > 0$, π_t is obtained by successively swapping item value i in π_{t-1} with item values $i+1, i+2, \dots, \min\{i+s, n\}$; and if $s < 0$, π_t is obtained by successively swapping item value i in π_{t-1} with values $i-1, i-2, \dots, \max\{i+s, 1\}$.

Definition 6 (Displacements). For a d -padding l and a permutation $\tau \in \mathcal{S}_n$, the maximum displacement of l w.r.t. τ is

$$\text{mdsp}(l, \tau) = \max_{j \in [N]: l[j] \neq \perp} |j - d \cdot \tau(l[j])|,$$

and the total displacement of l w.r.t. τ is

$$\text{tdsp}(l, \tau) = \sum_{j \in [N]: l[j] \neq \perp} |j - d \cdot \tau(l[j])|.$$

In the above notation, we may omit τ if $\tau = \text{id}_n$.

We will use the following simple relations between the displacement of a d -padding of a permutation, and the deviation of the permutation. The proof is given in Appendix B.

Lemma 7. If l is a d -padding of $\pi \in \mathcal{S}_n$, then $\text{mdev}(\pi) \leq \frac{8}{d} \cdot \text{mdsp}(l)$ and $\text{tdev}(\pi) \leq \text{tdsp}(l)$.

The role of target permutations τ_t and σ_t is to facilitate analyzing independently sorting from mixing steps. Both evolve in a similar manner, so we focus on τ_t for now. Roughly speaking, τ_t keeps track of all mixing steps, swapping $\tau_t(i)$ and $\tau_t(i+1)$ whenever $\pi_t^{-1}(i)$ and $\pi_t^{-1}(i+1)$ are swapped during a mixing step. In addition, at the end of each step we may need to perform some additional swaps to τ_t to ensure that a basic *admissibility condition* is satisfied. This condition states that if $\pi_t(i)$ and $\pi_t(i+1)$ are sorted in π_t (and thus also in l_t), then $\tau_t(\pi_t(i))$ and $\tau_t(\pi_t(i+1))$ must also be sorted in τ_t . This is a natural invariant to maintain, since if it is violated for some i , then simply swapping $\tau_t(\pi_t(i))$ and $\tau_t(\pi_t(i+1))$ in τ_t brings τ_t closer to the identity permutation, which can only help our analysis. We formally define admissibility, and a procedure to make a permutation admissible, as follows.

Definition 8 (Admissibility). For permutations $\tau, \pi \in \mathcal{S}_n$, we say that τ is admissible w.r.t. π if for all $i \in [n-1]$,

$$\pi(i) < \pi(i+1) \implies \tau(\pi(i)) < \tau(\pi(i+1)). \quad (5)$$

We let $\text{adm}(\tau, \pi)$ be the permutation computed by the following iterative procedure: As long as there is $i \in [n-1]$ that violates condition (5), consider the smallest such i , and replace τ by $\text{swap}(\tau, \pi(i), \pi(i+1))$. Once all $i \in [n-1]$ satisfy (5), output the resulting permutation. It is easy to verify that the procedure terminates, and outputs an admissible permutation w.r.t. π .

We are now ready to formally define the sequences of l_t , τ_t , and σ_t . We will not yet discuss their initialization (for $t=0$). In fact, our proof strategy is to occasionally intervene, e.g., to reset (or partly reset) the target distributions to the identity permutation, as described later. Sequences τ_t and σ_t differ only on how their values are modified in those interventions.

Definition 9 (Auxiliary Quantities l_t, τ_t, σ_t). Let $d > 1$ be an integer. Let τ_0 and σ_0 be permutations in \mathcal{S}_n that are admissible w.r.t. π_0 , and let l_0 be a d -padding of π_0 that is locally optimal w.r.t. τ_0 . For $t \geq 1$, let τ'_t and σ'_t be permutations defined as follows:

- if step t is a mixing step (and i, s are the values sampled at that step), then τ'_t is obtained from τ_{t-1} by successively swapping $\tau_{t-1}(i)$ with $\tau_{t-1}(i+1), \tau_{t-1}(i+2), \dots, \tau_{t-1}(\min\{i+s, n\})$ if $s > 0$, or with $\tau_{t-1}(i-1), \dots, \tau_{t-1}(\max\{i+s, 1\})$ if $s < 0$; and σ'_t is obtained identically from σ_{t-1} ;
- if t is a sorting step, then $\tau'_t = \tau_{t-1}$ and $\sigma'_t = \sigma_{t-1}$;

Then,

- $\tau_t = \text{adm}(\tau'_t, \pi_t)$ and $\sigma_t = \text{adm}(\sigma'_t, \pi_t)$;
- $l_t = \text{lopt}(l'_t, \tau_t)$, where l'_t is a d -padding of π_t with the same gaps as l_{t-1} .

2.3.2 Potential Functions

Introducing l_t , τ_t , and σ_t makes it possible to analyze independently the sorting steps from the mixing steps. Our analysis uses exponential potential functions to study the displacement of l_t w.r.t. τ_t , and independently the deviations of τ_t and σ_t . Using l_t instead of π_t is critical, as our potential functions do not work when applied to π_t directly. The conditions of local optimality and admissibility are also critical, in ensuring that the potential functions are well-behaved. Below, we define the two main potential functions we use.

Definition 10 (Potential Functions). *For any $t \geq 0$ and $j \in [N]$ such that $l_t[j] \neq \perp$, and for any $\alpha > 0$, let*

$$\phi_t(j, \alpha) = e^{\alpha \cdot |j - d \cdot \tau_t(l_t[j])|},$$

and

$$\Phi_t(\alpha) = \sum_{j \in [N]: l_t[j] \neq \perp} (\phi_t(j, \alpha) - 1).$$

Also, for any $i \in [n]$, let

$$\psi_t(i, \alpha) = e^{\alpha \cdot |\sigma_t(i) - i|},$$

and

$$\Psi_t(\alpha) = \sum_{i \in [n]} \psi_t(i, \alpha).$$

We will generally omit parameter α from the above notation; the dependency on α will be made explicit only when needed or relevant.

2.3.3 Initialization and Interventions

We discuss now the initialization and interventions to the auxiliary sequences l_t, τ_t, σ_t . Our analysis divides an execution into *phases* of consecutive steps, and at the beginning of each phase we *reset* the auxiliary sequences. Specifically, in the analysis of maximum displacement, at the beginning of a phase starting after step t , we reset τ_t and σ_t to the identity permutation id_n , and replace l_t by $\text{lopt}(l_t, \text{id}_n)$. (Note that $\tau_t = \sigma_t$ throughout each phase; in fact just τ_t is used in the analysis of maximum displacement.) In the analysis of total displacement, at the beginning of each phase just σ_t is reset to id_n , while τ_t changes to $\hat{\tau}_t$ by a more refined transformation; and l_t is replaced by $\text{lopt}(l_t, \hat{\tau}_t)$. Ideally, we would like to obtain $\hat{\tau}_t$ from τ_t by resetting to zero all deviations $|\tau_t(i) - i|$ that are below a certain threshold θ , in a way that does not increase any deviation that is above that threshold. That way, we can ensure that $\text{tdev}(\hat{\tau}_t)$ is bounded by the sum of the deviations above the threshold, and that $\text{mdev}(\hat{\tau}_t, \tau_t)$ is at most θ . The actual transformation, which we call *θ -filtering*, is a bit different: it keeps unchanged the elements of τ_t with deviation above θ , and sorts the remaining ones. However, it still achieves (within constant factors) the desired bounds on $\text{tdev}(\hat{\tau}_t)$ and $\text{mdev}(\hat{\tau}_t, \tau_t)$ mentioned above, as we shown in [Lemma 12](#).

Definition 11 (θ -filtering). *For $\theta \geq 0$, the θ -filtering of permutation $\tau \in \mathcal{S}_n$ is a permutation $\hat{\tau} \in \mathcal{S}_n$ defined as follows. Let $I = \{i \in [n] : |\tau(i) - i| > \theta\}$. Then,*

- $\hat{\tau}(i) = \tau(i)$ for all $i \in I$, and
- $\hat{\tau}(i) < \hat{\tau}(j)$ for all $i, j \in [n] \setminus I$ with $i < j$.

Lemma 12. *If $\hat{\tau}$ is the θ -filtering of $\tau \in \mathcal{S}_n$, then*

$$\text{mdev}(\hat{\tau}, \tau) \leq 2\theta,$$

and

$$\text{tdev}(\hat{\tau}) \leq 4 \sum_{i: |\tau(i) - i| > \theta} |\tau(i) - i|.$$

Proof. We can obtain $\hat{\tau}$ from τ using the following iterative procedure: As long as there are indices $i, j \in [n] \setminus I$ such that $i < j$ and $\tau(i) > \tau(j)$, i.e., pair $(\tau(i), \tau(j))$ is an inversion, replace τ by $\text{swap}(\tau, i, j)$. By observing that each step does not increase $\max\{|\tau(i) - i|, |\tau(j) - j|\} \leq \theta$ it follows that $|\hat{\tau}(i) - i| \leq \theta$ for all $i \in [n] \setminus I$. Therefore, for every $i \in [n] \setminus I$,

$$|\hat{\tau}(i) - \tau(i)| \leq |\hat{\tau}(i) - i| + |\tau(i) - i| \leq 2\theta.$$

And since $\hat{\tau}(i) = \tau(i)$ for $i \in I$, it follows $\text{mdev}(\hat{\tau}, \tau) \leq 2\theta$.

To bound the total deviation of $\hat{\tau}$, we first bound its Kendall-tau distance from id_n , $K(\hat{\tau})$. Let $P = \{(i, j) : i < j, \hat{\tau}(i) > \hat{\tau}(j)\}$ be the set of index pairs for which we have an inversion; clearly $K(\hat{\tau}) = |P|$. For each $(i, j) \in P$, we have that at least one of i, j is in I , by the definition of $\hat{\tau}$.

Let $i \in I$, and suppose that $\hat{\tau}(i) > i$ (the case $\hat{\tau}(i) < i$ is symmetric). We bound the number of pairs $(j, i), (i, j) \in P$ such that $|\hat{\tau}(j) - j| \leq |\hat{\tau}(i) - i|$. Then, summing over all $i \in I$ will bound $|P|$. Note that $(j, i) \notin P$ for all j such that $|\hat{\tau}(j) - j| \leq |\hat{\tau}(i) - i|$, because $j < i$ implies

$$\hat{\tau}(j) \leq j + |\hat{\tau}(j) - j| < i + |\hat{\tau}(i) - i| = \hat{\tau}(i).$$

On the other hand, there are at most $2 \cdot |\hat{\tau}(i) - i|$ pairs $(i, j) \in P$ with $|\hat{\tau}(j) - j| \leq |\hat{\tau}(i) - i|$, since for $j > \hat{\tau}(i) + |\hat{\tau}(i) - i|$,

$$\hat{\tau}(j) \geq j - |\hat{\tau}(j) - j| > \hat{\tau}(i).$$

It follows that

$$|P| \leq \sum_{i \in I} (2 \cdot |\hat{\tau}(i) - i|) = 2 \sum_{i \in I} |\tau(i) - i|.$$

Finally, from (2),

$$\text{tdev}(\hat{\tau}) \leq 2K(\hat{\tau}) = 2|P| \leq 4 \sum_{i \in I} |\tau(i) - i|. \quad \square$$

2.4 Blocks

For the analysis of the displacement of list l_t , we decompose the list into sorted *blocks*, defined as follows (see [Figure 1](#) for an illustration).

Definition 13 (Blocks). Let $\pi, \tau \in \mathcal{S}_n$ be permutations such that τ is admissible w.r.t. π , and let l be a d -padding of π that is locally optimal w.r.t. τ . A right block of list l is a contiguous sublist $l[j..k]$ satisfying the following properties:

1. (absence of gaps) $l[i] \neq \perp$, for all $j \leq i \leq k$,
2. (target monotonicity) $\tau(l[j]) < \tau(l[j+1]) < \dots < \tau(l[k])$,
3. (targets to the right) $d \cdot \tau(l[j]) > j$,
4. (maximality) decreasing j 's value or increasing k 's violates one of the previous three properties.

The head of right block $l[j..k]$ is its rightmost element $l[k]$, and its tail is the leftmost element $l[j]$. We define a left block $l[j..k]$ similarly, by replacing property 3 by

- 3'. (targets to the left) $d \cdot \tau(l[k]) < k$.

The head of left block $l[j..k]$ is $l[j]$ and its tail is $l[k]$.

A stationary block is a single element $l[i]$ for which $d \cdot \tau(l[i]) = i$. We refer to elements belonging to stationary blocks as stationary elements.

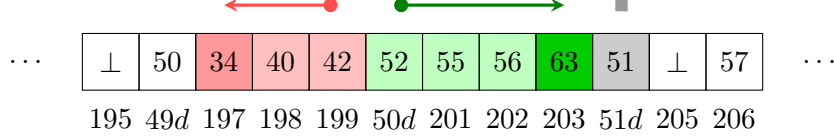

Figure 1: An example of a left block (shown in red), a right block (shown in green), and a stationary block (shown in gray) of list l , where $d = 4$ and $\tau = \text{id}_n$. The head of the left block is denoted by darker red and the head of the right block with darker green.

In the next lemma, we show the crucial property that the contribution to the potential function of the head of a block is at least a constant factor of the contribution of the entire block. We will make use of this property in proving the drop inequality in Lemma 15 for the Φ potential. Intuitively, the larger the number of gaps $d - 1$ between two targets, the more dominant the contribution of the head compared to that of the entire block.

Lemma 14. Consider an arbitrary list l and the potential function $\Phi_t = \Phi_t(\alpha)$ on this list for any real $\alpha > 0$ and any integer $d > 1$. For every step $t \geq 0$ and right block $l_t[i..j]$, it holds that

$$\sum_{k=i}^j \phi_t(k) \leq \phi_t(j) \cdot \frac{1 - e^{-\alpha \cdot (d-1) \cdot (j-i+1)}}{1 - e^{-\alpha \cdot (d-1)}} \leq \phi_t(j) \cdot \frac{1}{1 - e^{-\alpha \cdot (d-1)}}.$$

Similarly, for every left block $l_t[i..j]$, it holds that

$$\sum_{k=i}^j \phi_t(k) \leq \phi_t(i) \cdot \frac{1 - e^{-\alpha \cdot (d-1) \cdot (j-i+1)}}{1 - e^{-\alpha \cdot (d-1)}} \leq \phi_t(i) \cdot \frac{1}{1 - e^{-\alpha \cdot (d-1)}}.$$

Proof. Consider a right block $l_t[i..j]$ and any index $k \in [i, j]$. Then, we have that $k < j$ (by definition), $\tau_t(l_t[k]) > \tau_t(l_t[j])$ (by definition of a right block) and $\tau_t(l_t[j]) - \tau_t(l_t[k]) \geq j - k$. Therefore, we can upper bound the displacement of k as follows

$$d \cdot \tau_t(l_t[k]) - k \leq d \cdot (\tau_t(l_t[j]) - j + k) - k = d \cdot \tau_t(l_t[j]) - j - (d-1) \cdot (j-k). \quad (6)$$

Hence, the contribution of the block is given by

$$\begin{aligned} \sum_{k=i}^j \phi_t(k) &= \sum_{k=i}^j e^{\alpha \cdot (d \cdot \tau_t(l_t[k]) - k)} \\ &\stackrel{(6)}{\leq} \sum_{k=i}^j e^{\alpha \cdot (d \cdot \tau_t(l_t[j]) - j - (d-1) \cdot (j-k))} \\ &= \phi_t(j) \cdot \sum_{k=i}^j e^{-\alpha \cdot (d-1) \cdot (j-k)} \\ &= \phi_t(j) \cdot \frac{1 - e^{-\alpha \cdot (d-1) \cdot (j-i+1)}}{1 - e^{-\alpha \cdot (d-1)}}. \end{aligned}$$

By a symmetric argument and bounding instead the displacement $k - d \cdot \tau_t(l_t[k])$, we also get the claim for the left block. \square

3 Tight Bounds on the Maximum Deviation

In this section, we give a bound of $O(b \cdot \log n)$ for the maximum displacement. In [Section 5](#) in [Lemma 27](#), we prove an asymptotically matching lower bound for the process in [\[AKMU11\]](#) with any $b \in [1, \frac{2n}{\log n}]$. In [Section 3.1](#), we will prove a drift inequality for the Φ potential, establishing that in sorting steps it drops in expectation by a multiplicative factor of $1 - \Omega(\alpha/n)$. In [Section 3.2](#), we will analyze the evolution of σ as a result of mixing steps, this time by analyzing the Ψ potential. Finally, in [Section 3.3](#), we combine the two analyses to deduce the bound on the maximum deviation.

3.1 Analysis of the Φ Potential

Our main tool will be the Φ potential, which we recall was defined as

$$\Phi_t = \sum_{j \in [N]: l_t[j] \neq \perp} (\phi_t(j) - 1) = \sum_{j \in [N]: l_t[j] \neq \perp} (e^{\alpha \cdot |j - d \cdot \tau_t(l_t[j])|} - 1),$$

for a smoothing parameter α and $d - 1$ is the length of the padding.

Our goal is to prove the following drift inequality for Φ and establish that it is non-increasing.

Lemma 15 (Drift inequality). *Consider the auxiliary process $(l_t, \tau_t, \sigma_t)_{t \geq 0}$ and the potential function $\Phi_t = \Phi_t(\alpha)$ with any integer $d > 1$ and any real $\alpha \in [\frac{\log 20}{d-1}, 1]$. Further, let \mathcal{G}_{t+1} be the event that in step $t + 1$ we do sorting. Then, for any step $t \geq 0$, it holds that $\Phi_{t+1} \leq \Phi_t$ and*

$$\mathbb{E}[\Phi_{t+1} \mid \mathcal{F}_t] \leq \Phi_t \cdot \left(1 - \frac{\alpha}{4(n-1)} \cdot \mathbb{E}[\mathbf{1}_{\mathcal{G}_{t+1}} \mid \mathcal{F}_t]\right).$$

The intuition for the constraints on α and d , is that α needs to be small enough so that we can apply some Taylor estimates, and d needs to be large enough so that large displacements are amplified.

Proof. In any mixing step the value of the potential cannot increase, as the first step of the adm operation also swaps the targets of the elements mixed. These include the following swaps between adjacent elements:

- Swapping two elements of the same right (left) block ([Figures 2a](#) and [2b](#)).
- Swapping two stationary elements ([Figure 2c](#)).
- Swapping a stationary element with the tail of a left (right) block ([Figures 2d](#) and [2e](#)).

Now the remaining swaps between adjacent elements correspond to sorting steps. We will only consider the cases for swapping the *head* j of a right block as the cases for swapping the head of a left block are symmetric. Further note that since we are in an `lopt` list l , the next element $l_t[j+1] \neq \perp$ and $l_t[j+1] < l_t[j]$ (as otherwise $\tau_t(l_t[j+1]) > \tau_t(l_t[j])$ and $l_t[i..j]$ would not be a right block).

- When swapping j with the head of a left block, then both displacements decrease ([Figure 3a](#)).
- When swapping j with the tail of a right block, then only the displacement of the head decreases by 1 and the other displacement increases by 1 ([Figure 3b](#)). As we will show below, the change of the largest displacement (i.e., that of the head element) dominates and so overall the potential decreases.
- When swapping j with a stationary element, then again the displacement of the head decreases by 1 and the other displacement increases by 1 ([Figure 3c](#)).

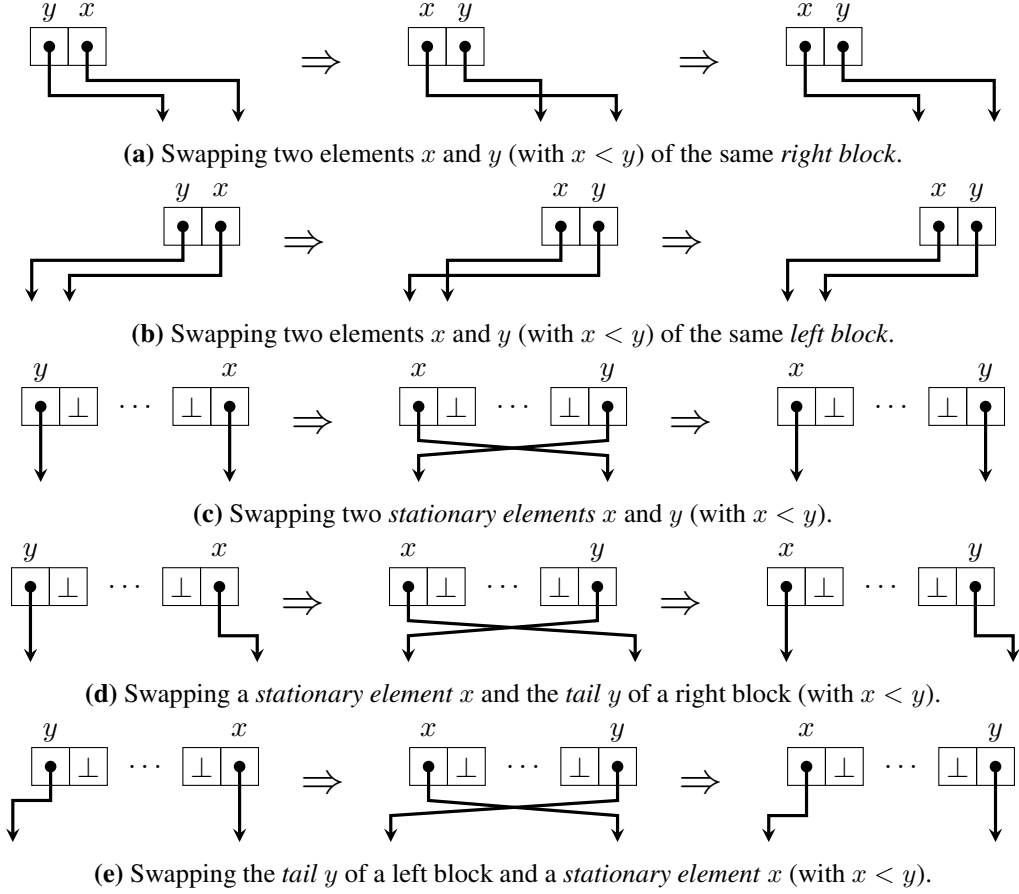

Figure 2: The five cases of swaps between adjacent element for which the value of the potential remains the same (all of which correspond to mixing steps). The figures show the following three stages: (i) the original list l , (ii) the list after the sorting swap, and (iii) the list after the adm operation. The arrows give roughly the direction of element i to its target $\tau_t(l_t[i])$.

Further, note that since the permutation τ_t is admissible w.r.t. π_t , we also have that the head of a right block j can always be swapped with its element to the right and that element is not a gap.

By the case analysis above, it follows that none of the swaps can increase the potential. Also, the lopt operation cannot increase the potential and so we deduce that $\Phi_{t+1} \leq \Phi_t$ for any step $t \geq 0$.

Our goal will be to show that the expected decrease of the value of the potential for the head j of the block covers (i) the possible increase of the potential for the element to its right, and (ii) also gives the decrease factor for all elements of its block. We will assume the pessimistic case where the displacement of the element to its right does increase.

Consider a right block $l_t[i..j]$. As mentioned above, we can assume that when swapping the head j of the block with the next element to its right, its displacement decreases by 1. Hence, using the Taylor estimate $e^{-\alpha} \leq 1 - \alpha/2$ (for any $\alpha \leq 1$), we have that

$$\begin{aligned} \mathbb{E}[\phi_{t+1}(j) \mid \mathcal{F}_t, \mathcal{G}_{t+1}] &\leq \left(1 - \frac{1}{n-1}\right) \cdot \phi_t(j) + \frac{1}{n-1} \cdot \phi_t(j) \cdot e^{-\alpha} \\ &= \phi_t(j) \cdot \left(1 + \frac{1}{n-1} \cdot (e^{-\alpha} - 1)\right) \end{aligned}$$

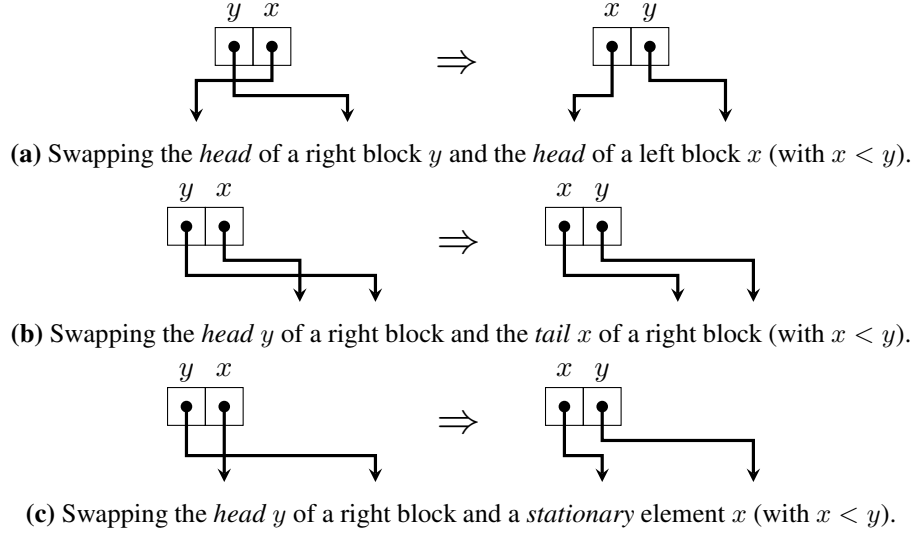

Figure 3: The three cases of sorting steps involving swapping the *head* of a right block.

$$\leq \phi_t(j) \cdot \left(1 - \frac{\alpha}{2(n-1)}\right).$$

Further, we can pessimistically assume that the displacement of the element $j + 1$ increases by 1. Using the Taylor estimate $e^\alpha \leq 1 + 2\alpha$ (for any $\alpha \leq 1$), we get that

$$\begin{aligned} \mathbb{E}[\phi_{t+1}(j+1) \mid \mathcal{F}_t, \mathcal{G}_{t+1}] &\leq \left(1 - \frac{1}{n-1}\right) \cdot \phi_t(j+1) + \frac{1}{n-1} \cdot \phi_t(j+1) \cdot e^\alpha \\ &= \phi_t(j+1) \cdot \left(1 + \frac{1}{n-1} \cdot (e^\alpha - 1)\right) \\ &\leq \phi_t(j+1) \cdot \left(1 + \frac{2\alpha}{n-1}\right). \end{aligned}$$

Moreover, in the cases where the displacement of j increases by 1 (Figures 3b and 3c), then $\tau_t(l_t[j]) \geq \tau_t(l_t[j-1]) + d$ and so $|d \cdot \tau_t(l_t[j]) - j| \geq |d \cdot \tau_t(l_t[j+1]) - (j+1)| + d - 1$. Therefore, we can bound its contribution as follows

$$\phi_t(j+1) \leq \phi_t(j) \cdot e^{-\alpha(d-1)} \leq \frac{1}{20} \cdot \phi_t(j),$$

using that $\alpha \cdot (d-1) \geq \log 20$. Therefore,

$$\begin{aligned} \mathbb{E}[\phi_{t+1}(j+1) \mid \mathcal{F}_t, \mathcal{G}_{t+1}] &\leq \phi_t(j+1) \cdot \left(1 - \frac{\alpha}{4(n-1)}\right) + \phi_t(j+1) \cdot \frac{2.25\alpha}{n-1} \\ &\leq \phi_t(j+1) \cdot \left(1 - \frac{\alpha}{4(n-1)}\right) + \phi_t(j) \cdot \frac{\alpha}{8(n-1)}. \end{aligned} \quad (7)$$

Now, for the contribution of the elements of the block $l_t[i..j]$ we have that

$$\begin{aligned} \mathbb{E}\left[\sum_{\ell=i}^j \phi_{t+1}(\ell) \mid \mathcal{F}_t, \mathcal{G}_{t+1}\right] &= \sum_{\ell=i}^{j-1} \phi_t(\ell) + \phi_t(j) \cdot \left(1 - \frac{\alpha}{2(n-1)}\right) \\ &= \sum_{\ell=i}^j \phi_t(\ell) \cdot \left(1 - \frac{\alpha}{4(n-1)}\right) + \sum_{\ell=i}^{j-1} \phi_t(\ell) \cdot \frac{\alpha}{4(n-1)} - \phi_t(j) \cdot \frac{\alpha}{4(n-1)} \end{aligned}$$

$$\leq \sum_{\ell=i}^j \phi_t(\ell) \cdot \left(1 - \frac{\alpha}{4(n-1)}\right) - \phi_t(j) \cdot \frac{\alpha}{8(n-1)}, \quad (8)$$

using in the last inequality that

$$\begin{aligned} \sum_{\ell=i}^{j-1} \phi_t(\ell) \cdot \frac{\alpha}{4(n-1)} &\stackrel{(a)}{\leq} \phi_t(j) \cdot \left(\frac{1}{1 - e^{-\alpha(d-1)}} - 1\right) \cdot \frac{\alpha}{4(n-1)} \\ &= \phi_t(j) \cdot \frac{e^{-\alpha(d-1)}}{1 - e^{-\alpha(d-1)}} \cdot \frac{\alpha}{4(n-1)} \\ &\stackrel{(b)}{\leq} \phi_t(j) \cdot \frac{\alpha}{8(n-1)}, \end{aligned}$$

where (a) follows by [Lemma 14](#) and (b) since $\alpha(d-1) \geq \log 20$. Therefore, combining (7) and (8), we have that

$$\mathbb{E} \left[\sum_{\ell=i}^{j+1} \phi_{t+1}(\ell) \mid \mathcal{F}_t, \mathcal{G}_{t+1} \right] \leq \sum_{\ell=i}^{j+1} \phi_t(\ell) \cdot \left(1 - \frac{\alpha}{4(n-1)}\right),$$

which also implies that

$$\mathbb{E} \left[\sum_{\ell=i}^{j+1} (\phi_{t+1}(\ell) - 1) \mid \mathcal{F}_t, \mathcal{G}_{t+1} \right] \leq \sum_{\ell=i}^{j+1} (\phi_t(\ell) - 1) \cdot \left(1 - \frac{\alpha}{4(n-1)}\right).$$

Further, by a symmetric argument, for a left block $l_t[i..j]$ we have that

$$\mathbb{E} \left[\sum_{\ell=i-1}^j (\phi_{t+1}(\ell) - 1) \mid \mathcal{F}_t, \mathcal{G}_{t+1} \right] \leq \sum_{\ell=i-1}^j (\phi_t(\ell) - 1) \cdot \left(1 - \frac{\alpha}{4(n-1)}\right).$$

By aggregating over all blocks and using that swaps between stationary elements do not contribute to the potential, we conclude that

$$\mathbb{E} [\Phi_{t+1} \mid \mathcal{F}_t, \mathcal{G}_{t+1}] \leq \Phi_t \cdot \left(1 - \frac{\alpha}{4(n-1)}\right).$$

Combining with the fact that deterministically $\Phi_{t+1} \leq \Phi_t$, we conclude that

$$\mathbb{E} [\Phi_{t+1} \mid \mathcal{F}_t] \leq \Phi_t \cdot \left(1 - \frac{\alpha}{4(n-1)}\right) \cdot \mathbb{E} [\mathbf{1}_{\mathcal{G}_{t+1}} \mid \mathcal{F}_t]. \quad \square$$

3.2 Analysis of the Ψ Potential

We now show that for any element i , the displacement of its target in $n \cdot k$ steps is at most $O(\sqrt{k \cdot \log n})$. The high level idea is that the targets perform an unbiased random walk, while the adm and lopt operations do not increase the exponential potential.

We define another exponential potential function

$$\Psi_t = \Psi_t(\alpha) = \sum_{i=1}^n e^{\alpha \delta_t(i)},$$

for a smoothing parameter $\alpha \in [1/n, 1]$ and where $\delta_t(i) = |\sigma_t^{-1}(i) - i|$.

Lemma 16. Consider the auxiliary process $(l_t, \tau_t, \sigma_t)_{t \geq 0}$ starting with the identity permutation $\sigma_0 = \text{id}_n$, with a perturbation distribution \mathcal{D} satisfying for $D \sim \mathcal{D}$ that $\mathbb{E}[D] = 0$ and $\mathbb{E}[e^{3\lambda|D|}] \leq c'$ for some constants $\lambda \in (0, 1/3]$ and $c' \geq 1$. Further, consider the potential $\Psi_t = \Psi_t(\alpha)$ for any real $\alpha \in [1/n, \lambda]$. Then, (i) for any step $t \geq 0$, it holds that

$$\mathbb{E}[\Psi_{t+1} | \mathcal{F}_t] \leq \Psi_t \cdot e^{\frac{\alpha^2}{n} \cdot \frac{3c'}{\lambda^2}} + \alpha \cdot \frac{4c'}{\lambda}.$$

(ii) for any integer $k \geq 1$, it holds that

$$\mathbb{E}[\Psi_{nk}] \leq 3 \cdot \frac{n}{\alpha} \cdot e^{k \cdot \frac{3c'}{\lambda^2} \cdot \alpha^2},$$

and (iii) for any integer $k \in [\frac{3}{c'} \cdot \log n, n]$, it holds that

$$\mathbb{P}\left[\max_{i \in [n]} \delta_{nk}(i) \leq \sqrt{108 \cdot \frac{c'}{\lambda^2} \cdot k \cdot \log n}\right] \geq 1 - n^{-6}.$$

Proof. First statement. Let Ψ'_t be the potential after the t -th mixing step, but before applying the adm and lopt operations. We will bound the expected value of $\psi'_{t+1}(i)$ for an arbitrary element $i \in [n]$. Let $\mathcal{T}_{t+1}(i)$ be the event that element i was selected in step $t+1$. Then,

$$\begin{aligned} & \mathbb{E}[\psi'_{t+1}(i) | \mathcal{F}_t] \\ &= \mathbb{E}[\psi'_{t+1}(i) | \mathcal{F}_t, \mathcal{T}_{t+1}(i)] \cdot \frac{1}{n} + \mathbb{E}[\psi'_{t+1}(i) | \mathcal{F}_t, \neg \mathcal{T}_{t+1}(i)] \cdot \left(1 - \frac{1}{n}\right) \\ &= \psi_t(i) + \mathbb{E}[\psi'_{t+1}(i) - \psi_t(i) | \mathcal{F}_t, \mathcal{T}_{t+1}(i)] \cdot \frac{1}{n} + \mathbb{E}[\psi'_{t+1}(i) - \psi_t(i) | \mathcal{F}_t, \neg \mathcal{T}_{t+1}(i)] \cdot \left(1 - \frac{1}{n}\right). \end{aligned} \quad (9)$$

We will now bound the increase of the potential separately for the two cases depending on whether $\mathcal{T}_{t+1}(i)$ holds or not.

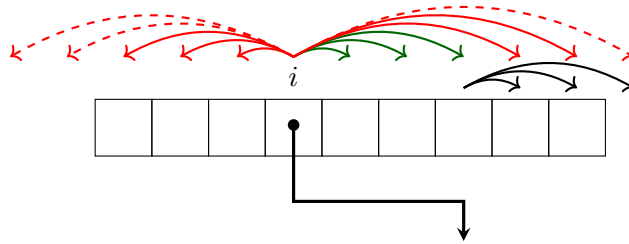
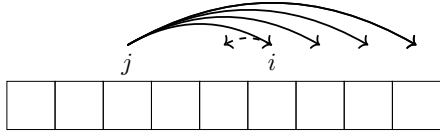

Figure 4: Arrows showing the possible displacements of element i by D_{t+1} . Red arrows represent an increase on $\delta_t(i)$, while green represent a decrease. Dashed arrows correspond to reaching a destination that is out of boundaries and in all cases lead to an increase (and their lengths upper bound the true increase). Solid black arrows represent the process corresponding to the additive term $\mathbb{E}[e^{\alpha|D_{t+1}|}]$ used to upper bound the contributions for when i surpasses the position $\sigma_t^{-1}(i)$.

Case 1 [$\mathcal{T}_{t+1}(i)$ holds]: When selecting element i , $\delta_t(i)$ will change by D_{t+1} , unless (i) the element reaches one of the two boundaries of the array, or (ii) the element surpasses the position $\sigma_t^{-1}(i)$.

For case (i), we upper bound the change by pessimistically assuming that the element carries on even outside the boundaries of the array (as this would mean higher $\delta_t(i)$). For case (ii), we upper bound the



(a) Element j can displace element i by one place (shown with the dashed arrow) iff $|D_{t+1}| \geq |i - j|$ (corresponding to the solid arrows).

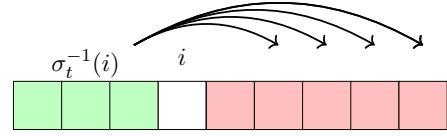

(b) The elements j that could decrease $\delta_t(i)$ if selected shown in green and the others in red. Note that there are always at least $\delta_t(i)$ green elements.

Figure 5: Visualizations for case 2, where element $j \neq i$ was selected for displacement.

increase by (always) having an additive term $\mathbb{E} [e^{\alpha|D_{t+1}|} - 1]$, i.e., at most the contribution of an element starting with $\delta_t(i) = 0$ (Figure 4).

Therefore,

$$\begin{aligned}
& \mathbb{E} [\psi'_{t+1}(i) - \psi_t(i) \mid \mathcal{F}_t, \mathcal{T}_{t+1}(i)] \\
& \leq \psi_t(i) \cdot (\mathbb{E} [e^{\alpha D_{t+1}}] - 1) + \mathbb{E} [e^{\alpha|D_{t+1}|} - 1] \\
& \stackrel{(a)}{\leq} \psi_t(i) \cdot \left(\alpha \cdot \mathbb{E} [D_{t+1}] + \alpha^2 \cdot \frac{c'}{\lambda^2} \right) + \alpha \cdot \mathbb{E} [|D_{t+1}|] + \alpha^2 \cdot \frac{c'}{\lambda^2} \\
& \stackrel{(b)}{\leq} \psi_t(i) \cdot \alpha^2 \cdot \frac{c'}{\lambda^2} + \alpha \cdot \frac{2c'}{\lambda},
\end{aligned}$$

using in (a) Lemma 33 (since $\alpha \leq \lambda$) and in (b) that $\mathbb{E} [|D_{t+1}|] \leq \frac{1}{\lambda} \cdot \mathbb{E} [e^{\lambda|D_{t+1}|}] \leq \frac{c'}{\lambda}$ and $\alpha^2 \cdot \frac{c'}{\lambda^2} \leq \alpha \cdot \frac{c'}{\lambda}$ since $\alpha \leq \lambda$.

Case 2 [$\mathcal{T}_{t+1}(i)$ does not hold]: Let j be the element that was selected in step $t + 1$. Element i will be displaced by one place iff $|D_{t+1}| \geq |i - j|$ and in the direction of i (Figure 5a). We can upper bound this probability using Markov's inequality as follows

$$\mathbb{P} [D_{t+1} \geq |i - j|] = \mathbb{P} [e^{\lambda D_{t+1}} \geq e^{\lambda|i-j|}] \leq \mathbb{E} [e^{\lambda D_{t+1}}] \cdot e^{-\lambda|i-j|} \leq c' \cdot e^{-\lambda|i-j|}, \quad (10)$$

and similarly

$$\mathbb{P} [D_{t+1} \leq -|i - j|] = \mathbb{P} [e^{\lambda D_{t+1}} \leq e^{-\lambda|i-j|}] \leq \mathbb{E} [e^{-\lambda D_{t+1}}] \cdot e^{-\lambda|i-j|} \leq c' \cdot e^{-\lambda|i-j|}.$$

Note that the number of elements j that increase and the number of elements that decrease $\delta_t(i)$ need not be the same. We pessimistically assume that there are more elements on the side that increase $\delta_t(i)$, and without loss of generality we assume these to be on the left side. Further, on the side that decrease $\delta_t(i)$ there should be at least $\delta_t(i)$ elements, namely the elements between i and $\sigma_t^{-1}(i)$ (Figure 5b). Hence,

$$\begin{aligned}
& \mathbb{E} [\psi'_{t+1}(i) - \psi_t(i) \mid \mathcal{F}_t, \neg \mathcal{T}_{t+1}(i)] \\
& \leq \psi_t(i) \cdot \left(\sum_{\ell \geq 1} \frac{1}{2(n-1)} \cdot \mathbb{P} [D_{t+1} \geq \ell] \cdot (e^\alpha - 1) + \sum_{\ell=1}^{\delta_t(i)} \frac{1}{2(n-1)} \cdot \mathbb{P} [D_{t+1} \leq -\ell] \cdot (e^{-\alpha} - 1) \right) \\
& \stackrel{(a)}{=} \psi_t(i) \cdot \left(\sum_{\ell \geq 1} \frac{1}{2(n-1)} \cdot \frac{1}{2} \mathbb{E} [|D_{t+1}|] \cdot (e^\alpha + e^{-\alpha} - 2) - \sum_{\ell \geq \delta_t(i)+1} \frac{1}{2(n-1)} \cdot \mathbb{P} [D_{t+1} \leq -\ell] \cdot (e^{-\alpha} - 1) \right) \\
& \stackrel{(b)}{\leq} \psi_t(i) \cdot \left(\frac{1}{n-1} \cdot \frac{1}{2} \mathbb{E} [|D_{t+1}|] \cdot \alpha^2 + \sum_{\ell \geq \delta_t(i)+1} \frac{1}{2(n-1)} \cdot \mathbb{P} [D_{t+1} \leq -\ell] \cdot \alpha \right)
\end{aligned}$$

$$\begin{aligned}
&\stackrel{(c)}{\leq} \psi_t(i) \cdot \left(\frac{1}{n-1} \cdot \frac{2c'}{\lambda} \cdot \alpha^2 + e^{-\lambda\delta_t(i)} \cdot \sum_{\ell \geq 1} \frac{1}{2(n-1)} \cdot c' \cdot e^{-\lambda\ell} \cdot \alpha \right) \\
&\stackrel{(d)}{\leq} \psi_t(i) \cdot \frac{\alpha^2}{n-1} \cdot \frac{2c'}{\lambda} + \alpha \cdot \frac{c'}{\lambda \cdot (n-1)},
\end{aligned}$$

using in (a) that since $\mathbb{E}[D_{t+1}] = 0$ we have that $\frac{1}{2} \mathbb{E}[|D_{t+1}|] = \sum_{\ell \geq 1} \mathbb{P}[D_{t+1} \geq \ell] = \sum_{\ell \geq 1} \mathbb{P}[D_{t+1} \leq -\ell]$, in (b) that $e^\alpha \leq 1 + \alpha + \alpha^2$ (since $\alpha \leq 1$) and $1 - \alpha \leq e^{-\alpha}$, in (c) the inequality (10) and that $\mathbb{E}[|D_{t+1}|] \leq \frac{1}{\lambda} \cdot \mathbb{E}[e^{\lambda|D_{t+1}|}] \leq \frac{c'}{\lambda}$, and in (d) that $\sum_{\ell=1}^{\infty} e^{-\lambda\ell} \leq \frac{1}{1-e^{-\lambda}} \leq \frac{2}{\lambda}$ (since $\lambda \leq 1$) and $\psi_t(i) = e^{\alpha\delta_t(i)}$ (and $\alpha \leq \lambda$).

Thus, combining the above two cases using (9), we have that

$$\mathbb{E}[\psi'_{t+1}(i) | \mathcal{F}_t] \leq \psi_t(i) \cdot \left(1 + \frac{\alpha^2}{n} \cdot \frac{3c'}{\lambda^2} \right) + \frac{\alpha}{n} \cdot \frac{4c'}{\lambda}.$$

By aggregating over all elements we have that

$$\mathbb{E}[\Psi'_{t+1} | \mathcal{F}_t] \leq \Psi_t \cdot \left(1 + \frac{\alpha^2}{n} \cdot \frac{3c'}{\lambda^2} \right) + \alpha \cdot \frac{4c'}{\lambda}. \quad (11)$$

After the swaps due to mixing, the adm operation may cause further swaps. By Lemma 32, these swaps do not increase the sum of the two displacements of the swapped elements, nor the largest displacement of the two. Thus, by the convexity of Ψ_t (being the sum of convex functions), this implies that the adm operation does not increase the potential. Further, the `lopt` operation does not affect σ_t , and so we conclude that the drop inequality (11) holds over the entire mixing step, i.e.,

$$\mathbb{E}[\Psi_{t+1} | \mathcal{F}_t] \leq \Psi_t \cdot \left(1 + \frac{\alpha^2}{n} \cdot \frac{3c'}{\lambda^2} \right) + \alpha \cdot \frac{4c'}{\lambda} \leq \Psi_t \cdot e^{\frac{\alpha^2}{n} \cdot \frac{3c'}{\lambda^2}} + \alpha \cdot \frac{4c'}{\lambda}.$$

Second statement. Applying for nk steps, we get that

$$\begin{aligned}
\mathbb{E}[\Psi_{nk}] &\leq n \cdot e^{nk \cdot \frac{\alpha^2}{n} \cdot \frac{3c'}{\lambda^2}} + \alpha \cdot \frac{4c'}{\lambda} \cdot \left(1 + e^{\frac{\alpha^2}{n} \cdot \frac{3c'}{\lambda^2}} + e^{2 \cdot \frac{\alpha^2}{n} \cdot \frac{3c'}{\lambda^2}} + \dots + e^{(nk-1) \cdot \frac{\alpha^2}{n} \cdot \frac{3c'}{\lambda^2}} \right) \\
&\leq n \cdot e^{k \cdot \alpha^2 \cdot \frac{3c'}{\lambda^2}} + \alpha \cdot \frac{4c'}{\lambda} \cdot \frac{e^{k \cdot \alpha^2 \cdot \frac{3c'}{\lambda^2}} - 1}{e^{\frac{\alpha^2}{n} \cdot \frac{3c'}{\lambda^2}} - 1} \\
&\stackrel{(a)}{\leq} n \cdot e^{k \cdot \alpha^2 \cdot \frac{3c'}{\lambda^2}} + \alpha \cdot \frac{4c'}{\lambda} \cdot \frac{e^{k \cdot \alpha^2 \cdot \frac{3c'}{\lambda^2}} - 1}{\frac{\alpha^2}{n} \cdot \frac{3c'}{\lambda^2}} \\
&\stackrel{(c)}{\leq} 3 \frac{n}{\alpha} \cdot e^{k \cdot \alpha^2 \cdot \frac{3c'}{\lambda^2}} \\
&\stackrel{(c)}{\leq} n^3 \cdot e^{k \cdot \alpha^2 \cdot \frac{3c'}{\lambda^2}},
\end{aligned}$$

using in (a) that $e^x \geq 1 + x$, in (b) that $\lambda \leq 1$ and in (c) that $\alpha \geq 1/n$.

Third statement. By Markov's inequality, we have that

$$\mathbb{P} \left[\Psi_{nk} \leq n^9 \cdot e^{k \cdot \alpha^2 \cdot \frac{3c'}{\lambda^2}} \right] \geq 1 - n^{-6}.$$

Therefore, with probability at least $1 - n^{-6}$, for any $i \in [n]$,

$$\delta_{nk}(i) \leq \frac{1}{\alpha} \cdot \log \Psi_{nk} \leq \frac{1}{\alpha} \cdot \left(9 \log n + k \cdot \alpha^2 \cdot \frac{3c'}{\lambda^2} \right) = 9 \cdot \frac{\log n}{\alpha} + k \cdot \frac{3c'}{\lambda^2} \cdot \alpha. \quad (12)$$

By choosing α such that $9 \cdot \frac{\log n}{\alpha} = k \cdot \frac{3c'}{\lambda^2} \cdot \alpha$ and using that $k \in [\frac{3}{c'} \cdot \log n, n]$, we get that

$$\alpha = \sqrt{\frac{3\lambda^2}{c'} \cdot \frac{\log n}{k}} \in [1/n, \lambda].$$

Substituting this in (12), we conclude that

$$\delta_{nk}(i) \leq 2 \cdot 9 \cdot \frac{\log n}{\alpha} \leq \sqrt{108 \cdot \frac{c'}{\lambda^2} \cdot k \cdot \log n}. \quad \square$$

3.3 Proof of Bound on Maximum Deviation

Now, we are ready to prove the upper bound for the maximum deviation.

Theorem 17. *Consider a process with bounded average rate of mixing steps for any $b \geq 1$ with a perturbation distribution \mathcal{D} satisfying for $D \sim \mathcal{D}$ that $\mathbb{E}[D] = 0$ and $\mathbb{E}[e^{3\lambda|D|}] \leq c'$ for some constants $\lambda \in (0, 1/3]$ and $c' \geq 1$. Then, there exists a constant $c := c(c', \lambda) > 0$ such that for any $m \geq 320 \cdot (b+1) \cdot n^2$, it holds that*

$$\mathbb{P}[\text{mdev}(\pi_m) \leq c \cdot b \cdot \log n] \geq 1 - n^{-2}.$$

Proof. Let $p = \frac{1}{4(b+1)}$. We will analyze the process for the last $m = \frac{80}{p} \cdot n^2$ steps. We will split these steps into $m/(nk)$ groups of nk steps each, where $k = \frac{16^2 \cdot 108 \cdot d^2}{p^2} \cdot \frac{c'}{\lambda^2} \cdot \log n$ and $d = 5$. At the end of each group of steps we will reset the targets to their original positions, so $\sigma_t = \tau_t = \text{id}_n$. We will consider a *capped process* in which if any of the mixing steps increases the displacement of the target within the current group to more than $M = \frac{1}{\lambda} \sqrt{108 \cdot c' \cdot k \cdot \log n}$, then the current and any future mixing step is not performed. By [Lemma 16 \(iii\)](#), we have that

$$\mathbb{P} \left[\bigcap_{t \in [0, m]} \left\{ \max_{i \in [n]} \delta_t(i) \leq M \right\} \right] \geq 1 - n^{-6} \cdot m \geq 1 - \frac{1}{2} n^{-3}. \quad (13)$$

and so the original process agrees with the capped process at all steps with probability at least $1 - \frac{1}{2} n^{-3}$. So, from now on we will be working with the capped process.

Consider the potential $\Phi_t = \Phi_t(\alpha)$ with $\alpha = \frac{\log 20}{d-1}$ and $d = 5$. Let \mathcal{G}_{t+1} be the event that step $t+1$ was a sorting step. By [Lemma 15](#), since $\alpha \in [\frac{\log 20}{d-1}, 1]$, in any step t , it holds that

$$\mathbb{E}[\Phi_{t+1} | \mathcal{F}_t] \leq \Phi_t \cdot \left(1 - \frac{\alpha}{4 \cdot (n-1)} \cdot \mathbb{E}[\mathbf{1}_{\mathcal{G}_{t+1}} | \mathcal{F}_t] \right).$$

We denote by Φ'_{t+nk} the value of the potential before resetting the targets.⁸ By aggregating over nk steps, for any step t being the start of a group, we have that

$$\mathbb{E}[\Phi'_{t+nk} | \mathcal{F}_t] \leq \Phi_t \cdot \prod_{i=1}^{nk} \left(1 - \frac{\alpha}{4(n-1)} \cdot \mathbb{E}[\mathbf{1}_{\mathcal{G}_{t+i}} | \mathcal{F}_t] \right) \leq \Phi_t \cdot e^{-\frac{\alpha}{4(n-1)} \cdot \sum_{i=1}^{nk} \mathbb{E}[\mathbf{1}_{\mathcal{G}_{t+i}} | \mathcal{F}_t]} \leq \Phi_t \cdot e^{-\frac{p\alpha}{4} \cdot \frac{nk}{n-1}},$$

⁸A similar interplay between two exponential potentials has been used to prove concentration in the context of balanced allocations (e.g., [\[LS22\]](#)). However, here because admissible steps can cause a large decrease in the potentials we require a slight variant of Azuma's inequality ([Lemma 31](#)).

where in the last inequality we used that $nk \geq (b+1) \cdot n$ and so by [Lemma 34](#) there is at least a p fraction of sorting steps among the nk steps.

Now, recall that in the capped process, at the end of the nk steps, the displacement of any single target changes by at most M , so each term in the potential increases by at most a factor of $e^{\alpha \cdot d \cdot M}$ plus an additive term of $e^{\alpha \cdot d \cdot M}$. Therefore,

$$\mathbb{E}[\Phi_{t+nk} | \mathcal{F}_t] \leq \Phi_t \cdot e^{-\frac{p\alpha}{4} \cdot \frac{nk}{n-1} + \alpha \cdot d \cdot M} + n \cdot e^{\alpha \cdot d \cdot M} \leq \Phi_t \cdot e^{-\frac{p\alpha}{8} \cdot k} + n \cdot e^{\alpha \cdot d \cdot M},$$

using that $\frac{p\alpha}{8} \cdot k \geq 2\alpha \cdot d \cdot M$ (since $k = \frac{16^2 \cdot 108 \cdot d^2}{p^2} \cdot \frac{c'}{\lambda} \cdot \log n$).

Trivially, at any step, each element is at most $n \cdot d$ units away from their target, so we have that $\Phi_0 \leq n \cdot e^{\alpha \cdot nd}$. By taking the expectation over the $\frac{m}{nk} = 80 \frac{n}{kp}$ groups we have that

$$\begin{aligned} \mathbb{E}[\Phi_m] &\stackrel{(a)}{\leq} n \cdot e^{\alpha \cdot nd} \cdot e^{-2\alpha \cdot nd} + n \cdot e^{\alpha \cdot d \cdot M} \cdot \left(1 + e^{-\frac{p\alpha}{8} \cdot k} + e^{-2 \cdot \frac{p\alpha}{8} \cdot k} + \dots\right) \\ &\leq 1 + n \cdot e^{\alpha \cdot d \cdot M} \cdot \frac{1}{1 - e^{-\frac{p\alpha}{8} \cdot k}} \\ &\stackrel{(a)}{\leq} 2n \cdot e^{\alpha \cdot d \cdot M}, \end{aligned}$$

using in (a) that $\frac{p\alpha}{8} \cdot k \cdot 80 \frac{n}{kp} \geq 2\alpha \cdot nd$ and in (b) that $e^{-\frac{p\alpha}{8} \cdot k} \leq \frac{1}{2}$ (since $k = \omega(1/p)$).

By Markov's inequality we have that

$$\mathbb{P}[\Phi_m \leq 2n^4 \cdot e^{\alpha \cdot d \cdot M}] \geq 1 - n^{-3},$$

and so we can deduce that

$$\mathbb{P}\left[\text{mdsp}(l_m) \leq \frac{1}{\alpha} \cdot (\log 2 + 4 \log n) + d \cdot M\right] \geq 1 - n^{-3}.$$

Using [Lemma 7](#), we have that for $c := 6 \cdot 10 \cdot \frac{16 \cdot 108 \cdot d^2 \cdot c'}{\lambda^2}$ (since $\frac{5}{\alpha} = \frac{20}{\log 20} \leq d \cdot M$) the capped process satisfies,

$$\mathbb{P}[\text{mdev}(\pi_m) \leq c \cdot b \cdot \log n] \geq 1 - n^{-3}.$$

Finally, by taking the union-bound with [\(13\)](#), the capped process agrees with the original process and so we conclude that the same bound holds for the original process

$$\mathbb{P}[\text{mdev}(\pi_m) \leq c \cdot b \cdot \log n] \geq 1 - n^{-3} - \frac{1}{2}n^{-3} \geq 1 - n^{-2}. \quad \square$$

From the preceding result bounding the maximum deviation, we immediately obtain an $O(n \cdot b \cdot \log n)$ bound on the total deviation. In [Theorem 24](#) we will improve this to $O(n)$ for any constant $b \geq 1$.

Remark 18. Consider the process where every sorting step is followed by $b \in [1, \frac{2n}{\log n}]$ mixing steps. Then by [Lemma 27](#) (i) the $O(b \cdot \log n)$ bound on the maximum deviation implied by [Theorem 17](#) is asymptotically tight.

Remark 19. The proof in [Theorem 17](#) also applies to a model where every nk steps each rank can be perturbed adversarially by at most M places.

In the proof of [Theorem 17](#), we assumed the worst possible initial maximum deviation, i.e., that of nd from their target positions. This allowed us to prove that the convergence time to a configuration with $O(b \cdot \log n)$ maximum deviation is w.h.p. $O(n^2 \cdot b)$. We can improve this to $O(n \cdot b \cdot \text{mdev}(\pi_0))$ for sufficiently large initial maximum deviation $\text{mdev}(\pi_0)$. By [Lemma 28](#), this is tight for any constant $b \geq 1$.

Corollary 20. Consider a process with bounded average rate of mixing steps for any $b \geq 1$ with a perturbation distribution \mathcal{D} satisfying for $D \sim \mathcal{D}$ that $\mathbb{E}[D] = 0$ and $\mathbb{E}[e^{3\lambda|D|}] \leq c'$ for some constants $\lambda \in (0, 1/3]$ and $c' \geq 1$. Then, there exists a constant $c > 0$ such that for any $m \geq 320 \cdot (b+1) \cdot n \cdot \text{mdev}(\pi_0)$, we have that

$$\mathbb{P}[\text{mdev}(\pi_m) \leq c \cdot b \cdot \log n] \geq 1 - n^{-2}.$$

Remark 21. Consider the process where every sorting step is followed by b mixing steps for any constant $b \geq 1$. Then, by [Lemma 27](#) (i) the $O(b \cdot n \cdot \text{mdev}(\pi_m))$ bound on the convergence time implied by [Theorem 17](#) is asymptotically tight.

4 Tight Bound on the Total Deviation

In this section, we will extend the ideas used in proving [Theorem 17](#) to show that w.h.p. the total deviation is $O(n)$ for any constant $b \geq 1$. This matches the lower bound in [[AKMU11](#), Theorem 1] for any constant $b \geq 1$.

We cannot directly apply the idea of resetting the targets for intervals of $o(n \log n)$ length, as for any interval of length ℓ the potential drops by a factor $e^{-\Theta(\ell/n)}$, while the worst-case displacement due to mixing could be $\omega(\ell/n)$. Take for example $\ell = \Theta(n)$, then the maximum displacement due to mixing is w.h.p. $\Theta(\log n / \log \log n)$. So using the same technique we would not be able to show that the potential decreases in expectation over these ℓ steps.

What we do instead is reset the targets only for elements with *small* displacement, i.e., those with $O(\ell)$ displacement which can be handled by the reallocation argument of [Section 3](#). For the rest of the elements that have a large displacement we prove that they don't contribute much to the total deviation. For instance, for $\ell = \Theta(n(\log n)^{2/3})$ we prove that the number of elements i with $\delta_t(i) = O((\log n)^{2/3})$ is $O(n \cdot e^{-(\log n)^{1/3}})$ and so they contribute $o(n)$ to the total displacement. Generalizing this idea for $\Theta(\log \log \log n)$ intervals of decreasing length and aggregating all the contributions of the large displacements, we are able to prove the $O(n)$ bound.

In [Section 4.1](#), we prove that the Ψ potential is concentrated and in [Section 4.2](#) we use this to prove the bound on the number (and total displacement) of elements with large displacements. Finally, in [Section 4.3](#), we combine these to prove the $O(n)$ bound on the total deviation.

4.1 Concentration of the Ψ Potential

In [Section 3.2](#), we analyzed the expectation of the Ψ potential. In the lemma below we will show that Ψ is also concentrated. We will use this lemma in [Section 4.2](#) to bound the sum of large displacements.

Lemma 22 (Concentration of Ψ). Consider the auxiliary process $(l_t, \tau_t, \sigma_t)_{t \geq 0}$ starting with the identity permutation $\sigma_0 = \text{id}_n$, with a perturbation distribution \mathcal{D} satisfying for $D \sim \mathcal{D}$ that $\mathbb{E}[D] = 0$ and $\mathbb{E}[e^{3\lambda|D|}] \leq c'$ for some constants $\lambda \in (0, 1/3]$ and $c' \geq 1$. Further, let $C \in [\frac{3}{\lambda}, n]$ be arbitrary. Then, for any $k \in [1, C \cdot \log n]$ and $\Psi_t = \Psi_t(\alpha)$ with any real $\alpha \in [\frac{1}{n}, \frac{\lambda}{6 \cdot 2 \cdot \sqrt{108 \cdot c' \cdot C}}]$, it holds that

$$\mathbb{P}\left[\Psi_{nk} \leq 4 \cdot \frac{n}{\alpha} \cdot e^{k \cdot \alpha^2 \cdot \frac{3c'}{\lambda^2}}\right] \geq 1 - n^{-4}.$$

Our goal is to use a variant of Azuma's inequality ([Lemma 31](#)) to prove concentration for the Ψ potential. To this end, we introduce a capped process, and an auxiliary potential, defined so that it is a super-martingale. Next, we show that this auxiliary potential satisfies a bounded difference inequality and hence, we can apply Azuma's inequality.

Proof. We define the *capped process* as the process following the original process, until at some step t some element i has displacement $\delta_t(i) > \tilde{c} \cdot \log n$ for $\tilde{c} = \frac{1}{\lambda} \sqrt{108 \cdot c' \cdot C}$. From that step t , in the capped process, we stop performing mixing steps.

Applying [Lemma 16 \(iii\)](#) (with $k = C \cdot \log n$) for all steps of the interval $[1, nk]$, and taking the union-bound, we have that the two processes agree with high probability.

$$\mathbb{P} \left[\bigcap_{t \in [1, nk]} \left\{ \max_{i \in [n]} \delta_t(i) \leq \tilde{c} \cdot \log n \right\} \right] \geq 1 - n^{-6} \cdot n \cdot k \geq 1 - \frac{1}{2} n^{-4}. \quad (14)$$

The potential functions. Let $\tilde{\Psi}_t = \tilde{\Psi}_t(\alpha)$ be the potential function for the capped process, for any smoothing parameter $\alpha \in [\frac{1}{n}, \frac{1}{6\tilde{c}}]$. Further, let $\tilde{\Psi}'_t$ be the value of the potential before applying the admissible swaps at the end of the step. Since $\tilde{\Psi}$ is convex, by [Lemma 32](#), we have that $\tilde{\Psi}_t \leq \tilde{\Psi}'_t$.

For any step t after a disagreement of the capped and the original process, we have that $\tilde{\Psi}_{t+1} \leq \tilde{\Psi}_t$ and so we can deduce by [Lemma 16 \(i\)](#), since $\alpha \in [\frac{1}{n}, \lambda]$ that for any step t it holds that

$$\mathbb{E} \left[\tilde{\Psi}'_{t+1} \mid \mathcal{F}_t \right] \leq \tilde{\Psi}_t \cdot e^{\frac{\alpha^2 \cdot 3c'}{n \cdot \lambda^2}} + \alpha \cdot \frac{4c'}{\lambda}. \quad (15)$$

Further, we define the auxiliary potential functions

$$\hat{\Psi}'_t = \left(\tilde{\Psi}'_t + \frac{\alpha \cdot \frac{4c'}{\lambda}}{e^{\frac{\alpha^2 \cdot 3c'}{n \cdot \lambda^2}} - 1} \right) \cdot e^{-t \cdot \frac{\alpha^2 \cdot 3c'}{n \cdot \lambda^2}}, \quad \text{and} \quad \hat{\Psi}_t = \left(\tilde{\Psi}_t + \frac{\alpha \cdot \frac{4c'}{\lambda}}{e^{\frac{\alpha^2 \cdot 3c'}{n \cdot \lambda^2}} - 1} \right) \cdot e^{-t \cdot \frac{\alpha^2 \cdot 3c'}{n \cdot \lambda^2}}, \quad (16)$$

for which $\hat{\Psi}'_t, \hat{\Psi}_t, \hat{\Psi}'_{t+1}, \hat{\Psi}_{t+1}, \dots$ is a sub-martingale since

$$\begin{aligned} \mathbb{E} \left[\hat{\Psi}'_{t+1} \mid \mathcal{F}_t \right] &= \left(\mathbb{E} \left[\tilde{\Psi}'_{t+1} \mid \mathcal{F}_t \right] + \frac{\alpha \cdot \frac{4c'}{\lambda}}{e^{\frac{\alpha^2 \cdot 3c'}{n \cdot \lambda^2}} - 1} \right) \cdot e^{-(t+1) \cdot \frac{\alpha^2 \cdot 3c'}{n \cdot \lambda^2}} \\ &\stackrel{(15)}{\leq} \left(\tilde{\Psi}_t \cdot e^{\frac{\alpha^2 \cdot 3c'}{n \cdot \lambda^2}} + \alpha \cdot \frac{4c'}{\lambda} + \frac{\alpha \cdot \frac{4c'}{\lambda}}{e^{\frac{\alpha^2 \cdot 3c'}{n \cdot \lambda^2}} - 1} \right) \cdot e^{-(t+1) \cdot \frac{\alpha^2 \cdot 3c'}{n \cdot \lambda^2}} \\ &= \left(\tilde{\Psi}_t \cdot e^{\frac{\alpha^2 \cdot 3c'}{n \cdot \lambda^2}} + \frac{\alpha \cdot \frac{4c'}{\lambda}}{e^{\frac{\alpha^2 \cdot 3c'}{n \cdot \lambda^2}} - 1} \cdot e^{\frac{\alpha^2 \cdot 3c'}{n \cdot \lambda^2}} \right) \cdot e^{-(t+1) \cdot \frac{\alpha^2 \cdot 3c'}{n \cdot \lambda^2}} \\ &= \left(\tilde{\Psi}_t + \frac{\alpha \cdot \frac{4c'}{\lambda}}{e^{\frac{\alpha^2 \cdot 3c'}{n \cdot \lambda^2}} - 1} \right) \cdot e^{-t \cdot \frac{\alpha^2 \cdot 3c'}{n \cdot \lambda^2}} = \hat{\Psi}_t, \end{aligned}$$

and deterministically

$$\hat{\Psi}_t \leq \hat{\Psi}'_t.$$

Bounded difference. Because of capping any mixing step can change $\tilde{\Psi}$ in at most $\tilde{c} \cdot \log n$ indices j . Therefore,

$$\left| \tilde{\Psi}'_{t+1} - \tilde{\Psi}_t \right| \leq (2\tilde{c} \cdot \log n) \cdot \max_{j \in [n]} \tilde{\psi}_t(j) \leq (2\tilde{c} \cdot \log n) \cdot e^{\alpha \cdot \tilde{c} \log n} \leq 2\tilde{c} \cdot n^{1/6} \cdot \log n, \quad (17)$$

using that $\alpha \leq \frac{1}{6\tilde{c}}$. Similarly it also holds that

$$\tilde{\Psi}_t \leq n \cdot e^{\alpha \cdot \tilde{c} \log n} \leq n \cdot n^{1/6} \quad \text{and} \quad \tilde{\Psi}'_t \leq n \cdot e^{\alpha \cdot \tilde{c} \log n} \leq n \cdot n^{1/6}. \quad (18)$$

Now we can bound the change of the potential due to a mixing step for any step $t \leq nk$ as follows

$$\begin{aligned} \left| \widehat{\Psi}'_{t+1} - \widehat{\Psi}_t \right| &\stackrel{(a)}{\leq} \left(\left| \widetilde{\Psi}'_{t+1} - \widetilde{\Psi}_t \right| + \widetilde{\Psi}_{t+1} \cdot (1 - e^{-\frac{\alpha^2 \cdot 3c'}{n \cdot \lambda^2}}) + \alpha \cdot \frac{4c'}{\lambda} \cdot \frac{1 - e^{-\frac{\alpha^2 \cdot 3c'}{n \cdot \lambda^2}}}{e^{\frac{\alpha^2 \cdot 3c'}{n \cdot \lambda^2}} - 1} \right) \cdot e^{-t \cdot \frac{\alpha^2 \cdot 3c'}{\lambda^2}} \\ &\stackrel{(b)}{\leq} 2\tilde{c} \cdot n^{1/6} \cdot \log n + n \cdot n^{1/6} \cdot 1 + \alpha \cdot \frac{4c'}{\lambda} \leq n^{1/3}, \end{aligned}$$

using in (a) the definition of the $\widehat{\Psi}$ potential in (16) and in (b) the bounds in (17) and (18). Further, recall that for any step $t \geq 0$, it holds $\widetilde{\Psi}_t \leq \widetilde{\Psi}'_t$.

Applying Azuma's inequality. Now we are ready to apply Azuma's inequality (Lemma 31) for the super-martingale $\widehat{\Psi}_0, \widehat{\Psi}'_1, \widehat{\Psi}_1, \widehat{\Psi}'_2, \widehat{\Psi}_2 \dots$ with $\lambda = \frac{n}{\alpha}$ and $D = n^{1/3}$

$$\mathbb{P} \left[\widehat{\Psi}_{nk} \leq \widehat{\Psi}_0 + \frac{n}{\alpha} \right] \geq 1 - \exp \left(-\frac{(n/\alpha)^2}{3n \cdot k \cdot (n^{1/3})^2 + \Psi_0 \cdot n^{1/3}} \right).$$

From the definition of $\widehat{\Psi}_t$,

$$\widehat{\Psi}_0 + \frac{n}{\alpha} = \left(n + \frac{\alpha \cdot \frac{4c'}{\lambda}}{e^{\frac{\alpha^2 \cdot 3c'}{n \cdot \lambda^2}} - 1} \right) \cdot 1 + \frac{n}{\alpha} \leq n + \frac{4}{3} \cdot \lambda \cdot \frac{n}{\alpha} + \frac{n}{\alpha} \leq 4 \cdot \frac{n}{\alpha}$$

and so when $\widehat{\Psi}_{nk} \leq \widehat{\Psi}_0 + \frac{n}{\alpha}$, we also have that

$$\widetilde{\Psi}_{nk} = \widehat{\Psi}_{nk} \cdot e^{nk \cdot \frac{\alpha^2 \cdot 3c'}{n \cdot \lambda^2}} - \frac{\alpha \cdot \frac{4c'}{\lambda}}{e^{\frac{\alpha^2 \cdot 3c'}{n \cdot \lambda^2}} - 1} \leq 4 \cdot \frac{n}{\alpha} \cdot e^{k \cdot \alpha^2 \cdot \frac{3c'}{\lambda^2}}.$$

Therefore, since $k = O(\log n)$ and $\alpha = O(1)$, we deduce that

$$\mathbb{P} \left[\widetilde{\Psi}_{nk} \leq 4 \cdot \frac{n}{\alpha} \cdot e^{k \cdot \alpha^2 \cdot \frac{3c'}{\lambda^2}} \right] \geq 1 - \frac{1}{2} n^{-4}. \quad (19)$$

Finally, by taking the union-bound of (14) and (19), we have that the capped process agrees with the original process, so $\Psi_{nk} = \widetilde{\Psi}_{nk}$ and

$$\mathbb{P} \left[\Psi_{nk} \leq 4 \cdot \frac{n}{\alpha} \cdot e^{k \cdot \alpha^2 \cdot \frac{3c'}{\lambda^2}} \right] \geq 1 - \frac{1}{2} n^{-4} - \frac{1}{2} n^{-4} = 1 - n^{-4}. \quad \square$$

4.2 Bounding the Sum of Large Displacements

In this section, we use the concentration of the Ψ potential to bound the number as well as the sum of large displacements.

Lemma 23. *Let $C \geq 1$ be an arbitrary constant and $R = \max\{6 \cdot 2 \cdot \frac{c'}{\lambda^2} \sqrt{108 \cdot C}, 32^3 \cdot 16\}$. Then, for any $k \in [(32R \log R)^3, C \cdot \log n]$, it holds that*

$$\mathbb{P} \left[\sum_{i \in [n]: \delta_{nk}(i) \geq k^{2/3}} \delta_{nk}(i) \leq n \cdot e^{-\frac{1}{2R} \cdot k^{1/3}} \right] \geq 1 - n^{-3}.$$

Proof. Let N_ℓ be the number of elements i with $\delta_{nk}(i) \geq \ell$, i.e.,

$$N_\ell = |\{i \in [n] : \delta_{nk}(i) \geq \ell\}|.$$

Then, we can express the total displacement $D_{\geq k^{2/3}}$ of elements i with $\delta_{nk}(i) \geq k^{2/3}$ as

$$D_{\geq k^{2/3}} = N_{k^{2/3}} \cdot (k^{2/3} - 1) + \sum_{\ell=k^{2/3}}^{\infty} N_\ell. \quad (20)$$

We will obtain bounds for N_ℓ using the potential functions $\Psi_t^\ell = \Psi_t^\ell(\alpha_\ell)$ for $\ell = k^{2/3}, \dots, k+1$ with smoothing parameters

$$\alpha_\ell = \begin{cases} \frac{1}{R} \cdot \frac{\ell}{k}, & \text{for } \ell \leq k, \\ \frac{1}{R}, & \text{for } \ell > k. \end{cases}$$

Applying [Lemma 22](#) (as $k \leq C \cdot \log n$ and $\alpha_\ell \leq \frac{1}{R} \leq \frac{\lambda}{6 \cdot 2 \cdot \sqrt{108} \cdot c' \cdot C}$), taking the union bound over the $(k+1 - k^{2/3} + 1)$ potential functions, we get that

$$\mathbb{P} \left[\bigcap_{\ell \in [k^{2/3}, k+1]} \left\{ \Psi_{nk}^\ell \leq 4 \cdot \frac{n}{\alpha_\ell} \cdot e^{k \cdot \frac{3c'}{\lambda^2} \cdot \alpha_\ell^2} \right\} \right] \geq 1 - n^{-4} \cdot (k+1 - k^{2/3} + 1) \geq 1 - n^{-3}, \quad (21)$$

Now, assuming that these bounds hold on the Ψ 's we will bound N_ℓ . We start by considering $\ell \in [k^{2/3}, k]$,

$$\begin{aligned} N_\ell &\leq \Psi_{nk}^\ell \cdot e^{-\alpha_\ell \cdot \ell} \\ &\leq 4 \cdot \frac{n}{\alpha_\ell} \cdot e^{k \cdot \frac{3c'}{\lambda^2} \cdot \alpha_\ell^2} \cdot e^{-\alpha_\ell \cdot \ell} \\ &= 4Rn \cdot \frac{k}{\ell} \cdot e^{\frac{1}{R} \cdot \frac{\ell^2}{k} \cdot \left(\frac{3c'}{\lambda^2} \cdot \frac{1}{R} - 1 \right)} \\ &\stackrel{(a)}{\leq} 4Rn \cdot \frac{k}{\ell} \cdot e^{-\frac{3}{4R} \cdot \frac{\ell^2}{k}} \\ &\stackrel{(b)}{\leq} 4Rn \cdot k^{1/3} \cdot e^{-\frac{3}{4R} \cdot k^{1/3}} \\ &\stackrel{(c)}{\leq} \frac{1}{4} n \cdot e^{-\frac{1}{2R} \cdot k^{1/3}}, \end{aligned} \quad (22)$$

using in (a) that $R \geq 12 \cdot \frac{c'}{\lambda^2}$, in (b) that $\ell \geq k^{2/3}$ and in (c) that $e^{\frac{1}{4R} \cdot k^{1/3}} \geq R^8 \geq 16R \cdot k^{1/3}$ as implied by $k \geq (32R \log R)^3$ and $R \geq 32^3 \cdot 16$.

Similarly, for $\ell > k$, we get

$$N_\ell \leq \Psi_{n \cdot k}^\ell \cdot e^{-\alpha_\ell \cdot \ell} \leq 4Rn \cdot e^{k \cdot \frac{3c'}{\lambda^2} \cdot \frac{1}{R^2}} \cdot e^{-\frac{1}{R} \ell} \leq 4Rn \cdot e^{-\frac{3}{4R} \ell} \leq \frac{1}{4} n \cdot e^{-\frac{1}{2R} \cdot k^{1/3}}. \quad (23)$$

Finally, the first term in (20) can be bounded similarly to (22), so

$$N_{k^{2/3}} \cdot (k^{2/3} - 1) \leq 4 \cdot n \cdot k \cdot e^{\frac{3c'}{\lambda^2} \cdot \frac{1}{R^2} \cdot \frac{(k^{2/3})^2}{k^2}} \cdot e^{-\frac{1}{R} \cdot \frac{(k^{2/3})^2}{k}} \leq 4Rn \cdot k \cdot e^{-\frac{3}{4R} \cdot k^{1/3}} \leq \frac{1}{4} n \cdot e^{-\frac{1}{2R} \cdot k^{1/3}}, \quad (24)$$

using in the last inequality that $e^{\frac{1}{4R} \cdot k^{1/3}} \geq R^8 \geq 16R \cdot k$. Combining (22) through (24), we get

$$D_{\geq k^{2/3}} \leq \frac{1}{4} n \cdot e^{-\frac{1}{2R} \cdot k^{1/3}} + 2 \cdot \frac{1}{4} n \cdot e^{-\frac{1}{2R} \cdot k^{1/3}} \leq n \cdot e^{-\frac{1}{2R} \cdot k^{1/3}}.$$

Finally, by (21), we conclude that

$$\mathbb{P} \left[D_{\geq k^{2/3}} \leq n \cdot e^{-\frac{1}{2R} \cdot k^{1/3}} \right] \geq 1 - n^{-3}. \quad \square$$

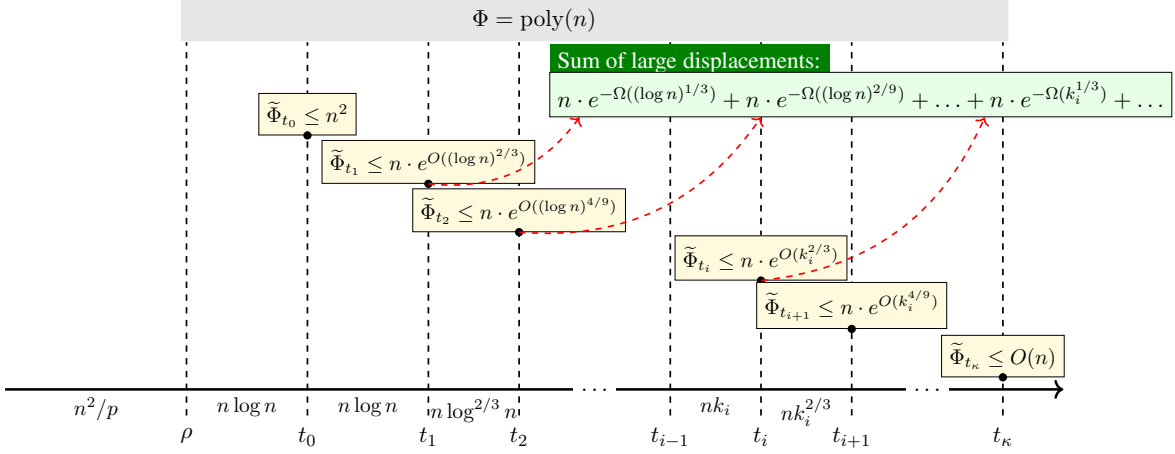

Figure 6: The phases for the proof of the $O(n)$ bound for the total deviation.

4.3 Proof of Bound on Total Deviation

Now, we are ready to prove the $O(n)$ bound on total deviation with high probability.

Theorem 24 (Total deviation). *Consider Naïve Sort under random adjacent rank swaps for any constant $b \geq 1$. Then, there exists a constant $c = c(b) > 0$ such that for any $m \geq 16 \cdot 128 \cdot 4 \cdot (b + 1) \cdot n^2$, it follows that*

$$\mathbb{P}[\text{tdev}(\pi_m) \leq cn] \geq 1 - n^{-2}.$$

Proof. Let $p = \frac{1}{4(b+1)}$. We will perform the analysis in $\kappa + 2$ phases $(0, \rho], (\rho, t_0], (t_0, t_1], \dots, (t_{\kappa-1}, t_\kappa]$ each consisting of $\rho, n \cdot k_0, n \cdot k_1, \dots, n \cdot k_\kappa$ many steps, where $k_0 = k_1 = \frac{16^2 \cdot 108 \cdot d^2}{p^2} \cdot \frac{c'}{\lambda^2} \cdot \log n$, $k_{i+1} = \frac{16d}{p} \cdot k_i^{2/3}$ (for $d = 128$) and $\rho = m - n \cdot k_0 - n \cdot k_1 - \dots - n \cdot k_\kappa$ (the remaining steps). We choose κ to be the smallest integer such that $k_\kappa \geq \max\left\{\left(\frac{8 \cdot 16d}{p}\right)^4, (32R \log R)^3\right\}$, where $R = \max\{6 \cdot 2 \cdot \frac{c'}{\lambda^2} \sqrt{108 \cdot C}, 32^3 \cdot 16\}$ the constant in [Lemma 23](#). It follows that $\kappa = \Theta(\log \log \log n)$.

We will be using two potential functions $\Phi_t = \Phi_t(\alpha)$ and $\tilde{\Phi}_t = \tilde{\Phi}_t(\tilde{\alpha})$ with α being a large constant factor larger than $\tilde{\alpha}$, so it holds that $\Phi_t \geq \tilde{\Phi}_t$ for any step $t \geq 0$. More concretely, we set $\alpha = \frac{\log 20}{127}$ and $\tilde{\alpha} = \frac{1}{42} \cdot \frac{\log 20}{127}$ (and d defined as above). First, we are going to prove that w.h.p. $\Phi_t = \text{poly}(n)$ for any $t \in [t_0, t_\kappa]$ and then we use this to show that $|\tilde{\Phi}_{t+1} - \tilde{\Phi}_t| \leq n^{1/3}$, which allows us to prove that w.h.p. $\tilde{\Phi}_t = O(n)$ for any $t = t_1, t_2, \dots, t_\kappa$ (before resetting the targets).

As in [Theorem 17](#), the first (long) phase will be to ensure that we reach a state with a small maximum displacement. The second phase is to ensure that $\Phi_t = \text{poly}(n)$. At the end of each of the phases $(t_i, t_{i+1}]$, we reset $\sigma_{t_{i+1}}$ to the identity permutation (with $\sigma'_{t_{i+1}}$ being the permutation before the reset) and update $\tau_{t_{i+1}}$ by resetting targets using θ -filtering with $\theta = 2k_i^{2/3}$ (with $\tau'_{t_{i+1}}$ being the permutation before the filtering).

We will prove the following claim for the tdev at step $m = \tau_{t_\kappa}$.

Claim 25. *It holds that,*

$$\mathbb{P}[\text{tdev}(\tau_{t_m}) \leq n] \geq 1 - \frac{1}{2}n^{-2}. \quad (25)$$

And we will also prove the following claim for tdsp at step $m = \tau_{t_\kappa}$.

Claim 26. *It holds that,*

$$\mathbb{P}[\text{tdsp}(l_m, \tau_m) \leq 8n \cdot d \cdot k_\kappa^{2/3}] \geq 1 - \frac{1}{2}n^{-2}. \quad (26)$$

Before proving these claims, we will show how these two imply the conclusion. We will use the following inequality to bound $\text{tdev}(\pi_m)$,

$$\text{tdev}(\pi_m) \leq \text{tdsp}(l_m, \tau_m) + \text{tdev}(\tau_m).$$

By taking the union-bound between (25), and using (26) we get

$$\mathbb{P} \left[\text{tdsp}(l_m, \tau_m) \leq 8n \cdot d \cdot k_\kappa^{2/3} \right] \geq 1 - \frac{1}{2}n^{-2} - \frac{1}{2}n^{-2} = 1 - n^{-2},$$

By Lemma 7, we conclude that

$$\mathbb{P} \left[\text{tdev}(\pi_m) \leq \frac{8c}{d} \cdot n \right] \geq 1 - n^{-2},$$

for the constant $c = 72k_\kappa^{2/3}$, since $k_\kappa^{2/3}$ is a constant.

Now, we turn our attention into proving these two claims.

Proof of Claim 25. For any phase $(t_{i-1}, t_i]$, we have that

$$\begin{aligned} \text{tdev}(\tau_{t_i}) &\stackrel{(a)}{\leq} 4 \cdot \sum_{j \in [n]: |\tau'_{t_i}(j) - j| > 2k_i^{2/3}} |\tau'_{t_i}(j) - j| \\ &\stackrel{(b)}{\leq} 4 \cdot \sum_{j \in [n]: |\sigma'_{t_i}(j) - j| > k_i^{2/3}} |\sigma'_{t_i}(j) - j| + 8 \cdot \text{tdev}(\sigma'_{t_i}, \tau'_{t_i}) \\ &\stackrel{(c)}{\leq} 4 \cdot \sum_{j \in [n]: |\sigma'_{t_i}(j) - j| > k_i^{2/3}} |\sigma'_{t_i}(j) - j| + 8 \cdot \text{tdev}(\sigma_{t_{i-1}}, \tau_{t_{i-1}}) \\ &\stackrel{(d)}{=} 4 \cdot \sum_{j \in [n]: |\sigma'_{t_i}(j) - j| > k_i^{2/3}} |\sigma'_{t_i}(j) - j| + 8 \cdot \text{tdev}(\tau_{t_{i-1}}) \\ &\stackrel{(e)}{=} 4 \cdot \sum_{j \in [n]: \delta_{t_i} > k_i^{2/3}} \delta_{t_i} + 8 \cdot \text{tdev}(\tau_{t_{i-1}}) \\ &\stackrel{(f)}{\leq} \sum_{s=0}^i 8^{i-s+1} \sum_{j \in [n]: \delta_{t_s}(j) > k_s^{2/3}} \delta_{t_s}(j), \end{aligned} \tag{27}$$

using in (a) Lemma 12, in (b) that if $|\tau'_{t_i}(j) - j| > 2k_i^{2/3}$, then (i) either $|\sigma'_{t_i}(j) - j| > k_i^{2/3}$ or $|\sigma'_{t_i}(j) - \tau'_{t_i}(j)| > k_i^{2/3}$ and (ii) $|\tau'_{t_i}(j) - j| \leq |\sigma'_{t_i}(j) - j| + 2 \cdot |\sigma'_{t_i}(j) - \tau'_{t_i}(j)|$, in (c) that the adm operations cannot increase the deviation between σ and τ during the phase (by Lemma 32), in (d) that $\sigma_{t_i} = \text{id}_n$, in (e) that $\delta_{t_s}(j) = |(\sigma'_{t_s})^{-1}(j) - j|$ and in (f) an inductive argument. By Lemma 23, we have that

$$\mathbb{P} \left[\sum_{j \in [n]: \delta_{t_i}(j) \geq k_i^{2/3}} \delta_{t_i}(j) \leq n \cdot e^{-\frac{1}{2R} \cdot k_i^{1/3}} \right] \geq 1 - n^{-3}.$$

By taking the union-bound over all $i = 1, \dots, \kappa$, we have that

$$\mathbb{P} \left[\sum_{i=0}^{\kappa} 8^{\kappa-i+1} \sum_{j \in [N]: \delta_{t_i}(j) \geq k_i^{2/3}} \delta_{t_i}(j) \leq n \cdot \sum_{i=0}^{\kappa} 8^{\kappa-i+1} \cdot e^{-\frac{1}{2R} \cdot k_i^{1/3}} \right] \geq 1 - n^{-3} \cdot \kappa \geq 1 - \frac{1}{4} n^{-2}.$$

By considering the ratio of two consecutive terms for i and $i + 1$ in the sum, we have that

$$8 \cdot e^{\frac{1}{2R} \cdot (k_{i+1}^{1/3} - k_i^{1/3})} \stackrel{(a)}{\leq} 8 \cdot e^{\frac{1}{2R} \cdot (-\frac{1}{2} k_i^{1/3})} \stackrel{(b)}{\leq} \frac{1}{2},$$

using in (a) that $k_{i+1}^{1/3} \leq \frac{1}{2} k_i^{1/3}$ (since $k_\kappa \geq (\frac{8 \cdot 16d}{p})^4$) and in (b) that $k_\kappa \geq (32R \log R)^3$. Hence,

$$\mathbb{P} \left[\sum_{i=0}^{\kappa} 8^{\kappa-i+1} \sum_{j \in [n]: \delta_{t_i}(j) \geq k_i^{2/3}} \delta_{t_i}(j) \leq n \right] \geq 1 - \frac{1}{2} n^{-2}. \quad \square$$

Proof outline of Claim 26. We start by bounding tdsp using $\tilde{\Phi}_m$ as follows

$$\text{tdsp}(l_m, \tau_m) \leq \frac{n}{\tilde{\alpha}} \cdot \log \left(1 + \frac{\tilde{\Phi}_m}{n} \right), \quad (28)$$

where we used the convexity of the $\tilde{\Phi}_m$, i.e.,

$$n \cdot \left(\exp \left(\tilde{\alpha} \cdot \frac{1}{n} \text{tdsp}(l_m, \tau_m) \right) - 1 \right) = n \cdot \left(\exp \left(\tilde{\alpha} \cdot \frac{1}{n} \sum_{j \in [N]} |j - d \cdot \tau_m(l_m[j])| \right) - 1 \right) \leq \tilde{\Phi}_m.$$

Analysis for Φ : Proving a $\text{poly}(n)$ bound. Note that by the choice of α and d , it follows that $\alpha(d-1) \geq \log 20$ and so by Lemma 15 it satisfies the drop inequality for sorting steps. Further, by Lemma 12, we have that

$$\text{mdev}(\tau_{t_i}, \tau'_{t_i}) \leq 4k_i^{2/3}. \quad (29)$$

As in the analysis in Theorem 17, we have that for any $r \geq \rho$,

$$\mathbb{E} [\Phi_r] \leq 2n \cdot e^{\alpha \cdot d \cdot \frac{1}{\lambda} \sqrt{108 \cdot c' \cdot k_0 \cdot \log n}}.$$

For the next phase, because each displacement in τ with respect to l changes $|l[i] - \tau(l[i])|$ by at most $k_0^{2/3}$, we have that

$$\mathbb{E} [\Phi_{t_0}] \leq 2n \cdot e^{\alpha \cdot dk_0^{2/3}},$$

and similarly

$$\mathbb{E} [\Phi_{t_1}] \leq 2n \cdot e^{4\alpha \cdot dk_1^{2/3}}.$$

Now, for any $i \in [2, \kappa]$,

$$\mathbb{E} [\Phi_{t_i}] \leq \mathbb{E} [\Phi_{t_{i-1}}] \cdot e^{-\frac{p\alpha}{4} \cdot k_i} \cdot e^{4\alpha \cdot dk_i^{2/3}} + n \cdot e^{4\alpha \cdot dk_i^{2/3}} \leq 2n \cdot e^{4\alpha \cdot dk_i^{2/3}},$$

using that $k_{i+1} = \frac{16d}{p} \cdot k_i^{2/3}$. Hence, we conclude that for any $t \in [t_1, t_\kappa]$, it follows that

$$\mathbb{E} [\Phi_t] \leq 2n \cdot e^{4\alpha \cdot dk_1^{2/3}} \leq n^2,$$

using that $k_1 = O(\log n)$. By Markov's inequality for any $t \in [t_1, t_\kappa]$,

$$\mathbb{P}[\Phi_t \leq n^7] \geq 1 - n^{-5},$$

and by taking the union-bound over all steps in $[t_1, t_\kappa]$

$$\mathbb{P}\left[\bigcap_{t \in [t_1, t_\kappa]} \{\Phi_t \leq n^7\}\right] \geq 1 - n^{-5} \cdot n \cdot O(\log n) \geq 1 - \frac{1}{2}n^{-3}.$$

Therefore, for $\tilde{c} = \frac{7}{\alpha}$, it follows that

$$\mathbb{P}\left[\bigcap_{t \in [t_1, t_\kappa]} \left\{ \text{mdsp}(l_t, \tau_t) \leq \tilde{c} \cdot \log n \right\}\right] \geq 1 - \frac{1}{2}n^{-3}. \quad (30)$$

From here onwards we will consider the *capped process* that never performs a mixing operation if the maximum displacement exceeds $\tilde{c} \cdot \log n$ in any step in $[t_1, t_\kappa]$. In the end, by the union bound, w.h.p. the two processes will agree.

Analysis for $\tilde{\Phi}$: Proving an $O(n)$ bound. Recall that $\tilde{\Phi} = \tilde{\Phi}(\tilde{\alpha}, d)$ with $\tilde{\alpha} = \frac{1}{6\tilde{c}} = \frac{\alpha}{42}$ for the same d as above. Note again that $\tilde{\alpha} \cdot (d-1) \geq \log(20)$ and so we can apply [Lemma 15](#) to deduce as before that

$$\mathbb{E}[\tilde{\Phi}_{t_0}] \leq 4n \cdot e^{4\alpha \cdot d \cdot k_0^{2/3}}.$$

At step t_1 before applying the target corrections, we have that

$$\mathbb{E}[\tilde{\Phi}_{t_1}] \leq 4n \cdot e^{4\tilde{\alpha} \cdot d \cdot k_0^{2/3}} \cdot e^{-\frac{\tilde{\alpha} p}{4} \cdot k_1} \leq n^{-3},$$

using that $k_1 = \frac{16^2 \cdot 108 \cdot d^2}{p^2} \cdot \frac{c'}{\lambda} \cdot \log n$ (and so $\frac{\tilde{\alpha} p}{4} \cdot k_1 \geq 60 \log n$).

Therefore, by Markov's inequality we have that

$$\mathbb{P}[\tilde{\Phi}_{t_1} \leq 1] \geq 1 - n^{-3},$$

and so, after moving the targets we have that

$$\mathbb{P}[\tilde{\Phi}_{t_1} \leq 4n \cdot e^{2\alpha \cdot d \cdot k_1^{2/3}}] \geq 1 - n^{-3}. \quad (31)$$

We will consider the interval $[t_i, t_{i+1}]$ consisting of $n \cdot k_{i+1}$ steps, where in step t_i we have that $\tilde{\Phi}_{t_i} \leq 4n \cdot e^{2\alpha \cdot d \cdot k_i^{2/3}}$. Our goal is to show that w.h.p. $\tilde{\Phi}_{t_{i+1}} \leq 4n$, by applying Azuma's inequality.

Recall that since we are in the capped process, we have that $\text{mdsp}(l_t, \tau_t) \leq \tilde{c} \cdot \log n$ holds in every step and so

$$\tilde{\phi}_t(i) \leq e^{\frac{1}{6\tilde{c}} \cdot \tilde{c} \cdot \log n} = n^{1/6}.$$

This also implies that

$$\tilde{\Phi}_t \leq n^{7/6}. \quad (32)$$

Let Φ'_t be the value of the potential before applying the adm and lopt operations, which can only lead to a decrease, i.e., $\Phi_t \leq \Phi'_t$. We define the auxiliary potential function at step $t \geq t_i$,

$$\hat{\Phi}_t = \tilde{\Phi}_t \cdot \left(1 - \frac{\tilde{\alpha}}{4 \cdot (n-1)}\right)^{-z(t)} \quad \text{and} \quad \hat{\Phi}'_t = \tilde{\Phi}'_t \cdot \left(1 - \frac{\tilde{\alpha}}{4 \cdot (n-1)}\right)^{-z(t)},$$

where $z(t)$ is the number of completed sorting steps from step $t_i + 1$ up to step t . This is a super-martingale, since in any sorting step we have that

$$\mathbb{E} \left[\widehat{\Phi}'_{t+1} \mid \mathcal{F}_r \right] \leq \widetilde{\Phi}_t \cdot \left(1 - \frac{\tilde{\alpha}}{4 \cdot (n-1)} \right) \cdot \left(1 - \frac{\tilde{\alpha}}{4 \cdot (n-1)} \right)^{-z(t)-1} = \widehat{\Phi}_t.$$

and in any mixing step we have that $\widehat{\Phi}_t \leq \widehat{\Phi}'_{t+1}$.

We now proceed to bound the difference $|\widehat{\Phi}'_{t+1} - \widehat{\Phi}_t|$. First note that by the definition of microsteps we have that

$$\left| \widetilde{\Phi}'_{t+1} - \widetilde{\Phi}_t \right| \leq n^{1/6}, \quad (33)$$

and further note that

$$\left(1 - \frac{\tilde{\alpha}}{4(n-1)} \right)^{-z(t)} \stackrel{(a)}{\leq} \left(1 + \frac{\tilde{\alpha}}{2(n-1)} \right)^{z(t)} \stackrel{(b)}{\leq} e^{\frac{\tilde{\alpha} p}{2(n-1)} \cdot n \cdot k_{i+1}} \leq n^{1/6}, \quad (34)$$

using in (a) that $(1 - \frac{\tilde{\alpha}}{4(n-1)})^{-1} \leq 1 + \frac{\tilde{\alpha}}{2(n-1)}$ (since $\frac{1}{1-\epsilon} \leq 1 + 2\epsilon$) and in (b) that $z(t) \leq n \cdot k_{i+1} \cdot p$ (by [Lemma 34](#)), $k_i = o(\log n)$ (for $i \geq 2$) and $\tilde{\alpha}$ is a constant.

Therefore, combining the above bounds, it follows that

$$\begin{aligned} \left| \widehat{\Phi}'_{t+1} - \widehat{\Phi}_t \right| &\leq \max \left\{ \left| \left(1 - \frac{\tilde{\alpha}}{4(n-1)} \right)^{-1} \cdot \widetilde{\Phi}'_{t+1} - \widetilde{\Phi}_t \right|, \left| \widetilde{\Phi}'_{t+1} - \widetilde{\Phi}_t \right| \right\} \cdot \left(1 - \frac{\tilde{\alpha}}{4(n-1)} \right)^{-z(t)} \\ &\stackrel{(a)}{\leq} \left(\left| \widetilde{\Phi}'_{t+1} - \widetilde{\Phi}_t \right| + \frac{\tilde{\alpha}}{2(n-1)} \cdot \widetilde{\Phi}'_{t+1} \right) \cdot \left(1 - \frac{\tilde{\alpha}}{4(n-1)} \right)^{-z(t)} \\ &\stackrel{(b)}{\leq} \left(n^{1/6} + 2n^{1/6} \right) \cdot n^{1/6} \leq 3n^{1/3}, \end{aligned}$$

using in (a) that $(1 - \frac{\tilde{\alpha}}{4(n-1)})^{-1} \leq 1 + \frac{\tilde{\alpha}}{2(n-1)}$ (since $\frac{1}{1-\epsilon} \leq 1 + 2\epsilon$) and in (b) the bounds [\(32\)](#), [\(33\)](#) and [\(34\)](#).

Applying Azuma's inequality ([Lemma 31](#)) for the sub-martingale $\widehat{\Phi}_{t_i}, \widehat{\Phi}'_{t_i+1}, \widehat{\Phi}_{t_i+1}, \dots$ with $\lambda = n$ and $D = 3n^{1/3}$

$$\mathbb{P} \left[\widehat{\Phi}_{t_{i+1}} \leq \widehat{\Phi}_{t_i} + n \mid \mathcal{F}_{t_i}, \widetilde{\Phi}_{t_i} \leq 4n \cdot e^{4\tilde{\alpha} \cdot d \cdot k_i^{2/3}} \right] \geq 1 - \exp \left(- \frac{n^2}{3n \cdot k_{i+1} \cdot (3n^{1/3})^2 + \widetilde{\Phi}_{t_i} \cdot (3n^{1/3})} \right).$$

By the definition of $\widehat{\Phi}_t$, we have that

$$\widehat{\Phi}_{t_i} = \widetilde{\Phi}_{t_i} \leq 4n \cdot e^{4\tilde{\alpha} \cdot d \cdot k_i^{2/3}},$$

and for $\widetilde{\Phi}''_{t_{i+1}}$ the value of the potential before the θ -filtering, assuming that $\{\widehat{\Phi}_{t_{i+1}} \leq \widehat{\Phi}_{t_i} + n\}$ holds, we get that

$$\widetilde{\Phi}''_{t_{i+1}} \leq \left(4n \cdot e^{4\tilde{\alpha} \cdot d \cdot k_i^{2/3}} + n \right) \cdot \left(1 - \frac{\tilde{\alpha}}{4(n-1)} \right)^{p \cdot n \cdot k_{i+1}} \leq 5n \cdot e^{4\tilde{\alpha} \cdot d \cdot k_i^{2/3}} \cdot e^{-\frac{\tilde{\alpha} p}{4 \cdot (n-1)} \cdot n \cdot k_{i+1}} \leq 4n,$$

using that $1 + x \leq e^x$ and that $k_{i+1} = \frac{16d}{p} \cdot k_i^{2/3}$.

Therefore, after the θ -filtering of the targets, using [\(29\)](#), it follows that

$$\mathbb{P} \left[\widetilde{\Phi}_{t_{i+1}} \leq 4n \cdot e^{4\tilde{\alpha} \cdot d \cdot k_{i+1}^{2/3}} \mid \mathcal{F}_{t_i}, \widetilde{\Phi}_{t_i} \leq 4n \cdot e^{4\tilde{\alpha} \cdot d \cdot k_i^{2/3}} \right] \geq 1 - n^{-3},$$

using the chain rule we obtain

$$\mathbb{P} \left[\bigcap_{i \in [\kappa]} \left\{ \tilde{\Phi}_{t_i} \leq 4n \cdot e^{4\tilde{\alpha} \cdot d \cdot k_i^{2/3}} \right\} \middle| \mathcal{F}_{t_0}, \tilde{\Phi}_{t_0} \leq 4n \cdot e^{4\tilde{\alpha} \cdot d \cdot k_1^{2/3}} \right] \geq (1 - n^{-3})^\kappa,$$

and combining with (31), we get that

$$\mathbb{P} \left[\bigcap_{i \in [\kappa]} \left\{ \tilde{\Phi}_{t_i} \leq 4n \cdot e^{4\tilde{\alpha} \cdot d \cdot k_i^{2/3}} \right\} \right] \geq (1 - n^{-3})^\kappa \cdot (1 - n^{-3}) \geq 1 - \frac{1}{4}n^{-2}.$$

Finally taking the union bound with (30) we get that the capped process agrees with the original process and so using (28), we conclude that

$$\mathbb{P} \left[\text{tdsp}(l_m, \tau_m) \leq 8n \cdot d \cdot k_\kappa^{2/3} \right] \geq 1 - \frac{1}{4}n^{-2} \frac{1}{2}n^{-3} \geq 1 - \frac{1}{2}n^{-2}. \quad \square$$

\square

5 Lower Bounds

Below we prove an asymptotically tight lower bound on the maximum and total deviation and the convergence time for the process in [AKMU11].

Lemma 27 (Maximum and Total Deviation). *Consider the process where every sorting step is followed by $b \geq 1$ mixing steps. Then, starting from a sorted list (i) it holds that at step $m = \frac{1}{100} \cdot (b+1)^2 \cdot n \log n$,*

$$\mathbb{P} \left[\bigcup_{t \in [1, m]} \text{mdev}(\pi_t) \geq \frac{1}{200} \cdot (b+1) \cdot \log n \right] \geq 1 - o(1),$$

and (ii) at step $m = \frac{1}{100} \cdot (b+1)^2 \cdot n$, it holds that

$$\mathbb{P} \left[\text{tdev}(\pi_m) \geq \frac{1}{1600} \cdot (b+1) \cdot n \right] \geq 1 - o(1).$$

Proof outline. First statement. Consider $m = c \cdot (b+1)^2 \cdot n \cdot \log n$ where $c = \frac{1}{100}$. We start with the sorted list $\pi_0 = \text{id}_n$. For each i , we keep track of $(j_t(i))_{t \geq 0}$ defined as follows $j_0(i) = i \in ((b+1) \cdot \log n, n - (b+1) \cdot \log n)$, in each mixing step we stay at the same index so $j_t(i) = j_{t-1}(i)$ and in each sorting step we follow the element at $j_{t-1}(i)$, so $j_t(i) \in \{j_{t-1}(i) - 1, j_{t-1}(i) + 1\}$. We consider the starting points \mathcal{J} which are multiples of $D = \frac{1}{400} \cdot (b+1) \cdot \log n$ and $K = (n-1)/D$, i.e., $\mathcal{J} = \{i \cdot D : i \in [K]\}$.

In these steps 1 through m , the indices in \mathcal{J} will be involved in at least $\frac{1}{2} \cdot \frac{m}{K}$ mixing steps. Also during these steps, as long as none of the indices has a deviation that is at least $\frac{1}{400} \cdot (b+1) \cdot \log n$ it means that each index is doing an unbiased random walk that does not interfere with the others. Hence, w.h.p. there is a particular $j_t(i)$ with $|j_t(i) - i| \geq \frac{1}{4}\sqrt{c} \cdot (b+1) \cdot \log n$, due to the mixing steps (by taking the maximum deviation of the $K \geq \log^2 n$ unbiased random walks). Further, by a Chernoff bound (Lemma 29), w.h.p. this value will be chosen in a sorting step at most $2\frac{m}{n} \cdot (b+1) = 2c \cdot (b+1) \cdot \log n$ times. Even if each of these sorting steps moves the item closer to the target, w.h.p. we have that

$$\text{mdev}(\pi_m) \geq \frac{1}{40} \cdot (b+1) \cdot \log n - \frac{1}{50} \cdot (b+1) \cdot \log n = \frac{1}{200} \cdot (b+1) \cdot \log n,$$

which concludes the proof for the first statement.

Second statement. We will consider the first $m = c \cdot (b + 1)^2 \cdot n$ steps where $c = \frac{1}{100}$. By the Central Limit Theorem w.h.p. at least $\frac{1}{4}n$ of the indices i will have $|j_t(i) - i| \geq \frac{1}{4} \cdot \sqrt{c} \cdot (b + 1)$ and at most a $\frac{1}{2}$ of these will be involved in more than $2 \cdot c \cdot (b + 1)$ sorting steps. Hence, it follows that w.h.p.

$$\text{tdev}(\pi_m) \geq \frac{1}{8} \cdot \frac{1}{200} \cdot (b + 1) \cdot n,$$

which concludes the proof for the second statement. \square

Next, we prove a lower bound on the convergence time depending on the maximum deviation of the initial configuration.

Lemma 28 (Convergence time). *Consider the process where every sorting step is followed by any constant $b \geq 1$ mixing steps, starting from any configuration π_0 with $\text{mdev}(\pi_0) \geq 96 \log n$. Then, the convergence time to a configuration with the maximum deviation being $O(\log n)$ is at least $\frac{1}{2}(n - 1) \cdot \text{mdev}(\pi_0)$ with probability at least $1 - n^{-1}$.*

Proof. Consider the first $m = \frac{1}{2}n \cdot \text{mdev}(\pi_0)$ steps of the algorithm. We will maintain a sequence of elements $(i_t)_{t=0}^m$, with the property that their displacement decreases with probability at most $1/n$. We start with i_0 being an element achieving the maximum deviation at step 0. Then, at step $t \geq 0$:

- If $t + 1$ a sorting step, at most one of the two swaps that involve i_t , either at index $\pi_t^{-1}(i_t) - 1$ or at $\pi_t^{-1}(i_t)$ will reduce the displacement of i . So we keep $i_{t+1} = i_t$.
- If $t + 1$ is a mixing step, it could be that both swaps involving i_t decrease the displacement of i_t . However, in this case the displacement of either $i_t - 1$ or $i_t + 1$ will be at least $|i_t - \pi_t(i_t)| - 1$ (after the swap), so we update i_{t+1} to that element.

then the displacement of element i_t in each step decreases by 1 with probability at most $1/(n - 1)$. Let D_m be the amount it decreases in m steps, then, using a Chernoff bound ([Lemma 29](#))

$$\mathbb{P} \left[D_m \leq \left(1 + \frac{1}{2}\right) \cdot \frac{1}{n - 1} \cdot m \right] \geq 1 - e^{-\frac{1}{4} \cdot \frac{1}{2} \cdot \text{mdev}(\pi_0)/3} \geq 1 - e^{-\frac{1}{4} \cdot \frac{1}{3} \cdot \frac{1}{2} \cdot 96 \cdot \log n} = 1 - n^{-1},$$

using that $\text{mdev}(\pi_0) \geq 96 \cdot \log n$, and so

$$\mathbb{P} \left[D_m \leq \frac{3}{4} \text{mdev}(\pi_0) \right] \geq 1 - n^{-1}.$$

Finally, using that $\text{mdev}(\pi_m) \geq \text{mdev}(\pi_0) - D_m$, we conclude that

$$\mathbb{P} \left[\text{mdev}(\pi_m) \geq \frac{1}{4} \text{mdev}(\pi_0) \right] \geq 1 - n^{-1},$$

and therefore the process takes at least m steps to converge. \square

APPENDIX

A Tools

A.1 Concentration Inequalities

We begin with a standard Chernoff bound.

Lemma 29. Let X_1, \dots, X_n be independent random variables taking values in $\{0, 1\}$. Let $X = \sum_{i=1}^n X_i$ and $\mu = \mathbb{E}[X]$. Then for any $\delta \in (0, 1)$, we have that

$$\max \{ \mathbb{P}[X \geq (1 + \delta) \cdot \mu], \mathbb{P}[X \leq (1 - \delta) \cdot \mu] \} \leq e^{-\delta^2 \mu / 3}.$$

Next, we state Azuma's inequality.

Lemma 30 (Azuma's Inequality for Super-Martingales [DP09, Problem 6.5]). Let X_0, \dots, X_n be a super-martingale satisfying $|X_i - X_{i-1}| \leq c_i$ for any $i \in [n]$, then for any $\lambda > 0$,

$$\mathbb{P}[X_n \geq X_0 + \lambda] \leq \exp\left(-\frac{\lambda^2}{2 \cdot \sum_{i=1}^n c_i^2}\right).$$

Next, we state and prove a variant of the Azuma's inequality in which every other step the sub-martingale may decrease by an arbitrary amount.

Lemma 31 (Modified Azuma). Let X_0, \dots, X_n be a non-negative super-martingale with n an even integer. Further, assume it satisfies $|X_i - X_{i-1}| \leq D$ for any odd $i \in [n]$ and $X_i \leq X_{i-1}$ for any even $i \in [n]$. Then for any $\lambda > 0$,

$$\mathbb{P}[X_n \geq X_0 + \lambda] \leq \exp\left(-\frac{\lambda^2}{3nD^2 + 2X_0 \cdot D}\right).$$

Proof outline. We cannot directly apply Azuma's inequality as it requires the absolute value of the differences to be bounded, but here at an even i the value of X_i could drop by X_i .

We will define an auxiliary sub-martingale Z and show that this satisfies $|Z_i - Z_{i-1}| \leq c$ for any i . To this end, for any $k \in \{0, \dots, n/2 - 1\}$, we define $\tau_k = \lfloor \frac{X_{2k+2} - X_{2k+1}}{c} \rfloor$ and set

$$Y_0^{(k)} = X_{2k}, Y_1^{(k)} = X_{2k+1}, Y_2^{(k)} = X_{2k+1} + d_1, Y_3^{(k)} = X_{2k+1} + d_1 + d_2, \dots, Y_{2+\tau_k}^{(k)} = X_{2k+2},$$

where

$$d_i = \begin{cases} c & i < \tau_k, \\ X_{2k+2} - X_{2k+1} - c \cdot (\tau_k - 1) & i = \tau_k. \end{cases}$$

Then, we set $Z = Y_0^{(0)}, Y_1^{(0)}, \dots, Y_0^{(1)}, Y_1^{(1)}, \dots, Y_0^{(n/2-1)}, Y_1^{(n/2-1)}$. It is clear that $Y^{(k)}$ forms a sub-martingale with respect to $\mathcal{F}'_0 = \mathcal{F}_{2k}, \mathcal{F}'_1 = \mathcal{F}_{k+1}$ and $\mathcal{F}'_{2+t} = (X_{2k+1}, t, X_{2k+2})$ for $t \in [0, \tau_k]$, and so Z also forms a sub-martingale, and further it satisfies the bounded difference inequality for D .

Throughout the n steps X can increase by at most $n/2 \cdot D$. Hence, in total there can be at most $2 \cdot (\frac{n}{2} + \frac{1}{D}X_0)$ extra decrease steps. So Z has at most $n' = \frac{3}{2} \cdot n + \frac{1}{D}X_0$ steps. By padding Z with the same last value we can ensure that it always has exactly n' steps, and it is still a sub-martingale. Therefore, applying Azuma's inequality (Lemma 30), we get that

$$\mathbb{P}[Z_{n'} \geq Z_0 + \lambda] \leq \exp\left(-\frac{\lambda^2}{3nD^2 + 2X_0 \cdot c}\right).$$

Using that $Z_0 = X_0$ and $Z_{n'} = X_n$, we obtain the conclusion. \square

B Omitted Material

In this Appendix, we first restate and establish a result whose proof was omitted. Then, we state and prove a lemma not included in the main text.

Lemma 7. *If l is a d -padding of $\pi \in \mathcal{S}_n$, then $\text{mdev}(\pi) \leq \frac{8}{d} \cdot \text{mdsp}(l)$ and $\text{tdev}(\pi) \leq \text{tdsp}(l)$.*

Proof. First statement. Let i be an element with maximum displacement $|i - \pi(i)|$ and without loss of generality assume that $\pi(i) < i$. We start with the list l having $l[j \cdot d] = \pi(j)$ and gaps in all other positions. We set $D = d \cdot |i - \pi(i)|$, the maximum displacement in l . We will prove that no matter how the gaps are redistributed in l while maintaining the relative order of the non-gap elements, we cannot reduce the maximum displacement in l down to $\frac{1}{8}D$.

In order to reduce the displacement of $\pi(i) = l[i \cdot d]$ in l to at most $\frac{1}{8}D$ we need to move at least $\frac{7}{8}D$ gaps to the left of $i \cdot d$. Note that there are no elements $j \in [i \cdot d, i \cdot d + \frac{3}{4}D]$ with $d \cdot l[j] \leq i \cdot d + \frac{3}{4}D$, as otherwise after the move their displacement in l would be at least $(i \cdot d + \frac{7}{8}D) - (i \cdot d + \frac{3}{4}D) = \frac{1}{8}D$. Hence, all of these elements have $d \cdot l[j] \geq i \cdot d + \frac{3}{4}D$. Considering position $i \cdot d + \frac{3}{4}D$, after the move the number of elements to its right is larger than the amount of multiples of d on its right (i.e., possible target positions), which means that there must be an index $k \geq i \cdot d + \frac{7}{8}D$ with $d \cdot l[k] \in [i \cdot d, i \cdot d + \frac{3}{4}D]$ and after the move its displacement will be at least $(i \cdot d + \frac{7}{8}D) - (i \cdot d + \frac{3}{4}D) = \frac{1}{8}D$. Therefore, there will be at least one element j with $|j - d \cdot l[j]| \geq \frac{1}{8}D$, concluding the proof.

Second statement. Let $T = \{j \cdot d : j \in [n]\}$ be the subset of all target positions in list l . We first move all n items to positions in T , such that if an item $j \in [n]$ is at a position $x \in (i \cdot d, (i+1) \cdot d)$, we move j to position $i \cdot d$ if $j \leq i$ else we move it to $(i+1) \cdot d$; this may result in more than one element mapped to the same position. Note that this step can only decrease the displacement of each element (and thus also the total displacement).

Let $L_i = \{j \cdot d : j \in [1, i]\}$ and $R_i = \{j \cdot d : j \in (i, n]\}$. Let s_i be the **total** number of items mapped to positions in L_i . Note that with respect to partition $\{L_i, R_i\}$ of T , there are at least $|s_i - i|$ elements j whose target position $j \cdot d$ is in a different part of the partition than the one at which element j is mapped to.

It follows that by “ignoring” all positions $x \in (i \cdot d, (i+1) \cdot d)$ when computing the total displacement, the total displacement reduces by at least $|s_i - i| \cdot (d - 1)$. And if we ignore all positions except for those in T , the total displacement decreases by at least $\sum_{i \in [n]} |s_i - i| \cdot (d - 1)$.

The last step is to redistribute the items so that exactly one item is mapped to each position in T . This may increase the total displacement by at most $\sum_{i \in [n]} |s_i - 1|$ as we explain next, and combining this with the previous point we get that overall the total displacement decreases.

To map one item to each position in T , for each $i \in [n - 1]$, we have to move exactly $|s_i - i|$ items between $i \cdot d$ and $(i+1) \cdot d$: from $i \cdot d$ to $(i+1) \cdot d$ if $s_i > i$ and in the opposite direction otherwise. The total displacement we have computed above is the same as the total deviation in π , and so the conclusion follows. \square

Lemma 32. *Consider any reals a, b, c, d such that $a \leq b$ and $c \leq d$. Then, (i)*

$$|a - c| + |b - d| \leq |a - d| + |b - c|,$$

and (ii)

$$\max\{|a - c|, |b - d|\} \leq \max\{|a - d|, |b - c|\}.$$

Proof. Without loss of generality assume that $a < c$. Then, we consider the three valid cases separately:

Case 1 [$a \leq b \leq c \leq d$]: In this case,

$$|a - c| + |b - d| = (c - a) + (d - b) = (d - a) + (c - b) = |a - d| + |b - c|.$$

And similarly,

$$\max\{|a - c|, |b - d|\} = \max\{c - a, d - b\} \leq d - a = \max\{|a - d|, |b - c|\}.$$

Case 2 [$a \leq c \leq b \leq d$]: In this case,

$$|a - c| + |b - d| = (c - a) + (d - b) = (d - a) - (b - c) = |a - d| - |b - c| \leq |a - d| + |b - c|.$$

And similarly,

$$\max\{|a - c|, |b - d|\} = \max\{c - a, d - b\} \leq d - a = \max\{|a - d|, |b - c|\}.$$

Case 3 [$a \leq c \leq d \leq b$]: In this case,

$$|a - c| + |b - d| = (c - a) + (b - d) \leq (d - a) + (b - c) = |a - d| + |b - c|.$$

And similarly,

$$\max\{|a - c|, |b - d|\} = \max\{c - a, d - b\} \leq \max\{d - a, b - c\} = \max\{|a - d|, |b - c|\}. \quad \square$$

Lemma 33. Consider any random variable $S \geq 0$ for which there exists $\lambda > 0$ and $c' > 0$ such that $\mathbb{E}[e^{3\lambda S}] \leq c'$. Then, for any $\alpha \in [-\lambda, \lambda]$, it holds that

$$\mathbb{E}[e^{\alpha S}] \leq 1 + \alpha \cdot \mathbb{E}[S] + \alpha^2 \cdot \frac{c'}{\lambda^2}.$$

Proof. Consider the function

$$f(\alpha) = \mathbb{E}[e^{\alpha S}].$$

Then, by Taylor's theorem we have that for any $\alpha \in [-\lambda, \lambda]$, there exists $\xi \in (-\lambda, \lambda)$ such that

$$\begin{aligned} f(\alpha) &= f(0) + \alpha \cdot f'(0) + \frac{\alpha^2}{2} \cdot f''(\xi) \\ &= 1 + \alpha \cdot \mathbb{E}[S] + \frac{\alpha^2}{2} \cdot \mathbb{E}[S^2 \cdot e^{\xi S}] \\ &\stackrel{(a)}{\leq} 1 + \alpha \cdot \mathbb{E}[S] + \alpha^2 \cdot \mathbb{E}[S^2 \cdot e^{\lambda S}] \\ &\stackrel{(b)}{\leq} 1 + \alpha \cdot \mathbb{E}[S] + \alpha^2 \cdot \mathbb{E}\left[\left(\frac{e^{\lambda S}}{\lambda}\right)^2 \cdot e^{\lambda S}\right] \\ &\stackrel{(c)}{\leq} 1 + \alpha \cdot \mathbb{E}[S] + \alpha^2 \cdot \frac{c'}{\lambda^2}, \end{aligned}$$

using in (a) that $\xi < \lambda$, in (b) that $S \leq \frac{e^{\lambda S}}{\lambda}$ and in (c) that $\mathbb{E}[e^{3\lambda S}] \leq c'$. \square

Lemma 34. Consider a process with bounded average rate of mixing steps for any $b \geq 1$. Then for any $m \geq (b + 1) \cdot n$ steps, at least a $\frac{1}{4(b+1)}$ fraction are sorting steps.

Proof. Consider any interval $[s, t]$ with $|t - s| = (b + 1) \cdot n$. Let u be the last sorting step before s , then by Definition 4, it follows that the next $n - 1$ sorting steps are in the interval $[s, t]$. Hence, in any interval of length $(b + 1) \cdot n$, there is at least a fraction of $\frac{n-1}{(b+1) \cdot n} \geq \frac{1}{2 \cdot (b+1)}$ sorting steps.

For intervals of length at least $(b + 1) \cdot n$, by splitting it into sub-intervals of length $(b + 1) \cdot n$ (except for possibly the last one), we get that at least a $\frac{1}{2} \cdot \frac{1}{2(b+1)}$ fraction of the steps are sorting. \square

References

- [AKM⁺12] Aris Anagnostopoulos, Ravi Kumar, Mohammad Mahdian, Eli Upfal, and Fabio Vandin. Algorithms on evolving graphs. In *Proc. Innovations in Theoretical Computer Science, ITCS*, pages 149–160, 2012. doi:10.1145/2090236.2090249.
- [AKMU09] Aris Anagnostopoulos, Ravi Kumar, Mohammad Mahdian, and Eli Upfal. Sort me if you can: How to sort dynamic data. In *Proc. 36th International Colloquium on Automata, Languages and Programming, ICALP*, pages 339–350, 2009. doi:10.1007/978-3-642-02930-1_28.
- [AKMU11] Aris Anagnostopoulos, Ravi Kumar, Mohammad Mahdian, and Eli Upfal. Sorting and selection on dynamic data. *Theor. Comput. Sci.*, 412(24):2564–2576, 2011. doi:10.1016/j.tcs.2010.10.003.
- [ALL⁺16] Aris Anagnostopoulos, Jakub Lacki, Silvio Lattanzi, Stefano Leonardi, and Mohammad Mahdian. Community detection on evolving graphs. In *Proc. Annual Conference on Neural Information Processing Systems, NIPS*, pages 3522–3530, 2016. URL: https://proceedings.neurips.cc/paper_files/paper/2016/file/8698ff92115213ab187d3
- [AM22] Aditya Acharya and David M. Mount. Optimally tracking labels on an evolving tree. In *Proc. 34th Canadian Conference on Computational Geometry, CCCG*, pages 1–8, 2022. URL: <https://www.torontomu.ca/content/dam/canadian-conference-computational-geometry->
- [BBHM05] Itai Benjamini, Noam Berger, Christopher Hoffman, and Elchanan Mossel. Mixing times of the biased card shuffling and the asymmetric exclusion process. *Trans. American Mathematical Society*, 357(8):3013–3029, 2005. URL: <http://www.jstor.org/stable/3845086>.
- [BKMU12] Bahman Bahmani, Ravi Kumar, Mohammad Mahdian, and Eli Upfal. Pagerank on an evolving graph. In *Proc. 18th ACM SIGKDD International Conference on Knowledge Discovery and Data Mining, KDD*, pages 24–32, 2012. doi:10.1145/2339530.2339539.
- [BM08] Mark Braverman and Elchanan Mossel. Noisy sorting without resampling. In *Proc. Nineteenth Annual ACM-SIAM Symposium on Discrete Algorithms, SODA*, pages 268–276, 2008. URL: <http://dl.acm.org/citation.cfm?id=1347082.1347112>.
- [BVDE⁺18a] Juan José Besa Vial, William E. Devanny, David Eppstein, Michael T. Goodrich, and Timothy Johnson. Optimally sorting evolving data. In *Proc. 45th International Colloquium on Automata, Languages, and Programming, ICALP*, pages 81:1–81:13, 2018. doi:10.4230/LIPICs.ICALP.2018.81.
- [BVDE⁺18b] Juan José Besa Vial, William E. Devanny, David Eppstein, Michael T. Goodrich, and Timothy Johnson. Quadratic time algorithms appear to be optimal for sorting evolving data. In *Proc. Twentieth Workshop on Algorithm Engineering and Experiments, ALENEX*, pages 87–96, 2018. doi:10.1137/1.9781611975055.8.
- [DEGI10] Camil Demetrescu, David Eppstein, Zvi Galil, and Giuseppe F. Italiano. Dynamic graph algorithms. In *Algorithms and Theory of Computation Handbook: General Concepts and Techniques*. Chapman & Hall/CRC, 2 edition, 2010. doi:10.1201/9781584888239.
- [DG18] Persi Diaconis and Ronald L. Graham. Spearman’s footrule as a measure of disarray. *Journal of the Royal Statistical Society: Series B (Methodological)*, 39(2):262–268, 2018. doi:10.1111/j.2517-6161.1977.tb01624.x.
- [DP09] Devdatt P. Dubhashi and Alessandro Panconesi. *Concentration of measure for the analysis of randomized algorithms*. Cambridge University Press, Cambridge, 2009. doi:10.1017/CBO9780511581274.
- [DR00] Persi Diaconis and Arun Ram. Analysis of systematic scan Metropolis algorithms using Iwahori-Hecke algebra techniques. *Michigan Mathematical Journal*, 48(1):157 – 190, 2000. doi:10.1307/mmj/1030132713.

- [ELS15] Alessandro Epasto, Silvio Lattanzi, and Mauro Sozio. Efficient densest subgraph computation in evolving graphs. In *Proc. 24th International Conference on World Wide Web, WWW*, pages 300–310, 2015. doi:[10.1145/2736277.2741638](https://doi.org/10.1145/2736277.2741638).
- [FRPU94] Uriel Feige, Prabhakar Raghavan, David Peleg, and Eli Upfal. Computing with noisy information. *SIAM J. Comput.*, 23(5):1001–1018, 1994. doi:[10.1137/S0097539791195877](https://doi.org/10.1137/S0097539791195877).
- [Gli02] Mark E. Glickman. Parameter estimation in large dynamic paired comparison experiments. *Journal of the Royal Statistical Society Series C: Applied Statistics*, 48(3):377–394, 01 2002. doi:[10.1111/1467-9876.00159](https://doi.org/10.1111/1467-9876.00159).
- [GSS23] Leszek Gasieniec, Paul G. Spirakis, and Grzegorz Stachowiak. New clocks, optimal line formation and self-replication population protocols. In *Proc. 40th International Symposium on Theoretical Aspects of Computer Science, STACS*, pages 33:1–33:22, 2023. doi:[10.4230/LIPICS.STACS.2023.33](https://doi.org/10.4230/LIPICS.STACS.2023.33).
- [GX23] Yuzhou Gu and Yinzhan Xu. Optimal bounds for noisy sorting. In *Proc. 55th Annual ACM Symposium on Theory of Computing, STOC*, pages 1502–1515, 2023. doi:[10.1145/3564246.3585131](https://doi.org/10.1145/3564246.3585131).
- [HLSZ17] Qin Huang, Xingwu Liu, Xiaoming Sun, and Jialin Zhang. Partial sorting problem on evolving data. *Algorithmica*, 79(3):960–983, 2017. doi:[10.1007/S00453-017-0295-3](https://doi.org/10.1007/S00453-017-0295-3).
- [Ken38] M. G. Kendall. A new measure of rank correlation. *Biometrika*, 30(1/2):81–93, 1938. URL: <http://www.jstor.org/stable/2332226>.
- [KLM16] Varun Kanade, Nikos Leonardos, and Frédéric Magniez. Stable matching with evolving preferences. In *Proc. Approximation, Randomization, and Combinatorial Optimization. Algorithms and Techniques, APPROX/RANDOM*, pages 36:1–36:13, 2016. doi:[10.4230/LIPICS.APPROX-RANDOM.2016.36](https://doi.org/10.4230/LIPICS.APPROX-RANDOM.2016.36).
- [Knu98] Donald Ervin Knuth. *The art of computer programming, Volume III, 2nd Edition*. Addison-Wesley, 1998. doi:<https://dl.acm.org/doi/10.5555/280635>.
- [LS22] Dimitrios Los and Thomas Sauerwald. Balanced allocations with incomplete information: The power of two queries. In *Proc. 13th Innovations in Theoretical Computer Science Conference, ITCS*, pages 103:1–103:23, 2022. doi:[10.4230/LIPICS.ITCS.2022.103](https://doi.org/10.4230/LIPICS.ITCS.2022.103).
- [Mah14] Mohammad Mahdian. Algorithms on evolving data sets. Talk given at ICERM/Brown Workshop on Stochastic Graph Models, March 17–21, 2014. URL: https://icerm.brown.edu/materials/Slides/sp-s14-w2/Algorithms_on_Evolving_Data_S
- [ML21] Dingheng Mo and Siqiang Luo. Agenda: Robust personalized pageranks in evolving graphs. In *Proc. 30th ACM International Conference on Information and Knowledge Management, CIKM*, pages 1315–1324, 2021. doi:[10.1145/3459637.3482317](https://doi.org/10.1145/3459637.3482317).
- [OMK15] Naoto Ohsaka, Takanori Maehara, and Ken-ichi Kawarabayashi. Efficient pagerank tracking in evolving networks. In *Proc. 21th ACM SIGKDD International Conference on Knowledge Discovery and Data Mining, KDD*, pages 875–884, 2015. doi:[10.1145/2783258.2783297](https://doi.org/10.1145/2783258.2783297).