

Frogs, hats and common subsequences

Joseph Briggs* Alex Parker^{†‡} Coy Schwieder^{†‡} Chris Wells*[‡]

Abstract

Write $W^{(n)}$ to mean the n -letter word obtained by repeating a fixed word W and let R_n denote a uniformly random n -letter word sampled from the same alphabet as W . We are interested in the average length of the longest common subsequence between $W^{(n)}$ and R_n , which is known to be $\gamma(W) \cdot n + o(n)$ for some constant $\gamma(W)$. Bukh and Cox recently developed an interacting particle system, dubbed the frog dynamics, which can be used to compute the constant $\gamma(W)$ for any fixed word W . They successfully analyzed the simplest case of the frog dynamics to find an explicit formula for the constants $\gamma(12 \cdots k)$. We continue this study by using the frog dynamics to find an explicit formula for the constants $\gamma(12 \cdots kk \cdots 21)$. The frog dynamics in this case is a variation of the PushTASEP on the ring where some clocks are identical. Interestingly, exclusion processes with correlated clocks of this type appear to have not been analyzed before. Our analysis leads to a seemingly new combinatorial object which could be of independent interest: frogs with hats!

1 Introduction

A *word* is a finite sequence of letters from some alphabet. A *subsequence* of a word W is a word obtained by deleting some letters from W ; the letters in a subsequence are not required to appear contiguously in W . A *common subsequence* between words W and W' is a subsequence of both W and W' . We denote by $\text{LCS}(W, W')$ the length of the *longest common subsequence* between W and W' . The quantity $\text{LCS}(W, W')$ is a measure of similarity between W and W' and is equivalent to the edit distance between W and W' ; that is, the fewest number of insertions/deletions needed to transform W into W' .

Throughout the paper, we use Σ to denote an alphabet (which is simply a finite set) and write $R \sim \Sigma^n$ to indicate that R is a word chosen uniformly at random from Σ^n .

A fundamental, long-standing problem is to understand $\text{LCS}(R, R')$ for a pair of independently sampled $R, R' \sim \Sigma^n$. This problem was introduced by Chvátal and Sankoff [5] in 1975 and it is still poorly understood to date. In [5], Chvátal and Sankoff proved that for any alphabet Σ , there exists a constant $\gamma = \gamma(|\Sigma|)$ for which

$$\mathbb{E}_{R, R' \sim \Sigma^n} \text{LCS}(R, R') = \gamma n + o(n).$$

The constant γ is now known as the Chvátal–Sankoff constant for Σ . To date, not a single value of γ is known. Even in the case of the binary alphabet, the best known bounds are $0.788071 \leq \gamma(2) \leq 0.826280$, both due to Lueker [7]. However, Tiskin [9] recently announced that $\gamma(2)$ is a solution to an explicit (but large) system of polynomial equations. While individual values of γ

*Dept. of Mathematics & Statistics, Auburn University, Auburn, AL, USA. {jgb0059, coc0014}@auburn.edu.

†Dept. of Mathematics, Iowa State University, Ames, IA, USA. {abparker, cschwi}@iastate.edu.

‡Supported in part by U.S. taxpayers through NSF RTG Grant DMS-1839918.

remain unknown, Kiwi, Loebl and Matoušek [6] established the asymptotic $\gamma(k) = (2 + o(1))/\sqrt{k}$ as $k \rightarrow \infty$.

Beyond the actual value of γ , the error-term is poorly understood as well. The best bound is due to Alexander [2] who established $\mathbb{E} \text{LCS}(R, R') = \gamma n + O(\sqrt{n \log n})$, but it is thought that perhaps $\mathbb{E} \text{LCS}(R, R') = \gamma n - \Theta(n^{1/3})$ (see [4, Section 5]).

Additionally, it is thought that if $R, R' \sim \Sigma^n$, then $\text{LCS}(R, R')$ should be approximately normal with linear variance; however, it is not even known if $\text{Var} \text{LCS}(R, R')$ tends toward infinity with n .

The difficulty of understanding $\text{LCS}(R, R')$ leads one to turn to understanding a class of related, but simpler, random variables: $\text{LCS}(R, F)$ where R is random and F is “fixed” in some sense. While one can fix the word F in myriad ways, we will be concerned with the situation when F is periodic.

For a word W , write $W^{(n)}$ to denote the periodic word of length n which is obtained by repeating W the appropriate number of times (which might be fractional if $\text{len } W$ does not divide n). For example, if $W = abba$, then $W^{(2)} = ab$ and $W^{(7)} = abbaabb$.

It is a routine exercise using superadditivity to show that for any alphabet Σ and any finite word W , there is a constant $\gamma = \gamma(W, \Sigma)$ for which

$$\mathbb{E}_{R \sim \Sigma^n} \text{LCS}(R, W^{(n)}) = \gamma n + o(n).$$

The leading constant γ can be viewed as the Chvátal–Sankoff constant for the “base-word” W . Unsurprisingly, actually computing the Chvátal–Sankoff constant and determining the order-of-magnitude of the error-term for any given base-word W remains a highly non-trivial task.

The random variable $\text{LCS}(R, W^{(n)})$ appears to have first been studied in its own right by Matzinger, Lember and Durringer [8], who showed that it has linear variance when R and W come from the binary alphabet. More recently, Bukh and Cox [4] developed an interacting particle system, dubbed the frog dynamics, which allows one to compute the Chvátal–Sankoff constant and the error term for any fixed base-word W . Using the frog dynamics, they gave an explicit formula for the Chvátal–Sankoff constant and the order-of-magnitude of the error term in the case when $W = 12 \cdots k$ for some positive integer k . Their results are not limited to the case when the random and periodic words have the same length; in the following, ρ represents the ratio of their lengths.

Theorem 1 (Bukh–Cox [4]). *Fix an integer $k \geq 2$ and a alphabet $\Sigma \supseteq [k]$. For any fixed $\rho \geq 0$,*

$$\mathbb{E}_{R \sim \Sigma^n} \text{LCS}(R, (12 \cdots k)^{(\rho n)}) = \left(\left(1 - \frac{m}{k}\right) \rho + \frac{m}{|\Sigma|(k+1-m)} \right) n - \tau \sqrt{n} + O(1),$$

where $m \in [k]$ is the largest integer for which

$$\frac{k(k+1)}{|\Sigma|(k+2-m)(k+1-m)} \leq \rho, \tag{1}$$

and $\tau = \tau(k, |\Sigma|, \rho) \geq 0$ always with $\tau > 0$ if and only if equality holds in eq. (1).

Prior to this current manuscript, the theorem above is the only instance of an infinite family of periodic words for which an explicit formula for their Chvátal–Sankoff constants is known. This current paper is dedicated to expanding this list by understanding the case when $W = 12 \cdots k k \cdots 21$ for some positive integer k .

Before stating our main result, we remark that we attempted to understand many additional families of periodic words, but found success only with this particular one. It is unclear if there is something particularly special about the base-word $W = 12 \cdots k k \cdots 21$ or if we simply lacked the proper insights to go further.

Theorem 2. Fix an integer $k \geq 2$ and a alphabet $\Sigma \supseteq [k]$. For any fixed $\rho \geq 0$,

$$\mathbb{E}_{R \sim \Sigma^n} \text{LCS}(R, (12 \dots k k \dots 21)^{(\rho n)}) = \left(\left(1 - \frac{m}{2k}\right) \rho + \frac{\sum_{j \geq 0} \binom{2k-2j}{m-1-2j}}{|\Sigma| \cdot \sum_{j \geq 0} \binom{2k-2j}{m-2j}} \right) n - \tau \sqrt{n} + O(1),$$

where $m \in [2k]$ is the largest integer for which

$$\frac{2k \cdot \sum_{j \geq 0} \binom{2k-2j}{m-1-2j}}{|\Sigma| \cdot \sum_{j \geq 0} \binom{2k-2j}{m-2j}} - \frac{2k \cdot \sum_{j \geq 0} \binom{2k-2j}{m-2-2j}}{|\Sigma| \cdot \sum_{j \geq 0} \binom{2k-2j}{m-1-2j}} \leq \rho, \quad (2)$$

and $\tau = \tau(k, |\Sigma|, \rho) \geq 0$ always with $\tau > 0$ if and only if equality holds in eq. (2).

This paper is organized as follows. In Section 2, we outline the Bukh–Cox frog dynamics and demonstrate how it will be used to prove Theorem 2. Then, in Section 3, we introduce a seemingly new combinatorial object, which may be of independent interest, in order to analyze the frog dynamics: frogs with hats! Finally, in Section 4, we use the frogs with hats to compute the necessary quantities of the frog dynamics which yield Theorem 2.

1.1 Notation

For a probability measure μ , we write $x \sim \mu$ to indicate that x is distributed according to μ . For a finite set Ω , we write $x \sim \Omega$ to indicate that x is drawn uniformly at random from Ω .

For a set Ω and an element x , we write $\Omega + x$ to indicate $\Omega \cup \{x\}$ and write $\Omega - x$ to indicate $\Omega \setminus \{x\}$. We often combine these two operations, e.g. $\Omega - x + y = (\Omega \setminus \{x\}) \cup \{y\}$. These abbreviations are used to aid readability and will be avoided if they ever introduce ambiguity.

When two sets Ω_1, Ω_2 are disjoint, we will often write their union as $\Omega_1 \sqcup \Omega_2$ to emphasize the fact that the two sets are disjoint.

For integers m, n , we use the shorthand $[m, n] \stackrel{\text{def}}{=} \{m, m+1, \dots, n-1, n\}$ where $[m, n] = \emptyset$ if $n < m$. As is common, we abbreviate $[n] \stackrel{\text{def}}{=} [1, n] = \{1, 2, \dots, n\}$. For a set Ω and an integer k , we denote by $\binom{\Omega}{k}$ the set of all k -sized subsets of Ω . We additionally denote the set of all subsets of size at most k by $\binom{\Omega}{\leq k}$.

2 Preliminaries

We begin by outlining the Bukh–Cox frog dynamics from [4].

Fix a word $W \in \Sigma^\ell$ where Σ is some alphabet. Imagine a circle of ℓ lily pads, $\wp_0, \dots, \wp_{\ell-1}$, arranged in clockwise order, where \wp_i is labeled with the $(i+1)$ th letter of W . Each of these lily pads is additionally occupied by a frog. The ℓ frogs vary from a large nasty frog to a little harmless froggie. No two frogs are equally nasty and so we denote them by $\mathfrak{F}_1, \dots, \mathfrak{F}_\ell$ where \mathfrak{F}_1 is the nastiest frog and \mathfrak{F}_ℓ is the least nasty frog. The arrangement of the frogs on the lily pads is described by a bijection $F: \{\mathfrak{F}_1, \dots, \mathfrak{F}_\ell\} \rightarrow \{\wp_0, \dots, \wp_{\ell-1}\}$; any such bijection is called a *frog arrangement*.

Given a frog arrangement, the *frog process* evolves as follows:

1. The monster which lives in the pond selects some letter $a \in \Sigma$ and pokes all lily pads labeled a . This agitates any frog residing on a lily pad labeled a and makes it want to jump away.

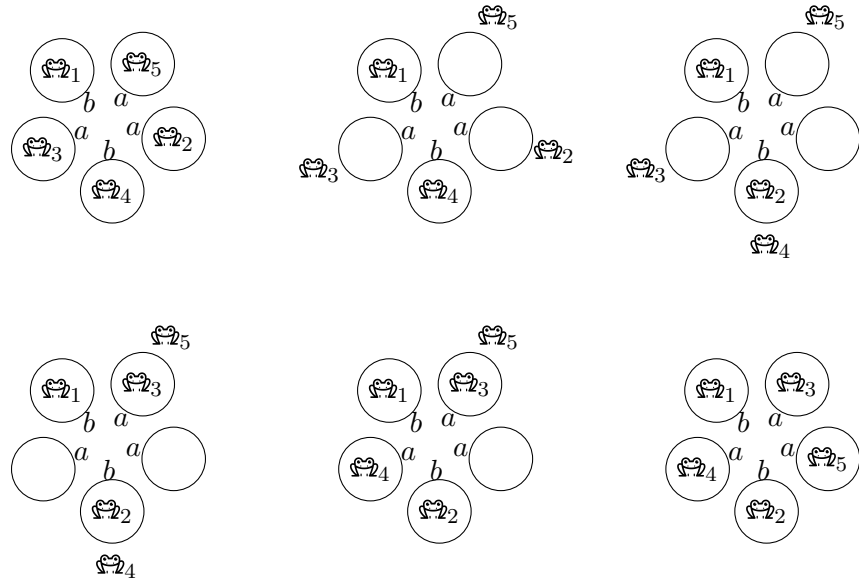

(a) The monster pokes lily pads labeled a ! The top-left image is F and the bottom-right image is Fa . Here, $D_1(F, a) = 0$, $D_2(F, a) = 1$, $D_3(F, a) = 2$, $D_4(F, a) = 1$ and $D_5(F, a) = 1$.

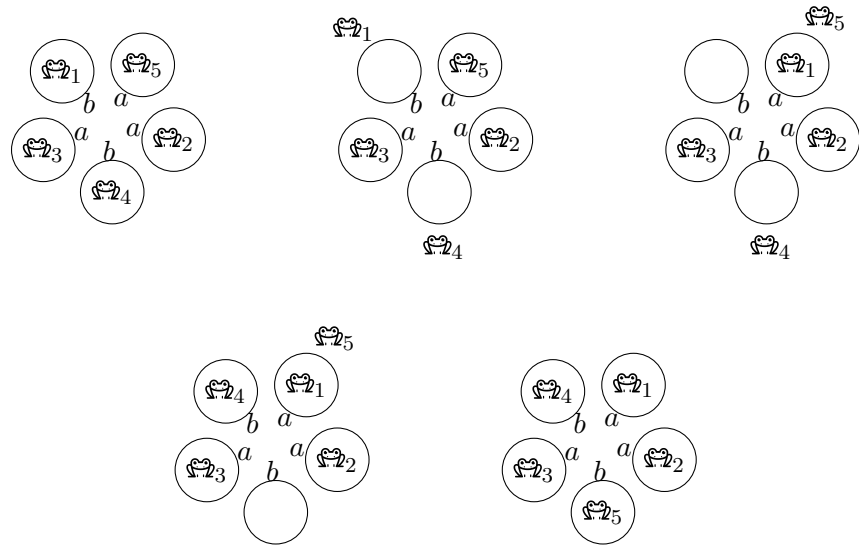

(b) The monster pokes lily pads labeled b ! The top-left image is F and the bottom-right image is Fb . Here, $D_1(F, b) = 1$, $D_2(F, b) = 0$, $D_3(F, b) = 0$, $D_4(F, b) = 2$ and $D_5(F, b) = 2$.

Figure 1: Examples of the frog process. An agitated frog is drawn just outside of the lily pad it occupies. The frogs hop in the clockwise direction.

2. In order of descending nastiness, starting from the nastiest frog \mathfrak{F}_1 , each of the agitated frogs will leap to the next ‘available’ lily pad; that is, the closest lily pad in the clockwise order that is either empty or occupied by a less nasty frog. Upon leaping to this next available lily pad, the frog that just hopped calms down and any previous occupant becomes agitated.

This repeats until all frogs are calm once more.

Note that, with each step of the process, the nastiest agitated frog gets less and less nasty. This guarantees the termination of the process and that no frog jumps over another agitated frog. Figure 1 includes two examples of the frog process.

For a frog arrangement F and a letter a , let Fa denote the frog arrangement that results from starting with F , poking all lily pads labeled a and waiting for the ensuing frenzy to settle. Note that if no lily pads are labeled a , then $Fa = F$. For each $m \in [\ell]$, let $D_m(F, a)$ denote the total number of lily pads that \mathfrak{F}_m hopped in the transition from F to Fa . For example, $D_1(F, a)$ is 1 if $F(\mathfrak{F}_1)$ is labeled a and is otherwise 0.

For a word $R = r_1 \cdots r_n \in \Sigma^n$, we write $FR \stackrel{\text{def}}{=} (((Fr_1)r_2) \cdots)r_n$. That is FR is the frog arrangement which results from first poking the letter r_1 , then poking r_2 , etc. Note that this notation respects concatenation: $(FR)R' = F(RR')$ for any two words R, R' . We additionally set $D_m(F, R)$ to be the total displacement of \mathfrak{F}_m upon poking r_1 , then poking r_2 , etc. Note that $D_m(F, RR') = D_m(F, R) + D_m(FR, R')$ for any two words R, R' .

Starting with a frog arrangement F_0 , set $F_n = F_0 r_1 r_2 \cdots r_n$ where the letters r_1, r_2, \dots are chosen independently and uniformly from Σ . Since $F_n = F_{n-1} r_n$, the sequence F_0, F_1, F_2, \dots forms a Markov chain, which is known as the (W, Σ) frog dynamics.

Remark. The frog dynamics is a particular variation on the so-called ‘‘colored/multi-species Push-TASEP on the ring’’. We direct the reader to [1, 3] for more information about this general framework, but we do not assume any prior knowledge of this subject in this paper. For those familiar with exclusion processes, though, we remark that this current paper appears to be the first time that such a process having ‘‘correlated clocks’’ have been considered.

A word W is said to be *irreducible* if it cannot be expressed as $W = UU \cdots U$ for some other word U . Formally, W is irreducible if there is *no* word $U \neq W$ with $\text{len } U \mid \text{len } W$ for which $W = U^{(\text{len } W)}$. When discussing periodic words, we may always suppose that the base-word is irreducible since if $W = UU \cdots U$, then $W^{(n)} = U^{(n)}$ for every n .

Bukh and Cox established the following connection between longest common subsequences and the frog dynamics.

Theorem 3 (Bukh–Cox [4]). *Let Σ be a alphabet and fix an irreducible word $W \in \Sigma^\ell$.*

1. *The (W, Σ) frog dynamics admits a unique stationary distribution π .*
2. *The average speed of \mathfrak{F}_m , defined by*

$$s_m \stackrel{\text{def}}{=} \lim_{n \rightarrow \infty} \mathbb{E}_{R \sim \Sigma^n} \frac{D_m(F_0, R)}{n},$$

exists and is independent of the initial frog arrangement F_0 . Furthermore,

$$s_m = \mathbb{E}_{a \sim \Sigma} \mathbb{E}_{F \sim \pi} D_m(F, a) \quad \text{for each } m \in [\ell].$$

3. For every fixed $\rho \geq 0$,

$$\mathbb{E}_{R \sim \Sigma^n} \text{LCS}(R, W^{(\rho n)}) = \left(\rho - \frac{1}{\ell} \sum_{s_m \leq \rho} (\rho - s_m) \right) n - \tau \sqrt{n} + O(1)$$

where $\tau = \tau(W, \Sigma, \rho) \geq 0$ always and $\tau > 0$ if and only if $\rho \in \{s_1, \dots, s_\ell\}$.

Therefore, in order to determine the Chvátal–Sankoff constant for the base-word W , one needs only to compute the speeds $s_1, \dots, s_{\text{len } W}$.

Bukh and Cox established [Theorem 1](#) by showing that $s_m = \frac{k(k+1)}{|\Sigma|(k+2-m)(k+1-m)}$ when $W = 12 \cdots k$ and $\Sigma \supseteq [k]$. We will likewise establish [Theorem 2](#) by showing that

$$s_m = \frac{2k \cdot \sum_{j \geq 0} \binom{2k-2j}{m-1-2j}}{|\Sigma| \cdot \sum_{j \geq 0} \binom{2k-2j}{m-2j}} - \frac{2k \cdot \sum_{j \geq 0} \binom{2k-2j}{m-2-2j}}{|\Sigma| \cdot \sum_{j \geq 0} \binom{2k-2j}{m-1-2j}},$$

when $W = 12 \cdots k k \cdots 21$ and $\Sigma \supseteq [k]$. This is the content of [Theorem 32](#).

2.1 The blind-frog process and dynamics

Fix a word $W \in \Sigma^\ell$ and an integer $m \in [\ell]$ and consider the frog dynamics associated with W . One key idea which greatly simplifies the computations involved in analyzing the frog dynamics is a coupling with a collection of simpler chains, which we call the *m-blind-frog dynamics*. In the *m-blind-frog dynamics*, we focus only on $\mathfrak{F}_{\leq m} \stackrel{\text{def}}{=} \{\mathfrak{F}_1, \dots, \mathfrak{F}_m\}$, suppressing the distinction between \mathfrak{F}_1 through \mathfrak{F}_m . As we are not interested in the position of any individual frog, we record the state of the system as a set $S \in \binom{\{\mathfrak{F}_0, \dots, \mathfrak{F}_{\ell-1}\}}{m}$. We call such a set S an *m-blind-frog arrangement*, and we continue to refer to the elements of S as ‘frogs’, despite not knowing their relative nastiness.

Given an *m-blind-frog arrangement* $S \in \binom{\{\mathfrak{F}_0, \dots, \mathfrak{F}_{\ell-1}\}}{m}$, the *m-blind-frog process* evolves as follows:

1. The monster which lives in the pond selects some letter $a \in \Sigma$ and pokes all lily pads labeled a . This agitates any frog residing on a lily pad labeled a and makes it want to jump away.
2. With no restrictions on priority, an agitated frog will hop to the lily pad immediately succeeding it in the clockwise order and calm down. If this lily pad was previously occupied, then the previous occupant becomes agitated.

This repeats until all m frogs are content once more.

For an *m-blind-frog arrangement* S and $a \in \Sigma$, let Sa be the *m-blind-frog arrangement* that results from starting with S , poking all lily pads labeled a and waiting for the ensuing frenzy to settle. Additionally, define $H(S, a)$ to be the total number of frogs that hopped in the transition from S to Sa .

Proposition 4. *For any word $W \in \Sigma^\ell$ and any $m \in [\ell]$, the *m-blind-frog process* is well-defined. That is, for each $S \in \binom{\{\mathfrak{F}_0, \dots, \mathfrak{F}_{\ell-1}\}}{m}$ and each $a \in \Sigma$, the order in which the agitated frogs hop once the lily pads labeled a are poked does not influence Sa nor $H(S, a)$.*

Proof. Let $H \subseteq S$ be the union of all cyclic intervals contained in S starting at a lily pad labeled a . Formally, $\mathfrak{F}_x \in H$ if and only if there is some $y \in \mathbb{Z}/\ell\mathbb{Z}$ (possibly $y = x$) for which $W_y = a$ and $\mathfrak{F}_y, \mathfrak{F}_{y+1}, \dots, \mathfrak{F}_x \in S$. The effect of poking all lily pads labeled a and waiting for the blind frogs to settle is precisely that every frog on a lily pad in H hops exactly one lily pad forward,

regardless of the order in which they hop. Indeed, every frog on a lily pad in H will eventually become agitated, and no other frogs can become agitated since, by definition, there exists an empty lily pad between any element of H and any element of $S \setminus H$ in the cyclic order. This observation implies that $Sa = (S \setminus H) \cup \{\mathfrak{Q}_{x+1} : \mathfrak{Q}_x \in H\}$ and $H(S, a) = |H|$. \square

Since the order in which the blind frogs hop is irrelevant, the blind-frog process aligns with the frog process. We remark that this type of observation is nothing new and some version of it is likely well-known to anyone who studies related interacting particle systems: [3, Lemma 16] gives an overview of the standard arguments. See also [1, Appendix A] for a more-involved version of this “color merging” idea.

Proposition 5. *If $W \in \Sigma^\ell$, then for any frog arrangement $F: \{\mathfrak{F}_1, \dots, \mathfrak{F}_\ell\} \rightarrow \{\mathfrak{Q}_0, \dots, \mathfrak{Q}_{\ell-1}\}$, $m \in [\ell]$ and $a \in \Sigma$, we have*

$$(Fa)(\mathfrak{F}_{\leq m}) = (F(\mathfrak{F}_{\leq m}))a, \quad \text{and}$$

$$\sum_{i=1}^m D_i(F, a) = H(F(\mathfrak{F}_{\leq m}), a).$$

Proof. We first observe that the movement of $\mathfrak{F}_1, \dots, \mathfrak{F}_m$ is unaffected by the floundering of the less nasty frogs $\mathfrak{F}_{m+1}, \dots, \mathfrak{F}_k$. Indeed, for any $i < j$, \mathfrak{F}_j can never agitate \mathfrak{F}_i and when \mathfrak{F}_i looks to hop, it never considers the presence of \mathfrak{F}_j . Therefore, since we seek to track only the nastiest m frogs, we may pretend as if $\mathfrak{F}_{m+1}, \dots, \mathfrak{F}_k$ do not exist.

Now, consider a slight modification to the frog process where, when \mathfrak{F}_i is agitated, instead of \mathfrak{F}_i hopping over any nastier frog, it instead hops onto the very next lily pad. If that lily pad is empty, \mathfrak{F}_i stops; otherwise there is another frog \mathfrak{F}_j occupying that lily pad. If $i > j$, then \mathfrak{F}_i settles down and \mathfrak{F}_j becomes agitated. Otherwise, \mathfrak{F}_i remains agitated and will continue to hop.

This alternative viewpoint is readily seen to be equivalent to the original frog dynamics: we are simply considering a long leap to be comprised of smaller hops. Furthermore, with this alternative viewpoint, whenever a frog lands on an occupied lily pad, one of these two frogs hops away on the next step. Suppressing the distinction between $\mathfrak{F}_1, \dots, \mathfrak{F}_m$ does not change this fact and so, since the order in which the blind frogs hop is irrelevant in the blind-frog process (Proposition 4), the conclusion follows. \square

Starting with an m -blind-frog arrangement F_0 , set $F_n = F_0 r_1 r_2 \dots r_n$ where the letters r_1, r_2, \dots are chosen independently and uniformly from Σ . Then the sequence F_0, F_1, F_2, \dots forms a Markov chain, which we call the (W, Σ) m -blind-frog dynamics.

Since the frog process aligns with the m -blind-frog process, we can couple the (W, Σ) frog dynamics with the (W, Σ) m -blind-frog dynamics by simply poking the same letter in each chain at each time step.

Corollary 6. *Fix an alphabet Σ and an irreducible word $W \in \Sigma^\ell$. If π denotes the stationary distribution of the (W, Σ) frog dynamics and π_m denotes the stationary distribution of the (W, Σ) m -blind-frog dynamics, then*

1. $F \sim \pi \implies F(\mathfrak{F}_{\leq m}) \sim \pi_m$, and

2. $\sum_{i=1}^m s_i = \mathbb{E}_{a \sim \Sigma} \mathbb{E}_{F \sim \pi_m} H(F, a).$

In the above statement, note that since π exists and is unique (Theorem 3), the same is true of π_m .

In the special case where $W = 12 \cdots k$ and $\Sigma \supseteq [k]$, Bukh and Cox found that the stationary distribution of the m -blind-frog dynamics is uniform [4, Theorem 30]. This fact allowed them to compute $\sum_{i=1}^m s_i$ for each $m \in [k]$ without much additional effort. Alas, the stationary distribution of the m -blind-frog dynamics for $W = 12 \cdots kk \cdots 21$ is not anywhere as easy to describe, let alone prove.

2.2 The blind-frogs associated with $W = 12 \cdots kk \cdots 21$

When working with the word $W = 12 \cdots kk \cdots 21$, it is convenient to represent the ring of lily pads instead as the grid $[2] \times [k]$ (see Figure 2).

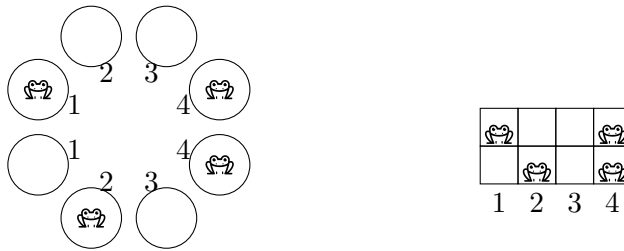

Figure 2: Representing the ring of lily pads (left) by a grid (right).

When considering frogs arranged on $[2] \times [k]$, the frogs in the top row (squares indexed by $(1, i)$) move to the right and frogs in the bottom row (squares indexed by $(2, i)$) move to the left, wrapping around at the sides. In this way, the letter $c \in [k]$ corresponds directly to column c in the grid. Thus, instead of poking individual lily pads, we think about poking an entire column in this grid.

We denote the set of all arrangements of m (blind) frogs on the grid $[2] \times [k]$ by $\mathcal{F}_{k,m}$; formally $\mathcal{F}_{k,m} \stackrel{\text{def}}{=} \binom{[2] \times [k]}{m}$.

The most important observation about this grid arrangement is its symmetry. Consider the map $\text{ROTATE}: [2] \times [k] \rightarrow [2] \times [k]$ defined by $\text{ROTATE}(i, j) = \text{ROTATE}(3 - i, k + 1 - j)$, thereby rotating the grid by 180° . The map ROTATE can naturally be applied to each $F \in \mathcal{F}_{k,m}$ by simply applying ROTATE pointwise to F .

Observation 7. Fix a letter $c \in [k]$ and set $c' = k + 1 - c$. Then for any $F \in \mathcal{F}_{k,m}$, we have $\text{ROTATE}(F) \in \mathcal{F}_{k,m}$ and $\text{ROTATE}(Fc) = \text{ROTATE}(F)c'$.

3 Frogs...with hats!

From here on, whenever we refer to a ‘frog’, that frog is blind in the sense that we do not care about relative nastiness. Recall from Section 2.2 that we consider these frogs to live on the grid $[2] \times [k]$ instead of on a ring of lily pads. In order to analyze the m -blind-frog dynamics associated with the word $W = 12 \cdots kk \cdots 21$, we need to introduce a new combinatorial object: frogs with hats!

Before introducing the frogs with hats, we start with a motivating example. Consider the blind-frog arrangement F shown in Figure 3a. Using π_m to denote the stationary distribution of

the m -blind-frog dynamics, it turns out that $\pi_2(F) = 0$... why? In [4, Theorem 20], Bukh and Cox argue that any given m -blind-frog arrangement is in the support of π_m if and only if that arrangement can be reached via a sequence of pokes starting from an arrangement where the m froggies form an interval. We encourage the reader to check that the arrangement in Figure 3a is indeed unreachable in this sense. The arrangement shown in Figure 3b has $\pi_4(F) = 0$ for the same reason, but this is more tedious to verify. However, the arrangements shown in Figures 3c and 3d both have $\pi_5(F) \neq 0$ and so they must be reachable, even though it may be unclear what sequence of pokes accomplishes this feat. Despite both being reachable, why is it that the arrangement in Figure 3d is three times more likely to appear than the arrangement in Figure 3c?



Figure 3: Some blind-frog arrangements and their stationary values.

All of these questions, and more, will be answered by placing hats on the froggies' heads!

Definition 8 (Hatted-frog arrangement). An m -hatted-frog arrangement on the grid $[2] \times [k]$ is a pair of sets (F, H) where $F \in \binom{[2] \times [k]}{m}$ and $H \subseteq F$ with the following properties:

- (1) If $(i, c) \in F$ for some $(i, c) \in [2] \times [k]$, then *exactly one* of $(1, c), (2, c)$ is an element of H , and
- (2) If $(2, c) \in H$, then $(1, c + 1) \notin H$.

We denote the set of all m -hatted-frog arrangements on $[2] \times [k]$ by $\mathcal{F}_{k,m}^{\hat{}}$.

To explain the terminology and notation, we imagine that the set $F \in \binom{[2] \times [k]}{m} = \mathcal{F}_{k,m}$ is the set of positions on the grid occupied by a frog and that $H \subseteq F$ is the set of frogs wearing a hat. To that end, we refer to each element of F as a ‘frog’ and to each element of H as a ‘hatted frog’. We will often use $\hat{\text{frog}}$ to denote an element of H and frog to denote an element of $F \setminus H$. The whole of $\mathcal{F}_{2,2}^{\hat{}}$ and $\mathcal{F}_{2,3}^{\hat{}}$ can be seen in Figure 5.

Informally, an m -hatted-frog arrangement is created by placing m frogs (some with hats, some without) in the grid $[2] \times [k]$ so that the following pictures are never seen:

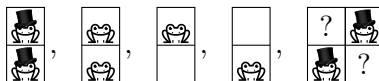

where a “?” represents a frog that may or may not be present. In our pictures, the top row corresponds to coordinates of the form $(1, i)$ and the bottom row corresponds to coordinates of the form $(2, i)$.

Recalling the rotation map ROTATE from Section 2.2, we can naturally apply ROTATE to each $(F, H) \in \mathcal{F}_{k,m}^{\hat{}}$ by applying ROTATE pointwise to both F and H . It is quick to observe that $\mathcal{F}_{k,m}^{\hat{}}$ is invariant under ROTATE.

At this point, the stationary values in Figure 3 begin to make sense. There are no valid ways to place hats on the frogs in Figures 3a and 3b, whereas there is a single way to place hats on the frogs in Figure 3c and three ways to place hats on the frogs in Figure 3d (it turns out that $|\mathcal{F}_{4,5}^{\hat{}}| = 80$).

There is an obvious projection $\text{DOFF}: \mathcal{F}_{k,m}^{\blacksquare} \rightarrow \mathcal{F}_{k,m}$ which simply removes the hats from all frogs; that is $\text{DOFF}(F, H) = F$. In order to explain the numbers in Figure 3, our goal is to create a Markov chain on $\mathcal{F}_{k,m}^{\blacksquare}$ such that DOFF realizes a coupling to the m -blind-frog dynamics. If all goes well, this Markov chain will wind up having a uniform stationary distribution.

3.1 The hatted-frog process and dynamics

In this section, we build a Markov chain on $\mathcal{F}_{k,m}^{\blacksquare}$ which projects to the m -blind-frog dynamics for $W = 12 \cdots kk \cdots 21$. Given a hatted-frog arrangement $F^{\blacksquare} \in \mathcal{F}_{k,m}^{\blacksquare}$, the m -hatted-frog process evolves as follows:

1. The monster which lives in the pond selects some letter $a \in \Sigma$. If $a \notin [k]$, then nothing happens; otherwise, the monster pokes column a . This agitates the frogs in column a and makes them want to jump away.
2. An agitated frog will hop to the very next square in the clockwise order. If there were initially two agitated frogs, then the one which was *not* originally wearing a hat hops first.
3. When an agitated frog lands on a new square, it calms down and immediately puts on a hat, potentially stealing this hat from the current occupant or from the occupant of the other square in this column, should either occupant exist. If the square was previously occupied, then that frog becomes agitated and will hop *immediately* on the next step. In particular, this newly agitated frog hops before any previously agitated frogs.

This repeats until all frogs are content once more.

For an m -hatted-frog arrangement $F^{\blacksquare} \in \mathcal{F}_{k,m}^{\blacksquare}$ and a letter $a \in \Sigma$, let $F^{\blacksquare}a$ be the hatted-frog arrangement that results from starting with F^{\blacksquare} , poking column a (if $a \in [k]$) and waiting for the ensuing frenzy to settle. Additionally, define $H(F^{\blacksquare}, a)$ to be the number of frogs which hopped in the transition from F^{\blacksquare} to $F^{\blacksquare}a$. Note that if $a \notin [k]$ or F^{\blacksquare} has no frogs in column a , then $H(F^{\blacksquare}, a) = 0$.

Examples of the hatted-frog process can be seen in Figure 4.

In the hatted-frog process, if two frogs are initially agitated, then the one that was originally wearing a hat waits until it is the only agitated frog before it hops. The astute reader may realize that this requirement is somewhat arbitrary. Indeed, this choice makes a difference only when there are exactly $2k$ frogs (in which case it is easy to verify that $H(F, a) = 2k$ for all $a \in [k]$). Nevertheless, enforcing this hopping order will aid our analysis of the hatted-frog process.

Recalling the rotation map ROTATE from Section 2.2, it is clear that:

Observation 9. Fix a letter $c \in [k]$ and set $c' = k + 1 - c$. Then for any $F^{\blacksquare} \in \mathcal{F}_{k,m}^{\blacksquare}$, we have $\text{ROTATE}(F^{\blacksquare}) \in \mathcal{F}_{k,m}^{\blacksquare}$ and $\text{ROTATE}(F^{\blacksquare}c) = \text{ROTATE}(F^{\blacksquare})c'$.

We next show that the hatted-frog process extends the blind-frog process. Recall that DOFF is the projection which simply removes the frogs' hats.

Theorem 10. For any letter $a \in \Sigma$ and any hatted-frog arrangement $F^{\blacksquare} \in \mathcal{F}_{k,m}^{\blacksquare}$,

$$\begin{aligned} \text{DOFF}(F^{\blacksquare}a) &= \text{DOFF}(F^{\blacksquare})a, & \text{and} \\ H(F^{\blacksquare}, a) &= H(\text{DOFF}(F^{\blacksquare}), a). \end{aligned}$$

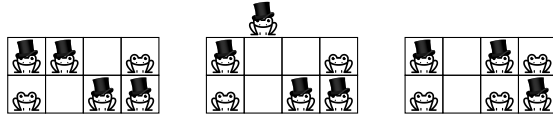

(a) The monster pokes column 2! The left-most image is F^1 , the right-most image is F^2 and $H(F^1, 2) = 1$.

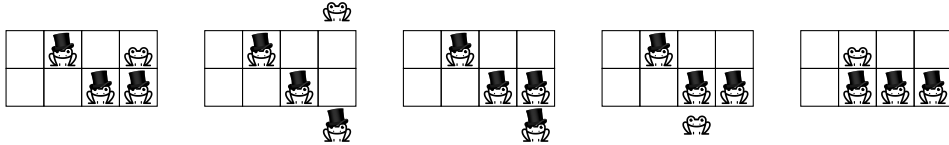

(b) The monster pokes column 4! The left-most image is F^1 , the right-most image is F^4 and $H(F^1, 4) = 3$.

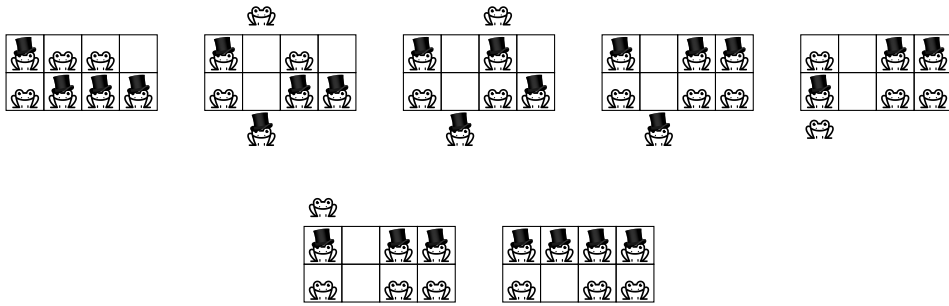

(c) The monster pokes column 2! The top-left image is F^1 , the bottom-right image is F^2 and $H(F^1, 2) = 5$.

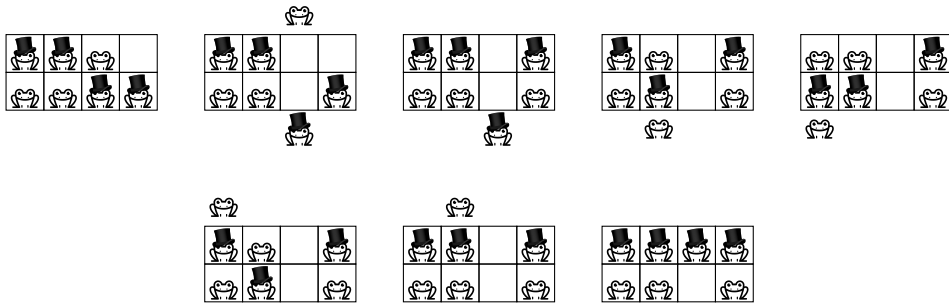

(d) The monster pokes column 3! The top-left image is F^1 , the bottom-right is F^3 and $H(F^1, 3) = 6$.

Figure 4: Examples of the [hatted-frog process](#). An agitated frog is drawn just above/below the square that it occupies. We emphasize the hatted poked frog by continuing to draw a hat on its head until it first hops.

In order to prove this, we introduce a pair of definitions and a lemma which will be used throughout the next section as well.

Definition 11. Fix a square $\square \in [2] \times [k]$.

- The column containing \square is denoted by $\text{Col}(\square)$; that is to say, $\text{Col}(r, c) \stackrel{\text{def}}{=} [2] \times \{c\}$.
- The square opposite to \square is denoted by $\text{opp}(\square)$; that is to say, $\text{opp}(r, c) \stackrel{\text{def}}{=} (3 - r, c)$.
- \square^+ denotes the square directly succeeding \square in the clockwise order and \square^- denotes the square directly preceding \square in the clockwise order. For example, $(1, 1)^+ = (1, 2)$ and $(1, 1)^- = (2, 1)$ and $(2, k)^+ = (2, k - 1)$ and $(2, k)^- = (1, k)$.

Note that Col and opp both commute with ROTATE and that $\text{ROTATE}(\square^\pm) = \text{ROTATE}(\square)^\pm$.

Recall that we use $\Omega + x$ as shorthand for $\Omega \cup \{x\}$ and use $\Omega - x$ as shorthand for $\Omega \setminus \{x\}$.

Lemma 12. *Suppose that (F, H) is a hatted-frog arrangement on $[2] \times [k]$ and fix any $\square \in [2] \times [k]$. If either $\square^- \in H$ or $F \cap \text{Col}(\square^-) = \emptyset$, then $(F + \square, H - \text{opp}(\square) + \square)$ is also a hatted-frog arrangement.*

Proof. Using rotational symmetry, we may suppose that $\square = (1, c)$ for some $c \in [k]$. It is quick to observe that the only way for $(F + \square, H - \text{opp}(\square) + \square)$ to fail to be a hatted-frog arrangement is if $c \geq 2$ and $(2, c - 1) \in H - \text{opp}(\square) + \square$. However, by assumption, either $\square^- = (1, c - 1) \in H$ or H is disjoint from $\text{Col}(\square^-) = [2] \times \{c - 1\}$. In either case $(2, c - 1) \notin H - \text{opp}(\square) + \square$. \square

Proof of Theorem 10. Observe that the only heed given to the presence of the hats in the hatted-frog process is to determine which of the agitated frogs has priority in moving. However, in the blind-frog process, the order in which the froggies hop is irrelevant. Therefore, we will have established the theorem provided that we show that $\blacksquare a \in \mathcal{F}_{k,m}$ for each $\blacksquare \in \mathcal{F}_{k,m}$ and each $a \in \Sigma$, i.e. we need only show that the hatted-frog process really is a process on $\mathcal{F}_{k,m}$. Of course, if $a \notin [k]$, then $\blacksquare a = \blacksquare$, so we may suppose that $a \in [k]$.

Set $h = H(\blacksquare, a)$. Fix $i \in [h]$ and consider the state of the hatted frogs after i hops in the transition from \blacksquare to $\blacksquare a$ have taken place. We can encode this state in a triple (F_i, H_i, A_i) where $A_i \in \binom{[2] \times [k]}{\leq 2}$ is the set of currently agitated frogs, $F_i \in \binom{[2] \times [k]}{\leq m}$ is the set of un-agitated frogs and $H_i \subseteq F_i$ is the set of those un-agitated frogs wearing a hat. Note that $|F_i| + |A_i| = m$ and that F_i and A_i may intersect. We additionally define (F_0, H_0, A_0) to be the state immediately after column a is poked but before any frogs have hopped. In particular, if $\blacksquare = (F, H)$, then $A_0 = F \cap ([2] \times \{a\})$, $F_0 = F \setminus A_0$ and $H_0 = H \setminus A_0$. Certainly, (F_0, H_0) is a hatted-frog arrangement.

By definition, $A_h = \emptyset$ and $\blacksquare a = (F_h, H_h)$. Therefore, the goal is to show that (F_h, H_h) is indeed a hatted-frog arrangement.

Suppose that $\heartsuit \in [2] \times [k]$ is the i th frog to hop. Then $\heartsuit \in A_{i-1}$ and

- $F_i = F_{i-1} + \heartsuit^+$, and
- $H_i = H_{i-1} - \text{opp}(\heartsuit^+) + \heartsuit^+$, and
- If $\heartsuit^+ \notin F$, then $A_i = A_{i-1} - \heartsuit$, and
- If $\heartsuit^+ \in F$, then $A_i = A_{i-1} - \heartsuit + \heartsuit^+$.

Using this information, it is not difficult to see that for each $i \in [0, h]$ and each $\mathfrak{E} \in A_i$, either $\mathfrak{E} \in H_i$ or $F_i \cap \text{Col}(\mathfrak{E}) = \emptyset$. Therefore, a routine induction using [Lemma 12](#) shows that (F_i, H_i) is indeed a hatted-frog arrangement for each $i \in [0, h]$, which concludes the proof. \square

Naturally, we can build a Markov chain from the hatted-frog process just as we have done from the frog and blind-frog processes. Indeed, fix integers k, m with $0 \leq m \leq 2k$ and an alphabet Σ . Starting with a hatted-frog arrangement $F_0 \in \mathcal{F}_{k,m}$ set $F_n = F_0 r_1 r_2 \cdots r_n$ where the letters r_1, r_2, \dots are chosen independently and uniformly from Σ . Then the sequence F_0, F_1, F_2, \dots is a Markov chain, which we call the (k, Σ) m -hatted-frog dynamics.

[Theorem 10](#) tells us that we can couple the $(12 \cdots kk \cdots 21, \Sigma)$ m -blind-frog dynamics and the (k, Σ) m -hatted-frog dynamics by simply poking the same letter in each chain at each time step.

Corollary 13. *Fix $W = 12 \cdots kk \cdots 21$, some alphabet $\Sigma \supseteq [k]$ and an integer $0 \leq m \leq 2k$. If π denotes the stationary distribution of the (W, Σ) m -blind-frog dynamics and π is any stationary distribution of the (k, Σ) m -hatted-frog dynamics, then*

1. $F \sim \pi \implies \text{DOFF}(F) \sim \pi$, and
2. $\mathbb{E}_{F \sim \pi} H(F, a) = \mathbb{E}_{F \sim \pi} H(F, a)$ for each $a \in \Sigma$.

With this coupling in hand, the next step is to locate a stationary distribution of the hatted-frog dynamics.

Theorem 14. *If $\Sigma \supseteq [k]$, then the (k, Σ) m -hatted-frog dynamics admits a uniform stationary distribution.*

Note that we prove only that the uniform distribution is a stationary distribution, not that it is unique.¹ Of course, [Corollary 13](#) and [Theorem 14](#) together imply that the stationary distribution of the $(12 \cdots kk \cdots 21, \Sigma)$ m -blind-frog dynamics where $\Sigma \supseteq [k]$, is given by

$$\pi(F) = \frac{|\text{DOFF}^{-1}(F)|}{|\mathcal{F}_{k,m}|}.$$

The whole of [Section 3.2](#) is dedicated to the proof of [Theorem 14](#).

3.2 The hatted-frog dynamics admits a uniform stationary distribution

To prove [Theorem 14](#), it suffices to show that the state-graph of the m -hatted-frog process is regular.

Let G be the directed graph whose vertex set is $\mathcal{F}_{k,m}$ where $E \rightarrow F$ in G if there is some $a \in \Sigma$ for which $F = Ea$. An example of such a graph is shown in [Figure 5](#). Note that G may have multi-edges (if $F = Ea = Eb$ for some $a \neq b \in \Sigma$) and loops (if $F = Fa$ for some $a \in \Sigma$).² With these considerations, $\deg^+(F) = |\Sigma|$ for each $F \in \mathcal{F}_{k,m}$. By definition, the m -hatted-frog dynamics is precisely a random walk on G where each edge is traversed with equal probability.

¹It should be possible to prove that the stationary distribution is indeed unique, but it is not necessary for our arguments.

²It turns out that multi-edges (except for multi-loops) are not possible and that loops occur only when an empty column is poked. In fact, these observations hold (with one exception) for any instance of the blind-frog dynamics. However, our arguments do not benefit from such knowledge and so we do not spend the time to prove this. The interested reader may find it enlightening to prove such a fact, though.

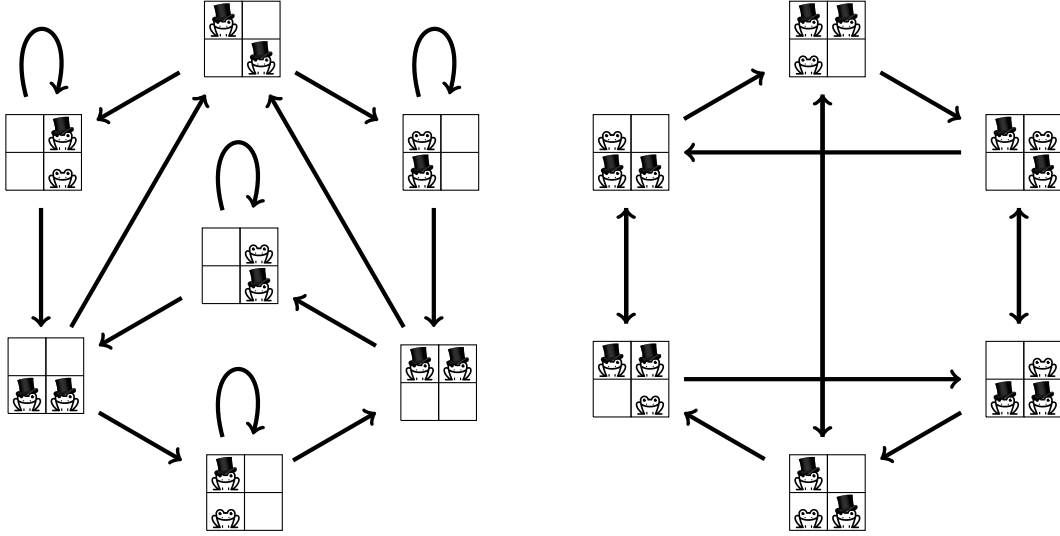

Figure 5: Two examples of the state-graph of the hatted-frog dynamics on the 2×2 grid using the alphabet $\Sigma = [2]$. Observe that each graph is 2-regular.

Theorem 15. *If $\Sigma \supseteq [k]$, then $\deg^+(\mathbf{F}) = \deg^-(\mathbf{F}) = |\Sigma|$ for every $\mathbf{F} \in \mathcal{F}_{k,m}$.*

We already know that $\deg^+(\mathbf{F}) = |\Sigma|$ from the earlier observation and so our efforts will be focused on proving that $\deg^-(\mathbf{F}) = |\Sigma|$.

Note that if the state graph is regular, then the uniform distribution is a stationary distribution. This standard fact follows immediately from the stationary equation. Therefore, [Theorem 15](#) implies [Theorem 14](#).

Establishing [Theorem 15](#) will comprise the remainder of this section and will require a careful analysis of the intermediate steps within each transition in the hatted-frog process.

Before diving into the details, we outline the motivating idea. Consider a hatted-frog arrangement $\mathbf{F} = (F, H) \in \mathcal{F}_{k,m}$. Observe that the number of non-empty columns in \mathbf{F} is precisely $|H|$. Therefore, for a letter $a \in \Sigma$, if either $a \notin [k]$ or there are no frogs in column a , then $\mathbf{F}a = \mathbf{F}$. This accounts for $|\Sigma| - |H|$ many in-edges to \mathbf{F} . As such, we need to locate exactly $|H|$ many additional in-edges; each of these in-edges will have the property that some frogs hopped in the transition. With this set-up, it is natural to try to find a bijection between H and pairs $(\mathbf{E}, a) \in \mathcal{F}_{k,m} \times [k]$ for which $\mathbf{E}a = \mathbf{F}$ and \mathbf{E} contains some frog in column a . Of course, since \mathbf{E} has some frog in column a , it has a hatted-frog in column a . Our goal is to track this special hatted-frog as it hops along in such a way that the ending-position of the special hatted-frog in \mathbf{F} uniquely identifies the pair (\mathbf{E}, a) .

3.2.1 Preliminaries

In this section, we lay out a number of definitions and results that will be crucial to establishing that the hatted-frog dynamics admits a uniform stationary distribution.

To begin, recall that if (F, H) is a hatted-frog arrangement, then H cannot contain both $(2, c)$

and $(1, c + 1)$ for any c . We note the following rephrasing of this property which will streamline some arguments.

Observation 16. *If $(F, H) \in \mathcal{F}_{k,m}$ and $\hat{f} \in H$, then either $\text{opp}(\hat{f})^+ = \hat{f}$ or $\text{opp}(\hat{f})^+ \notin H$.*

Note that $\text{opp}(\square)^+ = \square$ if and only if $\square \in \{(1, 1), (2, k)\}$.

In the next few definitions, we develop a larger vocabulary which will be used to discuss the movement of the frogs.

Definition 17 (Clockwise path). A sequence of squares $(\square_1, \dots, \square_\ell)$ coming from $[2] \times [k]$ is called a *clockwise path* if $\ell \leq 2k$ and $\square_{i+1} = \square_i^+$ for each $i \in [\ell - 1]$. For squares $\square_1, \square_2 \in [2] \times [k]$, the (unique) clockwise path starting at \square_1 and ending at \square_2 is denoted by $I[\square_1, \square_2]$. We abbreviate $I[\square_1, \square_2] \stackrel{\text{def}}{=} I[\square_1^+, \square_2]$.

Naturally, we can extend the rotation map **ROTATE** to act on clockwise paths by applying it to each coordinate of the sequence. In this way, $\text{ROTATE}(I[\square_1, \square_2]) = I[\text{ROTATE}(\square_1), \text{ROTATE}(\square_2)]$.

While $I[\square_1, \square_2]$ and $I(\square_1, \square_2)$ are technically sequences, we will usually treat them as sets of their elements for the sake of brevity. Note that neither of these sets are ever empty. It is also important to notice that, as sets, $I(\square_1, \square_2) \neq I(\square_1, \square_2) - \square_1$ if $\square_1 = \square_2$.

Now, imagine walking along a clockwise path, each of whose squares contain a frog. When you encounter a new frog, you must place a hat upon its head; however, you must additionally ensure that the result is still a hatted-frog arrangement. Therefore, when you visit a new frog and the opposite square is occupied by a hatted frog, you must steal the hat from that other frog so that your new froggie acquaintance can don a hat. This idea is formalized in the following definition.

Definition 18 (Alignment). A hatted-frog arrangement $(F, H) \in \mathcal{F}_{k,m}$ is said to *align* with a clockwise path $(\square_1, \dots, \square_\ell)$ in $[2] \times [k]$ if

- $\square_i \in F$ for all $i \in [\ell]$, and
- $\square_i \in H$ if and only if $\text{Col}(\square_i) \cap \{\square_{i+1}, \dots, \square_\ell\} = \emptyset$.

See [Figure 6](#) for examples of alignment. Observe that if \hat{F} aligns with $(\square_1, \dots, \square_\ell)$, then \hat{F} aligns also with $(\square_i, \dots, \square_\ell)$ for every $i \in [\ell]$.

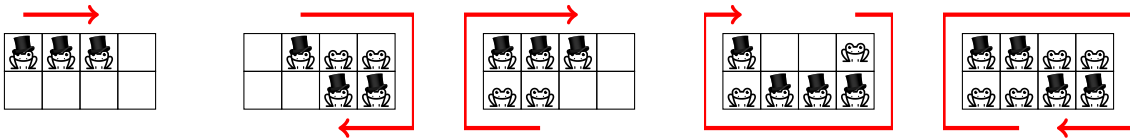

Figure 6: Examples of [alignment](#). The arrow indicates a clockwise path aligning with the arrangement, though this is not the unique clockwise path with this property. In each example, we draw only the frogs within the clockwise path, though there could be other frogs in the arrangement.

Definition 19 (Missing squares). For a subset $F \subseteq [2] \times [k]$ and a square $\square \in [2] \times [k]$, write $e_F^-(\square)$ to denote the first square preceding \square in the clockwise order which is *not* a member of F . If either $\square \notin F$ or $F = [2] \times [k]$, then we define $e_F^-(\square) = \square$.

Observe that if $e_F^-(\square) \neq \square$, then $e_F^-(\square) \notin F$ while $I(e_F^-(\square), \square] \subseteq F$. Additionally, notice that $\text{ROTATE}(e_F^-(\square)) = e_{\text{ROTATE}(F)}^-(\text{ROTATE}(\square))$.

The following lemma essentially states that alignment is maintained throughout the intermediate steps in the hatted-frog process. This can be seen as an extension of [Lemma 12](#).

Lemma 20. *Fix a hatted-frog arrangement $(F, H) \in \mathcal{F}_{k,m}^{\hat{\square}}$ and a square $\square \in [2] \times [k]$. Suppose that either*

- $F \cap \text{Col}(\square^-) = \emptyset$, or
- (F, H) aligns with $I(e_F^-(\square^-), \square^-]$.

Then $(F + \square, H - \text{opp}(\square) + \square)$ is a hatted-frog arrangement which aligns with $I(e_{F+\square}^-(\square), \square]$.

Proof. Set $(F', H') = (F + \square, H - \text{opp}(\square) + \square)$.

Note that if (F, H) aligns with $I(e_F^-(\square^-), \square^-]$, then $\square^- \in H$. Therefore, either $\square^- \in H$ or $F \cap \text{Col}(\square^-) = \emptyset$, and so [Lemma 12](#) tells us that (F', H') is also a hatted-frog arrangement.

Next, if $F \cap \text{Col}(\square^-) = \emptyset$, then $e_{F'}^-(\square) = \square^-$ and so $I(e_{F'}^-(\square), \square] = (\square)$ clearly aligns with (F', H') since $\square \in H'$.

Finally, suppose that (F, H) aligns with $I(e_F^-(\square^-), \square^-]$. Write $I(e_F^-(\square^-), \square^-] = (\square_1, \dots, \square_\ell)$, so $\square_1 = e_F^-(\square^-)^+$ and $\square_\ell = \square^-$.

Suppose first that $F + \square \neq [2] \times [k]$ or $\square \notin F$. It is not too difficult to see that $e_{F+\square}^-(\square) = e_F^-(\square^-)$ in this situation. Therefore, we have $I(e_{F+\square}^-(\square), \square] = (\square_1, \dots, \square_\ell, \square)$, which aligns with (F', H') since $\square \in H'$ and (F', H') and (F, H) agree everywhere beyond $\text{Col}(\square)$.

Otherwise, we must have $F = [2] \times [k]$ and so $F + \square = F$. Thus, $e_F^-(\square^-) = \square^-$ and $e_{F+\square}^-(\square) = \square$. Therefore, $I(e_{F+\square}^-(\square), \square] = (\square_2, \dots, \square_\ell, \square_1 = \square)$. This path aligns with (F', H') for the same reason as in the previous paragraph. \square

3.2.2 Crowned-frog arrangements

Recalling the proof of [Theorem 10](#), we can identify an intermediate step in the hatted-frog process with a triple (F, H, A) where $F \subseteq [2] \times [k]$ represents the positions of the un-agitated frogs, $H \subseteq F$ represents the positions of the un-agitated hatted frogs and $A \subseteq [2] \times [k]$ represents the positions of the agitated frogs. Unfortunately, tracking the evolution of the triple (F, H, A) will not be quite enough for our purposes. As discussed at the beginning of [Section 3.2](#), we also keep track of a special hatted-frog, which we call the *crowned frog* and denote by $\hat{\square}$; after all, a crown is quite a special hat!

The following definition is technical; the reader may find it helpful to peek ahead to [Figure 7](#) to see examples, even though much of that figure will not yet make sense.

Definition 21 (Crowned-frog arrangement). Fix positive integers k, m . The set of *m-crowned-frog arrangements* on $[2] \times [k]$ consists of all quintuples of the form $(F, H, A, \hat{\square}, x)$ where $F, H, A \subseteq [2] \times [k]$, and $\hat{\square} \in [2] \times [k]$, and $x \in \{\text{agitated}, \text{settled}\}$, satisfying the following properties:

- (1) (F, H) is a hatted-frog arrangement.
- (2) $|A| \leq 2$ and $|F| + |A| = m$.
- (3) $\hat{\square} \in H \cup A$, where

$$x = \text{agitated} \implies \hat{\square} \in A, \quad \text{and} \quad x = \text{settled} \implies \hat{\square} \in H.$$

- (4) For each $\mathfrak{F} \in A$, either $F \cap \text{Col}(\mathfrak{F}) = \emptyset$ or (F, H) aligns with $I(e_F^-(\mathfrak{F}), \mathfrak{F})$.
- (5) If $A = \{\mathfrak{F}\}$ and $x = \text{settled}$, then $\mathfrak{F}^+ \notin H$ and $\text{Col}(\square) \subseteq F$ for every $\square \in I[\mathfrak{F}, \mathfrak{F}]$.
- (6) If $|A| = 2$, then
- (i) $F \cap \text{Col}(\mathfrak{F}) = \emptyset$ (which implies that $\mathfrak{F} \in A \setminus H$ and $x = \text{agitated}$), and
 - (ii) If $A = \{\mathfrak{F}, \mathfrak{G}\}$, then $\mathfrak{F}^+ \notin H$ and $\text{Col}(\square) \subseteq F$ for every $\square \in I[\text{opp}(\mathfrak{F}), \mathfrak{G}] - \text{opp}(\mathfrak{F})$.
- (7) If $x = \text{agitated}$ and $e_F^-(\mathfrak{F}) = \text{opp}(\mathfrak{F}^+)$, then $F \cap \text{Col}(\mathfrak{F}^+) = \emptyset$.

The set of all m -crowned-frog arrangements on $[2] \times [k]$ is denoted by $\mathcal{F}_{k,m}^{\text{crown}}$.

As suggested earlier, the set F represents the positions of the un-agitated frogs, the set H represents the positions of the un-agitated frogs wearing a hat and the set A represents the positions of the agitated frogs. Furthermore, \mathfrak{F} marks the position of a special crowned frog (which is either a hatted frog or an agitated frog) and $x \in \{\text{agitated}, \text{settled}\}$ indicates whether or not the crowned frog is agitated (which is necessary only when $\mathfrak{F} \in A \cap H$ due to [property 3](#)).

We extend the rotation map **ROTATE** to act on $\mathcal{F}_{k,m}^{\text{crown}}$ by applying it pointwise to the first four coordinates and leaving the fifth unchanged. It is not difficult to see that $\mathcal{F}_{k,m}^{\text{crown}}$ is invariant under **ROTATE**.

We next define two special subsets of $\mathcal{F}_{k,m}^{\text{crown}}$ which bridge the gap between crowned-frog arrangements and hatted-frog arrangements.

Definition 22 (Starting arrangements). The set $\mathcal{F}_{k,m}^{\text{start}}$ consists of all crowned-frog arrangements of the form $(F, H, A, \mathfrak{F}, \text{agitated}) \in \mathcal{F}_{k,m}^{\text{crown}}$ where $A \subseteq \text{Col}(\mathfrak{F})$, and $F \cap \text{Col}(\mathfrak{F}) = \emptyset$, and $(F \sqcup A, H + \mathfrak{F}) \in \mathcal{F}_{k,m}^{\text{hat}}$.

Definition 23 (Ending arrangements). The set $\mathcal{F}_{k,m}^{\text{end}}$ consists of all crowned-frog arrangements of the form $(F, H, \emptyset, \mathfrak{F}, \text{settled}) \in \mathcal{F}_{k,m}^{\text{crown}}$.

We now justify the relationship between starting/ending arrangements and hatted-frog arrangements.

For each $c \in [k]$, define a map

$$\text{POKE}_c: \mathcal{F}_{k,m}^{\text{hat}} \rightarrow \mathcal{F}_{k,m}^{\text{crown}} \sqcup \mathcal{F}_{k,m}^{\text{hat}},$$

which ‘‘pokes the frogs in column c ’’. For $F = (F, H) \in \mathcal{F}_{k,m}^{\text{hat}}$, set $A = F \cap ([2] \times \{c\})$:

- If $A = \emptyset$, then $\text{POKE}_c(F) \stackrel{\text{def}}{=} F$.
- If $A \neq \emptyset$, set $\{\mathfrak{F}\} = H \cap A$. Then $\text{POKE}_c(F) \stackrel{\text{def}}{=} (F \setminus A, H \setminus A, A, \mathfrak{F}, \text{agitated})$.

In other words, the frogs in column c become agitated and the frog in column c which had a hat now dons a crown.

Observation 24. For each $F \in \mathcal{F}_{k,m}^{\text{hat}}$ and each $c \in [k]$, $\text{POKE}_c(F) \in \mathcal{F}_{k,m}^{\text{start}} \sqcup \mathcal{F}_{k,m}^{\text{hat}}$. Furthermore, for each $F \in \mathcal{F}_{k,m}^{\text{start}}$, there is a unique pair $(F', c) \in \mathcal{F}_{k,m}^{\text{hat}} \times [k]$ for which $F = \text{POKE}_c(F')$.

Turning our attention to $\mathcal{J}_{k,m}^{\text{end}}$, there is a projection which simply forgets about the crowned frog:

$$\begin{aligned} \text{DETHRONE}: \mathcal{J}_{k,m}^{\text{end}} &\rightarrow \mathcal{J}_{k,m} \\ &: (F, H, \emptyset, \mathbb{S}_2^+, \text{settled}) \mapsto (F, H). \end{aligned}$$

Observation 25. The elements of $\mathcal{J}_{k,m}^{\text{end}}$ are created by taking an element of $\mathcal{J}_{k,m}$ and declaring one of the hatted frogs to have a crown. In particular, for each $F = (F, H) \in \mathcal{J}_{k,m}$,

$$\text{DETHRONE}^{-1}(F) = \{(F, H, \emptyset, \mathbb{S}_2^+, \text{settled}) : \mathbb{S}_2^+ \in H\} \implies |\text{DETHRONE}^{-1}(F)| = |H|.$$

With these definitions in place, we encourage the reader to look back at the discussion toward the beginning of [Section 3.2](#). Essentially, proving [Theorem 15](#) amounts to finding a bijection $\Phi: \mathcal{J}_{k,m}^{\text{start}} \rightarrow \mathcal{J}_{k,m}^{\text{end}}$ which tracks the hatted-frog process in the sense that

$$F^c = (\text{DETHRONE} \circ \Phi \circ \text{POKE}_c)(F),$$

whenever F is a hatted-frog arrangement with a frog in column c .

To find this bijection, we define a transition map on $\mathcal{J}_{k,m}$ which represents the hopping of an agitated frog. In the following definition, we include also pictorial representations of each of the rules to aid in understanding. We additionally encourage the reader to look at [Figure 7](#) while reading the definition in order to see the transition map in action.

Definition 26 (The transition map HOP). Fix an element $F = (F, H, A, \mathbb{S}_2^+, x) \in \mathcal{J}_{k,m} \setminus \mathcal{J}_{k,m}^{\text{end}}$. In order to define $\text{HOP}(F)$, we break into cases:

C) $A = \{\mathbb{S}_2^+\}$ and $x = \text{agitated}$. The included pictures show only $\text{Col}(\mathbb{S}_2^+)$ and assume that \mathbb{S}_2^+ is a square in the top row of the grid.

C1) If $F \cap \text{Col}(\mathbb{S}_2^+) = \emptyset$, then

$$\text{HOP}(F) \stackrel{\text{def}}{=} (F + \mathbb{S}_2^+, H + \mathbb{S}_2^+, \emptyset, \mathbb{S}_2^+, \text{settled})$$

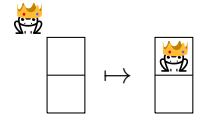

C2) If $\mathbb{S}_2^+ \notin F$ and $F \cap \text{Col}(\mathbb{S}_2^+) \neq \emptyset$, then

$$\text{HOP}(F) \stackrel{\text{def}}{=} (F + \mathbb{S}_2^+, H - \text{opp}(\mathbb{S}_2^+) + \mathbb{S}_2^+, \emptyset, \mathbb{S}_2^+, \text{settled})$$

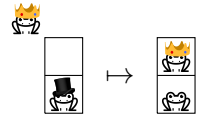

C3) If $\mathbb{S}_2^+ \in H$, then

$$\text{HOP}(F) \stackrel{\text{def}}{=} (F, H, \{\mathbb{S}_2^+\}, \mathbb{S}_2^+, \text{agitated})$$

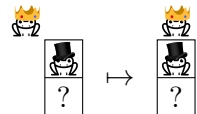

C4) If $\mathbb{S}_2^+ \in F \setminus H$, then

$$\text{HOP}(F) \stackrel{\text{def}}{=} (F, H - \text{opp}(\mathbb{S}_2^+) + \mathbb{S}_2^+, \{\mathbb{S}_2^+\}, \mathbb{S}_2^+, \text{settled})$$



F) $|A| = 2$ or both $|A| = 1$ and $x = \text{settled}$. Thus, either $A = \{\mathfrak{F}\}$ or $A = \{\mathfrak{F}, \mathfrak{F}^{\text{crown}}\}$ for some $\mathfrak{F} \in [2] \times [k]$. Note that $\mathfrak{F}^+ \notin H$ according to [properties 5](#) and [6](#). The included pictures show only $\text{Col}(\mathfrak{F}^+)$ and assume that \mathfrak{F}^+ is a square in the top row of the grid.

F1) If $F \cap \text{Col}(\mathfrak{F}^+) = \emptyset$, then

$$\text{HOP}(F^{\text{crown}}) \stackrel{\text{def}}{=} (F + \mathfrak{F}^+, H + \mathfrak{F}^+, A - \mathfrak{F}, \mathfrak{F}^{\text{crown}}, x).$$

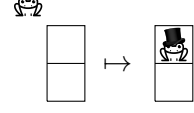

F2) If $\mathfrak{F}^+ \notin F$ and $F \cap \text{Col}(\mathfrak{F}^+) \neq \emptyset$, then

$$\text{HOP}(F^{\text{crown}}) \stackrel{\text{def}}{=} (F + \mathfrak{F}^+, H - \text{opp}(\mathfrak{F}^+) + \mathfrak{F}^+, A - \mathfrak{F}, \mathfrak{F}^{\text{crown}}, x).$$

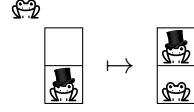

F3) If $\mathfrak{F}^+ \in F \setminus H$ and $\mathfrak{F} \neq \text{opp}(\mathfrak{F}^+)$, then

$$\text{HOP}(F^{\text{crown}}) \stackrel{\text{def}}{=} (F, H - \text{opp}(\mathfrak{F}^+) + \mathfrak{F}^+, A - \mathfrak{F} + \mathfrak{F}^{\text{crown}}, \mathfrak{F}^{\text{crown}}, x).$$

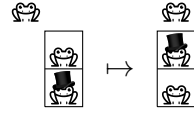

F4) If $\mathfrak{F}^+ \in F \setminus H$ and $\mathfrak{F} = \text{opp}(\mathfrak{F}^+)$, then

$$\text{HOP}(F^{\text{crown}}) \stackrel{\text{def}}{=} (F, H - \text{opp}(\mathfrak{F}^+) + \mathfrak{F}^+, \{\mathfrak{F}^+\}, \mathfrak{F}^{\text{crown}}, \text{agitated}).$$



Observe that $\text{HOP} \circ \text{ROTATE} = \text{ROTATE} \circ \text{HOP}$.

At this point, we encourage the reader to skip ahead to [Corollary 29](#) and [Figure 7](#) to get a better understanding of HOP before diving into [Theorem 28](#).

We record a few observations that follow directly from the definition of HOP .

Observation 27. Fix an element $F^{\text{crown}} = (F, H, A, \mathfrak{F}^{\text{crown}}, x) \in \mathcal{F}_{k,m}^{\text{crown}} \setminus \mathcal{F}_{k,m}^{\text{end}}$. Define $\mathfrak{F} \in [2] \times [k]$ by $\{\mathfrak{F}, \mathfrak{F}^{\text{crown}}\} = A + \mathfrak{F}^{\text{crown}}$ (note that we could have $\mathfrak{F} = \mathfrak{F}^{\text{crown}}$). If $\text{HOP}(F^{\text{crown}}) = (F_*, H_*, A_*, \mathfrak{F}_*, x_*)$, then

- $F_* = F + \mathfrak{F}^+$ and $H_* = H - \text{opp}(\mathfrak{F}^+) + \mathfrak{F}^+$, and
- $\mathfrak{F}_* \in \{\mathfrak{F}, \mathfrak{F}^+\}$, and
- $A_* = \begin{cases} A - \mathfrak{F}, & \text{if } \mathfrak{F}^+ \notin F, \\ A - \mathfrak{F} + \mathfrak{F}^+, & \text{if } \mathfrak{F}^+ \in F. \end{cases}$

We now prove that HOP sends crowned-frog arrangements to crowned-frog arrangements.

Theorem 28. Fix integers k, m with $0 \leq m \leq 2k$. If $F^{\text{crown}} \in \mathcal{F}_{k,m}^{\text{crown}} \setminus \mathcal{F}_{k,m}^{\text{end}}$, then $\text{HOP}(F^{\text{crown}}) \in \mathcal{F}_{k,m}^{\text{crown}} \setminus \mathcal{F}_{k,m}^{\text{start}}$.

Proof. Write $F_*^{\text{crown}} = (F_*, H_*, A_*, \mathfrak{F}_*, x_*) = \text{HOP}(F^{\text{crown}})$ and $\{\mathfrak{F}\} = A \setminus A_*$.

We begin by showing that $F_*^{\text{crown}} \in \mathcal{F}_{k,m}^{\text{crown}}$ by verifying each of the 7 properties.

- (1) (F, H) is a hatted-frog arrangement ([property 1](#)) and either $F \cap \text{Col}(\mathfrak{F}) = \emptyset$ or $\mathfrak{F} \in H$ ([property 4](#)) and so the fact that (F_*, H_*) is a hatted-frog arrangement follows from combining [Observation 27](#) and [Lemma 12](#).

(2) The fact that $|A_*| \leq 2$ and $|A_*| + |F_*| = m$ is an immediate consequence of [Observation 27](#).

(3) Suppose first that $x_* = \text{agitated}$. If the transition from F to F_* took place according to either [rule C3](#) or [F4](#), then $\mathfrak{S}_* \in A_*$ by definition. Otherwise, the transition took place according to one of [rules F1](#) to [F3](#) and $x = \text{agitated}$. This implies that $|A| = 2$, $A = \{\mathfrak{S}, \mathfrak{S}'\}$ ([property 3](#)) and $\mathfrak{S}'_* = \mathfrak{S}'$. The fact that $\{\mathfrak{S}\} = A \setminus A_*$ then means that $\mathfrak{S}_* = \mathfrak{S} \in A_*$ as needed.

Suppose next that $x_* = \text{settled}$. If the transition from F to F_* took place according to [rule C1](#), [C2](#) or [C4](#), then $\mathfrak{S}_* \in H_*$ by definition. Otherwise, the transition took place according to one of [rules F1](#) to [F3](#) and $x = \text{settled}$. In this case, $A = \{\mathfrak{S}\}$ and $\mathfrak{S}'_* = \mathfrak{S}'$. Therefore, $\mathfrak{S}_* = \mathfrak{S} \in H$ due to [property 3](#). Now, since $H_* = H - \text{opp}(\mathfrak{S}^+) + \mathfrak{S}^+$, the only way to have $\mathfrak{S}_* \notin H_*$ is if $\mathfrak{S}_* = \text{opp}(\mathfrak{S}^+)$. However, we know this to not be the case since otherwise the transition would have taken place according to [rule F4](#), meaning that $x_* = \text{agitated}$.

(4) Note that (F, H) is a hatted-frog arrangement ([property 1](#)) and either $F \cap \text{Col}(\mathfrak{S}) = \emptyset$ or (F, H) aligns with $I(e_{F^-}(\mathfrak{S}), \mathfrak{S}]$ ([property 4](#)). Thus, by combining [Observation 27](#) and [Lemma 20](#), we know that (F_*, H_*) aligns with $I(e_{F_*^-}(\mathfrak{S}^+), \mathfrak{S}^+]$.

Now, fix $\mathfrak{S}_* \in A_*$. If $\mathfrak{S}_* = \mathfrak{S}^+$, then (F_*, H_*) aligns with $I(e_{F_*^-}(\mathfrak{S}_*), \mathfrak{S}_*]$ by the remark above. Otherwise, $\mathfrak{S}_* \neq \mathfrak{S}^+$ in which case we must have $A_* = \{\mathfrak{S}^+, \mathfrak{S}_*\}$, $x_* = \text{agitated}$ and $\mathfrak{S}_* = \mathfrak{S}'_*$. Since $\mathfrak{S}^+ \neq \mathfrak{S}'_*$, we must have $\mathfrak{S}'_* = \mathfrak{S}'$, $A = \{\mathfrak{S}, \mathfrak{S}'\}$ and $x = \text{agitated}$ as well. Then, due to [property 6](#), we know that $F \cap \text{Col}(\mathfrak{S}) = \emptyset$ and that $\text{Col}(\mathfrak{S}^+) \neq \text{Col}(\mathfrak{S})$ since $\mathfrak{S}^+ \neq \mathfrak{S}$. Thus, $F_* \cap \text{Col}(\mathfrak{S}_*) = \emptyset$ as needed.

(5) Suppose that $A_* = \{\mathfrak{S}_*\}$ and $x_* = \text{settled}$. Therefore $\mathfrak{S}_* = \mathfrak{S}^+$ and the transition from F to F_* took place according to [rule F3](#) or [C4](#). In either case, we know that $F = F_*$, $\text{Col}(\mathfrak{S}_*) \subseteq F_*$ and that $\mathfrak{S}^+ \notin H$.

If the transition took place according to [rule C4](#), then $\mathfrak{S}_* = \mathfrak{S}'_*$ and so clearly $\text{Col}(\square) \subseteq F_*$ for every $\square \in I[\mathfrak{S}'_*, \mathfrak{S}'_*]$. If the transition took place according to [rule F3](#), then $\mathfrak{S}_* = \mathfrak{S}$, $A = \{\mathfrak{S}\}$ and $x = \text{settled}$. Therefore, since F satisfies [property 5](#), we immediately have that $\text{Col}(\square) \subseteq F_*$ for every $\square \in I[\mathfrak{S}_*, \mathfrak{S}_*]$.

Now, suppose for the sake of contradiction that $\mathfrak{S}_*^+ \in H_*$ and set $\mathfrak{S}' = \text{opp}(\mathfrak{S}_*)$. Since $\mathfrak{S}_* \in H_*$, we know that $\mathfrak{S}_*^+ \neq \mathfrak{S}'$; phrased differently, $\text{opp}(\mathfrak{S}')^+ \neq \mathfrak{S}'$. This also means that $\text{opp}(\mathfrak{S}')^+ = \mathfrak{S}_*^+ \in H$ since the only difference between H and H_* occurs in $\text{Col}(\mathfrak{S}_*)$. However, since $\mathfrak{S}_* = \mathfrak{S}^+ \notin H$ and $\mathfrak{S}_* \in F$, this means that $\mathfrak{S}' \in H$ as well; a contradiction to the fact that (F, H) is a hatted-frog arrangement ([Observation 16](#)).

(6) Suppose that $|A_*| = 2$. Then the transition from F to F_* took place according to [rule F3](#). In particular, $F_* = F$, $x_* = x = \text{agitated}$, $|A| = 2$ with $A = \{\mathfrak{S}, \mathfrak{S}'\}$, $\mathfrak{S}'_* = \mathfrak{S}'$, $A_* = \{\mathfrak{S}, \mathfrak{S}^+\}$ and $\text{Col}(\mathfrak{S}^+) \subseteq F_*$. Of course, this means that $F_* \cap \text{Col}(\mathfrak{S}_*) = \emptyset$ and $\text{Col}(\square) \subseteq F_*$ for every $\square \in I[\text{opp}(\mathfrak{S}_*), \mathfrak{S}^+] - \text{opp}(\mathfrak{S}_*)$ since F satisfies [property 6](#).

The argument that $\mathfrak{S}_*^+ \notin H_*$ is identical to the argument used to verify the preceding item.

(7) Suppose that $x_* = \text{agitated}$ and that $e_{F_*^-}(\mathfrak{S}_*) = \text{opp}(\mathfrak{S}_*^+)$, yet $F_* \cap \text{Col}(\mathfrak{S}_*^+) \neq \emptyset$. Since $x_* = \text{agitated}$, we know that $\mathfrak{S}_* \in A_*$ and so $F_* \neq [2] \times [k]$ ([property 2](#) since $m \leq 2k$); therefore, $e_{F_*^-}(\mathfrak{S}_*) \notin F_*$. This implies that $\mathfrak{S}_*^+ \in H_*$. We claim also that $\mathfrak{S}_* \in H_*$. Indeed,

if $\mathfrak{F}_* \notin H_*$, then $F_* \cap \text{Col}(\mathfrak{F}_*) = \emptyset$ due to [property 4](#). But then $e_{F_*}^-(\mathfrak{F}_*) = \mathfrak{F}_*$ and we know that $\mathfrak{F}_* \neq \text{opp}(\mathfrak{F}_*^+)$ since $\mathfrak{F}_*^+ \in H_* \subseteq F_*$.

In particular, this implies that \mathfrak{F}_* and \mathfrak{F}_*^+ reside in different columns. This additionally implies that, $\text{Col}(\mathfrak{F}_*) \subseteq F_*$ since we must have $I(\text{opp}(\mathfrak{F}_*^+), \mathfrak{F}_*) \subseteq F_*$.

We now consider the transition from F to F_* .

If $x = \text{settled}$, then the transition could have only taken place according to [rule F4](#). However, in this case, $\text{opp}(\mathfrak{F}_*), \mathfrak{F}_*^+ \in H$ which contradicts the fact that (F, H) is a hatted-frog arrangement ([Observation 16](#)). Therefore $x = \text{agitated}$.

Since $F_* = F + \mathfrak{F}_*^+$ and $\text{Col}(\mathfrak{F}_*) \subseteq F_*$, we know that $F \cap \text{Col}(\mathfrak{F}_*) \neq \emptyset$. In particular, we cannot have $|A| = 2$ since then $\mathfrak{F}_* = \mathfrak{F}_*$ and so [property 6](#) would be violated for F . Thus, $A = \{\mathfrak{F}_*\}$ and $\mathfrak{F}_* = \mathfrak{F}_* = \mathfrak{F}_*^-$. Since $x_* = \text{agitated}$ as well, we know that $F = F_*$ and so $e_F^-(\mathfrak{F}_*) = e_{F_*}^-(\mathfrak{F}_*) = \text{opp}(\mathfrak{F}_*^+)$. Since $\mathfrak{F}_* = \mathfrak{F}_*^+$, we find that $I(e_F^-(\mathfrak{F}_*), \mathfrak{F}_*)$ contains $\text{opp}(\mathfrak{F}_*)$ but does not contain \mathfrak{F}_* . Thus, since (F, H) aligns with $I(e_F^-(\mathfrak{F}_*), \mathfrak{F}_*)$ ([property 4](#)), we must additionally have $\text{opp}(\mathfrak{F}_*) \in H$. But then, both $\text{opp}(\mathfrak{F}_*)$ and \mathfrak{F}_*^+ belong to H ; a final contradiction ([Observation 16](#)).

Next, we show that $F_* \notin \mathcal{J}_{k,m}^{\text{start}}$, which will conclude the proof.

Suppose for the sake of contradiction that $F_* \in \mathcal{J}_{k,m}^{\text{start}}$. Then $A_* \subseteq \text{Col}(\mathfrak{F}_*)$, $x_* = \text{agitated}$ and F_* is disjoint from $\text{Col}(\mathfrak{F}_*)$. In particular, $A_* = A - \mathfrak{F}_*$ since otherwise we would have $\mathfrak{F}_*^+ \in A_* \cap F_*$. This also implies that $\mathfrak{F}_*^+ \in F_* \setminus F$, $\mathfrak{F}_* = \mathfrak{F}_*$ and $x = \text{agitated}$. Using rotational symmetry, we may suppose that $\mathfrak{F}_* = \mathfrak{F}_* = (1, c)$.

Now, according to [property 6](#), we know that $\text{Col}(\square) \subseteq F$ for every $\square \in I[\text{opp}(\mathfrak{F}_*), \mathfrak{F}_*] - \text{opp}(\mathfrak{F}_*)$. Since $\mathfrak{F}_*^+ \notin F$, this means that $\mathfrak{F}_*^+ = (2, f)$ for some $f \in [c-1]$. Let $t \in [f, c-1]$ be the largest integer for which $(2, f) \in H_*$; note that t exists since $\mathfrak{F}_*^+ \in H_*$. Since $[2] \times [f+1, c-1] \subseteq F_*$, this implies that $(2, t), (1, t+1) \in H_* + \mathfrak{F}_*$; a contradiction to the fact that $(F_* + \mathfrak{F}_*, H_* + \mathfrak{F}_*)$ is a hatted-frog arrangement. \square

Now that we know that HOP is a function from $\mathcal{J}_{k,m} \setminus \mathcal{J}_{k,m}^{\text{end}}$ to $\mathcal{J}_{k,m} \setminus \mathcal{J}_{k,m}^{\text{start}}$, we observe that POKE_c , HOP and DETHRONE together embody the hatted-frog process. Indeed, a comparison between [Observation 27](#) and the proof of [Theorem 10](#) shows that:

Corollary 29. *Fix any $F \in \mathcal{J}_{k,m}$ and any $c \in [k]$. If F has a frog in column c , then*

$$F^c = (\text{DETHRONE} \circ \text{HOP}^h \circ \text{POKE}_c)(F), \quad \text{where } h = \text{H}(F, c).$$

Examples of [Corollary 29](#) are shown in [Figure 7](#).

At this point, we have “lifted” the hatted-frog process to a new “crowned-frog process” defined by the map HOP . The astute reader will notice that HOP is not the only map which would accomplish this feat; in fact, it is far from the simplest such map. The reason for using this specific transition map is that it has an extra important property:

Theorem 30. *For integers k, m with $0 \leq m \leq 2k$, $\text{HOP}: \mathcal{J}_{k,m} \setminus \mathcal{J}_{k,m}^{\text{end}} \rightarrow \mathcal{J}_{k,m} \setminus \mathcal{J}_{k,m}^{\text{start}}$ is an injection.*



(a) Compare to Figure 4a.

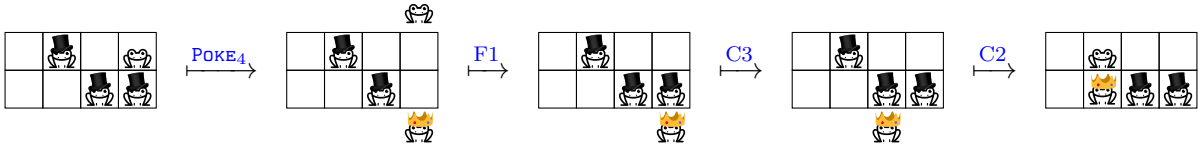

(b) Compare to Figure 4b.

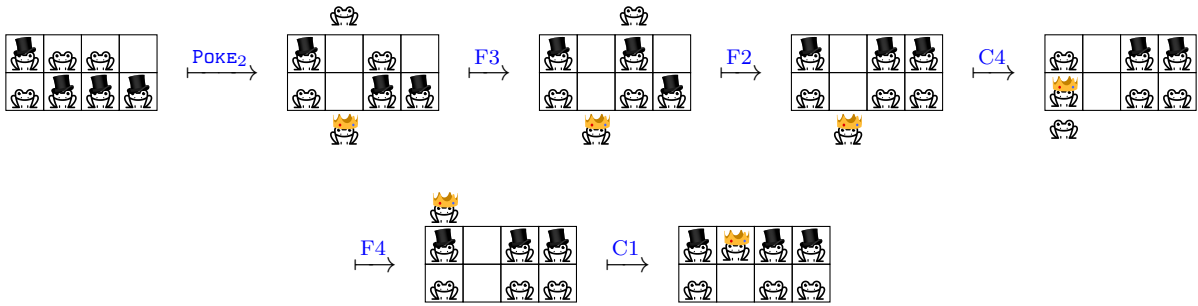

(c) Compare to Figure 4c.

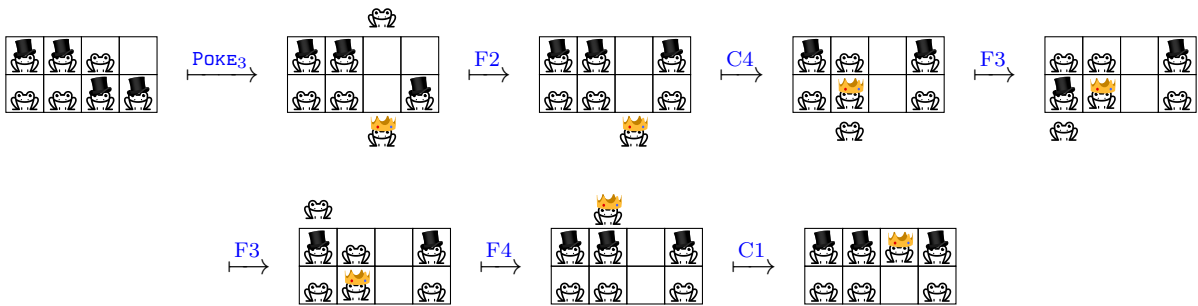

(d) Compare to Figure 4d.

Figure 7: Examples of Corollary 29. An agitated frog is drawn just above/below the square that it occupies. The examples shown here correspond to the examples of the hatted-frog process shown in Figure 4.

Proof. Fix $F = (F, H, A, \mathfrak{S}, x) \in \mathcal{J}_{k,m} \setminus \mathcal{J}_{k,m}^{\text{start}}$ and suppose that $F_1 = (F_1, H_1, A_1, \mathfrak{S}_1, x_1) \in \mathcal{J}_{k,m} \setminus \mathcal{J}_{k,m}^{\text{end}}$ satisfies $\text{Hop}(F_1) = F$. We must show that F_1 is unique in this regard.

Set $\{\mathfrak{S}_1\} = A_1 \setminus A$.

Case 1: $|A| = 2$. Here we have $A = \{\mathfrak{S}, \mathfrak{S}\}$ and $\mathfrak{S}_1 = \mathfrak{S}^-$. Furthermore, the transition from F_1 to F must have taken place according to [rule F3](#) and so F_1 is uniquely determined.

Case 2: $|A| = 1$ and $x = \text{settled}$. In this case, we must have $A_1 = \{\mathfrak{S}_1\}$, $A = \{\mathfrak{S}_1^+\}$ and $\mathfrak{S}_1^+ \in F$. In particular, \mathfrak{S}_1 and F are uniquely determined. Recall that [Observation 27](#) implies that $\mathfrak{S} \in \{\mathfrak{S}_1, \mathfrak{S}_1^+\}$.

If $\mathfrak{S} = \mathfrak{S}_1^+$, then the transition from F_1 to F could only have taken place according to [rule C4](#). If $\mathfrak{S} \neq \mathfrak{S}_1^+$, then $\mathfrak{S}_1 = \mathfrak{S}$ and transition from F_1 to F could only have taken place according to [rule F3](#). Therefore, since \mathfrak{S}_1 is uniquely determined, F_1 is uniquely determined based on whether or not $\mathfrak{S} = \mathfrak{S}_1^+$ (i.e. whether or not $\mathfrak{S} \in A$).

Case 3: $|A| = 1$ and $F \cap \text{Col}(\mathfrak{S}) = \emptyset$. In this case, the transition from F_1 to F must have taken place according to [rule F1](#) or [rule F2](#) and $\mathfrak{S}_1^+ \neq \mathfrak{S}$. In particular, we know that $x_1 = x = \text{agitated}$, $\mathfrak{S}_1 = \mathfrak{S}$ and $\{\mathfrak{S}_1^+\} = F \setminus F_1$. Therefore, if we can show that \mathfrak{S}_1 is uniquely determined, then we have shown that F_1 is uniquely determined.

Using rotational symmetry, we may suppose that $\mathfrak{S} = (1, c)$ and so $\mathfrak{S}_1^+ = (r, f)$ for some $f \in [c-1]$ due to [property 6](#). If $\mathfrak{S}_1 = (r', f')$, then [property 6](#) implies additionally that $[2] \times [f', c-1] \subseteq F_1$. Since $(r, f) \notin F_1$, this means that $f' > f$ and so $r = 2$ and $f' = f + 1$.

Now, let $t \in [c]$ be the largest integer for which either $(1, t) \notin F + (1, c)$ or $(2, t-1) \notin H$. Note that t exists since $(2, 0) \notin H$ vacuously. Additionally, note that we have $t = c$ if and only if $(2, c-1) \notin H$. If we can show that $f = t$, then we will have shown that \mathfrak{S}_1 is uniquely determined as desired.

As discussed above, we know that $[2] \times [f+1, c-1] \subseteq F$ and know also that (F, H) aligns with $I((2, c), (2, f))$, implying that $\{2\} \times [f, c-1] \subseteq H$. Therefore, we must have $f \geq t$. If $f > t$, then it must be the case that $(1, f) \in F$ and $(2, f-1) \in H$. However, since $(2, f) \notin F_1$ this would mean that $(2, f-1), (1, f) \in H_1$, contradicting the fact that (F_1, H_1) is a hatted-frog arrangement.

Case 4: $|A| = 1$, $x = \text{agitated}$ and $F \cap \text{Col}(\mathfrak{S}) \neq \emptyset$. Therefore, we must have $A = \{\mathfrak{S}\}$ and $\mathfrak{S} \in H$. We claim furthermore, that $\mathfrak{S} = \mathfrak{S}_1^+$. Indeed, if this is not the case, then $\mathfrak{S}_1 = \mathfrak{S}$ and $A_1 = \{\mathfrak{S}, \mathfrak{S}\}$. This, however, would contradict [property 6](#) since we would have $\mathfrak{S}_1 \in F_1 \cap \text{Col}(\mathfrak{S}_1)$.

Therefore, either $A_1 = \{\mathfrak{S}_1\}$ or $A_1 = \{\mathfrak{S}, \mathfrak{S}_1\}$ where $\mathfrak{S} = \mathfrak{S}_1^+$. In particular, $\mathfrak{S}_1 = \mathfrak{S}^-$ is uniquely determined. Note that if $|A_1| = 2$, then we must have $\mathfrak{S}_1 = \mathfrak{S}$ and $F_1 \cap \text{Col}(\mathfrak{S}) = \emptyset$.

Consider $e_F^-(\mathfrak{S})$. Since $F_1 \subseteq F \neq [2] \times [k]$ ([property 2](#)), we know that $e_F^-(\mathfrak{S}_1) = e_F^-(\mathfrak{S})$ due to [property 5](#).

Case 4a: $e_F^-(\mathfrak{S}) = \text{opp}(\mathfrak{S})$. In this case, we claim that $|A_1| = 2$. Indeed, suppose that $A_1 = \{\mathfrak{S}_1\}$. If $x_1 = \text{agitated}$, then $\mathfrak{S}_1 = \mathfrak{S}_1^+$ and we must have $\mathfrak{S} = \mathfrak{S}_1^+ \in H_1$ or else $x = \text{settled}$. However, since $e_{F_1}^-(\mathfrak{S}_1) = \text{opp}(\mathfrak{S}_1^+)$ here, this contradicts [property 7](#). On the other hand, if $x_1 = \text{settled}$, then the transition from F_1 to F must have taken place according to [rule F4](#); however this contradicts the fact that $\text{opp}(\mathfrak{S}) = e_F^-(\mathfrak{S}) \notin F_1$.

Therefore, $|A_1| = 2$ and so also $F_1 \cap \text{Col}(\mathfrak{S}) = \emptyset$. Because also $\mathfrak{S} = \mathfrak{S}_1^+$, the transition from F_1 to F must have taken place according to [rule F1](#) and so F_1 is uniquely determined.

Case 4b: $e_F^-(\mathfrak{S}_2) \neq \text{opp}(\mathfrak{S}_2)$. In this case, we must have $|A_1| = 1$. Indeed, if $|A_1| = 2$, then [properties 4](#) and [6](#) would imply that $e_F^-(\mathfrak{S}_2) = \text{opp}(\mathfrak{S}_2)$.

Since $|A_1| = 1$, the transition from F_1 to F could only have taken place according to either [rules C3](#) and [F4](#). Note that if $x_1 = \text{agitated}$, then $\mathfrak{S}_{2_1} = \mathfrak{S}_2$ and that if $x_1 = \text{settled}$, then $\mathfrak{S}_{2_1} = \text{opp}(\mathfrak{S}_2)$. Thus, if we can show that x_1 is uniquely determined, then we have shown that F_1 is uniquely determined as well.

Recall that $e_F^-(\mathfrak{S}_{2_1}) = e_F^-(\mathfrak{S}_2)$. We next claim that also $e_F^-(\mathfrak{S}_{2_1}) = e_F^-(\mathfrak{S}_2)$. Indeed, if $x_1 = \text{agitated}$, then $\mathfrak{S}_{2_1} = \mathfrak{S}_2$ and so $e_F^-(\mathfrak{S}_{2_1}) = e_F^-(\mathfrak{S}_2)$. Otherwise, if $x_1 = \text{settled}$, then [property 5](#) tells us that $I[\mathfrak{S}_{2_1}, \mathfrak{S}_{2_1}] \subseteq F$ and so we still have that $e_F^-(\mathfrak{S}_{2_1}) = e_F^-(\mathfrak{S}_2)$.

Using rotational symmetry, we may suppose that $\mathfrak{S}_2 = (1, c)$. Set $e_F^-(\mathfrak{S}_2) = (r, f)$; since $F = F_1 \neq [2] \times [k]$, we know that $(r, f) \notin F$. In particular, $f \neq c$. We break into two cases:

Case 4bi: $f < c$. We claim that $x_1 = \text{agitated}$. Indeed, if $x_1 = \text{settled}$, then $\mathfrak{S}_{2_1} = (2, c)$ and so $(r, f) \in I[\mathfrak{S}_{2_1}, \mathfrak{S}_{2_1}] \subseteq F_1 = F$; a contradiction.

Case 4bii: $f > c$. In this case, we know that $(2, c) \in I((r, f), \mathfrak{S}_{2_1}]$ whereas $(1, c) \notin I((r, f), \mathfrak{S}_{2_1}]$. Since (F_1, H_1) aligns with $I((r, f), \mathfrak{S}_{2_1}]$, this implies that $(2, c) \in H$ and so $x_1 = \text{settled}$ since otherwise $(1, c) \in H$.

Case 5: $|A| = 0$. In this case, we must have $A_1 = \{\mathfrak{S}_{2_1}\}$ and $\{\mathfrak{S}_{2_1}^+\} = F \setminus F_1$. In particular, the transition from F_1 to F took place according to one of [rules C1](#) to [F2](#). As such, if we can show that \mathfrak{S}_{2_1} is uniquely determined, then we will have shown that F_1 is uniquely determined.

Case 5a: $F = [2] \times [k]$. Using rotational symmetry, we may suppose that $\mathfrak{S}_2 = (1, c)$ for some $c \in [k]$. Since $\mathfrak{S}_2 \in H$ and F contains every square of the grid, we know that there is some $\ell \in [k]$ for which $(1, f) \in H$ whenever $f \leq \ell$ and $(2, f) \in H$ whenever $f > \ell$. Of course, $c \leq \ell$. We claim that $\mathfrak{S}_{2_1}^+ = (1, \ell)$ which will conclude this case.

To see why, because $\mathfrak{S}_{2_1}^+ \in H$, we have either $\mathfrak{S}_{2_1}^+ = (1, f)$ for some $f \leq \ell$ or $\mathfrak{S}_{2_1}^+ = (2, f)$ for some $f > \ell$. In the former case, we would have $(2, f) \in H_1$ and so we must also have $(2, \ell) \in H_1$ implying that $f = \ell$. In the latter case, we would have $\mathfrak{S}_{2_1} \neq \mathfrak{S}_{2_1}^+ = (1, c)$ yet $(2, f) \notin F_1$ which contradicts [property 5](#).

Case 5b: $F \neq [2] \times [k]$. Using rotational symmetry, we may suppose that $\mathfrak{S}_2 = (1, c)$. Let $f \in [c, k]$ be the smallest integer such that either $(2, f) \notin F$ or $(1, f)^+ \notin H$. By construction, $\{1\} \times [c, f] \subseteq H$ and $[2] \times [c, f-1] \subseteq F$. We claim that $\mathfrak{S}_{2_1}^+ = (1, f)$, which will conclude this case.

In this situation we know that $e_F^-(\mathfrak{S}_{2_1}^+) = e_F^-(\mathfrak{S}_2)$ and that (F, H) aligns with $I(e_F^-(\mathfrak{S}_2), \mathfrak{S}_{2_1}^+]$. Since $\mathfrak{S}_{2_1}^+ \notin F_1$ we must have $\mathfrak{S}_{2_1}^+ = (1, \ell)$ for some $\ell \in [c, k]$ or else [property 5](#) is violated for F_1 . Further using [property 5](#), $\{1\} \times [c, \ell] \subseteq H$ and that $[2] \times [c, \ell-1] \subseteq F$. In particular, $\ell \geq f$. Certainly if $(2, \ell) \notin F$, then $\ell = f$. Otherwise, $(2, \ell) \in F$ and hence $(2, \ell) \in H_1$. Since H_1 and H differ only in column ℓ , this would mean that $(1, \ell+1) \in H_1$ in the case that $\ell < f$, yielding a contradiction. \square

The injectivity of HOP can now be easily bootstrapped up to full bijectivity.

Corollary 31. Fix integers k, m with $0 \leq m \leq 2k$. The map $\text{HOP}: \mathcal{F}_{k,m} \setminus \mathcal{F}_{k,m}^{\text{end}} \rightarrow \mathcal{F}_{k,m} \setminus \mathcal{F}_{k,m}^{\text{start}}$ is a bijection. Moreover, for any $F \in \mathcal{F}_{k,m}$, there is a unique pair $(S, h) \in \mathcal{F}_{k,m}^{\text{start}} \times \mathbb{Z}_{\geq 0}$ for which $F = \text{HOP}^h(S)$.

Proof. We begin by observing that for any $F \in \mathcal{F}_{k,m}^{\text{crown}}$, there is a unique $t \in \mathbb{Z}_{\geq 0}$ for which $\text{Hop}^t(F) \in \mathcal{F}_{k,m}^{\text{end}}$. Indeed, the set of agitated frogs is weakly-decreasing in size and strictly decreases when a frog hops to an empty square. Since $m \leq 2k$, there is always an empty square if there is an agitated frog and so the observation follows.

Now, observe that for $(F, H) \in \mathcal{F}_{k,m}^{\text{crown}}$ and $c \in [k]$, F contains an element of column c if and only if H does as well. As such, [Observations 24](#) and [25](#) together imply that

$$|\mathcal{F}_{k,m}^{\text{start}}| = \sum_{(F,H) \in \mathcal{F}_{k,m}^{\text{crown}}} |H| = |\mathcal{F}_{k,m}^{\text{end}}|.$$

Together with the observation in the previous paragraph and [Theorem 30](#), this establishes the claim. \square

The proof of [Theorem 15](#) is now almost immediate.

Proof of [Theorem 15](#). Fix any $F = (F, H) \in \mathcal{F}_{k,m}^{\text{crown}}$; we must show that there are exactly $|\Sigma|$ many pairs $(S, a) \in \mathcal{F}_{k,m}^{\text{crown}} \times \Sigma$ for which $Sa = F$.

Note that $k - |H|$ is precisely the number of empty columns in F . Of course, if $c \in \Sigma$ is either the index of an empty column in F or not the index of a column (i.e. $c \notin [k]$), then $Fc = F$. This accounts for exactly $|\Sigma| - |H|$ many in-edges to F .

Therefore, we must show that there are exactly $|H|$ many pairs $(S, c) \in \mathcal{F}_{k,m}^{\text{crown}} \times [k]$ for which both $Sa = F$ and S has a frog in column c . Since $|\text{DETHRONE}^{-1}(F)| = |H|$ ([Observation 25](#)), this is an immediate consequence of [Corollaries 29](#) and [31](#). \square

4 Computation of the speeds

Now that we know that the m -hatted-frog dynamics admits a uniform stationary distribution, we can exploit this fact to compute the speeds of the frogs in the original frog dynamics.

Theorem 32. *Set $W = 12 \cdots kk \cdots 21$ and let $\Sigma \supseteq [k]$ be any alphabet. For each $m \in [2k]$, the cumulative speed of the nastiest m frogs in the (W, Σ) frog dynamics is*

$$\sum_{i=1}^m s_i = \frac{2k \cdot \sum_{j \geq 0} \binom{2k-2j}{m-1-2j}}{|\Sigma| \cdot \sum_{j \geq 0} \binom{2k-2j}{m-2j}}.$$

Together with [Theorem 3](#), this proves [Theorem 2](#). The proof of [Theorem 32](#) encapsulates the whole of this section.

We begin by detailing an important bijection, which we derive by applying our knowledge of the crowned frogs from the previous section.

Lemma 33. *Fix integers k, m with $0 \leq m \leq 2k$. For every $\square \in [2] \times [k]$, there is a bijection*

$$\phi_{\square}: \{(F, H) \in \mathcal{F}_{k,m}^{\text{crown}} : \square \in H, I[\text{opp}(\square), \square] \not\subseteq F\} \rightarrow \{(F, H) \in \mathcal{F}_{k,m-1}^{\text{crown}} : F \cap \text{Col}(\square) = \emptyset\}.$$

Informally, the bijection is accomplished by poking the column containing \square and following the hatted-frog process until exactly one frog is agitated.

Proof. Fix $\mathbf{F} = (F, H) \in \mathcal{F}_{k,m}$ with $\square \in H$ and $I[\text{opp}(\square), \square] \not\subseteq F$. Suppose that $\square = (r, c)$. For $t \in [0, H(\mathbf{F}, c)]$, set $(F_t, H_t, A_t, \mathfrak{S}_t, x_t) = \text{HOP}^t(\text{POKE}_c(\mathbf{F}))$, which is reasonable due to [Corollary 29](#). Let $T \in [0, H(\mathbf{F}, c)]$ be the smallest integer for which $|A_T| = 1$ and define $\phi_\square(\mathbf{F}) \stackrel{\text{def}}{=} (F_T, H_T)$. The fact that $(F_T, H_T) \in \mathcal{F}_{k,m-1}$ and $F_T \cap \text{Col}(\square) = \emptyset$ follow from [Theorem 28](#) and the fact that $|F_T| + |A_T| = m$.

To see why ϕ_\square is bijective, fix any $(F', H') \in \mathcal{F}_{k,m-1}$ with $F' \cap \text{Col}(\square) = \emptyset$. Then $\mathbf{F}' = (F', H', \{\square\}, \square, \text{agitated})$ is a member of $\mathcal{F}_{k,m}$. By [Observation 24](#) and [Corollary 31](#), there is a unique $(\mathbf{F}', c, t) \in \mathcal{F}_{k,m} \times [k] \times \mathbb{Z}_{\geq 0}$ for which $\mathbf{F}' = \text{HOP}^t(\text{POKE}_c(\mathbf{F}'))$. If $\mathbf{F}' = (F, H)$, then it is routine to check that $\square \in H$ and $I[\text{opp}(\square), \square] \not\subseteq F$. \square

The above ϕ_\square is actually just a piece of a more far-reaching bijection which we now detail.

Fix a hatted-frog arrangement $\mathbf{F} \in \mathcal{F}_{k,m}$ and fix an index $c \in [k]$. Define $\mathcal{H}(\mathbf{F}, c) \subseteq [2] \times [k]$ to be the set of frogs that hopped when poking column c in the arrangement \mathbf{F} in the hatted-frog process. Formally, if $\mathbf{F} = (F, H)$, then

$$\mathcal{H}(\mathbf{F}, c) \stackrel{\text{def}}{=} \{\mathfrak{S} \in [2] \times [k] : I[(r, c), \mathfrak{S}] \subseteq F \text{ for some } r \in [2]\}.$$

By definition, $H(\mathbf{F}, c) = |\mathcal{H}(\mathbf{F}, c)|$.

Expanding upon this, for non-negative integers k, m , define

$$\Omega_{k,m} \stackrel{\text{def}}{=} \{(\mathbf{F}, c, \mathfrak{S}) : \mathbf{F} \in \mathcal{F}_{k,m}, c \in [k], \mathfrak{S} \in \mathcal{H}(\mathbf{F}, c)\},$$

and observe that

$$|\Omega_{k,m}| = \sum_{c \in [k]} \sum_{\mathbf{F} \in \mathcal{F}_{k,m}} H(\mathbf{F}, c). \quad (3)$$

It will become apparent later that computing $|\Omega_{k,m}|$ is essentially equivalent to proving [Theorem 32](#).

We next define two maps

$$\begin{aligned} \Phi_{k,m} : \Omega_{k,m} &\rightarrow \mathcal{F}_{k,m-1} \times ([2] \times [k]), \\ \Psi_{k,m} : \mathcal{F}_{k,m-1} \times ([2] \times [k]) &\rightarrow \Omega_{k,m}, \end{aligned}$$

which will be used in our remaining arguments.

Fix $(\mathbf{F}, c, \mathfrak{S}) \in \Omega_{k,m}$ and suppose that $\mathbf{F} = (F, H)$. It must be the case that F contains some element of column c , otherwise \mathfrak{S} would not exist. Thus, set $\{\mathfrak{S}\} = H \cap ([2] \times \{c\})$.

1. If $I[\text{opp}(\mathfrak{S}), \mathfrak{S}] \subseteq F$, then

$$\Phi_{k,m}(\mathbf{F}, c, \mathfrak{S}) \stackrel{\text{def}}{=} ((F - \text{opp}(\mathfrak{S}), H), \mathfrak{S}).$$

2. Otherwise, $I[\text{opp}(\mathfrak{S}), \mathfrak{S}] \not\subseteq F$, so define

$$\Phi_{k,m}(\mathbf{F}, c, \mathfrak{S}) \stackrel{\text{def}}{=} (\phi_{\mathfrak{S}}(\mathbf{F}), \mathfrak{S}),$$

where $\phi_{\mathfrak{S}}$ is the bijection from [Lemma 33](#).

Due to [Lemma 33](#), it is easy to see that $\Phi_{k,m}: \Omega_{k,m} \rightarrow \mathcal{J}_{k,m-1} \times ([2] \times [k])$ is well-defined.

Next, fix $(\mathbf{F}, \square) \in \mathcal{J}_{k,m-1} \times ([2] \times [k])$ and suppose that $\mathbf{F} = (F, H)$. Note that $e_F^-(\square) \notin F$ since $m-1 < 2k$. Suppose that $e_F^-(\square) = (r, c) \in [2] \times [k]$.

1. If $\text{opp}(e_F^-(\square)) \in F$ (and so $\text{opp}(e_F^-(\square)) \in H$), then

$$\Psi_{k,m}(\mathbf{F}, \square) \stackrel{\text{def}}{=} ((F + e_F^-(\square), H), c, \square).$$

2. Otherwise, $F \cap \text{Col}(e_F^-(\square)) = \emptyset$, so define

$$\Phi_{k,m}(\mathbf{F}, \square) \stackrel{\text{def}}{=} (\phi_{e_F^-(\square)}^{-1}(\mathbf{F}), c, \square),$$

where $\phi_{e_F^-(\square)}$ is the bijection from [Lemma 33](#).

Due to [Lemma 33](#), it is again easy to see that $\Psi_{k,m}: \mathcal{J}_{k,m-1} \times ([2] \times [k]) \rightarrow \Omega_{k,m}$ is well-defined.

Observe that for any $F \subseteq [2] \times [k]$ and any $\square_1, \square_2 \in [2] \times [k]$, we have $I[\square_1, \square_2] \subseteq F$ if and only if $e_{F-\square_1}^-(\square_2) = \square_1$. This observation along with [Lemma 33](#) implies:

Theorem 34. *For any integers k, m with $0 \leq m \leq 2k$, the maps $\Phi_{k,m}$ and $\Psi_{k,m}$ are inverses.*

Immediately, [Theorem 34](#) implies that $\Phi_{k,m}: \Omega_{k,m} \rightarrow \mathcal{J}_{k,m-1} \times ([2] \times [k])$ is a bijection whenever $0 \leq m \leq 2k$. Combining this fact with [eq. \(3\)](#), we immediately have:

Theorem 35. *For any integers k, m with $0 \leq m \leq 2k$,*

$$\sum_{c \in [k]} \sum_{\mathbf{F} \in \mathcal{J}_{k,m}} H(\mathbf{F}, c) = 2k \cdot |\mathcal{J}_{k,m-1}|.$$

By taking appropriate ‘‘slices’’ of $\Phi_{k,m}$ and $\Psi_{k,m}$, [Theorem 34](#) has another straightforward implication.

Lemma 36. *For any integers k, m with $0 \leq m \leq 2k-1$,*

$$|\{(F, H) \in \mathcal{J}_{k,m} : (1, k) \in F\}| = |\{(F, H) \in \mathcal{J}_{k,m-1} : (1, k) \notin F\}|$$

Proof. Define

$$\begin{aligned} \mathcal{A} &\stackrel{\text{def}}{=} \{((F, H), k, (1, k)) : (F, H) \in \mathcal{J}_{k,m}, (1, k) \in F\}, \quad \text{and} \\ \mathcal{B} &\stackrel{\text{def}}{=} \{((F, H), (1, k)) : (F, H) \in \mathcal{J}_{k,m-1}, (1, k) \notin F\}. \end{aligned}$$

To prove the lemma, it suffices to show that $|\mathcal{A}| = |\mathcal{B}|$. Observe that $\mathcal{A} \subseteq \Omega_{k,m}$ and that $\mathcal{B} \subseteq \mathcal{J}_{k,m-1} \times ([2] \times [k])$.

Now, fix any $(F, H) \in \mathcal{J}_{k,m}$ with $(1, k) \in F$. Since $m < 2k$, we know that $I[(2, k), (1, k)] \not\subseteq F$ and therefore $\Phi_{k,m}((F, H), k, (1, k)) \in \mathcal{B}$.

On the other hand, fix any $(F, H) \in \mathcal{J}_{k,m-1}$ with $(1, k) \notin F$. Then $e_F^-(1, k) = (1, k)$ and so $\Psi_{k,m}((F, H), (1, k)) \in \mathcal{A}$.

Therefore, $\Phi_{k,m}: \mathcal{A} \rightarrow \mathcal{B}$ and $\Psi_{k,m}: \mathcal{B} \rightarrow \mathcal{A}$, and so the claim follows from [Theorem 34](#). \square

We can now compute the total number of hatted-frog arrangements.

Theorem 37. *For any non-negative integers k, m ,*

$$|\mathcal{F}_{k,m}^{\blacktriangleleft}| = \sum_{i \geq 0} \binom{2k - 2i}{m - 2i}.$$

Before proceeding with the proof, we note that these same numbers have appeared in various other contexts; see [OEIS:A035317](#), [OEIS:A059259](#) and [OEIS:A059260](#).

Proof. For non-negative integers n, m , define

$$f(n, m) \stackrel{\text{def}}{=} \begin{cases} |\mathcal{F}_{k,m}^{\blacktriangleleft}|, & \text{if } n = 2k, \\ |\{(F, H) \in \mathcal{F}_{k+1,m}^{\blacktriangleleft} : (1, k+1) \notin F\}|, & \text{if } n = 2k + 1. \end{cases}$$

We will prove that

$$f(n, m) = \sum_{i \geq 0} \binom{n - 2i}{m - 2i}, \quad (4)$$

which will establish the claim since $f(2k, m) = |\mathcal{F}_{k,m}^{\blacktriangleleft}|$ for any non-negative integer k .

It is not difficult to see that $f(n, 0) = 1$ and $f(n, n) = \lfloor n/2 \rfloor + 1$ for any non-negative n . We will show that f additionally satisfies the recurrence

$$f(n, m) = f(n - 1, m) + f(n - 1, m - 1), \quad \text{whenever } 0 < m < n. \quad (5)$$

Since the same boundary conditions and recurrence is true of the numbers $\sum_{i \geq 0} \binom{n-2i}{m-2i}$, this will establish [eq. \(4\)](#) and conclude the proof.

If n is odd, say $n = 2k + 1$, then clearly

$$\{(F, H) \in \mathcal{F}_{k+1,m}^{\blacktriangleleft} : (1, k+1) \notin F\} = \mathcal{F}_{k,m}^{\blacktriangleleft} \sqcup \{(F + (2, k+1), H + (2, k+1)) : (F, H) \in \mathcal{F}_{k,m-1}^{\blacktriangleleft}\},$$

which establishes [eq. \(5\)](#) in this case.

Next, if n is even, say $n = 2k$, then

$$\mathcal{F}_{k,m}^{\blacktriangleleft} = \{(F, H) \in \mathcal{F}_{k,m}^{\blacktriangleleft} : (1, k) \notin F\} \sqcup \{(F, H) \in \mathcal{F}_{k,m}^{\blacktriangleleft} : (1, k) \in F\}.$$

The former set has size $f(n - 1, m)$ by definition, and the latter set has size $f(n - 1, m - 1)$ due to [Lemma 36](#) and so we have established [eq. \(5\)](#). \square

We finally end our journey by combining all of the prior results in this paper to deduce the speeds of the frogs in the frog dynamics associated with $W = 12 \cdots kk \cdots 21$:

Proof of Theorem 32. Recall that $W = 12 \cdots kk \cdots 21$, that $\Sigma \supseteq [k]$ is some alphabet and that $m \in [2k]$. Let π denote the stationary distribution of the (W, Σ) m -blind-frog dynamics; [Corollary 6](#) tells us that

$$\sum_{i=1}^m s_i = \mathbb{E}_{a \sim \Sigma} \mathbb{E}_{F \sim \pi} \mathbf{H}(F, a).$$

Now, due to the coupling in [Corollary 13](#) and the fact that the (k, Σ) m -hatted-frog dynamics admits a uniform stationary ([Theorem 14](#)), we know that

$$\begin{aligned} \mathbb{E}_{a \sim \Sigma} \mathbb{E}_{F \sim \pi_m} H(F, a) &= \mathbb{E}_{a \sim \Sigma} \mathbb{E}_{\mathbf{F} \sim \mathcal{F}_{k,m}} H(\mathbf{F}, a) = \frac{1}{|\Sigma| \cdot |\mathcal{F}_{k,m}|} \sum_{a \in \Sigma} \sum_{\mathbf{F} \in \mathcal{F}_{k,m}} H(\mathbf{F}, a) \\ &= \frac{1}{|\Sigma| \cdot |\mathcal{F}_{k,m}|} \sum_{a \in [k]} \sum_{\mathbf{F} \in \mathcal{F}_{k,m}} H(\mathbf{F}, a) = \frac{2k \cdot \sum_{j \geq 0} \binom{2k-2j}{m-1-2j}}{|\Sigma| \cdot \sum_{j \geq 0} \binom{2k-2j}{m-2j}}, \end{aligned}$$

where the final equality follows from [Theorems 35](#) and [37](#). □

Acknowledgments. The frog symbol is from *Froggy Font* (<https://www.dafont.com/froggy.font>) by Vladimir Nikolic. The lily pad symbol is based on a drawing by FrauBieneMaja (<https://pixabay.com/vectors/water-lily-lake-water-pond-blossom-4177686/>).

References

- [1] A. Aggarwal, M. Nicoletti, and L. Petrov. Colored interacting particle systems on the ring: Stationary measures from Yang–Baxter equation, 2023. [arXiv:2309.11865](#).
- [2] K. S. Alexander. The rate of convergence of the mean length of the longest common subsequence. *Ann. Appl. Probab.*, 4(4):1074–1082, 1994.
- [3] A. Ayyer and J. B. Martin. The inhomogeneous multispecies PushTASEP: Dynamics and symmetry, 2023. [arXiv:2310.09740](#).
- [4] B. Bukh and C. Cox. Periodic words, common subsequences and frogs. *The Annals of Applied Probability*, 32(2):1295–1332, 2022.
- [5] V. Chvátal and D. Sankoff. Longest common subsequences of two random sequences. *J. Appl. Probability*, 12:306–315, 1975.
- [6] M. Kiwi, M. Loeb, and J. Matoušek. Expected length of the longest common subsequence for large alphabets. *Adv. Math.*, 197(2):480–498, 2005.
- [7] G. S. Lueker. Improved bounds on the average length of longest common subsequences. *Journal of the ACM*, 56(3):1–38, May 2009.
- [8] H. Matzinger, J. Lember, and C. Durringer. Deviation from mean in sequence comparison with a periodic sequence. *ALEA Lat. Am. J. Probab. Math. Stat.*, 3:1–29, 2007.
- [9] A. Tiskin. The Chvátal–Sankoff problem: Understanding random string comparison through stochastic processes, 2022. [arXiv:2212.01582](#).