

Chronicles of jockeying in queuing systems

Anthony Kiggundu

German Research Center for Artificial Intelligence (DFKI)
Germany
anthony.kiggundu@dfki.de

Dennis Krummacker

German Research Center for Artificial Intelligence (DFKI)
Germany
dennis.krummacker@dfki.de

Bin Han*

University of Kaiserslautern (RPTU)
Germany
bin.han@rptu.de

Hans D. Schotten

University of Kaiserslautern (RPTU)
German Research Center for Artificial Intelligence (DFKI)
Germany
schotten@rptu.de;hans_dieter.schotten@dfki.de

Abstract

The relevance of studies in queuing theory in social systems has inspired its adoption in other mainstream technologies with its application in distributed and communication systems becoming an intense research domain. Considerable work has been done regarding the application of the impatient queuing phenomenon in distributed computing to achieve optimal resource sharing and allocation for performance improvement. Generally, there are two types of common impatient queuing behaviour that have been well studied, namely balking and reneging, respectively. In this survey, we are interested in the third type of impatience: jockeying, a phenomenon that draws origins from impatient customers switching from one queue to another.

This survey chronicles classical and latest efforts that labor to model and exploit the jockeying behaviour in queuing systems, with a special focus on those related to information and communication systems, especially in the context of Multi-Access Edge Computing. We comparatively summarize the reviewed literature regarding their methodologies, invoked models, and use cases.

CCS Concepts: • **Computing Methodologies** → **Parallel computing methodologies**; *Queuing Theory*; Jockeying.

Keywords: Queuing theory, impatience, jockeying, MEC, Markov decision process.

*B. Han is the corresponding author.

Permission to make digital or hard copies of all or part of this work for personal or classroom use is granted without fee provided that copies are not made or distributed for profit or commercial advantage and that copies bear this notice and the full citation on the first page. Copyrights for components of this work owned by others than ACM must be honored. Abstracting with credit is permitted. To copy otherwise, or republish, to post on servers or to redistribute to lists, requires prior specific permission and/or a fee. Request permissions from permissions@acm.org.

Submitted to CSUR, for peer review only, Jan. 06. 2023

© 2023 Association for Computing Machinery.

ACM ISBN 978-x-xxxx-xxxx-x/YY/MM. . \$15.00

<https://doi.org/10.1145/nnnnnnn.nnnnnnn>

ACM Reference Format:

Anthony Kiggundu, Bin Han, Dennis Krummacker, and Hans D. Schotten. 2023. Chronicles of jockeying in queuing systems. In *Proceedings of Submitted to CSUR*. ACM, New York, NY, USA, 29 pages. <https://doi.org/10.1145/nnnnnnn.nnnnnnn>

1 Introduction

Experts in operations research have been at the forefront regarding the exploration of queuing systems [5]. The studies are mostly concerned with understanding the overall system response to the dynamics introduced by the behaviour of the system users. As a special domain in the field of queuing theory, the impatience behaviour of queuing agents has attracted a significant attention of researchers. More specifically, it has been suggested that such behaviour can take the form of balking (a user chooses not to join the queue given the status of the system) [24], reneging (users join any of the queues and later leaving without getting processed) [6] or jockeying (users join any of the available queues but are permitted to switch from one to another).

Over the recent past, the latest development of information and communication technologies (ICT) have enabled numerous new use cases. Some of them, such as remote control, industrial automation, and autonomous driving, are challenging the legacy solutions to manage queues of data packets or computation tasks in ICT systems with their unprecedented stringent latency constraints and traffic dynamics. It is therefore worthwhile recognising the relevance of impatient queuing in communication or cloud computing systems in recent times and its applicability to resource allocation paradigms.

The ability for consumers to choose from different resource pools by jockeying amongst available queues ensures parallelism for maximum utilization of each service line, consequently enabling performance optimization. This preference was earlier on hindered by the homogeneous nature of preexisting communication setups where consumption was limited to specific vendor implementations given the prevalent lack of flexibility in the systems architectures. Recent developments in the Open Radio Access Network (O-RAN) community for Fifth Generation (5G) networks followed

by their evolution into the Sixth Generation (6G) suggest the introduction of programmable interfaces, virtualization technologies and intelligence to radio resource management allowing for fusion of functionalities of the control and distributed units from different vendors. It is suggested that the interleaving in the architectural design can be achieved from the abstraction of previously hardware-embedded control plane functions as software components (virtual network functions) that can be ported to distributed cloud computing platforms such that hardware resources can be provisioned to scale with usage or demand. The decoupling of this functionality from the hardware is envisaged to allow for the adoption of implementations that seek to address foreseeable shortcomings associated with real-time morphing of the Radio Access Network (RAN) in a multi-vendor environment to meet ever changing consumer or application requirements. The disintegration of the Baseband Unit (BBU) and Remote Radio Unit (RRU) to hierarchically form layers of specialized functionality is expected to revolutionize definitions for optimal resource consumption. The split in the lower and higher layers (fronthaul to backhaul) into independent units (like the Distributed Unit (DU), Control Unit (CU)) constituting other sub-units (like the Control Plane (CP), User Plane (UP)) abstracted as network functions with interfaces to one another can be assembled to form a chain of distributed software components that can characterize a slice in the network. An instantiation of the network slice then organizes into a logical end-to-end connectivity with specialised capabilities; a technique that deviates from the one-size-fits-all approach to instead dynamically organize resource consumption based on the underlying application scenarios and Service Level Agreements (SLA). It is this heterogeneity therefore, that Engineering enthusiasts envisage will bridge the gap between the dynamic behaviour of an impatient consumer and the challenges forthwith such that continuous evaluations of the resource usage profiles will be requisite for preference over slice configurations listed by different vendors. Depending on the resource requirements of any running service instance, the consumer will in essence weigh the choice for a resource pool in real-time whether to switch slice decks or not with the objective of minimizing costs and latency measures while maintaining optimal resources usage to suit the defined Quality of Service (QoS) requirements.

It is worthwhile to mention therefore, that analytical concepts from queuing theory like jockeying reveal the potential of their relevance given the extensive coverage in literature there is when modelling for similar behaviour in diverse domains ranging from manufacturing to biological processes. Existing empirical studies provide strong plausibility for the adoption of this concept in communication systems, especially in the context of resource sharing in cloud computing. Whether as multi-server or single server lines, the arrangement of these service lines adopts notations derived from

three factors $A/S/c$ as [33] earlier on tried to standardize the setups into categories defined by the rates of incoming events (A), time it took the events to be processed (S) and the number of channels available for processing (c). The categorizations formed the origins to acronyms like Markovian/ Markovian/ number of queues (M/M/C), General/ General/ number of queues (G/G/C), $Erlang_k$ / Phase-type Distribution/ queues (E/PH/C) etcetera, with each symbol in the octet denoting an associated distribution of the arrival times, service times and number of queues available respectively. The notations have been extended to include other descriptive queue properties like queuing discipline rules and the First Come First Server (FCFS) rule have been mostly adopted. Other service disciplines considered in literature are Last Come First Serve (LCFS) [31][39], Serve In Random Order (SIRO) [35], Priority queuing [56][57] was also introduced for scheduling time critical processing. It is assumed in most of the queuing theory documentations, that tenants join any of the queues following some frequency and the periodicity of these arrivals can be statistically expressed as probabilities over time. The probability of occurrence of such events has widely been modelled as a Poisson distribution [48] for mostly those events that tend to be independent of earlier events. However, there also exist experimental simulations that model this sequential arrival process as a Markovian chain [41] such that the probability of the next event happening is dependent on the preceding event. Also, because each new entry to the queues presents a task that must be processed in variation with the magnitude of the workload, it is prudent to assume that the rate at which each entry is processed is independent of any previous ones.

The behaviour of jockeying to the shorter queue has been approached by several researchers from different perspectives or methods with each method factoring in diverging aspects like when to jockey, constraints to jockeying, cost of jockeying and others extending the problems to performance measurements associated to this behavior. This paper seeks to explore the diversity and commonalities in the approaches used by each author with an in-depth look at how each approach seeks to characterize the solution to the dynamics that are associated with the behaviour of customer impatience in service lines. We classify the variance in methods used into four categories based on the similarities in perspective and then try to summarize the findings in a table in the later part of this documentation, given the multitude of existing literature that needs to be covered. The rest of this paper will therefore take the form of different sections each dedicated to literature that we found characterizes for a solution to the jockeying behaviour using related methodologies. We however try to refrain from most of mathematical proof of resultant equations employed while evaluating the underlying problem but where necessary highlight some theorems or lemmas followed to ascertain the final solution. We also try to arrange the literature chronologically in each

section to make the flow of the survey more comprehensive. The order of the sections will therefore start with a section about models that cover instantaneous jockeying behaviour where customers switch pools when the size of one resource pool lessens in comparison to another or based on some probability evaluations. The next section then looks at authors' work who formulate for the equilibrium conditions of different system descriptors under jockeying setups using matrix-geometric methods. We then dedicated a section specific to modern applications of queuing theory in communication systems like cloud compute networks. These newer frontiers introduce aspects of costs and benefits (like latency and performance) associated to a client moving from one service line to another. It was relevant to widen the scope a little bit though, to also briefly cover the literature that considers not only one customers jockeying from one service queue to another but batch workloads being transferred given the priorities associated to the processing of those jobs. We finally discuss the multiple approaches in summary to provide an overall picture of the relevance of such a documentation to multi-access edge computing but let us first briefly expound on what the reader should expect from each of the sections.

1.1 Categories of jockeying models

As a preamble about classification of the models covered in this documentation, we briefly describe in this sections what is specific about each category of models to make it easier to find the commonalities and deviations in approaches for any prospective reader.

The first section covers that class of pioneer models that formulated for system equilibrium solutions starting with the simplest queue setups of just two queues under the assumption that each queue processed clients at the same rate. In this category, the switching from one queue to another was either instantaneous when the size of one of two queues was shorter by a difference of one to ensure jockeys were always to the shorter queue or based on probabilistic measures on the rates at which the queue sizes varied. The techniques deployed for the evaluation of the stable conditions of the queue sizes although varied.

It would be proposed later on that jockeying when the size of the queues exceeded one did not guarantee optimal utilization of the systems. The class of matrix-geometric models took the derivations to another level in that jockeying from one lane to another was no longer conditioned on the deviation between the queue sizes and the setups became more generalized to more than two queues. We therefore grouped into one section this class of approaches that characterized for the steady-state behaviour of the queues building on earlier findings about modeling stochastic processes using matrix-geometric techniques. The techniques basically analyzed to generalize for how the individual queues changed states and it is these states that composed for the state transition matrices. The way this transition state space matrix is

partitioned coupled with the associated matrix representation for the rates at which the queue states changes forms the basis for the solution of the equilibrium conditions. It would from there on become interesting for researchers to factor in more queue parameters when evaluating for the performance measures of the entire system.

There is a class of models that elevate the analytic evaluations of the morphing of the queuing systems to a commercial level as the applications of such systems spread to other domains like in communication systems. These category of models relate their derivations to the overall costs associated to consuming resources that are tenant has to pay and therefore timing becomes a very important factor since the costing is based on how much time the tenant spends in the systems before they get processed. Here each action is associated to a cost and it becomes so vital for the consumer to critically weigh options before making the choice for a given behaviour. While the objective of the aforementioned two classes of models is minimizing the time a client will spend waiting until they get served, the cost-benefit models complicate the solutions because not only is the objective to minimize the waiting time but also to formulate for policies that seek to minimize the overall accumulated costs. The complexity of the optimal solution is due to the variety of system descriptors and actions that need to be considered before or during the life-cycle of the system access.

It had always been assumed in most literature that the behaviour of switching lanes was restricted to single moves at a time but as more queue discipline rules like prioritization of some consumers over others were proposed, jockeying models that derived expressions for when it was optimal to move what bulk of workload and to which appropriate lane started to become prevalent. We found it necessary to document in a separate section a class of jockeying models where more than one customer could switch from one lane to another simultaneously due to competition or controlled bulk transfers of workload to meet predefined needs. This class of models owe their relevance to their practicability in economic and behavioural sense as service providers have more leverage and control, synonymous to classification of consumers based on financial capabilities. This class of models relates well to communication systems given the fact that some applications have more resource intensive and latency criticality requirements than others.

2 Instantaneous jockeying models

The behavior of customers in multiple server queuing system [34] has received diverse consideration with authors providing derivations for equilibrium conditions for varying systems descriptors with the objective to realise optimal performance and utilization within the systems. We highlight here some of the different queue setups that have been

investigated, sometimes assuming conditions like the consumers continuously being provided with information about the queue status to influence the choice for one service line over another and with some restrictions on moving from one to another.

Preliminary findings to model for the behaviour of impatient consumers when queuing up for resources can be traced back to a paper by [23], in which a simple setup with only two service lines (one "near" and the other "far" whose sizes were denoted by $X(t)$, $X'(t)$ respectively at time t) was assumed and new customers were allowed to join the shorter line or switch to the alternative one when deemed beneficial. The author analysed cases two of customers arriving to stations following a Poisson distribution at rate λ . The customer had the choice to stay in a given queue operating at Poisson distributed service rate μ_i ($i = 1, 2$) or jockey to another. The objective was to formulate expressions for steady state conditions in infinite time space. The authors first considered for the scenario when no jockeying was allowed such that for each change in state given any action (like a new arrival, exit or both actions happening concurrently in either service lines at a given time), expressions for the rate of change in the queue sizes $\frac{\delta p_{xy}(t)}{\delta t}$ were first derived. The formulation then expressed for $p_{xy}(t)$ as $t \rightarrow \infty$ (where $p_{xy}(t) = Pr\{X(t) = x, X'(t) = y\}$) to yield the bi-variate generating representation as a product over state space changes $s^x s'^y$ and a subsequent summation over this product to denote for the generating function (Equation 1). Partial derivations of this generating function were then evaluated under variations in queue states ($(s = s' = 0)$, $(s = 1, s' = 0)$, $(s = 0, s' = 1)$, $(s = s_i = 1)$) for each of these activities.

$$\Phi(s, s') = \sum_x \sum_y P_{xy} S^x S'^y \quad (1)$$

The distributions of the sizes for each queue were also formulated for from the representational difference equations, then expressions that related the averages of queues sizes defined and the overall system occupancy shown to be defined by Equation 2.

$$\sum \max(x, y) p_{xy} = \frac{m - m_0}{\rho'} + \frac{m' - m'_0}{\rho} \quad (2)$$

where $m = \sum_x x p_x = \Sigma[X(\infty)]$ and $m' = \sum_y y p_y = \Sigma[X'(\infty)]$ denoted the expectation of a given queue size in infinite time. ρ' and ρ were the traffic intensities of the far and near queues respectively

The paper concluded with the proof for stability conditions of the queue lengths when customers needed to switch from one line to another. The switching happened when the queue sizes varied by one (hence the states $x - 1, x$ or x, x or $x, x - 1$) and this was always from the longer to the shorter line. Equations 3, 4, 5 showed the solutions for the equilibrium conditions in each of the states in terms of π (the probability

that both queues were not occupied).

$$p_{xx} = \alpha \lambda L \beta^{2x} \pi \quad (x > 0), \quad (3)$$

$$p_{x-1,x} = \lambda \mu L \beta^{2x} \pi \quad (x > 1), \quad (4)$$

$$p_{x,x-1} = K L \beta^{2x} \pi \quad (x > 1), \quad (5)$$

where

$$\pi = \frac{(1-\beta^2)(\alpha+\lambda)}{(\alpha+\lambda)(1+\rho-\beta^2)+\lambda\rho'(1+\rho)}, \quad \beta = \frac{\lambda}{\mu+\mu'}, \quad \alpha = (\lambda + \mu + \mu')$$

$$K = \lambda\mu' + (\mu + \mu')^2, \quad L = \frac{(1+\rho')(\mu+\mu')^2}{\alpha(\alpha+\lambda)\lambda\mu}$$

It was also shown how the probabilities for the queues sizes and the moments of the queue lengths distribution when jockeying was allowed could be derived from these difference equations.

[36] would later on conduct more concrete studies that compared queue setups and rules where tenants could instantaneously jockey given some threshold on queue length difference or jockeying based on some probability computations. The queue setups compared were therein referred to as the "Tellers' Window", "Tellers' Windows with Jockeying" and the "Maitre d' Hotel". The heterogeneity in system setups was captivating for the author to not only better assess the impact of jockeying on the processing capacity of the system [22] but to statistically model equilibrium probabilities for the average waiting times. The decision to move from one service line to another either was made immediately when the size of the adjacent queue was shorter by one or given a certain probability based on how the differences in sizes of the queue changed. Figure 1 showed the heterogeneous setups of queues (also referred to as strategies), each associated with a set of behavioural rules for the customers.

In this document however, we will talk about variations in the "Tellers' Windows with Jockeying" setup (Figure 1C) to restrict the discourse of this work to the jockeying behaviour. Under this customer strategy, new arrivals were queued to the end of the shorter line and could move to the other queue when the difference between the two queues exceeded one (instantaneous strategy) or based on the rate ($k(w_i - w_j)$) (w_i, w_j as queue sizes) at which the queues varied in size (probability strategy).

In the case of probabilistic jockeying, the structure of the generator function $g_r(\xi)$ and the evaluations for the steady state conditions revealed that the behaviour of the system was the same as the setup where customers simply joined the shortest queue and never left until the end of service ("Teller's Window"). For the instantaneous jockeying, equations were derived under the three presumed occupancy state categories (n, n) , $(n + 1, n)$ and $(n, n + 1)$ that restricted jockeying within the system to the shorter line always (where n was the average number of occupants in a given queue). Expressions that denoted the predicted size of each queue were shown to evolve from the sequence of simultaneous equations representational of the state transitions. Equation 6 defined for the queue's performance capacity in terms of

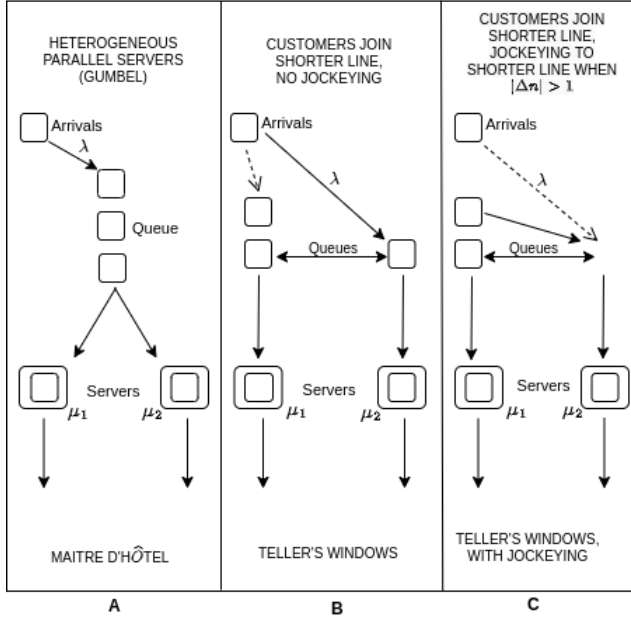

Figure 1. Jockeying strategies: In the left-most (A) of the illustration is the Maitre d'Hotel queuing strategy where customers waited in a single line and got served when one of the available stations was empty. In the middle (B) is the Tellers' Window strategy where customers joined and waited in the shorter of the two queues and no switching lines was permitted thereafter. In the right-most (C) was the Tellers' Window with Jockeying, a behaviour where despite a new customer having joined the shorter of the two queues, switching to an alternative one was permitted later given a deviation in the sizes by one.

the number of customers that the queue processed could be computed.

$$r_i = \frac{\mu_i(\lambda - \mu_i)\rho(1 - \rho)}{(\lambda_2 + 2\mu_1\mu_2\rho(1 - \rho))} \quad (6)$$

ρ was the traffic intensity of a given queue, $\mu_i, \lambda_i; i = 1, 2, \dots$ were the arrival and service rates of any queue i respectively. The documentation analysed more complicated jockeying behavior where the switching within queues was not restricted to only the shorter line but also the possibility to stay in the longer line. For example, the "Lane Changing" strategy (setup) did not guarantee jockeying to the shorter queue but switching was based on rate at which the two service lines differed with probability $(1 - e^{-(k_i(w_i - w_j)t)})$. But it however observed that under this setup, the number of customers that wanted to jockey grew exponentially and that equilibrium conditions were a factor of only λ , ($\lambda = \lambda_1 + \lambda_2$) and not $\lambda_i, i = 1, 2$. In addition to that, it was noted that some of these strategies led to states where one service line was empty while the other had customers queuing up, states in which queue utilization was compromised. Another interesting customer flow "Route changing" was presented where

jockeying was probabilistic, depending on how dissatisfied a customer was being at a certain position in the queue. This was given the fact that customer had no access to queue status information and Equation 7 computed for this probability at a time t .

$$0, \quad n_i = 0 \\ 1 - e^{-k_i(n_i-1)t}; \quad n_i \geq 1 \quad (7)$$

where n_i was the number of users in queue i

It was proven how expressions for equilibrium conditions could be formulated from the transition equations, for the average queue occupancy, the expected number of customers processed and the probability that the a queue was not occupied. The work finally presented results from the numerical studies that involved experimentation with varying queue parameters under the aforementioned strategies (setups) and shared insights into the queues' performance and quantitative measures on certain queue descriptors.

It would later be revealed that using the generating function to formulate the steady-state solution to the behaviour of instantaneous switching of service lines was not the only approach to the problem. [15] showed that a closed form solution for some queue descriptors like queue length could be derived from inversion operations on the representational state space matrix. The authors differed in methodology to reason that the underlying Markov process could be modelled using a transition diagram to capture the state changes as illustrated by Figure 2. It was proposed that, the equivalent coefficient matrix to the equilibrium equations that defined the transition state space was constituent of the regularity property and it was from this property that the solution evolved. Customers that joined the M/M/r queue system were governed by different rules both at admission (like which queue to join based on probabilities or queue size) and in cases of switching queues (say $n_1 - n_2 \geq 2$). The proof followed from the definitions of matrices that underpinned the transitions in state (Λ_0, Λ_n) . The constituent sub-matrices were then partitioned $(\Lambda_{0i}, \Lambda_{ni}, i = 0, 1, \dots, r)$ to characterize the coefficient matrix $(\Lambda P = 0, \text{ where } P \text{ was a column vector that denoted probabilities that a queue was in a given state.})$. It was argued therefore that the solution depended on choosing the proper sub-divisions. Equation 8 defined for such a matrix of sub-matrices in the case of $r = 2$ (under the assertion that the number of servers did not affect the formation of the coefficient matrix) and this composition formed the basis for derivation of expressions for the equilibrium conditions of the queue sizes.

$$\Lambda = \begin{bmatrix} \Lambda_{01} & \Lambda_{02} & 0 & 0 & 0 & 0 & \dots \\ 0 & \Lambda_{11} & \Lambda_{12} & 0 & 0 & 0 & \dots \\ 0 & \Lambda_{21} & \Lambda_{22} & 0 & 0 & 0 & \dots \\ 0 & 0 & 0 & \Lambda_{31} & \Lambda_{32} & 0 & \dots \\ \cdot & & & & & & \dots \end{bmatrix} \quad (8)$$

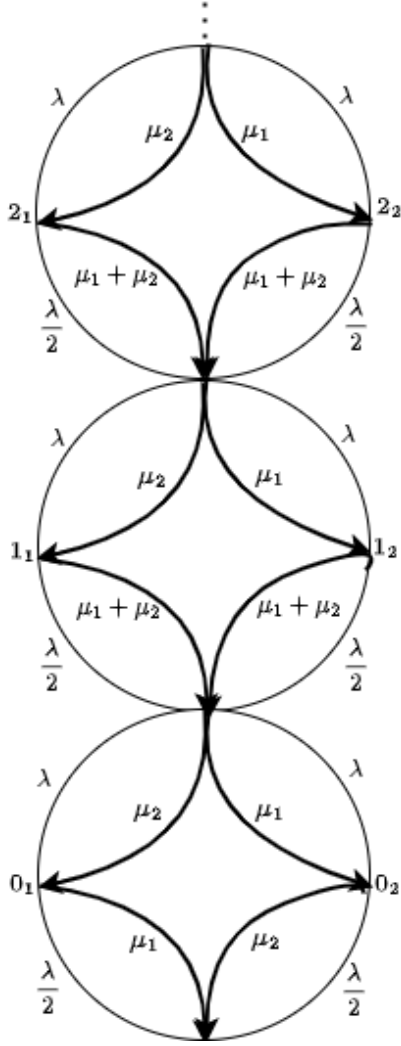

Figure 2. A depiction for the possible states that a two server setup with threshold jockeying could traverse from which the authors derived for the systems equilibrium equations.

The matrices of varying dimensions were defined and elements partitioned into vectors to characterize specific queue state probabilities. This iterative technique was followed by an inversion of each matrix (Λ_{n_2} and Λ_{0_2}) to yield expressions for the closed form solution of all state probabilities. These equations were verified using an example for the case when $r = 2$ and it was shown that they correlated with findings by previous researchers [22] [23]. The work further highlighted interesting behaviour in the queue given the variations in queue setups; say the case where a customer had to decide which service line to switch to in the case of a service being completed while at the same time two lines were equal in size. It was shown how the preference for which line to switch to could be a factor of the distance ($n_i - n_k \geq 2$; i, k were queues) the jockey candidate had to

traverse to the alternative queue. It was also shown how a closed form solution could exist in scenarios where the coefficient matrix was dependent on the number of customers in a queue.

Findings from [15] inspired further exploratory work where [17] not only sought to formulate a general solution for the stability conditions of certain queue descriptors but also modelling how queue parameters like time-until-service and how often newcomers arrived in the system influenced the jockeying behaviour. Here, to switch to any shorter line was preconditioned on the size of any two of r queues differing by two and a different technique for the partitioning of the state space transitions into sub-matrices was utilized. The overall behavior of $M/M/r$ (with a restriction on the maximum capacity of the queues) systems when switching of queues was permitted versus when no switching was allowed was observed and performance measures were documented. The dynamics of switching queues was studied in two models; the first model provided expressions that characterized the stability conditions and transition probabilities for an $M/M/3$ setup from the representational differential equations (which were simply probabilities that a given queue was in a certain state). Analytically, these differential equations were generalised as $AP = 0$ such that A denoted an $n(r^2 - 1) + 1$ sized matrix whose elements corresponded to the measure (coefficient) of the state probabilities, vector P denoted the actual probabilities that a given queue was in a certain state and 0 was a vector that constituted non-zero elements. It was this matrix A that was sub-divided into a series of other column vectors and sub-matrices of varying dimensions then by applying boundary constraints to the generalised equation, expressions that evaluated for the probabilities of the queue being a given state were formulated. To characterize for the transitions in state spaces then followed from the definition of other generalizations of the embedded dynamics (Equations 9 and 10).

$$AP(t) = P'(t), \tag{9}$$

$$IP(t) = 1 \tag{10}$$

given $P(t)$ as a vector constituting probabilities of being in a given state at a certain time while $P'(t)$ was a vector denoting the rate at which the probabilities of being in a given state changed.

The solution for the above equations then followed from applying initial constraints and subsequently partitioning of matrix A into sub-matrices to redefine the equations. The resultant expressions could however not be resolved for analytically, hence the need of a numerical solution for the transient state probabilities. The second model then analysed the queue dynamics under the jockeying behaviour where the queue parameters like the arrival λ , the service μ rates (defined by Equations 11,12 and 13) and system utilization ρ were a factor of the state of the a given queue; hence

the variation in the representative matrix A and magnitudes of the state probabilities.

$$(\mu)_j = k^0 \mu_j, \quad k = 1, 2, \dots, N/r; \quad j = 1, 2, \dots, r \quad (11)$$

$$\lambda_n = \lambda_0 \quad \text{for } m = 0, 1, 2, \dots, r - 1, \quad (12)$$

$$\lambda_n = \left(\frac{r}{m+1}\right) \beta \lambda_0 \quad \text{for } m = r, r+1, \dots, N-1. \quad (13)$$

where N as a restriction on capacity of the system, β was a measure of the effect of the system rate on the arrival rate, λ_n the rate at which new customers joined the queue given n customers in that queue and $\mu_j (j = 1, 2, \dots, r)$ as the service rate of a given queue. The performance of the queues was evaluated to ascertain the significance of switching or not switching from one queue to another on the waiting time under increasing system utilization. The results revealed that the time a customer had to wait before being processed was greater when jockeying was not allowed compared to when the behaviour was permitted. Also there was a higher probability of the queues staying idle under the non-jockeying setup. Other evaluations for performance measures like the predicted system occupancy under varying degrees of the system utilization or the state dependent queue parameters over time were documented. The findings correlated with previous suggestions from similar investigations [15] about the relevance of switching service lines to the overall improvement of system performance.

[60] caused case for contention about the approaches used by researchers in most of the above reviewed findings, arguing that besides the solutions being repetitive, they yielded no equations that evaluated for the boundary probabilities. Their analytic solution for the equilibrium probabilities drew its origins from similarities to the M/M/n model. The researchers' findings also intended to unravel some hidden dependencies between the transition rate matrix R and the overall queue utilization. The dynamics in the model required that new customers whose flow tended to a Poisson distribution at rate λ were queued to the shorter server in an M/M/n ($n \geq 2$) setup of n servers. Each server processed jobs at Identical and Independently Distributed (IID) rates $\mu_1, \mu_2, \dots, \mu_n$. Switching from one server to another was instantaneous (one of the servers n differing in size by a unit relative to any of the queues). Equation 14 defined existence of stability conditions of the stochastic process $\{(X_1(t), X_2(t), \dots, X_n(t)), t \geq 0\}$ that denoted the changes $(S = \{\vec{i} = (i_1, \dots, i_n | i_i \geq 0) \text{ for } 1 \leq j \leq n\})$ and $|i_k - i_l| \leq 1$ in the server sizes over infinite time as a factor of the traffic intensity ($\rho = \frac{\lambda}{\mu} < 1$).

$$p_{\vec{i}} = \lim_{n \rightarrow \infty} P_{\vec{i}}(t), \quad \vec{i} \in S, \quad (14)$$

where k and l were the number of customers in given states. The generator matrix Q (Equation 16) and its partitions (submatrices A_{ij} with varying dimensions) resulted from arranging the state space based on a function (Equation 15 for

example shows this ordering for the two state transitions i and j) that defined which state came prior to or after another such that if $Or(m_0) < 0$ then \vec{i} came before \vec{j} , else otherwise.

$$Or(m) = \sum_{t=m}^n (i_t - j_t) \quad (15)$$

$$Q = \begin{bmatrix} [-\Lambda] & \Lambda_{02} & 0 & 0 & 0 & 0 & \dots \\ A_{10} & A_{11} & A_0 & 0 & 0 & 0 & \dots \\ & A_2 & A_1 & A_0 & 0 & 0 & \dots \\ & & & A_2 & A_1 & A_0 & \dots \\ & & & & \cdot & \cdot & \dots \\ & & & & \cdot & \cdot & \dots \\ & & & & \cdot & \cdot & \dots \\ \cdot & & & & & & \dots \end{bmatrix} \quad (16)$$

The $\vec{p}_i, i \geq 1$ distributions were said to each constitute $2^n - 1$ elements as states that formed a block i with P_0, \vec{p}_1 as the bounds. The proof for the solution adopted mathematical techniques (separation of variables plus differential equations calculus)[44][7] for the derivation of the equilibrium probabilities as a factor of the traffic intensity ρ . Taking the case of $i \geq 2$ (therefore only interested in the $2^n - 2$ probabilities in \vec{p}_2 since the bounds were known), it was shown that a solution only existed under steady conditions defined by Equation 17 only when $\det(A_0 + A_1 \omega + A_2 \omega^2) = 0$, $0 < |\omega| < 1$ (where $\omega = \rho^n$). And it was proven through a couple of theorems (which theorized that the eigenvalue(s) $r_2^n - 1$ of the rate matrix R as the lone zero(s) in the determinant) that ρ^n was the only quantity that held true under this conditionality.

$$\vec{p}_{i+1} = \vec{p}_2 \omega^{i-1}, \quad i \geq 1 \quad (17)$$

Then taking the case of n servers, to show that ρ^n was the lone zero in the determinant above, a new chain for the stochastic process $(\vec{S} = \{(i_1, i_2, \dots, i_n) | i_t = 0 \text{ or } 1, 1 \leq t \leq n\} \cup \{m | m > n\})$ consisting of 2^n states was defined and the associated transition state infinitesimal generator matrix \bar{Q} constructed. Most $(2^n - 1)$ of the columns in both generator matrices (Q and \bar{Q}) were similar except for some few states (for which a specific generator matrix was formulated), then relationships were formed between the respective equilibrium probabilities of both processes. The proof showed that for any server k in the server deck n , $(\frac{p^n}{\omega})_i = \text{constant}, i \geq 1$ if and only if $\rho^n = \omega$ (ω as the only real solution of the determinant).

These theorems were a basis for evaluating for the boundary and equilibrium probabilities of $p(i_1, \dots, i_n), \vec{p}_{i+1}$ (for block $i+1$) and \vec{p}_2 to yield a relation between the rate matrix and the equilibrium probabilities. Expressions denoting measures for the predicted average system occupancy and the time spent in the system until service completion followed from these derivations and the application of Little's Law $W = \frac{E}{\lambda}$ (where E was the expected system occupancy). The paper

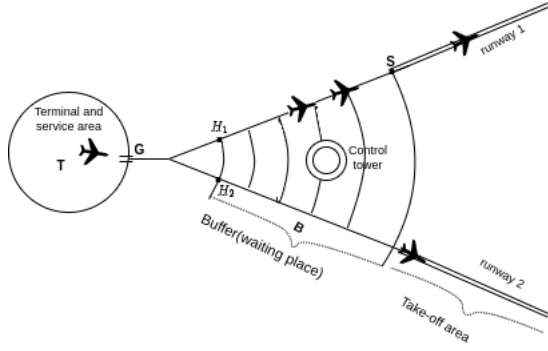

Figure 3. An example of the runway scene with planes accessing runways in queues

then shared results from the numerical analysis under varying configurations of the system descriptors to verify the formulations.

3 Models that use the matrix-geometric approach

The matrix-geometric approach owes its origins to pioneer studies of stochastic processes by [47] and from then on, research for solutions to stationary probability distributions of chain processes that do not change over a long period of time, attracted attention. The shortest queue problem is one area where this approach was earlier on the basis for expressing for the stationary probability vectors of queuing systems study by [20]. Here, interest was directed to a simple M/M/2 queuing system where the service consumers made choices for a service line based on the apparent size of two queues with preferences to the smaller in length of either lines. The study simulated an airport setup with planes that accessed runways (queues) following a Poisson distribution λ and exponentially distributed service times μ for each runway. Figure 3 depicted as a real scenario of such queuing systems with planes waiting before take-off. The continuous-time Markov chain representation of the state transitions for all the dynamics within such a system took the form of an infinitesimal generator matrix Q (Equation 18) with sub-matrices (A_0, A_1, A_2 and B_0) that inherently encoded state transitions.

$$Q = \begin{bmatrix} B_0 & A_0 & 0 & 0 & 0 & \dots \\ A_2 & A_1 & A_0 & 0 & \dots & \\ 0 & A_2 & A_1 & A_0 & 0 & \dots \\ 0 & 0 & A_2 & A_1 & A_0 & 0 \dots \\ \cdot & & & & & \\ \cdot & & & & & \end{bmatrix} \quad (18)$$

Ideally, it was suggested that completing a service in either queue and a jockey to a shorter queue summed to a total

transition rate of 2μ . And this also altered the dimensions of the sub-matrices that composed the generator matrix Q . For that, a non-negative rate matrix R that represented the rates at which states changed was defined and subsequent evaluations led to the solution for the stationary probability vectors $\pi = (\pi_1, \dots, \pi_n)$ being formulated. It was then shown how the proof for the necessary steady state conditions of the stochastic process existed only if $\lambda < 2\mu$. This was premised on the proposition ([20], proposition 1) that the underlying process to such dynamics inherently possessed conditions or there was a probability that certain queue states (i, j) in the process were revisited in finite time (positive recurrence [47]). And the stationary probability vectors were verified to exist under the steady conditions $\lambda < 2\mu$.

The author provided results from some numerical experiments with variations in parameter settings for how busy the queue was ρ and n ($n = 5, n = 10, n = 15 \dots$). It was conclusively suggested that as the threshold n increased ($10 < n < \infty$), differences in stationary probability vectors became negligible. The experiments also provided computations for some queue statistics like the means of individual queue lengths, mean waiting time and reaffirmed findings that systems with jockeying permitted performed better than those where the behaviour was prohibited.

Using the matrix-geometric approach to evaluate for stationary probability vectors for the stochastic chain of events was extended to an M/M/C queue by [32]. It was shown that from manipulating the structure of the generator matrix emanated a more reliable approach for ascertaining the stationary probability vectors. This followed the author's counter arguments about the methods used when partitioning the state space by [17], hence suggestions for an alternative solution. The study further computed for some underlying dynamics like the statistical distributions of the mean waiting time and other performance measures.

The setup assumed multiple servers with an infinite number of tenants that arrived following a Poisson distribution λ and each server processed tenants at rates μ that were exponentially distributed. New arrivals joined the shortest queue but if queues were equal in length they joined either queues with the same probability while jockeying was allowed only when the difference in queue sizes was two (jockeying threshold $n = 2$). The representations of such a Quasi-Birth-Death (QBD) process was an infinitesimal generator matrix Q composed of sub-matrices to denote the state transitions of the queue lengths like: $\{(0, 0, 0)\}$,

$\{(1, 0, 0), (0, 1, 0), (0, 0, 1), (1, 1, 0), (1, 0, 1), (0, 1, 1), (1, 1, 1)\}$,
 $\{(2, 1, 1), (1, 2, 1), (1, 1, 2), (2, 2, 1), (2, 1, 2), (1, 2, 2), (2, 2, 2)\}$,
 $\{(3, 2, 2), (2, 3, 2), (2, 2, 3), (3, 3, 2), (3, 2, 3), (2, 3, 3), (3, 3, 3)\}$,
 $\{(4, 3, 3), (3, 4, 3), (3, 3, 4), (4, 4, 3), (4, 3, 4), (3, 4, 4), (4, 4, 4)\}$

The work built on earlier findings in which the generator matrix [15], [47] for such QBD processes had been constituted but introduced slight modifications to the structure

of the stationary probability vectors. It was proposed that the boundary conditions required a special extension of the vectors, hence a new expression for the rate matrix. The proof applied previous theorems (theorem 3 [21]) such that the iterative evaluations culminated into an expression for the rate matrix R . Extensions were also done to [50]'s work, introducing the argument that because the structure of the infinitesimal generator matrix exhibited likelihood of boundaries state being revisited, there was need for new evaluations of the average size L of the queue. Premised on the existence of an absorbing state θ (a state when a new arrival got processed immediately) as part of the state space of the underlying QBD, expressions for the stationary waiting time probabilities were also derived. The re-partitioning of the representative infinitesimal generator matrix followed by the relevant proofs morphed into formulations for $W(\cdot)$ as the Laplace Transform $w(s)$ and the corresponding closed-formulation for the average time taken before being processed. The authors additionally showed how application of randomization methods could yield for the characterization of the stationary waiting time probabilities $W(t)$ for QBD processes. The proof assumed that given a statistical initial state denoted as a vector z there existed an n^{th} transition step of the stochastic process such that the queue was idle (state θ). The numerical analysis initialized a few system parameters to compute for some properties of rate matrix, the average queue occupancy L and Little's Law as the basis for the arithmetic computation of other descriptors.

As they attracted more recognition, matrix-geometric techniques to formulate solutions for steady state condition in an M/M/C service line setup with threshold jockeying were also the subject of a documentation by [1]. New customers made choices from the available service lines amongst the least occupied and had the option of moving from one queue to another with priority given to a service line that was completing a job.

To evaluate for the queue size equilibrium probabilities would then necessitate the partitioning of the state space using the transition rate matrix. In contrast to earlier suggestions [20] [59] that a solution for the steady state could not be achieved when the number of queues C exceeded 2, it was proven by the author that the solution lay within the state transition space sub-division method used. It was argued therein that, although ergodic conditions could be derived from the sub-division of these state spaces, the solution did not evaluate for the rate matrix hence the need for revisiting the state space splitting approach. For the proof therefore, sets of sub-levels were defined to map to sets of states and splitting was based on these sub-levels. The splitting was a factor of whether a sub-level's behavior was regular ($l = T, T + 1, \dots$) or otherwise ($1, \dots, T - 1$), l being a collection of state and T the jockeying threshold. The authors showed that the condition

for ergodicity was only possible when the system utilisation $\rho < 1$. Then by applying an earlier theorem [47](1.7.1) to the resultant Markovian generator matrix Q , statistical equilibrium was possible.

After categorizing based on sub-levels, the generator matrix Q took a different form that was irreducible but this was solved with the same theorem [47](1.7.1). The stationary vectors were similarly split along categories with respect to the sub-levels to obtain a mapping from stationary probability vectors to sub-levels using the Equations 19 and 20.

$$p_l = P_T R^{l-T}, l < T \quad (19)$$

$$D_0 + RD_1 + R^2 D_2 = 0 \quad (20)$$

where D_0, D_1 and D_2 denoted square sub-matrices constituting states at all sub-levels $\geq T$ and p_l or p_T as stable probability vectors corresponding to the level l (bound on T) that resulted from the split of the stable probability vector p . Because one of the sub-matrices in the generator Q took different dimensions due to the constituent states in the sub-level set, it was shown how given this difference in structure, a solution for the rate matrix (R) could be expressed. The evaluation derived its reference from suggestions by [50] that by ascertaining the maximum eigenvalue of rate matrix, one could easily express for the solution of R using Equation 21:

$$R = \begin{pmatrix} 0 \\ w \end{pmatrix} \quad (21)$$

where $w = -v(D_1 + \rho^c D_2)^{-1}$, ($w = w_0, \dots, w_{m-1}$), m being number of states at a given level that defined the dimension of the square sub-matrices. c was the number of queues available

It is plausible and indeed as earlier suggested [36] that when modelling queuing systems, the assumption that any two or more service lines could operate at equivalent service rates does not relate well with real environments as it is usually the case that each line inherently operates under different parameter settings, just like is the case of a service counter being operated by a human. [3] analysed the behaviour of two queues (M/M/2) each with a different service rate to derive expressions for sizes of the queues under stable conditions.

New customers joined the shorter of either queues (or based on a probability if the sizes of the two queues were equal) and it was allowed to switch from a longer to shorter one given some jockeying threshold T . The authors proved that when the size of the larger line exceeded the jockeying threshold, because of the unique formation at the boundaries, the formulation of the solution was the product of the stationary probabilities of each service line. Hence that given the appropriate sub-division of the state space, the matrix-geometric method yielded the same solution. The dynamics of the queue sizes m, n was modelled as a continuous-time Markov chain and the rates at which the changes in the sizes of queues occurred given task completions and new admissions was illustrated by Figure 4. The proof built on the authors' earlier

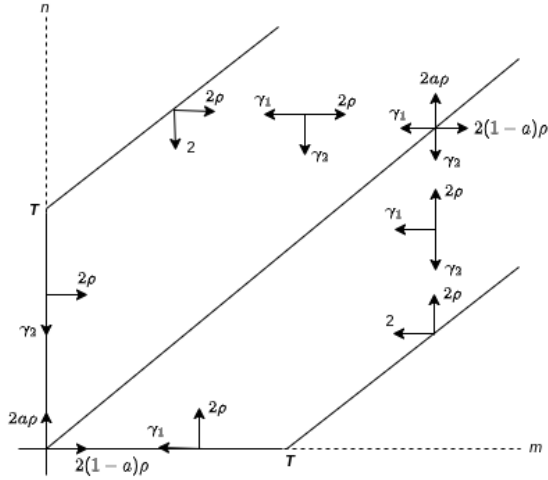

Figure 4. The transitions in states for the different queues over time given actions of service completions and new admissions

findings [4] [2] where it was shown that with no jockeying allowed between the queues, the equilibrium probabilities ($p_{m,n}$) of the queue sizes conformed to product-form solutions in infinite time and therefore numerical evaluations under set parameter configurations were done to validate whether the same was true when jockeying was permitted. It was found that the evaluation held true only for a defined portion $Q(\max(m, n) > T$ and (T, T)) of states and observing the rates of change in state of the stochastic process for only this portion of states conclusively categorized the process as irreducible. This necessitated the analysis of this portion of states as a separate process (with distribution $q_{m,n}$) with a relation to the main process denoted by $p_{m,n} = q_{m,n}P(Q)$ (where $P(Q)$ was the probability that the portion Q included the main process).

The product-form solution was derived from the notion of defining a set of metrics that were a factor of the arrival rate, the service rate of the shorter queue and the queue admission probability (specifically in case the two queues were of the same size) for which $l > T$ (l as the length of the longer line). The general purpose principle was the basis for the derivation of equations that resolved for these metrics and this system of equations characterized the steady-state and ergodicity conditions for the portion of states Q . The work sought to also draw comparisons between the product-form solution and the one ascertained using the matrix-geometric technique. For the geometric solution, the generator matrix emanated from sub-division of the steady-state probability vector into sub-levels that grouped states depending on the size l of the longer queue ($l < T$ and $l \geq T$) and associating each of these sub-levels to a steady-state probability vector \vec{p}_l . Since some of sub-matrices (A_0, A_1, A_2) in the generator

matrix G were irreducible, using existing theorems for ergodicity conditions [47] (Theorem 1.7.1, 1.7.11), \vec{p}_l when $l > T$ was ascertained from $\vec{p}_l = \vec{p}_T R^{l-T}$ (by taking the unique structural properties of A_0 to compute for R from $A_0 + RA_1 + R^2A_2 = 0$ given knowledge of R 's maximum eigenvalue). The the matrix-geometric formulation was found to bear similarities to the product-form solution.

More work on an M/M/2 queuing system was pursued by [55], this time around with a condition that a cap was placed on the maximum number of customers L that were allowed in the entire system and customers had the chance to change from one queue to another. The work provided solutions to equilibrium probabilities using the matrix-geometric method and computations for performance measures on overall stability conditions. The solutions were compared to results from existing models [8] to assess their relevance with regard to minimizing unbalanced utilization of the service lines and the time to service completion. The arrivals were simulated to imitate a Poisson distribution with rate λ , choosing the shorter of the two service lines each operating with exponentially distributed service rates (μ_1 and μ_2). If non of the service lines was shorter than the other, preference for one would follow probabilities (α or β , $\alpha + \beta = 1$) while instantaneous jockeying was possible when one of the service line was empty. For the transitions in queue lengths sizes that formed a Markovian chain, the author defined a sequence of difference equations that characterized the probability ($P_{i,j}$) of queues (i,j) being in equilibrium state. The compressed form (Equations 22 and 23) of these difference equations were first re-arranged to compose for a matrix block ($A_1P_1 + B_2P_2 + C_3P_3 = 0$) of sub-matrices (A, B and C) that generalized the system dynamics and traffic intensities. Then the evaluations for the sub-matrices (A, B, C) were computed from the definition of column vectors that encoded state transition probabilities over all positions in both queues.

$$A_{k-1}P_{k-1} + B_kP_k + C_{k+1}P_{k+1} = 0, \quad k = 2, 3, 4, \dots, L-1 \quad (22)$$

$$A_{L-1}P_{L-1} + B_LP_L = 0, \quad k = L \quad (23)$$

The geometric solution to the equilibrium probabilities of stochastic process emerged from the repetitive evaluations of the general Equation 22. Theoretically, the proof required that the sub-matrix B_k was invertible and this meant computing the inverse of the sub-matrix and its determinants. And there existed an inverse of this sub-matrix only if its determinant did not evaluate to 0 for all values of the traffic intensity ρ . Based on P_k^+ being the theoretical solution for stability conditions, Equation 23 expressed for this solution as the probability that the system was occupied to maximum capacity ($P_L = -R_L A_{L-1} P_{L-1}$, $k = L$) given that $R_L = B_L^{-1}$. Iteration of computations for R evolved into solutions for the differential equations expressed in terms of $P_{0,0}$ (probability that both queues were idle). The proof by induction on k

was required to further verify the relation $g_k = \rho^{k-2}g_2$ for $k = 2, 3, \dots, 2L$ (given $g_k = Pr(N = k)$; $N = N_1 + N_2$ and N_i , $i = 1, 2$ were the number of customers in either queue) that formulated for the equilibrium probabilities as the M/M/2 system capacity was doubled ($2L$) or as $L \implies \infty$. A numerical analysis included setting the arrival and service rates to different values and comparisons made with earlier results from the Conolly's model [8]. Performance evaluations for the effect of the system utilization on the equilibrium probability g_n under different queue setups were illustrated to show how the author's model was quantitatively better.

More like an extension to his [55] earlier work, [54] investigated the evolution in the transition state space of an asymmetric M/M/2 setup using two techniques; that is, randomization and Runge-Kutta. Similarly, the bulk of workload that the queuing system could accommodate was also restricted and the work built on the earlier matrix solution to formulate statistical equations that characterized the dynamics in the state space. No more than L tenants were allowed in the system and jockeying was only allowed from the longer line when any of the other service line was empty. This behaviour was captured as a Markovian process and the probability of having a certain number of customers at a time t ($p_{i,j} = Pr(N_1(t) = i, N_2(t) = j)$) in either service lines defined in conformity to a series of difference equations ([54], Equations 1 - 21). The formulation of the model stemmed from the definition of the state probability vectors $P_k(t)$ (and their derivatives $P'_k(t)$, $k = 0, 1, 2, 3, \dots, L$) for all state transitions over L (maximum allowed capacity of both queue) at given time t . The difference equations were then re-defined in terms of these state probability vectors to evolve into a generalized block-matrix formation $P'(t) = QP(t)$ (where $P(t) = (P_0(t), P_1(t), P_2(t), \dots, P_L(t))^T$) constituting sub-matrices (A, B, C). The sub-matrices denoted state space partitions to compose the rate matrix Q (Equation 24).

$$Q = \begin{bmatrix} B_0 & C_1 & 0 & \dots & & 0 \\ A_0 & B_1 & C_2 & 0 & 0 & 0 \\ & A_1 & B_2 & C_3 & 0 & 0 \\ & & & & \dots & \\ 0 & .. & & 0 & A_{L-1} & B_L \end{bmatrix} \quad (24)$$

It was argued therein that the expressions for the rate matrices ($R_L = B_L^{-1}$, R_k) could be ascertained from iterations of computations, a method that deviated from the usual technique of calculating for the eigenvalues and eigenvectors of the rate matrix. The modified vector-geometric solution for equilibrium probabilities of the Markov chain emerged therefore from the evaluations of the block-matrix equations in relation to the author's method of expressing for the rate matrix, given $P'(t) = 0$. The resolution for the transition probabilities ($P_{i,j}(t)$) in finite state space followed from the randomisation theorem ([54], Theorem 3.1 - Equation 25), which according to the author was more statistically efficient

when computing for probabilities in state changes.

$$p_{i,j}(t) = e^{-(1+p)t} \sum_{n=0}^{\infty} \frac{[(1+p)t]^n}{n!} p_{i,j}^n(t), i, j = 0, 1, 2, 3, \dots \quad (25)$$

$p_{i,j}^n(t)$ as the probability of the process changing state at the n^{th} step

From applying this theorem to the difference equations emanated recurrence expressions whose properties were used to calculate for the distribution of state changes. The statistical prediction of the time $w(T)$ (where T was the waiting time at a specific time t) that a customer spent in the queue before they got processed was also derived for when the systems was under equilibrium conditions. It was also shown how the Runge-Kutta method could be manipulated to provide an equivalent evaluation for the transition state distribution. The work then provided numerical analysis that compared the results from both methods when used for the calculation of the probabilities in state changes, probabilities that the queue was empty, distributions about the entire system occupancy etcetera. The author was also interested in tests that sought to understand how probabilities and capacities of the queues were influenced by the overall system utilization ρ under variations in queue parameters. The comparisons of results obtained from these two techniques under variations in quantities of the system descriptors with models studied by other researchers [8] were documented. Also, the impact of switching queues on the processing times and sizes of the queues was assessed versus when no switching queues was possible.

As research gained ground in jockeying, ideas started emerging with more diversity in the methods employed in analysing the queuing systems under the dynamics of switching lanes. [28] studied the value of purchased queue status information prior to a customer joining any of the two servers in an M/M/2 system. The experiments were inspired by the notion that such information could enable for optimal usage of the service line, consequently minimizing waiting times. This followed the belief that the decision for a new arrival on which queue to join was influenced by the precedent customer having bought queue status information (externalities). The authors therefore expressed for this influence by deriving Nash-equilibrium rules for a system where jockeying occurred when the difference between the two queues was three.

Analogous to a cost benefit model, the authors deployed Nash-equilibrium strategies that put a value on the purchased status information by evaluating how much benefit a client got from it. The expected benefit $g(p)$ meant knowing how much less time the consumer would be waiting to get serviced given the charges for that information. Two strategies arose here $p, 0 \leq p \leq 1$ which denoted the probability whether the information was purchased or not respectively. That is, a pure and a mixed strategy. But the

strategies ($g(p) = C, g(p) \leq C, g(p) \geq C$) were a factor of the relation between the benefit of the acquired information $g(p)$ and the costs C .

Basically, on arrival a customer purchased a probability value that abstracted the potential benefits given the current state of the queue. It was also relevant for the investigation to ascertain whether this information from prior clients impacted the subsequent client positively or negatively. Following a partitioning of the state space, the authors used the matrix-geometric method [47] here to obtain the stationary probabilities $\pi_{i,j}$ (i or j being sizes of either queues) of each queue size given the jockeying threshold $N = 3(3 \leq N \leq \infty)$. The proof included first defining the generator matrices that encoded the transitions within the system, then the stationary probabilities were evaluated from the eigenvalues/eigenvectors and spectral properties of the rate matrix R .

For each assumed position a customer took, a function $g(p)$ for ascertaining the benefit (expected waiting time) at that position under a given Nash-Equilibrium strategy was formulated from difference equations.

The numerical results showed comparisons between the benefit from purchases depending on the jockeying threshold N and the service line utilisation $\rho = \frac{\lambda}{2\mu}$ (where λ, μ were the arrival and service rate respectively). So the authors defined kind of evolutionary stable strategies or unique Nash-equilibrium strategies that related the expected benefits to the cost of obtaining queue status information for varying N . The study conclusively expressed for the magnitude of influence (be it negative or positive) of the actions of prior customers on new arriving customers when they purchased knowledge and when $N = 3$. The effect was considered positive if the acquired knowledge helped the consumers optimally use the service line and negative if the customer ended up waiting longer than expected.

The authors also argued, after computations of the expected time to service completion under different queue sizes that, the benefit was positive for new customers when the state of the system was $i = 0, j = 1$ such that any new customer joining culminated into stable conditions (1, 1). And that as the divergence N in queue sizes grew larger than 4, the benefits of purchasing knowledge were negligible.

[59] studied the jockeying behaviour and its applicability to multi-beam satellite systems when earth-stations were ordered as disjoint zones forming up-link and down-link connections with satellites. The sequence of the incoming packets was defined by an independent distribution function such that they were appended to the end of any of the shortest buffers at the satellites and then processed at varying Markovian service rates following the FCFS rule. The paper expressed for steady-state conditions for the number of packets in the systems as a vector-geometric solution. Based on the assumption that the underlying process

to the behaviour was non-Markovian, the problem was segmented into first defining a "imbedded Markov chain" ($\{\vec{X}_l = (X_1(t_l), X_2(t_l), \dots, X_c(t_l)) | l = 1, 2, \dots\}$) for which expressions for the probabilities of the buffers' capacities were ascertained under ergodic conditions. Under stable conditions, this chain was synonymous to a vector-geometric distribution. The solution for stable conditions in the satellite buffers arose from dividing the state spaces into groups $B_{<r}, B_m$ (maximum size of the buffers and maximum deviation between smallest and largest buffer respectively) given the probability (ω) that there existed only a one-to-one relationship between any two states (with the exception of the boundary states) and that new packets did not necessarily visit all states. Following the sub-division of the state transition matrix was the formulation of the equilibrium equations (both for non-boundary and the boundaries states) that characterized these sub-divisions. And subsequent derivations endeavored to show that both the boundary equations and queue equations had vector-geometric solution. The solution for the queue equations borrowed from earlier findings ([47], Lemmas 1.2.4) that there existed an eigenvalue $\omega = \omega_0; 0 < \omega_0 < 1$ of the transition rate matrix R and the determinant (using Equation 26) of this matrix was 0.

$$\det(\omega I - \sum_{k=0}^{\infty} \omega^k A_k) \quad (26)$$

where I was an Identity matrix, A_k was a square sub-matrix block of states when there were k packets in the system. This same Lemma was adopted for the proof whether the vector-geometric solution was valid for the boundary equations by taking the probabilities of any of the boundary states ($p_{r,r,\dots,r}$) in \vec{p}_r and evaluating for redundancy of each of the resultant substitutions of the vector-geometric expressions in the equilibrium equations. The proof concluded by showing that for the stationary probabilities of this "imbedded Markov chain" there existed a geometric parameter $\omega = \sigma$ that defined the uniqueness of the solution.

It was also proven that, the stationary probabilities vector (defined by Equation 27) of the buffer capacities was also a modified vector-geometric solution governed by similar uniqueness constraints.

$$\pi_{\vec{i}} = \lim_{t \rightarrow \infty} P\{\vec{X}(t) = \vec{i}\}, \quad \vec{i} \in S \quad (27)$$

S denoted the state space here. This followed the definition another "imbedded semi-Markov chain" ($X_i^*(t), i = 1, 2, \dots, c$) that represented the buffer capacities prior to any last packet at any time. Then, the fact that the stationary probabilities for this kind of process were similar to those of the "imbedded markov chain", it was theorized that from the sub-division of the $\vec{\pi} = (\vec{\pi}_{<r}, \vec{\pi}_r, \vec{\pi}_{r+1}, \dots)$, the process assumed a modified vector-geometric solution too.

Further consideration of the process as a continuous-time Markov chain was done where a generator matrix corresponding to the process and its stationary equations were defined. Then the same state-based partitioning techniques were applied to express for the general solution of the equilibrium probabilities.

Numerical experiments were conducted with the purpose of evaluating the system and its performance under setups where jockeying was permitted versus those where this behaviour and illustrations descriptive of the results presented. Table 1 for example showed how the time the packets spent in the buffers before service varied under relations of the processing times and it was justifiable, in tandem with conclusions by earlier researchers that switching queues presented positive effects with regard to the overall performance of the system.

4 Models based on cost-benefit and performance analysis

There exist a class of queuing models that suggest solutions to the problem of equilibrium conditions in queuing systems, under the dynamics of moving from one service line to another, by taking into consideration the accumulated costs during the life-cycle of the customer in the system. This class of models derive expressions for optimal cost policies that seek to govern customer behavior with the objective to maximize the overall reduction in the costing for the service.

The behavioral relationships between routing and jockeying control functions in parallel systems by associating both to costs with the goal of deriving for optimal rule-sets that governed these behaviour were the subject of [58]'s studies about controlling packets in buffers of multi-beam satellite stations for cost effectiveness. This was an M/M/2 system with no limit on new entrants to any of the service lanes and every packet that joined the server incurred holding costs. Also, moving (instantaneous) a packet from one lane to another generated a jockeying cost and no preemption was allowed. The proof suggested that, the optimal rule-sets for each behavior were characteristic of properties of convex functions and caused for some argument about system performance measures like workload distribution versus cost efficiency.

In the model, the system changed states $(X(t) = (X_1(t), X_2(t)))$ (state for lanes 1 and 2 respectively) then actions were taken when a new packet arrived or left any of the lanes. Expressions for the expected reduction in costs $(V_t(x_1, x_2))$ over time t and a predicted mean costs over longer time-span under steady conditions were documented. The author made a few observations about the rule-sets that governed new packets being pushed to a specific buffer or moving one job to an alternative queue. That the control of such behavior was tightly hinged onto the expected accumulation of costs (under discounted or non-reduced service costs and long-run

average costs) and on the apparent load in a given lane in comparison to the alternative one.

The control of packets behavior (admission or jockeying) was also conditioned on the state of current service station and the monotonic properties of the function F_{ij} (which defined the optimal rule-set). Therefore, a packet would only be routed to or migrated to another station if that station was in a valid state (x_1, x_2) at time t . The author proposed theorems for the existence of a function $F(x)$ that defined when it was okay for a new packet to be routed, when to move packets and when not to. And these functions (defined by 28-32) were adopted for the characterization of the optimal rule-sets for the different behaviour.

Explicitly, a new packet was routed to lane 2 only if 28 was true.

$$x_2 \leq F(x_1) \quad (28)$$

If F_{12} and F_{21} were true then it was okay to move packet from lane 1 to 2,

$$x_2 \leq F_{12}(x_1) \quad (29)$$

or from lane 2 to lane 1 defined by Equation 29

$$x_2 \geq F_{21}(x_1) \quad (30)$$

Migrations of packets was not optimal when

$$F_{12}(x_1) < x_1 < F_{21}(x_1) \quad (31)$$

$$F_{12}(x_1) < x_2 < F_{21}(x_1) \quad (32)$$

And it was proven that the characteristics of the function held true, not only for the setup where the costs were discounted during finite period of time t but also the long run mean expenditure.

The investigation also provided a deeper analysis of the state space to ascertain those state conditions for which the asymptotic characteristics were still applicable to the control functions that described the optimal rule-sets (under reduced costs and the mean costs over time). One of the restrictive characteristic of the control functions was that the decision to move from a station whose costs were lower than the costs of an alternative service station was only plausible if the alternative station was idle. This characteristic was evaluated by taking a state of the system when the alternative station was not empty and validating it under the jockeying control that underpinned the best-fit rule-set. The proof for existence of other asymptotic characteristics in control functions that defined the optimal rule-set F under discounted costs were also provided and it was shown that the same applied to the non-discounted mean costing over time. It was stated though that the control functions under both costing environments only converged under specific conditions of the both the jockeying and service costs.

Studies in the applications of consumer behavioural control would further penetrate in queuing systems to realise distribution of load in [16]'s findings where they ventured into expressing for the steady and non-steady conditions of service lines using fluid modelling. Exponentially distributed

	W		
	9:1	3:1	1:1
r=1	2.210	2.051	1.961
improvement(%)	38.3	17.6	7.0
r=2	2.667	2.273	2.062
improvement(%)	25.6	8.7	2.2
non-jockeying	3.582	2.489	2.108

Table 1. With the traffic intensity set to $\rho = 0.7$ under different ratios of the service times, the impact of jockeying versus no jockeying permitted on the average time to service completion under different jockeying thresholds r was evident as shown in the table above.

batches of clients chose between a low-cost and high-cost service line in an M/M/2 setup with an embedded controller that moved the clients from either service lines at fixed or variable costs depending on the bulk of client transfers involved. It would be shown how the expressions for these transitions would be portable heuristically to generalized setups of more than two service lines using a dynamic twinning technique. With independent and identically distributed arrival rates and equal processing rates for the two lines, the authors here extended [37]'s earlier work to derive for the class of policies that optimised the average long-run costs accumulated with client transfers, without factoring in the deviations (jockeying threshold) in the sizes of the service lines.

A policy or rule-set $\pi \in \Pi$ basically encapsulated the magnitude of bulks transfers to move, how long any of the clients to migrate had been waiting plus any other queue status knowledge relevant for the Markov chain. Besides the holding costs $h_i n_i$ (at server i), the decision \mathbb{D} (given a service completion or new admission to the service line) to transfer was associated with fixed K and varying costs m_j . Equation 33 defined the average predicted cost of a client starting in a state x given rule-set π . The optimal rule-set π^* was conditioned on $g^{\pi^*}(x) \leq g^\pi(x)$ for all states.

$$g^\pi(x) = \lim_{n \rightarrow \infty} \sup \frac{\mathbb{E}_x^\pi \left\{ \sum_{i=0}^n [k(X_i, Y_i) + \int_{\rho_i}^{\rho_{i+1}} c(X_i, Y_i) \delta t] \right\}}{\mathbb{E}_x^\pi \{ \rho_n \}} \quad (33)$$

where X_i was the state at the i^{th} decision step and \mathbb{E}_x^n the expectation (given policy π) of taking action Y_i would accumulate $k(\cdot)$ as the overall cost at a cost rate $c(\cdot)$.

In their fluid model, the heuristics that governed the optimal rule-set were a fusion of different queue descriptors, that is, the queue occupancy and times when an admission or release from the system took place. Earlier findings [11][10] have shown that the stability of fluid models derived from the existence of fluid limits $(\bar{M}(t), \bar{T}_j(t) : j = 1, \dots, N)$ and this conditionality was the basis for the resolution of the

model Equations 34-35.

$$\bar{M}(t) = \bar{M}(0) + \sum_{j=1}^N \lambda_j t - \mu \sum_{j=1}^N \bar{T}_j(t); \quad (34)$$

$$\bar{M}(t) \geq 0, \bar{T}_j(0) = 0 \quad (35)$$

where $\bar{T}_j(\cdot)$ was non-decreasing for $j = 1, \dots, N$ and $\bar{T}_j(t)$ were the times when the queue j with service rate μ and arrival rate λ was occupied at a time t .

Expressing for steady-state conditions was based on the notion of modelling the rates at which the randomness of incoming and outgoing clients in a system occurred to determine the resultant state of that system. So the fluid model was said to be in equilibrium when all incoming clients had been processed ($\bar{M}(t) = 0, t \geq t_0$) by the system (implying the rate at which processing occurred was larger than the rate at which new clients were admitted to the queues) and otherwise if at a certain time-frame $\delta > 0$ the queues were still occupied ($\bar{M}(\delta) \neq 0; \delta > 0$). The rule-set π of interest therefore had to be evaluated under prescribed conditions ($\epsilon \geq 0; \epsilon > 0$) to ascertain if it stabilised the fluid model. These conditions verified for the existence of the probability α that the state of the queues was changing asymptotically. The proof for the optimal rule-set assumed a simple M/M/2 setup and the objective was that the control rule-set ensured that transfer of workload within the system led to non-busy service lines in the shortest time possible while keeping the accumulated costs as low as possible (that is, moving workload to the costly service line was only if it was aimed to making sure that the line was not idle). The derivation (based on the sample path argument) emanated from the comparison of processes that mimicked clients joining the queues (given similar arrival and service parameters), guided by two policies (π - from high cost queue to low cost queue and π' otherwise) but each dedicated to moving clients from h_1 to h_2 and vice-versa. Function definitions that expressed for the differences in costs were formulated for each rule-set under varying queue sizes to maintain some level of uniform distribution when moving around clients while making sure that $\pi' < \pi$. These expressions formed the basis for determining the optimal rule-set that ensured transfer of

workload from either queue only when not occupied (non-idling policy), single client transfers or bulk transfers under symmetry conditions of the queue.

The solution for the optimal control rule-sets in the case of N queues adopted expressions for the kind of multiplicity in setup under the presumption that free servers continuously polled their peers for workload to be transferred. The performance of the rule-sets was numerically analysed for in a setup of six asymmetric queues (varied costs and arrival times) while maintaining a consistent service rate μ and each queue was polled randomly for workload to transfer after a set time T . The results suggested direct proportionality between the overall costs under given optimal rule-sets. It was also observed that there existed relationships between the polling time T and the performance or system load.

From a commercial perspective, usually it would be expected that any resource consumers' aim is to keep the overall accumulated costs when accessing the queue as minimal as possible and according to [53], it did not matter whether the shorter or longer queue was joined or jockeyed to as long as the choice for either yielded costs below a pre-set limit c . These costs were a factor of both the size of the queue (N_i) and processing fee $\beta_i > 0$, ($i \in \{1, 2\}$, i denoted a queue), such that new customers (with arrival rate λ as a Poisson distribution) were added to a queue depending on the magnitude of $\alpha_i N_i + \beta_i \leq c$ (where $\alpha_i = 1$ was a weighting measure on queue) of either queue. If a customer realised that waiting in shorter queue would accumulate more costs than switching to the longer queue was permissible. The authors derived equations that characterized the equilibrium distribution of the stochastic process that represented the queue sizes. The studies were mainly inspired by vendors offering varying price list for their services to give the user more preference depending on their service requirements. And staying away completely from the services when the overall service costs would turn up being too high was equally an option. The model falls in the class of setups that tend to restrict the capacity of the queues such that the maximum length $K_i = [c - \beta_i + 1]$; Hence, the representational Markov chain $X(t) = (X_1(t), X_2(t))$ of the changing sizes of the queues was irreducible and a factor of the underlying costs. The proof for the equilibrium probabilities ($\pi_{i,j}$) of the queue sizes was expressed under comparisons between and variations in the queue descriptors (K_i, β_i, c). The documentation formulated for the steady-state distribution deriving from theoretical comparisons between these descriptors under specific quantities of the system utilization ($\rho = \frac{\lambda}{2\mu}$, $\rho \neq 1, \rho \neq \frac{1}{2}$). Three comparisons between the system descriptors were made and for each comparison, expressions that represented the state changes (as a factor of β_1, β_2 and c) were first defined. The distinction line of the three cases compared was based on the magnitude of $K_1 - K_2$ (to determine whether a new client had to join or jockeying to either server1 or server2); That is,

$\beta_2 - \beta_1 - 1 < K_1 - K_2 < \beta_2 - \beta_1, \beta_2 - \beta_1 < K_1 - K_2 < \beta_2 - \beta_1 + 1$ and $K_1 - K_2 = \beta_2 - \beta_1$ such that all possible states reachable for each of the three cases were defined.

For each comparison case, balance equations which characterized the influence of leaving or entering the queue in a given state and under what circumstances a specific state was reachable formed the basis for the proof for equilibrium probabilities ($\pi_{i,j}$) of the system. The solutions for these balance equations evolved from them being re-written as difference equations in relation to the expressions (Equations 36-37) that composed the state sequence $s_i, i \in \mathbb{Z}_+$.

$$s_i = A_+ a_+^i + A_- a_-^i, \quad i \in \mathbb{Z} \quad (36)$$

given $s_0 = 1, \quad s_1 = 1 + 2\rho$ and where

$$a_{\pm} = 1 + \rho \pm (\rho^2 + 1)^{1/2} A_{\pm} = \frac{1}{2} \pm \frac{\rho^2}{(\rho^2 + 1)^{1/2}} \quad (37)$$

It was shown from induction principles how $\pi(i, j)$ could be derived for from relations between $\pi(1, 0)$ and $\pi(0, 0)$.

Figure 5 is an illustration of another example of an admission control queuing system, adapted from [12]'s work where new arrivals to a two service (M/M/2) line queuing systems were managed using an admission controller [40] that distributed them to either lines based on Bernoulli computed probabilities. The customers in the queue were charged a cost for staying in the system and since the customers kept getting knowledge about the status of the queue, jockeying from from a line to the tail-end of another was also associated to a cost. The study was interested in the behavior of a tenant who from the time of entering the queue continuously received updates about the status of the system and had the option to use this knowledge to make the decision whether to stay in the current line or to move. With close similarities to [16], the authors provided limit policies that guided the behaviour of customers joining a service line or moving from one line to another while ensuring that the least costs were accumulated over time in service. And the optimal policy therefore was one that prioritized reducing the expected cumulative costs.

The work proved that there existed limits on a current user's position in the a service line and on the number of customers in the alternative line, above or below which the user could make the decision to move to another service line or stay put. It was also hypothesized and justified therein that there existed a maximum queue length that would lead to a new arrival having preference for a specific service line.

To model for the continuous-time Markov process, a vector denoting the queue status ($x = (q_1, q_2, l) \in S$; q_i as service lines $i = 1, 2$) at a time t was defined. Then for any of the service lines in a state $q_1 q_2 l \in S$ with a customer at a given position taking a set of actions $a, a \in A (A = \{0, 1\})$, functions for the total anticipated reduction in costs (V_n for server 1, V'_n for and server2) after a finite number of time n , were

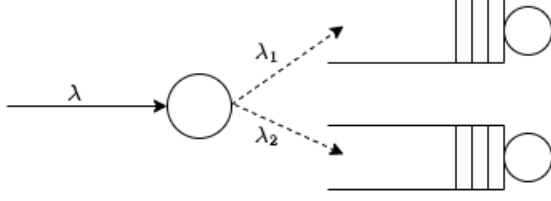

Figure 5. A simple illustration of a queuing system with an admission controller that decided which of the two service lines customers could join at a defined rate λ_1 or λ_2 such that $\lambda = \lambda_1 + \lambda_2$

evaluated from Equations 38-41

$$V_n(q_1, q_2, l) = \min_{a \in A} V_n[(q_1, q_2, l), a], \quad (38)$$

$$V'_n(q_1, q_2, l) = \min_{a \in A} V'_n[(q_1, q_2, l), a] \quad (39)$$

and for an infinite period of time as

$$V(q_1, q_2, l) = \lim_{n \rightarrow \infty} V_n(q_1, q_2, l), \quad (40)$$

$$V'(q_1, q_2, l) = \lim_{n \rightarrow \infty} V'_n(q_1, q_2, l) \quad (41)$$

The derivations followed from two theorems (one for the jockeying behavior and another for the control of new arrivals) that sought to ascertain whether the optimal rule-sets (that dictate customer behavior) monotonically increased or decreased with limits on the queue characteristics. In the case of the jockeying policy, the proof adopted defined inequalities (given the state of the queues) for which the cost functions held true for the optimal rule-set to maintain monotonicity over a finite period of time.

It was therefore shown that, there existed a limit $q^*(q_1, l)$ on the current queue length and the number of customers ahead of a current customer such that if the number of customers in the alternative queue was less than this limit, then it was okay for a customer to jockey and this limit was non-decreasing in l . Also, for the sizes of any two servers, if the number of customers ahead l of the current customer was greater than the limit $l^*(q_1, q_2)$, it made sense to jockey and this limit decreased monotonically in q_2 .

The proof for an optimal rule-set that dictated the behavior of new arrivals on the other hand followed from the theorem that, given prior knowledge about the queue status, there was a limit $\epsilon(q_1)$ on the length of a given queue for which if the size of the alternative queue (q_2) was greater than this limit, then a new customer should join q_1 and the limit was monotonically non-decreasing in q_1 . And that these two theorems held sufficient for conditions when no discount was given on the overall costing in infinite time.

It is evident that documentations about queuing solutions that subscribe to the "join the shortest queue with threshold jockeying" behavior all suggest that the decision to migrate workload within the system was a driver for better performance and balanced resource usage. There however seem to

exist hidden performance parameters that could individually be analysed revealing more room for system optimization. Take the case of [51] whose work concentrated on obtaining analytic expressions that evaluated for the number of jockeys made from one service station to another before getting served given that each jockey accumulated a cost. New arrivals (as a Poisson distribution) were pushed to the shorter station or either station with equal probability and the jockeying for a tail-end customer from the more occupied station to the end of the less occupied station was permitted when the difference between the length of any of $k \geq 2$ servers (each serving customers at IID processing times) equalled a threshold d . The solution involved splitting the transition state space based on queue length statistics like customers ahead (f) or behind (b) a given customer ($(f, b) \implies b \geq f \geq 1$) in the service line and whether the next move by that customer was a jockey or a forward in the same queue. The proof that was adopted from generating function theory, sought to provide mappings for a customer's state or position in the queue to the possible number of jockeys ($Y_{f,b}$) that the customer would make before being processed. The evaluation of the generating function therefore was characterized by the iterative formulation of the relationships ($\Phi_{f,b}(s) \ 0 \leq s \leq 0$) between these state actions. This required initial statistical computation for the chance ($P_f(j|b), \ 1 \leq f \leq \min b, j$) that the customer's next state ($(f-1, f)$) followed a jockey to the alternative queue or a forward move in the same queue to end up in state $(f-1, f) \ f \leq \min j, b$.

The expression for the chance (Equation 42) that a customer would move to the alternative station (in state $(f-1, j), \ f \leq j \leq b-1$ or $j \leq b$) were premised on the prevailing conditions in the current queue. That is, provided that $b > f-1$ and that the variation between the number of clients behind the current customer that left that station versus the number that wanted to join any of the queues was $b-j$.

$$1 - \sum_{j=f}^{\infty} P_f(j|b) = [\Gamma(\mu)]^{b-f+1} \quad (42)$$

From the total probability [51] (Equation 1) principles, the formulation of the relations (given the probabilities of being in a state) evolved into Equation 43 which defined for the generator function ($\Phi_Y(S)$). This function mapped the expected number of jockeys ($Y_{f,b}$) from one queue to another before the customer was serviced and it was a prediction dependent on the f (the number of people ahead of the current customer being served) and the arrival rate.

$$\Phi_Y(S) = \frac{2-\rho}{2+\rho} \left[\frac{2+\rho}{2} + 2B_0(S) + \frac{4}{\rho} B_1(S) \right] \quad (43)$$

where B_0 and B_1 were linear expressions that denoted aggregations of state relations and service line utilization over n customers in a queue.

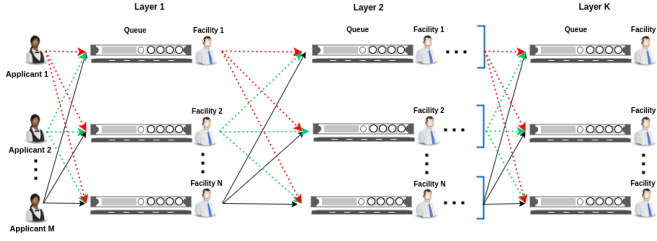

Figure 6. An example of stack of layers each with N facilities through which workload was processed to constitute a **MLCFLP** setup.

Additionally, a generating function ($\Psi_K(\theta)$) that yielded the random distribution of how many customers K ahead of the current customer left the queue was defined. This followed the analysis of the process representative of either actions (joining or leaving) over time, therein referred to as a "difference random walk" (DRW).

We present as one of the last papers in this section a somewhat differing application of jockeying in location-allocation problems, where [18] studied a cooperative multi-layered setup of queues to optimize both the times jobs took to completion and the utilization of individual queues in congested systems. This was given the fusion of queuing theory to solutions of a class of problems therein referred to as "Facility location problems (FLP)" [52], [25]. In such systems, jobs were distributed to empty service lines within the hierarchical layers based on certain rules that considered job priorities. And jockeying had mostly been discouraged given the presumable associated costs and complexity that the behavior presented forthwith. An optimal solution to these kind of problems motivated the researchers' choice to use genetic algorithms and the performance of the resultant model was evaluated under different scenarios.

Figure 6 depicted the layering, each constituent of facilities such that each facility orchestrated an M/M/1 queue and the applicant had the option to switch from one processing facility to another to evolve into a Multi-Layered Congested Facility Location Problem (MLCFLP). The authors were interested in dynamically distributing the facilities in each layer effectively so as to meet the emerging demand in small and large systems. A job was processed through each layer by those facilities in closest proximity to the job's location and the optimal solution was determining the set of facilities that could partake in the servicing of the job request. The demand for service queues followed a Poisson distribution, the service rates at each facility were exponentially distributed and each facility in a given layer participated in the processing of a jockeyed applicant.

Starting with a solution for small-scale systems, expressions that characterized the objective functions (reduce jockeying plus mean waiting times and keeping all facilities busy) were formulated and then further model equations that regulated

the facility descriptors and constraints on the entire of the system were shown.

The equations however encapsulated the non-linear nature of the problem and it was therefore required to redefine some of the expressions to be representative of the expected linearity of the model. Because the underlying problem presented itself as a class of multi-objective optimization problems (MOP), the derivations for the global solutions (Pareto-Optimal) were required not to be those that were optimal for one objective function while compromising the objectivity of the other functions. For this specific bi-objective problem, the authors utilized the augmented ϵ -constraint technique, where lexicographic optimization of any given objective function followed from how relevant it was (courtesy of a decision-maker).

The applicability of the augmented ϵ -constraint method when evaluating for Pareto-Optimal solutions to multi-objective non-linear models was restricted to small scale scenarios. The experiment therefore adopted the Non-Dominated Sorting Genetic Algorithm (NSGA)-II for medium to large scale service systems where a technique called non-dominated sorting was used to rank each entity. Figure 7 described the iterative process of using evolutionary operators for the selection of the parents for the next generation of off-springs. The Taguchi scheme was found relevant for the adjustment of input parameters used for the initialization of the population given the effect these parameters had on the genetic algorithms. The characteristic behaviour of each entity in the population and system components like layers or facilities was abstracted as chromosomes to which constraints ($g(x)$ where x was a chromosome) and cost functions were pegged. This aided the evaluations for how worth a chromosome was for parenting the next generation by associating the chromosome to penalties defined by Equations 44.

$$p(x) = U * \text{Max}\{0, \frac{g(x)}{b} - 1\} \quad (44)$$

such that U was a constant, $g(x)$ the constraint and $p(x)$ the punishment on chromosome x . The final mating population evolved from the iterative application of a sequence of operators (selection, cross-over, mutation) until the fitness function quantitatively yielded no better results for a series of selection runs. The authors concluded the investigations with a numerical analysis of the model by setting up a manufacturing system and results were documented when jockeying was permitted from one facility to another within the the layers versus when applicants were processed by a single facility.

The performance measurements confirmed that not only did allowing switching from one facility to another reduce the waiting and idle time of the facilities but the behaviour also ensured that the job transfer overhead was minimized given that only facilities within the proximity of a potential

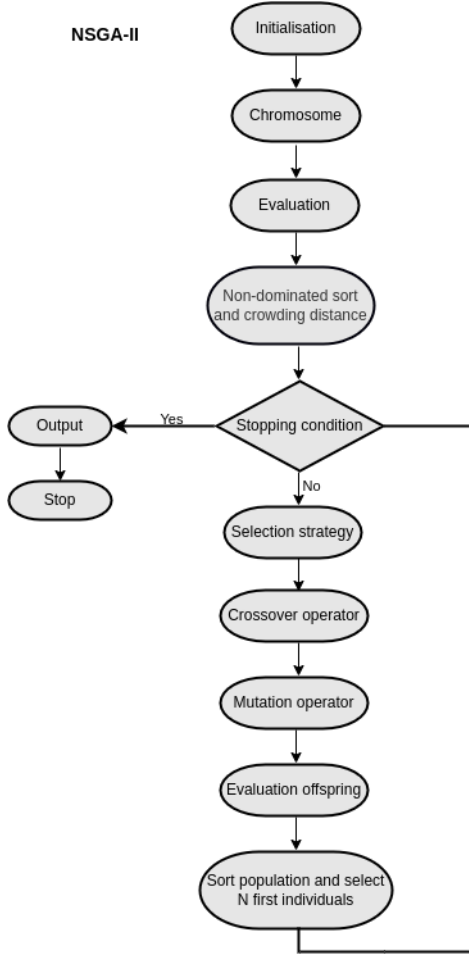

Figure 7. A depiction of the steps in the evolutionary algorithm that were followed during the evaluation of fitness functions for the parents of the off-springs in the next generation.

jockey were those considered to participate in a job's sub-processing.

Developing rules that governed the dynamics of impatient customers switching from one server to another inspired more experimentation that sought to develop jockeying controls for managing the behavior. The authors [40] here aggregated static and dynamic controls from individual controllers like routing, admission, service and jockeying to ascertain a best fit (hedge point) solution for equilibrium conditions. New arrivals did not get to choose which queue they joined but went through an admission controller[12] which managed the allocation to service lines each operating at varying exponentially distributed processing times. Over time, the costs accumulated due to holding, processing or jockeying influenced the required measure for a selected rule-set given the existence of a costing threshold.

The jockeying control[16] was triggered on service completion in one service line and the resultant chain of activities corresponded to a continuous-time Markov process. The activities here were accepting, rejecting or migrating workload which could be denoted as finite sets of non-negative numbers. An admission rule (u such that $u = \{u_0, u_1, u_2, \dots\} \in U$ as the collection of all possible admission rules) as a set of functions, on the other hand matched a given state (x) to possible actions based on the requirements of the decision and the associated forecast cost discount ($J_u(x)$); so the optimal admission rule was one that maximized this discount, therein referred to as the optimal value function V (Equation 45).

$$V(x) = \max_{u \in U} J_u(x) \quad (45)$$

Behind every action was an operator, therefore a function that mapped the transition to the next state as a conditional probability based on the admission rule and the current state was defined. To prove the presence of an optimal control rule-set followed from earlier findings [49] to evaluate for u as a stable rule-set. This required verification of each operator to be characteristic of the specific structural (sub-modularity and concavity convergence) properties and the emergent resolution involved repetitively trying different operations (using the Bellman operator T) against initial value function V_0 in infinite time such that the optimal value function set V_s included only those functions that obeyed the properties for all states.

To evaluate for the value function that maximized the discounted costs, the structure of each function $V \in V_s$ was validated to ascertain whether the magnitude of the expected discounted costs (related to taking an action that led to the next state) were non-decreasing or otherwise.

The optimal policy adopted a form therefore, that was determined by switching functions (S_1, S_2, L_i and G_i where $i = 1, 2, 3, 4$) which depended on the operation in a given state. Some functions managed assignments of new arrivals to queues and which paths they took while some functions managed completed services and migrations from one queue to another. This approach led to the division of the state space along a decision making (hedging) point and Figure 8 illustrated these dissections.

In essence, the optimal policy (hedging point policy) that controlled the dynamics in the setup was therefore the function of the monotonicity properties of these regional dissecting curves $S_i(x_i)$, $L_i(x_i)$, $G_i(x_i)$; $i = 1, 2$. The actions to be taken were also a function of a state's (x_1, x_2) locality such that subsequent servicing or jockeying actions for the boundary states were strictly dictated by L_3 or L_4 at server 1 and G_3 or G_4 for server 2 respectively. That is, when to accept or deny new entrants to a given server and when to forego jobs in a server's current work log to give priority to jockeyed jobs from the parallel server.

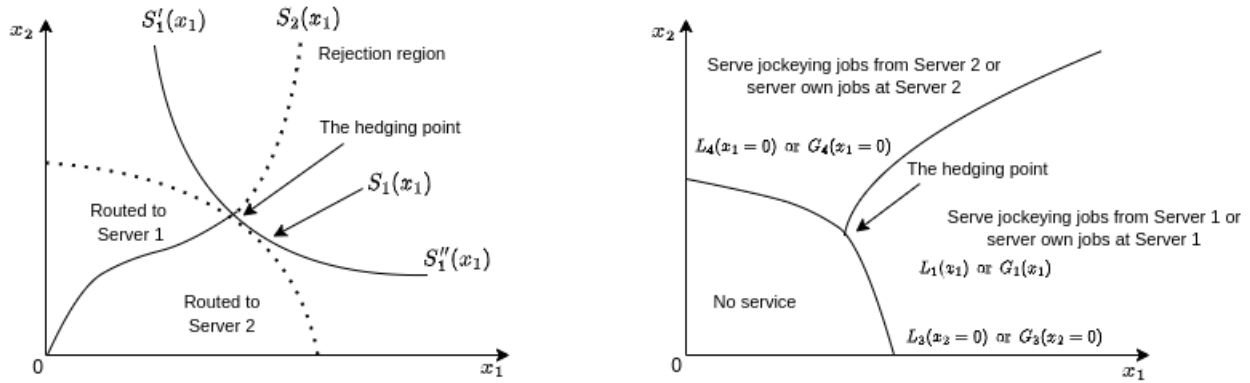

Figure 8. Left: The switching curves S_i that intersected to define a threshold (hedge point) policy for the decision to which server a new customer would be pushed. Right: The switching curves L_i and G_i that were bound to the decisions for which customer to service or move from server 1 to server 2 and vice-versa respectively as dictated by the hedging point policy.

The model was further assessed when switching jobs from one server to another was permitted versus when it was not and it was proven by re-evaluation from the Bellman Equation ($U = \bar{T}U$), that the optimal value function V that controlled the jockeying behaviour showed no significant deviations from the optimal value function U that characterized non-jockeying behaviour. Further proof was provided to justify the assertion that because of the optimal value function's inherent monotonicity properties that decrease or increase with respect to queue descriptors (like the arrival rate, service rates and the underlying costs in any of the servers), the system performance respectively exhibited similar characterizations.

The numerical evaluation included two symmetric servers (charging equal holding and jockeying costs as well as operating at equal service rates and arrival rates) and for the resultant stochastic process, the evaluation for the best approximation of the optimal value function $V(x)$ was shown. This followed a couple of repetitive application of the operator T to the value function using value iteration techniques and results showing the optimal behaviour of the value function with regards to the decision controls for server actions (admission, routing, jockeying, stopping etc) were documented.

To sum up this section, it has been widely assumed in most work that the customers arriving in queues will either have no prior knowledge about the different queues or some queue state information is availed at joining time giving the arriving customer some leverage when deciding which service line to join. Statistics about queues like their lengths, utility costs or average service and waiting times influence customer preference and considerations for providing such knowledge continuously in communication systems research have been proposed in recent years.

Designing queuing systems for time critical applications that depend highly on freshness of information motivated [26] to study the impatience of customers (where queue channel

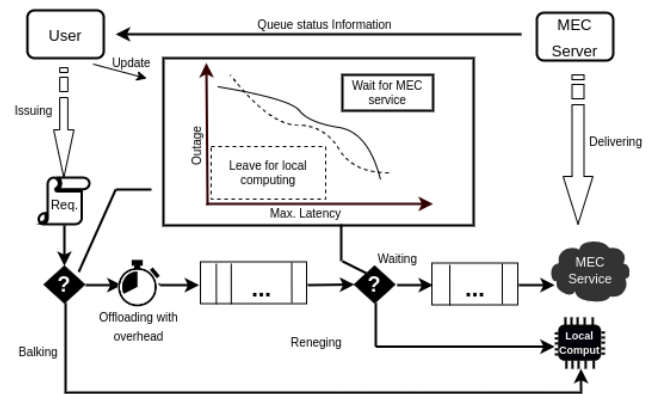

Figure 9. An schematic depiction of the impatient customer that had the option to either process a task on a MEC server or locally depending on the latency critical requirements of the underlying application

status information was availed to those customers versus when it was not) who could either renege or balk (with some semblance to jockeying) from queues in a Multi-access Edge Computing (MEC) 5G network environment. The customers had the option to continuously weigh the risk related to either process jobs locally (on their devices) or forward them to a cloud server. And even after the task was forwarded to the MEC, in order to minimize the risks that the latency requirements of the application could possibly not be met, the impatient customer was permitted to abandon the cloud server in a setup that simulated an $G/G/1/\infty$ FCFS queue as illustrated in Figure 9. Theirs was for latency sensitive "age-of-information" scenarios where applications required time-critical responses during service interactions and any out of sync information rendered subsequent unwanted outputs. The authors were interested in the behaviour of resource users' expected task requirements and it was shown that

a user's choice for either local or cloud processing was dependent on the requirements of the application's response time. The approach referenced information like expected waiting time in queues at the MEC server or the predicted degradation in expected response times to influence the decision as to which platform the computations of the task at hand took place given the fact that local computation involved no queuing. A utility model was first developed for the latency-critical tasks where customers got rewards from the tasks that were successfully processed and the reward (u) decreased to null with the total delay Δt . This delay, as defined by Equation 46 varied depending on the choice for platform and the user got access to this kind of information for a given task beforehand.

$$F_{\Delta t}(x|t) = \begin{cases} F_{\tau_l}(x - t|t) & z_t = 0 \\ F_{\tau_c}(x - t|t) & z_t = 1 \end{cases} \quad (46)$$

where F_{τ_l}, F_{τ_c} functions that defined for the expected remaining processing lag on the local (τ_l) and cloud (τ_c) platforms respectively

While at the MEC server, the user then had the ability to assess the risk (P_o) associated with continuing with the cloud-based processing given the ever changing network/compute resource delays so as to make decisions that maximized the expected reward. The authors first studied the behavior of an impatient customer amongst patient customers (those whose chances of balking were negligible) who was availed continuously with channel status information plus some system characteristics. At any time therefore, the customer was aware of the expected cloud server response times τ_c in terms of the task forwarding overhead (τ_s) and the predicted waiting time ($\tau_{w,k}$) given the user landing in position k at joining time $t > 0$.

It was shown in this case that a user that submitted a task to a queue in the cloud did not retrieve the task from the queue when provided with reliable and flawless channel information. The proof followed from the fact ([26], Lemmas 1-2) that there existed a time, given the task forwarding overhead to be incurred, that the risk P_o associated to the predicted cloud delay was less than that associated with remaining local delay. This implied that the customer could not leave the queue immediately after joining it (t_1) and because the predicted remaining latency diminished as more customers that were in front in the queue got processed, it was argued that the customer could not also retrieve the task at time t_2 . The paper further considered the customers' task processing rates changed according to a Poisson-mixture distribution (Markov-modulated Poisson process) at time t such that the value of the rates $\hat{\mu}_t = \mu * Y_t^T$ was defined as a factor of the status of the cloud server (Y_t^T) and the vector-based representation of the processing rates (μ) at varying system states. It was clear that continuous updates to the service rates would easily affect the risk estimations

for predicted remaining cloud lag consequently leading to customers retrieving their tasks from the MEC server.

It was also necessary to understand customers' reaction when availed with flawed information about the state of the channels under the hypothesis that may be the customers could develop their own knowledge from experience and use this knowledge to make the necessary choices for a compute platform. The imperfect knowledge presumably being say the processing rates of any server or how busy it was, then it was expected of the customer to validate this information with time by continuously observing how the size of the queue varied. The error arising from this observing and estimation for the rates was computed using Equation 47

$$\epsilon_\mu(\Omega_t) = \hat{\mu}(\Omega_t) - \mu \quad (47)$$

where $\hat{\mu}(\Omega_t)$ was the predicted processing rate after observing users at k positions after a number of observations $\Omega_t = (\omega_{t_1}, \omega_{t_2}, \dots, \omega_t)$ over time t with $\omega_{t_n} = (k(t_n), t_n)$ as the positions in the queue at given times t_n .

It was argued that the margin of this error directly affected the predictions for the risk associated with making the choice for which resources to use such that customers would end up either being reluctant or hasty. The expected return on the reward would supposedly also suffer a loss, consequently the response times too and there was therefore a need to control the learning process to know whether the acquired knowledge still added value or not by penalising the evaluation of μ . When knowledge about the queue was provided, it was probable that this knowledge had an effect on the magnitude of the loss or gain. The authors therefore found it optimal to avail such status updates by evaluating for the learning gain or predicted loss in reward upon service completions or when customers retrieved their tasks from the queue. An algorithm was then devised that could allow for such a risk-analysis dependent model of the customer's reneging behaviour while encapsulating the underlying learning constraints, loss or gain in reward under probabilistic estimations of the service rates $\hat{\mu}$. The authors verified the mechanisms with a numerical study of the impatient customer's regretting behaviour under different experimental setups involving correct and partially correct system status information. The results provided interesting insights into the influence of queue status knowledge on a customer's decision for preference of a processing platform and on the overall system performance in terms of the response times under changing conditions.

5 Multi-class multi-server Priority transfers models

The statistical analysis of the queuing systems with possibility of customers making preference for which service line to join or switch to had earlier on been concentrated on

single workload migration. Newer studies of queuing systems however suggest new approaches such that transfers do not involve single jobs at a time but job batches from one service line to another. The reader however should not expect extensive coverage of models where transfers are based on workload prioritization in this documentation as this is another wide topic in parallel systems. So we restricted the content under this section to the few models whose proofs relate more to the solutions for the equilibrium conditions for the different queue descriptors and overall system performance evaluations.

[42] provided expressions for policies that could guided job transfers from unreliable or broken servers to available ones. In this case, there was no need for the to-be transferred workload having prior knowledge about the other queue but, to whatever new target queue jobs had to be migrated, the associated costs had to be minimized. Because no queue status information existed at arrival, a new job was tagged with a time threshold (given the arrival timestamp) within which it had to be processed. In the event that this time threshold expired, the workload was transferred to any available server. Selecting the right server on which to migrate the workload was the objective of the transfer policy deployed. The authors therefore compared the different policies under different job expiry thresholds to keep the resultant costs (holding and transfer costs) charged during such migrations as low as possible. The costs depended on which position the migrated job landed at and how many job migrations occurred at a given point in time. Initial experiments aimed at obtaining a solution for a single server setup, such that when the server was unavailable, job processing was simply abandoned (reneging). Later, it was shown how this solution was applicable to a multi-server setup with batch job transfers. Figure 10 represented the dynamics in the system with jobs arriving at each service line following a Poisson distribution and the processing rate at each server being exponentially distributed. The job expiry thresholds and the periods when the service lines were operational or not were all exponentially distributed over the mean. Jobs that were terminated prematurely due to server breakdown had tags appended to them to indicate where processing would resume while jobs the exceeded their time thresholds were immediately migrated to an existing operational server as dictated by the transfer policy. Finding the optimal configurations for the job expiry periods and the workload transfer policy under steady conditions for the queue sizes (L_i say for queue i) and reneges/transfers ($\beta_{i,j}$) while keeping costs low were used as the metrics of measure of how well the systems fared. The single queue case was first considered and it was shown analytically that the mean number of jobs (L) in the system could be computed from the system of linear difference equations. And a reneging rate (β) for those jobs that expired (since there was no other service line) expressed for. The stationary probabilities ($p_{i,j}$) of the queue being in a specific

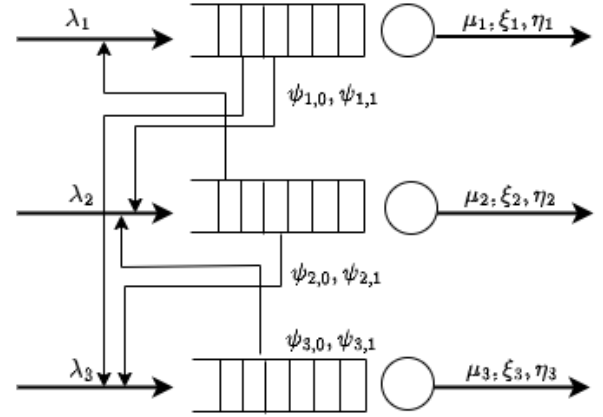

Figure 10. A depiction of workload transfers from unavailable servers to any of N available servers under the assumption that execution of transferred jobs onto an operational server resumed at the point of failure.

state i, j , (where i was the server status of up or down and j as the number of jobs) were ascertained for a few special scenarios.

The authors then experimented with the case of N service lines under similar dynamics and from the transitions within the systems emanated a matrix constituent of job migration possibilities $Q = q_{i,j}, j=1$ that influenced which job(s) was migrated to which queue (transfer policy) with which probability $q_{i,j}$. How often workload was migrated from one queue to another (transfer rate) was then defined by $\beta_i q_{i,j}$ (i and j as queues) and the sum of all these rates could be computed using Equation 48.

$$y_i = \alpha_i + \sum_{j=1}^N \beta_i q_{i,j} \quad (48)$$

where α was the probability that the server was broken

To quantitatively obtain the transfer rates, it was suggested here that an iterative process that built on the solution for the single server setup (treating each queue individually) be followed to estimate for these rates and the total costing given the workload on the server. And the process would terminate when two successive rates did not differ beyond a certain margin. A mechanism the authors referred to as Poisson Approximation. However, to choose a job migration rule Q that ensured optimal performance required exploring the parameter configuration space for each service line and as the number of servers increased, the migration probabilities exploded exponentially making the search harder. It was observed that the Poisson Approximation technique was less viable for the embedded dynamics in such N server setups. The authors proposed some existing heuristic rules (round-robin, fastest other etcetera) that could lead to optimal solutions for the transfer policy under assumptions of consistency in some queue parameters.

To conclude the study was a numerical analysis to evaluate the scope of applicability of the Poisson Approximation solution to answer queries around optimal choice of workload expiry thresholds; comparisons in performance of the above mentioned heuristic policies under varying server configurations were also benchmarked.

The batch transfer methods received further attention in a setup of two M/M/1 queuing servers when [29] considered the variation in the sizes of the two service lines (q_1, q_2) hitting a preset threshold L as the trigger for moving some workload K ($0 < K < L$) to the shorter queue. The dynamics in the two queues assumed a QBD process and steady-state equations were evaluated for using the mean-drift technique. Drawing inspiration from the service sector, the researchers wanted to know the optimal time and number of consumers that could be migrated from one health facility to another while keeping the pricing for these services affordable. A QBD process ($(q_1(t), q_2(t)), t \geq 0$) with state space $(n_1, n_2) : n_1 \geq 0, |n_1 - n_2| < L$ ($n_i, i = 1, 2$ as the number of customers in a given queue) was assumed given that new Poisson distributed arrivals (at rate λ_i) joined service queues that run at exponentially distributed processing rates ($\mu_i; i = 1, 2$). Then based on the inherent recurrence (the probability that the system will revisit an earlier state in finite time) properties of such processes, it was theorized and proven [29, 34] that steady-state conditions could only exist under specific conditions of the traffic intensity ($\rho < 1$) (calculated for by Equation 49).

$$\rho = \frac{\lambda_1 + \lambda_2}{\mu_1 + \mu_2} \quad (49)$$

The derivation adopted findings from [19] where a state mapping $f(n_1, n_2)$ (Lyapunov function) related the state of each queue; this mapping was then the basis for the computation of the mean drift as an aggregation of the process generator matrices Q in state space followed by a proof for necessity. Although the structure of the stochastic process made it hard to analyse, the fact that the process constituted special properties ($q_1 - q_2 \leq L - 1$) allowed for the sub-division of the state space $\{(q_1(t), (q_2(t)), t \geq 0\}$ to re-organise into a valid QBD to which matrix-geometric techniques could be applied for a solution to the equilibrium probabilities. This state space was re-organised based on the system occupancy $q(t) = q_1 + q_2$ and the deviation between the sizes of the queues ($j(t) = q_1 - q_2$) at any time t . Because of the associative relationship (the value of one parameter determines the value of the other) between the two queue characteristics, it was observable that the emergent process ($(q(t), j(t)), t \geq 0$) from such a relationship was Markovian. Further partitioning of this process's state space into levels (depending on the number of customers in the system and the respective infinitesimal generator matrix Q_1 for that process constructed from the partitions) was done but because the processes partitioned along the system occupancy were

hard to resolve for, partitioning of the state space was done until when all dependencies were broken. This iteration was done until the resultant stochastic process $(X(t), J(t), t \geq 0)$ (with its corresponding generator matrix Q_2) was irreducible and not dependent on the number of customers (system occupancy). The equilibrium probabilities for this process were then formulated for using matrix-geometric methods based on earlier solutions ($A_0 + RA_1 + R^2A_2 = 0$) [47],[38] that entailed resolving for the eigenvalues (with the largest modulus - Perron-Frobesius eigenvalue) of the rate matrices R at the different levels (L) under the assumption that the process was constituent of recurrence properties. The solutions for the stationary probabilities vectors at each level followed from the matrices that denoted each of the state space sub-divisions (to form new Markovian chains) and these probabilities formed the basis for proof for stability conditions for system descriptors like likelihood that a queue was idle, number of serviced units, estimates on the number of consumers in a queue under steady conditions, how often workload was transferred ($T_{R,1 \rightarrow 2}, T_{R,2 \rightarrow 1}$) within the system, etcetera.

Expressions for the rate at which the distribution of system occupancy diminished were formulated, following from findings[46] that evaluated for this rate as $sp(R)$ (Perron-Frobesius eigenvalue of the R) for such matrix-geometric distributions ($(X(t), J(t), t \geq 0)$). It was suggested that this decay rate was representational of an exponential distribution and the paper derived equations for both this decay rate (was neither affected by the workload transfer threshold L nor the number of workload migrations K) under varying inequalities of the traffic intensity ρ . The asymptotic behaviour of the steady-state probabilities of the queue sizes were also formulated for. Then based on theoretical assumptions on the structural (like spectral radius) properties of the non-negative matrices like R , an expression for the rate matrix and eigenvectors for the corresponding eigenvalues were also derived.

The analytic solution was validated by numerical evaluations that involved experimentation with variations in queue design parameters (like number of transfer, transfer threshold, processing and arrival rates) to reveal parameter configurations under which optimal performance could be realized in the queuing system. Taking the case of the first queue with $\lambda_1 = 1, \lambda_2 = 2, \mu_1 + \mu_2 = 1 = 4, L = 5, K = 3$, it was observed that as the service rate increased, the rate at which customers were transferred to the second queue decreased and vice-versa. This revealed the inherent convexity properties of the relationship between the service and transfer rates. These findings provided hints about how admission of new service consumers in the system was controlled such that the intersection of the two transfer curves marked that point in time when the service lines possessed the same number of occupants. This corresponded to utilization of the two

lines being equal in magnitude, hence minimizing the rate at which migration of workloads occurred within the system. It was conclusively suggested by the researchers, that choosing the right processing rate for each queue was requisite for even load distribution ($\rho_1 \approx \rho_2$) so as to keep transfers within the system at reasonable minimum quantities. This was given the fact that the transfer rates exhibited monotonicity properties in the processing rate. Further analysis of system performance under variations in service line parameters was documented as part of the numerical studies so as to gauge the magnitude of influence these parameters had on the workload (K) migration decisions. Ultimately, it was suggested therein that the parameter that exerted much influence on these decisions was the deviation in queue utilization (traffic intensity).

We found interesting [14]'s fluid limit approach for evaluating steady-state expressions for a cluster of cascading servers that continuously co-operated to share task executions. Specific classes of customers with IID arrival times were allocated positions in specific queues. But these class specific queues served (IID processing times) customers from other classes only when they were idle.

Two variations were presented therein; one of the class of *X-models* as a setup with two servers (each representing a class of customers) and the other, coined the term "tree-cascade system" that included three servers (classes). Equation 50 represented the stochastic process as an aggregation over the individual processes that underpinned the dynamics of the servers.

$$X = (Q, Z, U, V) := X(t) = (Q(t), Z(t), U(t), V(t)), t \geq 0 \quad (50)$$

where

$U(t)$ = the time before a new arrival seeks to join the server

$V(t)$ = time left to service end for customers

$D(t)$ = finished jobs

$Z(t)$ = jobs being processed

$T(t)$ = Total allocated time for processing for customers

$Y(t)$ = Time server is not processing any job

$Q(t)$ = size of the buffer at any time.

It was argued that to compute the steady-state conditions for such a networked system, one needed to prove the stability of the underlying fluid limit model, which required that the system was in equilibrium if the emergent Markov process X had a non-repeating consistent statistical value[9]. It was theorized (from [13]) therefore that, assuming two service line scenarios, where one had a lower processing rate ($r_1, r_2 \geq 1$ or $r_1, r_2 < 1$) than the other (given $r_1 = \frac{\mu_1}{\mu_{1,2}}$ and $r_2 = \frac{\mu_2}{\mu_{1,2}}$), then stability for fluid limit based models could only exist under specific conditions of comparative variations in the arrival (λ) and service rate (μ). These conditions were specified by Equation 51, such that the aggregations over the quantities $\bar{Q}(0), \bar{U}(0), \bar{V}(0)$ of the queue network equations

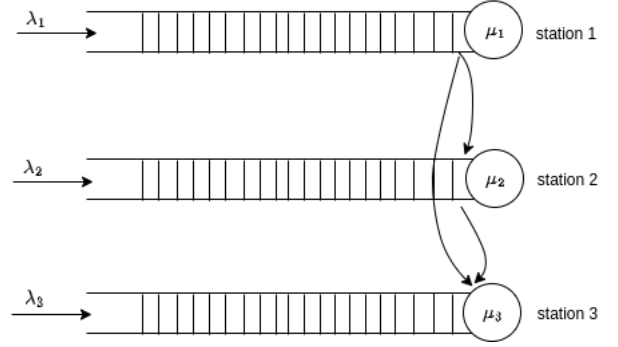

Figure 11. The setup of three stations where the first two directly serviced customers' requests while the third station took over tasks from any of the other two queues to form a co-operative tree-cascading setup.

at a time $t \geq 0$ equalled unit, $\bar{Q}(t) = 0, t \geq t_1$.

$$\begin{cases} (A_1) & \lambda_1 - \mu_1 + \frac{\lambda_2 - \mu_2}{r_2} < 0, \\ (A_2) & \frac{\lambda_1 - \mu_1}{r_1} + \lambda_2 - \mu_2 < 0. \end{cases} \quad (51)$$

The proof for the stability of the X -model then derived from the adoption of the Lyapunov function $f(t)$ [43] which related the sizes of the queues ($\bar{Q}(1), \bar{Q}(2)$) over time $t \geq 0$ and it was necessary to show that $f(t) \leq -C$ (constant $C > 0$) under varying comparisons of the arrival (λ_i) and service rates ($\mu_i, i = 1, 2$).

The authors extended their studies to the tree-cascade setup as illustrated by Figure 11, under work-conserving rules where jockeying was allowed to any of the servers that were free although the third station was dedicated to supporting the other two stations. The corresponding Markov process X (renewal arrivals and jockeying when one queue was empty) was similar to the one for the two server setup except with higher dimensionality in the state space and with slight differences in the system equations that expressed for the interactions amongst the service stations. The stability of the fluid model in this setup was also premised on ratios of processing times ($r_{1,3} \leq r_{1,2}, r_{2,3}$) and the rate at which customers sought to join a given buffer under conditions defined by the Equation 52.

$$\begin{cases} (B_1) & \lambda_1 - \mu_1 + \frac{\lambda_2 - \mu_2}{r_{1,2}} + \frac{\lambda_3 - \mu_3}{r_{1,2}r_{2,3}} < 0, \\ (B_2) & \lambda_2 - \mu_2 + \frac{\lambda_3 - \mu_3}{r_{2,3}} < 0, \\ (B_3) & \lambda_3 - \mu_3 < 0. \end{cases} \quad (52)$$

Similarly, adopting the Lyapunov function $f(t)$ [43] and because the function was inherent of similar differentials at any time t with the server sizes, the proof for the equilibrium conditions gathered from evaluation of the inequality $f(t) \leq -C < 0; C := \min\{C_1, C_2, C_3\}$ to hold under varying sizes of the queues ($\bar{Q}_i(t), i = 1, 2, 3$). It was shown how the fluid limits on the servers' occupancy hold stable in infinite time, hence that with such server conditions the Markov

process revisited specific states in finite time (positive Harris recurrent).

In yet another diversity in approaches to batch transfers problems, [30] research built on earlier findings[27][45] to study the boundary asymptotic formation of the probability distributions of the sizes of two (M/M/2) service lines (one special and the other normal) with specific interest in the steady-state conditions of the normal service line. The growth in size of normal line was continuously monitored after an exponential time interval such that workload was transferred ($L - K$ where L was the length of the normal line) when the size of the line exceeded a preset threshold (K). The paper provided expressions that defined under what conditions the probability that the number of customers in the normal line increased based on some geometric limits (tail asymptotes) in infinite time vis-a-vis the number of customers in the special line staying constant.

For the continuous Markov chain $\{(L_1(t), L_2(t)), t \geq 0\}$ (L being the lengths of each service line), steady-state conditions of the queue sizes were first derived for as $\lambda q < \mu_2$ and $\lambda < \mu_1 + \mu_2$ (where $\lambda < \mu_1, \lambda < \mu_2$ were arrival rates and q the probability that new arrivals joined the special line). The proof developed from adoption of the Foster-Lyapunov[19][43] condition for stability to show that the process states were revisited in finite time (positive recurrence). That is, given a process $X_n > M$ (M as a non changing value of big quantity) under varying relations of the arrival rate and processing rate, expressions (Equation 53 for $\lambda p < \mu_1$ and Equation 54 for $\lambda p \geq \mu_1$) that evaluated for stability from the Foster-Lyapunov condition ($E[X_{n+1} - X_n | X_n] < -\epsilon < 0$) were derived.

$$\frac{\lambda q - \mu_2}{\eta} \quad (53)$$

$$\frac{\lambda p - \mu_1}{\eta} + \frac{\lambda q - \mu_2}{\eta} \quad (54)$$

where p was the probability of joining the main queue, η was a distribution of the server polling intervals

For uniformity, transitions probability matrix $P = I + Q$ (where Q represented that rates at which the queue varied in size and I an Identity matrix) was subsequently divided into sub-matrices based on levels. By exploiting the special structural properties of the irreducible sub-matrix ($D(\sigma) = A + B\sigma + C\sigma^2$; where σ defined by Equation 55 was the decay rate and A,B and C as sub-matrices depicting state space splits), the authors showed that the boundary limits of the probability distribution of the normal queue size decreased at some constant ratio sequentially (geometrically). A further split of the sub-matrix D along the boundaries evolved into the formulation for the proof. The characterization followed from the evaluations for convergence norms $\vec{\sigma}, 0 < \sigma < 1$, verification for the existence of the $\frac{1}{\sigma}$ - invariant measures

and vectors of the sub-matrices ([30], Lemmas 4.1-4.2).

$$\sigma = \frac{(\lambda p + \mu_1 + \eta) - \sqrt{(\lambda p + \mu_1 + \eta)^2 - 4\lambda p \mu_1}}{2\mu_1} \quad (55)$$

Under special conditions of $\lambda q < \mu_2$ and $\lambda < \mu_1 + \mu_2$, it was shown that the boundary limits for joint stationary distribution $\pi_{i,j}$ as approximated from the decay rate decreased geometrically and the decay rate varied with the individual queue sizes.

Numerical analysis of the these formulations were performed, experimenting with different queue parameter settings for the arrival or processing rates in each queue. At different monitoring intervals, results were compared under changing values of the arrival rate and it was observable that the increase in the decaying rate was linearly proportionally to the rate at which customers joined the queue. It was interesting to also observe how the decaying rate responded to increasing quantities of the processing rates and the results surprisingly suggested that the decaying rate decreased linearly with respect to an increase in the service rates of the queues.

6 Discussion and Summary

We have profiled herein the behaviour of switching service lines by impatient customers waiting in queues and the numerical evaluations from all findings correlate to justify the hypothesis that jockeying from one line to another not only yields better utilization of the queues but is also a catalyst for reduced processing times. This documentation has covered the topic in categories, based on the technique used by each respective author to solve for the underlying problem. We have also presented cases where the jockeying behaviour is not restricted to one consumer at a time but also studies where batches of consumers could be transferred from one queue to another.

All the studies model the stochastic process that underpins the changes in state that the system undergoes to derive for the stability distributions of different queuing system parameters under steady-state conditions. And the solutions are backed up with numerical experiments that try to validate and analyse the systems' overall performance under different measures of queue characteristics. As evidenced from these chronicles, the benefits that come with jockeying from one queue to another in queuing systems range from technical to economical. Technical in the sense that, switching queues ensures that customers do not get to wait in longer queues when an alternative one lies idle. This ensures maximum utilization of the existing resource pools while minimizing the overall time tenants might spend waiting to get processed. And this minimization of the average time spent waiting relieves the consumers of a percentage of the total accumulation in holding and service costs, hence the economic significance of this jockeying behaviour.

Recent findings suggest that the number of devices that will be connected to communication systems will grow to exceed the existing demand for available resources as more functionality is introduced into these devices. The multitude of devices that require access to existing infrastructure resources has direct implication on the data exchange within the networks consequently presenting more challenges associated to how these systems can qualitatively distribute resources to guarantee the satisfaction of different SLA. Because different vendors will provide varying costings for the services they provide, giving the consumer the ability to select from the pool of available resources will mitigate the expected impact of diminishing availability while ensuring optimal usage of the communication channels. It still remains unclear, although suggestions exist, how continuous relaying of queue status information to customers can be achieved in communication networks as this might introduce extra overhead within the channels. In addition to this, the distributed nature of cloud computing systems reveals aspects of location-allocation dynamics; That is, as earlier on observed in some of the work here, the distance that packets have to traverse when making preference for a given queue needs to be factored in when the designing such systems. In the context of resource allocation in MEC 5G or 6G communication systems and beyond, where it has been proposed that application requirements will be mapped categorically to specific network slice configurations, queuing theory is one concept that could accelerate flexibility where consumers evaluate their choices for access to vendor resource pools by jockeying from one queue to another with the objective of minimizing expected costs for services while ensuring that the respective QoS requirements are satisfied.

	Type of queue	Jockey threshold	Other evaluation metrics
Probabilistic and Instantaneous jockeying models			
A Solution for Queues with Instantaneous Jockeying and Other Customer Selection Rules	M/M/C	2	Distance traversed by jockeying candidate
On Jockeying in Queues	M/M/2	1	average waiting times, impact of jockeying on service rate
Two queues in parallel	M/M/2	1	mean queue sizes
The shortest queue model with jockeying	M/M/C	1	mean queue sizes, average waiting times
General solutions of the jockeying problem	M/M/3 + M/M/∞	≥ 2	restricted queue capacities, effect of arrival rate on jockeying rate, system utilization
Matrix-geometric models			
Matrix-geometric analysis of the shortest queue problem with threshold jockeying	M/M/C	≥ N	mean queue length, mean waiting time
Analysis of two queues in parallel with jockeying and restricted capacities	M/M/2 2xM/M/1	+ iff N1=0 or N2=0	traffic intensity
A matrix-geometric solution of the jockeying problem	M/M/C	≥ 2	mean queue sizes, mean waiting time
The shorter queue problem: A numerical study using the matrix-geometric solution	M/M/2	10 < n > ∞	mean queue length, mean waiting time
Equilibrium strategies and the value of information in a two line queuing system with threshold jockeying	M/M/2	3 < n > ∞	queue status information and its cost
Queuing Analysis of a Jockeying	M/M/C	≥ 1	waiting time, traffic intensity
Transient analysis of two queues in parallel with jockeying	M/M/2	iff N1=0 or N2=0	traffic intensity
Analysis of the asymmetric shortest queue problem with threshold jockeying	M/M/2	≥ N	mean queue length
Cost-benefit analysis models and the MEC			
Dynamic routing and jockeying controls in a two-station queuing system	M/M/2	≥ 1	Workload distribution, cost efficiency
Optimal policy for controlling the two-server queuing systems with jockeying	M/M/2	Hedge point	Cost optimization
Dynamic Load Balancing in Parallel Queuing Systems: Stability and Optimal Control	M/M/2 + M/M/C	≥ N	Polling time for workload to transfer within queues
Impatient Queuing for Intelligent Task Offloading in Multi-Access Edge Computing	G/G/1/∞	1	Costs, response time and rewards
Strategic Dynamic Jockeying Between Two Parallel Queues	M/M/2		Limits on queue lengths when jockeying was beneficial
A new look on the shortest queue system with jockeying	M/M/C	≥ N	Count of jumps before being served
Bi-objective optimization approach to a multi-layer location-allocation problem with jockeying	M/M/C	Fitness function	Idle time, waiting time, transfer overhead
A Queuing System with Two Parallel Lines, Cost-Conscious Customers, and Jockeying	M/M/2	≥ 1	Costs optimization
Multi-server batch workload transfer models			
Analysis of job transfer policies in systems with unreliable servers		≥ N	Workload expiry threshold
Stability analysis of some networks with interacting servers		≥ N	
Two M/M/1 Queues with Transfers of Customers	2xM/M/1	1	transfer rates, size of transfer, throughput, time to migrate workload, magnitude of bulk transfer
Tail asymptotics of Two Parallel Queues with Transfers of Customers	M/M/2	≥ N	

Table 2. Different approaches used for analysing the jockeying behaviour of customers in queuing systems

Acknowledgments

This work is supported in part by the German Federal Ministry of Education and Research (BMBF) within the project **Open6GHub** under grant numbers 16KISK003K and 16KISK004.

7 List of Acronyms

QoS Quality of Service	2
FCFS First Come First Server	2
LCFS Last Come First Serve	2
QBD Quasi-Birth-Death	8
IID Identical and Independently Distributed	7
MEC Multi-access Edge Computing	19
5G Fifth Generation	1
6G Sixth Generation	2
SLA Service Level Agreements	2
NSGA Non-Dominated Sorting Genetic Algorithm	17
MOP multi-objective optimization problems	17
MLCFLP Multi-Layered Congested Facility Location Problem	17
FLP Facility location problems	17
M/M/C Markovian/ Markovian/ number of queues	2
G/G/C General/ General/ number of queues	2
E/PH/C Erlang _k / Phase-type Distribution/ queues	2
RAN Radio Access Network	2
O-RAN Open Radio Access Network	1
CP Control Plane	2
DU Distributed Unit	2
RRU Remote Radio Unit	2
UP User Plane	2
CU Control Unit	2

SIRO Serve In Random Order	2
BBU Baseband Unit	2

References

- [1] Ivo Adan, J. Wessels, and W. Henk M. Zijm. 1993. Matrix-geometric analysis of the shortest queue problem with threshold jockeying. *Operations Research Letters* 13 (03 1993), 107–112. [https://doi.org/10.1016/0167-6377\(93\)90037-H](https://doi.org/10.1016/0167-6377(93)90037-H)
- [2] Ivo J. B. F. Adan, Wessels Jaap., and W. Henk M. Zijm. 1991. Analysis of the Asymmetric Shortest Queue Problem. *Queueing Syst. Theory Appl.* 8, 1 (2 1991), 1–58. <https://doi.org/10.1007/BF02412240>
- [3] Ivo J. B. F. Adan, Jaap Wessels, and W. Henk M. Zijm. 1991. Analysis of the asymmetric shortest queue problem with threshold jockeying. *Communications in Statistics. Stochastic Models* 7, 4 (1991), 615–627. <https://doi.org/10.1080/15326349108807209>
- [4] J. B. F. Ivo Adan, Wessels Jaap, and W. Henk M. Zijm. 1990. Analysis of the symmetric shortest queue problem. *Communications in Statistics. Part C, Stochastic Models* 6 (1990), 691–713. <https://doi.org/10.1080/15326349908807169>
- [5] Erlang Agner Krarup. 1909. Sandsynlighedsregning og Telefonsamtaler. *Nyt tidsskrift for matematik* 20 (1909), 33–39. <http://www.jstor.org/stable/24528622>
- [6] Clinton J. Ancker and A. V. Gafarian. 1963. Some Queuing Problems with Balking and Reneging. I. *Operations Research* 11, 1 (1963), 88–100. <http://www.jstor.org/stable/168146>
- [7] D. Y. Barrer. 1959. Queues, Inventories and Maintenance (Philip M. Morse). *SIAM Rev.* 1, 2 (1959), 186–187. <https://doi.org/10.1137/1001042>
- [8] Brian W. Conolly. 1984. “The Autostrada Queueing Problem.” *Journal of Applied Probability.* *JSTOR* 21, no. 2 (1984), 394–403. <https://doi.org/10.2307/3213648>
- [9] Jim G. Dai. 1995. On Positive Harris Recurrence of Multiclass Queueing Networks: A Unified Approach Via Fluid Limit Models. *The Annals of Applied Probability* 5, 1 (1995), 49–77. <http://www.jstor.org/stable/2245268>
- [10] Jim G. Dai. 1996. A fluid limit model criterion for instability of multi-class queueing networks. *The Annals of Applied Probability* 6, 3 (1996), 751 – 757. <https://doi.org/10.1214/aoap/1034968225>
- [11] Jim G. Dai and Sean P. Meyn. 1995. Stability and convergence of moments for multiclass queueing networks via fluid limit models. *IEEE Trans. Automat. Control* 40, 11 (1995), 1889–1904. <https://doi.org/10.1109/9.471210>
- [12] Amin Dehghanian, Jeffrey P. Kharoufeh, and Mohammad Modarres. 2016. Strategic dynamic jockeying between two parallel queues. *Probability in the Engineering and Informational Sciences* 30, 1 (2016), 41–60. <https://doi.org/10.1017/S0269964815000273>
- [13] Rosario Delgado and Evsey Morozov. 2014. Stability analysis of cascade networks via fluid models. *Performance Evaluation* 82 (2014), 39–54. <https://doi.org/10.1016/j.peva.2014.10.001>
- [14] Rosario Delgado and Evsey V. Morozov. 2014. Stability Analysis of Some Networks with Interacting Servers. *International Conference on Analytical and Stochastic Modeling Techniques and Applications ASMTA 2014* (2014), 1–15. https://doi.org/10.1007/978-3-319-08219-6_1
- [15] William E. DISNEY, Ralph L; MITCHELL. 1970. A Solution for Queues with Instantaneous Jockeying and Other Customer Selection Rules. *Naval Research Logistics* 17 (9 1970), 315–325. <https://doi.org/10.1002/nav.3800170308>
- [16] Douglas G. Down and Mark E. Lewis. 2006. Dynamic load balancing in parallel queueing systems: Stability and optimal control. *European Journal of Operational Research* 168, 2 (2006), 509–519. <https://doi.org/10.1016/j.ejor.2004.04.041> Feature Cluster on Mathematical Finance and Risk Management.

- [17] Elsayed A. Elsayed and Ali S. Bastani. 1985. General solutions of the jockeying problem. *European Journal of Operational Research* 22, 3 (1985), 387–396. [https://doi.org/10.1016/0377-2217\(85\)90258-9](https://doi.org/10.1016/0377-2217(85)90258-9)
- [18] Amir Eshaghi Chaleshtori, Hamed Jahani, and Abdollah Aghaie. 2020. Bi-objective optimization approach to a multi-layer location-allocation problem with jockeying. *Computers & Industrial Engineering* 149 (2020), 106740. <https://doi.org/10.1016/j.cie.2020.106740>
- [19] Robert D. Foley and David R. McDonald. 2001. Join the Shortest Queue: Stability and Exact Asymptotics. *The Annals of Applied Probability* 11, 3 (2001), 569–607. <http://www.jstor.org/stable/2699873>
- [20] Ilya B. Gertsbakh. 1984. The shorter queue problem: A numerical study using the matrix-geometric solution. *European Journal of Operational Research* 15 (1984), 374–381.
- [21] Fabienne Gillent and Guy Latouche. 1983. Semi-explicit solutions for M/PH/1-like queueing systems. *European Journal of Operational Research* 13, 2 (1983), 151–160. [https://doi.org/10.1016/0377-2217\(83\)90077-2](https://doi.org/10.1016/0377-2217(83)90077-2)
- [22] Harold Gumbel. 1960. Waiting Lines with Heterogeneous Servers. *Operations Research* 8, 4 (1960), 504–511. <http://www.jstor.org/stable/167292>
- [23] Frank A. Haight. 1958. Two Queues in Parallel. *Biometrika* 45, 3/4 (1958), 401–410. <http://www.jstor.org/stable/2333187>
- [24] Frank A. Haight. 1960. Queueing with Balking. II. *Biometrika* 47, 3/4 (1960), 285–296. <http://www.jstor.org/stable/2333300>
- [25] Vahid Hajipour, Parviz Fattahi, Madjid Tavana, and Debora Di Caprio. 2016. Multi-objective multi-layer congested facility location-allocation problem optimization with Pareto-based meta-heuristics. *Applied Mathematical Modelling* 40 (2016), 4948–4969.
- [26] Bin Han, Vincenzo Sciancalepore, Yihua Xu, Di Feng, and Hans Schotten. 2022. Impatient Queueing for Intelligent Task Offloading in Multi-Access Edge Computing. *IEEE Transactions on Wireless Communications* PP (01 2022), 1–1. <https://doi.org/10.1109/TWC.2022.3191287>
- [27] Lani Haque, Yiqiang Q. Zhao, and Liming Liu. 2005. Sufficient conditions for a geometric tail in a QBD process with many countable levels and phases. *Stochastic Models* 21, 1 (2005), 77–99. <https://doi.org/10.1081/STM-200046489>
- [28] Refael Hassin and Moshe Haviv. 1994. Equilibrium strategies and the value of information in a two line queueing system with threshold jockeying. *Stochastic Models - STOCH MODELS* 10 (01 1994), 415–435. <https://doi.org/10.1080/15326349408807302>
- [29] Qiming He and Marcel F. Neuts. 2002. Two M/M/1 Queues with Transfers of Customers. *Queueing Systems* 42 (2002), 377–400.
- [30] Tao Jiang and Li-Wei Liu. 2016. Tail Asymptotics of Two Parallel Queues with Transfers of Customers. *Journal of the Operations Research Society of China* 4 (04 2016). <https://doi.org/10.1007/s40305-016-0127-1>
- [31] Michelle H. Kallmes, D. Towsley, and Christos G. Cassandras. 1989. Optimality of the last-in-first-out (LIFO) service discipline in queueing systems with real-time constraints. *Proceedings of the 28th IEEE Conference on Decision and Control*, 2, 0 (1989), 1073–1074. <https://doi.org/10.1109/CDC.1989.70296>
- [32] Edward P.C. Kao and Chiunsin Lin. 1990. A matrix-geometric solution of the jockeying problem. *European Journal of Operational Research* 44, 1 (1990), 67–74. [https://doi.org/10.1016/0377-2217\(90\)90315-3](https://doi.org/10.1016/0377-2217(90)90315-3)
- [33] David G. Kendall. 1953. Stochastic Processes Occurring in the Theory of Queues and their Analysis by the Method of the Imbedded Markov Chain. *The Annals of Mathematical Statistics* 24, 3 (1953), 338–354. <http://www.jstor.org/stable/2236285>
- [34] John Frank C. Kingman. 1961. Two Similar Queues in Parallel. *The Annals of Mathematical Statistics* 32, 4 (1961), 1314–1323. <http://www.jstor.org/stable/2237929>
- [35] John Frank C. Kingman. 1962. On queues in which customers are served in random order. *Mathematical Proceedings of the Cambridge Philosophical Society* 58 (1962), 79 – 91.
- [36] Ernest Koenigsberg. 1966. On Jockeying in Queues. *Management Science* 12 (1966), 412–436.
- [37] Ger Koole. 1996. On the Pathwise Optimal Bernoulli Routing Policy for Homogeneous Parallel Servers. *Mathematics of Operations Research* 21, 2 (1996), 469–476. <http://www.jstor.org/stable/3690243>
- [38] Guy Latouche and V. Ramaswami. 1987. *Introduction to Matrix Analytic Methods in Stochastic Modelling*. Society for Industrial and Applied Mathematics, Philadelphia.
- [39] Vlada Limic. 2001. A LIFO Queue in Heavy Traffic. *The Annals of Applied Probability* 11, 2 (2001), 301–331. <http://www.jstor.org/stable/2667250>
- [40] Bing Lin, Yuchen Lin, and Rohit Bhatnagar. 2022. Optimal Policy for Controlling Two-Server Queueing Systems with Jockeying. *Journal of Systems Engineering and Electronics* 33, 1 (2022), 144–155. <https://doi.org/10.23919/JSEE.2022.000015>
- [41] Andrey Andreyevich Markov. 1906. Extension of the law of large numbers to quantities dependent of each other [Rasprostraneniye zakona bolshikh chisel na velichiny, zavisyashchiye drug ot druga]. *Izvestiya fiziko-matematicheskogo obshchestva pri Kazanskom universitete [Proceedings of Physical and Mathematical Society at the University of Kazan]* 2, 15 (1906), 135–156.
- [42] Simon P. Martin and Isi Mitran. 2008. Analysis of job transfer policies in systems with unreliable servers. *Annals of Operations Research* 162 (2008), 127–141.
- [43] Sean P. Meyn and Richard L. Tweedie. 1993. Stability of Markovian Processes III: Foster-Lyapunov Criteria for Continuous-Time Processes. *Advances in Applied Probability* 25, 3 (1993), 518–548. <http://www.jstor.org/stable/1427522>
- [44] Ronald E. Mickens. 2015. *Difference Equations: Theory, Applications and Advanced Topics*. Vol. Third Edition. Chapman and Hall/CRC., London. <https://doi.org/10.1201/b18186>
- [45] Masakiyo Miyazawa and Yiqiang Q. Zhao. 2004. The Stationary Tail Asymptotics in the GI/G/1-Type Queue with Countably Many Background States. *Advances in Applied Probability* 36, 4 (2004), 1231–1251. <http://www.jstor.org/stable/4140396>
- [46] Marcel F. Neuts. 1986. The caudal characteristic curve of queues. *Advances in Applied Probability* 18, 1 (1986), 221–254. <https://doi.org/10.2307/1427244>
- [47] Marcel Fernand Neuts. 1994. *Matrix-geometric Solutions in Stochastic Models: An Algorithmic Approach*. Dover Publications, New York. <https://books.google.de/books?id=WPol7RVptz0C>
- [48] S.D. Poisson and S.D. Poisson. 1837. *Recherches sur la probabilité des jugements en matière criminelle et en matière civile: précédées des règles générales du calcul des probabilités*. Bachelier, online. https://books.google.de/books?id=_8FAjzHfzHgC
- [49] Martin L. Puterman. 1994. *Markov Decision Processes: Discrete Stochastic Dynamic Programming* (1st ed.). John Wiley and Sons, Inc., USA.
- [50] V. Ramswami and Guy Latouche. 1986. A general class of Markov processes with explicit matrix-geometric solutions. *Operations-Research-Spektrum* 8 (1986), 209–218.
- [51] Rachel Ravid. 2021. A new look on the shortest queue system with jockeying. *Probability in the Engineering and Informational Sciences* 35, 3 (2021), 557–564. <https://doi.org/10.1017/S0269964819000469>
- [52] Seyed Mahdi Shavarani, Sam Mosallaeipour, Mahmoud Golabi, and Gökhan İzbirak. 2019. A congested capacitated multi-level fuzzy facility location problem: An efficient drone delivery system. *Computers & Operations Research* 108 (2019), 57–68. <https://doi.org/10.1016/j.cor.2019.04.001>
- [53] Wolfgang Stadje. 2009. A Queueing System with Two Parallel Lines, Cost-Conscious Customers, and Jockeying. *Communications in Statistics - Theory and Methods* 38:16-17 (2009), 3158–3169. <https://doi.org/10.1080/03610920902947618>
- [54] Ahmed M.K. Tarabia. 2009. Transient analysis of two queues in parallel with jockeying. *Stochastics* 81, 2 (2009), 129–145. <https://doi.org/10.1080/03610920902947618>

[1080/17442500802200658](https://doi.org/10.1080/17442500802200658)

- [55] Ahmed M. K. Tarabia. 2008. Analysis of two queues in parallel with jockeying and restricted capacities. *Applied Mathematical Modelling* 32 (2008), 802–810.
- [56] J. W. J. Williams. 1964. Algorithm 232 - Heapsort. *Communications of ACM* 7, 6 (6 1964), 347–348. <https://doi.org/10.1145/512274.512284>
- [57] J. W. J. Williams. 1964. Algorithm 245 - Treesort. *Communications of ACM* 7, 12 (12 1964), 701. <https://doi.org/10.1145/355588.365103>
- [58] Susan H. Xu and Y. Quennel Zhao. 1996. Dynamic routing and jockeying controls in a two-station queuing system. *Advances in Applied Probability* 28, 4 (1996), 1201–1226. <https://doi.org/10.2307/1428170>
- [59] Y. Zhao and Grassmann K. Winfried. 1995. Queuing Analysis of a Jockeying Model. *Operations Research* 43, 3 (1995), 520–529. <http://www.jstor.org/stable/171875>
- [60] Yiqiang Q. Zhao and Winfried K. Grassmann. 1990. The shortest queue model with jockeying. *Naval Research Logistics* 37 (1990), 773–787.