

AN ELABORATE NEW PROOF OF CAYLEY'S FORMULA

ESTHER BANAIAN, ANH TRONG NAM HOANG, ELIZABETH KELLEY, WESTON MILLER,
JASON STACK, CAROLYN STEPHEN, AND NATHAN WILLIAMS

ABSTRACT. We construct a bijection between certain Deodhar components of a braid variety constructed from an affine Kac-Moody group of type A_{n-1} and vertex-labeled trees on n vertices. By an argument of Galashin, Lam, and Williams using Opdam's trace formula in the affine Hecke algebra and an identity due to Haglund, we obtain an elaborate new proof for the enumeration of the number of vertex-labeled trees on n vertices.

1. INTRODUCTION

1.1. **Introduction.** It is well-known that the following sets have size n^{n-2} :

- TREE_n , the set of vertex-labeled trees with n vertices [Cay89] (*Cayley's formula*); and
- FACT_n , the set of factorizations of the long cycle $(1, 2, \dots, n)$ in the symmetric group S_n into a product of $(n-1)$ transpositions [GJ97].

But finding a bijection between TREE_n and FACT_n is surprisingly tricky (for a discussion, we refer the reader to the excellent paper [GY02]; see also [Sta97]).

It turns out to be much easier to show that

$$(n-1)!|\text{TREE}_n| = (n-1)!|\text{FACT}_n|.$$

We quickly sketch the bijection. The factor $(n-1)!$ on the left-hand side comes from labeling the $n-1$ edges of a vertex-labeled tree bijectively with the numbers $[n-1] := \{1, 2, \dots, n-1\}$. Recording the edges in order of increasing edge-label—where the edge between vertex i and vertex j is recorded as the transposition (i, j) —gives a bijection between vertex- and edge-labeled trees and factorizations of *all* $(n-1)!$ long cycles in S_n into $(n-1)$ transpositions. The tricky bit is to identify which vertex- and edge-labeled trees have image in the original set FACT_n (the answer relies on a certain embedding).

In this paper, we consider related problems in the *affine* symmetric group \tilde{S}_n .

1.2. **The affine symmetric group.** The *affine symmetric group* \tilde{S}_n can be thought of as the group of bijections $\tilde{w} : \mathbb{Z} \rightarrow \mathbb{Z}$ such that [BB05, Chapter 8]

$$(1.1) \quad \tilde{w}(i+n) = \tilde{w}(i) + n \text{ and } \sum_{i=1}^n \tilde{w}(i) = \binom{n+1}{2}.$$

Recall that the reflections of \tilde{S}_n swap i and j for $i, j \in \mathbb{Z}$ with $i \not\equiv j \pmod{n}$, and are written $((i, j))$.

We will be interested in certain factorizations into reflections of the element $\lambda_n \in \tilde{S}_n$ that acts on \mathbb{R}^n by the translation

$$\lambda_n : x \mapsto x + (1, 1, \dots, 1, -n+1).$$

Then λ_n can be expressed as a product of $2n-2$ reflections (and not fewer). This λ_n will play the role of the long cycle.

1.3. **Trees.** A reflection factorization for λ_n

$$r = [((a_0, b_1)), ((a_1, b_2)), \dots, ((a_{2n-3}, b_{2n-2}))]$$

is called *tree-like* if $a_{k-1} < b_k$ and $a_k = b_k \pmod{n}$. We write $\tilde{\text{FACT}}_n$ for the set of all tree-like factorizations of λ_n .

Theorem 3.10. *There is a bijection between TREE_n and $\tilde{\text{FACT}}_n$, where TREE_n is the set of plane-embedded vertex-labeled trees on $[n]$ with a marked edge adjacent to the vertex n (up to orientation preserving homeomorphism of the plane).*

Corollary 3.12. *For all $n \geq 2$, the number of tree-like factorizations of λ_n is*

$$|\widetilde{\text{FACT}}_n| = n! \text{Cat}(n),$$

where $\text{Cat}(n) = \frac{1}{n+1} \binom{2n}{n}$ is the n th Catalan number.

1.4. Cyclic trees. For each vertex-labeled tree, we will specify a preferred *cyclic* embedding in the plane. Given a vertex-labeled tree $T \in \text{TREE}_n$, its *cyclic* embedding is given as follows: draw T so that for every vertex $i \in [n]$ its neighboring vertices j increase clockwise—with the exception that for $i \neq n$, i 's neighbor on the unique path from the vertex n to i is read as the central label i . The marked edge is the edge from n to its smallest neighbor. An example of a cyclically-embedded tree is given in Figure 1.

The restriction of Corollary 3.12 to cyclically-embedded trees gives the notion of cyclic factorizations $\widetilde{\text{FACT}}_n$.

1.5. Subwords. The factorizations in our version of the problem appear as labelings of certain Deodhar components for a braid variety constructed from an affine Kac-Moody group of type A_{n-1} . Write SUB_n for the set of *maximal distinguished subwords* of the word

$$\lambda_n := [s_0, s_1, \dots, s_{n-1}]^{n-1}.$$

For simplicity in the introduction, we define SUB_n to be the set of subwords with $2n-2$ skips whose product is the identity (the equivalence with the usual definition is proven in Corollary 5.15). An example of an element of SUB_n is given in Figure 1.

1.6. Subwords and cyclic trees. Our main theorem is a bijection between SUB_n and (cyclically-embedded) trees.

Theorem 6.1. *There is a bijection between SUB_n and TREE_n .*

1.7. Enumeration. In previous work, SUB_n was counted by Galashin, Lam, and Williams using braid varieties, a trace formula in the affine Hecke algebra due to Opdam, and an identity due to Haglund [Wil23].

Theorem 7.4 (P. Galashin, T. Lam, N. Williams).

$$|R_{\lambda_n}(\mathbb{F}_q)| = (q-1)^{2n-2} [n]_q^{n-2} \quad \text{and} \quad |\text{SUB}_n| = n^{n-2}.$$

Theorems 6.1 and 7.4 together give an elaborate new proof for the enumeration of TREE_n .

Corollary 7.5 (Cayley's formula). $|\text{TREE}_n| = n^{n-2}$.

Remark 1.1. Since the maximal distinguished subwords SUB_n are naturally in bijection with trees, it makes sense to consider the braid variety $R_{\lambda_n}(\mathbb{F}_q)$ to be a q -analogue of vertex-labeled trees. Compare with [Lei21], which gives a very different q -analogue as the number of nilpotent linear operators on \mathbb{F}_q^n .

The remainder of this paper has the same structure as the introduction, with a final section on future work.

2. THE AFFINE SYMMETRIC GROUP

The *affine symmetric group* \widetilde{S}_n can be thought of as the group of bijections $\widetilde{w} : \mathbb{Z} \rightarrow \mathbb{Z}$ such that [BB05, Chapter 8]

$$(2.1) \quad \widetilde{w}(i+n) = \widetilde{w}(i) + n \quad \text{and} \quad \sum_{i=1}^n \widetilde{w}(i) = \binom{n+1}{2}.$$

We write $((i, j))$ for the *affine reflection* that interchanges i and j (simultaneously interchanging $i+kn$ and $j+kn$ for every $k \in \mathbb{Z}$); thus, $((i, j)) = ((i+kn, j+kn))$. We denote by $s_j := ((j, j+1))$ the *simple reflections*. For clarity of typesetting, we use the notation $\bar{i} := i - n$. We write $i \bmod n$ for the representative between 1 and n equal to i modulo n .

The *reflection length* of $w \in \widetilde{S}_n$ is the minimal number of reflections required to express w as a product of reflections.

Proposition 2.1. *For $0 \leq i < n$, $s_i = ((i, i+1))$ is a right descent of $w \in \widetilde{S}_n$ iff $w(i) > w(i+1)$.*

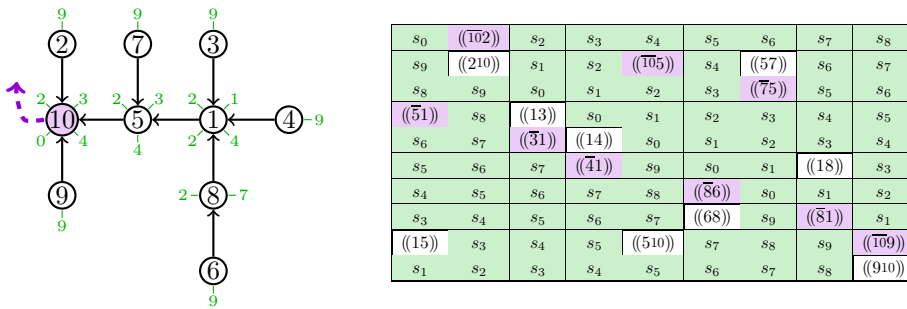

FIGURE 1. Our running example. *Left*: a cyclically-embedded vertex-labeled tree in TREE_9 (for now, ignore the arrows, green edges, and green labels). *Right*: the corresponding maximal distinguished subword $u \in \text{SUB}_{10}$, with takes in green, and skips in white and purple (decorated by the corresponding skip reflection, with the convention that $\bar{i} := i - n$).

Proposition 2.2. Let λ_n be the translation that acts on \mathbb{R}^n by

$$\lambda_n : x \mapsto x + (1, 1, \dots, 1, -n + 1).$$

Then λ_n is an element of \tilde{S}_n with:

- reduced word in simple reflections $(s_0 s_1 \cdots s_{n-1})^{n-1}$;
- one-line notation

$$[n + 1, n + 2, \dots, 2n - 1, -n(n - 2)]; \text{ and}$$

- cycle notation

$$\left(\prod_{i=1}^{n-1} (\dots, i - n, i, i + n, \dots) \right) \left(\prod_{m=0}^{n-1} (\dots, nm + n(n - 1), nm, nm - n(n - 1), \dots) \right).$$

Furthermore, λ_n has reflection length $2n - 2$.

Proof. The three descriptions are simple computations. The reflection length is easily deduced from [MP11, Proposition 4.3] (see also [LMPS19, Theorem 4.25]). \square

From its cycle decomposition, we see that λ_n acts on the integers as follows: it sends $k = 0 \pmod n$ to $k - n(n - 1)$, and it sends $k \neq 0 \pmod n$ to $k + n$.

3. TREES

In Section 3.1, we describe sets of certain *tree-like* factorizations of λ_n in the affine symmetric group, which we will show in Section 3.2 are encoded by clockwise walks around embedded vertex-labeled trees.

Given a finite sequence of reflections $r = [(a_0, b_1), (a_1, b_2), \dots]$ and $k \in [n]$, write $r_\ell = ((a_{\ell-1}, b_\ell))$ for the ℓ th reflection in the sequence. We say that r is a *factorization* of $w \in \tilde{S}_n$ if $w = \prod_i ((a_i, b_{i+1}))$; it is of *minimal length* if the number of reflections is equal to the reflection length of w . For $w \in \tilde{S}_n$, write $\text{FACT}(w)$ for the set of its minimal length reflection factorizations.

3.1. Tree-like factorizations.

Definition 3.1. A minimal length reflection factorization

$$r = [(a_0, b_1), (a_1, b_2), \dots, (a_{2n-3}, b_{2n-2})] \in \text{FACT}(\lambda_n)$$

is *tree-like* if $a_{k-1} < b_k$ and $a_k = b_k \pmod n$. We write $\tilde{\text{FACT}}_n$ for the set of all tree-like factorizations of λ_n .

Example 3.2. For $n = 10$, the following factorization (see [Figure 1](#)) is tree-like:

$$r = \left[((\overline{102}), ((210)), ((\overline{105})), ((57)), ((\overline{75})), ((\overline{51})), ((13)), ((\overline{31})), ((14)), \right. \\ \left. ((\overline{41})), ((18)), ((\overline{86})), ((68)), ((\overline{81})), ((15)), ((510)), ((\overline{109})), ((910)) \right].$$

We say that a reflection r_ℓ *increases* an integer k if

$$r_\ell r_{\ell+1} \cdots r_{2n-2}(k) > r_{\ell+1} \cdots r_{2n-2}(k),$$

and we say r_ℓ *decreases* k if

$$r_\ell r_{\ell+1} \cdots r_{2n-2}(k) < r_{\ell+1} \cdots r_{2n-2}(k).$$

Since each r_ℓ is a reflection, there exist unique distinct integers $a, b \in [n]$ such that r_ℓ increases a and decreases b . For

$$r = [((a_0, b_1)), ((a_1, b_2)), \dots, ((a_{2n-3}, b_{2n-2}))] \in \widetilde{\text{FACT}}_n,$$

write

$$(3.1) \quad \text{nb}(r, k) = [b_{i_1} \bmod n, \dots, b_{i_\ell} \bmod n]$$

for the sequence of b_{i_j} (modulo n) for which $a_{i_j-1} = k \bmod n$ (the abbreviation is for *neighbors*).

Example 3.3. If we track the progression of the integer 0 in [Example 3.2](#) as the list of products $r_\ell r_{\ell+1} \cdots r_{2n-2}(0)$ for $\ell = 1, \dots, 2n-2$, we obtain the sequence

$$[-90, -88, -80, -75, -73, -65, -59, -57, -49, \\ -46, -39, -32, -24, -22, -19, -15, -10, -1].$$

Note that every reflection decreases 0. On the other hand, 1 is unchanged until the 15th reflection $((15))$, which increases 1 to 5, and is next modified by the 6th reflection $((\overline{51}))$, which increases 5 to 11. Observe that exactly two reflections increase 1.

We make the observations of [Example 3.3](#) precise in the following proposition, which gives a condition on factorizations equivalent to being tree-like. This equivalent condition will be easier to check on the factorizations arising from distinguished subwords in [Section 5](#).

Proposition 3.4. *A factorization $r = [r_1, r_2, \dots, r_{2n-2}] \in \text{FACT}(\lambda_n)$ is tree-like if and only if there exist $a_0, \dots, a_{2n-2} \in \mathbb{Z}$ such that*

$$(3.2) \quad r_\ell = ((a_{\ell-1}, a_\ell)) \text{ and } |a_\ell - a_{\ell-1}| < n \text{ for } \ell = 1, \dots, 2n-2.$$

Proof. First suppose that $r \in \text{FACT}(\lambda_n)$ is tree-like. Then we can choose

$$a_0 < \cdots < a_{2n-2}$$

such that $r_\ell = ((a_{\ell-1}, a_\ell))$. Since for any $1 \leq \ell < 2n-2$

$$r_\ell \cdots r_{2n-2}(a_{2n-2}) = a_{\ell-1} < a_{2n-2},$$

it follows that every r_ℓ decreases a_{2n-2} . So we must have $a_0 = a_{2n-2} = 0 \bmod n$ because the only integers that λ_n decreases are the multiples of n .

Now since λ_n maps each $k \in [n-1]$ to $k+n$, there must exist at least two r_ℓ which either increase or decrease k . But each r_ℓ decreases n and increases some $k \neq n$, so by a pigeonhole argument, there are in fact exactly two unique factors r_ℓ for each $k \neq n$ which increase k . If r_i and r_j are the two factors which increase k , then

$$k+n = r_1 \cdots r_{2n-2}(k) = k + (a_i - a_{i-1}) + (a_j - a_{j-1}).$$

So we must have $a_\ell - a_{\ell-1} < n$ for all ℓ .

For the other direction, fix $r \in \text{FACT}(\lambda_n)$ satisfying [Equation \(3.2\)](#). Note that the second condition $|a_\ell - a_{\ell-1}| < n$ implies that for a given $k \neq n$ there must exist $1 \leq i < j \leq 2n-2$ such that r_i and r_j increase k . Since we only have $2n-2$ factors, it follows again from a pigeonhole argument that each factor *must* increase some $k \neq n$, and for each $k \neq n$, there are exactly two r_ℓ which increase k .

Now, since 0 is sent to $-n(n-1)$ and each r_ℓ can only decrease 0 by at most $n-1$, we have that 0 needs to be decreased by at least n of the r_ℓ . Note that a_{2n-2} is either increased or decreased by

every r_ℓ . If $a_{2n-2} \not\equiv 0 \pmod n$, then a_{2n-2} is increased by exactly two of the r_ℓ and decreased by all the others. Since each r_ℓ decreases only one integer $\pmod n$, it follows that the two factors which increase a_{2n-2} are the only factors that can decrease n . So we must have $n = 2$. But in that case, there is only one minimal length reflection factorization of λ_2 satisfying Equation (3.2):

$$((0, 1))((1, 2)) = ((3, 2))((2, 1)).$$

This factorization is tree-like, so the equivalence also holds for $n = 2$.

For $n > 2$, it follows that $a_{2n-2} \equiv 0 \pmod n$. Since none of the r_ℓ increase 0 (since every r_ℓ increases a $k \in [n-1]$), it follows that all r_ℓ must decrease 0. This implies that

$$a_0 < a_1 < \cdots < a_{2n-2},$$

so that r is tree-like. \square

Since every reflection r_ℓ must decrease 0, we immediately obtain the following corollaries.

Corollary 3.5. *Let $r \in \widetilde{\text{FACT}}_n$ with $r_\ell = ((a_{\ell-1}, a_\ell))$. Then $a_0 = a_{2n-2} \equiv 0 \pmod n$.*

Corollary 3.6. *For $k \in [n-1]$, there are exactly two reflections that increase k —the first and last reflections to use a number equal to $k \pmod n$. We denote these reflections*

$$\begin{aligned} r_1^k &= ((\bar{b}_k, k)) \text{ and } r_2^k = ((k, b_k)) \text{ if } b_k > k \text{ and} \\ r_1^k &= ((b_k, k)) \text{ and } r_2^k = ((\bar{k}, b_k)) \text{ if } b_k < k. \end{aligned}$$

We call r_1^k the **left end** of its pair and r_2^k the **right end** of its pair.

Proof. In the proof of Proposition 3.4, we observed that for each $k \neq n$, there are unique factors r_i and r_j , where $i < j$, which increase k , and every r_ℓ is in one of these pairs. Assume $b_k > k$. Then $r_\ell \cdots r_{2n-2}(k) = k$ for $\ell > j$, so $r_j = ((k, b_k))$ for some $b_k > k$. Moreover,

$$r_\ell \cdots r_{2n-2}(k) = \begin{cases} b_k & \text{if } i < \ell \leq j, \\ k + n & \text{if } \ell \leq i, \end{cases}$$

so $r_i = ((b_k, k + n)) = ((\bar{b}_k, k))$. The case for $b_k < k$ is similar. \square

3.2. Tree embeddings.

Definition 3.7. We write TREE_n for the set of plane-embedded vertex-labeled trees on $[n]$ with a marked edge adjacent to the vertex n (up to orientation preserving homeomorphism of the plane).

Example 3.8. The $30 = 3! \cdot \text{Cat}(3)$ trees in TREE_4 are illustrated in Figure 2.

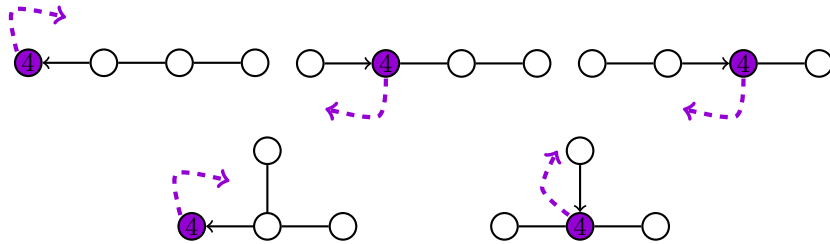

FIGURE 2. The $30 = 3! \cdot \text{Cat}(3)$ trees in TREE_4 . Each tree has only the vertex 4 labeled, and so corresponds to $3!$ vertex-labeled trees in TREE_4 by choosing a labeling of the unlabeled vertices by 1, 2, 3.

Given an embedded vertex-labeled tree $T \in \text{TREE}_n$, we produce a sequence r^T of $2n - 2$ affine reflections (this sequence will turn out to be a tree-like factorization of λ_n). Starting at the vertex labeled n , walk around the embedded tree T clockwise (so that every edge is traversed exactly twice)—initially walking along the marked edge adjacent to n . Record the edges visited as

$$(3.3) \quad \left[(v_0, v_1), (v_1, v_2), \dots, (v_{2n-3}, v_{2n-2}) \right]$$

with the convention that $v_0 = n$ and $v_{2n-2} = n$. Then r^T is defined to be the following sequence of $2n - 2$ affine reflections:

$$r^T := \left[((i_1, j_1)), ((i_2, j_2)), \dots, ((i_{2(n-1)}, j_{2(n-1)})) \right], \text{ where}$$

$$((i_k, j_k)) := \begin{cases} ((v_{k-1}, v_k)) & \text{if } v_{k-1} < v_k \\ ((\bar{v}_{k-1}, v_k)) & \text{if } v_{k-1} > v_k \end{cases} \text{ and } \bar{i} = i - n.$$

Conversely, given $r \in \widetilde{\text{FACT}}_n$, we define a corresponding plane embedded tree T^r . T^r has vertex set $[n]$; for each reflection r_i that can be written as $((a, b))$ with $1 \leq a < b \leq n$, there is an edge connecting a and b (exactly half the reflections have this property by [Corollary 3.6](#)). It follows from [Definition 4.1](#) that T^r is connected, and so it must be a tree since it has only $n - 1$ edges. The embedding of T^r is determined by placing the neighbors of vertex k clockwise around k in the order in which they appear in $\text{nb}(r, k)$.

Example 3.9. The factorization r in [Example 3.2](#) corresponds to the embedded tree T in [Figure 1](#), where the marked edge adjacent to 10 is $(10, 2)$.

Theorem 3.10. *For any embedded vertex-labeled tree $T \in \text{TREE}_n$, r^T is a tree-like factorization. For any tree-like factorization $r \in \widetilde{\text{FACT}}_n$, T^r is an embedded vertex-labeled tree. The maps $T \mapsto r^T$ and $r \mapsto T^r$ are mutually inverse bijections between TREE_n and $\widetilde{\text{FACT}}_n$.*

Proof. We first show that r^T is a factorization in $\text{FACT}(\lambda_n)$. For $1 \leq i \leq n - 1$ and $m \in \mathbb{Z}$, we wish to show that $i + mn$ is sent to $i + (m + 1)n$ to conclude that the composition of reflections produced by r^T gives the first product of cycles in [Proposition 2.2](#). By periodicity, it is enough to show this for $m = 0$.

We will compute the composition of the reflections from right to left and show that we obtain λ_n . We record the list of reflections by starting at the vertex labeled n and walking around the tree T counterclockwise, initially walking along the marked edge incident with n . This allows us to read the list of vertices in [Equation \(3.3\)](#) from right to left. Suppose the first edge using the vertex i encountered on this counterclockwise walk is the edge (j, i) traversed from the vertex j to i .

- If $i < j$, then we record the reflection $((i, j))$, which sends i to j —and all edges encountered until we revisit the edge (i, j) (now traversed from the vertex i to j) do not involve j . The second time the edge is revisited, we record the reflection $((j - n, i)) = ((j, i + n))$, and thus sends j to $i + n$.
- If $i > j$, then we record the reflection $((i - n, j))$, which sends i to $j + n$. Until we walk on this edge again, all other edges will not affect j . The second time the edge is revisited, we record the reflection $((j, i)) = ((j + n, i + n))$, which sends $j + n$ to $i + n$.

In each case, we conclude that i is sent to $i + n$.

It remains to show that r^T also gives the second product of cycles in [Proposition 2.2](#)—again by periodicity, it is enough to show n is sent to $n - n(n - 1)$. Since for every $1 \leq i < j \leq n$ every edge (i, j) is traversed twice, once as just (i, j) and once as $(j - n, i)$, and since every pair of adjacent reflections share a letter, n is subtracted from the quantity exactly $(n - 1)$ times—once for each pair of edges on the walk. Thus, n is sent to $n - n(n - 1)$, as desired.

By construction, the factorization r^T of λ_n satisfies [Definition 3.1](#), and so is tree-like. It is clear that the inverse is given by the map $r \mapsto T^r$. \square

Corollary 3.11. *Let $r = [r_1, r_2, \dots, r_{2n-2}] \in \widetilde{\text{FACT}}_n$, and write $r_\ell = ((a_{\ell-1}, a_\ell))$ with $a_0 < \dots < a_{2n-2}$. Then*

- (i) *If $((a_{\ell-1}, a_\ell))$ is to the left of r_1^k or to the right of r_2^k , then $a_{\ell-1}, a_\ell \not\equiv k \pmod n$.*
- (ii) *If $((a_{\ell-1}, a_\ell))$ is between r_1^k and r_2^k , then $a_{\ell-1}, a_\ell \not\equiv b_k \pmod n$.*
- (iii) *$((a_{\ell-1}, a_\ell))$ is between r_1^k and r_2^k iff $((\bar{a}_\ell, a_{\ell-1}))$ is also between r_1^k and r_2^k .*

3.3. Enumeration. The bijection of [Theorem 3.10](#) gives the following interesting enumeration for the tree-like factorizations of λ_n .

Corollary 3.12. *For all $n \geq 2$, the number of tree-like factorizations of λ_n is*

$$|\widetilde{\text{FACT}}_n| = n! \text{Cat}(n),$$

where $\text{Cat}(n) = \frac{1}{n+1} \binom{2n}{n}$ is the n th Catalan number.

Proof. The number of rooted planar trees with n vertices is $\text{Cat}(n)$. By marking an edge, we remove any symmetries. Since the number of plane-embedded vertex-labeled trees with n vertices is $n!\text{Cat}(n)$, we conclude the same enumeration for $\widetilde{\text{FACT}}_n$ by Theorem 3.10. \square

Remark 3.13. Corollary 3.12 is not our titular “elaborate proof”—we are relying on previous combinatorial enumerations of rooted planar trees. The issue is that we do not know what braid varieties over the loop group for SL_n correspond to tree-like factorizations; Minh-Tâm Trinh has constructed certain “generalized Steinberg varieties” using unipotent elements that give this enumeration—but using the simple Lie group and not its loop group.

4. CYCLIC TREES

In Section 4.1, we describe sets of certain *cyclic* factorizations of λ_n in the affine symmetric group, which we will show in Section 4.2 are encoded by clockwise walks around *cyclically-embedded* vertex-labeled trees.

4.1. Cyclic factorizations.

Definition 4.1. A tree-like factorization

$$r = [(a_0, b_1), (a_1, b_2), \dots, (a_{2n-3}, b_{2n-2})] \in \widetilde{\text{FACT}}_n$$

is *cyclic* if

(i) if $\text{nb}(r, n) = [b_{i_1}, \dots, b_{i_\ell}]$ then

$$b_{i_1} < \dots < b_{i_\ell}; \text{ and}$$

(ii) for any $1 \leq k < n$, if $\text{nb}(r, k) = [b_{i_1}, \dots, b_{i_\ell}]$, then there exists some $1 \leq j \leq \ell$ for which

$$b_{i_j} < b_{i_{j+1}} < \dots < b_{i_{\ell-1}} < k < b_{i_1} < \dots < b_{i_{j-1}}.$$

We write $\widetilde{\text{FACT}}_n$ for the set of all cyclic factorizations of λ_n .

Note that b_{i_ℓ} is replaced by k in Definition 4.1 (ii).

Example 4.2. The tree-like factorization in Example 3.2 is also cyclic. Definition 4.1 (i) is satisfied because $\text{nb}(r, 10) = [2, 5, 9]$ and $2 < 5 < 9$. As an example of Definition 4.1 (ii), $\text{nb}(r, 1) = [3, 4, 8, 5]$ satisfies $1 < 3 < 4 < 8$.

Our goal now is to give an equivalent characterization of cyclic factorizations, again to more easily connect with the factorizations arising from trees in Section 4.2. We will require the following easy lemma concerning cyclic orderings.

Lemma 4.3. *Suppose that $a, v, b \in \mathbb{Z}$ such that $v - n < a < v < b < v + n$. Let $1 \leq \tilde{a}, \tilde{v}, \tilde{b} \leq n$ be the corresponding values modulo n . Then $a + n < b$ if and only if $\tilde{a} < \tilde{b} < \tilde{v}$, $\tilde{v} < \tilde{a} < \tilde{b}$, or $\tilde{b} < \tilde{v} < \tilde{a}$.*

Proof. Both statements are obviously equivalent to

$$v - n < a < b - n < v < a + n < b < v + n. \quad \square$$

The following proposition will be used to connect cyclic factorizations with distinguished subwords in Section 6.

Proposition 4.4. *Suppose that $r \in \widetilde{\text{FACT}}_n$. By Corollary 3.5, we can write*

$$(r_1 \cdots r_{j-1})r_j(r_{j-1} \cdots r_1) = ((0, m_j)),$$

for each $j = 1, \dots, 2n - 2$. Then r is cyclic if and only if

$$m_1 < \dots < m_{2n-2}.$$

Proof. Suppose that r is a cyclic factorization, and fix $1 \leq j < 2n - 2$. Write $r_j = ((a, v))$ and $r_{j+1} = ((v, b))$ with $a < v < b$. By adding a multiple of n if necessary, we can assume that $r_1 \cdots r_{j-1}(a) = 0$. There are four cases to consider¹, all of which will be handled using Corollary 3.11:

¹These four cases correspond to the four cases in Figure 6 and in Section 6.2.

- (a) Suppose r_j and r_{j+1} are both the left ends of their pairs. Then $m_j = v < b = m_{j+1}$.
- (b) Suppose r_j is the right end of its pair and r_{j+1} is the left end of its pair. Then $m_j = a + n$ and $m_{\ell+1} = b$. By [Proposition 3.4](#) we also know that $v - n < a < v < b < v + n$. It then follows from [Definition 4.1 \(ii\)](#) and [Lemma 4.3](#) that $m_j < m_{j+1}$.
- (c) Suppose r_j and r_{j+1} are both the right ends of their pairs. Then $m_j = a + n < v + n = m_{j+1}$.
- (d) Suppose r_j is the left end of its pair and r_{j+1} is the right end of its pair. Then these must be the same pair, so $a = b - n$, and $m_j = v < v + n = m_{j+1}$.

Suppose now that we have a tree-like factorization with $m_1 < \dots < m_{2n-2}$. We begin by considering [Definition 4.1 \(i\)](#). It follows from [Corollary 3.11](#) that we can write r_1, \dots, r_{2n-2} as

$$((\bar{n}, v_1)), \dots, ((v_1, n)), ((\bar{n}, v_2)), \dots, ((v_2, n)), \dots, ((\bar{n}, v_\ell)), \dots, ((v_\ell, n)).$$

Consider the adjacent factors $r_j = ((v_i, n))$ and $r_{j+1} = ((\bar{n}, v_{i+1}))$. We have $v_{i+1} - v_i = m_{j+1} - m_j > 0$, so $v_i < v_{i+1}$.

Now consider [Definition 4.1 \(ii\)](#). It follows from [Corollary 3.11](#) that we can write r_1, \dots, r_{2n-2} as

$$\dots, ((\bar{a}_\ell, k)), ((k, a_1)), \dots, ((\bar{a}_1, k)), \dots, ((k, a_{\ell-1})), \dots, ((\bar{a}_{\ell-1}, k)), ((k, a_\ell)), \dots,$$

where each $a_i = v_i \bmod n$. Consider the adjacent factors $r_j = ((\bar{a}_i, k))$ and $r_{j+1} = ((k, a_{i+1}))$ for $1 \leq i \leq \ell - 2$. We have $a_{i+1} - a_i = m_{j+1} - m_j > 0$, so $a_i < a_{i+1}$. We also have $k - n < a_i - n < k < a_{i+1} < k + n$, so by [Lemma 4.3](#) either $v_i < v_{i+1} < k$, $k < v_i < v_{i+1}$, or $v_{i+1} < k < v_i$. [Definition 4.1 \(ii\)](#) follows, so that r is cyclic. \square

4.2. Cyclic embeddings.

Definition 4.5. We write TREE_n for the set of vertex-labeled trees (as abstract graphs).

For each vertex-labeled tree, we will now specify a preferred *cyclic* embedding in the plane. (We note that there is some similarity with [\[GY02, Section 3\]](#).)

Definition 4.6. Given a vertex-labeled tree $T \in \text{TREE}_n$, its *cyclic* embedding is given as follows: draw T so that for every vertex $i \in [n]$ its neighboring vertices j increase clockwise—with the exception that for $i \neq n$, i 's neighbor on the unique path from the vertex n to i is read as the central label i . The marked edge is the edge from n to its smallest neighbor.

To make the clockwise increasing condition easy to see in examples, we direct each edge in T towards the vertex n .

Example 4.7. All 16 trees in TREE_4 are drawn in [Figure 3](#) in their cyclic embedding; a larger example is given in [Figure 1](#).

By construction, [Theorem 3.10](#) restricts from all tree-like factorizations and all embeddings to cyclic factorizations and embeddings.

Theorem 4.8. For any cyclically-embedded vertex-labeled tree $T \in \text{TREE}_n$, r^T is a cyclic factorization. For any cyclic factorization $r \in \widetilde{\text{FACT}}_n$, T^r is a cyclically-embedded vertex-labeled tree. The maps $T \mapsto r^T$ and $r \mapsto T^r$ are mutually inverse bijections between TREE_n and $\widetilde{\text{FACT}}_n$.

Remark 4.9. At this point we could use the known enumeration of TREE_n to conclude that $|\widetilde{\text{FACT}}_n| = n^{n-2}$. We will instead connect $\widetilde{\text{FACT}}_n$ to certain maximal distinguished subwords in [Section 5](#), connect these subwords to certain braid varieties in [Section 7.1](#), use representation-theoretic methods to compute the point count of the braid varieties over a finite field with q elements, and then recover the cardinality of $\widetilde{\text{FACT}}_n$ by sending $q \rightarrow 1$.

Remark 4.10. In analogy with the usual problem of minimal reflection factorizations of the long cycle in S_n and the noncrossing partition lattice, it seems natural to define a partial order on the prefixes of cyclic factorizations in \widetilde{S}_n . Unfortunately, for $n \geq 4$ there are maximal chains in this partial order that no longer correspond to cyclic factorizations.

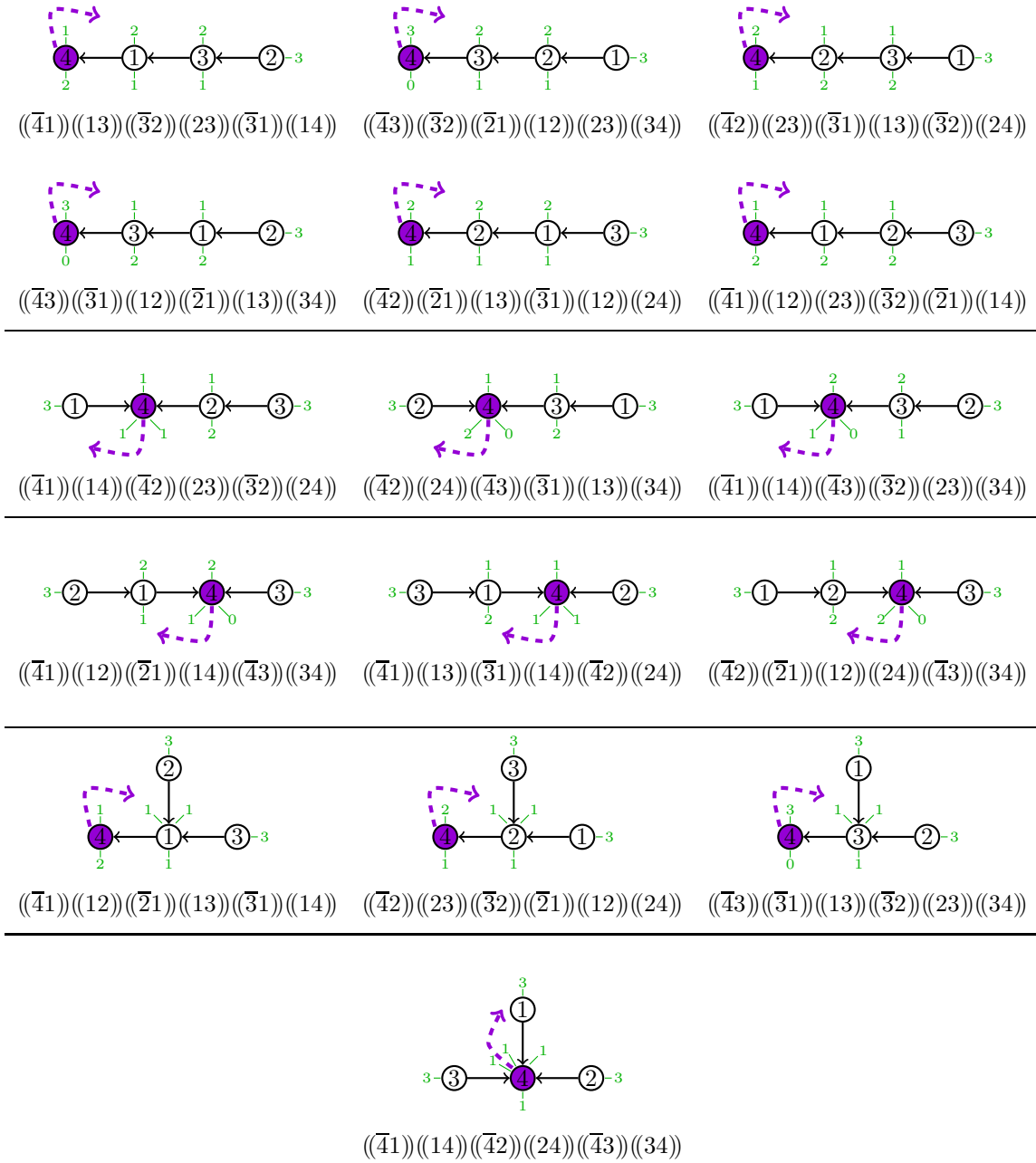

FIGURE 3. The set $TREE_4$, the 16 vertex-labeled trees on 4 vertices, cyclically embedded in the plane according to Section 4.2. Below each tree is the corresponding cyclic factorization of λ_4

5. SUBWORDS

A *subword* u of a sequence $[s_{i_1}, s_{i_2}, \dots, s_{i_m}]$ of simple generators of the affine symmetric group \tilde{S}_n (see Section 2 for more details) is a sequence

$$u = [u_1, u_2, \dots, u_m], \text{ where } u_j \in \{s_{i_j}, e\} \text{ for all } j.$$

We call the letters j for which $u_j = e$, *skips*, and the letters j for which $u_j = s_{i_j}$ *takes*. For any such sequence, we set

$$(5.1) \quad \begin{aligned} u_{(j)} &:= u_1 u_2 \cdots u_j \in \tilde{S}_n, \text{ and} \\ u^{(j)} &:= u_j \cdots u_m \in \tilde{S}_n. \end{aligned}$$

We say \mathbf{u} is a *w-subword* if $u_{(m)} = w$.

5.1. Maximal distinguished subwords.

Definition 5.1. Write SUB_n for the set of *maximal distinguished subwords* of the word

$$\lambda_n := [s_0, s_1, \dots, s_{n-1}]^{n-1}.$$

That is, SUB_n is the set of subwords with $2n - 2$ skips whose product is the identity.

The n consecutive factors of length $n - 1$ of the word λ_n —from the $i(n - 1)$ st letter to the $((i + 1)(n - 1) - 1)$ st letter—will be called *rows*. Drawing λ_n with subsequence rows vertically aligned gives the notion of *columns*. We will typically depicting λ_n or a subword $\mathbf{u} \in \text{SUB}_n$ using an $n \times (n - 1)$ array.

We will show in [Corollary 5.15](#) that for this special case of λ_n , [Definition 5.1](#) recovers the usual notion of *distinguished* [[Deo85](#)].

Example 5.2. The 16 maximal distinguished subwords in SUB_4 are given in [Figure 5](#). A larger example is given in [Figure 1](#). See also [Figure 4](#).

In preparation to connect subwords to trees, we associate a reflection to each skip in a subword in SUB_n .

Definition 5.3. For $\mathbf{u} \in \text{SUB}_n$, define

$$(5.2) \quad \text{INV}(\mathbf{u}) := [r_1, r_2, \dots, r_{n(n-1)}]$$

where $r_k = u_{(i_{k-1})} s_{i_k} u_{(i_{k-1})}^{-1}$ (the notation $u_{(i)}$ is defined in [Equation \(5.1\)](#)). We write r^u for the subsequence of $\text{INV}(\mathbf{u})$ obtained by restricting to the *skips* of \mathbf{u} —that is, restricted to the indices j for which $u_j = e$ —and call the subsequence *skip reflections*.

Remark 5.4. We will show in [Section 6](#) that SUB_n is in bijection with TREE_n —the skip reflections will determine the edges of the corresponding tree.

Example 5.5. [Figure 4](#) illustrates $\text{INV}(\mathbf{u})$ for the maximal distinguished subword from [Figure 1](#).

((101))	((102))	((23))	((24))	((25))	((26))	((27))	((28))	((29))
((21))	((210))	((103))	((104))	((105))	((56))	((57))	((78))	((79))
((71))	((27))	((73))	((74))	((710))	((76))	((75))	((58))	((59))
((51))	((21))	((13))	((34))	((103))	((36))	((73))	((38))	((39))
((35))	((23))	((31))	((14))	((104))	((46))	((74))	((48))	((49))
((45))	((24))	((34))	((41))	((101))	((16))	((71))	((18))	((89))
((58))	((28))	((38))	((48))	((810))	((86))	((76))	((16))	((69))
((56))	((26))	((36))	((46))	((610))	((68))	((78))	((81))	((19))
((15))	((25))	((35))	((45))	((510))	((610))	((710))	((810))	((109))
((19))	((29))	((39))	((49))	((59))	((69))	((79))	((89))	((910))

FIGURE 4. $\text{INV}(\mathbf{u})$ for the maximal distinguished subword from [Figure 1](#). Skips are colored purple.

For a subword $\mathbf{u} = [u_1, \dots, u_{n(n-1)}]$ of λ_n , we encode the pattern of skips in an *indicator word* $\psi(\mathbf{u}) = [\psi_1, \dots, \psi_{n(n-1)}]$, where

$$\psi_i = \begin{cases} 0 & \text{if } u_i = e, \\ 1 & \text{otherwise.} \end{cases}$$

$((\bar{4}1))$	s_1	$((13))$	s_0	s_1	$((\bar{4}3))$	s_0	$((\bar{4}2))$	$((23))$
s_3	$((\bar{3}2))$	s_1	s_3	$((\bar{3}2))$	s_1	$((\bar{3}1))$	s_0	s_1
s_2	$((23))$	$((\bar{3}1))$	$((\bar{2}1))$	s_3	s_0	$((13))$	s_3	$((\bar{3}2))$
$((14))$	s_2	s_3	$((12))$	$((23))$	$((34))$	s_1	$((24))$	s_3
s_0	s_1	$((\bar{4}3))$	s_0	$((\bar{4}2))$	s_2	$((\bar{4}1))$	$((12))$	$((23))$
$((\bar{3}1))$	$((12))$	s_1	$((\bar{2}1))$	s_0	$((13))$	s_3	s_0	$((\bar{3}2))$
s_2	$((\bar{2}1))$	s_0	s_2	s_3	$((\bar{3}1))$	s_2	$((\bar{2}1))$	s_0
$((13))$	s_2	$((34))$	$((12))$	$((24))$	s_3	$((14))$	s_2	s_3
$((\bar{4}1))$	s_1	s_2	s_0	$((\bar{4}2))$	s_2	$((\bar{4}1))$	s_1	s_2
$((14))$	$((\bar{4}2))$	$((23))$	s_3	$((24))$	$((\bar{4}3))$	$((14))$	s_0	$((\bar{4}3))$
s_2	s_3	$((\bar{3}2))$	$((\bar{3}1))$	s_3	s_0	s_2	$((\bar{3}2))$	s_0
s_1	$((24))$	s_3	$((13))$	s_2	$((34))$	s_1	$((23))$	$((34))$
$((\bar{4}1))$	$((12))$	s_2	$((\bar{4}1))$	s_1	$((13))$	s_0	$((\bar{4}2))$	s_2
s_3	$((\bar{2}1))$	s_1	s_3	s_0	$((\bar{3}1))$	$((\bar{2}1))$	s_0	s_1
$((14))$	s_3	$((\bar{4}3))$	$((14))$	$((\bar{4}2))$	s_0	$((12))$	$((24))$	$((\bar{4}3))$
s_1	s_2	$((34))$	s_1	$((24))$	s_3	s_1	s_2	$((34))$
$((\bar{4}1))$	$((12))$	s_2	s_0	$((\bar{4}2))$	$((23))$	s_0	s_1	$((\bar{4}3))$
s_3	$((\bar{2}1))$	$((13))$	s_3	s_0	$((\bar{3}2))$	$((\bar{3}1))$	s_0	s_1
s_2	s_3	$((\bar{3}1))$	$((\bar{2}1))$	s_3	s_0	$((13))$	$((\bar{3}2))$	s_0
$((14))$	s_2	s_3	$((12))$	$((24))$	s_3	s_1	$((23))$	$((34))$
$((\bar{4}1))$	s_1	s_2	$((14))$	$((\bar{4}2))$	s_1	s_2	$((24))$	$((\bar{4}3))$
s_2	$((24))$	$((\bar{4}3))$	s_1	s_2	$((34))$			

FIGURE 5. The 16 distinguished subwords in SUB_4 , with letters chosen in the subword indicated in green, positive skips in white, and negative skips in purple (and replaced by the corresponding inversions). Compare with Figure 3.

We define the *rotation* of a subword, denoted $\text{rot}(\mathbf{u})$ as the subword with indicator word

$$[\psi(\mathbf{u})_{n(n-1)}, \psi(\mathbf{u})_1, \dots, \psi(\mathbf{u})_{n(n-1)-1}].$$

Explicitly, we can write $\text{rot}(\mathbf{u})_i$ in terms of how it acts on the integers via

$$\text{rot}(\mathbf{u})_i = \alpha_+ u_{i-1} \alpha_- ,$$

where $\alpha_+(m) = m + 1$ and $\alpha_-(m) = m - 1$.

Lemma 5.6. *The rotation of an e -subword \mathbf{u} of λ_n is an e -subword.*

Proof. Write $u'_i := \text{rot}(\mathbf{u})_i$. Then

$$\begin{aligned} u'_1 \cdots u'_{n(n-1)} &= \alpha_+ u_{n(n-1)} u_1 \cdots u_{n(n-1)-1} \alpha_- \\ &= \alpha_+ u_{n(n-1)} (u_1 \cdots u_{n(n-1)}) u_{n(n-1)} \alpha_- = e. \end{aligned} \quad \square$$

Corollary 5.7. *The rotation of a maximal distinguished subword of λ_n is again a maximal distinguished subword.*

Remark 5.8. It might be interesting to determine the orbit structure of SUB_n under cyclic rotation.

5.2. Skip reflections are tree-like. Our eventual goal is to show that if $\mathbf{u} \in \text{SUB}_n$, then $\mathbf{r}^{\mathbf{u}}$ gives a cyclic factorization of λ_n . We begin by showing that $\mathbf{r}^{\mathbf{u}}$ is tree-like (Definition 3.1).

Proposition 5.9. *For \mathbf{u} a subword of λ_n , write $\mathbf{r}^{\mathbf{u}} = [r_1, \dots, r_k]$. Let i_j denote the index of the skip corresponding to r_j . Then for any $i_j \leq \ell < i_{j+1}$,*

$$r_1 \cdots r_j = (\lambda_n)_{(\ell)} u_{(\ell)}^{-1}.$$

Proof. This is [GLTW22, Proposition 4.7]. The idea is to notice that

$$(\lambda_n)_{(\ell)}^{-1} r_1 \cdots r_j = \mathbf{u}_{(\ell)}^{-1}$$

because the r_i cancel the corresponding skips from $(\lambda_n)_{(\ell)}^{-1}$. \square

Corollary 5.10. *If $\mathbf{u} \in \text{SUB}_n$, then $r^{\mathbf{u}} \in \text{FACT}(\lambda_n)$.*

We can understand how a subword \mathbf{u} acts on k by looking at $\text{INV}(\mathbf{u})$. The j th reflection $((a, b))$ in $\text{INV}(\mathbf{u})$ with a or b equal to k modulo n will be either:

- *increases* ($u^{(j)}(k) > u^{(j+1)}(k)$), which occur along columns
- *decreases* ($u^{(j)}(k) < u^{(j+1)}(k)$), which occur along rows
- skips ($u^{(j)}(k) = u^{(j+1)}(k)$), which appear as corners.

Example 5.11. It is helpful for understanding the subsequent proofs to interpret the various data on subwords in terms of cyclic trees (although the bijection will not be formally proven until Section 6).

Consider the set of reflections $((a, b))$ in $\text{INV}(\mathbf{u})$ with a or b equal to k modulo n . This set, when highlighted on λ_n drawn using n rows and $n - 1$ columns, record what is seen as one goes clockwise around the vertex k in the tree corresponding to $r^{\mathbf{u}}$. The set forms a connected path heading down and right on a torus (if the path goes below the n th row, the path continues in the same column in the first row; if the path goes to the right of the $(n - 1)$ st column, the path continues one row below in the first column):

- for $k \neq 0 \pmod n$, the path starts down from the topmost box in column k ; if $k = 0 \pmod n$, then then path starts right from the top left box;
- skips of \mathbf{u} correspond to neighbors of k ; at skips, the path switches between going down and going right;
- neighbors $a < k$ (resp. $a > k$) are recorded as corners $((a, k))$ and $((\bar{k}, a))$ (resp. corners $((\bar{a}, k))$ and $((k, a))$) in the same column of the strip;
- the vertical distance between the corners $((a, k))$ and $((\bar{k}, a))$ (or $((\bar{a}, k))$ and $((k, a))$) is given by the number of vertices on the connected component containing a of the tree without vertex k (and the reflections that appear use those vertices and k itself); and
- the horizontal distance between clockwise adjacent neighbors of k is given by the length of the *run-leaf* between those neighbors (defined in Section 6.2).

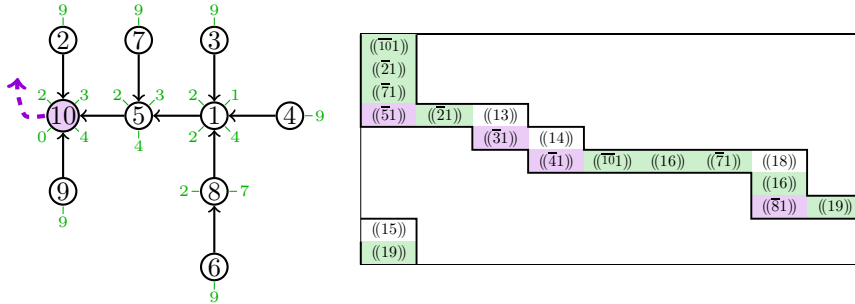

The path above describes a clockwise turn around the vertex 1 of the tree above (reproduced from Figure 1: starting at the corner $((\bar{5}1))$ corresponding to the neighbor 5, there is a run-leaf with label 2 corresponding to a horizontal step of length 2, then the neighbor 3 is visited as the corners $((13))$ and $((\bar{3}1))$ (there is a single vertical step since 3 only has 1 as a neighbor), there is a run-leaf with label 1 corresponding to one horizontal step, the neighbor 4 is visited as the corners $((14))$ and $((\bar{4}1))$ (again, there is a single vertical step since 4 only has 1 as a neighbor), then the run-leaf with label 4 gives four horizontal steps, we visit the neighbor 8 as the corners $((18))$ and $((\bar{8}1))$ with two vertical steps between them because 8 is connected to 6, then a run-leaf with label 2, and then we revisit the neighbor 5 as the corner $((15))$ and we must make five vertical steps to return to the corner $((\bar{5}1))$ because of the vertices 5, 7, 10, 2, 9.

Lemma 5.12. *If \mathbf{u} is an e -subword of λ_n , then for all integers k and all a, b with $0 \leq b - a < n(n - 1)$,*

$$|(u_a \cdots u_b)(k) - k| \leq n - 2,$$

where the indices are taken modulo $n(n-1)$.

Proof. Any segment $(u_a \cdots u_b)$ and any k such that

$$(u_a \cdots u_b)(k) - k \geq n - 1$$

can be converted to the segment $(u_{b+1} \cdots u_{a-1})$ and $k' = (u_a \cdots u_b)(k)$ with

$$(u_{b+1} \cdots u_{a-1})(k') - k' \leq 1 - n,$$

since

$$(u_{b+1} \cdots u_{a-1})((u_a \cdots u_b)(k)) - (u_a \cdots u_b)(k) = k - (u_a \cdots u_b)(k) \leq 1 - n.$$

So it suffices to consider the case $(u_a \cdots u_b)(k) - k \leq 1 - n$, so that the number of terms in $u_a \cdots u_b$ that decrease k (by one, since each u_i is a simple reflection) is at least $n - 1$. Moreover, we can take the index b to be $n(n-1)$ by rotating the subword. The terms that decrease k correspond to indices $a \leq i_{n-1} < \cdots < i_1 \leq n(n-1)$ such that $u_{i_\ell} = s_{k-\ell}$. Notice that $i_{n-1} \leq (n-1)^2 + 1$.

Since $(u_1 \cdots u_{a-1} u_a \cdots u_b)(k) = k$, there must exist at least $n - 1$ terms in $(u_1 \cdots u_{a-1})$ that increase $(u_a \cdots u_b)(k)$, so we can find indices $1 \leq j_1 \leq \cdots \leq j_{n-1} \leq a - 1$ such that $u_{j_\ell} = s_{k-\ell}$. Each of these indices must be on its own row and not on the last two rows (because $j_{n-1} \leq i_{n-1} - n \leq (n-2)(n-1)$). So we reach a contradiction because λ_n only has n rows. \square

Lemma 5.13. *If u is an e -subword of λ_n and $((a, b)) \in \text{INV}(u)$, then $|b - a| \leq n - 1$.*

Proof. We need to show that

$$|(u_1 \cdots u_j)(j+1) - (u_1 \cdots u_j)(j)| \leq n - 1$$

for all $j = 0, \dots, n(n-1) - 1$. Suppose not. Since each inversion is an affine reflection, it is not possible to have

$$|(u_1 \cdots u_j)(j+1) - (u_1 \cdots u_j)(j)| = n,$$

so suppose that

$$|(u_1 \cdots u_j)(j+1) - (u_1 \cdots u_j)(j)| \geq n + 1.$$

By Lemma 5.12 there are two cases to consider:

- (1) $(u_1 \cdots u_j)(j+1) \leq j < j+1 \leq (u_1 \cdots u_j)(j)$
- (2) $(u_1 \cdots u_j)(j) \leq j < j+1 \leq (u_1 \cdots u_j)(j+1)$

In the first case, there must exist an index $1 < \ell < j$ such that $u_\ell = s_{\ell-1}$ and

$$(u_{\ell+1} \cdots u_j)(j) = \ell - 1 \quad \text{and} \quad (u_{\ell+1} \cdots u_j)(j+1) = \ell.$$

Choose the smallest such ℓ . Then

$$|(u_1 \cdots u_{\ell-1})(\ell-1) - (u_1 \cdots u_{\ell-1})(\ell)| = |(u_1 \cdots u_j)(j+1) - (u_1 \cdots u_j)(j)| \geq n + 1,$$

and

$$(u_1 \cdots u_{\ell-1})(\ell-1) \leq \ell - 1 < \ell \leq (u_1 \cdots u_j)(\ell).$$

So the first case reduces to the second. Let

$$c = j - (u_1 \cdots u_j)(j) \quad \text{and} \quad d = (u_1 \cdots u_j)(j+1) - (j+1),$$

so $c + d \geq n$. Now there must be indices $1 \leq i_d < i_{d-1} < \cdots < i_1 \leq j$ such that $u_{i_\ell} = s_{j+\ell}$. Each of these indices must be on its own row. Moreover, i_1 cannot be on the same row as j .

Now there must also be indices $j+1 \leq k_1 < \cdots < k_c \leq n(n-1)$ such that $u_{k_\ell} = s_{j-\ell}$. Again, each of these indices must be its own row. Moreover, k_1 cannot be on the same row as j . It follows that we need to use at least $c + d + 1 \geq n + 1$ rows, which is a contradiction. \square

Lemma 5.14. *For $u \in \text{SUB}_n$, r^u is a tree-like factorization in $\widetilde{\text{FACT}}_n$.*

Proof. Write $r^u = [r_1, \dots, r_{2n-2}]$. If the skips corresponding to r_ℓ and $r_{\ell+1}$ are at indices i and j , respectively, then

$$u_{(j-1)}(j-1) = u_{(i-1)} e s_i \cdots s_{j-2}(j-1) = u_{(i-1)}(i).$$

Since $r_\ell = ((u_{(i-1)}(i-1), u_{(i-1)}(i)))$ and $r_{\ell+1} = ((u_{(j-1)}(j-1), u_{(j-1)}(j)))$, it follows that there exist $a_0, \dots, a_{2n-2} \in \mathbb{Z}$ such that $r_\ell = ((a_{\ell-1}, a_\ell))$. The result then follows from Lemma 5.13 and Proposition 3.4. \square

We now show that Definition 5.1 captures the usual definition of *distinguished* subword, that a simple reflection must be used if it causes the current product to decrease in weak order.

Corollary 5.15. *For $u \in \text{SUB}_n$, if $u_{(j)}s_j < u_{(j)}$ then $u_{j+1} = s_j$.*

Proof. It is clear that $u_{(j)}s_j < u_{(j)}$ iff $u_{(j)}(j) > u_{(j)}(j+1)$. Suppose that $u_{j+1} = e$, so the inversion corresponding to this skip is $((u_{(j)}(j), u_{(j)}(j+1)))$. By the proofs of [Lemma 5.14](#) and [Proposition 3.4](#), it follows that $u_{(j)}(j) < u_{(j)}(j+1)$. The result follows by contraposition. \square

5.3. Skip reflections are cyclic. We continue to work towards the bijection between SUB_n and TREE_n by now showing that r^u is actually a cyclic factorization in $\widetilde{\text{FACT}}_n$.

Lemma 5.16. *For u a subword of λ_n , write $r^u = [r_1, \dots, r_\ell]$, and let i_j denote the index of the skip corresponding to r_j . Then*

$$(r_1 \cdots r_{j-1})r_j(r_{j-1} \cdots r_1) = \left(\left(0, i_j + \left\lfloor \frac{i_j - 1}{n - 1} \right\rfloor \right) \right).$$

Proof. From [Lemma 5.9](#), we have

$$\begin{aligned} (r_1 \cdots r_{j-1})r_j(r_{j-1} \cdots r_1) &= (\lambda_n)_{(i_j-1)} u_{(i_j-1)}^{-1} (u_{(i_j-1)} s_{i_j-1} u_{(i_j-1)}^{-1}) u_{(i_j-1)} (\lambda_n)_{(i_j-1)}^{-1} \\ &= (s_0 \cdots s_{i_j-2}) s_{i_j-1} (s_{i_j-2} \cdots s_0) \\ &= ((s_0 \cdots s_{i_j-2}(i_j - 1), s_0 \cdots s_{i_j-2}(i_j))) \\ &= ((0, s_0 \cdots s_{i_j-2}(i_j))). \end{aligned}$$

Write $a_k := s_0 \cdots s_{k-2}(k)$. If $k < n$, then $a_k = k$. Otherwise,

$$\begin{aligned} a_k &= s_0 \cdots s_{k-n}(k) = s_0 \cdots s_{k-n-1}(k+1) \\ &= s_0 \cdots s_{k-n-1}(k-n+1) + n = a_{k-(n-1)} + n. \end{aligned}$$

This shows that $a_k = k + \lfloor (k-1)/(n-1) \rfloor$, so the result follows. \square

Corollary 5.17. *For $u \in \text{SUB}_n$, r^u is a cyclic factorization in $\widetilde{\text{FACT}}_n$.*

Proof. Write $r^u = [r_1, \dots, r_{2n-2}]$. From [Lemma 5.14](#), we know $[r_1, \dots, r_{2n-2}]$ satisfies [Definition 3.1](#), so it remains to show [Definition 4.1 \(i\)](#) and [Definition 4.1 \(ii\)](#). These follow from [Lemma 5.16](#) and [Proposition 4.4](#). \square

Proposition 5.18. *Let $r \in \widetilde{\text{FACT}}_n$. Then there exists a subword $u \in \text{SUB}_n$ such that $r = r^u$.*

Proof. Suppose that $[r_1, \dots, r_{2n-2}]$ is a cyclic factorization of λ_n . By [Corollary 3.11](#), we can write $r_\ell = ((a_{\ell-1}, a_\ell))$ with $a_{\ell-1} < a_\ell$, $a_0 = 0$, and $a_{2n-2} = n(n-1)$.

As in [Proposition 4.4](#), for $1 \leq j \leq 2n-2$, define integers m_j by

$$(r_1 \cdots r_{j-1})r_j(r_{j-1} \cdots r_1) = ((0, m_j)).$$

Then

$$m_{2n-2} = a_{2n-1} + n < a_{2n-2} + n = n(n-1) + n = n^2.$$

By [Proposition 4.4](#), we have

$$0 = a_0 < a_1 = m_1 < m_2 < \cdots < m_{2n-2} < n^2.$$

For $j = 1, \dots, 2n-2$, define

$$i_j := m_j - \left\lfloor \frac{m_j - 1}{n} \right\rfloor \text{ so that } m_j = i_j - \left\lfloor \frac{i_j - 1}{n - 1} \right\rfloor.$$

Notice that

$$1 \leq i_j \leq n^2 - 1 - \left\lfloor \frac{n^2 - 2}{n} \right\rfloor = n(n-1),$$

so we can take u to be the subword of λ_n with skips at indices i_j . By [Lemma 5.16](#), we have $r^u = [r_1, \dots, r_{2n-2}]$. Then, since $r_1 \cdots r_{2n-2} = \lambda_n$, it follows from [Proposition 5.9](#) that u is a distinguished subword. \square

Corollary 5.19. *The map $u \mapsto r^u$ is a bijection between SUB_n and $\widetilde{\text{FACT}}_n$.*

6. SUBWORDS AND CYCLIC TREES

In this section, we prove our main theorem—that there is a bijection between maximal distinguished subwords of λ_n and (cyclically-embedded) vertex-labeled trees with n vertices.

Theorem 6.1. *There is a bijection between SUB_n and $TREE_n$.*

The proof of [Theorem 6.1](#) will occupy the next two subsections.

6.1. From subwords to cyclic trees. The forward direction of the bijection is easy: given $u \in SUB_n$, compute the inversions of the skips r^u , then create a tree $T \in TREE_n$ with edges (a, b) between $a < b$ when $((a, b))$ and $((\bar{b}, a))$ appear as reflections in r^u . This tree can then be cyclically embedded using [Section 4.2](#).

6.2. From cyclic trees to subwords. The other direction of the bijection is a little more difficult. To more easily describe it, we decorate the trees with *run-leaves*.

Fix a cyclic tree $T \in TREE_n$. To each vertex $v \neq n$ we will attach $\deg(v)$ many *run-leaves*, so that in a clockwise walk around T , edges and run-leaves alternate. At the vertex n , we instead add $\deg(n) + 1$ many leaves: two between the smallest and largest neighbors of n (because T is cyclically embedded, these vertices will be adjacent). We index the run-leaves based on when we see them in the clockwise walk starting from n towards its smallest neighbor, so that our walk visits run-leaves l_0, \dots, l_{2n-2} and edges e_0, \dots, e_{2n-1} in the order

$$(6.1) \quad [l_0, e_0, l_1, e_1, l_2, \dots, e_{2n-1}, l_{2n-2}].$$

We now label each run-leaf l_k with an integer $\ell(l_k) := \ell_k$ with $1 \leq \ell_k \leq n-1$ as follows (for now, ignore the first and last run-leaves, l_0 and l_{2n-2} , attached to vertex n). The run-leaf l_k is situated between the two edges $e_{k-1} = (v_{k-1}, v_k)$ and $e_k = (v_k, v_{k+1})$, incident to the vertex v_k to which l_k has been attached. The label ℓ_k is assigned according to the following four cases, illustrated in [Figure 6](#):

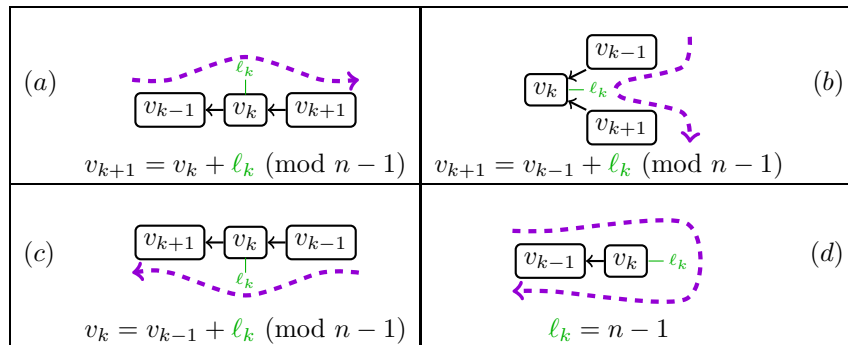

FIGURE 6. Run-leaf rules, where the dashed line denoting our walk around a cyclic tree T . The walk begins at vertex n and steps first towards the smallest neighbor of n walking clockwise.

- (a) if $v_{k+1} \neq v_{k-1}$ and the path from v_{k+1} to n goes through v_k and v_{k-1} , then $\ell_k = v_{k+1} - v_k \pmod{n-1}$.
- (b) if the paths from v_{k-1} to n and from v_{k+1} go through v_k , then $\ell_k = v_{k+1} - v_{k-1} \pmod{n-1}$.
- (c) if $v_{k+1} \neq v_{k-1}$ and the path from v_{k-1} to n goes through v_k and v_{k+1} , then $\ell_k = v_k - v_{k-1} \pmod{n-1}$.
- (d) if $v_{k+1} = v_{k-1}$, then $\ell_k = n-1$.

We can view these four cases as specializations of the general rule for $1 \leq \ell_k \leq n-1$:

$$\ell_k = v'_{k+1} - v'_{k-1} \pmod{n-1}, \text{ where}$$

$$v'_{k\pm 1} = \begin{cases} v_k & \text{if } v_{k\pm 1} \text{ is on the path from } v_k \text{ to } n, \\ v_{k\pm 1} & \text{otherwise.} \end{cases}$$

Finally, we define ℓ_0 to be v_1 , the smallest neighbor of n , and ℓ_{2n-2} to be $(n-1) - v_{2n-3}$; note that v_{2n-3} is necessarily the largest neighbor of n and ℓ_{2n-2} is possibly zero. By construction, the sum of the labels of the run-leaves adjacent to any vertex $k \in [n]$ is $n-1$.

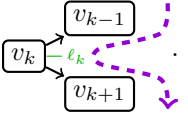
Remark 6.2. Because there is a unique path from v_k to n , we never have the case .

The subword $u^T \in \text{SUB}_n$ is now described using the sequence of run-leaves and edges in Equation (6.1) to describe its takes and skips (see Section 5 for these definitions): each run-leaf l_k corresponds to a series of $\ell_k - 1$ successive takes, while each edge e_k corresponds to a single skip. Lemma 5.13, Corollary 3.11, and Lemma 5.16 justify this procedure. Write

$$r^u = [r_1, \dots, r_{2n-2}],$$

and let i_j be the index of the skip corresponding to r_j . Consider $r_\ell = ((a, b))$ and $r_{\ell+1} = ((b, c))$ with $a < b < c$. Then we have the following cases (each one corresponds to a case in Figure 6):

- (a) If r_ℓ and $r_{\ell+1}$ are both the left ends of their pairs, then
 - $i_{\ell+1} - i_\ell = c - b$ if $(c \bmod n) > (b \bmod n)$
 - $i_{\ell+1} - i_\ell = c - b - 1$ if $(c \bmod n) < (b \bmod n)$
- (b) If r_ℓ is the right end of its pair and $r_{\ell+1}$ is the left end of its pair, then
 - $i_{\ell+1} - i_\ell = c - a$ if $(c \bmod n) > (a \bmod n)$
 - $i_{\ell+1} - i_\ell = c - a - 1$ if $(c \bmod n) < (a \bmod n)$
- (c) If r_ℓ and $r_{\ell+1}$ are both the right ends of their pairs, then
 - $i_{\ell+1} - i_\ell = b - a$ if $(b \bmod n) > (a \bmod n)$
 - $i_{\ell+1} - i_\ell = b - a - 1$ if $(b \bmod n) < (a \bmod n)$
- (d) If r_ℓ is the left end of its pair and $r_{\ell+1}$ is the right end of its pair, then $c = a + n$ and $i_{\ell+1} - i_\ell = n - 1$.

Example 6.3. Let T be the cyclic tree from Figure 1 (reproduced below):

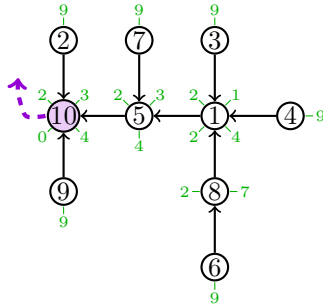

The sequence of run-leaf labels and edges visited during the clockwise walk around T is:

$$[2, (102), 9, (210), 3, (105), 2, (57), 9, (75), 3, (51), 2, (13), 9, (31), 1, (14), 9, (41), 4, (18), 7, (86), 9, (68), 2, (81), 2, (15), 4, (510), 4, (109), 9, (910), 0].$$

Replacing run-leaves by runs (green) and edges by skips (white), we obtain the subword from Figure 1 (reproduced below):

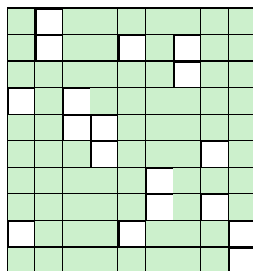

7. ENUMERATION

In this section we prove Cayley's formula for the number of vertex-labeled trees:

$$|\text{TREE}_n| = n^{n-2}.$$

Our proof uses the bijection between TREE_n and SUB_n from [Theorem 6.1](#), along with representation-theoretic techniques (previously obtained in a collaboration between the last author with P. Galashin and T. Lam) to compute the number of points in a particular braid variety $R_{\lambda_n}(\mathbb{F}_q)$ over the finite field \mathbb{F}_q with q elements. Using a trace formula due to Opdam and an identity due to Haglund, we obtain that

$$|R_{\lambda_n}(\mathbb{F}_q)| = (q-1)^{2n-2} [n]_q^{n-2},$$

where $[n]_q := \frac{q^n-1}{q-1}$ is the usual q -analogue. Certain *distinguished subwords* \mathcal{D}_{λ_n} index the Deodhar components of this braid variety $D_u(\mathbb{F}_q)$:

$$R_{\lambda_n}(\mathbb{F}_q) = \bigsqcup_{u \in \mathcal{D}_{\lambda_n}} D_u(\mathbb{F}_q),$$

but the maximal distinguished subwords in SUB_n are the only components that contribute to the sum when q is sent to 1:

$$|\text{SUB}_n| = \left((q-1)^{-2n+2} |R_{\lambda_n}(\mathbb{F}_q)| \right) \Big|_{q \rightarrow 1} = n^{n-2}.$$

7.1. Braid varieties. The usual definition of braid varieties extends to the context of Kac-Moody groups (for simplicity, we give a specialization of the more general definition). For $\mathbf{w} = [s_1, s_2, \dots, s_m]$ a word in the simple reflections S of the Weyl group W , we denote this *braid variety* (over a finite field) by $R_{\mathbf{w}}(\mathbb{F}_q)$. In slightly more detail, a split minimal Kac-Moody group G is associated to a symmetrizable generalized Cartan matrix; it is generated by a split torus T and root subgroups $U^{\pm} = \{U_{\pm\alpha_i}\}$. We have opposite Borel subgroups B^{\pm} generated by T and U^{\pm} , we have the flag variety $\mathcal{B} = G/B^+$ with its decomposition into Schubert cells $\mathcal{B}_w = B^+ \cdot wB^+/B^+$ and opposite Schubert cells $\mathcal{B}^w = B^- \cdot wB^+/B^+$, and we can speak of the *relative position* of two flags $B_1, B_2 \in G/B^+$ (written $B_1 \xrightarrow{w} B_2$ for $w \in W$). Then for $\mathbf{w} = [s_1, s_2, \dots, s_m]$ with $w = s_1 s_2 \dots s_m \in W$, we have

$$R_{\mathbf{w}}(\mathbb{F}_q) = \left\{ B^+ = B_0 \xrightarrow{s_1} B_1 \xrightarrow{s_2} B_2 \dots \xrightarrow{s_m} B_m : B_m \in \mathcal{B}^e \right\}.$$

A *distinguished subword* u of \mathbf{w} is a subword for which a simple reflection must be used if it causes the current product to decrease in weak order—that is, if $u_{(j)} s_j < u_{(j)}$ then $u_{j+1} = s_j$ (see also [Corollary 5.15](#)). Write $\mathcal{D}_{\mathbf{w}}$ for all distinguished subwords. By a natural extension of [[Deo85](#)] (see also [[BH21](#)]), the braid variety $R_{\mathbf{w}}(\mathbb{F}_q)$ has a Deodhar decomposition into

$$R_{\mathbf{w}}(\mathbb{F}_q) = \bigsqcup_{u \in \mathcal{D}_{\mathbf{w}}} D_u(\mathbb{F}_q),$$

where each $D_u(\mathbb{F}_q)$ is isomorphic to $(\mathbb{F}_q^{\times})^{s(u)} \times \mathbb{F}_q^{t(u)}$, where $s(u)$ is the number of skips of u and $t(u)$ is half the number of takes.

Let B_W be the *braid group* for W with generators T_i for each $s_i \in S$, and let $H_W = B_W / (T_i^2 = (q-1)T_i + q)$ be the *Hecke algebra*, with usual basis $\{T_w\}_{w \in W}$. Write $w = s_1 \dots s_m \in W$. By the same arguments as [[KL79](#), Lemmas A3 and A4] and [[GLTW22](#), Corollary 5.3] the number of \mathbb{F}_q -points in the braid variety $R_{\mathbf{w}}(\mathbb{F}_q)$ is given by the trace

$$|R_{\mathbf{w}}(\mathbb{F}_q)| = q^{\ell(w)} \text{tr}(T_w^{-1}),$$

where for $X \in H_W$, $\text{tr}(X)$ returns the coefficient of the basis element T_e indexed by the identity.

7.2. Opdam's trace formula. We now specialize to G the affine Kac-Moody group of type A_{n-1} . Write Φ^+ for the positive roots of GL_n , $Q = \bigoplus_{i=1}^r \mathbb{Z}\alpha_i$ for its *root lattice*, $Q^+ \subset Q$ for the positive span of the simple roots, and Λ for the weight lattice. Write \widehat{S}_n for the *extended affine symmetric group*, whose elements can be thought of as bijections $\widehat{w} : \mathbb{Z} \rightarrow \mathbb{Z}$ such that $\widehat{w}(i+n) = \widehat{w}(i) + n$ and $\sum_{i=1}^n \widehat{w}(i) = \binom{n+1}{2} \pmod{n}$; it contains the elements of Λ as translations.

Given $\lambda \in Q^+$, we express λ in the basis of fundamental weights as $\lambda = \sum_{i=1}^{n-1} a_i \lambda_i$ and define $\lambda_+ = \sum_{i:a_i>0} a_i \lambda_i$ and $\lambda_- = -\sum_{i:a_i<0} a_i \lambda_i$.

Definition 7.1. A *Kostant partition* $(a_\alpha)_{\alpha \in \Phi^+}$ for $\lambda \in Q^+$ is a sequence of nonnegative integers indexed by positive roots such that $\lambda = \sum_{\alpha \in \Phi^+} a_\alpha \alpha$. We denote the set of all Kostant partitions for λ by $K(\lambda)$.

Opdam proved the following formula for the trace in the Hecke algebra \widehat{H}_n for the extended affine symmetric group.

Theorem 7.2 ([Opd03, Cor. 1.18]). *Let $[k]_q = \frac{(q-1)^2 q^k - q^{-k}}{q - q^{-1}}$. For $\lambda = \lambda_+ - \lambda_- \in Q^+$,*

$$\mathrm{tr}(T_{\lambda_-} T_{\lambda_+}^{-1}) = q^{(\ell(\lambda_-) - \ell(\lambda_+))/2} \sum_{(a_\alpha) \in K(\lambda)} \prod_{\substack{\alpha \in \Phi^+ \\ a_\alpha > 0}} [a_\alpha]_q.$$

7.3. Haglund's identity. In [Hag11], Haglund proved a remarkable formula for the bigraded (in x - and y -degree) Hilbert series of the quotient ring of diagonal coinvariants. Haglund stated the formula in terms of *Tesler matrices*, which are a simple combinatorial rephrasing of Kostant partitions.

Theorem 7.3 ([Hag11, Corollary 1]). *Write $[k]_{q,t} = (q-1)(1-t) \frac{q^k - t^k}{q-t}$ and let $\lambda_n := n\lambda_{n-1} \in Q_n^+$. Then*

$$\mathrm{Hilb}(\mathrm{DH}_{n-1}; q, t) = \left(\frac{1}{(q-1)(t-1)} \right)^{n-1} \sum_{(a_\alpha) \in K(\lambda)} \prod_{\substack{\alpha \in \Phi_n^+ \\ a_\alpha > 0}} [a_\alpha]_{q,t}.$$

7.4. Cyclic enumeration.

Theorem 7.4 (P. Galashin, T. Lam, N. Williams).

$$|R_{\lambda_n}(\mathbb{F}_q)| = (q-1)^{2n-2} [n]_q^{n-2} \quad \text{and} \quad |\mathrm{SUB}_n| = n^{n-2}.$$

Proof. Since $[k]_q = [k]_{q,q^{-1}}$, we can use Opdam's [Theorem 7.2](#) and specialize Haglund's [Theorem 7.3](#) to conclude that

$$|R_{\lambda_n}(\mathbb{F}_q)| = q^{\ell(\lambda_n)} \mathrm{tr}(T_{\lambda_{n-1}}) = (q-1)^{2n-2} [n]_q^{n-2}.$$

Since all maximal distinguished subwords have exactly $2n-2$ skips and all other distinguished subwords have more than $2n-2$ skips, we have

$$\begin{aligned} (q-1)^{2n-2} [n]_q^{n-2} &= |R_{\lambda_n}(\mathbb{F}_q)| = \sum_{\mathbf{u} \in \mathcal{D}_{\lambda_n}} |D_{\mathbf{u}}(\mathbb{F}_q)| = \sum_{\mathbf{u} \in \mathrm{SUB}_n} |D_{\mathbf{u}}(\mathbb{F}_q)| + \sum_{\mathbf{u} \notin \mathrm{SUB}_n} |D_{\mathbf{u}}(\mathbb{F}_q)| \\ &= \sum_{\mathbf{u} \in \mathrm{SUB}_n} (q-1)^{2n-2} q^{(n-1)(n-2)/2} + \sum_{\mathbf{u} \notin \mathrm{SUB}_n} (q-1)^{s(\mathbf{u})} q^{t(\mathbf{u})}, \end{aligned}$$

where $s(\mathbf{u}) > 2n-2$ for all $\mathbf{u} \notin \mathrm{SUB}_n$. Dividing by $(q-1)^{2n-2}$ and letting $q \rightarrow 1$ gives $|\mathrm{SUB}_n| = n^{n-2}$. \square

Corollary 7.5 (Cayley's formula). $|\mathrm{TREE}_n| = n^{n-2}$.

Proof. This follows immediately from [Theorems 6.1](#) and [7.4](#). \square

8. FUTURE WORK

8.1. Distinguished subwords. It would be interesting to give a combinatorial interpretation for *all* distinguished subwords of λ_n . For $n = 2, 3, 4, 5$, the number of such subwords is 1, 4, 45, 1331; this sequence does not appear in the Online Encyclopedia of Integer Sequences.

8.2. Other weights. There should be a Fuss–Catalan extension [Wil23], using the translation

$$\lambda_{m,n} = (m(n-1) + 1)\lambda_{n-1} - (m-1)\lambda_1.$$

Maximal distinguished subwords will still be parameterized by trees, but the combinatorics of the run-leaves will be more complicated—the number of maximal subwords will be $(m(n-1) + 1)^{n-2}$.

Much more generally [AGH⁺12, Conjecture 7.1], there should be interesting combinatorics coming from the weight

$$\lambda = \sum_{i=1}^{n-1} a_i \alpha_i \text{ with } a_1 > a_2 > \cdots > a_{n-1} \geq a_n = 0.$$

In this case, the number of maximal distinguished subwords is [AGH⁺12]

$$\prod_{i=1}^{n-1} ((i+1)a_i - ia_{i+1}).$$

8.3. Relation to Galashin-Lam-Trinh-Williams. In this section we explore the possibility of a relationship between $R_{\lambda_n}(\mathbb{F}_q)$ and the rational noncrossing parking functions (and their braid varieties) of [GLTW22, Section 8.5].

Definition 8.1. Let $u \in \text{SUB}_n$. We say that a skip in u is a *negative* if the corresponding inversion $((a, b))$ in r^u satisfies $a < b$ and $1 \leq (b \bmod n) < (a \bmod n) \leq n$. A skip is *positive* if it is not negative.

Example 8.2. The negative skips are colored purple in Figures 1 and 5, while the positive skips are left in white. Observe that there is exactly one negative skip in each column and each row except the last.

Proposition 8.3. *Each $u \in \text{SUB}_n$ has exactly one negative skip in each column and each row except the last.*

Proof. It follows from Corollary 3.11 and Lemma 5.16 that the pair of negative and positive skips r_1^k, r_2^k appear in column k . Suppose that $t_1 = ((\bar{a}_0, a_1))$, where $1 \leq a_1 < a_0 \leq n$, is the inversion of the first negative skip in some row of our grid. The next skip has inversion $t_2 = ((a_1, a_2))$ or $((\bar{a}_1, a_2))$, where $1 \leq a_2 \leq n$. If t_2 is in the same row as t_1 , then its column number must be greater than a_1 . It follows that $a_2 > a_1$, so $t_2 = ((a_1, a_2))$. If the next skip is again in the same row, then its column number must be greater than a_2 , so its inversion is $t_3 = ((a_2, a_3))$, where $a_2 < a_3 \leq n$. Continuing in this way, we see that there cannot be another negative skip in this row.

It remains to show that the last row of the grid cannot contain a negative skip. The last skip cannot be negative because its inversion is $((a, n))$ by Corollary 3.11. Moreover, every skip in the last row of the grid must be the second in its pair since the pairs occur in the same column. So if there is a negative skip with inversion $((\bar{a}_0, a_1))$ in the last row, it must be in column a_0 and the next skip must be in column a_1 , which contradicts $a_1 < a_0$. So there cannot be a negative skip in the last row. \square

We will not recall the definitions of the rational noncrossing parking braid varieties $R_{\mathfrak{c}^{n+1}}^{(w)}(\mathbb{F}_q)$ here, instead referring the interested reader to [GLTW22]. We will simply describe how to use Proposition 8.3 to conjecturally break our braid variety $R_{\lambda_n}(\mathbb{F}_q)$ into pieces that should match the individual components of the noncrossing parking braid varieties (indexed by $w \in S_n$).

Remark 8.4. Minh-Tâm Trinh has constructed certain braid variety variants that bundle together the individual parking braid variety components by enriching the usual definition of braid variety by elements of the unipotent subgroup of B^+ . There should be an isomorphism between $R_{\lambda_n}(\mathbb{F}_q)$ and this variant for the symmetric group S_{n-1} and the braid \mathfrak{c}^n , where \mathfrak{c} is the lift of any standard Coxeter element in S_{n-1} to its braid group.

For $w \in S_{n-1}$, write $\text{SUB}_n(w)$ for the set of all subwords $u \in \mathcal{D}_{\lambda_n}$ with negative skips in the positions of the ones in the $(n-1) \times (n-1)$ permutation matrix of w , and takes in the positions corresponding to the inversions of w (indices to the left of and above the ones). Write

$$R_{\lambda_n}^{(w)}(\mathbb{F}_q) = \bigsqcup_{u \in \text{SUB}_n(w)} D_u(\mathbb{F}_q).$$

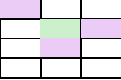
Example 8.5. If we fix $w = [1, 3, 2] \in S_3$, $\text{SUB}_4(w)$ consists of all distinguished subwords that must use skips in the purple boxes and takes in the green boxes of . Then $\text{SUB}_4(w)$ contains three maximal distinguished subwords, and eight distinguished words in total:

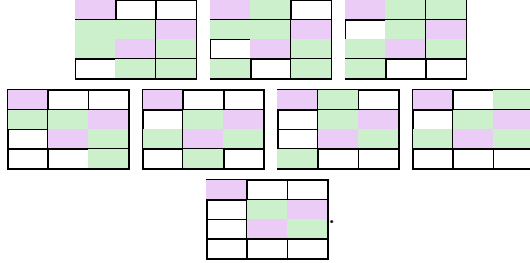

Conjecture 8.6. *We have a disjoint decomposition*

$$R_{\lambda_n}(\mathbb{F}_q) = \bigsqcup_{w \in S_{n-1}} R_{\lambda_n}^{(w)}(\mathbb{F}_q).$$

Moreover, for $w \in S_{n-1}$ and $c_{n-1} = [s_1, \dots, s_{n-2}]$, we have an isomorphism

$$R_{\lambda_n}^{(w)}(\mathbb{F}_q) \simeq (\mathbb{F}_q^\times)^{n-1} \times \mathbb{F}_q^{\ell(w)} \times R_{c_{n-1}}^{(w)}(\mathbb{F}_q),$$

where $R_{c_{n-1}}^{(w)}(\mathbb{F}_q)$ are the noncrossing parking braid varieties of [GLTW22].

Remark 8.7. When w is the identity of S_{n-1} , the subwords in $\text{SUB}_n(e)$ skip all instances of the affine reflection s_0 in λ_n and there are no required takes (since the identity has no inversions). Writing $c_n = [s_1, \dots, s_{n-1}]$, we immediately have

$$R_{\lambda_n}^{(e)}(\mathbb{F}_q) \simeq (\mathbb{F}_q^\times)^{n-1} \times R_{c_n}(\mathbb{F}_q),$$

where $R_{c_n}(\mathbb{F}_q)$ is the Fuss-Dogolon braid variety for S_n , which can easily be shown to be isomorphic to the usual Catalan braid variety $R_{c_{n-1}}(\mathbb{F}_q)$ in S_{n-1} .

ACKNOWLEDGEMENTS

We thank Elise Catania, Sasha Pevzner, and Sylvester Zhang for organizing the 2023 Minnesota Research Workshop in Algebra and Combinatorics (MRWAC), where this work began. We thank the Department of Mathematics at the University of Minnesota, Twin Cities, for providing excellent working conditions. We acknowledge Lee Trent for participating in the early stages of the project.

This work benefited from computations in Sage [The21] and the combinatorics features developed by the Sage-Combinat community [SCc08].

Esther Banaian was supported by Research Project 2 from the Independent Research Fund Denmark (grant no. 1026-00050B). Anh Trong Nam Hoang was supported by the University of Minnesota Doctoral Dissertation Fellowship. Elizabeth Kelley was supported by the National Science Foundation under Award No. 1937241. Weston Miller, Jason Stack, and Nathan Williams were partially supported by the National Science Foundation under Award No. 2246877.

REFERENCES

- [AGH⁺12] Drew Armstrong, Adriano Garsia, James Haglund, Brendon Rhoades, and Bruce Sagan, *Combinatorics of Tesler matrices in the theory of parking functions and diagonal harmonics*, Journal of Combinatorics **3** (2012), no. 3, 451–494.
- [BB05] Anders Björner and Francesco Brenti, *Combinatorics of Coxeter groups*, vol. 231, Springer, 2005.
- [BH21] Huanchen Bao and Xuhua He, *Flag manifolds over semifields*, Algebra & Number Theory **15** (2021), no. 8, 2037–2069.
- [Cay89] Arthur Cayley, *The Quarterly Journal of Mathematics* **23** (1889), 376–378.
- [Deo85] Vinay V Deodhar, *On some geometric aspects of Bruhat orderings. I. a finer decomposition of Bruhat cells*, Inventiones mathematicae **79** (1985), no. 3, 499–511.
- [GJ97] Ian Goulden and David Jackson, *Transitive factorisations into transpositions and holomorphic mappings on the sphere*, Proceedings of the American Mathematical Society **125** (1997), no. 1, 51–60.
- [GLTW22] Pavel Galashin, Thomas Lam, Minh-Tâm Quang Trinh, and Nathan Williams, *Rational noncrossing Coxeter-Catalan combinatorics*, arXiv preprint arXiv:2208.00121 (2022).

- [GY02] Ian Goulden and Alexander Yong, *Tree-like properties of cycle factorizations*, Journal of Combinatorial Theory, Series A **98** (2002), no. 1, 106–117.
- [Hag11] James Haglund, *A polynomial expression for the Hilbert series of the quotient ring of diagonal coinvariants*, Advances in Mathematics **227** (2011), no. 5, 2092–2106.
- [KL79] David Kazhdan and George Lusztig, *Representations of Coxeter groups and Hecke algebras*, Inventiones mathematicae **53** (1979), no. 2, 165–184.
- [Lei21] Tom Leinster, *The probability that an operator is nilpotent*, The American Mathematical Monthly **128** (2021), no. 4, 371–375.
- [LMPS19] Joel Lewis, Jon McCammond, Kyle Petersen, and Petra Schwer, *Computing reflection length in an affine Coxeter group*, Transactions of the American Mathematical Society **371** (2019), no. 6, 4097–4127.
- [MP11] Jon McCammond and T Kyle Petersen, *Bounding reflection length in an affine Coxeter group*, Journal of Algebraic Combinatorics **34** (2011), 711–719.
- [Opd03] Eric M Opdam, *A generating function for the trace of the Iwahori–Hecke algebra*, Springer, 2003.
- [SCc08] The Sage-Combinat community, *Sage-Combinat: enhancing Sage as a toolbox for computer exploration in algebraic combinatorics*, 2008, <http://combinat.sagemath.org>.
- [Sta97] Richard P Stanley, *Parking functions and noncrossing partitions*, The Electronic Journal of Combinatorics [electronic only] **4** (1997), no. 2, v4i2r20–pdf.
- [The21] The Sage Developers, *Sagemath, the Sage Mathematics Software System (Version 9.4)*, 2021, <https://www.sagemath.org>.
- [Wil23] Nathan Williams, *Combinatorics of braid varieties*, Proceedings of Symposia in Pure Mathematics (2023+).

(Banaian) AARHUS UNIVERSITY
Email address: banaian@math.au.dk

(Hoang) UNIVERSITY OF MINNESOTA
Email address: hoang278@umn.edu

(Kelley) UNIVERSITY OF ILLINOIS URBANA CHAMPAIGN
Email address: kelleye@illinois.edu

(Miller) UNIVERSITY OF TEXAS AT DALLAS
Email address: weston.miller@utdallas.edu

(Stack) UNIVERSITY OF TEXAS AT DALLAS
Email address: jason.stack@utdallas.edu

(Stephen) UNIVERSITY OF MINNESOTA
Email address: csteph@umn.edu

(Williams) UNIVERSITY OF TEXAS AT DALLAS
Email address: nathan.williams1@utdallas.edu