

The Complexity of Distance- r Dominating Set Reconfiguration

Niranka Banerjee ✉

Research Institute of Mathematical Sciences, Kyoto University, Japan

Duc A. Hoang ✉ 

VNU University of Science, Vietnam National University, Hanoi, Vietnam

Abstract

For a fixed integer $r \geq 1$, a *distance- r dominating set* of a graph $G = (V, E)$ is a vertex subset $D \subseteq V$ such that every vertex in V is within distance r from some member of D . Given two distance- r dominating sets D_s, D_t of G , the DISTANCE- r DOMINATING SET RECONFIGURATION ($DrDSR$) problem asks if there is a sequence of distance- r dominating sets that transforms D_s into D_t (or vice versa) such that each intermediate member is obtained from its predecessor by applying a given reconfiguration rule exactly once. The problem for $r = 1$ has been well-studied in the literature. We consider $DrDSR$ for $r \geq 2$ under two well-known reconfiguration rules: Token Jumping (TJ, which involves replacing a member of the current $DrDS$ by a non-member) and Token Sliding (TS, which involves replacing a member of the current $DrDS$ by an adjacent non-member).

It is known that under any of TS and TJ, the problem on split graphs is PSPACE-complete for $r = 1$. We show that for $r \geq 2$, the problem is in P, resulting in an interesting complexity dichotomy. Along the way, we prove some non-trivial bounds on the length of a shortest reconfiguration sequence on split graphs when $r = 2$ which may be of independent interest. Additionally, we prove some observations that lead to the polynomial-time solvability of $DrDSR$ for $r \geq 2$ on dually chordal graphs under TJ and on cographs under any of TS and TJ, and design a linear-time algorithm for solving the problem under TJ on trees. On the negative side, we show that $DrDSR$ for $r \geq 1$ on planar graphs of maximum degree three and bounded bandwidth is PSPACE-complete, improving the degree bound of previously known results. We also show that the known PSPACE-completeness results under TS and TJ for $r = 1$ on bipartite graphs and chordal graphs can be extended for $r \geq 2$.

2012 ACM Subject Classification Mathematics of computing → Graph algorithms

Keywords and phrases Reconfiguration problem, Distance- r dominating set, Computational complexity, PSPACE-completeness, Polynomial-time algorithm

Funding Niranka Banerjee: Funded by JSPS KAKENHI Grant Number JP20H05967.

Duc A. Hoang: Funded by University of Science, Vietnam National University, Hanoi under project number TN.23.04.

Acknowledgements This work was partially completed when Duc A. Hoang was a postdoctoral researcher at the Vietnam Institute for Advanced Study in Mathematics (VIASM). Duc A. Hoang would like to thank VIASM for their support and hospitality.

1 Introduction

Reconfiguration Problems. For the last few decades, *reconfiguration problems* have independently emerged in different areas of computer science, including recreational mathematics (e.g., games and puzzles), computational geometry (e.g., flip graphs of triangulations), constraint satisfaction (e.g., solution space of Boolean formulas), and even quantum complexity theory (e.g., ground state connectivity), among others [19, 17, 16, 3]. In a *reconfiguration variant* of a computational problem (e.g., SATISFIABILITY, INDEPENDENT SET, DOMINATING SET, VERTEX-COLORING, etc.), two *feasible solutions* (e.g., satisfying truth assignments, independent sets, dominating sets, proper vertex-colorings, etc.) S and T are given along with a *reconfiguration rule* that describes how to slightly modify one feasible solution to

obtain a new one. The question is whether one can transform/reconfigure S into T via a sequence of feasible solutions such that each intermediate member is obtained from its predecessor by applying the given rule exactly once. Such a sequence, if it exists, is called a *reconfiguration sequence*.

Distance Domination. In 1975, Meir and Moon [14] combined the concepts of “distance” and “domination” in graphs and introduced *distance- r dominating set* of a graph (which they called a “ r -covering”), where $r \geq 1$ is some fixed integer. For a fixed positive integer r and a graph G , a *distance- r dominating set* (DrDS) (also known as *r -hop dominating set* or *r -basis*) of G is a vertex subset D where each vertex of G is within distance r from some member of D . In particular, a D1DS is nothing but a *dominating set* of G .

Given a graph G and some positive integer k , the DISTANCE- r DOMINATING SET problem asks if there is a DrDS of G of size at most k . DISTANCE- r DOMINATING SET remains NP-complete even on bipartite graphs or chordal graphs of diameter $2r + 1$ [5]. Since the work of Meir and Moon, this notion of distance domination in graphs has been extensively studied from different perspectives. We refer readers to the survey of Henning [10] for more details.

Dominating Set Reconfiguration. Reconfiguration of dominating sets has been well-studied in the literature from both algorithmic and graph-theoretic viewpoints. Imagine that a token is placed on each vertex of a dominating set of a graph G and no vertex has more than one token. In a reconfiguration setting for dominating sets, the following reconfiguration rules have been considered.

- **Token Sliding (TS):** One can move a token to one of its unoccupied neighbors as long as the resulting token-set forms a dominating set.
- **Token Jumping (TJ):** One can move a token to any unoccupied vertex as long as the resulting token-set forms a dominating set.
- **Token Addition/Removal (TAR(k)):** One can either add or remove a token as long as the resulting token-set forms a dominating set of size at most some threshold $k \geq 0$.

Given a graph G , a fixed integer $r \geq 1$, two dominating sets D_s, D_t of G , and a reconfiguration rule $R \in \{\text{TS}, \text{TJ}, \text{TAR}\}$, the DOMINATING SET RECONFIGURATION (DSR) problem under R asks if there is a sequence of dominating sets between D_s and D_t where each intermediate member is obtained from its predecessor by applying R exactly once.

We briefly mention some well-known algorithmic results and refer readers to [16] for recent developments from the graph-theoretic perspective. Haddadan et al. [8] first studied the computational complexity of DSR under TAR and showed that the problem is PSPACE-complete on planar graphs of maximum degree six, bounded bandwidth graphs, split graphs, and bipartite graphs. On the positive side, they designed polynomial-time algorithms for solving DSR under TAR on cographs, forests, and interval graphs. Bonamy et al. [1] observed that the TJ and TAR rules are equivalent under some constraints, and therefore the above-mentioned results indeed hold for DSR under TJ. Bonamy et al. [1] first studied the computational complexity of DSR under TS and showed that the hardness results of Haddadan et al. [8] hold even under TS. On the positive side, Bonamy et al. [1] designed polynomial-time algorithms for solving DSR under TS on cographs and dually chordal graphs (which contain trees and interval graphs). Bousquet and Joffard [2] later showed that DSR under TS is PSPACE-complete on circle graphs and can be solved in polynomial time on circular-arc graphs, answering some open questions previously asked by Bonamy et al. [1]. Recently, Křišť'an and Svoboda [12] improved the positive results of Bonamy et al. [1] by showing polynomial-time algorithms to find a *shortest* reconfiguration sequence, if it exists,

between two given dominating sets under TS when the input graph is either a tree or an interval graph. However, their techniques cannot be extended to dually chordal graphs.

A systematic study of the parameterized complexity of several reconfiguration problems, including DSR, was initiated by Mouawad et al. [15]. There are two natural parameterizations: the number of tokens k and the length of a reconfiguration sequence ℓ . In [15], Mouawad et al. showed that DSR under TAR on general graphs is W[1]-hard parameterized by k and W[2]-hard parameterized by $k + \ell$. When parameterized by k on graphs excluding $K_{d,d}$ as a subgraph for any constant d (including bounded degeneracy and nowhere dense graphs), Lokshtanov et al. [13] designed an FPT algorithm for solving the problem. When parameterized by ℓ alone, it was mentioned in [3] that the problem is fixed-parameter tractable on any class where first-order model-checking is fixed-parameter tractable. We refer readers to [13, 3] and the references therein for more details.

Our Problem. Similar to DSR, one can define DISTANCE- r DOMINATING SET RECONFIGURATION (Dr DSR) under R for a fixed integer $r \geq 2$. To the best of our knowledge, for $r \geq 2$, the computational complexity of Dr DSR has not yet been studied. On the other hand, from the parameterized complexity viewpoint, Siebertz [18] studied Dr DSR under TAR parameterized by k and proved that there exists a constant r such that the problem is W[2]-hard on somewhere dense graphs, which are close under taking subgraphs. On the positive side, Siebertz showed that the problem is in FPT on nowhere dense graphs. From the graph-theoretic viewpoint, DeVos et al. [6] introduced the γ_r -graph of a graph G —a (reconfiguration) graph whose nodes are *minimum* distance- r dominating sets of G and edges are defined under TJ—and proved several results on its realizability. In this paper, to obtain a better understanding of the separating line between “hard” and “easy” instances of Dr DSR ($r \geq 2$) on different graphs, we study the problem under TS and TJ from the computational complexity viewpoint.

Our Results. In Section 3, we give polynomial-time algorithms.

- In Section 3.1, we give a few observations that, when combined with known results for DSR, lead to the polynomial-time solvability of Dr DSR for $r \geq 2$ on dually chordal graphs (which include interval graphs and trees) under TJ (**Proposition 2**) and on cographs (i.e., P_4 -free graphs) under both TS and TJ (**Corollary 5**).
- In Section 3.2, we show that Dr DSR under either TS or TJ on split graphs can be solved in polynomial time for any fixed $r \geq 2$ (**Theorem 8** and **Corollary 9**). This result establishes a surprising dichotomy compared to the lower bound result on split graphs by Haddadan et al. [8], who show that the problem is PSPACE-complete for $r = 1$. Additionally, we establish non-trivial bounds on the length of a *shortest* reconfiguration sequence between two D2DSs of a split graph under both TS and TJ, which may be of independent interest (**Theorem 11**). In particular, any TS-sequence (resp., TJ-sequence) has a natural lower bound on its length, and we show that, on split graphs, one can design a TS-sequence (resp., TJ-sequence) between *any* pair of D2DSs D_s and D_t that uses at most two (resp., one) more extra token-slides (resp., token-jump) than such lower bound. Moreover, we also show that there exist instances (G, D_s, D_t) on split graphs where one cannot use less than two extra moves under TS and less than one extra move under TJ to reconfigure D_s into D_t and vice versa.
- Our observation for dually chordal graphs above implies that Dr DSR ($r \geq 2$) under TJ on trees (and indeed on dually chordal graphs) can be solved in quadratic time. In

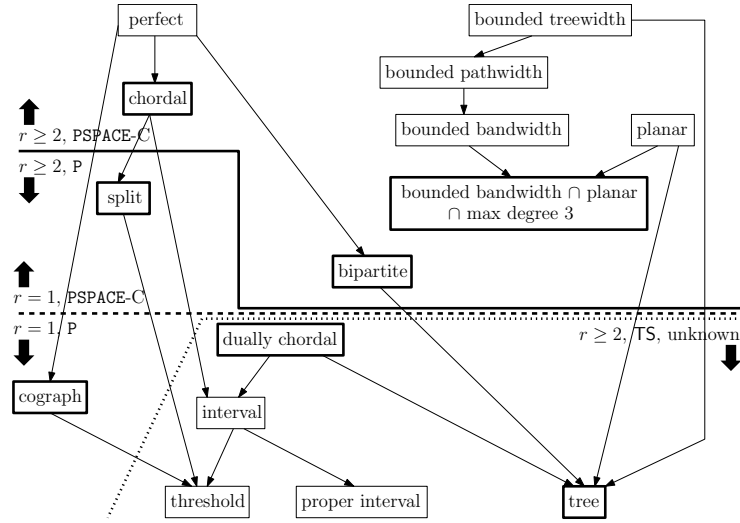

■ **Figure 1** The complexity status of $DrDSR$ for fixed $r \geq 1$ on different graph classes under TS and TJ. Our results are for $r \geq 2$. Each arrow from graph class A to graph class B indicates that B is properly included in A . We omit the specific reconfiguration rules when the corresponding result can be applied for any rule in $\{TS, TJ\}$.

Section 3.3, we improve this running time by designing a linear-time algorithm for solving the problem on trees (**Theorem 17**).

In Section 4, we present our hardness results.

- In Section 4.2, we improve upon the known results for DSR on planar graphs by showing that for any fixed $r \geq 1$, $DrDSR$ under either TS or TJ remains PSPACE-complete even on planar graphs of maximum degree three (while the known results of Haddadan et al. [8] and Bonamy et al. [1] are only for maximum degree six and $r = 1$) and bounded bandwidth (**Theorem 19**).
- In Sections 4.3 and 4.4, we also show that some known hardness results for DSR can be extended to $DrDSR$ when $r \geq 2$. More precisely, we show that under either TS or TJ, $DrDSR$ ($r \geq 2$) is PSPACE-complete on chordal graphs (**Theorem 21**) and on bipartite graphs (**Theorem 22**).

We omit several details related to the statements marked with (*). The omitted details can be found in the appendix.

2 Preliminaries

Graph Notation. For concepts and notations not defined here, we refer readers to [7]. Unless otherwise mentioned, throughout this paper, we consider simple, connected, undirected graphs G with vertex-set $V(G)$ and edge-set $E(G)$. For any pair of vertices u, v , the *distance* between u and v in G , denoted by $\text{dist}_G(u, v)$, is the length of the shortest path between them. The *diameter* of G , denoted by $\text{diam}(G)$, is the largest distance between any pair of vertices. For two vertex subsets X, Y , we use $X - Y$ and $X + Y$ to indicate $X \setminus Y$ and $X \cup Y$, respectively. If Y contains a single vertex u , we write $X - u$ and $X + u$ instead of $X - \{u\}$ and $X + \{u\}$, respectively. We denote by $X \Delta Y$ their *symmetric difference*, i.e., $X \Delta Y = (X - Y) + (Y - X)$. For a subgraph H of G , we denote $G - H$ as the graph obtained from G by deleting all vertices of H and their incident edges in G . A *dominating set* (DS) of G is a vertex subset

D such that for every $u \in V(G)$, there exists $v \in D$ such that $\text{dist}_G(u, v) \leq 1$. For a fixed positive integer r , a *distance- r dominating set* (*DrDS*) of G is a vertex subset D such that for every $v \in V(G)$, there exists $u \in D$ such that $\text{dist}_G(u, v) \leq r$. In particular, any D1DS is also a DS, and vice versa. Let $N_G^r[u]$ be the set of all vertices of distance at most r from u in G . We say that a vertex v is *r -dominated* by u (or u *r -dominates* v) if $v \in N_G^r[u]$. We say that a vertex subset X is *r -dominated* by some vertex subset Y if each vertex in X is r -dominated by some vertex in Y . A DrDS is nothing but a vertex subset D that r -dominates $V(G)$. We denote by $\gamma_r(G)$ the size of a minimum DrDS of G .

Graph Classes. We mention some graph classes that will be considered in this paper. A graph $G = (V, E)$ is called a *split graph* if its vertex set V is partitioned into two subsets, K and S , which respectively induce a clique and an independent set of G . For any split graph G , we assume that such a partition is always given and write $G = (K \uplus S, E)$. A graph G is called a *chordal graph* if every cycle of G on four or more vertices has a chord—an edge joining two non-adjacent vertices in the cycle. It is known that any split graph is also a chordal graph. A *bipartite graph* G is a graph where $V(G)$ can be partitioned into two disjoint vertex subsets X and Y where no edge of G joins two vertices in X or two vertices in Y . G is a *planar graph* if it can be drawn in the plane in such a way that no edges cross each other. A *tree* is a graph having no cycles. The *bandwidth* of a graph G is the minimum over all injective assignments $f : V(G) \rightarrow \mathbb{N}$ of $\max_{uv \in E(G)} |f(u) - f(v)|$. G is called a *bounded bandwidth graph* if there exists a constant b such that the bandwidth of G is at most b .

Reconfiguration Notation. Throughout this paper, we write “ (G, D_s, D_t) under R ” to indicate an instance of DrDSR where D_s and D_t are two given DrDSs of a graph G , and the reconfiguration rule is $R \in \{\text{TS}, \text{TJ}\}$. Imagine that a token is placed on each vertex in a DrDS of a graph G . A *TS-sequence* in G between two DrDSs D_s and D_t is a sequence $\mathcal{S} = \langle D_s = D_0, D_1, \dots, D_q = D_t \rangle$ such that for $i \in \{0, \dots, q-1\}$, the set D_i is a DrDS of G , and there exists a pair $x_i, y_i \in V(G)$ such that $D_i - D_{i+1} = \{x_i\}$, $D_{i+1} - D_i = \{y_i\}$, and $x_i y_i \in E(G)$. A *TJ-sequence* in G is defined similarly, but without the restriction $x_i y_i \in E(G)$. For a given rule $R \in \{\text{TS}, \text{TJ}\}$, we say that D_{i+1} is obtained from D_i by *immediately sliding/jumping* a token from x_i to y_i under rule R , and we write $x_i \xrightarrow{G}_R y_i$. This allows us to express \mathcal{S} as a sequence of token-moves: $\mathcal{S} = \langle x_0 \xrightarrow{G}_R y_0, \dots, x_{q-1} \xrightarrow{G}_R y_{q-1} \rangle$. In short, \mathcal{S} can be viewed as an (ordered) sequence of either DrDSs or token-moves. (Recall that we defined \mathcal{S} as a sequence between D_s and D_t . As a result, when regarding \mathcal{S} as a sequence of token-moves, we implicitly assume that the initial DrDS is D_s .) With respect to the latter viewpoint, we say that \mathcal{S} *slides/jumps a token t from u to v in G* if t is initially placed on $u \in D_0$ and finally on $v \in D_q$ after performing \mathcal{S} . The *length* of a R -sequence is simply the number of times the rule R is applied.

3 Polynomial-Time Algorithms

3.1 Observations

Graphs and Their Powers. For a graph G and an integer $s \geq 1$, the s^{th} *power* of G is the graph G^s whose vertices are $V(G)$ and two vertices u, v are adjacent in G^s if $\text{dist}_G(u, v) \leq s$. Observe that D is a DrDS of G if and only if D is a DS of G^r . The following proposition is straightforward.

► **Proposition 1** (*). *Let \mathcal{G} and \mathcal{H} be two graph classes and suppose that for every $G \in \mathcal{G}$ we have $G^r \in \mathcal{H}$ for some fixed integer $r \geq 1$. If DSR under TJ on \mathcal{H} can be solved in polynomial time, so does DrDSR under TJ on \mathcal{G} .*

Dually Chordal Graphs. We refer readers to [4] for a precise definition of this graph class. It is known that DSR can be solved in quadratic time under TS on connected dually chordal graphs [1, Theorem 13]. Specifically, given an instance (G, D_s, D_t) of DSR under TS, where D_s and D_t are two dominating sets of a connected dually chordal graph G , one can construct in quadratic time a TS-sequence between D_s and D_t . Since any TS-sequence is also a TJ-sequence, the result also applies for TJ. In other words, DSR under TJ on connected dually chordal graphs can be solved in quadratic time.

One can construct in quadratic time a TJ-sequence between D_s and D_t on disconnected dually chordal graphs G as follows. Bonamy et al. also proved that one can construct in linear time a canonical minimum dominating set C and respectively reconfigure D_s and D_t under TS into D'_s and D'_t such that $C \subseteq D'_s \cap D'_t$ [1, Lemma 12]. Moreover, in a component, note that any token not in a canonical minimum dominating set can be arbitrarily moved/jumped to any other component. As a result, one can indeed reconfigure D_s and D_t under TJ such that, finally, their intersections with each component are of equal size. Now, it remains to solve for each component independently, which can be done as described in [1, Theorem 13]. In summary, we have the following proposition.

► **Proposition 2.** *DSR under TJ is quadratic-time solvable on dually chordal graphs.*

It is also known that the power of any dually chordal graph is also a dually chordal graph [4]. Additionally, any tree or interval graph is also dually chordal [1]. Along with Proposition 1, we obtain the following corollary.

► **Corollary 3.** *DrDSR under TJ on dually chordal graphs is quadratic-time solvable for any $r \geq 2$. Consequently, the result also applies to trees and interval graphs.*

Graphs With Bounded Diameter Components. We prove the following observation for graphs satisfying that each component's diameter is upper bounded by the same constant.

► **Proposition 4** (*). *Let G be any graph such that there is some constant $c > 0$ satisfying $\text{diam}(C_G) \leq c$ for any component C_G of G . Then, DrDSR on G under $R \in \{\text{TS}, \text{TJ}\}$ is in \mathcal{P} for every $r \geq c$.*

Since any connected cograph (P_4 -free graph) has diameter at most 2, the following corollary is straightforward.

► **Corollary 5.** *DrDSR under $R \in \{\text{TS}, \text{TJ}\}$ on cographs is in \mathcal{P} for any $r \geq 2$.*

3.2 Split Graphs

In this section, we consider split graphs. We begin by proving some useful properties when moving tokens in a split graph.

► **Lemma 6** (*). *Let D be a D2DS of a split graph $G = (K \uplus S, E)$.*

- (a) *For every pair $u \in D \cap K$ and $v \in K - D$, the set $D - u + v$ is a D2DS of G .*
- (b) *For every pair $u \in D \cap S$ and $v \in K - D$, the set $D - u + v$ is a D2DS of G .*
- (c) *For every pair $u \in D \cap K$ and $v \in S - D$, the set $D - u + v$ is a D2DS of G if $(D \cap K) - u \neq \emptyset$.*

A direct consequence of Lemma 6 is as follows.

► **Corollary 7.** *Let $G = (K \uplus S, E)$ be a split graph and D be any D2DS of G . For any $u \in D$ and $v \in N_G(u) - D$, if $(D - u) \cap K \neq \emptyset$ then $D - u + v$ is always a D2DS of G .*

In the following theorem, we prove that DrDSR under TS on split graphs is polynomial-time solvable.

► **Theorem 8 (*)**. *DrDSR under TS on split graphs is in P for any $r \geq 2$. In particular, when $r = 2$, for any pair of size- k D2DSs D_s, D_t of a split graph $G = (K \uplus S, E)$, there is a TS-sequence in G between D_s and D_t .*

Since any TS-sequence in G is also a TJ-sequence, a direct consequence of Theorem 8 and Proposition 4 is as follows.

► **Corollary 9.** *DrDSR under TJ on split graphs is in P for any $r \geq 2$.*

We now consider *shortest* reconfiguration sequences in split graphs. Observe that each R-sequence ($R \in \{\text{TS}, \text{TJ}\}$) between two DrDSs D_s and D_t induces a bijection f between them: the token on $u \in D_s$ must ultimately be placed on $f(u) \in D_t$, and vice versa. We denote the length of a *shortest* R-sequence in G between two DrDSs D_s and D_t by $\text{OPT}_R(G, D_s, D_t)$. If there is no R-sequence between D_s and D_t , we define $\text{OPT}_R(G, D_s, D_t) = \infty$.

Let $M_{\text{TS}}^*(G, D_s, D_t) = \min_f \sum_{i=1}^k \text{dist}_G(s_i, f(s_i))$, where f is a bijection between vertices of D_s and D_t , and let $M_{\text{TJ}}^*(G, D_s, D_t) = \frac{|D_s \Delta D_t|}{2}$. Observe that $\text{OPT}_{\text{TS}}(G, D_s, D_t) \geq M_{\text{TS}}^*(G, D_s, D_t)$; in order to slide a token from $s_i \in D_s$ to $f(s_i) \in D_t$ for some $i \in \{1, \dots, k\}$, one cannot use fewer than $\text{dist}_G(s_i, f(s_i))$ token-slides. Additionally, we also have $\text{OPT}_{\text{TJ}}(G, D_s, D_t) \geq M_{\text{TJ}}^*(G, D_s, D_t)$; each token in $D_s \setminus D_t$ may jump directly to some vertex in $D_t \setminus D_s$. Furthermore, observe that for any instance where both D_s and D_t are subsets of K , one can indeed construct TS- and TJ-sequences that are, respectively, of lengths $M_{\text{TS}}^*(G, D_s, D_t)$ and $M_{\text{TJ}}^*(G, D_s, D_t)$. (Recall that any vertex in K forms a size-1 D2DS of G .)

Indeed, we are not interested in the case $r \geq 3$. In this case, any token-jump or token-slide results in a new DrDS of G . Thus, it is not hard to construct shortest reconfiguration sequences of lengths $M_{\text{TS}}^*(G, D_s, D_t)$ and $M_{\text{TJ}}^*(G, D_s, D_t)$: Under TS, one can apply Theorem 10 below (which originally is [19, Theorem 4.3]). Under TJ, just jump tokens one by one from $D_s \setminus D_t$ to $D_t \setminus D_s$.

► **Theorem 10 ([19]).** *For any graph G and two token-sets (i.e., vertex subsets of $V(G)$) U and V , there exists a shortest TS-sequence between U and V of length exactly $M_{\text{TS}}^*(G, U, V)$.*

The rest of this section is devoted to proving the following theorem when $r = 2$.

► **Theorem 11.** *For any instance (G, D_s, D_t) of D2DSR on split graphs,*

(a) $M_{\text{TS}}^*(G, D_s, D_t) \leq \text{OPT}_{\text{TS}}(G, D_s, D_t) \leq M_{\text{TS}}^*(G, D_s, D_t) + 2$.

(b) $M_{\text{TJ}}^*(G, D_s, D_t) \leq \text{OPT}_{\text{TJ}}(G, D_s, D_t) \leq M_{\text{TJ}}^*(G, D_s, D_t) + 1$.

Additionally, there are instances where $\text{OPT}_{\text{TS}}(G, D_s, D_t) = M_{\text{TS}}^(G, D_s, D_t) + 2$ and instances where $\text{OPT}_{\text{TJ}}(G, D_s, D_t) = M_{\text{TJ}}^*(G, D_s, D_t) + 1$.*

We first consider the TS rule. Lemma 12 is a direct consequence of Theorem 10.

► **Lemma 12.** *Let $G = (K \uplus S, E)$ be a split graph. Suppose that any sequence of token-slides in G is a TS-sequence, meaning that every time a token is slid along an edge, the resulting token-set is always a D2DS. Then, for any pair of D2DSs D_s and D_t of G , there exists a TS-sequence of length exactly $M_{\text{TS}}^*(G, D_s, D_t)$.*

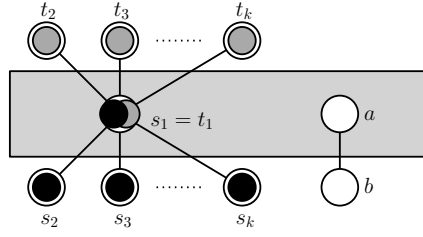

■ **Figure 2** Construction of a split graph $G = (K \uplus S, E)$ satisfying Lemma 13. Vertices in the light gray box are in K . Tokens in D_s and D_t are respectively marked by black and gray circles.

► **Lemma 13.** *There exists a split graph $G = (K \uplus S, E)$ and two size- k D2DSs D_s, D_t of G such that $\text{OPT}_{\text{TS}}(G, D_s, D_t) = M_{\text{TS}}^*(G, D_s, D_t) + 2$, for $k \geq 2$.*

Proof. We construct a split graph $G = (K \uplus S, E)$ as follows (see Figure 2):

- The set K contains 2 vertices, labeled $s_1 = t_1$ and a . Vertices in K form a clique in G .
- The set S contains $2k - 1$ vertices, labeled $s_2, \dots, s_k, t_2, \dots, t_k, b$. Vertices in S form an independent set in G .
- We join $s_1 = t_1$ to every vertex in $\{s_2, \dots, s_k, t_2, \dots, t_k\}$ and join a to b .

Let $D_s = \{s_1, \dots, s_k\}$ and $D_t = \{t_1, \dots, t_k\}$. Since $s_1 = t_1 \in K$, both D_s and D_t are D2DSs of G .

Let $M^* = M_{\text{TS}}^*(G, D_s, D_t)$. One can verify that $M^* = \sum_{i=1}^k \text{dist}_G(s_i, t_i) = 2k - 2$. Additionally, any TS-sequence \mathcal{S} in G between D_s and D_t must begin with sliding the token on s_1 to one of its unoccupied neighbors. A TS-sequence of length exactly M^* would require sliding the token on s_1 to one of t_2, \dots, t_k . However, this is not possible, as the vertex b would not be 2-dominated by any token in the resulting token-set. Thus, the only viable initial move is to slide the token on s_1 to a . Next, one can slide each token on s_i ($2 \leq i \leq k$) to t_i along the $s_i t_i$ -path (of length 2) in G . Finally, the token on a is slid back to $t_1 = s_1$. This completes our construction of a TS-sequence of length $2(k - 1) + 2 = M^* + 2$ between D_s and D_t .

Observe that the moves from s_1 to a and then later from a to s_1 are essential and cannot be omitted. Furthermore, it requires at least two token-slides to transform a token on any s_i to some t_j for $2 \leq i, j \leq k$. Hence, in total, any TS-sequence requires at least $M^* + 2$ token-slides. Therefore, our constructed TS-sequence is the shortest possible. ◀

Let (G, D_s, D_t) be any instance of D2DSR under TS, and let $f : D_s \rightarrow D_t$ be any bijection between the vertices of D_s and D_t . For each $i \in \{1, \dots, k\}$, we call $f(s_i)$ the *target* of the token on s_i . By *handling the token on s_i* , we mean constructing a TS-sequence that moves the token on s_i to its target $f(s_i)$. By *swapping the targets* of s_i and s_j , we mean applying the following procedure: Define a new bijection $g : D_s \rightarrow D_t$ such that $g(s_\ell) = f(s_\ell)$ for every $\ell \in \{1, \dots, k\} \setminus \{i, j\}$, $g(s_i) = f(s_j)$, and $g(s_j) = f(s_i)$. Then, reassign $f \leftarrow g$.

For any instance (G, D_s, D_t) of D2DSR under TS on split graphs, we now prove an upper bound of $\text{OPT}_{\text{TS}}(G, D_s, D_t)$.

► **Lemma 14.** *For any instance (G, D_s, D_t) of D2DSR under TS on split graphs, we have $\text{OPT}_{\text{TS}}(G, D_s, D_t) \leq M_{\text{TS}}^*(G, D_s, D_t) + 2$.*

Proof. Let $M^* = M_{\text{TS}}^*(G, D_s, D_t)$. We describe an algorithm to construct a TS-sequence of length at most $M^* + 2$ between any pair of D2DSs, D_s and D_t of $G = (K \uplus S, E)$. Take any bijection $f : D_s \rightarrow D_t$ such that $M^* = \sum_{i=1}^k \text{dist}_G(s_i, f(s_i))$, where $D_s = \{s_1, \dots, s_k\}$.

Intuitively, we plan to move each token on s_i to $f(s_i)$ along some shortest $s_i f(s_i)$ -path. When there is an “obstacle token” along the path, we try the *swapping targets* procedure. If the *swapping targets* procedure does not work, we attempt to slide the “obstacle” token one step away, handling every other token that passes through the “obstacle,” and then move the “obstacle token” to its target. We claim that this entire procedure can be completed with at most $M^* + 2$ token-slides.

Observe that Lemma 12 addresses the case when G has a diameter of at most 2. Thus, we only need to consider the case when G has a diameter of 3. Since G has a diameter of 3, we have $|K| \geq 2$. We can further assume that $D_s \cap K \neq \emptyset$; otherwise, pick any $s_i \in D_s \cap S$ and slide the token on s_i one step to one of its neighbors $u \in K$ in a shortest $s_i f(s_i)$ -path in G . (As G is connected, such a vertex u exists.) Recall that Corollary 7 implies that the resulting token-set after each such move is a D2DS of G . Let s_i be an arbitrary vertex in $D_s \cap K$. As $s_i \in K$, note that s_i by itself is a valid D2DS of the graph.

We emphasize that from the proof of [19, Theorem 4.3], it follows that every time Lemma 12 is applied, moving a token¹ to $f(s_j)$ always takes *exactly* $\text{dist}_G(s_j, f(s_j))$ token-slides, regardless of how the token is moved. This is the main reason why we can consider the cases separately as below and finally combine them to have a TS-sequence with at most $M^* + 2$ token-slides.

Observe that we can *handle any token* on s_j , $j \neq i$, such that there exists a shortest $s_j f(s_j)$ -path in G that does not contain s_i . The reason is that, in this case, the token on s_i is never moved when *handling these tokens*. Thus, from the observation of Corollary 7, we can apply Lemma 12.

It remains to handle every token s_j , $j \neq i$, where all shortest $s_j f(s_j)$ -paths in G pass through s_i . Let \mathcal{A} be the set of all such tokens. We partition \mathcal{A} into two disjoint subsets \mathcal{A}_1 and \mathcal{A}_2 . \mathcal{A}_1 consists of all $s_j \in \mathcal{A}$ such that there exists a shortest $s_j f(s_j)$ -path in G that does not contain $f(s_i)$. \mathcal{A}_2 consists of all $s_j \in \mathcal{A}$ such that every shortest $s_j f(s_j)$ -path in G contains $f(s_i)$. Intuitively, \mathcal{A}_1 consists of every s_j where one can move the token on s_j along some shortest $s_j f(s_j)$ -path without possibly having a token on $f(s_i)$ as an “obstacle token”, while \mathcal{A}_2 consists of every s_j where one cannot. Observe that since $s_i \in K$, we have $0 \leq \text{dist}_G(s_i, f(s_i)) \leq 2$. Moreover, note that if $f(s_i) \in S$, the vertex $f(s_i)$ has no token; otherwise, there must be some $s_j \in \mathcal{A}$ such that $s_j = f(s_i)$, and swapping the targets of s_i and s_j would result in a new bijection f where $\sum_{i=1}^k \text{dist}_G(s_i, f(s_i))$ is smaller than M^* , which contradicts our assumption. (Note that any shortest $s_j f(s_j)$ -path where $s_j \in \mathcal{A}$ contains s_i .)

We consider the following cases:

- **Case A:** $\text{dist}_G(s_i, f(s_i)) = 2$. In this case, observe that $\mathcal{A}_2 = \emptyset$, and therefore, it suffices to show how to handle tokens on vertices in \mathcal{A}_1 . Let P_i be a shortest $s_i f(s_i)$ -path in G , and let u be the common neighbor of s_i and $f(s_i)$ in P_i . Note that $u \in K$ and $f(s_i) \in S$.
 - Let us first consider the case where u has no token. Again, \mathcal{A}_1 can be partitioned into two disjoint subsets \mathcal{A}_{11} and \mathcal{A}_{12} , where \mathcal{A}_{11} consists of all $s_j \in \mathcal{A}_1$ such that there exists a shortest $s_j f(s_j)$ -path in G that does not contain u , and \mathcal{A}_{12} consists of all $s_j \in \mathcal{A}_1$ such that every shortest $s_j f(s_j)$ -path in G contains u . To handle tokens on vertices in both \mathcal{A}_{11} and \mathcal{A}_{12} , the first step is to directly slide the token on s_i to u , which can be done since $u \in K$. At this point, all tokens on $s_j \in \mathcal{A}_{11}$

¹ This token may or may not be from s_j , as sometimes you need to “swap targets” when having an “obstacle token”.

can be *handled* via shortest $s_j f(s_j)$ -paths that do not contain u using Lemma 12, as s_i has no token, and this *handling* process does not involve $u \in K$.

Observe that for all $s_j \in \mathcal{A}_{12}$, $s_j s_i u f(s_j)$ must form a shortest $s_j f(s_j)$ -path in G ; otherwise (i.e., $s_j u s_i f(s_j)$ forms a shortest $s_j f(s_j)$ -path in G), by swapping the targets of s_i and s_j , we obtain a bijection with a total sum $\sum_{i=1}^k \text{dist}_G(s_i, f(s_i))$ smaller than M^* , which contradicts our assumption. (Note that in the latter case, $\text{dist}_G(s_i, f(s_j)) + \text{dist}_G(s_j, f(s_i)) = 1 + 2 = 3 < \text{dist}_G(s_i, f(s_i)) + \text{dist}_G(s_j, f(s_j)) = 2 + 3 = 5$.) It remains to handle all tokens on $s_j \in \mathcal{A}_{12}$, one token at a time, as follows:

- * Pick an $s_j \in \mathcal{A}_{12}$ and slide its token one step directly to s_i (which is currently unoccupied). This can be done because $s_i \in K$.
- * Slide the token currently placed on u to $f(s_j)$. This can be done because s_i now has a token.
- * Slide the token currently on s_i to u . This can be done because $u \in K$.
- * Remove s_j from \mathcal{A}_{12} .
- * Repeat the process until $\mathcal{A}_{12} = \emptyset$.

After every token on vertices in \mathcal{A}_{12} is handled, we can simply move the last token on u directly to $f(s_i)$. Intuitively, what we are doing in the above process is to slide the token that is originally on s_i to $f(s_j)$ and the token that is originally on s_j to u via s_i , all of which can be done using exactly three token-slides along the shortest $s_j f(s_j)$ -path $s_j s_i u f(s_j)$ (of length exactly 3)². Thus, in this case, our constructed TS-sequence has length exactly M^* .

- To complete our construction, we consider the case where u has a token. In this case, we simply slide that token to $f(s_i)$ (which can be done because $s_i \in K$ currently has a token) and reduce to the case where u has no token. Again, our constructed TS-sequence has length exactly M^* .

- **Case B:** $\text{dist}_G(s_i, f(s_i)) = 1$. In this case, $f(s_i)$ may be either in S or in K .

- We first consider the case $f(s_i) \in S$. In this situation, $\mathcal{A}_2 = \emptyset$, and therefore, we need to *handle* only tokens on vertices in \mathcal{A}_1 . If every vertex in K has a token, and since $|K| \geq 2$, there must be at least one vertex $u \neq s_i \in K$ having a token. Thus, we first directly slide the token on s_i to $f(s_i)$. Again, we can partition \mathcal{A}_1 into two disjoint subsets \mathcal{A}_{11} and \mathcal{A}_{12} , where \mathcal{A}_{11} consists of all $s_j \in \mathcal{A}_1$ such that there exists a shortest $s_j f(s_j)$ -path in G that does not contain u , and \mathcal{A}_{12} consists of all $s_j \in \mathcal{A}_1$ such that every shortest $s_j f(s_j)$ -path in G contains u .

The tokens on vertices s_j in \mathcal{A}_{11} can be *handled* via the $s_j f(s_j)$ -shortest paths that do not contain u using Lemma 12, as at this point s_i has no token, and the *handling process* does not involve $u \in K$. We *handle* the tokens on vertices in \mathcal{A}_{12} similarly as **Case A**. (At this point, note that s_j, u both have tokens while s_i and $f(s_j)$ do not. We use the same strategy as in **Case A** along the $s_j f(s_j)$ -shortest path $s_j s_i u f(s_j)$.) Again, our constructed TS-sequence has length exactly M^* in this case.

We now consider the case that there exists a vertex $u \in K$ that has no token. As before, we partition \mathcal{A}_1 into two disjoint subsets \mathcal{A}_{11} and \mathcal{A}_{12} and handle each of them similarly to **Case A** except the final step. In the final step, as the vertex u is not in any $s_i f(s_i)$ -shortest path, we do not move the token on u directly to $f(s_i)$ (which may

² Intuitively, one may think of this as in order to achieve M^* token-slides, here we have three token-slides to use, and as long as we do not use more, we are fine.

not even be possible if they are not adjacent) but we move it back to s_i (which can be done because $s_i \in K$) and then finally from s_i to $f(s_i)$ (which can be done because $f(s_i)$ is at this point the unique vertex in D_t not having a token). As we use two more extra token-slides (sliding a token from s_i to u and later slide the token on u back to s_i), our constructed TS-sequence has length at most $M^* + 2$.

- We now consider the case $f(s_i) \in K$. First, we show that at this point $f(s_i)$ does not have a token. Suppose to the contrary that it does, i.e., there exists ℓ such that $s_\ell = f(s_i)$. In this case, no shortest $s_\ell f(s_\ell)$ -path contains s_i ; otherwise, swapping the targets of s_i and s_ℓ would lead to a total sum $\sum_{i=1}^k \text{dist}_G(s_i, f(s_i))$ smaller than M^* . Thus, s_ℓ must already have been handled before, which means $f(s_i)$ cannot have a token at this point, a contradiction.

As $f(s_i)$ does not have a token, we directly slide the token on s_i to $f(s_i)$. At this point, each $s_j \in \mathcal{A}_1$ (where there exists an $s_j f(s_j)$ -shortest path that does not contain $f(s_i)$) can be *handled* using Lemma 12, as currently there is an $s_j f(s_j)$ -shortest path that does not contain s_i . For the tokens on $s_j \in \mathcal{A}_2$ (where both s_i and $f(s_i)$ are in every $s_j f(s_j)$ -path), we can then set $s'_i = f(s_i) = f(s'_i)$ and instead of working with the token-set $s_1, \dots, s_i, \dots, s_k$ and the value M^* , we work with the token-set $s_1, \dots, s'_i, \dots, s_k$ and the value $M^* - 1$. As $s'_i = f(s'_i)$, we can reduce to **Case C** below.

- **Case C:** $\text{dist}_G(s_i, f(s_i)) = 0$. In this case, note that $\mathcal{A}_1 = \emptyset$. So we need to only deal with the set \mathcal{A}_2 . In this case, both s_i and $f(s_i)$ are the same vertex and both belong to K . If every vertex in K has a token, there must be some $s_j \in \mathcal{A}_2$ such that $f(s_j) \in S$ has no token on it; otherwise, there is no token left to consider. Let u be one of $f(s_j)$'s neighbors in K along a $s_j f(s_j)$ -shortest path. (As G is connected, such a vertex u exists.) As u has a token, there exists ℓ such that $u = s_\ell$. We then swap the targets of s_j and s_ℓ and slide the token on $u = s_\ell$ to its new target (which was originally $f(s_j)$). One can verify by considering all relative positions of $s_j, f(s_j), u = s_\ell, f(s_\ell)$ (note that u and $f(s_j)$ are always adjacent in a $s_j f(s_j)$ -shortest path) that this “swapping targets” procedure does not lead to any total sum $\sum_{i=1}^k \text{dist}_G(s_i, f(s_i))$ smaller than M^* . Now, as u has no token, we reduce to the case where not every vertex in K has a token.

We now consider the case where not every vertex in K has a token. In this case, since $|K| \geq 2$, there must be at least one vertex $u \neq s_i(f(s_i))$ in K having no token. As before, we partition \mathcal{A}_2 into two disjoint subsets \mathcal{A}_{21} and \mathcal{A}_{22} where \mathcal{A}_{21} consists of all $s_j \in \mathcal{A}_2$ such that there exists a shortest $s_j f(s_j)$ -path in G which does not contain u (but contains $s_i = f(s_i)$) and \mathcal{A}_{22} consists of all $s_j \in \mathcal{A}_2$ such that every shortest $s_j f(s_j)$ -path in G contains u (and $s_i = f(s_i)$). We then *handle* \mathcal{A}_{21} (resp., \mathcal{A}_{22}) similarly to what we did before for \mathcal{A}_{11} (resp., \mathcal{A}_{12}) in **Case A** and **Case B**. Again, since we use two extra token-slides (sliding token from s_i to u and then later sliding token from u back to s_i), our constructed TS-sequence has length $M^* + 2$. (For example, see the constructed example in the proof of Lemma 13. In that example, $\mathcal{A}_{22} = \emptyset$.)

◀

It remains to consider the TJ rule.

- **Lemma 15.** *There exists a split graph $G = (K \uplus S, E)$ and two size- k D2DSs D_s, D_t of G such that $\text{OPT}_{\text{TJ}}(G, D_s, D_t) = M_{\text{TJ}}^*(G, D_s, D_t) + 1$, for $k \geq 2$.*

Proof. We construct a split graph $G = (K \uplus S, E)$ as follows:

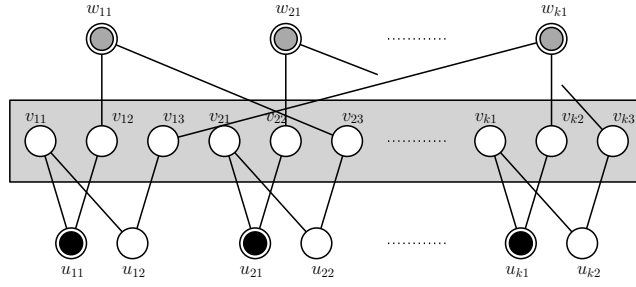

■ **Figure 3** Construction of a split graph $G = (K \uplus S, E)$ satisfying Lemma 15. Vertices in the light gray box are in K . Tokens in D_s and D_t are respectively marked by black and gray circles.

- The set K contains $3k$ vertices labeled $v_{i1}, v_{i2},$ and v_{i3} , for $1 \leq i \leq k$. Vertices in K form a clique in G .
- The set S contains $3k$ vertices labeled u_{i1}, u_{i2}, w_{i1} for $1 \leq i \leq k$. Vertices in S form an independent set in G .
- For each $i \in \{1, \dots, k\}$, we join u_{i1} to both v_{i1} and v_{i2} , join u_{i2} to both v_{i1} and v_{i3} , and join w_{i1} to v_{j3} , where $j = i + 1$ if $i \leq k - 1$ and $j = 1$ if $i = k$.

Let $D_s = \bigcup_{i=1}^k \{u_{i1}\}$ and $D_t = \bigcup_{i=1}^k \{w_{i1}\}$.

To see that D_s is a D2DS of G , note that each u_{i1} 2-dominates every vertex in $K \cup \{u_{i1}\} \cup \{u_{i2}\} \cup \{w_{i1}\}$. To see that D_t is a D2DS of G , note that each w_{i1} 2-dominates every vertex in $K \cup \{u_{i1}\} \cup \{u_{j2}\} \cup \{w_{i1}\}$, where $j = i + 1$ if $i \leq k - 1$ and $j = 1$ if $i = k$.

Let $M^* = M_{\text{TJ}}^*(G, D_s, D_t)$. Observe that any TJ-sequence of length exactly M^* must begin with a direct token-jump from some u_{i1} to some w_{j1} for some $1 \leq i, j \leq k$. We claim that such a move cannot be performed:

- If the token on u_{i1} is moved directly to any w_{j1} where $i \neq j$, the vertex u_{i1} is not 2-dominated by any token in the resulting token-set.
- If the token on u_{i1} is moved directly to w_{i1} , the vertex u_{i2} is not 2-dominated by any token in the resulting token-set.

On the other hand, a TJ-sequence of length exactly $M^* + 1$ can be constructed: first jumping the token on u_{11} to v_{11} , then for $2 \leq i \leq k$, directly jumping the token on u_{i1} to w_{i1} , and finally jumping the token on v_{11} to w_{11} . As before, since a token is always placed at $v_{11} \in K$ after the first token-jump and before the final one, the above sequence of token-jumps is indeed a TJ-sequence in G . ◀

► **Lemma 16** (*). *For any instance (G, D_s, D_t) of D2DSR under TJ on split graphs, $\text{OPT}_{\text{TJ}}(G, D_s, D_t) \leq M_{\text{TJ}}^*(G, D_s, D_t) + 1$.*

3.3 Trees

By Corollary 3, it follows that $D_r\text{DSR}$ under TJ on trees can be solved in quadratic time. In this section, we improve the running time as follows.

► **Theorem 17** (*). *$D_r\text{DSR}$ under TJ on trees can be solved in linear time for any $r \geq 2$.*

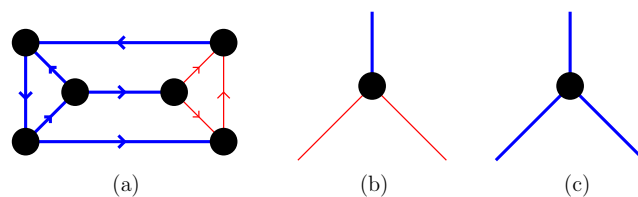

■ **Figure 4** (a) A configuration of an NCL AND/OR constraint graph, (b) NCL AND vertex, (c) NCL OR vertex.

4 Hardness Results

We begin this section with the following remark. It is well-known that for any computational problem in NP, any of its reconfiguration variants is in PSPACE (see the proof of [11, Theorem 1]). Since *DrDS* is in NP [5], *DrDSR* is in PSPACE. As a result, when proving the PSPACE-completeness of *DrDSR*, it suffices to show a polynomial-time reduction.

4.1 Base Problems for Hardness Reduction

Nondeterministic Constraint Logic (NCL). In an *NCL constraint graph* (or *NCL graph* for short), first introduced by Hearn and Demaine [9], each edge has weight either 1 (red, thin) or 2 (blue, thick). A *configuration* of an NCL graph is an orientation of its edges satisfying that the *in-weight* (i.e., the sum of all weights of edges that are directed inward) at any vertex is at least two. Two NCL configurations of an NCL graph are *adjacent* if one can be obtained from the other by reversing the direction of exactly one edge. Given an NCL graph and two configurations C_s, C_t , the *NCL configuration-to-configuration (C2C)* variant asks whether there is a sequence of adjacent configurations between C_s and C_t , i.e., a sequence $\langle C_s = C_1, C_2, \dots, C_p = C_t \rangle$ where all C_i ($1 \leq i \leq p$) are NCL configurations and C_i and C_{i+1} ($1 \leq i \leq p-1$) are adjacent.

An *NCL AND/OR constraint graph* is an NCL graph where only two types of vertices, namely AND vertices and OR vertices, are allowed. (See Figure 4.)

- In an NCL AND vertex u (Figure 4(b)), there are three incident edges: two of which have weight 1 (red) and one has weight 2 (blue). To direct the weight-2 (blue) edge outward, *both* two weight-1 (red) edges must be directed inward. It is not required that when two weight-1 (red) edges are directed inward, the weight-2 (blue) edge must be directed outward. This mimics the behavior of a logical AND gate.
- In an NCL OR vertex v (Figure 4(c)), there are three incident edges, each of which have weight 2 (blue). To direct any weight-2 (blue) edge outward, *at least one* of the other two weight-2 (blue) edges must be directed inward. This mimics the behavior of a logical OR gate.

For simplicity, we call the NCL C2C variant as the *NCL problem* and an NCL AND/OR constraint graph as an *NCL graph*. It is well-known that the NCL problem remains PSPACE-complete even on NCL graphs that are both planar and bounded bandwidth [20].

4.2 Planar Graphs

In this section, we consider planar graphs. We remark that one can extend the known results for DSR [8, 1] on planar graphs of maximum degree six and bounded bandwidth to show the PSPACE-completeness of *DrDSR* ($r \geq 2$) under both TS and TJ on the same graph class.

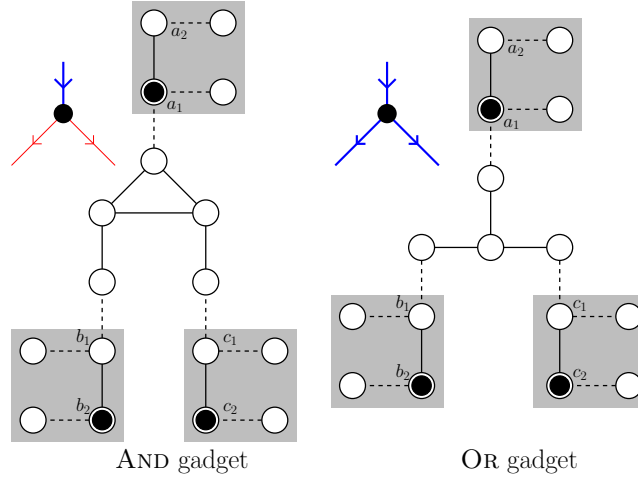

■ **Figure 5** Our gadgets for $DrDSR$. Each dashed edge represents a path of length $r - 1$.

► **Theorem 18** (*). $DrDSR$ under $R \in \{TS, TJ\}$ on planar graphs of maximum degree six and bounded bandwidth is $PSPACE$ -complete for any $r \geq 2$.

In the following theorem, we show that we can further improve the above result by reducing from the NCL problem.

► **Theorem 19**. $DrDSR$ under $R \in \{TS, TJ\}$ on planar graphs of maximum degree three and bounded bandwidth is $PSPACE$ -complete for any $r \geq 1$.

Proof. We reduce from the NCL problem, which is known to be $PSPACE$ -complete on planar graphs of bounded bandwidth. We first consider TS and later explain how the same reduction holds under TJ . The AND and OR gadgets that simulate the behaviors of the NCL AND and OR vertices, respectively, are constructed as in Figure 5.

- A gadget has exactly one *main component* and three disjoint *link components*.
- The *main component* of the AND gadget contains a bull graph (i.e., a triangle with two disjoint pendant edges). There is exactly one path of length $r - 1$ attached to each vertex of degree at most two of the graph. The *main component* of the OR gadget contains a claw graph (i.e., a $K_{1,3}$). There is exactly one path of length $r - 1$ attached to each leaf of the claw graph. (See Figure 5.)
- Each *link component* in both gadgets is formed by attaching paths of length $r - 1$ to the endpoints of each edge: $\{(a_1 a_2), (b_1 b_2), (c_1 c_2)\}$. More precisely, there is exactly one path of length $r - 1$ starting from each of the vertices $a_1, a_2, b_1, b_2, c_1,$ and c_2 . In Figure 5, each link component is shown inside a gray box.
- In each gadget, its main component and three link components are joined together respectively at the vertices $a_1, b_1,$ and c_1 , as in Figure 5.

We want these link components to simulate the directions of NCL edges as follows: when a token is placed on either $a_1, b_1,$ or c_1 , the corresponding NCL edge is directed inward, and when a token is placed on either $a_2, b_2,$ or c_2 , the corresponding NCL edge is directed outward. Naturally, *sliding a token*, say from a_1 to a_2 , corresponds to *reversing the direction of the corresponding NCL edge*, say from inward to outward, and vice versa. Figure 5 illustrates this setting:

- The current token-set of the AND gadget corresponds to a AND vertex where the weight-2 (blue) edge is directed inward and the two weight-1 (red) edges are directed outward.

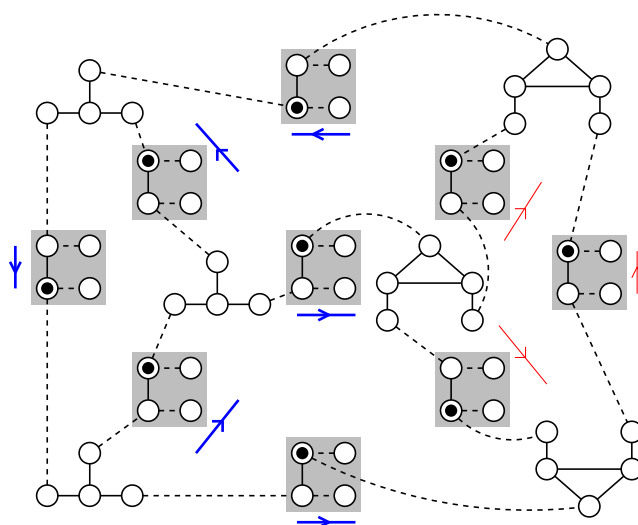

■ **Figure 6** The graph and token-set corresponding to the NCL AND/OR constraint graph and its configuration in Figure 4(a). Each dashed edge represents a path of length $r - 1$.

- The current token-set of the OR gadget corresponds to a OR vertex where one weight-2 (blue, top) edge is directed inward and the other two weight-2 (blue, bottom) edges are directed outward.

Given an NCL graph, which is planar and bounded bandwidth, and one of its configurations, we construct a corresponding graph and token-set by joining together AND and OR gadgets at their shared link components and placing the tokens in link components appropriately. Figure 6 describes the constructed graph and token-set corresponds to the NCL graph and its configuration given in Figure 4(a). One can verify that the constructed token-set indeed forms a DrDS of the constructed graph. (It suffices to verify for each gadget.) For convenience, we call each constructed token-set a *standard token placement* and each token in a link component a *link token*.

We now show the correctness of our construction.

► **Claim 20 (*)**. *There is a reconfiguration sequence between two NCL configurations C_s and C_t if and only if there is a TS-sequence between their corresponding standard token placements in the constructed graph. Additionally, the constructed graph is planar, has maximum degree three and bounded bandwidth.*

Finally, as link tokens never leave their corresponding edges, any TJ-move is also a TS-move, and therefore our proof holds under TJ. ◀

4.3 Chordal Graphs

► **Theorem 21 (*)**. *DrDSR under $R \in \{TS, TJ\}$ on chordal graphs is PSPACE-complete for any $r \geq 2$.*

4.4 Bipartite Graphs

► **Theorem 22 (*)**. *DrDSR under $R \in \{TS, TJ\}$ on bipartite graphs is PSPACE-complete for any $r \geq 2$.*

References

- 1 Marthe Bonamy, Paul Dorbec, and Paul Ouvrard. Dominating sets reconfiguration under token sliding. *Discrete Applied Mathematics*, 301:6–18, 2021. doi:10.1016/j.dam.2021.05.014.
- 2 Nicolas Bousquet and Alice Joffard. TS-reconfiguration of dominating sets in circle and circular-arc graphs. In *Proceedings of FCT 2021*, volume 12867 of *LNCS*. Springer, 2021. doi:10.1007/978-3-030-86593-1_8.
- 3 Nicolas Bousquet, Amer E. Mouawad, Naomi Nishimura, and Sebastian Siebertz. A survey on the parameterized complexity of the independent set and (connected) dominating set reconfiguration problems. *arXiv preprint*, 2022. arXiv:2204.10526.
- 4 Andreas Brandstädt, Feodor Dragan, Victor Chepoi, and Vitaly Voloshin. Dually chordal graphs. *SIAM Journal on Discrete Mathematics*, 11(3):437–455, 1998. doi:10.1137/S0895480193253415.
- 5 Gerard J. Chang and George L. Nemhauser. The k -domination and k -stability problems on sun-free chordal graphs. *SIAM Journal on Algebraic Discrete Methods*, 5(3):332–345, 1984. doi:10.1137/0605034.
- 6 Matt DeVos, Adam Dyck, Jonathan Jedwab, and Samuel Simon. Which graphs occur as γ -graphs? *Graphs and Combinatorics*, 36(4):1219–1246, 2020. doi:10.1007/s00373-020-02174-9.
- 7 Reinhard Diestel. *Graph Theory*, volume 173 of *Graduate Texts in Mathematics*. Springer, 5th edition, 2017. doi:10.1007/978-3-662-53622-3.
- 8 Arash Haddadan, Takehiro Ito, Amer E. Mouawad, Naomi Nishimura, Hirotaka Ono, Akira Suzuki, and Youcef Tebbal. The complexity of dominating set reconfiguration. *Theoretical Computer Science*, 651:37–49, 2016. doi:10.1016/j.tcs.2016.08.016.
- 9 Robert A. Hearn and Erik D. Demaine. PSPACE-completeness of sliding-block puzzles and other problems through the nondeterministic constraint logic model of computation. *Theoretical Computer Science*, 343(1-2):72–96, 2005. doi:10.1016/j.tcs.2005.05.008.
- 10 Michael A. Henning. *Distance Domination in Graphs*, volume 64 of *Developments in Mathematics*, pages 205–250. Springer, 2020. doi:10.1007/978-3-030-51117-3_7.
- 11 Takehiro Ito, Erik D. Demaine, Nicholas J. A. Harvey, Christos H. Papadimitriou, Martha Sideri, Ryuhei Uehara, and Yushi Uno. On the complexity of reconfiguration problems. *Theoretical Computer Science*, 412(12-14):1054–1065, 2011. doi:10.1016/j.tcs.2010.12.005.
- 12 Jan Matyáš Křišť'an and Jakub Svoboda. Shortest dominating set reconfiguration under token sliding. In Henning Fernau and Klaus Jansen, editors, *Proceedings of FCT 2023*, volume 14292 of *LNCS*, pages 333–347. Springer, 2023. doi:10.1007/978-3-031-43587-4_24.
- 13 Daniel Lokshtanov, Amer E. Mouawad, Fahad Panolan, M. S. Ramanujan, and Saket Saurabh. Reconfiguration on sparse graphs. *Journal of Computer and System Sciences*, 95:122–131, 2018. doi:10.1016/j.jcss.2018.02.004.
- 14 A. Meir and John Moon. Relations between packing and covering numbers of a tree. *Pacific Journal of Mathematics*, 61(1):225–233, 1975. doi:10.2140/pjm.1975.61.225.
- 15 Amer E. Mouawad, Naomi Nishimura, Venkatesh Raman, Narges Simjour, and Akira Suzuki. On the parameterized complexity of reconfiguration problems. *Algorithmica*, 78(1):274–297, 2017. doi:10.1007/s00453-016-0159-2.
- 16 C.M. Mynhardt and S. Nasserar. Reconfiguration of colourings and dominating sets in graphs. In Fan Chung, Ron Graham, Frederick Hoffman, Ronald C. Mullin, Leslie Hogben, and Douglas B. West, editors, *50 years of Combinatorics, Graph Theory, and Computing*, pages 171–191. CRC Press, 1st edition, 2019. doi:10.1201/9780429280092-10.
- 17 Naomi Nishimura. Introduction to reconfiguration. *Algorithms*, 11(4):52, 2018. doi:10.3390/a11040052.
- 18 Sebastian Siebertz. Reconfiguration on nowhere dense graph classes. *The Electronic Journal of Combinatorics*, 25(3):P3.24, 2018. doi:10.37236/7458.

- 19 Jan van den Heuvel. The complexity of change. In *Surveys in Combinatorics*, volume 409 of *London Mathematical Society Lecture Note Series*, pages 127–160. Cambridge University Press, 2013. doi:10.1017/cbo9781139506748.005.
- 20 Tom C. van der Zanden. Parameterized complexity of graph constraint logic. In *Proceedings of IPEC 2015*, volume 43 of *LIPICs*, pages 282–293. Schloss Dagstuhl – Leibniz-Zentrum für Informatik, 2015. doi:10.4230/LIPICs.IPEC.2015.282.



A

 Omitted Details for Section 3 (Polynomial-Time Algorithms)

► **Proposition 1** (*). Let \mathcal{G} and \mathcal{H} be two graph classes and suppose that for every $G \in \mathcal{G}$ we have $G^r \in \mathcal{H}$ for some fixed integer $r \geq 1$. If DSR under TJ on \mathcal{H} can be solved in polynomial time, so does DrDSR under TJ on \mathcal{G} .

Proof. Since D is a DrDS of G if and only if D is a DS of G^r , any TJ-sequence in G between two DrDSs can be converted to a TJ-sequence in G^r between two corresponding DSs and vice versa. ◀

► **Proposition 4** (*). Let G be any graph such that there is some constant $c > 0$ satisfying $\text{diam}(C_G) \leq c$ for any component C_G of G . Then, DrDSR on G under $R \in \{\text{TS}, \text{TJ}\}$ is in P for every $r \geq c$.

Proof. When $r \geq c$, any size-1 vertex subset of G is a DrDS. In this case, observe that any token-jump (and therefore token-slide) from one vertex to any unoccupied vertex always results a new DrDS. Thus, under TJ, any instance of DrDSR is a yes-instance. On the other hand, under TS, the answer depends on the number of tokens in each component. More precisely, for any instance (G, D_s, D_t) of DrDSR under TS, if $|D_s \cap V(C_G)| = |D_t \cap V(C_G)|$ for any component C_G of G then it is a yes-instance; otherwise it is a no-instance. ◀

► **Lemma 6** (*). Let D be a D2DS of a split graph $G = (K \uplus S, E)$.

- (a) For every pair $u \in D \cap K$ and $v \in K - D$, the set $D - u + v$ is a D2DS of G .
- (b) For every pair $u \in D \cap S$ and $v \in K - D$, the set $D - u + v$ is a D2DS of G .
- (c) For every pair $u \in D \cap K$ and $v \in S - D$, the set $D - u + v$ is a D2DS of G if $(D \cap K) - u \neq \emptyset$.

Proof. By definition, $\text{dist}_G(v, w) \leq 2$ for any $w \in V(G)$. Consequently, in both (a) and (b), $\{v\}$ is a D2DS of G , and therefore so is $D - u + v \supseteq \{v\}$. In (c), since $(D \cap K) - u \neq \emptyset$, there must be a vertex $x \in D \cap K$ such that $x \neq u$. Again, since $\{x\}$ is a D2DS of G , so is $D - u + v \supseteq \{x\}$. ◀

► **Theorem 8** (*). DrDSR under TS on split graphs is in P for any $r \geq 2$. In particular, when $r = 2$, for any pair of size- k D2DSs D_s, D_t of a split graph $G = (K \uplus S, E)$, there is a TS-sequence in G between D_s and D_t .

Proof. Proposition 4 settles the case $r \geq 3$. It remains to consider the case $r = 2$. We claim that for any pair of size- k D2DSs D_s and D_t of a split graph $G = (K \uplus S, E)$, there exists a TS-sequence in G between D_s and D_t .

Suppose that $p = |K| \geq 1$ and $q = |S| \geq 1$. If $p = 1$, then G is a star graph $K_{1,q}$, and any size-1 vertex subset of G is also a D2DS. In this case, any token can move freely, and a TS-sequence between D_s and D_t can be easily designed.

Now, suppose that $p \geq 2$. In this case, observe that as long as there is a token in K , Corollary 7 ensures that any other token can move freely. Using this observation, we design a TS-sequence between D_s and D_t as follows.

- If there is no token in K , move an arbitrary token from some vertex $u \in D_s \cap S$ to one of its neighbors $v \in K$. (As G is connected, such a vertex v exists.)
- While keeping a token in K , move tokens to vertices in $S \cap D_t$ as follows: Pick a $v \in S \cap D_t$, choose a closest token to v on some vertex v_{close} , and move it to v . If v_{close} is the only vertex with a token in K at that time and v is not the last vertex in D_t that needs a token, first move another token from S to K . This can be done either by shifting the

token on v_{close} to another vertex in K and then shifting a token to v_{close} , or by shifting a token to a vertex in $K \setminus v_{\text{close}}$. If v is the last vertex in D_t that needs a token, simply move the token on v_{close} to v along one of their shortest paths P . Note that all vertices of P except v are in K , and D_t is a D2DS. Thus, every move along P results in a new D2DS.

- Finally, move any remaining tokens (if they exist) to $K \cap D_t$.

◀

► **Lemma 16** (*). *For any instance (G, D_s, D_t) of D2DSR under TJ on split graphs, $\text{OPT}_{\text{TJ}}(G, D_s, D_t) \leq M_{\text{TJ}}^*(G, D_s, D_t) + 1$.*

Proof. We use the same strategy as in the proof of Lemma 15. Let $M^* = M_{\text{TJ}}^*(G, D_s, D_t)$. To construct a TJ-sequence of length exactly $M^* + 1$ between any pair of D_s and D_t of $G = (K \uplus S, E)$, we proceed as follows:

- (1) If $D_s \cap K = \emptyset$, we first move a token t in D_s to some vertex in K (which takes one token-jump).
- (2) We then move every other token in $D_s \setminus D_t$ to some vertex in $D_t \setminus D_s$ (which takes $M^* - 1$ token-jumps).
- (3) Finally, we move t to the unique remaining unoccupied vertex in D_t (which takes one token-jump).

Since t is always located in K except possibly before the initial jump and after the final jump, our constructed sequence is a TJ-sequence, and it has length $M^* + 1$. ◀

► **Theorem 17** (*). *DrDSR under TJ on trees can be solved in linear time for any $r \geq 2$.*

To prove this theorem, we extend the idea of Haddadan et al. [HIM⁺16] for $r = 1$ under TAR and the linear-time algorithm of Kundu and Majumder [KM16] for finding a minimum DrDS on trees. In particular, we employ a simpler implementation of Kundu and Majumder's algorithm presented by Abu-Affash, Carmi, and Krasin [AACK22]. More precisely, based on the minimum DrDS D^* obtained from the implementation of Abu-Affash, Carmi, and Krasin, we construct a partition $\mathbb{P}(T)$ of T consisting of $\gamma_r(T)$ vertex-disjoint subtrees, each of which contains exactly one vertex of D^* . (Haddadan et al. called such a set D^* a *canonical dominating set*.) For convenience, we denote by C_x the member of $\mathbb{P}(T)$ whose intersection with D^* is the vertex x . We claim that $\mathbb{P}(T)$ satisfies the following property: for any DrDS D of G , each member of $\mathbb{P}(T)$ contains at least one vertex in D . Using this property, one can design a linear-time algorithm for constructing a TJ-sequence between any pair of size- k DrDSs D_s, D_t of G . The key idea is one can transform both D_s and D_t into some DrDS D that contains D^* . For instance, to transform D_s into D , for each subtree $C_x \in \mathbb{P}(T)$ for $x \in D^*$, we move any token in $D_s \cap V(C_x)$ to x . If we handle each subtree C_x based on the order of subtrees added to $\mathbb{P}(T)$ in our modified implementation, such a transformation will form a TJ-sequence in T . After this procedure, we obtain a set of tokens D' that contains D^* and since D^* is a minimum DrDS of G , transforming D' into D under TJ can now be done easily: until there are no tokens to move, repeatedly take a token in $D' - D$, move it to some vertex in $D - D'$, and update both D and D' .

We now define some notations and, for the sake of completeness, describe the algorithm of Abu-Affash, Carmi, and Krasin [AACK22]. In a graph G , for a vertex subset $D \subseteq V(G)$ and a vertex $u \in V(G)$, we define $\delta_D(u) = \min_{v \in D} \text{dist}_G(u, v)$ and call it the *distance* between u and D . Observe that a vertex u is r -dominated by D if $\delta_D(u) \leq r$ and therefore D is a

$DrDS$ of G if for every $u \in V(G)$ we have $\delta_D(u) \leq r$. For a n -vertex tree T , let T_u be the *rooted form* of T when regarding the vertex $u \in V(T)$ as the root. For each $v \in V(T_u)$, we denote by T_v the subtree of T_u rooted at v . In other words, T_v is the subtree of T_u induced by v and its descendants. We also define $h(T_v) = \max_{w \in V(T_v)} \text{dist}_{T_u}(v, w)$ and call it the *height* of T_v . In other words, $h(T_v)$ is the largest distance from v to a vertex in T_v . The set of children of v in T_u is denoted by $\text{child}(v)$.

The algorithm is described in Algorithm 1. In short, in each iteration, it finds a subtree T_v of height exactly r , adds v to D^* , and removes all the leaves of T_u that are in $N_{T_u}^r[v]$. To implement the algorithm in $O(n)$ time, a modified version of the depth-first search (DFS) algorithm was used in [AACK22] (Function `ModifiedDFS` in Algorithm 1). The procedure `ModifiedDFS` visits the vertices of T_u starting from the root u and recursively visits each of its children, which means vertices in D^* would be added in a “bottom-up” fashion. In each recursive call `ModifiedDFS(v)`, if $h(T_v) = r$ then v is added to D^* and since all vertices in T_v is r -dominated by v , we remove them from T_u and return $\delta_{D^*}(v) = 0$. Otherwise ($h(T_v) \neq r$), we call `ModifiedDFS(w)` for each child w of v , and we update $\delta_{D^*}(v)$ and $h(T_v)$ according to these calls. When these calls return, we have $h(T_v) \leq r$. Then we check whether $\delta_{D^*}(v) + h(T_v) \leq r$. If so (which means the current D^* r -dominates v and all its descendants in the original rooted tree T_u), we remove all the vertices of T_v from T_r and return $\delta_{D^*}(v)$. Otherwise ($\delta_{D^*}(v) + h(T_v) > r$), we check again whether $h(T_v) = r$ (in case the descendants reduced the height of T_v to r). If so, we add v to D^* , remove all the vertices of T_v from T_u , and return $\delta_{D^*}(v) = 0$. Otherwise ($h(T_v) < r$), we return ∞ . Finally, when $\delta_{D^*}(u) = \infty$, we add u to D^* .

To illustrate Algorithm 1, we consider the example from [AACK22] for $r = 2$ with the tree T_u rooted at $u = 1$ as described in Figure 7. The first vertex added to D^* is 7 in `ModifiedDFS(7)`, since $h(T_7) = 2$. In this call, we remove T_7 from T_u , update $h(T_7) = -1$ and return $\delta_{D^*}(7) = 0$ to `ModifiedDFS(4)`. In `ModifiedDFS(4)`, we update $\delta_{D^*}(4) = 1$ and, after traversing vertices 6 and 8, $h(T_4) = 1$, and since $h(T_4) + \delta_{D^*}(4) = 2 = r$ and 7 is the latest vertex added to D^* , we remove T_4 from T_u and return $\delta_{D^*}(4) = 1$ to `ModifiedDFS(2)`. In `ModifiedDFS(2)`, since $h(T_2) = 3 > r$, we call `ModifiedDFS(5)` which adds 5 to D^* , removes T_5 from T_u , and returns $\delta_{D^*}(5) = 0$. Then, we update $\delta_{D^*}(2) = 1$ and $h(T_2) = 0$, and since $h(T_2) + \delta_{D^*}(2) = 1 < r$ and 5 is the latest vertex added to D^* , we remove T_2 from T_u , and return $\delta_{D^*}(2) = 1$ to `ModifiedDFS(1)`. In `ModifiedDFS(1)`, since $\delta_{D^*}(1) = 2$ and, after traversing 3, $h(T_1) = 1$, we return $\delta_{D^*}(1) = \infty$ to Algorithm 1, and therefore, we add 1 to D^* .

We now describe how to construct our desired partition $\mathbb{P}(T_u)$. Recall that $\mathbb{P}(T_u)$ is nothing but a collection of vertex-disjoint subtrees whose union is the original tree T_u . Suppose that D^* is the minimum $DrDS$ of T_u obtained from Algorithm 1 and furthermore assume that vertices of D^* are ordered by the time they were added to D^* . For each $v \in D^*$, we define C_v (the unique member of $\mathbb{P}(T_u)$ containing v) as T_v (the subtree of T_u rooted at v) and then delete T_v from T_u . Figure 7 illustrates how to construct $\mathbb{P}(T_u)$ in the above example. From the construction, it is clear that each member of $\mathbb{P}(T_u)$ contains exactly one vertex from D^* . We say that two subtrees C_x, C_y in $\mathbb{P}(T_u)$ are *adjacent* if there exists $v \in V(C_x)$ and $w \in V(C_y)$ such that $vw \in E(T_u)$. If a subtree contains the root u then we call it the *root subtree*. Otherwise, if a subtree has exactly one adjacent subtree then we call it a *leaf subtree* and otherwise an *internal subtree*.

We now claim that the constructed partition $\mathbb{P}(T_u)$ satisfies the following property.

► **Lemma 23.** *Let D be any $DrDS$ of T_u . Then, $D \cap V(C_v) \neq \emptyset$ holds for every $v \in D^*$.*

Proof. We claim that for each $v \in D^*$, one can find a vertex $v' \in V(C_v)$ such that $N_7^r[v'] \subseteq$

Algorithm 1 $\text{MinDrDSTree}(T_u)$

Input: A tree T_u rooted at u .

Output: A minimum distance- r dominating set D^* of T_u .

```

1  $D^* \leftarrow \emptyset$ 
2 for each  $v \in V(T_u)$  do
3    $\text{compute } h(T_v)$ 
4    $\delta_{D^*}(v) \leftarrow \infty$ 
5  $\delta_{D^*}(u) \leftarrow \text{ModifiedDFS}(u)$ 
6 if  $\delta_{D^*}(u) = \infty$  then
7    $D^* \leftarrow D^* + u$ 
8 return  $D^*$ 

9 Function  $\text{ModifiedDFS}(v)$ :
10 if  $h(T_v) = r$  then
11    $D^* \leftarrow D^* + v$ 
12    $T_u \leftarrow T_u - T_v$ 
13    $h(T_v) \leftarrow -1$ 
14    $\delta_{D^*}(v) \leftarrow 0$ 
15 else //  $h(T_v) > r$ 
16   for each  $w \in \text{child}(v)$  do
17     if  $h(T_w) \geq r$  then
18        $\delta_{D^*}(v) \leftarrow \min\{\delta_{D^*}(v), \text{ModifiedDFS}(w) + 1\}$ 
19    $h(T_v) \leftarrow \max\{h(T_w) + 1 : w \in \text{child}(v)\}$  // updating  $h(T_v)$ 
20   if  $h(T_v) + \delta_{D^*}(v) \leq r$  then
21      $T_u \leftarrow T_u - T_v$ 
22      $h(T_v) \leftarrow -1$ 
23   if  $h(T_v) = r$  then
24      $D^* \leftarrow D^* + v$ 
25      $T_u \leftarrow T_u - T_v$ 
26      $h(T_v) \leftarrow -1$ 
27      $\delta_{D^*}(v) \leftarrow 0$ 
28   else
29      $\delta_{D^*}(v) \leftarrow \infty$ 
30 return  $\delta_{D^*}(v)$ 

```

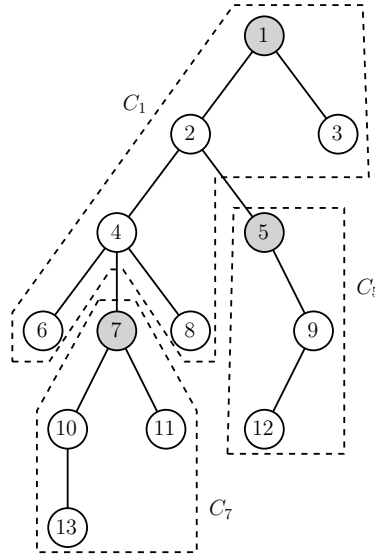

■ **Figure 7** A tree T_u rooted at $u = 1$. For $r = 2$, Algorithm 1 returns $D^* = \{7, 5, 1\}$. A partition $\mathbb{P}(T_u) = \{C_7, C_5, C_1\}$ of T_u is also constructed.

$V(C_v)$. For each $v \in D^*$, let D_v^* be the set of all vertices added to D^* before v .

If C_v is a leaf subtree, we take any leaf in C_v of distance exactly r from v and regard it as v' . Clearly, v' is also a leaf of T_u and is not r -dominated by any vertex outside C_v , i.e., $N_T^r[v'] \subseteq V(C_v)$.

If C_v is an internal subtree, we describe how to find our desired v' . From Algorithm 1, since v is the next vertex added to D_v^* , it follows that there must be some vertex in $V(C_v)$ not r -dominated by any member of D_v^* ; we take v' to be the one having maximum distance from v among all those vertices. By definition, v' is clearly not r -dominated by any vertex in a C_w where $w \in D_v^*$. Since C_v is an internal subtree, by Algorithm 1, the distance between v and v' must be exactly r and therefore no vertex in a C_w , where $w \in D^* - D_v^* - v$, r -dominates v . (Recall that by Algorithm 1, since v is added to D_v^* , the current subtree T_v must have height exactly r .) Thus, $N_T^r[v'] \subseteq V(C_v)$.

If C_v is the root subtree, again we can choose v' using exactly the same strategy as in the case for internal subtrees. The main difference here is that, by Algorithm 1, the distance between v' and v may not be exactly r . However, since C_v contains the root u , v is the last vertex added to D^* . (Intuitively, this means C_v has no “parent subtree” above it.) Therefore, in order to show that $N_T^r[v'] \subseteq V(C_v)$, it suffices to show that no vertex in a C_w , where $w \in D_v^*$, r -dominates v' . Indeed, this clearly holds by definition of v' .

We are now ready to prove the lemma. Suppose to the contrary that there exists $v \in D^*$ such that $D \cap V(C_v) = \emptyset$. Then, D does not r -dominate v' —a vertex in C_v with $N_T^r[v'] \subseteq V(C_v)$. This contradicts the assumption that D is a Dr DS. Our proof is complete. ◀

The following lemma is crucial in proving Theorem 17.

► **Lemma 24.** *Let D be an arbitrary Dr DS of T_u . Let D' be any Dr DS of T_u that contains D^* , i.e., $D^* \subseteq D'$. Then, in $O(n)$ time, one can construct a TJ-sequence \mathcal{S} in T_u between D and D' .*

Proof. We construct \mathcal{S} as follows. Initially, $\mathcal{S} = \emptyset$.

Step 1: For each $v \in D^*$, let x be any vertex in $D \cap V(C_v)$. From Lemma 23, such a vertex x exists. We append $x \xrightarrow{T_u}_{\text{TJ}} v$ to \mathcal{S} and assign $D \leftarrow D - x + v$. (After this step, clearly $D^* \subseteq D \cap D'$.)

Step 1: Let $x \in D - D'$ and $y \in D' - D$. We append $x \xrightarrow{T_u}_{\text{TJ}} y$ to \mathcal{S} and assign $D \leftarrow D - x + y$. Repeat this step until $D = D'$.

For each $v \in D^*$, let D_v^* be the set of all vertices added to D^* before v . Since any vertex r -dominated by x and not in C_v is r -dominated by either v or a member of D_v^* , any move performed in **Step 1** results a new DrDS of T_u . Note that after **Step 1**, $D^* \subseteq D \cap D'$. Thus, any move performed in **Step 2** results a new DrDS of T_u . In short, \mathcal{S} is indeed a TJ-sequence in T_u . In the above construction, as we “touch” each vertex in D at most once, the running time is indeed $O(n)$. ◀

Using Lemma 24, it is not hard to prove Theorem 17. More precisely, let (T, D_s, D_t) be an instance of DrDSR under TJ where D_s and D_t are two DrDS s of a tree T . By Lemma 24, one can immediately decide if (T, D_s, D_t) is a yes-instance by comparing the sizes of D_s and D_t : if they are of the same size then the answer is “yes” and otherwise it is “no”. Moreover, in a yes-instance, Lemma 24 allows us to construct in linear time a TJ-sequence (which is not necessarily a shortest one) between D_s and D_t .

B Omitted Details for Section 4 (Hardness Results)

(Minimum) Vertex Cover Reconfiguration. Recall that a *vertex cover* of a graph G is a vertex subset C such that for every edge e of G , at least one endpoint of e is in C . An *independent set* of a graph G is a vertex subset I such that no two vertices in I are joined by an edge. We use $\tau(G)$ and $\alpha(G)$ to respectively denote the size of a minimum vertex cover and a maximum independent set of G . In a VERTEX COVER RECONFIGURATION (VCR)’s instance (G, C_s, C_t) under $R \in \{\text{TS}, \text{TJ}, \text{TAR}\}$, two vertex covers C_s and C_t a graph G are given, and the question is to decide whether there is a R -sequence between C_s and C_t . The INDEPENDENT SET RECONFIGURATION (ISR) problem under $R \in \{\text{TS}, \text{TJ}, \text{TAR}\}$ is defined similarly. In the MINIMUM VERTEX COVER RECONFIGURATION (MIN-VCR) (resp., MAXIMUM INDEPENDENT SET RECONFIGURATION (MAX-ISR)) problem, all inputs are minimum vertex covers (resp., maximum independent sets). Since I is an independent set of G if and only if $V(G) - I$ is a vertex cover, from the classic complexity viewpoint, VCR (resp., MIN-VCR) and ISR (resp., MAX-ISR) share the same complexity status under the same reconfiguration rule. In this paper, we are interested in using some variants of MIN-VCR as the bases for our hardness reduction.

Ito et al. [IDH⁺11] proved that ISR is PSPACE-complete on general graphs under TAR. Since TJ and TAR are somewhat equivalent [KMM12, Theorem 1]—any reconfiguration sequence under TJ between two size- k independent sets can be converted to a reconfiguration sequence under TAR whose members are independent sets of size at least $k - 1$ and vice versa—the result of Ito et al. can be applied for TJ. Indeed, Ito et al. constructed reconfiguration sequences under TAR which contain only independent sets of maximum size k and those of size $k - 1$. When converting to reconfiguration sequences under TJ as described in [KMM12, Theorem 1], all independent sets have *maximum* size. Additionally, note that any TJ-move applied to a maximum independent set is indeed also a TS-move³, because any maximum

³ Another way to see this is as follows. From Ito et al.’s construction, observe that under TJ no token can

independent set is also a dominating set. Thus, the result of Ito et al. can be applied for TS even when all independent sets are of maximum size. In short, MAX-ISR is PSPACE-complete on general graphs under $R \in \{\text{TS}, \text{TJ}, \text{TAR}\}$ and therefore so is MIN-VCR.

Hearn and Demaine [HD05] proved that ISR is PSPACE-complete on planar graphs of maximum degree three and later van der Zanden [van15] extended their results for those graphs with the additional “bounded bandwidth” restriction. Hearn and Demaine explicitly considered only the TS rule and later Bonsma et al. [BKW14] observed that their result also holds under TJ and TAR (using a similar argument as what we mentioned for general graphs). Again, since their proofs only involve *maximum* independent sets, MAX-ISR is PSPACE-complete on planar graphs of maximum degree three and bounded bandwidth under $R \in \{\text{TS}, \text{TJ}, \text{TAR}\}$ and therefore so is MIN-VCR.

► **Theorem 18** (*). *DrDSR under $R \in \{\text{TS}, \text{TJ}\}$ on planar graphs of maximum degree six and bounded bandwidth is PSPACE-complete for any $r \geq 2$.*

Proof. We give a polynomial-time reduction from MIN-VCR on planar graphs of maximum degree three and bounded bandwidth. Our reduction extends the classic reduction from VERTEX COVER to DOMINATING SET [GJ79]. This reduction has also been modified for showing the hardness of the problem for $r = 1$ (i.e., DOMINATING SET RECONFIGURATION) by Haddadan et al. [HIM⁺16] under TAR and later by Bonamy et al. [BDO21] under TS. Let (G, C_s, C_t) be an instance of MIN-VCR under R where C_s, C_t are two minimum vertex covers of a planar graph G of maximum degree three and bounded bandwidth. We will construct an instance (G', D_s, D_t) of DrDSR under R where D_s and D_t are two DrDSs of a planar graph G' of maximum degree six and bounded bandwidth.

Suppose that $V(G) = \{v_1, \dots, v_n\}$. We construct G' from G as follows. For each edge $v_i v_j \in E(G)$, add a new path $P_{ij} = x_{ij}^0 x_{ij}^1 \dots x_{ij}^{2r}$ of length $2r$ ($1 \leq i, j \leq n$) with $x_{ij}^0 = v_i$ and $x_{ij}^{2r} = v_j$. Observe that $x_{ij}^p = x_{ji}^{2r-p}$ for $0 \leq p \leq 2r$. Intuitively, G' is obtained from G by replacing each edge of G by a cycle C_{ij} of length $2r + 1$ formed by the path P_{ij} and the edge $uv = v_i v_j$. We define $D_s = C_s$ and $D_t = C_t$. Clearly, this construction can be done in polynomial time. (See Figure 8.)

We now in the next two lemmas that (G', D_s, D_t) is indeed our desired DrDSR's instance.

► **Claim 25.** *G' is planar, of maximum degree six, and bounded bandwidth.*

Proof. It follows directly from the construction that G' is planar and has maximum degree six. Since the number of edges of G' is exactly $(2r + 1)$ times the number of edges of G , the bandwidth of G' increases (comparing to that of G) only by a constant multiplicative factor, which implies that G' is a bounded bandwidth graph. ◀

► **Claim 26.** *Any minimum vertex cover of G is also a minimum DrDS of G' . Consequently, both D_s and D_t are minimum DrDSs of G' .*

Proof. It follows directly from the construction that both D_s and D_t are DrDSs of G' (and so is any minimum vertex cover of G). To show that all minimum vertex covers of G are also minimum DrDSs of G' , we prove that $\tau(G) = \gamma_r(G')$ where $\tau(G)$ and $\gamma_r(G')$ are respectively the size of a minimum vertex cover of G and a minimum DrDS of G' . Since any minimum vertex cover of G is also a DrDS of G' , we have $\tau(G) \geq \gamma_r(G')$. On the other hand, from the

ever leaves its corresponding gadget, which is either an edge or a triangle, and therefore any TJ-move is indeed also a TS-move.

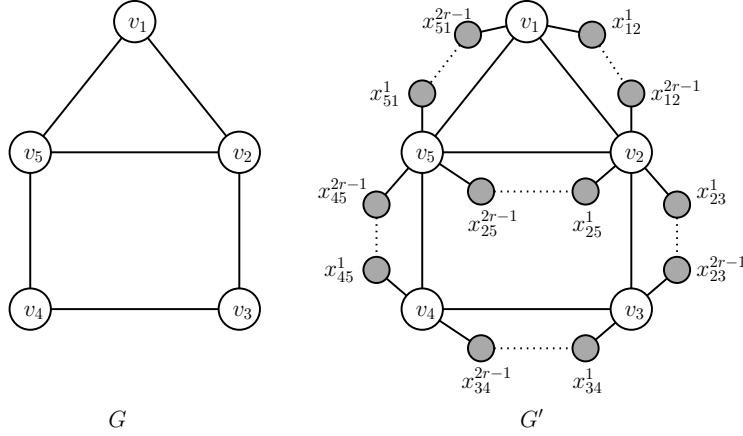

■ **Figure 8** An example of constructing G' from a planar, subcubic, and bounded bandwidth graph G in the proof of Theorem 18. Vertices in $V(G') - V(G)$ are marked with the gray color. Each dotted path is of length $2r - 2$.

construction of G' , observe that for any pair $i, j \in \{1, \dots, n\}$ with $v_i v_j \in E(G)$, the vertex x_{ij}^r (whose distance from both v_i and v_j is exactly r) can only be r -dominated by some vertex in $V(C_{ij})$, which implies that one needs at least $\tau(G)$ tokens to r -dominate $V(G')$. Therefore, $\gamma_r(G') \geq \tau(G)$. ◀

We are now ready to show the correctness of our reduction. (Claims 27 and 28.)

► **Claim 27.** *Under TS, (G, C_s, C_t) is a yes-instance if and only if (G', D_s, D_t) is a yes-instance.*

Proof(\Rightarrow) Let \mathcal{S} be a TS-sequence in G between C_s and C_t . Since any minimum vertex cover of G is also a minimum Dr DS of G' , the sequence \mathcal{S}' obtained by replacing each move $u \xrightarrow{G} v$ in \mathcal{S} by $u \xrightarrow{G'} v$ is also a TS-sequence in G' between $D_s = C_s$ and $D_t = C_t$.

(\Leftarrow) Let \mathcal{S}' be a TS-sequence in G' between D_s and D_t . We construct a sequence of token-slides \mathcal{S} in G between $C_s = D_s$ and $C_t = D_t$ as follows. Initially, $\mathcal{S} = \emptyset$. For each move $u \xrightarrow{G'} v$ in \mathcal{S}' , we consider the following cases.

- **Case 1:** $u \in V(G)$ and $v \in V(G)$. It must happen that $u = v_i$ and $v = v_j$ for some $i, j \in \{1, \dots, n\}$ such that $v_i v_j \in E(G)$. We append $v_i \xrightarrow{G} v_j$ to \mathcal{S} .
- **Case 2:** $u \in V(G)$ and $v \in V(G') - V(G)$. Do nothing.
- **Case 3:** $u \in V(G') - V(G)$ and $v \in V(G)$. It must happen that $u = x_{ij}^{2r-1}$ and $v = x_{ij}^{2r} = v_j$ for some $i, j \in \{1, \dots, n\}$ such that $v_i v_j \in E(G)$. We append $v_i \xrightarrow{G} v_j$ to \mathcal{S} .
- **Case 4:** $u \in V(G') - V(G)$ and $v \in V(G') - V(G)$. Do nothing.

To see that \mathcal{S} is indeed a TS-sequence in G , it suffices to show that if C is the minimum vertex cover obtained right before the move $v_i \xrightarrow{G} v_j$ in G then $C' = C - v_i + v_j$ is also a minimum vertex cover of G . If **Case 1** happens, this is trivial. Thus, it remains to consider the case when **Case 3** happens. In this case, suppose to the contrary that C' is not a vertex cover of G . It follows that there exists $k \in \{1, \dots, n\}$ such that $v_i v_k \in E(G)$, $v_k \neq v_j$, and $v_k \notin C'$. Intuitively, the edge $v_i v_k \in E(G)$ is not covered by any vertex in C' . On the other hand, let D be the Dr DS of G' obtained right before the move

$x_{ij}^{2r-1} \xrightarrow{G'}_{\text{TS}} x_{ij}^{2r} = v_j$. Since $D' = D - x_{ij}^{2r-1} + x_{ij}^{2r}$ is also a DrDS of G' , there must be some vertex in D' that r -dominates x_{ik}^r , which implies $V(P_{ik}) \cap D' \neq \emptyset$. However, from the construction of \mathcal{S} , it follows that $v_k \in C$, which is a contradiction. Thus, C' is a vertex cover of G . Since $|C'| = |C|$, it is also minimum. \blacktriangleleft

► **Claim 28.** *Under TJ, (G, C_s, C_t) is a yes-instance if and only if (G', D_s, D_t) is a yes-instance.*

Proof(\Rightarrow) Let \mathcal{S} be a TJ-sequence in G between C_s and C_t . Since any minimum vertex cover of G is also a minimum DrDS of G' , the sequence \mathcal{S}' obtained by replacing each move $u \xrightarrow{G}_{\text{TJ}} v$ in \mathcal{S} by $u \xrightarrow{G'}_{\text{TJ}} v$ is also a TS-sequence in G' between $D_s = C_s$ and $D_t = C_t$.

(\Leftarrow) Let \mathcal{S}' be a TJ-sequence in G' between D_s and D_t . We construct a sequence of token-jumps \mathcal{S} in G between $C_s = D_s$ and $C_t = D_t$ as follows. Initially, $\mathcal{S} = \emptyset$. For each move $u \xrightarrow{G'}_{\text{TJ}} v$ in \mathcal{S}' , we consider the following cases.

- **Case 1:** $u \in V(G)$ and $v \in V(G)$. It must happen that $u = v_i$ and $v = v_j$ for some $i, j \in \{1, \dots, n\}$. We append $v_i \xrightarrow{G}_{\text{TJ}} v_j$ to \mathcal{S} .
- **Case 2:** $u \in V(G)$ and $v \in V(G') - V(G)$. Do nothing.
- **Case 3:** $u \in V(G') - V(G)$ and $v \in V(G)$. From the construction of G' , for each pair $i, j \in \{1, \dots, n\}$ such that $v_i v_j \in E(G)$, the vertex x_{ij}^r must be r -dominated by at least one vertex of C_{ij} . Additionally, note that any token-set resulting from a move in \mathcal{S}' must be a minimum DrDS of G' . Thus, we must have $u = x_{ij}^p$ and $v = x_{ij}^{2r} = v_j$ for some $i, j \in \{1, \dots, n\}$ such that $v_i v_j \in E(G)$ and $1 \leq p \leq 2r - 1$. Now, we append $v_i \xrightarrow{G}_{\text{TS}} v_j$ to \mathcal{S} .
- **Case 4:** $u \in V(G') - V(G)$ and $v \in V(G') - V(G)$. Do nothing.

To see that \mathcal{S} is indeed a TJ-sequence in G , it suffices to show that if C is the minimum vertex cover obtained right before the move $v_i \xrightarrow{G}_{\text{TJ}} v_j$ in G then $C' = C - v_i + v_j$ is also a minimum vertex cover of G . If **Case 1** happens, this is trivial. Thus, it remains to consider the case **Case 3** happens. In this case, suppose to the contrary that C' is not a vertex cover of G . It follows that there exists $k \in \{1, \dots, n\}$ such that $v_i v_k \in E(G)$, $v_k \neq v_j$, and $v_k \notin C'$. Intuitively, the edge $v_i v_k \in E(G)$ is not covered by any vertex in C' . On the other hand, let D be the DrDS of G' obtained right before the move $x_{ij}^p \xrightarrow{G'}_{\text{TJ}} x_{ij}^{2r} = v_j$, for $1 \leq p \leq 2r - 1$. Since $D' = D - x_{ij}^p + x_{ij}^{2r}$ is also a DrDS of G' , there must be some vertex in D' that r -dominates x_{ik}^r , which implies $V(P_{ik}) \cap D' \neq \emptyset$. However, from the construction of \mathcal{S} , it follows that $v_k \in C$, which is a contradiction. Thus, C' is a vertex cover of G . Since $|C'| = |C|$, it is also minimum. \blacktriangleleft

Our proof is complete. \blacktriangleleft

► **Claim 20** (*). *There is a reconfiguration sequence between two NCL configurations C_s and C_t if and only if there is a TS-sequence between their corresponding standard token placements in the constructed graph. Additionally, the constructed graph is planar, has maximum degree three and bounded bandwidth.*

Proof. Observe that, starting from a standard token placement, no link token ever leaves its corresponding edge ($(a_1 a_2)$, $(b_1 b_2)$, or $(c_1 c_2)$). Otherwise, one of the two degree-1 vertices in the link component would not be r -dominated by the resulting token-set. Hence, a one-to-one mapping exists between the direction of an NCL edge and the placement of a link token:

a link token is placed on either a_1 , b_1 , or c_1 if and only if the corresponding NCL edge is directed inward, and on either a_2 , b_2 , or c_2 if and only if the corresponding NCL edge is directed outward.

The AND gadget satisfies the same constraint as an NCL AND vertex. The top token can slide from a_1 to a_2 (which corresponds to the reversal of the top weight-2 (blue) edge from inward to outward) only when both bottom tokens slide in respectively from b_2 to b_1 and c_2 to c_1 (corresponding to the reversal of the two bottom weight-1 (red) edges from outward to inward).

Similarly, the OR gadget satisfies the same constraint as an NCL OR vertex. The top token can slide from a_1 to a_2 (corresponding to the reversal of the top weight-2 (blue) edge from inward to outward) only when at least one of the two bottom tokens slides either from b_2 to b_1 or from c_2 to c_1 (corresponding to the reversal of at least one of the two bottom weight-2 (blue) edges from outward to inward).

Thus, given a sequence $\langle C_s = C_1, C_2, \dots, C_p = C_t \rangle$ of NCL configurations where C_i and C_{i+1} are adjacent, for $1 \leq i \leq p-1$, one can construct (using the above one-to-one mapping) a TS-sequence between the corresponding standard token placements, and vice versa. Therefore, our reduction is correct.

Recall that the original NCL graph is planar and bounded bandwidth. Since both our gadgets are planar, having only a constant number of edges (as r is a fixed constant), and of maximum degree three, the constructed graph is also planar, bounded bandwidth, and of maximum degree three. (For example, see Figure 6). ◀

► **Theorem 21** (*). *DrDSR under $R \in \{\text{TS}, \text{TJ}\}$ on chordal graphs is PSPACE-complete for any $r \geq 2$.*

Proof. We give a polynomial-time reduction from MIN-VCR on general graphs. We remark that a similar idea has been used in [Hoa23]. Let (G, C_s, C_t) be an instance of MIN-VCR under R where C_s, C_t are two minimum vertex covers of a graph G . We will construct an instance (G', D_s, D_t) of DrDSR under R where D_s and D_t are two DrDSs of a chordal graph G' .

Suppose that $V(G) = \{v_1, \dots, v_n\}$. We construct G' from G as follows.

- Form a clique in G' having all vertices v_1, \dots, v_n of G
- For each edge $v_i v_j \in E(G)$ ($i, j \in \{1, \dots, n\}$) and for $p \in \{1, 2\}$, add a corresponding new vertex x_{ij}^p and create an edge from it to both v_i and v_j . Observe that $x_{ij}^p = x_{ji}^p$. Furthermore, create a new path P_{ij}^p of length exactly $r-1$ attached to x_{ij}^p .

We define $D_s = C_s$ and $D_t = C_t$. Clearly, this construction can be done in polynomial time. (See Figure 9.)

Now, we show that (G', D_s, D_t) is indeed our desired DrDSR's instance. It follows from the construction that G' is indeed a chordal graph. More precisely, if we define $H = (K \uplus S, F)$ to be the subgraph of G' induced by $K \cup S$ with $K = \{v_1, \dots, v_n\}$ forming a clique and $S = \bigcup_{p=1}^2 \bigcup_{\{i,j \mid v_i v_j \in E(G)\}} \{x_{ij}^p\}$ forming an independent set, then H is indeed a split graph. Moreover, G' is obtained from H by attaching paths to each member of S , which clearly results a chordal graph. Additionally, one can verify that any minimum vertex cover of G is also a minimum dominating set of H and therefore a minimum DrDS of G' .

It remains to show that our reduction is correct, i.e., under $R \in \{\text{TS}, \text{TJ}\}$, (G, C_s, C_t) is a yes-instance if and only if (G', D_s, D_t) is a yes-instance.

- (\Rightarrow) Let \mathcal{S} be a R -sequence in G between C_s and C_t . Since any minimum vertex cover of G is also a minimum DrDS of G' , the sequence \mathcal{S}' obtained by replacing each move $u \xrightarrow{G} v$ in \mathcal{S} by $u \xrightarrow{G'} v$ is also a R -sequence in G' between $D_s = C_s$ and $D_t = C_t$.

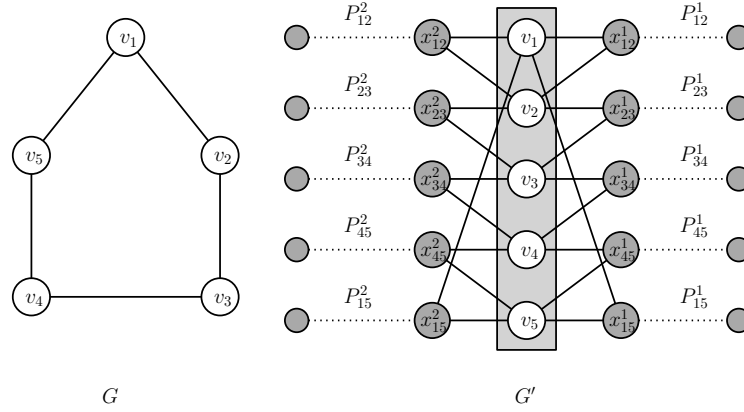

■ **Figure 9** An example of constructing G' from a graph G in the proof of Theorem 21. Vertices in $V(G') - V(G)$ are marked with the gray color. Vertices in the light gray box form a clique. Each dotted path is of length exactly $r - 1$.

(\Leftarrow) Let \mathcal{S}' be a R-sequence in G' between D_s and D_t . From the construction of G' , observe that no token can be moved to a vertex in $V(G') - V(G)$; otherwise some degree-1 endpoint of a P_{ij}^p ($p \in \{1, 2\}$, $i, j \in \{1, \dots, n\}$) would not be r -dominated by the resulting token-set. Therefore, any move $u \xrightarrow{G'}_R v$ in \mathcal{S}' satisfies that both u and v are in $V(G)$, and thus can be replaced by the move $u \xrightarrow{G}_R v$ to construct \mathcal{S} —our desired R-sequence between $C_s = D_s$ and $C_t = D_t$ in G .

Our proof is complete. \blacktriangleleft

► **Theorem 22** (*). *DrDSR under $R \in \{\text{TS}, \text{TJ}\}$ on bipartite graphs is PSPACE-complete for any $r \geq 2$.*

Proof. We give a polynomial-time reduction from MIN-VCR on general graphs. Our reduction extends the one given by Bonamy et al. [BDO21] for the case $r = 1$. Let (G, C_s, C_t) be an instance of MIN-VCR under R where C_s, C_t are two minimum vertex covers of a graph G . We will construct an instance (G', D_s, D_t) of DrDSR under R where D_s and D_t are two DrDSs of a bipartite graph G' .

Suppose that $V(G) = \{v_1, \dots, v_n\}$. We construct G' from G as follows.

- (a) Replace each edge $v_i v_j$ by a path $P_{ij} = x_{ij}^0 x_{ij}^1 \dots x_{ij}^{2r}$ of length $2r$ ($1 \leq i, j \leq n$) with $x_{ij}^0 = v_i$ and $x_{ij}^{2r} = v_j$. Observe that $x_{ij}^p = x_{ji}^{2r-p}$ for $0 \leq p \leq 2r$.
- (b) Add a new vertex x and join it to every vertex in $V(G)$.
- (c) Attach a new path P_x of length r to x .

We define $D_s = C_s + x$ and $D_t = C_t + x$. Clearly, this construction can be done in polynomial time. (See Figure 10.)

In the next two claims, we prove that our construction results in an instance of DrDSR on bipartite graphs: Claim 29 shows that G' is bipartite and Claim 30 implies that both D_s and D_t are minimum DrDSs of G' .

► **Claim 29.** *G' is a bipartite graph.*

Proof. We show that any cycle \mathcal{C}' in G' has even length and therefore G' is bipartite. Observe that no cycle of G' contains a vertex from $V(P_x) - x$. From the construction, if \mathcal{C}' does not contain x , it follows that $V(\mathcal{C}') \cap V(G)$ must form a cycle \mathcal{C} of G . Therefore, \mathcal{C}' is of length

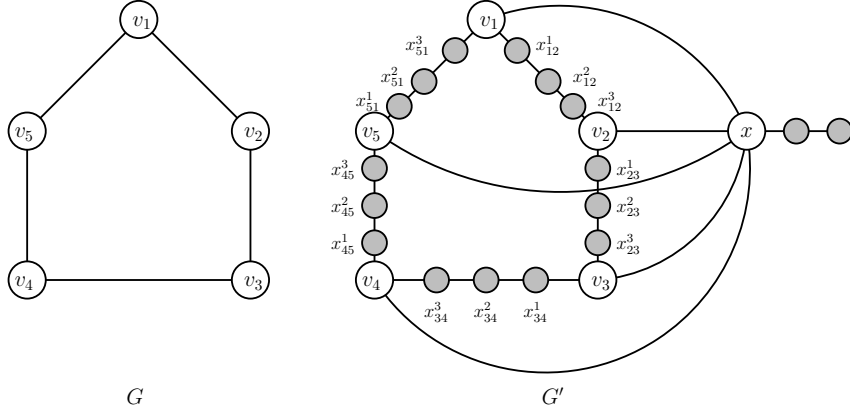

■ **Figure 10** An example of constructing a bipartite graph G' from a graph G when $r = 2$ in the proof of Theorem 22.

$2r|E(\mathcal{C})|$, which is even. On the other hand, if \mathcal{C}' contains x , it follows that $V(\mathcal{C}') \cap V(G)$ must form a path \mathcal{P} of G . Therefore, \mathcal{C}' is of length $2 + 2r|E(\mathcal{P})|$, which again is even. ◀

► **Claim 30.** Any set of the form $C + x$, where C is a minimum vertex cover of G , is a minimum $DrDS$ of G' .

Proof. To see this, note that, by construction, in G' , x r -dominates every vertex in $V(G') - \bigcup_{v_i, v_j \in E(G)} \{x_{ij}^r\}$. Additionally, since each x_{ij}^r belongs to exactly one path P_{ij} and C is a minimum vertex cover of G , it follows that in G' , C r -dominates $\bigcup_{v_i, v_j \in E(G)} \{x_{ij}^r\}$. Thus, $C + x$ r -dominates $V(G')$, i.e., $C + x$ is a $DrDS$ of G' .

It remains to show that $C + x$ is minimum. Indeed, it is sufficient to show that $\tau(G) + 1 = \gamma_r(G')$ where $\tau(G)$ and $\gamma_r(G')$ are respectively the size of a minimum vertex cover of G and a minimum $DrDS$ of G' . Since $C + x$ is a $DrDS$ of G' , we have $\tau(G) + 1 = |C| + x \geq \gamma_r(G')$. On the other hand, note that any minimum $DrDS$ D' of G' must r -dominate $V(P_x)$ and therefore contains a vertex of P_x (which, by the construction, does not belong to G). Moreover, from the construction of G' , each path P_{ij} ($1 \leq i, j \leq n$ and $v_i v_j \in E(G)$) is of length $2r$. Thus, in order to r -dominate all $V(P_{ij})$, D' needs to contain at least one vertex from each path P_{ij} . Therefore, $\gamma_r(G') = |D'| \geq 1 + \tau(G)$. Our proof is complete. ◀

Before proving the correctness of our reduction, we prove some useful observations.

► **Claim 31.** Let $D = C + x$ be a $DrDS$ of G' where C is a minimum vertex cover of G . Then,

- (a) $D - u + y$ is not a $DrDS$ of G' , for any $u \in C$ and $y \in V(P_x) - x$.
- (b) $D - x + v$ is not a $DrDS$ of G' , for any $v \in V(G') - x$.
- (c) $D - u + z$ is not a $DrDS$ of G' , for $u = v_i \in C$ and $z \notin \bigcup_{\{j|v_j \in N_G(v_i) - C\}} V(P_{ij})$.

Proof. (a) Suppose to the contrary there exists $u \in C$ and $y \in V(P_x) - x$ such that $D' = D - u + y$ is a $DrDS$ of G' . Since $|D'| = |D| = \tau(G) + 1$, Claim 30 implies that D' is a minimum $DrDS$ of G' . On the other hand, from the construction of G' , any vertex r -dominated by y must also be r -dominated by x . Thus, $D' - y$ is also a $DrDS$ of G' , which is a contradiction.

(b) Suppose to the contrary there exists $v \in V(G') - x$ such that $D' = D - x + v$ is a $DrDS$ of G' . From (a), it follows that $v \in V(P_x) - x$; otherwise some vertex of P_x would not be r -dominated by any member of D' . Since C is a minimum vertex cover of G , it follows

that there exists a pair $i, j \in \{1, \dots, n\}$ such that $v_i v_j \in E(G)$ and $C \cap \{v_i, v_j\} = \{v_i\}$; otherwise every vertex of G would contain a token in C and therefore C would not be minimum—a contradiction. From the construction of G' , x is the unique vertex in $V(P_x)$ that r -dominates x_{ij}^{r+1} . Thus, x_{ij}^{r+1} is not r -dominated by any vertex in $D' = D - x + v$ for $v \in V(P_x) - x$, which is a contradiction.

- (c) Let $j \in \{1, \dots, n\}$ be such that $v_j \in N_G(u) - C = N_G(v_i) - C$. Since C is a minimum vertex cover of G , such a vertex v_j must exist. From the construction of G' , the vertex $u = v_i$ is the unique vertex in D that r -dominates x_{ij}^r . Thus, in order to keep x_{ij}^r being r -dominated in G' , a token on u can only be moved to some vertex in $\bigcup_{\{j|v_j \in N_G(v_i)-C\}} V(P_{ij})$. ◀

Intuitively, starting from a token-set of the form $C + x$ for some minimum vertex cover C of G , Claim 31(a) means that as long as x has a token, no other token can be moved in G' to a vertex in $P_x - x$, Claim 31(b) implies that if x has a token, it will never be moved in G' , and Claim 31(c) says that a token cannot be moved in G' “too far” from its original position.

We are now ready to show the correctness of our reduction. (Claims 32 and 33.)

► **Claim 32.** *Under TS, (G, C_s, C_t) is a yes-instance if and only if (G', D_s, D_t) is a yes-instance.*

Proof(\Rightarrow) Suppose that \mathcal{S} is a TS-sequence in G between C_s and C_t . We construct a sequence \mathcal{S}' of token-slides in G' between D_s and D_t by replacing each $v_i \xrightarrow{G} v_j$ in \mathcal{S} with the sequence $\mathcal{S}_{ij} = \langle v_i \xrightarrow{G'} x_{ij}^1, x_{ij}^1 \xrightarrow{G'} x_{ij}^2, \dots, x_{ij}^{2r-1} \xrightarrow{G'} x_{ij}^{2r} \rangle$, where $i, j \in \{1, \dots, n\}$ and $v_i v_j \in E(G)$. Intuitively, sliding a token t_{ij} from v_i to its neighbor v_j in G corresponds to sliding t_{ij} from v_i to v_j in G' along the path P_{ij} . Since x always r -dominates $V(G') - \bigcup_{v_i v_j \in E(G)} \{x_{ij}^r\}$ and after each move in \mathcal{S}_{ij} the token t_{ij} always r -dominates x_{ij}^r , it follows that \mathcal{S}_{ij} is indeed a TS-sequence in G' . Thus, \mathcal{S}' is our desired TS-sequence.

(\Leftarrow) Let \mathcal{S}' be a TS-sequence in G' between D_s and D_t . We describe how to construct a TS-sequence \mathcal{S} in G between C_s and C_t . Initially, $\mathcal{S} = \emptyset$. For each move $u \xrightarrow{G'} v$ ($u \neq v$) in \mathcal{S}' , we consider the following cases:

- **Case 1: Either $u \in V(P_x)$ or $v \in V(P_x)$.** Since \mathcal{S}' starts with $D_s = C_s + x$, Claim 31 ensures that no token can be placed on some vertex in $P_x - x$ and x always contains a token. As a result, this case does not happen.
- **Case 2: $u = x_{ij}^p$ and $v = x_{ij}^{p+1}$ for $0 \leq p < 2r$.** Recall that in G' , we have $x_{ij}^0 = v_i$ and $x_{ij}^{2r} = v_j$. Additionally, from our construction, since $x_{ij}^p \in V(G')$ has a token, so does $v_i \in V(G)$. If $p = 2r - 1$, we append the move $v_i \xrightarrow{G} v_j$ to \mathcal{S} . Otherwise, we do nothing.

To see that \mathcal{S} is indeed a TS-sequence in G , it suffices to show that if C is the minimum vertex cover obtained right before the move $v_i \xrightarrow{G} v_j$ then $C' = C - v_i + v_j$ is also a minimum vertex cover of G . Suppose to the contrary that C' is not a vertex cover of G . It follows that there exists $k \in \{1, \dots, n\}$ such that $v_i v_k \in E(G)$, $v_k \neq v_j$, and $v_k \notin C$. Intuitively, the edge $v_i v_k$ is not covered by any vertex in C' . On the other hand, let D be the DrDS of G' obtained right before the move $x_{ij}^{2r-1} \xrightarrow{G'} x_{ij}^{2r} = v_j$. Since $D' = D - x_{ij}^{2r-1} + x_{ij}^{2r}$ is also a DrDS of G' , there must be some vertex in D' that r -dominates x_{ik}^r , which implies $V(P_{ik}) \cap D' \neq \emptyset$. However, from the construction of \mathcal{S} , it follows that $v_k \in C$, which is a contradiction. Thus, C' is a vertex cover of G . Since $|C'| = |C|$, it is also minimum.



► **Claim 33.** *Under TJ, (G, C_s, C_t) is a yes-instance if and only if (G', D_s, D_t) is a yes-instance.*

Proof(⇒) Suppose that \mathcal{S} is a TJ-sequence in G between C_s and C_t . It follows from Claim 30 that the sequence \mathcal{S}' of token-jumps obtained from \mathcal{S} by replacing each move $u \xrightarrow{G} v$ in \mathcal{S} by $u \xrightarrow{G'} v$ is a TJ-sequence between $D_s = C_s + x$ and $D_t = C_t + x$.

(⇐) On the other hand, let \mathcal{S}' be a TJ-sequence in G' between D_s and D_t . We describe how to construct a TJ-sequence \mathcal{S} in G between C_s and C_t . Initially, $\mathcal{S} = \emptyset$. For each move $u \xrightarrow{G'} v$ ($u \neq v$) in \mathcal{S}' , we consider the following cases:

- **Case 1:** **Either** $u \in V(P_x)$ **or** $v \in V(P_x)$. As before, it follows from Claim 31 that this case does not happen.
- **Case 2:** $u = x_{ij}^p$ **and** $v = x_{ij}^q$ **for** $0 \leq p, q \leq 2r$. Recall that in G' we have $x_{ij}^0 = v_i$ and $x_{ij}^{2r} = v_j$. If $q = 2r$, we append the move $v_i \xrightarrow{G} v_j$ to \mathcal{S} . Otherwise, we do nothing.
- **Case 3:** $u = x_{ij}^p$ **and** $v = x_{kl}^q$ **for two edges** $v_i v_j$ **and** $v_k v_\ell$ **in** G **and** $0 \leq p, q \leq 2r$. Note that if (\star) $v_i v_j$ and $v_k v_\ell$ are adjacent edges in G and either u or v is their common endpoint, we are back to **Case 2**. Thus, let's assume (\star) does not happen and consider the *first* move of this type. From Claim 31, it must happen that before the move $x_{ij}^p \xrightarrow{G'} x_{kl}^q$, some move in \mathcal{S}' places a token on $u = x_{ij}^p$ and moreover such a token must come from either v_i or v_j . Additionally, again by Claim 31, if the token comes from v_i then v_j contains no other token, and vice versa. Let D be the DrDS obtained right before the move $x_{ij}^p \xrightarrow{G'} x_{kl}^q$. Now, since $x_{ij}^p \xrightarrow{G'} x_{kl}^q$ is the first move of its type, it follows that the path P_{ij} contains exactly one token from D which is placed on x_{ij}^p . However, this means we cannot perform $x_{ij}^p \xrightarrow{G'} x_{kl}^q$; otherwise x_{ij}^p would not be r -dominated by the resulting token-set. Thus, this case does not happen unless (\star) is satisfied.

To see that \mathcal{S} is indeed a TJ-sequence in G , it suffices to show that if C is the minimum vertex cover obtained right before the move $v_i \xrightarrow{G} v_j$ then $C' = C - v_i + v_j$ is also a minimum vertex cover of G . Suppose to the contrary that C' is not a vertex cover of G . It follows that there exists $k \in \{1, \dots, n\}$ such that $v_i v_k \in E(G)$, $v_k \neq v_j$, and $v_k \notin C'$. Intuitively, the edge $v_i v_k \in E(G)$ is not covered by any vertex in C' . On the other hand, let D be the DrDS of G' obtained right before the move $x_{ij}^p \xrightarrow{G'} x_{ij}^{2r} = v_j$. Since $D' = D - x_{ij}^p + x_{ij}^{2r}$ is also a DrDS of G' , there must be some vertex in D' that r -dominates x_{ik}^r , which implies $V(P_{ik}) \cap D' \neq \emptyset$. However, from the construction of \mathcal{S} , it follows that $v_k \in C$, which is a contradiction. Thus, C' is a vertex cover of G . Since $|C'| = |C|$, it is also minimum.



Our proof is complete. ◀



References for the Appendix

- AACK22** A. Karim Abu-Affash, Paz Carmi, and Adi Krasin. A linear-time algorithm for minimum k -hop dominating set of a cactus graph. *Discrete Applied Mathematics*, 320:488–499, 2022.
- BDO21** Marthe Bonamy, Paul Dorbec, and Paul Ouvrard. Dominating sets reconfiguration under token sliding. *Discrete Applied Mathematics*, 301:6–18, 2021.



- BKW14** Paul S. Bonsma, Marcin Kamiński, and Marcin Wrochna. Reconfiguring Independent Sets in Claw-Free Graphs. In *Proceedings of SWAT 2014*, volume 8503 of *LNCS*, pages 86–97. Springer, 2014.
- GJ79** Michael R. Garey and David S. Johnson. *Computers and intractability: A guide to the theory of NP-completeness*. WH Freeman and Company, 1979.
- HD05** Robert A. Hearn and Erik D. Demaine. PSPACE-completeness of sliding-block puzzles and other problems through the nondeterministic constraint logic model of computation. *Theoretical Computer Science*, 343(1-2):72–96, 2005.
- HIM⁺16** Arash Haddadan, Takehiro Ito, Amer E. Mouawad, Naomi Nishimura, Hirotaka Ono, Akira Suzuki, and Youcef Tebbal. The complexity of dominating set reconfiguration. *Theoretical Computer Science*, 651:37–49, 2016.
- Hoa23** Duc A. Hoang. On the complexity of distance- d independent set reconfiguration. In Bertrand M. T. Lin, Chun-Cheng Lin, and Giuseppe Liotta, editors, *Proceedings of WALCOM 2023*, volume 13973 of *LNCS*, pages 254–266, 2023.
- IDH⁺11** Takehiro Ito, Erik D. Demaine, Nicholas J. A. Harvey, Christos H. Papadimitriou, Martha Sideri, Ryuhei Uehara, and Yushi Uno. On the complexity of reconfiguration problems. *Theoretical Computer Science*, 412(12-14):1054–1065, 2011.
- KM16** Sukhamay Kundu and Subhashis Majumder. A linear time algorithm for optimal k -hop dominating set of a tree. *Information Processing Letters*, 116(2):197–202, 2016.
- KMM12** Marcin Kamiński, Paul Medvedev, and Martin Milanič. Complexity of independent set reconfigurability problems. *Theoretical Computer Science*, 439:9–15, 2012.
- van15** Tom C. van der Zanden. Parameterized complexity of graph constraint logic. In *Proceedings of IPEC 2015*, volume 43 of *LIPICs*, pages 282–293. Schloss Dagstuhl – Leibniz-Zentrum für Informatik, 2015.