

Algebraic characterisation of the category of cobordisms of 2-dimensional CW-complexes and the Andrews-Curtis conjecture

I. BOBTCHEVA
i.bobtcheva@gmail.com

Abstract

We prove that S^1 is a unimodular, cocommutative Hopf algebra in the category CW^{1+1} of 2-equivalence classes of cobordisms of 2-dimensional CW-complexes and that CW^{1+1} is actually equivalent to the symmetric monoidal category freely generated by such Hopf algebra. Moreover, we show that the algebraic structure the category Chb^{3+1} of cobordisms of orientable relative 4-dimensional 2-handlebody cobordisms up to 2-deformations described in [3], is a refinement of the algebraic structure of their spines.

Keywords: CW-complexes, Hopf algebra, TQFT, Andrews-Curtis conjecture.

AMS Classification: 57M20, 57T05, 20F05, 57Q10, 16T05, 57R56

Introduction

In [3] a complete description is given of the algebraic structure of the category Chb^{3+1} of relative 4-dimensional 2-handlebody cobordisms up to 2-deformations. In particular, it is proven that there is an equivalence functor $\Phi : \mathcal{H}^r \rightarrow Chb^{3+1}$ from the category \mathcal{H}^r , freely generated by a unimodular¹ ribbon Hopf algebra to Chb^{3+1} . In the present work it will be shown that the algebraic structure of such cobordisms is actually a refinement of the algebraic structure of their spines, i.e. of the category CW^{1+1} of cobordisms of relative 2-dimensional CW-complexes modulo 2-equivalence. This last category was first defined in [14] and the corresponding (1+1)-TQFT's were studied in [2, 4, 12].

We prove here that S^1 is a unimodular, cocommutative Hopf algebra in the category CW^{1+1} (Theorem 4.1) and that CW^{1+1} is actually equivalent to the symmetric monoidal category freely generated by such Hopf algebra (Theorem 4.4).

The structure of the paper is the following. In Section 1 we introduce the category CW^{1+1} as the connected part of the category of cobordisms of 2-dimensional CW-complexes in [14]. In Section 1.5 we use standard complexes to show that CW^{1+1} is equivalent to the category \mathcal{P} of relative presentations modulo AC-moves. Here the term *relative presentations* is used in restricted sense; it refers to presentations whose generators are divided in *external* and *internal* ones. The external ones, are the generators of the fundamental group of the source and of the target of the cobordism, while the rest of the generators are internal. From the point of view of the moves, an external generator can not be cancelled. Then in Section 3 we define a unimodular, cocommutative Hopf algebra H in a symmetric monoidal category \mathcal{C} and introduce the category \mathcal{H}^c , freely generated

¹In [3] and in the following, we consider a categorical cocommutative Hopf algebra unimodular if it has a two-sided integral and a 2-sided cointegral.

by such algebra. Section 4 is dedicated to the proofs of Theorems 4.1 and 4.4. Finally, in Section 5 we show that \mathcal{H}^c is equivalent to a quotient of the universal ribbon category \mathcal{H}^r defined in [3].

Acknowledgments The idea about the possible relationship between the quantum invariants of 3-dimensional cobordisms, 4-dimensional 2-handlebodies and 2-dimensional CW-complexes is due to Frank Quinn who started this line of research and whose insights and support have remained the main driving force behind it. The author would also like to thank Riccardo Piergallini for reading and correcting a preliminary version of this preprint.

Notation Given a category \mathcal{C} , we denote by $\text{Obj } \mathcal{C}$ the set of its objects and by $\text{Mor } \mathcal{C}$ the set of morphisms of \mathcal{C} , always assuming that \mathcal{C} is a small category. Moreover, for any $C, C' \in \text{Obj } \mathcal{C}$, the set of morphisms of \mathcal{C} with source C and target C' are denoted by $\text{Mor}_{\mathcal{C}}(C, C')$.

1 Preliminaries on 2-dimensional CW-complexes

We remind some basic definitions and facts about CW-complexes. The reader can find all details and a complete reference list in [6].

1.1 Definition

An n -dimensional CW complex is a space $X = X^n$ constructed inductively in the following way:

- (1) X^0 is a discrete space, each point being a 0-cell.
- (2) X^k is obtained by attaching to X^{k-1} a disjoint family D_i^k of closed k -disks via continuous functions $\phi_i : \partial D_i^k \rightarrow X^{k-1}$. In particular, X^k is the quotient space of $X^{k-1} \sqcup_i D_i^k$ under the identification $x \sim \phi_i(x)$ for $x \in \partial D_i^k$. The homeomorphic image of the interior of D_i^k under the restriction of the quotient map $\Phi_i : D_i^k \rightarrow X^k$ is the k -cell e_i^k . Then ϕ_i and Φ_i are called respectively the *attaching map* and the *characteristic map* of e_i^k .

On the space X is assigned the weak topology, i.e. a subset is closed if its intersection with the closure of each cell is closed.

We consider CW-complexes up to *cellular isomorphism*, i.e. up to homeomorphism which maps open cells to open cells. This means that the attaching and the characteristic maps are not unique, but two attaching (resp. characteristic) maps of a given cell are homotopic up to composition with an orientation reversing homeomorphism of ∂D (resp D) to itself.

A CW-complex is *finite* if it consists of finitely many cells. From now on, unless explicitly mentioned otherwise, we will work only with finite CW-complexes.

1.2 n -deformation and simple homotopy

A *subcomplex* of a CW-complex X is a closed subspace $Y \subset X$ that is a union of cells of X . For any $0 \leq k \leq n$, the subspace X^k is a subcomplex of X , called the k -skeleton of X . A pair (X, Y) consisting of a n -dimensional CW-complex X and a subcomplex Y will be called a n -dimensional *CW-pair*. A CW-pair will be called *connected* if both X and Y are connected.

Definition 1.1. A subcomplex Y is obtained from X by an *elementary collapse* of dimension k , or equivalently X is obtained from Y by an *elementary expansion*, if there exist a pair (e^k, e^{k-1}) of cells of X with characteristic maps $\Phi^k : D^k \rightarrow X$ and $\Phi^{k-1} : D^{k-1} \rightarrow X$ and an embedding $\iota : D^{k-1} \rightarrow \partial D^k$, such that

- (i) $X = Y \sqcup e^k \sqcup e^{k-1}$ and
- (ii) $\Phi^{k-1} = \Phi^k \circ \iota$ while $\Phi^k(\partial D^k - \iota \circ D^{k-1}) \subset Y$.

Here e^{k-1} is called a *free face* of e^k and of X . A sequence of elementary collapses (resp. expansions) is called a *collapse* (resp. *an expansion*) and denoted by $Y \nearrow X$ (resp. $X \searrow Y$), while a sequence where both expansion and collapses are allowed is called a *deformation* and denoted by $X \frown Y$.

Definition 1.2. We say that two CW-pairs (X, Y) and (X', Y) are *simple-homotopy equivalent* if there is a map $X \rightarrow X'$ which is homotopic to a deformation and induces the identity on the common subcomplex Y . Two CW-complexes X and X' are simple-homotopy equivalent if the CW-pairs (X, \emptyset) and (X', \emptyset) are simple-homotopy equivalent.

Definition 1.3. We say that two n -dimensional CW-pairs (X, Y) and (X', Y) are *n -equivalent* if one can be deformed to the other by homotopies of attaching maps of the cells and expansions and collapses of dimension at most n , which restrict to the identity on the common subcomplex Y . A sequence of such moves is called an *n -deformation*.

Two n -dimensional CW-complexes X and X' are *n -equivalent* if the CW-pairs (X, \emptyset) and (X', \emptyset) are n -equivalent.

In the definition above we had followed the terminology in [17, 13, 14], which is motivated by the observation that two n -dimensional CW-complexes are n -equivalent if one can be deformed to the other through n -dimensional complexes. Such terminology is not universally accepted. Indeed, due to the proposition below, what we call here n -deformation is called a $(n + 1)$ -deformation in [6] and [19].

Proposition 1.4 (Lemma 2.5-I in [6]). *Two n -dimensional CW-pairs (X, Y) and (X', Y) are n -equivalent if and only if there is a map $X \rightarrow X'$ which is homotopic to a to a sequence of expansions and collapses of dimension at most $n + 1$ and induces the identity on the common subcomplex Y .*

By results of Wall [17, 18] for any $n \neq 2$ simple homotopy equivalence of n -dimensional CW-pairs implies n -equivalence. The question if an analogous statement holds for $n = 2$ is still open. The following is known as the *generalized Andrews-Curtis conjecture* (see Section 4.1 in Chapter I of [6]).

Conjecture 1.5. Any two simple-homotopy equivalent 2-dimensional CW-pairs are 2-equivalent.

The original Andrews-Curtis conjecture (AC-conjecture) was formulated in 1965 in [1] and states that if two simply connected 2-dimensional CW-complexes are simple-homotopy equivalent then they are 2-equivalent. It is believed that the conjecture is false. On the other hand, Wall's result [17] implies that if X_1 and X_2 are simple-homotopy equivalent 2-dimensional CW-complexes, there exists $k \geq 0$ such that the 1-point unions of the two complexes with k copies of the 2-sphere, $X_1 \vee kS^2$ and $X_2 \vee kS^2$, are 2-equivalent. This makes it quite difficult to construct sensible invariants which can detect possible counterexamples to the AC-conjecture.

1.3 Elementary 2-deformation moves

We describe below three particular 2-deformation moves. As it will be shown in Proposition 1.7, any 2-deformation between two standard 2-dimensional CW complexes is a composition of those moves.

The moves are illustrated in Figure 1, where only the 0-, 1- and 2-cells involved are evinced, while the rest of the CW-complex is shown in dark gray. The reader should keep in mind that some of the drawn 0- and 1-cells may coincide with each other.

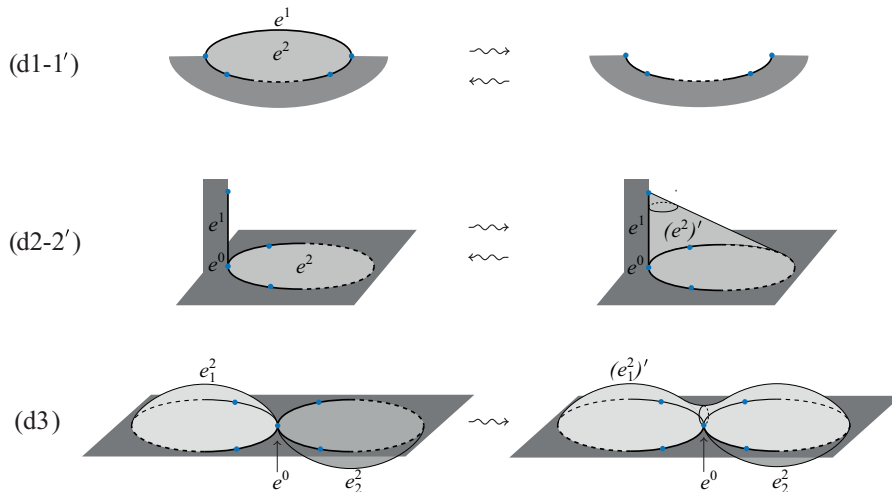


Figure 1: Elementary 2-deformation moves

(d1-1') Expanding/collapsing a pair (e^2, e^1)

(d2-2') Pushing a 2-cell e^2 along/off the 1-cell e^1

Suppose that a CW-complex X has an 1-cell e^1 and a 2-cell e^2 , whose attaching maps send $P_1 \in \partial D^1$ and $P_2 \in \partial D^2$ to the same 0-cell e^0 . Consider the disk D' with radius 1 and center O presented in Figure 2 (a). Let $E \subset D'$ be the union of darker disk of radius 1/2 and center O and OB . We identify E with $D^2 \vee_{P_1=P_2} D^1$ and consider a map $\tilde{\phi} : E \rightarrow X$, whose restriction to D^2 (resp. D^1) coincides with the characteristic map of e^2 (resp. e^1). Let $r : D' \rightarrow E$ be the retraction which maps each point of D' to E as shown in Figure 2 (a), and let $f_t : D' \rightarrow D'$ be the homotopy which maps any point $x \in D'$ to the point $f_t(x)$ dividing the segment from A to x in ratio $1 : (1 - t)$. Then $\tilde{\phi} \circ r \circ f_t|_{S^1}$ changes the attaching map of e^2 by homotopy and the CW-complex for $t = 1$ is the result of pushing e^2 along e^1 . We also consider the inverse of such a move, to which we will refer as *pushing e^2 off the e^1* , and which is defined when the attaching map of e^2 maps two consecutive arcs in ∂D^2 onto the same 1-cell e^1 . Observe that the result of pushing e^2 along e^1 depends not only on the 1- and 2-cells in question, but also on the choice of particular preimages of e^0 under the attaching maps of such cells.

(d3) Sliding a 2-cell e_1^2 over another 2-cell e_2^2

Suppose that a CW-complex X has 2-cells e_1^2 and e_2^2 , whose closures contain a common 0-cell e^0 and let P_1 (resp. P_2) be a preimage of e^0 under the attaching map of e_1^2 (resp. e_2^2). Then the definition of the sliding of e_1^2 over e_2^2 follows the steps in (2-2'), where the segment OB is replaced by the disk of radius 1/2 of diameter OB in Figure 2 (b), $E \subset D'$ is taken to be the union of the two darker disks in the same figure and it is identified with

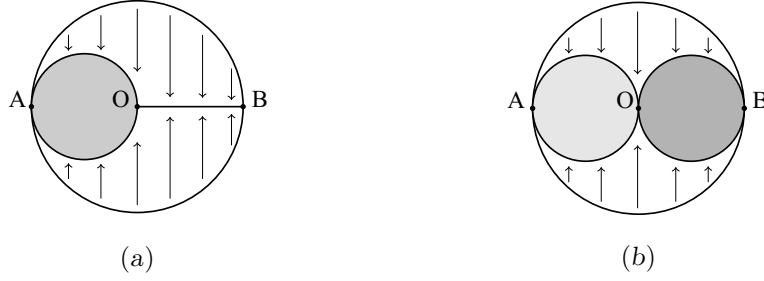


Figure 2

$D^2 \vee_{P_1=P_2} D^2$, while the map $\tilde{\phi} : E \rightarrow X$ is defined by requiring that its restriction to the first (resp. second) copy of D^2 coincides with the characteristic map of e_1^2 (resp. e_2^2). Observe that here also the final result of the move depends on the choice of preimages of e^0 . Moreover, one can obtain the inverse move by sliding the resulting 2-cell once more over e_2^2 and then pushing it off the 1-cells in the border of e_2^2 . We will discuss this later in more details in the case of standard complexes.

(d4) Sliding a 1-cell e_1^1 over another 1-cell e_2^1 .

As it is shown in Figure 3, this move is actually a composition of the moves (d1), (d2') and (d3). In order to slide e_1^1 over e_2^1 we first expand a pair of 2- and 1-cells (e^2, e^1) , where $\partial \text{Cle}^2 = \text{Cl}(e^1 \cup e_1^1 \cup e_2^1)$. Then we use move (d3) to slide over e^2 all 2-cells e_j^2 , attached to e_1^1 , and through move (d2) we to push them out of e_1^1 making it free. Finally, we collapse the pair (e^2, e_1^1) .

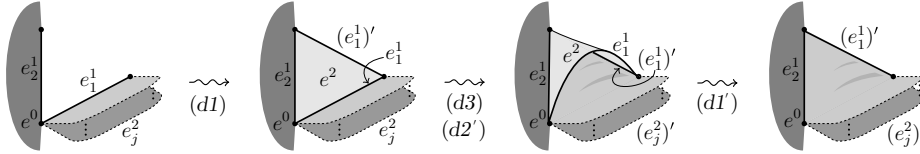


Figure 3: Definition of the 2-deformation move (d4)

1.4 Standard complexes

Definition 1.6. A 2-dimensional CW-pair (X, Y) will be called *standard* if it satisfies the following properties:

- (i) $Y^0 = X^0$ consists of a single 0-cell (vertex); then X^1 is the union of X^0 and a (finite) collection e_i^1 of 1-cells whose boundaries are attached to it;
- (ii) X^2 is obtained by attaching to X^1 a (finite) collection of 2-cells e_j^2 , where each ∂e_j^2 is subdivided into edges and vertices; each vertex of ∂e_j^2 is sent by the corresponding attaching map to X^0 and each open edge of ∂e_j^2 is sent either to X^0 or homeomorphically to some open e_i^1 .

If $Y = X^0$, we will refer to the corresponding standard CW-pair (X, X^0) simply as the *standard 2-dimensional CW-complex* X .

Given two standard CW-pairs (X, Y) and (X', Y') , we define their 1-point union $(X \vee X', Y \vee Y')$ to be the standard CW-pair obtained by indentifying X^0 and X'^0 in the disjoint

union $(X, Y) \sqcup (X', Y')$. Observe that this operation defines a monoidal structure on the set of standard CW-pairs whose identity is given by the trivial complex consisting of a single 0-cell.

Remark. To any standard 2-dimensional CW complex X can be associated (in a non unique way) presentation of its fundamental group in terms of generators and relations. In order to do this, we need to make a choice of an orientation of each 1-cell and a choice of a base point and an orientation of ∂D^2 for each 2-cell in such a way that the attaching map $\phi : \partial D^2 \rightarrow X^1$ of the 2-cell maps the its base point to e^0 . Then the desired presentation has one generator for each 1-cell and one relation for each 2-cell, obtained by reading off the word corresponding to $\phi(\partial D)$. Clearly, different choices of orientations or of base points change the presentation by sostitutions of generators or relations by their inverses and by cyclicly permuting the letters of the relations. Analogously, to any standard CW-pair (X, Y) we can associate a presentation of the fundamental group X , in which the generators corresponding to Y have been marked.

Observe that the set of standard complexes is invariant under the moves $(d1-1')$, $(d2-2')$ and $(d3)$. Moreover, the following proposition (see Lemma 4 in [19] and Theorem 2.4 in Chapter I of [6]), implies that in the study of the CW-pairs we can limit ourselves to the study of standard pairs modulo such moves.

Proposition 1.7. *Any connected CW-pair (X, Y) in which Y is standard, is 2-equivalent to a standard one. Moreover, if two standard CW-pairs are 2-equivalent, then there is a 2-deformation between them which is a composition of the moves $(d1-1')$, $(d2-2')$ and $(d3)$.*

1.5 The category CW^{1+1} of cobordisms of 2-dimensional CW-complexes

We can now define the main object of study of the present work: the category of cobordisms of 2-dimensional CW-complexes. For first time similar category was introduced and studied in [14] as a domain category of modular TQFT. In [14] the objects of the category are 1-dimensional CW-complexes and the morphisms 2-equivalence classes of 2-dimensional CW-complexes. Using Proposition 1.7, one can easily see that its subcategory generated by connected objects and morphisms is equivalent to the one generated by standard complexes modulo the moves $(d1-1')$, $(d2-2')$ and $(d3)$. Therefore, without loss of generality we will work with such subcategory, indicating it by CW^{1+1} .

Objects The objects of CW^{1+1} are *standard* 1-dimensional complexes equipped with an orientation and enumeration² of their 1-cells, considered up to homeomorphism which preserves the extra structure. We will use the notation \bar{Y}_n to indicate the object of CW^{1+1} whose underlying CW-complex Y_n has n 1-cells.

Morphisms A morphism $(X, \bar{Y}_{n_1}, \bar{Y}_{n_2}) : \bar{Y}_{n_1} \rightarrow \bar{Y}_{n_2}$ in CW^{1+1} is a 2-equivalence class of standard 2-dimensional CW-pairs $(X, Y_{n_1} \vee Y_{n_2})$ in which Y_{n_1} and Y_{n_2} are equipped with orientation and enumeration of their 1-cells. The composition of two morphisms $(X, \bar{Y}_{n_1}, \bar{Y}_{n_2})$ and $(X', \bar{Y}_{n_2}, \bar{Y}_{n_3})$ is given by $(X \sqcup_{Y_{n_2}} X', \bar{Y}_{n_1}, \bar{Y}_{n_3})$, where $X \sqcup_{Y_{n_2}} X'$ is the glueing of X and X' along Y_{n_2} by a homomorphism which respects the enumeration and the orientation of the 1-cells.

Pictorial representation. It will be useful, even if not strictly necessary, to have a pictorial representation of the morphisms of CW^{1+1} . Unfortunately, it is very difficult to

²A finite enumerated set is a set A together with a bijective function $\{1, 2, \dots, n\} \rightarrow A$.

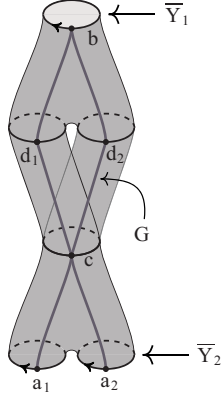


Figure 4: A morphism $(X, \bar{Y}_2, \bar{Y}_1)$ in CW^{1+1}

draw a CW-complex build on a 1-point union of circles, so we will stretch it and instead of the cobordism $(X, \bar{Y}_{n_1}, \bar{Y}_{n_2})$, we will draw a CW-pair $(\tilde{X}, \tilde{Y}_{n_1} \cup G \cup \tilde{Y}_{n_2})$, where

- $\tilde{Y}_{n_i} \subset R^2 \times \{i\}$, $i = 1, 2$, is a disjoint union of n_i oriented based circles;
- $G \subset \tilde{X}$ is a possibly not connected graph which intersects $R^2 \times \{\{1\}, \{2\}\}$ in the base points of the components of $\tilde{Y}_{n_1} \sqcup \tilde{Y}_{n_2}$;
- $(\tilde{X}, \tilde{Y}_{n_1} \cup G \cup \tilde{Y}_{n_2})/G$ is isomorphic to $(X, \bar{Y}_{n_1}, \bar{Y}_{n_2})$ and the image of G under the quotient map is the unique vertex of X , while the images of \tilde{Y}_{n_1} and \tilde{Y}_{n_2} are exactly \bar{Y}_{n_1} and \bar{Y}_{n_2} .

In the pictures G will be drawn as a tick dark gray *unoriented* graph, while the 1-cells of X will be drawn as black thick curves, which will be oriented if they belong to \tilde{Y}_{n_1} and \tilde{Y}_{n_2} . An example of a morphism $(X, \bar{Y}_2, \bar{Y}_1)$ in CW^{1+1} is presented in Figure 4. The letters a_1, a_2, b , ecc. indicate the corresponding generators of the fundamental group of X and will be used later.

Identity morphism. $\text{id}_{\bar{Y}_n}$ is obtained by attaching n 2-cells on $\bar{Y}_n \vee \bar{Y}_n$ as follows: we orient the boundary of D^2 and identify it with the union of the two intervals lying into the upper and lower half planes, $\partial D^2 = I_1 \cup I_2$; then the attaching map of the i -th 2-cell of $\text{id}_{\bar{Y}_n}$ sends I_1 (resp. I_2) to the i -th 1-cell of the source (resp. the target) by an orientation preserving (resp. reversing) homeomorphism ($\text{id}_{\bar{Y}_1}$ is presented in Figure 5). The proof that $\text{id}_{\bar{Y}_{n_1}} \circ (X, \bar{Y}_{n_1}, \bar{Y}_{n_2}) = (X, \bar{Y}_{n_1}, \bar{Y}_{n_2})$ is illustrated in the same figure, where $e_{i,1}^1$ (resp. $e_{i,2}^1$) is the i -th 1-cell in the source (resp. target) of $\text{id}_{\bar{Y}_{n_1}}$, while e_i^2 is its i -th 2-cell: we homotope in $\text{id}_{\bar{Y}_{n_1}}$ the attaching map of any 2-cell e^2 of X , which contains $e_{i,2}^1$ in its closure, until the image of such map is entirely contained in $e_{i,1}^1$; eventually we collapse the pair $(e_i^2, e_{i,2}^1)$. The resulting cobordism is clearly 2-equivalent to $(X, \bar{Y}_{n_1}, \bar{Y}_{n_2})$.

2 Group presentations and 2-dimensional CW-complexes

2.1 Relative group presentations

To any standard 2-dimensional CW-complex, one can associate a presentation of its fundamental group. In order to extend such correspondence to standard CW-pairs, we will need the concept of a relative group presentation. In general, a relative group presentation

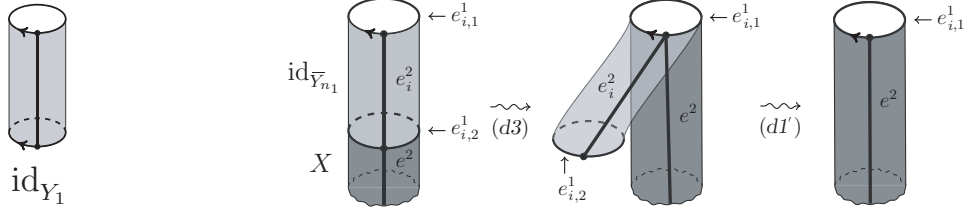


Figure 5: The identity morphism.

is an expression of the form $P = \langle G; X \mid R \rangle$, where G is a group, X is a set of generators disjoint from G and R is a set of words in $G \star \langle X \rangle$. Nevertheless, in the present work we will use it in a more restricted sense when G itself is a group freely generated by a given set.

Definition 2.1. Given a set A and $n \in \mathbf{N}$, we will call a *word* of length n in the set A any expression of the form $w = a_1^{\epsilon_1} a_2^{\epsilon_2} \dots a_n^{\epsilon_n}$, $a_i \in A$, $\epsilon_i = \pm 1$. The exponential notation a_i^m , $m \in \mathbf{Z} - \{0\}$ will be used as an abbreviation to indicate m consecutive equal terms.

The length of the word w will be indicated by $|w|$, while $|w|_{a_i}$ will indicate the number of appearances of a_i in w .

Observe that the concatenation defines a product on the set of words in A whose identity is the empty word.

Definition 2.2. We call *relative group presentation* an expression of the form $P = \langle A; B \mid R \rangle$ where A and B are finite sets and R is a finite set of words in $G = A \sqcup B$. A and B will be called correspondingly the *external* and the *internal generators* of P , while the elements of R are called the *relators* of P . Two relative presentations $P = \langle A; B \mid R \rangle$ and $P' = \langle A'; B' \mid R' \rangle$ will be considered *identical* if there exist bijective maps $F_A : A \rightarrow A'$, $F_B : B \rightarrow B'$ and $F_R : R \rightarrow R'$ such that for any word $w \in R$ of length n , $F_R(w)$ coincides with the image of w under the map $(A \sqcup B)^{\times n} \rightarrow (A' \sqcup B')^{\times n}$ induced by $F_A \sqcup F_B$. Moreover, two relative presentations will be called *AC-equivalent* if one of them can be obtained from the other by a finite sequence of the following moves, called *AC-moves*:

- (ac1) adding a new generator b to B and a new relator bw to R , where w is any word in G , or the inverse of such move;
- (ac2) substituting a relator $w \in R$ by $gg^{-1}w$ or by $g^{-1}gw$ for some $g \in G$, or the inverse of such a move;
- (ac3) replacing a relator by its left product with another relator;
- (ac4) cyclic permutation of a relator;
- (ac5) replacing a relator by its inverse;

We will use the notation $P \simeq P'$ to indicate that the presentations P and P' are AC-equivalent.

The following proposition is well known, but we sketch the proof for completeness.

Proposition 2.3. *Two relative presentations related by each of the following moves are AC-equivalent:*

- (ac2') insertion or cancellation in a relator of gg^{-1} or of $g^{-1}g$ for some $g \in G$;
- (ac3') replacing a relator by its right product with another relator;
- (ac6) replacing in all relators an internal generator $b \in B$ by its inverse b^{-1} ;
- (ac7) if R contains an word v of the form bw^{-1} , $w^{-1}b$, wb^{-1} or $b^{-1}w$ where $b \in B$ is an internal generator and w is a word in $G \setminus \{b\}$, replacing b by w in all relators except v , and then deleting b and v .

Proof. (ac2') is a generalization of (ac2) which is obtained by using (ac4) to cyclicly permute the relator in order to get in first place the letter in front of which we want to insert gg^{-1} , applying (ac2) and then cyclicly permuting back to the original order.

To achieve (ac3') we invert both relators, replace one by its left product with the other, and then invert back.

Move (ac6) follows from (ac7) after an insertion of a new generator c and a new relator cb , so it remains to prove (ac7).

Assume now that $R = \{w^{-1}b\} \cup R'$, where where $b \in B$ and w is a word in $G \setminus \{b\}$ (all other cases follow from this one by applying (ac4) and/or (ac5)). Then (ac7) follows by the following inductive argument on the total number of appearances of b and b^{-1} in the relators of R' . If b or b^{-1} don't appear in R' , the statement follows by (ac1). If instead b or b^{-1} appear in a relator $w' \in R'$, by inverting (if necessary) and applying cyclic permutations (moves (ac4) and (ac5)) we bring w' in the form $b^{-1}z$, then we multiply it on the left by $w^{-1}b$ and cancel bb^{-1} (moves (ac3) and (ac2')), replacing in this way r' by $w^{-1}z$. Eventually, we apply backwards cyclic permutations and inversions to obtain the original relator in which one of the b 's has been replaced by w . Therefore, the presentation is AC-equivalent to one in which b has one less appearances. \square

2.2 The category \mathcal{P} of relative group presentations

In what follows we will use the notation $\bar{A} = (a_1, a_2, \dots, a_n)$ to indicate the set $A = \{a_1, a_2, \dots, a_n\}$ whose elements have been totally ordered.

Objects The set of objects of the category of relative presentations \mathcal{P} is \mathbf{N} .

Morphisms A morphism $\langle \bar{A}_1, \bar{A}_2; B | R \rangle : n_1 \rightarrow n_2$ of the category of relative presentations \mathcal{P} , is given by the AC-equivalence classes of relative presentations $\langle A_1 \sqcup A_2; B | R \rangle$ in which A_i , $i = 1, 2$ is a set of cardinality n_i , together with a choice of total order on each A_i . Hopefully without causing a confusion, we will call *source* (resp. *target*) of the above morphism both n_1 and \bar{A}_1 (resp. n_2 and \bar{A}_2). Two morphisms $\langle \bar{A}_1, \bar{A}_2; B | R \rangle, \langle \bar{A}'_1, \bar{A}'_2; B' | R' \rangle : n_1 \rightarrow n_2$ are considered identical if the corresponding relative presentations can be identified through the bijective maps $F_{A_1} \sqcup F_{A_2} \sqcup F_B : \bar{A}_1 \sqcup \bar{A}_2 \sqcup B \rightarrow \bar{A}'_1 \sqcup \bar{A}'_2 \sqcup B'$, where F_{A_1} and F_{A_2} preserve the given orders.

Notation: In the explicit expression for a given morphism in \mathcal{P} we will present the ordered sets A_1 and A_2 as sequences of small letters delimited by curly brackets, while the unordered sets B and R won't be delimited, following the usual notation for a group presentation.

The composition of two morphisms is defined as:

$$\langle \bar{A}_1, \bar{A}_2; B | R \rangle \circ \langle \bar{A}_2, \bar{A}_3; B' | R' \rangle \simeq \langle \bar{A}_1, \bar{A}_3; A_2 \sqcup B \sqcup B' | R \sqcup R' \rangle,$$

where the target of the first morphism has been identified with the source of the second one through a bijective map which respects the sets' enumeration. Observe that the composition is well defined on equivalence classes since any AC-move on one of the factors induces the same move on the composition, and the associativity property is straightforward.

The identity morphism $n \rightarrow n$ is given by

$$\text{id}_n \simeq \langle (a_1, a_2, \dots, a_n), (b_1, b_2, \dots, b_n); \emptyset \mid a_1 b_1^{-1}, a_2 b_2^{-1}, \dots, a_n b_n^{-1} \rangle$$

Indeed, in order to see that the compositions $\text{id}_n \circ P$ and $P \circ \text{id}_n$ (when defined) are AC-equivalent to P , we apply move (ac7) to substitute each b_i by a_i , $i = 1, \dots, n$, in the relators of P , and then delete all the relators of id_n and the generators b_i , $1 \leq i \leq n$, from the resulting presentation.

Theorem 2.4. *There exists a category equivalence functor $\Pi : CW^{1+1} \rightarrow \mathcal{P}$.*

Proof. On the set of objects we define $\Pi(\bar{Y}_n) = n$, for any $n \in \mathbb{N}$. On the set of morphisms we define $\Pi(X, \bar{Y}_{n_1}, \bar{Y}_{n_2}) = \langle \bar{A}_1, \bar{A}_2; B \mid w_1, \dots, w_s \rangle$, where A_i , $i = 1, 2$, is the set of 1-cells of Y_{n_i} , B is the set of 1-cells of X which are not in $Y_{n_1} \vee Y_{n_2}$, and s is the number of 2-cells of X . In order to define the w_j 's we fix an orientation of the elements of B and for each 2-cell e_j^2 of X with attaching map $\phi_j : \partial D \rightarrow X^1$ we choose an orientation and a base point of $b_j \in \partial D$ such that $\phi_j(b_j) = X^0$. Then w_j , $j = 1, \dots, s$ is the word in $A_1 \sqcup A_2 \sqcup B$ describing the attaching map of the j -th 2-cell of X as an element in $\pi_1(X^1, X^0)$.

We have to show now that the AC-equivalence class of $\Pi(X, \bar{Y}_{n_1}, \bar{Y}_{n_2})$ doesn't depend on the choices made in the definition of the w_j 's. Indeed, changing the orientation of an element in B replaces the corresponding generator of $\langle \bar{A}_1, \bar{A}_2; B \mid w_1, \dots, w_s \rangle$ by its inverse (move (ac6)); changing the orientation of ∂D in some $\phi_j : \partial D \rightarrow X^1$ replaces w_j by its inverse (move (ac5)), while making a different choice of the base point of ∂D induces a cyclic permutation of w_j (move (ac4)).

Next we show that if $(X, \bar{Y}_{n_1} \vee \bar{Y}_{n_2})$ is changed by a 2-deformation, i.e. by some of the moves (d1-1'), (d2-2') or (d3), the AC-equivalence class of $\langle \bar{A}_1, \bar{A}_2; B \mid w_1, \dots, w_s \rangle$ remains the same. Indeed, (d1-1') adds or cancels a pair of a new generator and a new relation to the presentation as in move (ac1); (d2-2') inserts or cancels $g_i g_i^{-1}$ in a relator (move (ac2)) and (d3) replaces a relator by its product with (a cyclic permutation of) another one (moves (ac4) and (ac3)). It remains to observe that Π preserves the composition and the identity morphisms.

In order to show that Π is a category equivalence, we will construct a monoidal functor $\bar{\Pi} : \mathcal{P} \rightarrow CW^{1+1}$ and show that $\bar{\Pi} \circ \Pi = \text{id}_{CW^{1+1}}$ and $\Pi \circ \bar{\Pi} = \text{id}_{\mathcal{P}}$.

On the set of objects we define $\bar{\Pi}(n) = \bar{Y}_n$ for any $n \in \mathbb{N}$. Let $P = \langle \bar{A}_1, \bar{A}_2; B \mid R \rangle : n_1 \rightarrow n_2$ be a morphism in \mathcal{P} and let $m = |B|$ and $s = |R|$ denote the cardinalities of B and R . Then $\bar{\Pi}(P) = (X_P, \bar{Y}_{n_1}, \bar{Y}_{n_2})$ where X_P is the standard 2-dimensional CW-complex build as follows: the 1-skeleton of X_P is $Y_m \vee \bar{Y}_{n_1} \vee \bar{Y}_{n_2}$. Observe that the given enumeration defines a bijective map from A_i to the set of 1-cells of Y_{n_i} . Then we choose an orientation of all 1-cells of Y_m and a bijective map from B to the set of the 1-cells of Y_m . With these choices each word $w \in R$ defines a unique element $\pi(w) \in \pi_1(\bar{Y}_m \vee \bar{Y}_{n_1} \vee \bar{Y}_{n_2})$ and we complete the construction of X_P by attaching one 2-cell on each $\pi(w)$.

Observe that, given a morphism $P \in \text{Mor } \mathcal{P}$, different choices of orientation of the 1-cells of Y_m and of the bijective map from B to the set of the 1-cells of Y_m leave invariant the relative 2-dimensional CW-complex $\Pi(P)$ up to cellular isomorphism. The same is

true if we replace a relator of P by its cyclic permutation or by its inverse (moves (ac4) and (ac5)). The rest of the AC-moves, (ac1), (ac2) and (ac3), change $\Pi(P)$ by the 2-deformation moves (d1-1'), (d2-2') and (d3). Moreover, Π respects the composition and the identities.

Now the identities $\bar{\Pi} \circ \Pi = \text{id}_{CW^{1+1}}$ and $\Pi \circ \bar{\Pi} = \text{id}_{\mathcal{P}}$ are straightforward. \square

From now on we will work only with the category of relative presentations \mathcal{P} . Nevertheless, whenever it may be useful we will illustrate the morphisms in \mathcal{P} by drawing the corresponding relative 2-dimensional CW-complexes.

3 The universal unimodular cocommutative Hopf algebra \mathcal{H}^c

We start with some basic definitions and statements from the general theory of monoidal braided categories, which are used repeatedly in the paper. A complete reference on the subject is Mac Lanes's book [9].

Definition 3.1. A *strict monoidal braided category* $\mathcal{C} = (\mathcal{C}, \diamond, \mathbb{1}, \gamma)$ is a category \mathcal{C} together with an associative bifunctor $\diamond: \mathcal{C} \times \mathcal{C} \rightarrow \mathcal{C}$, called *product* on \mathcal{C} , an object $\mathbb{1}$ which is right and left unit for \diamond , and a natural isomorphism $\gamma_{A,B}: A \diamond B \rightarrow B \diamond A$, defined for any $A, B \in \text{Obj}(\mathcal{C})$, satisfying the following identities:

- (i) $\gamma_{\mathbb{1},A} = \text{id}_A = \gamma_{A,\mathbb{1}}$;
- (ii) $\gamma_{A,B \diamond C} = (\text{id}_B \diamond \gamma_{A,C}) \circ (\gamma_{A,B} \diamond \text{id}_C)$ and $\gamma_{A \diamond B,C} = (\gamma_{A,C} \diamond \text{id}_C) \circ (\text{id}_A \diamond \gamma_{B,C})$;
- (iii) $\gamma_{A,B}$ is natural in A and B , i.e. for any morphisms $f: A \rightarrow A'$ and $g: B \rightarrow B'$, $\gamma_{A',B} \circ (f \diamond \text{id}_B) = (\text{id}_B \diamond f) \circ \gamma_{A,B}$ and $\gamma_{A,B'} \circ (\text{id}_A \diamond g) = (g \diamond \text{id}_A) \circ \gamma_{A,B}$.

A strict braided monoidal category is called *symmetric* if for any $A, B \in \text{Obj}(\mathcal{C})$, $\gamma_{A,B} = \gamma_{A,B}^{-1}$.

Action of symmetric group. Let Σ_n be the symmetric group of degree n , i.e. the set of bijective functions from $\{1, 2, \dots, n\}$ to itself with group operation given by the composition. Then, given a set \mathcal{A} , there is a standard left action of Σ_n on $\mathcal{A}^{\times n}$ which sends the i -th element in the $\sigma(i)$ -th place:

$$\sigma(A_1, A_2, \dots, A_n) = (A_{\sigma^{-1}(1)}, A_{\sigma^{-1}(2)}, \dots, A_{\sigma^{-1}(n)}).$$

We will use this action in different contexts. The first one is when $\mathcal{A} = \text{Obj}(\mathcal{C})$ for some monoidal category (\mathcal{C}, \diamond) and $\mathcal{A}^{\times n}$ is identified with the set of \diamond -words $A_1 \diamond A_2 \diamond \dots \diamond A_n$ in \mathcal{A} . The second one is the action of Σ_n on the set of words of length n in some set G when $\mathcal{A} = G \times \{+1, -1\}$ (see Definition 2.1).

Definition 3.2. Given any $n \geq 1$ and any decomposition $n = n_1 + n_2 + \dots + n_k$, $\iota_{n_1, \dots, n_k}: \times_{i=1}^k \Sigma_{n_i} \hookrightarrow \Sigma_n$ is the injective group homomorphism which applies $\sigma_i \in \Sigma_{n_i}$ on the n_i -subtuple $(n_1 + \dots + n_{i-1} + 1, \dots, n_1 + \dots + n_{i-1} + n_i)$ of the n -tuple $(1, 2, \dots, n)$.

In what follows, whenever the context is clear, we will identify $\times_{i=1}^k \Sigma_{n_i}$ with the image of ι_{n_1, \dots, n_k} writing $\sigma_1 \times \sigma_2 \times \dots \times \sigma_k$ instead of $\iota_{n_1, \dots, n_k}(\sigma_1, \sigma_2, \dots, \sigma_k)$.

We are going now to state the coherence theorem of Mac Lane for symmetric categories, specified to the case of *strict* monoidal categories, which basically says that any morphism from $A_1 \diamond A_2 \diamond \cdots \diamond A_n$ to $\sigma(A_1 \diamond A_2 \diamond \cdots \diamond A_n)$, build up as composition of products of γ 's and identities, is uniquely determined by the permutation $\sigma \in \Sigma_n$.

Theorem 3.3 (Theorem 1, Chapter XI, [9]). *Let $(\mathcal{C}, \diamond, \mathbb{1}, \gamma)$ be a symmetric strict monoidal category and $A_1, \dots, A_n \in \text{Obj}(\mathcal{C})$. For any permutation $\sigma \in \Sigma_n$ there exists a unique morphism $\Upsilon_{A_1, \dots, A_n}^\sigma : A_1 \diamond A_2 \diamond \cdots \diamond A_n \rightarrow \sigma(A_1 \diamond A_2 \diamond \cdots \diamond A_n)$, natural in the A_i 's, such that*

- (i) $\Upsilon_{A_1, \dots, A_n}^{\text{id}} = \text{id}_{A_1 \diamond A_2 \diamond \cdots \diamond A_n}$;
 - (ii) $\Upsilon_{A_1, A_2}^{(1,2)} = \gamma_{A_1, A_2}$, where $(1, 2) \in \Sigma_2$ denotes the transposition;
 - (iii) $\Upsilon_{A_{\sigma^{-1}(1)}, \dots, A_{\sigma^{-1}(n)}}^{\sigma'} \circ \Upsilon_{A_1, \dots, A_n}^\sigma = \Upsilon_{A_1, \dots, A_n}^{\sigma' \circ \sigma}$;
 - (iv) $\Upsilon_{A_1, \dots, A_n}^\sigma \diamond \Upsilon_{A'_1, \dots, A'_m}^{\sigma'} = \Upsilon_{A_1, \dots, A_n, A'_1, \dots, A'_m}^{\sigma \times \sigma'}$ for ogni $\sigma \in \Sigma_n$, $\sigma' \in \Sigma_m$;
 - (v) $\Upsilon_{A_1, \dots, A_n}^\sigma$ is natural in the A_i 's, i.e. given any morphism $F : A_i \rightarrow B$,
- $$(\text{id}_{\sigma(i)-1} \diamond F \diamond \text{id}_{n-\sigma(i)}) \circ \Upsilon_{A_1, \dots, A_n}^\sigma = \Upsilon_{A_1, \dots, A_{i-1}, B, A_{i+1}, \dots, A_n}^\sigma \circ (\text{id}_{i-1} \diamond F \diamond \text{id}_{n-i})$$

$\Upsilon_{A_1, \dots, A_n}^\sigma$ is called **canonical morphism**.

Definition 3.4. A braided strict monoidal category $\mathcal{C} = (\mathcal{C}, \diamond, \mathbb{1}, \gamma)$ is called *autonomous* (or rigid) (see [16]) if for every $A \in \text{Obj} \mathcal{C}$ it is given a *right dual* object $A^* \in \text{Obj} \mathcal{C}$ and two morphisms

$$\begin{aligned} \Lambda_A : \mathbb{1} &\rightarrow A^* \diamond A && (\text{coform}), \\ \lambda_A : A \diamond A^* &\rightarrow \mathbb{1} && (\text{form}), \end{aligned}$$

such that the compositions

$$\begin{array}{ccccccc} A & \longrightarrow & A \diamond \mathbb{1} & \xrightarrow{\text{id} \diamond \Lambda_A} & A \diamond (A^* \diamond A) & \longrightarrow & (A \diamond A^*) \diamond A & \xrightarrow{\lambda_A \diamond \text{id}} & \mathbb{1} \diamond A & \longrightarrow & A, \\ A^* & \longrightarrow & \mathbb{1} \diamond A^* & \xrightarrow{\Lambda_A \diamond \text{id}} & (A^* \diamond A) \diamond A^* & \longrightarrow & A^* \diamond (A \diamond A^*) & \xrightarrow{\text{id} \diamond \lambda_A} & A^* \diamond \mathbb{1} & \longrightarrow & A^*, \end{array}$$

are the identities. Then, given any morphism $F : A \rightarrow B$ in \mathcal{C} , we define its *dual* $F^* : B^* \rightarrow A^*$ as follows:

$$F^* = (\text{id}_{A^*} \diamond \lambda_B) \circ (\text{id}_{A^*} \diamond F \diamond \text{id}_{B^*}) \circ (\Lambda_A \diamond \text{id}_{B^*}).$$

Definition 3.5. Given a strict braided monoidal category $(\mathcal{C}, \diamond, \mathbb{1}, \gamma)$, a *bialgebra* in \mathcal{C} is an objects H equipped with the following families of morphisms in \mathcal{C} (cf. Table 1):

a *comultiplication* $\Delta : H \rightarrow H \diamond H$, such that

$$(\Delta \diamond \text{id}_H) \circ \Delta = (\text{id}_H \diamond \Delta) \circ \Delta; \tag{a1}$$

a *counit* $\epsilon : H \rightarrow \mathbb{1}$, such that

$$(\epsilon \diamond \text{id}_H) \circ \Delta = \text{id}_H = (\text{id}_H \diamond \epsilon) \circ \Delta; \tag{a2-2'}$$

a *multiplication* $\mu : H \diamond H \rightarrow H$ such that

$$\mu \circ (\mu \diamond \text{id}_H) = \mu \circ (\text{id}_H \diamond \mu), \tag{a3}$$

$$(\mu \diamond \mu) \circ (\text{id}_H \diamond \gamma_{H,H} \diamond \text{id}_H) \circ (\Delta \diamond \Delta) = \Delta \circ \mu, \quad (\text{a5})$$

$$\epsilon \circ \mu = \epsilon \diamond \epsilon; \quad (\text{a6})$$

a *unit* $\eta : \mathbb{1} \rightarrow H$, such that

$$\mu \circ (\text{id}_H \diamond \eta) = \text{id}_H = \mu \circ (\eta \diamond \text{id}_H), \quad (\text{a4-4'})$$

$$\Delta \circ \eta = \eta \diamond \eta, \quad (\text{a7})$$

$$\epsilon \circ \eta = \text{id}_{\mathbb{1}}; \quad (\text{a8})$$

A bialgebra H in \mathcal{C} will be called

cocommutative if

$$\gamma_{H,H} \circ \Delta = \Delta, \quad (\text{a9})$$

*unimodular*³ if it is equipped with a *two-sided cointegral* $l : H \rightarrow \mathbb{1}$ and a *two-sided integral* $L : \mathbb{1} \rightarrow H$ such that

$$(\text{id}_H \diamond l) \circ \Delta = \eta \circ l = (I \diamond \text{id}_H) \circ \Delta, \quad (\text{i1-1'})$$

$$\mu \circ (L \diamond \text{id}_H) = L \circ \epsilon = \mu \circ (\text{id}_H \diamond L), \quad (\text{i2-2'})$$

$$l \circ L = \text{id}_H, \quad (\text{i3})$$

Hopf algebra if it is equipped with an invertible morphism $S : H \rightarrow H$, called the *antipode* of H , such that

$$\mu \circ (S \diamond \text{id}_H) \circ \Delta = \eta \circ \epsilon = \mu \circ (\text{id}_H \diamond S) \circ \Delta. \quad (\text{s1-1'})$$

Definition 3.6. The *universal unimodular cocommutative bialgebra* \mathcal{H}^c is the strict symmetric monoidal category freely generated by a unimodular cocommutative bialgebra H . In particular, if \mathcal{C} is any symmetric monoidal category with a unimodular cocommutative bialgebra $H_{\mathcal{C}}$ in it, then there exists a braided monoidal functor $\mathcal{H}^c \rightarrow \mathcal{C}$ sending H to $H_{\mathcal{C}}$

Diagrammatic language. The set of objects of \mathcal{H}^c is the free monoid generated by H , while the set of morphisms consists of all the compositions of products of identities and of the elementary morphisms $\gamma, \Delta, \epsilon, \mu, \eta, S, L, l$ modulo the defining axioms for a braided symmetric structure and the defining axioms listed in Definition 3.5. Analogously to [7, 3], \mathcal{H}^c can be described as a category of planar diagrams in $[0, 1] \times [0, 1]$, where the objects are sequences of points in $[0, 1]$ and the morphisms are iterated products and compositions of the elementary diagrams presented in Table 1, modulo the relations presented there and also plane isotopies which preserve the y -coordinate. We remind that the composition of

³In the literature the term *unimodular* is not uniquely defined. In [11] a Hopf algebra is called unimodular if it has a two-sided integral, while in [10] it is called unimodular if it has a two-sided cointegral. Our definition is stronger since it implies both and adds the normalization condition (i3).

diagrams $D_2 \circ D_1$ is obtained by stacking D_2 on the top of D_1 and then rescaling, while the product $D_1 \diamond D_2$ is given by the horizontal juxtaposition of D_1 and D_2 and rescaling.

Most of the proofs here will consist in showing that some morphisms in the universal algebra are equivalent, meaning that the graph diagram of one of them can be obtained from the graph diagram of the other by applying a sequence of the defining relations (moves) of the algebra axioms. We will outline the main steps in this procedure by drawing in sequence some intermediate diagrams, and for each step we will indicate in the corresponding order, the main moves needed to transform the diagram on the left into the one on the right. Notice, that the moves represent equivalences of diagrams and we use the same notation for them and their inverses.

From now on H will indicate the unimodular cocommutative bialgebra which generates \mathcal{H}^c .

Notations. The notations for the identities, the braiding and the canonical morphisms in Theorem 3.3 on multiple products of H , will be simplified as follows:

$$\text{id}_n \stackrel{\text{def}}{=} \text{id}_{H^{\circ n}}, \quad \gamma_{n,m} \stackrel{\text{def}}{=} \gamma_{H^{\circ n}, H^{\circ m}} \quad \text{for } n, m > 0.$$

$$\Upsilon^\sigma \stackrel{\text{def}}{=} \Upsilon_{H, \dots, H}^\sigma : H^{\circ n} \rightarrow H^{\circ n}, \quad \text{for } \sigma \in \Sigma_n.$$

In the next proposition we list some well known properties of \mathcal{H}^c , the most important of which is that H has an involutory antipode and it is therefore a Hopf algebra. This will allow as from now on to call H the universal cocommutative Hopf algebra. The results of Proposition 3.7 appear in the literature in different contexts, nevertheless, the interested reader can find the proofs in Appendix A using the diagrammatic language.

Proposition 3.7. *Let H be a unimodular cocommutative bialgebra in $(\mathcal{C}, \diamond, \mathbb{1}, \gamma)$. Then (cf. Table 2) H is a Hopf algebra with antipode*

$$S = ((l \circ \mu) \diamond \text{id}_1) \circ (\text{id}_1 \diamond \gamma) \circ ((\Delta \circ L) \diamond \text{id}_1) = (\text{id}_1 \diamond (l \circ \mu)) \circ (\gamma \diamond \text{id}_1) \circ (\text{id}_1 \diamond (\Delta \circ L)) \quad (\text{s0-0}')$$

Moreover,

$$S^2 = \text{id}_1 \quad (\text{s2})$$

$$S \circ L = L, \quad l \circ S = l \quad (\text{i4-5})$$

$$\Delta \circ S = (S \diamond S) \circ \gamma_{1,1} \circ \Delta = (S \diamond S) \circ \Delta, \quad (\text{s3})$$

$$S \circ \mu = \mu \circ (S \diamond S) \circ \gamma_{1,1}, \quad (\text{s4})$$

$$\epsilon \circ S = \epsilon, \quad S \circ \eta = \eta, \quad (\text{s5-6})$$

$$(S \diamond \text{id}) \circ \Delta \circ L = (\text{id} \diamond S) \circ \Delta \circ L, \quad (\text{s7})$$

$$l \circ \mu \circ (S \diamond \text{id}) = l \circ \mu \circ (\text{id} \diamond S), \quad (\text{s8})$$

$$l \circ \mu \circ \gamma = l \circ \mu, \quad (\text{s9})$$

$$(\text{id} \diamond (l \circ \mu)) \circ ((\Delta \circ L) \diamond \text{id}) = S = ((l \circ \mu) \diamond \text{id}) \circ (\text{id} \diamond (\Delta \circ L)). \quad (\text{s10-10}')$$

Proof. See Appendix A. □

Proposition 3.8. *Given $n \geq 1$, let $\pi_n \in \Sigma_{2n}$, be such that*

$$\pi_n(2i-1) = i \quad \text{and} \quad \pi_n(2i) = n+i, \quad 1 \leq i \leq n.$$

Then:

$$\lambda_n = (l \circ \mu \circ (\text{id} \diamond S))^{\diamond n} \circ \Upsilon^{\pi_n^{-1}} : H^{\diamond n} \diamond H^{\diamond n} \rightarrow \mathbb{1}$$

and

$$\Lambda_n = \Upsilon^{\pi_n} \circ \Delta^{\diamond n} \circ L^{\diamond n} : \mathbb{1} \rightarrow H^{\diamond n} \diamond H^{\diamond n}.$$

define non degenerate form and coform on $H^{\diamond n}$, i.e

$$(\text{id}_n \diamond \lambda_n) \circ (\Lambda_n \diamond \text{id}_n) = \text{id}_n = (\lambda_n \diamond \text{id}_n) \circ (\text{id}_n \diamond \Lambda_n).$$

Proof. Relations (s7-8) and (s10-10') in Proposition 3.7 imply that (see Table 2):

$$\Lambda = \Lambda_1 = \Delta \circ L, \tag{f1}$$

$$\lambda = \lambda_1 = l \circ \mu \circ (\text{id}_1 \diamond S), \tag{f2}$$

satisfy the identities:

$$(\text{id}_1 \diamond \lambda) \circ (\Lambda \diamond \text{id}_1) = \text{id}_1 = (\lambda \diamond \text{id}_1) \circ (\text{id}_1 \diamond \Lambda) \tag{f3-3'}$$

For $n > 1$, $\lambda_n : H^{\diamond n} \diamond H^{\diamond n} \rightarrow \mathbb{1}$ and $\Lambda_n : \mathbb{1} \rightarrow H^{\diamond n} \diamond H^{\diamond n}$ can be obtained by the following inductive definition⁴:

$$\Lambda_n = (\text{id}_{n-1} \diamond \gamma_{n-1,1} \diamond \text{id}_1) \circ (\Lambda_{n-1} \diamond \Lambda),$$

$$\lambda_n = (\lambda_{n-1} \diamond \lambda) \circ (\text{id}_{n-1} \diamond \gamma_{1,n-1} \diamond \text{id}_1).$$

Then the naturality of the braiding morphisms and (f3-3') imply that the nondegeneracy condition holds for any $n \geq 1$. □

Definition 3.9. For any $n \geq 0$ we define the morphisms $\Delta^n : H \rightarrow H^{\diamond(n+1)}$ and $\mu^n : H^{\diamond(n+1)} \rightarrow H$ inductively as follows:

$$\Delta^0 = \text{id}_1$$

$$\Delta^n = (\Delta^{n-1} \diamond \text{id}_1) \circ \Delta \quad \text{for } n > 0,$$

$$\mu^0 = \text{id}_1$$

$$\mu^n = \mu \circ (\mu^{n-1} \diamond \text{id}_1) : H^{\diamond(n+1)} \rightarrow H \quad \text{for } n > 0.$$

In the next proposition we generalize to any n relations (a5), (a9) and (s4).

Proposition 3.10. *Let $n \geq 0$.*

(a) *Let $\pi_{n+1} \in \Sigma_{2(n+1)}$, be such that $\pi_{n+1}(2i-1) = i$ and $\pi_{n+1}(2i) = n+1+i$, $1 \leq i \leq n+1$. Then*

$$\Delta \circ \mu^n = (\mu^n \diamond \mu^n) \circ \Upsilon^{\pi_{n+1}} \circ \Delta^{\diamond(n+1)}. \tag{a10}$$

⁴The extension of the definition of the form and the coform to any $n > 1$ is not unique. The choice here is different from the one in [3] and it is more appropriate to the use we make of it.

(b) For any permutation $\sigma \in \Sigma_{n+1}$,

$$\Upsilon^\sigma \circ \Delta^n = \Delta^n, \quad (\text{a11})$$

(c) Let $\tau_{n+1} \in \Sigma_{n+1}$ be such that $\tau_{n+1}(i) = n+2-i$, $1 \leq i \leq n+1$. Then

$$S \circ \mu^n = \mu^n \circ \Upsilon^{\tau_{n+1}} \circ S^{\diamond(n+1)}, \quad (\text{s11})$$

Proof. (a10) is proved by induction on n . If $n = 0$, the statement is trivial and for $n = 1$, it coincides with (a5). Suppose now the statement is true for some $n \geq 1$. Then

$$\begin{aligned} \Delta \circ \mu \circ (\mu^n \diamond \text{id}_1) &= (\mu \diamond \mu) \circ (\text{id}_1 \diamond \gamma_{1,1} \diamond \text{id}_1) \circ ((\Delta \circ \mu^n) \diamond \Delta) \\ &= (\mu \diamond \mu) \circ (\text{id}_1 \diamond \gamma_{1,1} \diamond \text{id}_1) \circ (((\mu^n \diamond \mu^n) \circ \Upsilon^{\pi_{n+1}}) \diamond \text{id}_2) \circ \Delta^{\diamond(n+2)} \\ &= (\mu^{n+1} \diamond \mu^{n+1}) \circ (\text{id}_1 \diamond \gamma_{n+1,1} \diamond \text{id}_1) \circ (\Upsilon^{\pi_{n+1}} \diamond \text{id}_2) \circ \Delta^{\diamond(n+2)} \\ &= (\mu^{n+1} \diamond \mu^{n+1}) \circ \Upsilon^{\pi_{n+2}} \circ \Delta^{\diamond(n+2)}, \end{aligned}$$

where we have used first (a5), then the induction hypothesis, and finally the naturality of the braiding.

For $n = 0$ (a11) follows from the definitions of Υ^{id_1} and that of Δ^0 . On the other hand, if $n > 0$, any permutation in Σ_{n+1} can be expressed as composition of adjacent transpositions and, according to property (iv) in Theorem 3.3, $\Upsilon^{\sigma' \circ \sigma} = \Upsilon^{\sigma'} \circ \Upsilon^\sigma$. Therefore, it is enough to prove (a11) in the case in which σ is an adjacent transposition and in that case it follows directly from the coassociativity axiom (a1) and the cocommutativeity axiom (a9).

(s11) follows by induction on n . For $n = 0$ the statement is trivial. Suppose it is true for $n \geq 0$. Then using the property of the antipode (s4) and the naturality of the braiding morphism (b3), we obtain:

$$\begin{aligned} S \circ (\mu \circ (\mu^n \diamond \text{id}_1)) &= \mu \circ \gamma_{1,1} \circ ((S \circ \mu^n) \diamond S) \\ &= \mu \circ \gamma_{1,1} \circ ((\mu^n \circ \Upsilon^{\tau_{n+1}} \circ S^{\diamond(n+1)}) \diamond S) \\ &= \mu^{n+1} \circ \Upsilon^{\tau_{n+2}} \circ S^{\diamond(n+2)}. \end{aligned}$$

□

4 The equivalence functor $\Omega : \mathcal{H}^c \rightarrow \mathcal{P}$

The one-point union of cobordisms in CW^{1+1} induces through the equivalence functor in Theorem 2.4 a strict monoidal structure on the category of relative group presentations \mathcal{P} , whose product $\diamond : \mathcal{P} \times \mathcal{P} \rightarrow \mathcal{P}$ is given by the sum on the set of objects and by the disjoint union on the set of morphisms as follows:

$$\begin{aligned} n \diamond m &= n + m \\ \langle \bar{A}_1, \bar{A}_2; B | R \rangle \diamond \langle \bar{A}'_1, \bar{A}'_2; B' | R' \rangle &\simeq \langle \overline{A_1 \sqcup A'_1}, \overline{A_2 \sqcup A'_2}; B \sqcup B' | R \sqcup R' \rangle, \end{aligned}$$

where in $\overline{A_i \sqcup A'_i}$, the enumeration of A'_i is shifted forward by the cardinality of A_i , $i = 1, 2$. The identity object is 0.

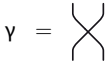






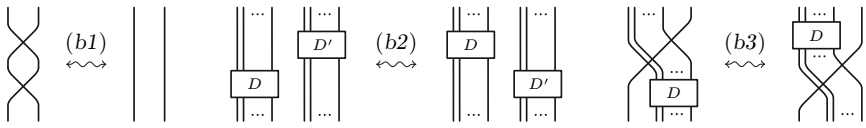
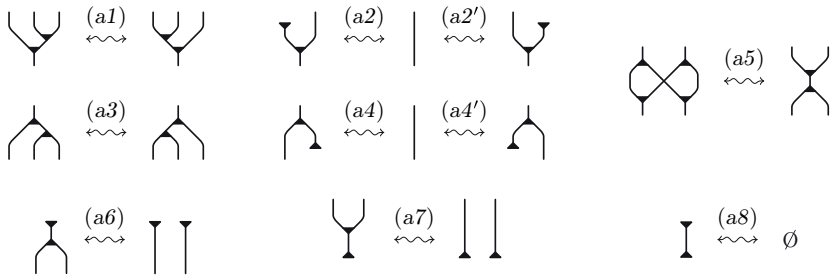
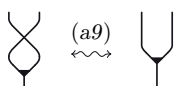
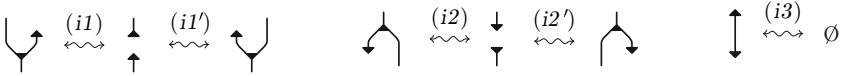
Elementary diagrams of \mathcal{H}^c			
$\gamma =$ 	$\Delta =$ 	$\varepsilon =$ 	$l =$ 
braiding	comultiplication	counit	cointegral
	$m =$ 	$\eta =$ 	$L =$ 
	multiplication	unit	integral
Axioms of the category \mathcal{H}^c			
			
Braid axioms			
			
Bialgebra axioms			
			
Triangularity axiom			
			
Integral axioms			

Table 1

Antipode in \mathcal{H}^c	
$S = \begin{array}{c} \\ \circ \\ \end{array} \xrightleftharpoons[\text{def}]{(s0)} \begin{array}{c} \uparrow \\ \diagdown \\ \diagup \\ \downarrow \end{array} \xrightleftharpoons{(s0')} \begin{array}{c} \uparrow \\ \diagup \\ \diagdown \\ \downarrow \end{array}$	
<i>Definition</i>	
<i>Properties of \mathcal{H}^c</i>	
Form and coform in \mathcal{H}^c	
$\Lambda = \cup \xrightleftharpoons[\text{def}]{(f1)} \begin{array}{c} \downarrow \\ \cup \end{array} \quad \lambda = \cap \xrightleftharpoons[\text{def}]{(f2)} \begin{array}{c} \uparrow \\ \cap \end{array} \quad \begin{array}{c} \downarrow \\ \cup \end{array} \xrightleftharpoons{(f3)} \xrightleftharpoons{(f3')} \begin{array}{c} \downarrow \\ \cup \end{array}$	
$\Lambda_n = \begin{array}{c} \cup \\ \dots \\ \cup \end{array} \quad \lambda_n = \begin{array}{c} \cap \\ \dots \\ \cap \end{array}$	

Table 2









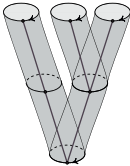
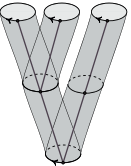
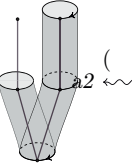
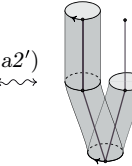
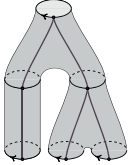
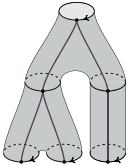
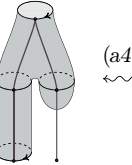
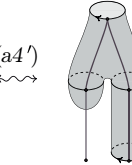
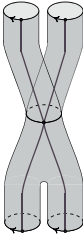
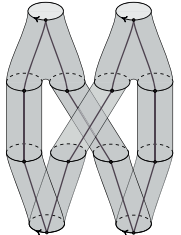
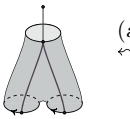

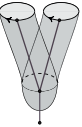
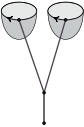
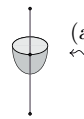

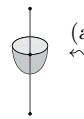

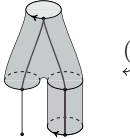

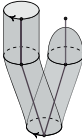

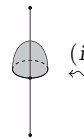

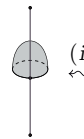

Elementary cobordisms of CW^{1+1}			
 identity	 comultiplication	 counit	 cointegral
 braiding	 multiplication	 unit	 integral
Bialgebra and integral relations in CW^{1+1}			
			
			
			
			
			
			
			

Table 3

Theorem 4.1. (\mathcal{P}, \diamond) is a strict symmetric monoidal category with braiding morphism $\hat{\gamma}_{n,m} : n \diamond m \rightarrow m \diamond n$ given by

$$\hat{\gamma}_{n,m} \simeq \langle (a_1, \dots, a_{n+m}), (b_1, \dots, b_{n+m}); \emptyset \mid a_1 b_{m+1}^{-1} \dots, a_n b_{m+n}^{-1}, a_{n+1} b_1^{-1}, \dots, a_{m+n} b_m^{-1} \rangle.$$

Moreover, the object $1 \in \mathbf{N}$ is a unimodular cocommutative Hopf algebra in \mathcal{P} with

$$\text{identity } \hat{\text{id}}_n = \langle (a_1, \dots, a_n), (b_1, \dots, b_n); \emptyset \mid a_1 b_1^{-1}, \dots, a_n b_n^{-1} \rangle, : n \rightarrow n;$$

$$\text{comultiplication } \hat{\Delta} \simeq \langle (a), (b, c); \emptyset \mid ab^{-1}, ac^{-1} \rangle : 1 \rightarrow 2;$$

$$\text{counit } \hat{\epsilon} \simeq \langle (a), \emptyset; \emptyset \mid \emptyset \rangle : 1 \rightarrow 0;$$

$$\text{multiplication } \hat{\mu} \simeq \langle (a, b), (c); \emptyset \mid abc^{-1} \rangle : 2 \rightarrow 1;$$

$$\text{unit } \hat{\eta} \simeq \langle \emptyset, (a); \emptyset \mid a \rangle : 0 \rightarrow 1;$$

$$\text{cointegral } \hat{l} \simeq \langle (a), \emptyset; \emptyset \mid a \rangle : 1 \rightarrow 0;$$

$$\text{integral } \hat{L} \simeq \langle \emptyset, (a); \emptyset \mid \emptyset \rangle : 0 \rightarrow 1;$$

$$\text{antipode } \hat{S} \simeq \langle (a), (b); \emptyset \mid ab \rangle : 1 \rightarrow 1.$$

The statement of Theorem 4.1 is illustrated in Table 3, where we have represented the relative 2-dimensional CW-complexes, whose images under the functor equivalence Π in Theorem 2.4 are $\hat{\text{id}}_1$, $\hat{\Delta}$, $\hat{\mu}$, $\hat{\epsilon}$, $\hat{\eta}$, \hat{L} and \hat{l} and the relations in CW^{1+1} which correspond to the bialgebra and integral axioms.

Proof. We have to check that the morphisms in the statement of the theorem satisfy the axioms in Definition 3.5 (cf. Table 1). All proofs are based on the following observation: in the composition $P_2 \circ P_1$ of two morphisms in \mathcal{P} , the external generators in the target of P_1 (and in the source of P_2) become internal, and those of them which appear in a relation r with total exponent ± 1 , can be eliminated by first cyclicly permuting and/or inverting r (moves (ac4) and (ac5)) in order to represent it as a product of some word w and the inverse of the generator, then substituting the generator by w in all other relations and finally cancelling the generator and r from $P_2 \circ P_1$ (move (ac7)). Using this strategy we will eliminate all internal operators which appear in both, right- and left-hand sides of the relations in Definition 3.5 and show that the resulting presentations are equivalent.

We start by showing that the braiding is symmetric (axiom (b1)); indeed,

$$\begin{aligned} \hat{\gamma}_{1,1} \circ \hat{\gamma}_{1,1} &\simeq \langle (a_1, a_2), (b_1, b_2); c_1, c_2 \mid a_1 c_2^{-1}, a_2 c_1^{-1}, c_1 b_2^{-1}, c_2 b_1^{-1} \rangle \\ &\simeq \langle (a_1, a_2), (b_1, b_2); \emptyset \mid a_2 b_2^{-1}, a_1 b_1^{-1} \rangle \simeq \hat{\text{id}}_1 \diamond \hat{\text{id}}_1, \end{aligned}$$

where we have used the first two relations to eliminate the internal generators c_1 e c_2 . The other two braiding axioms (b2-3) are straightforward.

The left- and the right-hand side of the coassociativity axiom (a1) are the following:

$$\begin{aligned} (\hat{\text{id}}_1 \diamond \hat{\Delta}) \circ \hat{\Delta} &\simeq \langle (a), (b_1, b_2, b_3); c_1, c_2 \mid ac_1^{-1}, ac_2^{-1}, c_1 b_1^{-1}, c_2 b_2^{-1}, c_2 b_3^{-1} \rangle, \\ (\hat{\Delta} \diamond \hat{\text{id}}_1) \circ \hat{\Delta} &\simeq \langle (a), (b_1, b_2, b_3); c_1, c_2 \mid ac_1^{-1}, ac_2^{-1}, c_1 b_1^{-1}, c_1 b_2^{-1}, c_2 b_3^{-1} \rangle. \end{aligned}$$

Then, using the first two relations in each of the above presentations to eliminate the internal generators c_1 and c_2 and substituting them elsewhere by a , we obtain

$$(\hat{\Delta} \diamond \hat{\text{id}}_1) \circ \hat{\Delta} \simeq \langle (a), (b_1, b_2, b_3); \emptyset \mid ab_1^{-1}, ab_2^{-1}, ab_3^{-1} \rangle \simeq (\hat{\text{id}}_1 \diamond \hat{\Delta}) \circ \hat{\Delta}.$$

Analogously, we prove the associativity of the multiplication (axiom (a3)):

$$\begin{aligned}\hat{\mu} \circ (\hat{\text{id}}_1 \circ \hat{\mu}) &\simeq \langle (a_1, a_2, a_3), (b); c_1, c_2 \mid a_1 c_1^{-1}, a_2 a_3 c_2^{-1}, c_1 c_2 b^{-1} \rangle, \\ \hat{\mu} \circ (\hat{\mu} \circ \hat{\text{id}}_1) &\simeq \langle (a_1, a_2, a_3), (b); c_1, c_2 \mid a_1 a_2 c_1^{-1}, a_3 c_2^{-1}, c_1 c_2 b^{-1} \rangle,\end{aligned}$$

and eliminating the internal generators c_1 and c_2 , we obtain

$$\hat{\mu} \circ (\hat{\mu} \circ \hat{\text{id}}_1) \simeq \langle (a_1, a_2, a_3), (b); \emptyset \mid a_1 a_2 a_3 b^{-1} \rangle \simeq \hat{\mu} \circ (\hat{\text{id}}_1 \circ \hat{\mu})$$

Relations (a2) and (a4'), which assert that $\hat{\epsilon}$ and $\hat{\eta}$ are correspondingly left counit and unit are proved bellow, where we use again the first two relations to eliminate the internal generators c_1 e c_2 . The proofs of (a2') and (a4) are analogous.

$$\begin{aligned}(\hat{\epsilon} \circ \hat{\text{id}}_1) \circ \hat{\Delta} &\simeq \langle (a), (b); c_1, c_2 \mid a c_1^{-1}, a c_2^{-1}, c_2 b^{-1} \rangle \simeq \langle (a), (b); \emptyset \mid a b^{-1} \rangle \simeq \hat{\text{id}}_1 \\ \hat{\mu} \circ (\hat{\eta} \circ \hat{\text{id}}_1) &\simeq \langle (a), (b); c_1, c_2 \mid c_1, a c_2^{-1}, c_1 c_2 b^{-1} \rangle \simeq \langle (a), (b); \emptyset \mid a b^{-1} \rangle \simeq \hat{\text{id}}_1\end{aligned}$$

The bialgebra axiom (a5), which states that $\hat{\Delta}$ is an algebra homomorphism, is proved bellow:

$$\begin{aligned}(\hat{\mu} \circ \hat{\mu}) \circ (\hat{\text{id}}_1 \circ \hat{\gamma}_{1,1} \circ \hat{\text{id}}_1) \circ (\hat{\Delta} \circ \hat{\Delta}) &\simeq \\ &\simeq \langle (a_1, a_2), (b_1, b_2); c_1, c_2, c_3, c_4 \mid a_1 c_1^{-1}, a_1 c_2^{-1}, a_2 c_3^{-1}, a_2 c_4^{-1}, c_1 c_3 b_1^{-1}, c_2 c_4 b_2^{-1} \rangle \\ &\simeq \langle (a_1, a_2), (b_1, b_2); \emptyset \mid a_1 a_2 b_1^{-1}, a_1 a_2 b_2^{-1} \rangle \\ &\simeq \langle (a_1, a_2), (b_1, b_2); c \mid a_1 a_2 c^{-1}, c b_1^{-1}, c b_2^{-1} \rangle \\ &\simeq \hat{\Delta} \circ \hat{\mu},\end{aligned}$$

where in the second step we have used the first four relations to eliminate the internal operators and in the third step we have inserted the generator c and the relation $a_1 a_2 c^{-1}$ applying the inverse of move (ac7).

The proofs of (a6) and (a7) are straightforward:

$$\begin{aligned}\hat{\epsilon} \circ \hat{\mu} &\simeq \langle (a_1, a_2), \emptyset; b \mid a_1 a_2 b^{-1} \rangle \simeq \langle (a_1, a_2), \emptyset; \emptyset \mid \emptyset \rangle \simeq \hat{\epsilon} \circ \hat{\epsilon} \\ \hat{\Delta} \circ \hat{\eta} &\simeq \langle \emptyset; (a_1, a_2), b \mid b, b a_1^{-1}, b a_2^{-1} \rangle \simeq \langle \emptyset, (a_1, a_2); \emptyset \mid a_1^{-1}, a_2^{-1} \rangle \simeq \hat{\eta} \circ \hat{\eta}\end{aligned}$$

Axiom (a8), i.e. that $\hat{l} \circ \hat{L} \simeq \hat{\text{id}}_0$, follows directly from (ac1), while the cocommutativeity axiom (a9) holds because the set of relations in a presentation is unordered.

It remains to check the integral axioms. (i2), (i3) and (i4) are obtained by direct application of (ac1), while (i5) follows from (ac7). The proof of (i1) is presented bellow:

$$\begin{aligned}(\hat{\text{id}}_1 \circ \hat{l}) \circ \hat{\Delta} &\simeq \langle (a), (b); c_1, c_2 \mid a c_1^{-1}, a c_2^{-1}, c_1 b^{-1}, c_2 \rangle \\ &\simeq \langle (a), (b); \emptyset \mid a b^{-1}, a \rangle \\ &\simeq \langle (a), (b); \emptyset \mid b a^{-1}, a \rangle \\ &\simeq \langle (a), (b); \emptyset \mid b, a \rangle \simeq \hat{\eta} \circ \hat{l},\end{aligned}$$

where in the first step we have used (ac7) to eliminate c_1 and c_2 , and in the second and the third steps we have used (ac5) and (ac3).

We have now proved that 1 is a unimodular bialgebra in the symmetric category \mathcal{P} . Then, according to Proposition 3.7, $1 \in \text{Obj}(\mathcal{P})$ is a Hopf algebra with antipode

$$\begin{aligned}S &= (\hat{\text{id}}_1 \circ (l \circ \mu)) \circ (\hat{\gamma} \circ \hat{\text{id}}_1) \circ (\hat{\text{id}}_1 \circ (\hat{\Delta} \circ \hat{L})) \\ &\simeq \langle (a), (b); c_1, c_2 \mid c_1 b^{-1}, c_1 c_2^{-1}, c_2 a \rangle \\ &\simeq \langle (a), (b); c_2 \mid b c_2^{-1}, c_2 a \rangle \\ &\simeq \langle (a), (b); \emptyset \mid b a \rangle \simeq \langle (a), (b); \emptyset \mid a b \rangle\end{aligned}$$

□

Proposition 4.2. *There exists a monoidal braided functor $\Omega : \mathcal{H}^c \rightarrow \mathcal{P}$ which sends H to 1 and each of the elementary morphisms of \mathcal{H}^c to the corresponding morphism of \mathcal{P} carrying the same name. Moreover for any $n \geq 1$,*

$$(a) \quad \Omega(\Delta^n) \simeq \langle (a), (b_1, b_2, \dots, b_{n+1}); \emptyset \mid ab_1^{-1}, ab_2^{-1}, \dots, ab_{n+1}^{-1} \rangle;$$

$$(b) \quad \Omega(\mu^n) \simeq \langle (a_1, a_2, \dots, a_{n+1}), (b); \emptyset \mid a_1 a_2 \dots a_{n+1} b^{-1} \rangle;$$

(c) For any $\sigma \in \Sigma_n$,

$$\Omega(\Upsilon^\sigma) \simeq \langle (a_1, a_2, \dots, a_n), (b_1, b_2, \dots, b_n); \emptyset \mid a_1 b_{\sigma(1)}^{-1}, a_2 b_{\sigma(2)}^{-1}, \dots, a_n b_{\sigma(n)}^{-1} \rangle.$$

$$(d) \quad \Omega(L \circ \eta) \simeq \langle \emptyset, \emptyset; \emptyset \mid 1 \rangle$$

Proof. The existence a monoidal braided functor $\Omega : \mathcal{H}^c \rightarrow \mathcal{P}$ follows from Theorem 4.1 and the universal property of \mathcal{H}^c .

(a) follows by induction on n . Indeed, for $n = 1$ it is true by the definition of Ω and supposing that the statement holds for $\Omega(\Delta^{n-1})$, we have

$$\begin{aligned} \Omega(\Delta^n) &= \Omega(\Delta^{n-1} \diamond \text{id}_1) \circ \Omega(\Delta) \\ &\simeq \langle (a), (b_1, \dots, b_n, b_{n+1}); c_1, c_2 \mid c_1 b_1^{-1}, c_1 b_2^{-1}, \dots, c_1 b_n^{-1}, c_2 b_{n+1}^{-1}, a c_1^{-1}, a c_2^{-1} \rangle \end{aligned}$$

Now it is enough to use the last two relations to eliminate c_1 and c_2 and to substitute them elsewhere by a . The proof of (b) is similar and it is left to the reader.

The statement (c) follows by induction on the minimal number m_σ of transpositions of the type $(i, i+1)$, $1 \leq i < n$ in which σ decomposes. Indeed, the statement for $\sigma = (i, i+1)$, reduces to the definition of $\Omega(\gamma)$. On the other hand, if the statement holds for σ and σ' , using Theorem 3.3 (iii) we obtain:

$$\begin{aligned} \Omega(\Upsilon^{\sigma' \circ \sigma}) &= \Omega(\Upsilon^{\sigma'}) \circ \Omega(\Upsilon^\sigma) \\ &\simeq \langle (a_1, \dots, a_n), (b_1, \dots, b_n); c_1, \dots, c_n \mid a_1 c_{\sigma(1)}^{-1}, \dots, a_n c_{\sigma(n)}^{-1}, c_1 b_{\sigma'(1)}^{-1}, \dots, c_n b_{\sigma'(n)}^{-1} \rangle \\ &\simeq \langle (a_1, \dots, a_n), (b_1, \dots, b_n); \emptyset \mid a_{\sigma^{-1}(1)} b_{\sigma'(1)}^{-1}, \dots, a_{\sigma^{-1}(n)} b_{\sigma'(n)}^{-1} \rangle \\ &\simeq \langle (a_1, \dots, a_n), (b_1, \dots, b_n); \emptyset \mid a_1 b_{\sigma' \circ \sigma(1)}^{-1}, \dots, a_n b_{\sigma' \circ \sigma(n)}^{-1} \rangle \end{aligned}$$

(d) can be obtained as following:

$$\Omega(L \circ \eta) \simeq \langle \emptyset, \emptyset; a \mid a, a \rangle \simeq \langle \emptyset, \emptyset; a \mid 1, a \rangle \simeq \langle \emptyset, \emptyset; \emptyset \mid 1 \rangle$$

□

The following proposition introduces a specific notation for some set of morphisms which we will need later, and states some of their properties.

Proposition 4.3. *Given word w of length $l \geq 1$ in $G = \{g_1, g_2, \dots, g_n\}$, define $\mathcal{S}_w : H^{\text{ol}} \rightarrow H^{\text{ol}} \in \text{Mor } \mathcal{C}$ inductively on l as follows:*

$$\mathcal{S}_{g_i} = \text{id}_1, \quad \mathcal{S}_{g_i^{-1}} = S, \quad \mathcal{S}_{w_1 w_2} = \mathcal{S}_{w_1} \diamond \mathcal{S}_{w_2}.$$

(a) For any $\sigma \in \Sigma_l$,

$$\Upsilon^\sigma \circ \mathcal{S}_w = \mathcal{S}_{\sigma(w)} \circ \Upsilon^\sigma. \tag{s12}$$

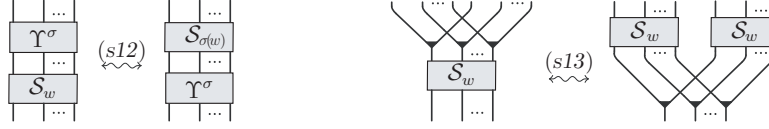


Figure 6: Properties of S_w .

(b) Let $\pi_l \in \Sigma_{2l}$, such that $\pi_l(2i-1) = i$ and $\pi_l(2i) = l+i$, $1 \leq i \leq l$ (cf. Proposition 3.10). Then

$$\Upsilon^{\pi_l} \circ \Delta^{\circ l} \circ S_w = (S_w \diamond S_w) \circ \Upsilon^{\pi_l} \circ \Delta^{\circ l}. \quad (s13)$$

The statement of the proposition is illustrated in Figure 6.

Proof. (s12) follows from the naturality of Υ . To prove (s13) we use induction on l . Indeed, for $l = 1$ the statement follows from (s3) and (a9) (cf. Table 2). Suppose it is true for $l \geq 1$ and let $w' = w g_i^{\epsilon_i}$ be a word of length $(l+1)$. Observe that the uniqueness of the canonical morphism in Theorem 3.3 implies that:

$$\Upsilon^{\pi_{l+1}} = (\text{id}_l \diamond \gamma_{l,1} \diamond \text{id}_1) \circ (\Upsilon^{\pi_l} \diamond \text{id}_2).$$

Then applying the induction hypotheses and the naturality of the braiding, we have

$$\begin{aligned} \Upsilon^{\pi_{l+1}} \circ \Delta^{\circ(l+1)} \circ S_{w'} &= (\text{id}_l \diamond \gamma_{l,1} \diamond \text{id}_1) \circ ((\Upsilon^{\pi_l} \circ \Delta^{\circ l} \circ S_w) \diamond (\Delta \circ S_{g_i^{\epsilon_i}})) \\ &= (\text{id}_l \diamond \gamma_{l,1} \diamond \text{id}_1) \circ (S_w \diamond S_w \diamond S_{g_i^{\epsilon_i}} \diamond S_{g_i^{\epsilon_i}}) \circ (\Upsilon^{\pi_l} \diamond \text{id}_2) \circ \Delta^{\circ(l+1)} \\ &= (S_{w'} \diamond S_{w'}) \circ \Upsilon^{\pi_{l+1}} \circ \Delta^{\circ(l+1)}. \end{aligned}$$

□

We can now state our main theorem.

Theorem 4.4. *There exists a monoidal braided functor $\bar{\Omega} : \mathcal{P} \rightarrow \mathcal{H}^c$ such that $\bar{\Omega} \circ \Omega = \text{id}_{\mathcal{H}^c}$ and $\Omega \circ \bar{\Omega} = \text{id}_{\mathcal{P}}$. In particular, Ω and $\bar{\Omega}$ are category equivalences.*

Proof. On the set of objects we define:

$$\bar{\Omega}(n) = H^{\circ n}.$$

Then, given a morphism $P = \langle (a_1, \dots, a_n), (b_1, \dots, b_m); C | R \rangle : n \rightarrow m$ in \mathcal{P} , the definition of $\bar{\Omega}(P)$ involves some choices.

First of all we fix a total order on the set of internal generators C and denote by \bar{G} the totally ordered set of generators of P , starting with the ones in the source, then the internal ones and finally the ones in the target:

$$\bar{G} = (g_1, g_2, \dots, g_r) \stackrel{\text{def}}{=} (a_1, \dots, a_n, c_1, \dots, c_k, b_1, \dots, b_m).$$

Here $r = n + m + k$ denotes the total number of generators.

Then we fix a total order on the set of relations R and we denote this ordered set by $\bar{R} = (w_1, \dots, w_s)$. Let

$$l_i = |w_i|, \quad w_P = w_1 w_2 \dots w_s, \quad \text{and} \quad e_i = |w_P|_{g_i}.$$

Let also w_P^+ be the word obtained from w_P by inverting the signs of all negative exponents of the generators. Observe that the length of w_P^+ is

$$l = \sum_{i=1}^s l_i = \sum_{i=1}^r e_i.$$

We choose now $\sigma_P \in \Sigma_l$ to be such that $\sigma_P(\prod_{i=1}^r g_i^{e_i}) = w_P^+$ (see p.11) and define:

$$\bar{\Omega}(P) = \left(\left(\diamond_{i=1}^s (l \circ \mu^{l_i-1} \circ \mathcal{S}_{w_i}) \circ \Upsilon^{\sigma_P} \circ (\diamond_{j=1}^r \Delta^{e_j-1}) \right) \diamond \text{id}_m \right) \circ (\text{id}_n \diamond L^{\triangleright k} \diamond \Lambda_m),$$

where if $e_j = 0$, i.e. the j -th generator does not appear in any relation, we put $\Delta^{-1} \stackrel{\text{def}}{=} \epsilon$. The definition of $\bar{\Omega}$ is illustrated in Figure 7 and a specific example is shown in Figure 8.

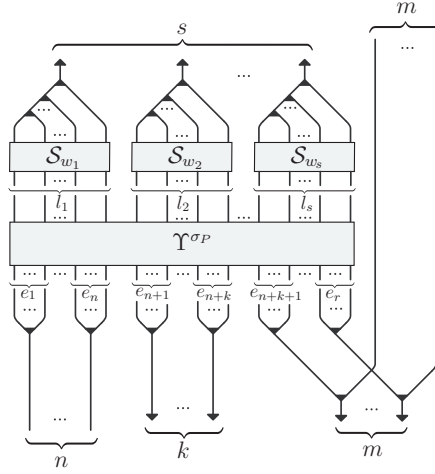


Figure 7: Definition of $\bar{\Omega}(P)$

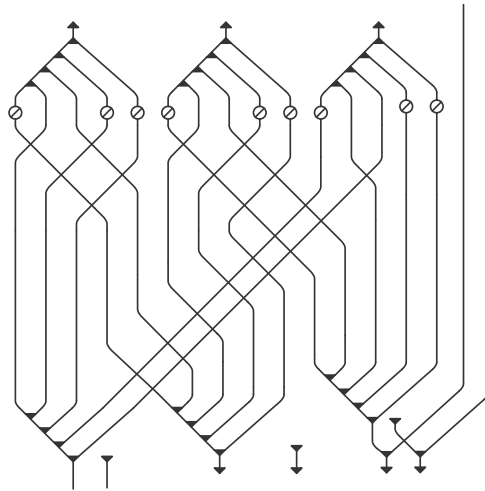


Figure 8: $\bar{\Omega}((a_1, a_2), (b_1, b_2), c_1, c_2 \mid c_1^{-1} a_1 c_1 a_1^{-2}, b_1^{-1} c_1 b_1 c_1^{-2}, a_1^{-1} b_1 a_1 b_1^{-2})$

Lemma 4.5. $\overline{\Omega}(P)$ is independent of the choice of σ_P and of the choices of total order of the sets of internal generators and relations.

Proof. We will show first the independence of the choice of σ_P . If σ_P and σ'_P are two permutations in Σ_l which rearrange the word $\prod_{i=1}^r g_i^{e_i}$ into the word w_P^+ , then $\sigma_P^{-1} \circ \sigma'_P$ leaves unchanged $\prod_{i=1}^r g_i^{e_i}$. Therefore $\sigma'_P = \sigma_P \circ (\sigma_1 \times \sigma_2 \times \dots \times \sigma_r)$ for some permutations $\sigma_i \in \Sigma_{e_i}$, $i = 1, \dots, r$ (cf. Definition 3.2). Then, according to Theorem 3.3 (iii) and (iv):

$$\Upsilon^{\sigma'_P} = \Upsilon^{\sigma_P} \circ (\Upsilon^{\sigma_1} \diamond \Upsilon^{\sigma_2} \diamond \dots \diamond \Upsilon^{\sigma_r}).$$

But (a11) in Proposition 3.10 implies that (Figure 9)

$$\Upsilon^{\sigma'_P} \circ (\diamond_{j=1}^r \Delta^{e_j}) = \Upsilon^{\sigma_P} \circ (\diamond_{j=1}^r (\Upsilon^{\sigma_j} \circ \Delta^{e_j})) = \Upsilon^{\sigma_P} \circ (\diamond_{j=1}^r \Delta^{e_j}).$$

Therefore substituting σ_P with σ'_P doesn't change $\overline{\Omega}(P)$.

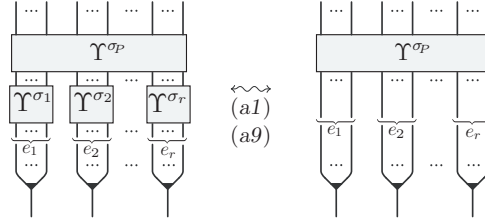


Figure 9: Independence of the choice of σ_P .

In order to prove the independence of the total order on the set of relations, it is enough to analyze what happens if two consecutive relations r_i and r_{i+1} are interchanged. Such move changes the permutation σ_P by a composition with a permutation which interchanges the positions of the l_i -tuple and the l_{i+1} -tuple (Figure 10). Therefore in the expression for $\overline{\Omega}(P)$, Υ^{σ_P} is substituted by $(\text{id}_{l'_i} \diamond \gamma_{l_i, l_{i+1}} \diamond \text{id}_{l''_i}) \circ \Upsilon^{\sigma_P}$, where $l'_i = \sum_{j=1}^{i-1} l_j$ and $l''_i = \sum_{j=i+1}^s l_j$. Then by the naturality of γ (axiom (b3) in Table 1) we have:

$$\left((l \circ \mu^{l_{i+1}} \circ \mathcal{S}_{w_{i+1}}) \diamond (l \circ \mu^{l_i} \circ \mathcal{S}_{w_i}) \right) \circ \gamma_{l_i, l_{i+1}} = \gamma_{\mathbb{1}, \mathbb{1}} \circ \left((l \circ \mu^{l_i} \circ \mathcal{S}_{w_i}) \diamond (l \circ \mu^{l_{i+1}} \circ \mathcal{S}_{w_{i+1}}) \right).$$

Hence interchanging r_i and r_{i+1} doesn't change $\overline{\Omega}(P)$.

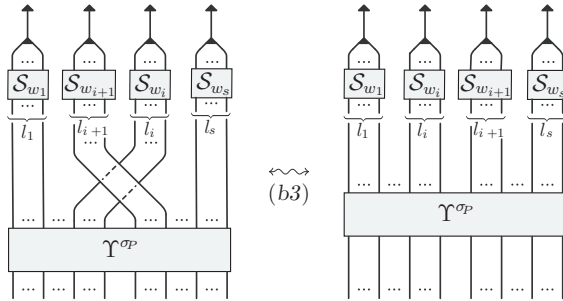


Figure 10: Independence of the choice of total order on the set of relations.

The proof of the independence of the total order on the set of internal generators is completely analogous and it is illustrated in Figure 11. \square

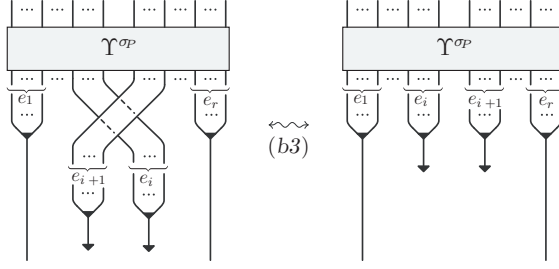


Figure 11: Independence of the choice of total order on the set of internal generators.

Lemma 4.6. $\overline{\Omega}(P)$ depends only on the AC-equivalence class of P .

Proof. We have to show that $\overline{\Omega}(P)$ is invariant under the five AC-moves in Definition 2.2.

Invariance under (ac1). Let Q be the presentation obtained from P by adding a new internal generator c_0 and a new relator $w_0 = c_0 v_0$, where v_0 is any word in G :

$$Q = \langle (a_1, \dots, a_n), (b_1, \dots, b_m); c_0, c_1, \dots, c_k \mid c_0 v_0, w_1, \dots, w_s \rangle$$

Let

$$l_0 = |w_0|, \quad l' = l + l_0, \quad f_i = |w_0|_{c_i}, \quad e'_i = |w_Q^+|_{c_i} = e_i + f_i \text{ if } i \geq 1 \text{ and } e'_0 = 1.$$

Assuming that the new generator and relator are the first ones, we have

$$\overline{\Omega}(Q) = \left(\left(\diamond_{i=0}^s (l \circ \mu^{l_i-1} \circ \mathcal{S}_{w_i}) \circ \Upsilon^{\sigma_Q} \circ (\diamond_{j=0}^r \Delta^{e'_j-1}) \right) \diamond \text{id}_m \right) \circ (\text{id}_n \diamond L^{\diamond k} \diamond \Lambda_m).$$

Moreover, since $\sigma_Q \in \Sigma_{l'}$ is defined up to multiplication of the right by element in $\times_{i=1}^r \Sigma_{e'_i}$, we can choose it in such a way that (see Figure 12):

$$\Upsilon^{\sigma_Q} = (\text{id}_1 \times \Upsilon^\sigma) \circ (\gamma_{f,1} \circ \text{id}_{l'-1-f}),$$

where $f = \sum_{i=1}^n e'_i$ and $\sigma \in \Sigma_{l'-1}$ is such that $\sigma(\prod_{i=1}^r g_i^{e'_i}) = v_0 w_1 \dots w_s$ and $\sigma^{-1}(i) < \sigma^{-1}(j)$ for any i, j with $1 \leq i \leq l_0 - 1$ and $l_0 \leq j \leq l' - 1$. Then, using the naturality of Υ , $\overline{\Omega}(Q)$ can be written as (Figure 12):

$$\begin{aligned} \overline{\Omega}(Q) &= \left(\left((l \circ \mu^{l_0-1}) \circ (L \diamond \mathcal{S}_{v_0}) \right) \diamond \left(\diamond_{i=1}^s (l \circ \mu^{l_i-1} \circ \mathcal{S}_{w_i}) \right) \right) \\ &\quad \circ \left((\Upsilon^\sigma \circ (\diamond_{j=1}^r \Delta^{e'_j-1})) \diamond \text{id}_m \right) \circ (\text{id}_n \diamond L^{\diamond k} \diamond \Lambda_m) \end{aligned}$$

Now applying the integral property (i2-3) and the invariance of the counit under the action of the antipode (a6), we have (see Figure 13):

$$\begin{aligned} \overline{\Omega}(Q) &= \left(\diamond_{i=1}^s (l \circ \mu^{l_i-1} \circ \mathcal{S}_{w_i}) \diamond \text{id}_m \right) \\ &\quad \circ \left(\left((\epsilon^{\diamond(l_0-1)} \diamond \text{id}_l) \circ \Upsilon^\sigma \right) \circ (\diamond_{j=1}^r \Delta^{e'_j-1}) \right) \diamond \text{id}_m \circ (\text{id}_n \diamond L^{\diamond k} \diamond \Lambda_m) \end{aligned}$$

Finally, using again the naturality of Υ and the counit property (a2) we obtain:

$$\begin{aligned} ((\epsilon^{\diamond(l_0-1)} \diamond \text{id}_l) \circ \Upsilon^\sigma) \circ (\diamond_{j=1}^r \Delta^{e'_j-1}) &= \Upsilon^{\sigma_P} \circ (\diamond_{j=1}^r ((\epsilon^{\diamond f_i} \diamond \text{id}_{e_i}) \circ \Delta^{e'_j-1})) \\ &= \Upsilon^{\sigma_P} \circ (\diamond_{j=1}^r \Delta^{e_j-1}), \end{aligned}$$

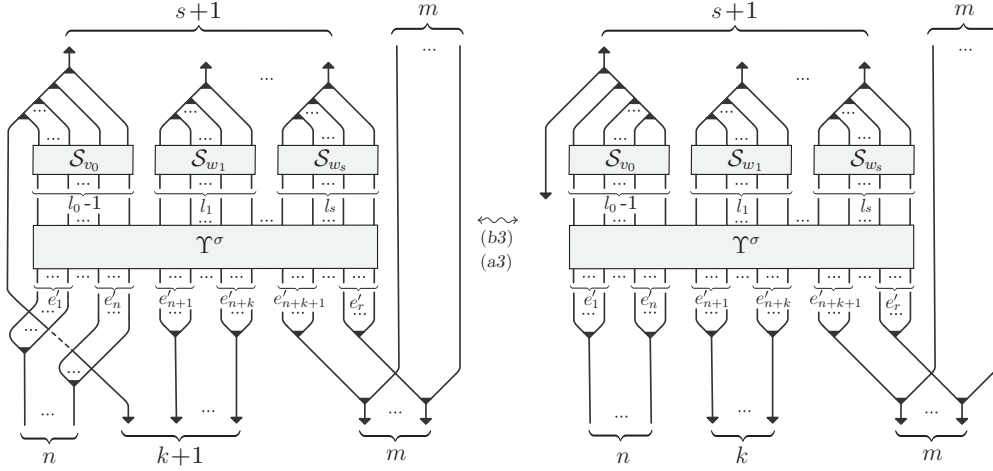


Figure 12: Invariance of $\bar{\Omega}(P)$ under (ac1), part I.

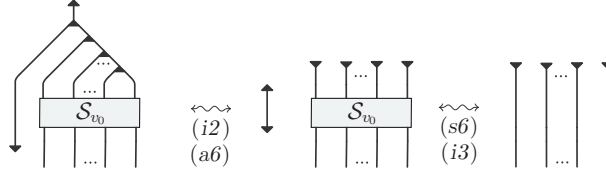


Figure 13: Invariance of $\bar{\Omega}(P)$ under (ac1), part II.

where as desired $\sigma_P(\prod_{i=1}^r g_i^{e_i}) = w_1 \dots w_s$.

Invariance under (ac2). The move (ac2) consists in multiplying a relator in R on the left by $g_i g_i^{-1}$ or by $g_i^{-1} g_i$ for some $g_i \in G$. Without loss of generality we can assume that the relator is the first one. The resulting presentation is:

$$Q = \langle (g_1, \dots, g_n), (g_{n+k+1}, \dots, g_r); g_{n+1}, \dots, g_{n+k} \mid g_i g_i^{-1} w_1, \dots, w_s \rangle$$

Let $e'_j = |w_Q|_{g_j}$, $1 \leq j \leq r$, $f = \sum_{j=1}^{i-1} e_j$ and $l'_1 = l_1 + 2$ and $l'_j = l_j$ for $j \geq 1$ be the lengths of the relators of Q . Then

$$\bar{\Omega}(Q) = \left(\left(\diamond_{i=1}^s (l \circ \mu^{l'_i-1} \circ \mathcal{S}_{w_i}) \circ \Upsilon^{\sigma_Q} \circ (\diamond_{j=1}^r \Delta^{e'_j-1}) \right) \diamond \text{id}_m \right) \circ (\text{id}_n \diamond L^{\circ k} \diamond \Lambda_m).$$

Moreover we can choose $\sigma_Q \in \Sigma_{l+2}$ in the form $\sigma_Q = (\text{id}_{\Sigma_2} \times \sigma_P) \circ \sigma$, where

$$\sigma(j) = \begin{cases} j+2 & \text{if } 1 \leq j \leq f, \\ 1 & \text{if } j = f+1, \\ 2 & \text{if } j = f+2, \\ j & \text{if } f+3 \leq j \leq l+2. \end{cases}$$

The relevant part of $\bar{\Omega}(Q)$ is presented in the left hand side of Figure 14. As indicated in the figure, now the equivalence of $\bar{\Omega}(Q)$ and $\bar{\Omega}(P)$ follows from the naturality of γ and the defining axioms of the antipode, the unit and the counit. The proof of the invariance under the multiplication by $g_i^{-1} g_i$ is analogous.

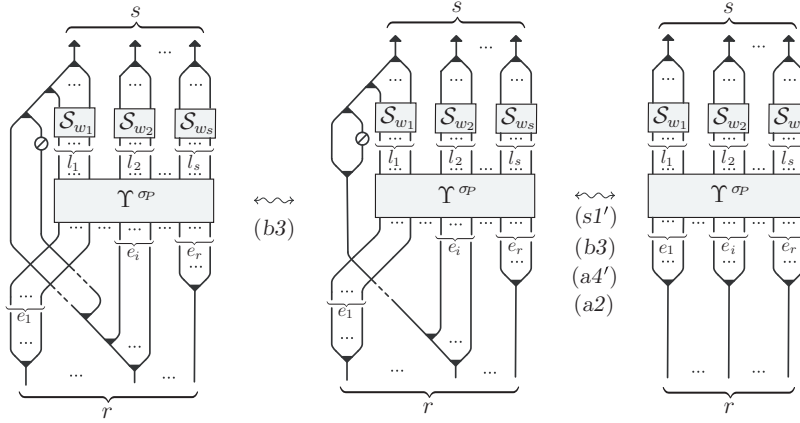


Figure 14: Invariance of $\bar{\Omega}(P)$ under (ac2).

Invariance under (ac3). Since the $\bar{\Omega}$ doesn't depend on the order the relators, it is enough to show that $\bar{\Omega}(P) = \bar{\Omega}(Q)$, where Q is obtained by multiplying the second relator by the first:

$$Q = \langle (g_1, \dots, g_n), (g_{n+k+1}, \dots, g_r); g_{n+1}, \dots, g_{n+k} \mid w_1, w_1 w_2, \dots, w_s \rangle$$

We start by observing that (see Figure 15):

$$\begin{aligned} & (l \circ \mu^{l_1-1} \circ \mathcal{S}_{w_1}) \diamond (l \circ \mu^{l_2-1} \circ \mathcal{S}_{w_2}) \\ &= l \circ \mu \circ (((l \diamond \text{id}_1) \circ (\Delta \circ \mu^{l_1-1} \circ \mathcal{S}_{w_1})) \diamond (\mu^{l_2-1} \circ \mathcal{S}_{w_2})) \\ &= (l \diamond (l \circ \mu)) \circ (((\mu^{l_1-1} \circ \mu^{l_1-1}) \circ \Upsilon^{\pi_{l_1}} \circ \Delta^{\diamond l_1} \circ \mathcal{S}_{w_1}) \diamond (\mu^{l_2-1} \circ \mathcal{S}_{w_2})) \\ &= (l \diamond (l \circ \mu)) \circ ((\mu^{l_1-1} \circ \mathcal{S}_{w_1}) \diamond (\mu^{l_1-1} \circ \mathcal{S}_{w_1}) \diamond (\mu^{l_2-1} \circ \mathcal{S}_{w_2})) \circ ((\Upsilon^{\pi_{l_1}} \circ \Delta^{\diamond l_1}) \diamond \text{id}_{l_2}) \\ &= ((l \circ \mu^{l_1-1} \circ \mathcal{S}_{w_1}) \diamond (l \circ \mu^{l_1+l_2-1} \circ \mathcal{S}_{w_1 w_2})) \circ ((\Upsilon^{\pi_{l_1}} \circ \Delta^{\diamond l_1}) \diamond \text{id}_{l_2}) \end{aligned}$$

Now we substitute the expression above in $\bar{\Omega}(P)$ and apply the naturality of Υ to obtain (see Figure 16):

$$((\Upsilon^{\pi_{l_1}} \circ \Delta^{\diamond l_1}) \diamond \text{id}_{l-l_1}) \circ \Upsilon^{\sigma P} \circ (\diamond_{i=1}^r \Delta^{e_i}) = \Upsilon^{\sigma Q} \circ (\diamond_{i=1}^r \Delta^{e'_i}),$$

where $e'_i = e_i + |w_1|_{g_i}$. Therefore $\bar{\Omega}(P) = \bar{\Omega}(Q)$.

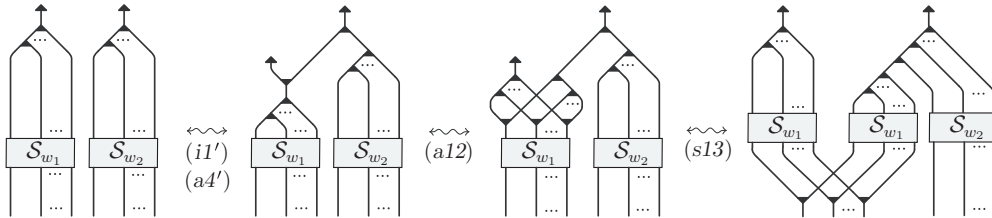


Figure 15: Invariance of $\bar{\Omega}(P)$ under (ac3) – part I.

Invariance under (ac4). The move (ac4) permutes cyclicly the letters of a relator. Let $w = g_{i_1} g_{i_2} \dots g_{i_p}$ be the relator on which the move is applied, transforming it in $w' = g_{i_p} g_{i_1} g_{i_2} \dots g_{i_{p-1}}$. In the expression for $\bar{\Omega}(P)$ this corresponds to the replacement of $l \circ$

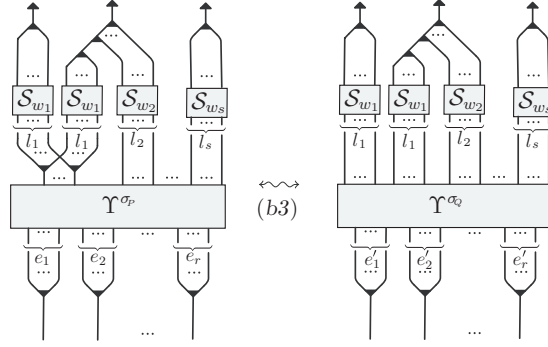


Figure 16: Invariance of $\overline{\Omega}(P)$ under (ac3) – part II.

$\mu^{p-1} \circ \mathcal{S}_w$ by $l \circ \mu^{p-1} \circ \mathcal{S}_{w'} \circ \gamma_{p-1,1}$, but as it is proved below the last two morphisms are equal in \mathcal{H}^c (cf. Figure 17):

$$\begin{aligned} l \circ \mu^{p-1} \circ \mathcal{S}_{w'} \circ \gamma_{p-1,1} &= l \circ \mu \circ (\text{id}_1 \diamond \mu^{p-2}) \circ \gamma_{p-1,1} \circ \mathcal{S}_w = l \circ \mu \circ \gamma_{1,1} \circ (\mu^{p-2} \diamond \text{id}_1) \circ \mathcal{S}_w \\ &= l \circ \mu \circ (\text{id}_1 \diamond \mu^{p-2}) \circ \mathcal{S}_w = l \circ \mu^{p-1} \circ \mathcal{S}_w, \end{aligned}$$

where we first apply (s12) in Proposition 4.3, then the naturality of γ and the associativity of μ , and finally we apply (s9) in Proposition 3.7.

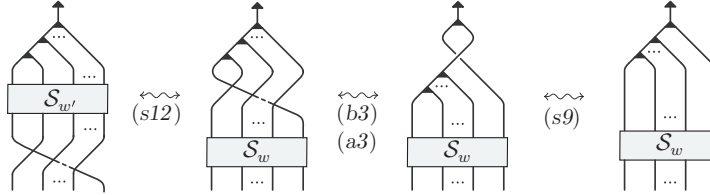


Figure 17: Invariance of $\overline{\Omega}(P)$ under (ac4).

Invariance under (ac5). Let $w = g_{i_1} g_{i_2} \dots g_{i_p}$ be the relator on which is replaced by its inverse. In the expression for $\overline{\Omega}(P)$ replacing w by w^{-1} corresponds to the replacement of $l \circ \mu^{p-1} \circ \mathcal{S}_w$ by $l \circ \mu^{p-1} \circ \mathcal{S}_{w^{-1}} \circ \Upsilon^{\tau_p}$ (cf. Proposition 3.10). As it is proved below the last two morphisms are equal in \mathcal{H}^c (cf. Figure 18):

$$\begin{aligned} l \circ \mu^{p-1} \circ \mathcal{S}_w &= l \circ \mathcal{S} \circ \mu^{p-1} \circ \mathcal{S}_w \\ &= l \circ \mu^{p-1} \circ \Upsilon^{\tau_p} \circ \mathcal{S}^{\diamond p} \circ \mathcal{S}_w \\ &= l \circ \mu^{p-1} \circ \mathcal{S}_{w^{-1}} \circ \Upsilon^{\tau_p}, \end{aligned}$$

where we first apply (i5), then (s11) in Proposition 3.10, and finally (s12) in Proposition 4.3 and (s2) in Proposition 3.7. \square

Proof of Theorem 4.1. We can now complete the proof of Theorem 4.1. We will first show that $\overline{\Omega}$ defines a braided monoidal functor from \mathcal{P} to \mathcal{H}^c , i.e. that it preserves identities, compositions, products and braiding structure.

We recall that

$$\text{id}_n = \langle (a_1, \dots, a_n), (b_1, \dots, b_n); \emptyset \mid a_1 b_1^{-1}, \dots, a_n b_n^{-1} \rangle$$

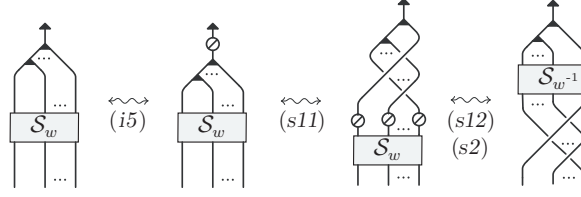


Figure 18: Invariance of $\bar{\Omega}(P)$ under (ac5).

Therefore Proposition 3.8 implies that (cf. Figure 19):

$$\begin{aligned}\bar{\Omega}(\hat{\text{id}}_n) &= ((l \circ \mu \circ (\text{id}_1 \diamond S))^{\diamond n} \circ \Upsilon^{\pi_n}) \diamond \text{id}_n \circ (\text{id}_n \diamond \Lambda_n) \\ &= (\lambda_n \diamond \text{id}_n) \circ (\text{id}_n \diamond \Lambda_n) = \text{id}_n.\end{aligned}$$

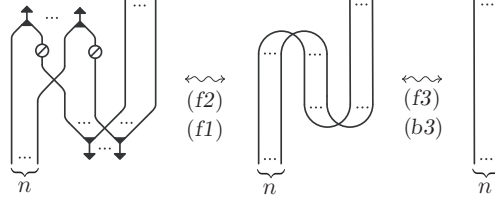


Figure 19: $\bar{\Omega}(P)$ preserves identities.

To see that $\bar{\Omega}$ preserves compositions, let

$$P = \langle \bar{A}, (h_1, \dots, h_m); C \mid R \rangle : n \rightarrow m, \quad Q = \langle (h_1, \dots, h_m), \bar{B}; C' \mid R' \rangle : m \rightarrow n',$$

be two morphisms in \mathcal{P} and let also

$$e_i = |w_P^+|_{h_i}, \quad e'_i = |w_Q^+|_{h_i}, \quad 1 \leq i \leq m, \quad q = |w_Q^+| - \sum_{i=1}^m e'_i, \quad p = |w_P^+| - \sum_{i=1}^m e_i.$$

Then

$$Q \circ P = \langle \bar{A}, \bar{B}; \{h_1, \dots, h_m\} \sqcup C \sqcup C' \mid R \sqcup R' \rangle : n \rightarrow n'.$$

Using the naturality of γ , we can transform the essential part of the morphism $\bar{\Omega}(Q) \circ \bar{\Omega}(P)$ as follows (cf. Figure 20):

$$\begin{aligned}(\Upsilon^{\sigma_P} \diamond \Upsilon^{\sigma_Q}) \circ (\text{id}_p \diamond ((\diamond_{i=1}^m \Delta^{e_i}) \diamond (\diamond_{i=1}^m \Delta^{e'_i}) \circ \Upsilon^{\pi_m} \circ (\Delta \circ L)^{\diamond m}) \diamond \text{id}_q) \\ = \Upsilon^{\sigma_{Q \circ P}} \circ (\text{id}_p \diamond (\diamond_{i=1}^m (\Delta^{e_i + e'_i} \circ L)) \diamond \text{id}_q).\end{aligned}$$

Therefore $\bar{\Omega}(Q) \circ \bar{\Omega}(P) = \bar{\Omega}(Q \circ P)$.

Since the product in \mathcal{P} is given by the disjoint union on the set of generators and relators, $\bar{\Omega}(P \diamond Q) = \bar{\Omega}(P) \diamond \bar{\Omega}(Q)$ follows from the naturality of the braiding, while the proof that $\bar{\Omega}$ preserves the braiding morphism is analogous to the one for the identity and is illustrated in Figure 21.

Now it remains to show that $\bar{\Omega}$ is the inverse functor of Ω , i.e. that $\bar{\Omega} \circ \Omega = \text{id}_{\mathcal{H}^c}$ and $\Omega \circ \bar{\Omega} = \text{id}_{\mathcal{P}}$

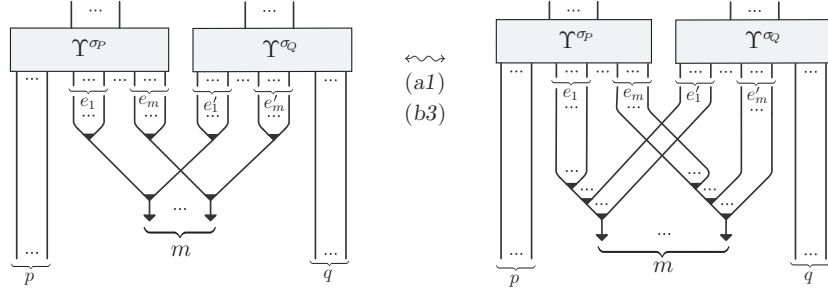


Figure 20: $\bar{\Omega}(P)$ preserves compositions.

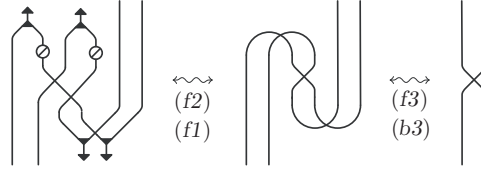


Figure 21: $\bar{\Omega}(P)$ preserves the braiding.

$\bar{\Omega} \circ \Omega = \text{id}_{\mathcal{H}^c}$ would follow if we show that $\bar{\Omega} \circ \Omega(P) = P$ where P is any of the morphisms $\hat{\Delta}, \hat{\mu}, \hat{S}, \hat{\epsilon}, \hat{\eta}, \hat{l} \in \hat{L}$ in Theorem 4.1. This is straightforward and the only non trivial cases are shown in Figure 22.

To see that $\Omega \circ \bar{\Omega} = \text{id}_{\mathcal{P}}$, let

$$P = \langle (g_1, \dots, g_n), (g_{n+k+1}, \dots, g_{n+k+m}); g_{n+1}, \dots, g_{n+k} \mid w_1, \dots, w_s, 1, \dots, 1 \rangle : n \rightarrow m$$

be a morphism in \mathcal{P} . From Proposition 4.2 it follows that after the elimination of some internal generators, $\Omega \circ \bar{\Omega}(P)$ is 2-equivalent to:

$$\langle (g_1, \dots, g_n), (y_1, \dots, y_m); g_{n+1}, \dots, g_{n+k}, g_{n+k+1}, \dots, g_{n+k+m}, x_1, \dots, x_m \mid w_1, \dots, w_s, 1, \dots, 1, x_1 y_1^{-1}, x_1 g_{n+k+1}^{-1}, \dots, x_m y_m^{-1}, x_m g_{n+k+m}^{-1} \rangle$$

Now $\Omega \circ \bar{\Omega}(P) \simeq P$ follows from the above expression by first using the relators $x_i y_i^{-1}$, $1 \leq i \leq m$, to eliminate all x_i 's substituting them by the y_i 's, and afterwards using the relators $y_i g_{n+k+i}^{-1}$ to eliminate all g_{n+k+i} 's substituting them by the y_i 's. Eventually we change the letters y_i to g_{n+k+i} . \square

5 \mathcal{H}^c as quotient of the universal ribbon Hopf algebra \mathcal{H}^r

Theorem 4.7.5 in [3] proves that there is an equivalence functor $\Phi : \mathcal{H}^r \rightarrow Chb^{3+1}$ from the category \mathcal{H}^r , freely generated by a unimodular ribbon Hopf algebra, to the category Chb^{3+1} of relative 4-dimensional 2-handlebody cobordisms up to 2-deformations. The axioms of the category \mathcal{H}^r are presented in Table 4 (cf. Tables 4.7.13 in [3]).

Proposition 5.1. *Let $\mathcal{H}^r / \langle v = \text{id}_H \rangle$ be the quotient of \mathcal{H}^r by the additional relation $v = \text{id}_H$. Then there exist an equivalence of braided monoidal categories*

$$\Theta : \mathcal{H}^r / \langle v = \text{id}_H \rangle \rightarrow \mathcal{H}^c$$















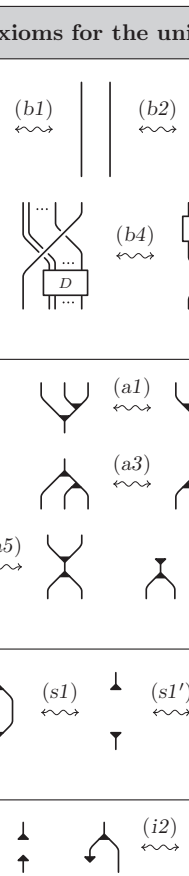
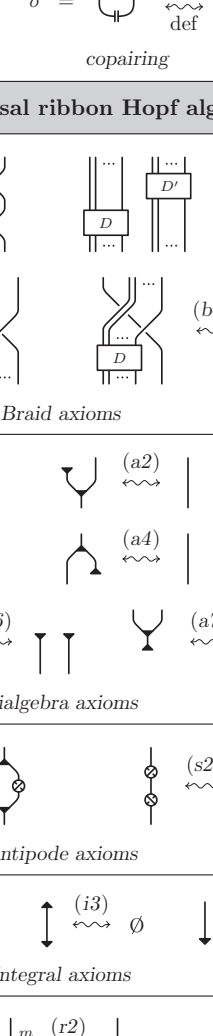
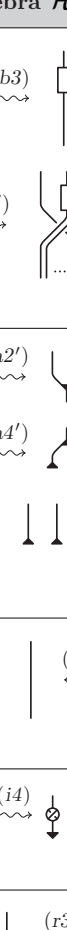

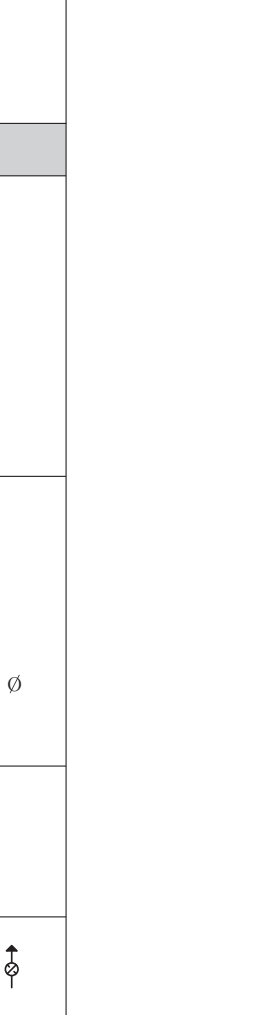
Elementary diagrams for the universal ribbon Hopf algebra \mathcal{H}^r				
$\gamma =$ 	$\Delta =$ 	$\varepsilon =$ 	$S =$ 	$l =$ 
braiding	comultiplication	counit	antipode	cointegral
$\bar{\gamma} =$ 	$m =$ 	$\eta =$ 	$\bar{S} =$ 	$L =$ 
	multiplication	unit		integral
$v^n =$ 	$\sigma =$ 	$(r6)$ def 	-1 	
ribbon morphisms	copairing			
Axioms for the universal ribbon Hopf algebra \mathcal{H}^r				
				
Braid axioms				
				
Bialgebra axioms				
				
Antipode axioms				
				
Integral axioms				
				
Ribbon axioms				

Table 4

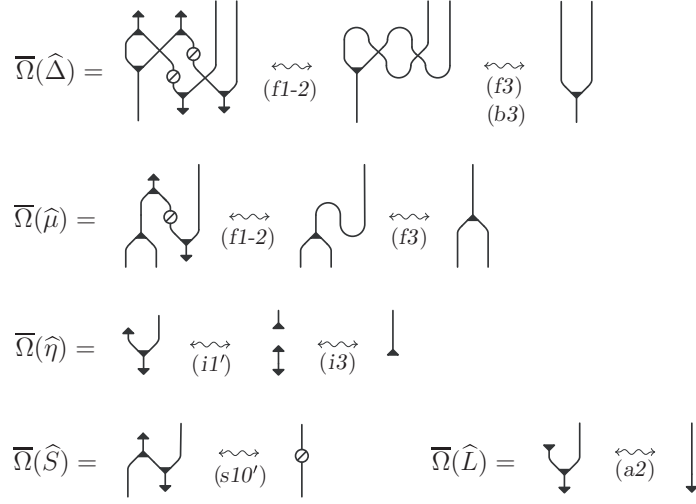


Figure 22: Proof that $\bar{\Omega} \circ \Omega = \text{id}_{\mathcal{H}^c}$.

Proof. We will first prove that $\mathcal{H}^r / \langle v = \text{id}_H \rangle$ is a symmetric category and H is a unimodular cocommutative Hopf algebra in it. Indeed, since $v = \text{id}_H$, axioms (r3-5) in Table 4 become identities, while axioms (r6) and (a7) in the same table imply that in $\mathcal{H}^r / \langle v = \text{id}_H \rangle$ the copairing is trivial, i.e. $\sigma = \eta \diamond \eta$. Then axiom (r7) becomes identity as well, while axioms (r8) and (r9) are reduced correspondingly to the cocommutative axiom (a9) and to the symmetry axiom (b1) in Table 1.

Therefore, $\mathcal{H}^r / \langle v = \text{id}_H \rangle$ is a unimodular cocommutative Hopf algebra and by the universality property of \mathcal{H}^c , there exists a braided monoidal functor $\bar{\Theta} : \mathcal{H}^c \rightarrow \mathcal{H}^r / \langle v = \text{id}_H \rangle$ which sends $H \in \mathcal{H}^c$ to $H \in \mathcal{H}^r / \langle v = \text{id}_H \rangle$. Moreover, $\bar{\Theta}$ is invertible and its inverse is the monoidal functor $\Theta : \mathcal{H}^r / \langle v = \text{id}_H \rangle \rightarrow \mathcal{H}^c$ which sends v to id_H , σ to $\eta \diamond \eta$ and the rest of the elementary morphisms of $\mathcal{H}^r / \langle v = \text{id}_H \rangle$ to the corresponding morphisms of \mathcal{H}^c caring the same name. \square

Remark By tracing the images of the generators of the categories \mathcal{H}^r and \mathcal{H}^c under the corresponding functors, one can easily check that the following commutative diagram holds:

$$\begin{array}{ccc}
 \mathcal{H}^r & \xrightarrow{\Phi} & \mathcal{C}hb^{3+1} \\
 \downarrow & & \downarrow \\
 \mathcal{H}^c & \xrightarrow{\Omega} & \mathcal{P},
 \end{array}$$

where the functor $\mathcal{H}^r \rightarrow \mathcal{H}^c$ is the composition of the quotient functor with Θ , while $\mathcal{C}hb^{3+1} \rightarrow \mathcal{P}$ is the forgetful functor which looks only at the relative presentation of the fundamental group of the 4-dimensional handlebody associated to its spine.

A Proof of Proposition 3.7

The proof is presented in Figure 23. We start by proving in the first line in the figure that S satisfies the defining property (s1) of the antipode. Then in the second line we show that the antipode can also be express through the formula (s0'), symmetric to (s0), and this implies (s1') by symmetry. Now, by applying the cocommutative ity condition (a9) ($\Delta = \gamma \circ \Delta$) to the comultiplication morphisms in (s0-0'), we obtain (s10-10') and,

expressing the antipode through $(s10-10')$, we immediately see that the right- and the left-hand side of $(s7)$ and $(s8)$ are the same.

$(s2)$ and $(i4)$ are proven in the third and the fourth lines in Figure 23, while the proof of $(i5)$ is obtained by reflecting the one of $(i4)$ with respect to the horizontal line.

Finally, $(s3-6)$ represent the basic properties of the antipode in any Hopf algebra and their proofs can be found in any text (see for example [11] or [3] in term of the diagrammatic language). Then $(s9)$ follows from $(s4)$ as it is shown in the last line in Figure 23.

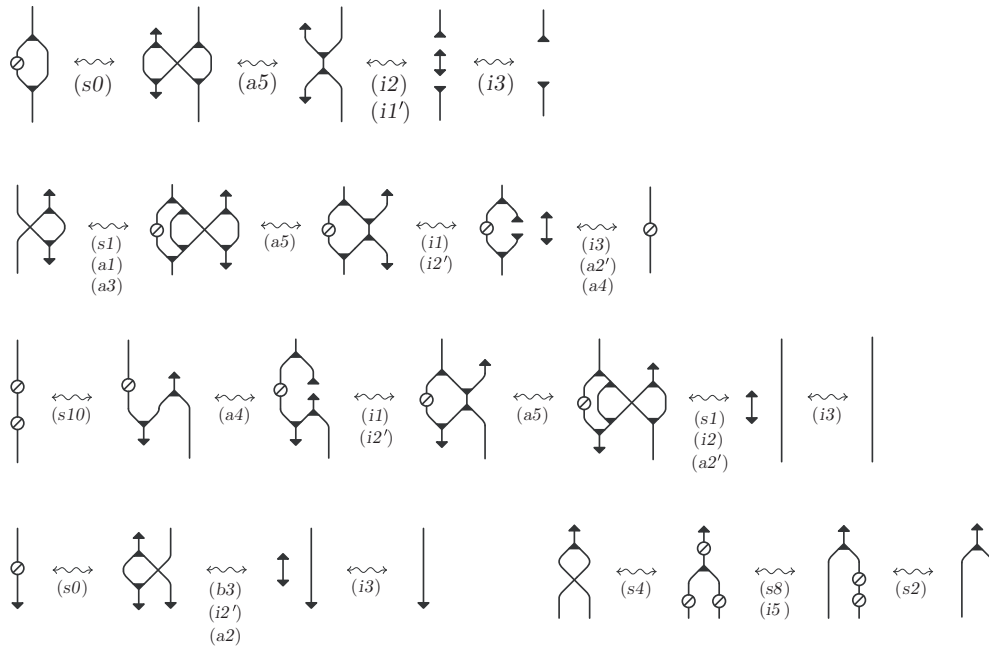


Figure 23: Proof of Proposition 3.7

References

- [1] J.J. Andrews, M. L. Curtis, *Free groups and handlebodies*, Proc. Amer. Math. Soc. **16** (1965), 192–195.
- [2] I.Bobtcheva, On Quinn’s invariants of 2-dimensional CW complexes, Contemporary Mathematics **233**, 69-96, (1999)
- [3] I.Bobtcheva, R. Piergallini, *On 4-dimensional 2-handlebodies and 3-manifolds*, J. Knot Theory Ramifications **21**, No.12 (2012)
- [4] I. Bobtcheva, F. Quinn, *The reduction of quantum invariants of 4-thickenings*, Fundamenta Mathematicae **188** (2005), 21–43.
- [5] S.Gelfand and D.Kazhdan, *Examples of tensor categories*, Invent.Math. **109** (1992), 595-617.
- [6] C. Hog-Angeloni, W.Metzler, A. Sieradski, *Two-dimensional homotopy and combinatorial group theory*, London Mathematical Society Lecture Notes Series **197**, Cambridge University Press, 1993.

- [7] T. Kerler, *Towards an algebraic characterization of 3-dimensional cobordisms*, Contemporary Mathematics **318** (2003), 141–173.
- [8] S. MacLane, *Natural associativities and commutativities*, Rice Univ. Studies **49** (1963), 28–46.
- [9] S. MacLane, *Categories for the working Mathematician*, Springer-Verlag, Graduate Texts in Mathematics **5** (1998).
- [10] S. Majid, *Foundations of Quantum Group Theory*, Cambridge University Press (1995).
- [11] S. Montgomery, *Hopf algebras and their actions on rings*, AMS, CBMS **82** (1992).
- [12] Müller, Klaus, *Probleme des Einfachen Homotopietyps in niederen Dimensionen und ihre Behandlung mit Hilfsmitteln der Topologischen Quantenfeldtheorie*. Der Andere Verlag Dissertation Frankfurt/Main, Chapter 3, (2000).
- [13] F. Quinn, *Handlebodies and 2-complexes*, Geometry and Topology, vol. **1167**, Lecture Notes in Mathematics, (1985), 245–259.
- [14] F. Quinn, *Lectures on Axiomatic Topological Quantum Field Theory*, LAS/Park City Mathematical Series, vol. **1**, 1995.
- [15] N. Yu. Reshetikhin, V.G. Turaev, *Invariants of 3-manifold via link polynomials and quantum groups*, Invent. Math. **103** (1991), 547–597.
- [16] M.C. Shum, *Tortile tensor categories*, Journal of Pure and Applied Algebra **93** (1994), 57–110.
- [17] C. T. C. Wall, *Formal deformations*, Proc. London Math. Soc. **16** (1966), 342–354.
- [18] C. T. C. Wall, *Relatively 1-dimensional complexes*, Math. Z. **172** (1980), 77–79.
- [19] P. Wright, *Group presentations and formal deformations*, Transactions of the AMS **208** (1975), 161–169.