

# An in-reachability based classification of invariant synchrony patterns in weighted coupled cell networks

P M Sequeira<sup>1</sup>, J P Hespanha<sup>2</sup> and A P Aguiar<sup>1</sup>

<sup>1</sup> SYSTEC-ARISE & Department of Electrical and Computer Engineering, Faculdade de Engenharia, Universidade do Porto, Rua Dr. Roberto Frias, 4200-465 Porto, Portugal

<sup>2</sup> Department of Electrical and Computer Engineering, University of California, Santa Barbara, CA, USA

E-mail: [pedro.sequeira@fe.up.pt](mailto:pedro.sequeira@fe.up.pt), [hspanha@ece.ucsb.edu](mailto:hspanha@ece.ucsb.edu), [pedro.aguiar@fe.up.pt](mailto:pedro.aguiar@fe.up.pt)

**Abstract.** This paper presents an in-reachability based classification of invariant synchrony patterns in Coupled Cell Networks (CCNs). These patterns are encoded through partitions on the set of cells, whose subsets of synchronized cells are called colors.

We study the influence of the structure of the network in the qualitative behavior of invariant synchrony sets, in particular, with respect to the different types of (cumulative) in-neighborhoods and the in-reachability sets. This motivates the proposed approach to classify the partitions into the categories of strong, rooted and weak, according to how their colors are related with respect to the connectivity structure of the network.

Furthermore, we show how this classification system acts under the partition join ( $\vee$ ) operation, which gives us the synchrony pattern that corresponds to the intersection of synchrony sets.

AMS classification scheme numbers: 34A34, 34C45, 05C20, 05C40

*Keywords:* coupled cell networks, synchrony, connectivity

Submitted to: *Nonlinearity at 17 of February of 2023*

## 1. Introduction

**Networks** are structures that describe systems with multiple components, called **cells**. These cells can be connected through **edges**, which encode how one cell affects another. In general, these edges can be directed or undirected and they can have weights in order to parameterize their interaction.

Networks are ubiquitous structures, both in the natural world and in engineering applications. Some examples are for instance the brain, the internet, the electric grid and electronic circuits in general, food webs and the spread of a virus in a pandemic.

In order to study these types of systems, the theory of **coupled cell networks** (CCN) was first formalized in [1, 2, 3]. In [4], this was generalized for networks with weighted connections and with arbitrary edges and edge types, and it is the formalism that we adopt in this work.

In theory of CCNs the concept of **admissible function** is defined such that a function  $f$  is admissible in a network if it satisfies certain minimal properties that allow it to be a valid modeling of some dynamical system  $\mathbf{x}^+/\dot{\mathbf{x}} = f(\mathbf{x})$  on that network.

In this work we study general equality-based invariant synchrony patterns, which are represented through partitions on the set of cells of a network. Much work has been done regarding balanced partitions, which represent patterns of synchrony that are invariant under any admissible function on the network of interest. Although balanced partitions represent a very important subclass of invariant synchrony patterns with strong properties, it is possible for other invariant patterns to be present in a network. Consider for instance the subset of admissible functions such that a cell becomes insensitive to cells that are on the same state. Note that such a system is, consequently, always insensitive to self-loops. This happens, for instance, in the Kuramoto model [5, 6, 7]. This property leads to the study of exo-balanced partitions [8, 9, 10], which is a larger class of partitions than the balanced ones.

For this reason, we consider arbitrary subsets of admissible functions  $F$  and show that the set of partitions  $L_F$  that describe synchrony patterns that are invariant under  $F$  always form lattices. Furthermore, we show that these lattices have similar properties to the lattices of balanced partition  $\Lambda_{\mathcal{G}}$ . In particular, these lattices share the same join operation  $\vee$  and have a  $cir_F$  function associated with them.

The coarsest invariant refinement ( $cir$ ), was first developed in [11] as polynomial-time algorithm that finds the maximal element of the lattice balanced partitions. In [9] it was noted that this algorithm does more than just finding the maximal balanced partition. In fact, given any input partition, it outputs the greatest balanced partition that is finer ( $\leq$ ) than the input one. Therefore, the maximal balanced partition is given by  $cir(\mathcal{T})$ . In this work, we show that the concept of  $cir$ , as a function, is not specific to balanced partitions and that every  $F$ -invariant lattice  $L_F$  has an associated  $cir_F$  function.

Furthermore, we explore how the connectivity structure of a CCN affects an admissible dynamical system in that network. In particular, we focus on the different types of (cumulative) in-neighborhoods and the in-reachability sets. We show that differences

in this structure can lead to qualitatively different behaviors of general equality-based invariant synchrony patterns.

In section 2 we summarize the formalism for general weighted CCNs.

In section 3 we provide the necessary background regarding general equality-based invariant synchrony patterns in CCNs.

In section 4 we clarify how the connectivity structure of a network affects its dynamics. This motivates the study of the network according to its in-reachability sets.

In section 5, motivated by the previous observations regarding the role of connectivity, we define a classification of partitions of invariant synchrony into strong, rooted and weak types.

## 2. Weighted multi-edge formalism

We start by introducing the definition of a cell coupled network according to the general weighted formalism.

### 2.1. Commutative monoids

The commutative monoid is a set equipped with a binary operation (usually denoted  $+$ ) such that it is commutative and associative. Furthermore, it has one identity element (usually denoted  $0$ ). This is the simplest algebraic structure that can be used to describe arbitrary finite parallels of edges. Note that associativity and commutativity, together, are equivalent to the invariance to permutations property.

In this work, the “sum” operation is denoted by  $\parallel$ , with the meaning of “adding in parallel”. In this context, the zero element of a monoid should be interpreted as “no edge”. Note that we do not require the existence of inverse elements. That is, given an edge, there does not need to exist another one such that the two in parallel act as “no edge”. This is the reason for the use of monoids instead of the algebraic structure of groups.

### 2.2. Multi-indexes

A multi-index is an ordered  $n$ -tuple of non-negative integers (indexes). That is, an element of  $\mathbb{N}_0^n$ . In particular,  $\mathbf{0}_n$  represents the tuple of  $n$  zeros. We denote the multi-indexes with the same notation we use for vectors, using bold, as in  $\mathbf{k} = [k_1, \dots, k_n]^\top$ . We will often specify the tupleness  $n$  of a multi-index  $\mathbf{k}$  indirectly, by using  $\mathbf{k} \geq \mathbf{0}_n$  in order to denote  $\mathbf{k} \in \mathbb{N}_0^n$ .

### 2.3. CCN formalism

According to [4], a general weighted coupled cell network is given by the following definition.

**Definition 2.1.** A network  $\mathcal{G}$  consists of a set of cells  $\mathcal{C}_{\mathcal{G}}$ , where each cell has a type, given by an index set  $T = \{1, \dots, |T|\}$  according to  $\mathcal{T}_{\mathcal{G}}: \mathcal{C}_{\mathcal{G}} \rightarrow T$  and has an  $|\mathcal{C}_{\mathcal{G}}| \times |\mathcal{C}_{\mathcal{G}}|$  in-adjacency matrix  $M_{\mathcal{G}}$ . The entries of  $M_{\mathcal{G}}$  are elements of a family of commutative monoids  $\{\mathcal{M}_{ij}\}_{i,j \in T}$  such that  $[M_{\mathcal{G}}]_{cd} = m_{cd} \in \mathcal{M}_{ij}$ , for any cells  $c, d \in \mathcal{C}_{\mathcal{G}}$  with types  $i = \mathcal{T}_{\mathcal{G}}(c)$ ,  $j = \mathcal{T}_{\mathcal{G}}(d)$ .  $\square$

For each commutative monoid  $\mathcal{M}_{ij}$  we denote its “zero” element as  $0_{ij}$ .

**Remark 1.** The subscripts  $\mathcal{G}$  are omitted when the network of interest is clear from context.  $\square$

#### 2.4. Admissibility

A function  $f: \mathbb{X} \rightarrow \mathbb{Y}$  is said to be **admissible** on a network if it respects the minimal properties that we expect from it in order to be a plausible modeling of the dynamics  $\dot{\mathbf{x}}/\mathbf{x}^+ = f(\mathbf{x})$  or some measurement function  $\mathbf{y} = f(\mathbf{x})$  on the network. In particular, it has to describe some **first-order property**. That is, it models something that, when evaluated at cell, depends on the state of that cell and its in-neighbors. This does not mean that everything on a network has to (or can) be defined by such a function. For instance, the second derivative or the two-step evolution of a dynamical system on a network will not be of this form. Those functions will be second-order in the sense that, when evaluated on a cell, they depend on the states of that cell, together with the states of the cells in its first and second in-neighborhoods (neighbor of neighbor). Such second-order functions are, however, fully defined from the original first-order functions. We construct admissible functions through the use of mathematical objects called **oracle components**, first introduced in [4] and then simplified in [12]. An oracle component is a mathematical object that describes how cells of a given type respond to arbitrary finite in-neighborhoods. It completely separates the modeling of the behavior of cells from the particular network on which the cells of interest are inserted.

Consider the simple network of figure 1a, (which could be part of a larger network) consisting of cell  $c$  and its in-neighborhood. We have cell types  $T = \{1, 2\}$  which

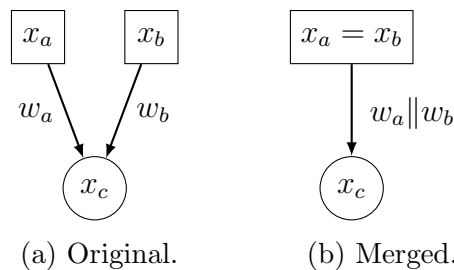

Figure 1: Edge merging.

represent “circle” and “square” cells, respectively. In order to define functions on the cells we associate with them the state sets  $\mathbb{X}_1, \mathbb{X}_2$  and the output sets  $\mathbb{Y}_1, \mathbb{Y}_2$  according to their respective type.

We consider that the input received by a cell is independent of how we draw the network, that is, from the point of view of cell  $c$ , there would be no difference if cell  $b$  was at the left of cell  $a$ . Then, for a function  $\hat{f}_1$  acting on cells of type 1, we would expect that

$$\hat{f}_1 \left( x_c; \begin{bmatrix} w_a \\ w_b \end{bmatrix}, \begin{bmatrix} x_a \\ x_b \end{bmatrix} \right) = \hat{f}_1 \left( x_c; \begin{bmatrix} w_b \\ w_a \end{bmatrix}, \begin{bmatrix} x_b \\ x_a \end{bmatrix} \right),$$

for  $x_c \in \mathbb{X}_1$ ,  $x_a, x_b \in \mathbb{X}_2$  and  $w_a, w_b \in \mathcal{M}_{12}$ . Moreover, since cells  $a$  and  $b$  are of the same cell type (square) ( $\mathcal{T}(a) = \mathcal{T}(b) = 2$ ), we expect that when they are in the same state ( $x_a = x_b = x_{ab}$ ), the total input received by cell  $c$  at that instant, is the same as if both edges originated from a single “square” cell with that state, as in figure 1b. That is,

$$\hat{f}_1 \left( x_c; \begin{bmatrix} w_a \\ w_b \end{bmatrix}, \begin{bmatrix} x_{ab} \\ x_{ab} \end{bmatrix} \right) = \hat{f}_1 (x_c; w_a \| w_b, x_{ab}).$$

Although this might look inconsistent since the domains look mismatched, the following definition formalizes it in a rigorous way. Finally, when  $\hat{f}_1$  is evaluated at a cell it should only depend on the in-neighborhood of that cell. Therefore, if  $w_a = 0_{12}$ , cell  $c$  should not be directly influenced by cell  $a$ . That is,

$$\hat{f}_1 \left( x_c; \begin{bmatrix} 0_{12} \\ w_b \end{bmatrix}, \begin{bmatrix} x_a \\ x_b \end{bmatrix} \right) = \hat{f}_1 (x_c; w_b, x_b).$$

These ideas are now formalized in the following definition.

**Definition 2.2.** Consider the set of cell types  $T$ , and some related sets  $\{\mathbb{X}_j, \mathbb{Y}_j\}_{j \in T}$  together with a family of commutative monoids  $\{\mathcal{M}_{ij}\}_{j \in T}$ , for a given fixed  $i \in T$ . Take a function  $\hat{f}_i$  defined on

$$\hat{f}_i: \mathbb{X}_i \times \bigcup_{\mathbf{k} \geq \mathbf{0}_{|T|}} (\mathcal{M}_i^{\mathbf{k}} \times \mathbb{X}^{\mathbf{k}}) \rightarrow \mathbb{Y}_i, \quad (1)$$

where  $\bigcup$  denotes the disjoint union and for multi-index  $\mathbf{k}$  we define  $\mathbb{X}^{\mathbf{k}} := \mathbb{X}_1^{k_1} \times \dots \times \mathbb{X}_{|T|}^{k_{|T|}}$  and  $\mathcal{M}_i^{\mathbf{k}} := \mathcal{M}_{i1}^{k_1} \times \dots \times \mathcal{M}_{i|T|}^{k_{|T|}}$ .

The function  $\hat{f}_i$  is called an **oracle component of type  $i$** , if it has the following properties:

(i) If  $\sigma$  is a **permutation** matrix (of appropriate dimension), then

$$\hat{f}_i(x; \mathbf{w}, \mathbf{x}) = \hat{f}_i(x; \sigma \mathbf{w}, \sigma \mathbf{x}), \quad (2)$$

where we assume, without loss of generality, that one can keep track of the cell types of each element of  $\sigma \mathbf{w}$  and  $\sigma \mathbf{x}$ .

(ii) If the indexes  $j_1, j_2$  and  $j_{12}$  denote cells of type  $j \in T$ , then

$$\hat{f}_i \left( x; \begin{bmatrix} w_{j_1} \| w_{j_2} \\ \mathbf{w} \end{bmatrix}, \begin{bmatrix} x_{j_{12}} \\ \mathbf{x} \end{bmatrix} \right) = \hat{f}_i \left( x; \begin{bmatrix} w_{j_1} \\ w_{j_2} \\ \mathbf{w} \end{bmatrix}, \begin{bmatrix} x_{j_{12}} \\ x_{j_{12}} \\ \mathbf{x} \end{bmatrix} \right). \quad (3)$$

(iii) If the index  $j$  denotes a cell of type  $j \in T$ , then

$$\hat{f}_i \left( x; \begin{bmatrix} 0_{ij} \\ \mathbf{w} \end{bmatrix}, \begin{bmatrix} x_j \\ \mathbf{x} \end{bmatrix} \right) = \hat{f}_i(x; \mathbf{w}, \mathbf{x}). \quad (4)$$

□

The disjoint union allows us to distinguish neighborhoods of different types. That is, even in the particular case of  $\mathbb{X}_1 = \mathbb{X}_2$  and  $\mathcal{M}_{i1} = \mathcal{M}_{i2}$ , we are able to differentiate the part of the domain associated with  $\mathcal{M}_{i1}^2 \times \mathbb{X}_1^2$  from the one associated with  $\mathcal{M}_{i1} \times \mathcal{M}_{i2} \times \mathbb{X}_1 \times \mathbb{X}_2$ . A non-disjoint union, on the other hand, would merge these sets together.

**Remark 2.** As stated in item  $i$  of definition 2.2, it is always assumed that given any weight  $w_c$  or state  $x_c$ , we always know the cell type of the corresponding cell  $c$ . Note that one can always do enough bookkeeping in order to ensure this. For instance, one can extend  $\hat{f}_i(x; \mathbf{w}, \mathbf{x})$  into  $\hat{f}_i(x; \mathbf{t}, \mathbf{w}, \mathbf{x})$ , where  $\mathbf{t}$  would be a vector that encodes the cell types associated with  $\mathbf{w}, \mathbf{x}$ . Then, we would have  $\hat{f}_i(x; \mathbf{t}, \mathbf{w}, \mathbf{x}) = \hat{f}_i(x; \sigma \mathbf{t}, \sigma \mathbf{w}, \sigma \mathbf{x})$  instead. Our implicit bookkeeping means that we do not have to constrain  $\sigma$  to preserve cell typing. That is, if we assume some canonical order of the cell types in the part of the domain  $\mathcal{M}_i^{\mathbf{k}} \times \mathbb{X}^{\mathbf{k}}$  in (1), then we know the correct  $\mathbf{k} \geq \mathbf{0}_{|T|}$  and can reorder the rows of  $\mathbf{w}$  and  $\mathbf{x}$  in  $\hat{f}_i(x; \mathbf{w}, \mathbf{x})$  appropriately.

Note that by considering invariance under general permutations, and not having to worry about preserving cell types or respecting some canonical ordering of cell types, we are always able to shift the cells of major interest to the top of the vectors, as in (3),(4), regardless of the types of other cells. □

We consider the function  $\mathcal{K}$  such that for a set of cells  $\mathbf{s}$ , we have that  $\mathbf{k} = \mathcal{K}(\mathbf{s})$  is the  $|T|$ -tuple such that  $k_i$  is the number of cells in  $\mathbf{s}$  that are of type  $i \in T$ . This allows us to pick the proper  $\mathbf{k} \geq \mathbf{0}_{|T|}$  in (1) when we want to evaluate oracle components at a cell and its in-neighbors.

The **oracle set** is the set of all  $|T|$ -tuples of oracle components, such that each element of the tuple represents one of the types in  $T$ . It is denoted as

$$\hat{\mathcal{F}}_T = \prod_{i \in T} \hat{\mathcal{F}}_i,$$

where  $\hat{\mathcal{F}}_i$  is the set of all oracle components of type  $i$ . We are always implicitly assuming sets  $\{\mathbb{X}_i, \mathbb{Y}_i\}_{i \in T}$  and commutative monoids  $\{\mathcal{M}_{ij}\}_{i,j \in T}$ . Note that modeling some aspect of a network that follows our assumptions is effectively choosing one of the elements of  $\hat{\mathcal{F}}_T$ , which we call **oracle functions**.

**Definition 2.3.** Consider a network  $\mathcal{G}$  on a cell set  $\mathcal{C}$  with cell types in  $T$  according to the cell type partition  $\mathcal{T}$ , and an in-adjacency matrix  $M$ . Assume without loss of generality that the cells are ordered according to the cell types such that we can associate with the network a state  $\mathbb{X} := \mathbb{X}^{\mathbf{k}}$  and output  $\mathbb{Y} := \mathbb{Y}^{\mathbf{k}}$  sets, with  $\mathbf{k} = \mathcal{K}(\mathcal{C})$ .

A function  $f: \mathbb{X} \rightarrow \mathbb{Y}$ , given as

$$f = (f_c)_{c \in \mathcal{C}}, \quad \text{with } f_c: \mathbb{X} \rightarrow \mathbb{Y}_i, \quad i = \mathcal{T}(c),$$

is said to be  **$\mathcal{G}$ -admissible** if there is some oracle function  $\hat{f} \in \hat{\mathcal{F}}_T$ ,  $\hat{f} = (\hat{f}_i)_{i \in T}$  such that

$$f_c(\mathbf{x}) = \hat{f}_i(x_c; \mathbf{m}_c^\top, \mathbf{x}), \quad (5)$$

for  $\mathbf{x} \in \mathbb{X}$ , where  $x_c$  is the  $c^{\text{th}}$  coordinate of  $\mathbf{x}$  and  $\mathbf{m}_c$  is the  $c^{\text{th}}$  row of matrix  $M$ . In this case we write  $f = \hat{f}|_{\mathcal{G}}$ .  $\square$

The set of all  $\mathcal{G}$ -admissible functions is denoted as  $\mathcal{F}_{\mathcal{G}}$ . It can be thought of as the result of evaluating  $\hat{\mathcal{F}}_T$  at  $\mathcal{G}$ , which can be written as  $\hat{\mathcal{F}}_T|_{\mathcal{G}}$ . Note that process of evaluating oracle functions at a network is not necessarily injective. There might be oracle functions  $\hat{f}, \hat{g} \in \hat{\mathcal{F}}_T$  with  $\hat{f} \neq \hat{g}$  such that  $\hat{f}|_{\mathcal{G}} = \hat{g}|_{\mathcal{G}}$ .

The next example makes explicit the relation between the connectivity graph of a network and how that constrains any possible admissible function that acts on it.

**Example 2.1.** Figure 2 shows an example of a **CCN** of three cells. We have cell types  $T = \{1, 2\}$  which represent “circle” and “square” cells, respectively. This **CCN**

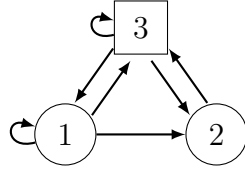

Figure 2: Simple network with admissible functions that have the structure given by (7),(8),(9).

can be described by the in-adjacency matrix  $M$

$$M = \begin{bmatrix} 1 & 0 & 1 \\ 1 & 0 & 1 \\ 1 & 1 & 1 \end{bmatrix}, \quad (6)$$

together with the cell type partition  $\mathcal{T} = \{\{1, 2\}, \{3\}\}$ . This means that a suitable  $f \in \mathcal{F}_{\mathcal{G}}$  should have the following structure

$$f_1(\mathbf{x}) = \hat{f}_1(x_1; \begin{bmatrix} 1 & 0 & 1 \end{bmatrix}^\top, \mathbf{x}), \quad (7)$$

$$f_2(\mathbf{x}) = \hat{f}_1(x_2; \begin{bmatrix} 1 & 0 & 1 \end{bmatrix}^\top, \mathbf{x}), \quad (8)$$

$$f_3(\mathbf{x}) = \hat{f}_2(x_3; \begin{bmatrix} 1 & 1 & 1 \end{bmatrix}^\top, \mathbf{x}), \quad (9)$$

for some  $\hat{f} \in \hat{\mathcal{F}}_T$ .  $\square$

### 3. Equality-based synchronism

In this section, we concern ourselves with patterns of synchronism defined by equalities between the states of cells. Such a set of equalities establishes an equivalence relation, which we encode through the use of partitions on the set of cells.

### 3.1. Partitions and their representations

A partition  $\mathcal{A}$  on a set of cells  $\mathcal{C}$  is a set of non-empty subsets of  $\mathcal{C}$  such that they are pairwise disjoint and their union is equal to  $\mathcal{C}$ . We often refer to each element of a given partition (corresponding to a subset of cells) by the term **color**. The number of colors in a partition is called its **rank**.

We construct the **quotient set**  $\mathcal{C}/\mathcal{A}$  by taking the elements of  $\mathcal{C}$  and merging them together according to  $\mathcal{A}$ , such that each color of  $\mathcal{A}$  is associated with an element of  $\mathcal{C}/\mathcal{A}$ . We can now think of  $\mathcal{A}$  as a function from  $\mathcal{C}$  to  $\mathcal{C}/\mathcal{A}$ , which we illustrate in the following example.

**Example 3.1.** Consider the set of cells  $\mathcal{C} = \{a, b, c, d, e\}$ . Then,  $\mathcal{A} = \{\{a, b\}, \{c\}, \{d, e\}\}$  is a partition on  $\mathcal{C}$  with three colors ( $\text{rank}(\mathcal{A}) = 3$ ). We denote the quotient set as  $\mathcal{C}/\mathcal{A} = \{ab, c, de\}$ , which contains three elements. Then,  $\mathcal{A}$  acts as function in  $\mathcal{C} \rightarrow \mathcal{C}/\mathcal{A}$ , and we write  $\mathcal{A}(a) = \mathcal{A}(b) = ab$ ,  $\mathcal{A}(c) = c$  and  $\mathcal{A}(d) = \mathcal{A}(e) = de$ .  $\square$

**Remark 3.** In the example above it might look more canonical to think of the elements of  $\mathcal{C}/\mathcal{A}$  as  $ab := \{a, b\}$ ,  $c := \{c\}$  and  $de := \{d, e\}$ . That is, each of its elements is a color according to partition  $\mathcal{A}$ . However, using this notation,  $\mathcal{A}$  and  $\mathcal{C}/\mathcal{A}$  would look indistinguishable. We want to think of these objects as semantically different. While we think of a partition  $\mathcal{A}$  as a set of sets of elements (cells), we think of  $\mathcal{C}/\mathcal{A}$  as just a set of elements, (which are colors, and therefore end up being sets themselves). In order to make this clear we use this shorthand notation. This becomes more important when we compose partitions (e.g., we apply a partition on the set  $\mathcal{C}/\mathcal{A}$ ) and define the concept of partition quotients.  $\square$

Interpreting partitions as functions allows us to say that two cells  $c, d \in \mathcal{C}$  are of the same color, according to  $\mathcal{A}$ , if and only if  $\mathcal{A}(c) = \mathcal{A}(d)$ . Furthermore, they are surjective functions by construction and each color is given by the preimage of each element of  $\mathcal{C}/\mathcal{A}$ . Conversely, note that every surjective function establishes a partition on its domain through its level sets.

Given two partitions  $\mathcal{A}, \mathcal{B}$  on a set of cells  $\mathcal{C}$ , we say that  $\mathcal{A}$  is **finer** than  $\mathcal{B}$ , denoted as  $\mathcal{A} \leq \mathcal{B}$ , if

$$\mathcal{A}(c) = \mathcal{A}(d) \implies \mathcal{B}(c) = \mathcal{B}(d) \quad (10)$$

for all  $c, d \in \mathcal{C}$ . Conversely,  $\mathcal{B}$  is said to be **coarser** than  $\mathcal{A}$ . Roughly speaking, (10) means that if any pair of cells have the same color according to partition  $\mathcal{A}$ , then they also have the same color according to  $\mathcal{B}$ . In other words, if we merge some of the colors of  $\mathcal{A}$  together, we can obtain  $\mathcal{B}$ . Conversely, we can obtain  $\mathcal{A}$  by starting with  $\mathcal{B}$  and splitting some of its colors into smaller ones. The **trivial** partition, in which each color consists of a single cell, is the **finest** and its rank is  $|\mathcal{C}|$ . We now show that if  $\mathcal{A} \leq \mathcal{B}$  we can define a **quotient partition**  $\mathcal{B}/\mathcal{A}$ .

**Lemma 3.1.** Consider a set of cells  $\mathcal{C}$  and the partitions  $\mathcal{A} : \mathcal{C} \rightarrow \mathcal{C}/\mathcal{A}$  and  $\mathcal{B} : \mathcal{C} \rightarrow \mathcal{C}/\mathcal{B}$ . Then,  $\mathcal{A} \leq \mathcal{B}$  if and only if there is some  $\mathcal{B}/\mathcal{A} : \mathcal{C}/\mathcal{A} \rightarrow \mathcal{C}/\mathcal{B}$  such that  $\mathcal{B}/\mathcal{A} \circ \mathcal{A} = \mathcal{B}$ .  $\square$



*Proof.* Note that  $\mathcal{B}/\mathcal{A} \circ \mathcal{A} = \mathcal{B}$  means that  $\mathcal{B}/\mathcal{A}(\mathcal{A}(c)) = \mathcal{B}(c)$  for all  $c \in \mathcal{C}$ . This means that  $\mathcal{B}/\mathcal{A}$  is the function that maps  $\mathcal{A}(c) \in \mathcal{C}/\mathcal{A}$  into  $\mathcal{B}(c) \in \mathcal{C}/\mathcal{B}$  for all  $c \in \mathcal{C}$ . Note that this is enough to define  $\mathcal{B}/\mathcal{A}$  on its whole domain since  $\mathcal{A}$  is surjective. That is, for every element  $k \in \mathcal{C}/\mathcal{A}$  there is some  $c \in \mathcal{C}$  such that  $\mathcal{A}(c) = k$ . Finally,  $\mathcal{B}/\mathcal{A}$  exists if and only if such a function is well-defined. That is, for every  $k \in \mathcal{C}/\mathcal{A}$ , the mapping of  $k = \mathcal{A}(c)$  into  $\mathcal{B}(c)$  has to be completely independent of the particular choice of  $c \in \mathcal{C}$ , which is equivalent to  $\mathcal{A} \leq \mathcal{B}$ . ■

In particular, if  $\mathcal{A} \leq \mathcal{B}$ , the partition  $\mathcal{B}/\mathcal{A}$  describes how to merge the colors of  $\mathcal{A}$  into the colors of  $\mathcal{B}$ . Furthermore, note that  $\mathcal{B}/\mathcal{A}$  is uniquely defined and is also surjective. If we consider the particular case  $\mathcal{B} = \mathcal{A}$ , then we have that  $\mathcal{A}/\mathcal{A} : \mathcal{C}/\mathcal{A} \rightarrow \mathcal{C}/\mathcal{A}$  is such that  $\mathcal{A}/\mathcal{A} \circ \mathcal{A} = \mathcal{A}$ . That is,  $\mathcal{A}/\mathcal{A}$  acts as the identity map in the set  $\mathcal{C}/\mathcal{A}$  and it is the trivial partition in that set.

**Example 3.2.** Consider the set of cells  $\mathcal{C} = \{a, b, c, d, e\}$  on which we define the partitions  $\mathcal{A} = \{\{a, b\}, \{c\}, \{d, e\}\}$   $\mathcal{B} = \{\{a, b\}, \{c, d, e\}\}$ . We denote the quotient sets as  $\mathcal{C}/\mathcal{A} = \{ab, c, de\}$  and  $\mathcal{C}/\mathcal{B} = \{ab, cde\}$ . Consider that the mappings  $\mathcal{A} : \mathcal{C} \rightarrow \mathcal{C}/\mathcal{A}$  and  $\mathcal{B} : \mathcal{C} \rightarrow \mathcal{C}/\mathcal{B}$  are defined in the expected way. Then, since we have  $\mathcal{A} \leq \mathcal{B}$ , the quotient partition  $\mathcal{B}/\mathcal{A} : \mathcal{C}/\mathcal{A} \rightarrow \mathcal{C}/\mathcal{B}$  is such that  $\mathcal{B}/\mathcal{A}(ab) = ab$  and  $\mathcal{B}/\mathcal{A}(c) = \mathcal{B}/\mathcal{A}(de) = cde$ . Using the set of colors notation, we can write  $\mathcal{B}/\mathcal{A} = \{\{ab\}, \{c, de\}\}$ . Finally, note that  $\text{rank}(\mathcal{B}/\mathcal{A}) = \text{rank}(\mathcal{B}) = 2$ . □

It should be clear that  $\text{rank}(\mathcal{B}/\mathcal{A}) = \text{rank}(\mathcal{B})$  is true in general, since it always corresponds to the size of their common image set  $\mathcal{C}/\mathcal{B}$ .

**Lemma 3.2.** The partition quotient preserves the partial order relation  $\leq$ . That is, for all partitions  $\mathcal{A}, \mathcal{B}_1, \mathcal{B}_2$  on  $\mathcal{C}$  such that  $\mathcal{A} \leq \mathcal{B}_1, \mathcal{B}_2$ , we have that  $\mathcal{B}_1 \leq \mathcal{B}_2$  if and only if  $\mathcal{B}_1/\mathcal{A} \leq \mathcal{B}_2/\mathcal{A}$ . □

*Proof.* Firstly, note that  $\mathcal{B}_1/\mathcal{A}$  and  $\mathcal{B}_2/\mathcal{A}$  are both partitions on the set  $\mathcal{C}/\mathcal{A}$ , therefore the statement  $\mathcal{B}_1/\mathcal{A} \leq \mathcal{B}_2/\mathcal{A}$  is meaningful.

Since we have that  $\mathcal{A} \leq \mathcal{B}_1, \mathcal{B}_2$  from assumption, we can, using lemma 3.1, write  $\mathcal{B}_1 \leq \mathcal{B}_2$  as  $\mathcal{B}_1/\mathcal{A}(\mathcal{A}(c)) = \mathcal{B}_1/\mathcal{A}(\mathcal{A}(d)) \implies \mathcal{B}_2/\mathcal{A}(\mathcal{A}(c)) = \mathcal{B}_2/\mathcal{A}(\mathcal{A}(d))$  for all  $c, d \in \mathcal{C}$ .

We have to show that this is equivalent to  $\mathcal{B}_1/\mathcal{A}(k) = \mathcal{B}_1/\mathcal{A}(l) \implies \mathcal{B}_2/\mathcal{A}(k) = \mathcal{B}_2/\mathcal{A}(l)$  for all  $k, l \in \mathcal{C}/\mathcal{A}$ . The forward direction comes from the fact that  $\mathcal{A}$  is surjective. That is, for all  $k, l \in \mathcal{C}/\mathcal{A}$  there are some  $c, d \in \mathcal{C}$  such that  $\mathcal{A}(c) = k$  and  $\mathcal{A}(d) = l$ . The backwards direction is immediate from the fact that for all  $c, d \in \mathcal{C}$ , we have that  $\mathcal{A}(c), \mathcal{A}(d) \in \mathcal{C}/\mathcal{A}$ . ■

It is often convenient to establish an order on a set of cells. That is, to associate with each cell a distinct integer from 1 to  $n$ , where  $n$  is the size of that set. We now see that this allows us to represent partitions using matrices.

Consider we identify  $\mathcal{C}$  with  $\{1, \dots, |\mathcal{C}|\}$  and  $\mathcal{C}/\mathcal{A}$  with  $\{1, \dots, |\mathcal{C}/\mathcal{A}|\}$ . Then, we can represent a partition  $\mathcal{A} : \mathcal{C} \rightarrow \mathcal{C}/\mathcal{A}$  through a **partition matrix** (also called characteristic matrix)  $P \in \{0, 1\}^{|\mathcal{C}| \times |\mathcal{C}/\mathcal{A}|}$ , such that  $[P]_{ck} = 1$  if  $\mathcal{A}(c) = k$  and  $[P]_{ck} = 0$

otherwise. That is, rows corresponds to the cells and columns correspond to the colors, with 1 encoding that the cell of that row maps into the color associated with that column. This is illustrated in the following example.

**Example 3.3.** Consider the same sets of cells and partitions as in example 3.2. For  $\mathcal{C}$  we use the indexing  $(a, b, c, d, e) = (1, 2, 3, 4, 5)$ , for  $\mathcal{C}/\mathcal{A}$  we index  $(ab, c, de) = (1, 2, 3)$ , and we index  $\mathcal{C}/\mathcal{B}$  according to  $(ab, cde) = (2, 1)$ . Note that we indexed  $ab$  differently as a member of  $\mathcal{C}/\mathcal{A}$  than as a member of  $\mathcal{C}/\mathcal{B}$ . This is not an issue since an ordering is a property within a given set, not something intrinsic to an element. Using the mentioned indexing, the partitions  $\mathcal{A}, \mathcal{B}, \mathcal{B}/\mathcal{A}$  are represented through the partition matrices  $P_{\mathcal{A}}, P_{\mathcal{A}}, P_{\mathcal{B}/\mathcal{A}}$ , which are given by

$$P_{\mathcal{A}} = \begin{bmatrix} 1 & 0 & 0 \\ 1 & 0 & 0 \\ 0 & 1 & 0 \\ 0 & 0 & 1 \\ 0 & 0 & 1 \end{bmatrix}, \quad P_{\mathcal{B}} = \begin{bmatrix} 0 & 1 \\ 0 & 1 \\ 1 & 0 \\ 1 & 0 \\ 1 & 0 \end{bmatrix}, \quad P_{\mathcal{B}/\mathcal{A}} = \begin{bmatrix} 0 & 1 \\ 1 & 0 \\ 1 & 0 \end{bmatrix}.$$

□

Note that these matrices are related by  $P_{\mathcal{A}}P_{\mathcal{B}/\mathcal{A}} = P_{\mathcal{B}}$ . This is equivalent to  $\mathcal{B}/\mathcal{A} \circ \mathcal{A} = \mathcal{B}$ . It is more clear that these formulas are analogous if we consider the transposed version  $P_{\mathcal{B}/\mathcal{A}}^{\top}P_{\mathcal{A}}^{\top} = P_{\mathcal{B}}^{\top}$ . In this work, we considered it more useful to define partition matrices the way we did instead of the transposed alternative.

Note that given a partition  $\mathcal{A}$ , we can index its related sets  $\mathcal{C}$  and  $\mathcal{C}/\mathcal{A}$  in different ways. This means that  $\mathcal{A}$  can be represented by multiple partition matrices that are related to each other by a reordering of rows and columns. This is not an issue as long as we keep things consistent by always using the same assigned ordering when constructing other partition matrices that also involve  $\mathcal{C}$  and  $\mathcal{C}/\mathcal{A}$ .

We will often use the partition and its matrix interchangeably, that is,  $P_{\mathcal{A}} \leq \mathcal{B}$  or  $P_{\mathcal{A}} \leq P_{\mathcal{B}}$  to mean  $\mathcal{A} \leq \mathcal{B}$ .

Note that given partition matrices  $P_{\mathcal{A}}, P_{\mathcal{B}}$  such that  $P_{\mathcal{A}} \leq P_{\mathcal{B}}$ , we have, from assumption, already assigned an ordering on all the relevant sets  $\mathcal{C}, \mathcal{C}/\mathcal{A}$  and  $\mathcal{C}/\mathcal{B}$ . Therefore, there exists an unique partition matrix  $P_{\mathcal{A}\mathcal{B}}$ , representing  $\mathcal{B}/\mathcal{A}$  such that  $P_{\mathcal{A}}P_{\mathcal{B}/\mathcal{A}} = P_{\mathcal{B}}$ .

The trivial partition can be represented by any  $|\mathcal{C}| \times |\mathcal{C}|$  permutation matrix, one of which is the identity.

The rank of a partition corresponds to the rank of any of its matrix representations. That is,  $\text{rank}(\mathcal{A}) = \text{rank}(P_{\mathcal{A}})$ .

Note that given some matrix  $M$  of appropriate dimensions,  $PM$  is always well-defined as an expansion of  $M$ , where its rows get replicated. In the case of  $MP$ , we require the ability of summing elements of  $M$ . In our context, the sum operations will be the previously mentioned monoid sum operations  $\parallel$ .

### 3.2. Lattices of partitions

A lattice  $L$  is a partially ordered set such that given any two elements  $a, b \in L$ , there exists in  $L$  a **least upper bound** or **join** denoted by  $a \vee_L b$ . Similarly, there is in  $L$  a **greatest lower bound** or **meet** denoted by  $a \wedge_L b$ .

**Example 3.4.** Consider figure 3, where we represent two partially ordered sets  $L$  and  $S$ . We connect two different elements if and only if one is larger than the other (according to its assigned partial order  $\leq$ ) and they have no other element in-between. Furthermore, we present graphically the larger elements above the smaller terms. For instance, in figure 3b, we have that  $e \leq_L b$  and  $b \leq_L a$  so we connect them. However, we do not connect  $e - a$  despite  $e \leq_L a$  since  $b$  is in-between them. Note that  $L$  is a lattice since  $\vee_L$  and  $\wedge_L$  are well-defined for every pair of elements (e.g.,  $b \vee_L d = a$  and  $b \wedge_L d = f$ ). On the other hand,  $S$  does not have this property. Note that the set of elements larger than  $l$  and  $m$  is  $\{i, j, k\}$ . Out of these,  $j, k$  are both smaller than  $i$ , however, neither  $j \leq k$  nor  $k \leq j$ . That is, they are non-comparable. Since  $\{i, j, k\}$  does not have a smallest element,  $l \vee_S m$  is not defined, which means that  $S$  is not a lattice.  $\square$

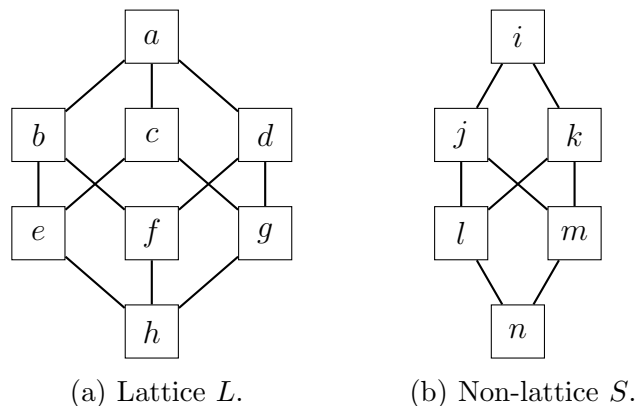

Figure 3: Partially ordered sets  $L, S$  such that  $L$  is a lattice and  $S$  is not a lattice.

In this work, we are only interested in lattices of partitions, partially ordered according to the finer ( $\leq$ ) relation, described in (10).

The set of all partitions on a finite set of cells  $\mathcal{C}$ , partially ordered by the finer ( $\leq$ ) relation, forms a **lattice**  $L_{\mathcal{C}}$ . In this set, the join ( $\vee$ ) and meet ( $\wedge$ ) operations can be calculated according to lemmas 3.3 and 3.4 respectively.

**Lemma 3.3.** *The partition given by  $\mathcal{A} = \mathcal{A}_1 \vee \mathcal{A}_2$  is such that  $\mathcal{A}(c) = \mathcal{A}(d)$  if and only if there is a chain of cells  $c = c_1, \dots, c_k = d$  such that, for each  $c_i, c_{i+1}$ , with  $1 \leq i < k$ , we have either  $\mathcal{A}_1(c_i) = \mathcal{A}_1(c_{i+1})$  or  $\mathcal{A}_2(c_i) = \mathcal{A}_2(c_{i+1})$ .  $\square$*

*Proof.* Any partition  $\mathcal{A}$  that is simultaneous coarser than  $\mathcal{A}_1$  and  $\mathcal{A}_2$  has to obey (from

(10))

$$\begin{cases} \mathcal{A}_1(c) = \mathcal{A}_1(d) \\ \text{or} \\ \mathcal{A}_2(c) = \mathcal{A}_2(d) \end{cases} \implies \mathcal{A}(c) = \mathcal{A}(d).$$

For such partition, any chain of cells  $c = c_1, \dots, c_k = d$  such that, for each  $c_i, c_{i+1}$ , with  $1 \leq i < k$ , either  $\mathcal{A}_1(c_i) = \mathcal{A}_1(c_{i+1})$  or  $\mathcal{A}_2(c_i) = \mathcal{A}_2(c_{i+1})$ , implies that  $\mathcal{A}(c) = \mathcal{A}(d)$ . The finest such partition  $\mathcal{A}$  is the one such that  $\mathcal{A}(c) = \mathcal{A}(d)$  if and only if there is such a chain. Note that the existence of such chains induces an equivalence relation on the set of cells. Therefore, this defines a valid partition. ■

**Lemma 3.4.** *The partition given by  $\mathcal{A} = \mathcal{A}_1 \wedge \mathcal{A}_2$  is such that  $\mathcal{A}(c) = \mathcal{A}(d)$  if and only if  $\mathcal{A}_1(c) = \mathcal{A}_1(d)$  and  $\mathcal{A}_2(c) = \mathcal{A}_2(d)$ . □*

*Proof.* Any partition  $\mathcal{A}$  that is simultaneous finer than  $\mathcal{A}_1$  and  $\mathcal{A}_2$  has to obey (from (10))

$$\mathcal{A}(c) = \mathcal{A}(d) \implies \begin{cases} \mathcal{A}_1(c) = \mathcal{A}_1(d), \\ \mathcal{A}_2(c) = \mathcal{A}_2(d). \end{cases}$$

The coarsest such partition is created by making the implication into an equivalence. This induces an equivalence relation on the set of cells. Therefore, it defines a valid partition. ■

Not every subset of partitions forms a lattice. Furthermore, subsets of lattices that are themselves lattices might not be sublattices of the original lattice. That is, their join and meet operations might be different. With regard to lattices of partitions, either the join will be coarser than in lemma 3.3 or the meet will be finer than in lemma 3.4 (or both).

Denote by  $L_{\mathcal{T}}$  the subset of  $L_{\mathcal{C}}$  consisting on the partitions of  $\mathcal{C}$  that are finer than  $\mathcal{T}$ . Note that  $L_{\mathcal{T}}$  remains closed under the same join ( $\vee$ ) and meet ( $\wedge$ ) operations. Therefore,  $L_{\mathcal{T}}$  is a sublattice of  $L_{\mathcal{C}}$ .

All the lattices in this work are bounded, which means that they have a (**maximum/greatest element/top**), denoted by  $\top$  and a (**minimum/least element/bottom**), denoted by  $\perp$ . In particular, the top partitions of  $L_{\mathcal{C}}$  and  $L_{\mathcal{T}}$  are  $\top_{\mathcal{C}} = \{\mathcal{C}\}$  and  $\top_{\mathcal{T}} = \mathcal{T}$ , respectively. The bottom elements  $\perp_{\mathcal{C}} = \perp_{\mathcal{T}}$  are given by the trivial partition.

We now show that the existence of a minimal element together with a join operation is enough to guarantee that a finite set forms a lattice.

**Lemma 3.5.** *Consider a finite partially ordered ( $\leq_L$ ) set  $L$  such that there is a minimal element  $\perp_L \in L$  and for every pair  $\mathcal{A}_1, \mathcal{A}_2 \in L$ , there exists an element denoted  $\mathcal{A}_1 \vee_L \mathcal{A}_2$  which is their least upper bond in  $L$ . Then,  $L$  is a lattice. □*

*Proof.* Consider any pair of elements  $\mathcal{A}_1, \mathcal{A}_2 \in L$ . Call  $S$  the subset of  $L$  of the elements that are simultaneously smaller ( $\leq_L$ ) than  $\mathcal{A}_1$  and  $\mathcal{A}_2$ . That is,  $S := \{\mathcal{P} \in L : \mathcal{P} \leq_L \mathcal{A}_1, \mathcal{A}_2\}$ . Note that  $S$  is finite. Furthermore, it is not empty since  $\perp_L \in S$ . Then, to obtain the largest element of  $S$  we apply the join ( $\vee_L$ ) operation over the whole set, obtaining  $\mathcal{B} = \bigvee_{\mathcal{P} \in S}^L \mathcal{P}$ . From assumption, the result is in  $L$ . Furthermore, since all the elements of  $S$  are smaller than  $\mathcal{A}_1$  and  $\mathcal{A}_2$ , then  $\mathcal{B}$  is smaller as well. Therefore,  $\mathcal{B} \in S$ . By construction,  $\mathcal{B}$  is larger than every other element of  $S$ , therefore, it is an upper bound of  $S$ . That is,  $\mathcal{B} \in S$  is the greatest lower bound of  $\mathcal{A}_1, \mathcal{A}_2$  in  $L$ , which we denote by  $\mathcal{A}_1 \wedge_L \mathcal{A}_2$ , which means that  $L$  is a lattice. ■

In this work, we have particular interest in lattices of partitions  $L$  in which the bottom partition is the trivial one ( $\perp_L = \perp$ ) and the join is given according to lemma 3.3 ( $\vee_L = \vee$ ).

**Lemma 3.6.** *Consider a lattice of partitions  $L \subseteq L_{\mathcal{T}}$  such that  $\perp_L = \perp$  and  $\vee_L = \vee$ . Then, given any partition  $\mathcal{A} \in L_{\mathcal{T}}$ , there is a partition  $\mathcal{B} \in L$  that is the coarsest one in  $L$  such that  $\mathcal{B} \leq \mathcal{A}$ . □*

*Proof.* Call  $S$  the subset of  $L$  of the elements that are finer ( $\leq$ ) than  $\mathcal{A}$ . That is,  $S := \{\mathcal{P} \in L : \mathcal{P} \leq \mathcal{A}\}$ . Note that  $S$  is finite. Furthermore, it is not empty since  $\perp \in S$ . Then, to obtain the coarsest element of  $S$  we apply the join ( $\vee_L = \vee$ ) operation over the whole set, obtaining  $\mathcal{B} = \bigvee_{\mathcal{P} \in S} \mathcal{P}$ . Then,  $\mathcal{B} \in L$ . Furthermore, due to the fact that  $L \subseteq L_{\mathcal{T}}$  and  $\vee_L = \vee$ , we know that all the elements of  $S$  being finer than  $\mathcal{A}$  implies that  $\mathcal{B}$  is finer as well. Therefore,  $\mathcal{B} \in S$ . By construction,  $\mathcal{B}$  is coarser than every other element of  $S$ , therefore it is an upper bound of  $S$ . That is,  $\mathcal{B} \in S$  is the greatest lower bound of  $\mathcal{A}$  in  $L$ . ■

**Remark 4.** *Note that lemma 3.6 only holds because we have that  $\perp_L = \perp$  and  $\vee_L = \vee$ . If  $\perp_L \neq \perp$ , then it would not work for any  $\mathcal{A} < \perp_L$  (or non-comparable). Furthermore, note that  $\mathcal{A}_1, \mathcal{A}_2 \leq \mathcal{A}$  only implies  $\mathcal{A}_1 \vee_L \mathcal{A}_2 \leq \mathcal{A}$  if those partitions are all in the lattice associated with  $\vee_L$ . The fact that  $\vee_L = \vee$  is what allows us to apply this implication with respect to the lattice  $L_{\mathcal{T}}$ . □*

The correspondence between partitions  $\mathcal{A} \in L_{\mathcal{T}}$  and  $\mathcal{B} \in L$  described in lemma 3.6 establishes a function in  $L_{\mathcal{T}} \rightarrow L$ , which we denote by  $cir_L$ .

We know from lemma 3.5 that a set  $L$  with a minimal partition  $\perp_L$  and a join  $\vee_L$  is automatically a lattice, therefore, it has a meet operation  $\wedge_L$ . Furthermore, in the case that  $L$  is a lattice of partitions such that  $\perp_L = \perp$  and  $\vee_L = \vee$ , it is not guaranteed that  $\wedge_L = \wedge$ . We know, however, that  $\mathcal{A}_1 \wedge_L \mathcal{A}_2 \leq \mathcal{A}_1 \wedge \mathcal{A}_2$ . Then, using  $cir_L$ , it is clear how to write  $\wedge_L$  as a function of  $\wedge$ .

**Corollary 3.1.** *Consider a lattice of partitions  $L \subseteq L_{\mathcal{T}}$  such that  $\perp_L = \perp$  and  $\vee_L = \vee$ . Then, given partitions  $\mathcal{A}_1, \mathcal{A}_2 \in L$ , we have that  $\mathcal{A}_1 \wedge_L \mathcal{A}_2 = cir_L(\mathcal{A}_1 \wedge \mathcal{A}_2)$ . □*

Note that the meet operation  $\wedge_L$  is only meaningful when applied to elements of  $L$  while  $cir_L$  can be applied to any element of  $L_{\mathcal{T}}$ .

We now illustrate the  $cir_L$  operation in the following example.

**Example 3.5.** In figure 4a we have the lattice of all partitions finer than  $\mathcal{T} = \{\{1, 2, 3\}, \{4, 5\}\}$  and in figure 4b we have some lattice  $L$ , which contains the trivial partition  $\perp$  and is closed under the partition join  $\vee$ . We present the partitions in a simplified manner such that singletons do not appear, which correspond to cells that are not synchronized with any other cell (e.g., the partition  $\{\{1, 2\}, \{3\}, \{4, 5\}\}$  is simply represented as 12/45). The lattices are colored such that each element of  $L_{\mathcal{T}}$  is of the same color of the element of  $L$  that  $\text{cir}_L$  maps to.  $\square$

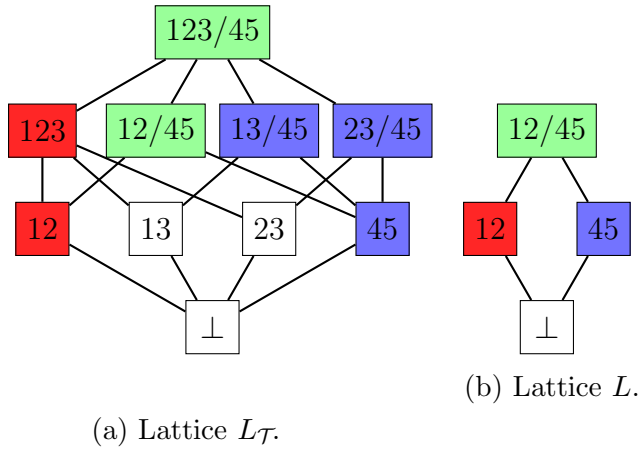

Figure 4: Illustration of a  $\text{cir}_L$  function over a suitable lattice of partitions  $L$ .

### 3.3. Lattice quotients

In this section, we define the quotient operation on sets of partitions. In particular, we show that for lattices of partitions  $L$  with the properties we are interested in ( $\vee_L = \vee$  and  $\perp_L = \perp$ ), all these properties are preserved under the quotient operation.

**Definition 3.1.** Consider a set of partitions  $L$  on some set of cells  $\mathcal{C}$ . Then, for some  $\mathcal{A} \in L$ , we define the quotient  $L/\mathcal{A}$  as the set of elements of the form  $\mathcal{B}/\mathcal{A}$ , for all  $\mathcal{B} \in L$  such that  $\mathcal{A} \leq \mathcal{B}$ .  $\square$

**Remark 5.** Note that  $L/\mathcal{A}$ , which is a set of partitions defined on  $\mathcal{C}/\mathcal{A}$ , always contains the trivial partition on that set (consider  $\mathcal{B} = \mathcal{A}$ ).  $\square$

We now show that if  $L$  is a lattice, then the quotient  $L/\mathcal{A}$  is also a lattice in its own right and its join and meet operations are induced from the join and meet of the original lattice  $L$ .

**Lemma 3.7.** Consider a lattice of partitions  $L$  and some partition  $\mathcal{A} \in L$ . Then,  $L/\mathcal{A}$  is also a lattice and its join ( $\vee_{L/\mathcal{A}}$ ) and meet ( $\wedge_{L/\mathcal{A}}$ ) operations are given by

$$(\mathcal{B}_1/\mathcal{A}) \vee_{L/\mathcal{A}} (\mathcal{B}_2/\mathcal{A}) = (\mathcal{B}_1 \vee_L \mathcal{B}_2)/\mathcal{A}, \quad (11a)$$

$$(\mathcal{B}_1/\mathcal{A}) \wedge_{L/\mathcal{A}} (\mathcal{B}_2/\mathcal{A}) = (\mathcal{B}_1 \wedge_L \mathcal{B}_2)/\mathcal{A}, \quad (11b)$$

for any  $\mathcal{B}_1, \mathcal{B}_2 \in L$  such that  $\mathcal{A} \leq \mathcal{B}_1, \mathcal{B}_2$ , or equivalently, for any  $\mathcal{B}_1/\mathcal{A}, \mathcal{B}_2/\mathcal{A} \in L/\mathcal{A}$ . Furthermore, its top ( $\top_{L/\mathcal{A}}$ ) and bottom ( $\perp_{L/\mathcal{A}}$ ) partitions are given by

$$\top_{L/\mathcal{A}} = \top_L/\mathcal{A}, \quad (12a)$$

$$\perp_{L/\mathcal{A}} = \mathcal{A}/\mathcal{A}. \quad (12b)$$

□

*Proof.* Consider any partition  $\mathcal{P}/\mathcal{A} \in L/\mathcal{A}$  such that  $\mathcal{P}/\mathcal{A} \geq \mathcal{B}_1/\mathcal{A}$  and  $\mathcal{P}/\mathcal{A} \geq \mathcal{B}_2/\mathcal{A}$ . From lemma 3.2, this is equivalent to saying that  $\mathcal{P} \geq \mathcal{B}_1$  and  $\mathcal{P} \geq \mathcal{B}_2$ . Since  $\mathcal{P}, \mathcal{B}_1, \mathcal{B}_2 \in L$ , this is equivalent to  $\mathcal{P} \geq \mathcal{B}_1 \vee_L \mathcal{B}_2$ . Once again from lemma 3.2, this is equivalent to  $\mathcal{P}/\mathcal{A} \geq (\mathcal{B}_1 \vee_L \mathcal{B}_2)/\mathcal{A}$ . Note that  $(\mathcal{B}_1 \vee_L \mathcal{B}_2)/\mathcal{A} \in L/\mathcal{A}$ . Furthermore,  $(\mathcal{B}_1 \vee_L \mathcal{B}_2)/\mathcal{A}$  is coarser than  $\mathcal{B}_1/\mathcal{A}$  and  $\mathcal{B}_2/\mathcal{A}$  and any partition that is coarser than them has to also be coarser than  $(\mathcal{B}_1 \vee_L \mathcal{B}_2)/\mathcal{A}$ . Then,  $(\mathcal{B}_1 \vee_L \mathcal{B}_2)/\mathcal{A}$  is the finest such partition, which means that it corresponds to the join ( $\vee_{L/\mathcal{A}}$ ) of  $L/\mathcal{A}$ , which proves (11a). Equation (11b) is proven in a completely analogous way.

Consider any partition  $\mathcal{P}/\mathcal{A} \in L/\mathcal{A}$ . Then, we have that  $\mathcal{P} \in L$  is such that  $\mathcal{A} \leq \mathcal{P} \leq \top_L$ . Then, from lemma 3.2, we have that  $\mathcal{A}/\mathcal{A} \leq \mathcal{P}/\mathcal{A} \leq \top_{L/\mathcal{A}}$ , which proves (12a) and (12b). ■

**Lemma 3.8.** Consider partitions  $\mathcal{A}, \mathcal{B}_1, \mathcal{B}_2$  such that  $\mathcal{A} \leq \mathcal{B}_1, \mathcal{B}_2$ . Then,

$$(\mathcal{B}_1/\mathcal{A}) \vee (\mathcal{B}_2/\mathcal{A}) = (\mathcal{B}_1 \vee \mathcal{B}_2)/\mathcal{A}. \quad (13)$$

□

*Proof.* Firstly, note that both sides describe partitions on the same set. Assume  $\mathcal{A}, \mathcal{B}_1, \mathcal{B}_2$  are partitions on a set of cells  $\mathcal{C}$ . Then,  $\mathcal{B}_1/\mathcal{A}$  and  $\mathcal{B}_2/\mathcal{A}$  are partitions on  $\mathcal{C}/\mathcal{A}$ , and so is their join. Therefore, the left hand side describes a partition on  $\mathcal{C}/\mathcal{A}$ . It is clear that the right hand side is also a partition on  $\mathcal{C}/\mathcal{A}$ .

In order to prove that the two partitions are the same, we show that two cells are of the same color in the partition of left hand side if and only if they are also of the same color in the partition of the right hand side. That is,

$$\begin{aligned} (\mathcal{B}_1/\mathcal{A}) \vee (\mathcal{B}_2/\mathcal{A})(k) &= (\mathcal{B}_1/\mathcal{A}) \vee (\mathcal{B}_2/\mathcal{A})(l) \iff \\ (\mathcal{B}_1 \vee \mathcal{B}_2)/\mathcal{A}(k) &= (\mathcal{B}_1 \vee \mathcal{B}_2)/\mathcal{A}(l) \end{aligned}$$

for all  $l, k \in \mathcal{C}/\mathcal{A}$ . From lemma 3.3,  $(\mathcal{B}_1/\mathcal{A}) \vee (\mathcal{B}_2/\mathcal{A})(k) = (\mathcal{B}_1/\mathcal{A}) \vee (\mathcal{B}_2/\mathcal{A})(l)$  is equivalent to the existence of a chain of cells  $k = k_1, \dots, k_n = l$  in  $\mathcal{C}/\mathcal{A}$  such that, for each  $k_i, k_{i+1}$ , with  $1 \leq i < n$ , we have either  $(\mathcal{B}_1/\mathcal{A})(k_i) = (\mathcal{B}_1/\mathcal{A})(k_{i+1})$  or  $(\mathcal{B}_2/\mathcal{A})(k_i) = (\mathcal{B}_2/\mathcal{A})(k_{i+1})$ . Note that  $k \in \mathcal{C}/\mathcal{A}$  if and only if there is some  $c \in \mathcal{C}$  such that  $\mathcal{A}(c) = k$ . Then, under some cell correspondence  $\mathcal{A}(c_i) = k_i$ , what we have is equivalent to saying that there is some chain of cells  $c = c_1, \dots, c_n = d$  in  $\mathcal{C}$  such that, for each  $c_i, c_{i+1}$ , with  $1 \leq i < n$ , we have either  $(\mathcal{B}_1/\mathcal{A})(\mathcal{A}(c_i)) = (\mathcal{B}_1/\mathcal{A})(\mathcal{A}(c_{i+1}))$  or  $(\mathcal{B}_2/\mathcal{A})(\mathcal{A}(c_i)) = (\mathcal{B}_2/\mathcal{A})(\mathcal{A}(c_{i+1}))$ . This simplifies into having that either  $\mathcal{B}_1(c_i) = \mathcal{B}_1(c_{i+1})$  or  $\mathcal{B}_2(c_i) = \mathcal{B}_2(c_{i+1})$ . Then, from lemma 3.3 again, this is equivalent to  $\mathcal{B}_1 \vee \mathcal{B}_2(c) = \mathcal{B}_1 \vee \mathcal{B}_2(d)$ . Since  $\mathcal{A} \leq \mathcal{B}_1, \mathcal{B}_2$  from assumption, it is always true that  $\mathcal{A} \leq$

$\mathcal{B}_1 \vee \mathcal{B}_2$ . Therefore, what we have is equivalent to  $(\mathcal{B}_1 \vee \mathcal{B}_2)/\mathcal{A}(\mathcal{A}(c)) = (\mathcal{B}_1 \vee \mathcal{B}_2)/\mathcal{A}(\mathcal{A}(d))$ . This simplifies into  $(\mathcal{B}_1 \vee \mathcal{B}_2)/\mathcal{A}(k) = (\mathcal{B}_1 \vee \mathcal{B}_2)/\mathcal{A}(l)$ , which completes the proof. ■

The following is now immediate from lemmas 3.7 and 3.8.

**Corollary 3.2.** *Consider a lattice of partitions  $L$ , some partition  $\mathcal{A} \in L$  and its respective quotient lattice  $L/\mathcal{A}$ . Then, for the joins of those lattices, we have that  $\vee_L = \vee$  with regard to partitions coarser than  $\mathcal{A}$ , if and only if  $\vee_{L/\mathcal{A}} = \vee$ . □*

In this work we have a particular interest in lattices of partitions that contain the trivial partition and whose join is determined by the partition join of lemma 3.3. We have shown that these properties are preserved under the lattice quotient operation. That is,

**Theorem 3.1.** *Consider a lattice of partitions  $L$  on a set of cells  $\mathcal{C}$ , such that  $\perp_L = \perp_{\mathcal{C}}$  and  $\vee_L = \vee$ . Then, given any partition  $\mathcal{A}_1 \in L$ , we have that  $L/\mathcal{A}$  is a lattice on the set  $\mathcal{C}/\mathcal{A}$  such that  $\perp_{L/\mathcal{A}} = \perp_{\mathcal{C}/\mathcal{A}}$  and  $\vee_{L/\mathcal{A}} = \vee$ . □*

We know from lemma 3.6 that lattices with these properties have *cir* functions associated to them. We now show how these functions are related.

**Lemma 3.9.** *Consider a lattice of partitions  $L$  such that  $\perp_L = \perp$  and  $\vee_L = \vee$ . Then, given some partition  $\mathcal{A} \in L$ , the lattice  $L/\mathcal{A}$  has a  $cir_{L/\mathcal{A}} : L_{\mathcal{T}}/\mathcal{A} \rightarrow L/\mathcal{A}$  function, which is related to the  $cir_L : L_{\mathcal{T}} \rightarrow L$  of the original lattice  $L$ . In particular, for every  $\mathcal{B}/\mathcal{A} \in L_{\mathcal{T}}/\mathcal{A}$ , we have that*

$$cir_{L/\mathcal{A}}(\mathcal{B}/\mathcal{A}) = cir_L(\mathcal{B})/\mathcal{A}. \quad (14)$$

□

*Proof.* Firstly, note that since we consider elements  $\mathcal{B}/\mathcal{A} \in L_{\mathcal{T}}/\mathcal{A}$ , we have that  $\mathcal{A} \leq \mathcal{B}$  from assumption.

Note that from definition,  $cir_L(\mathcal{B})$  is the maximal element of the set  $S := \{\mathcal{P} \in L : \mathcal{P} \leq \mathcal{B}\}$  (which we know exists from lemma 3.6). Then, since  $\mathcal{A} \in S$ , we have that  $cir_L(\mathcal{B}) \geq \mathcal{A}$ . Therefore,  $cir_L(\mathcal{B})/\mathcal{A} \in L/\mathcal{A}$  exists and it corresponds to the maximal element of  $S/\mathcal{A}$ .

On the other hand,  $cir_{L/\mathcal{A}}(\mathcal{B}/\mathcal{A})$  is by definition the maximal term of  $\{\mathcal{P}/\mathcal{A} \in L/\mathcal{A} : \mathcal{P}/\mathcal{A} \leq \mathcal{B}/\mathcal{A}\}$ , which is again the set  $S/\mathcal{A}$ , concluding the proof. ■

**Example 3.6.** *In figure 5a we have a lattice of partitions  $L$ , on a set of cells  $\mathcal{C} = \{1, 2, 3, 4\}$ , such that  $\perp_L = \perp_{\mathcal{C}}$  and  $\vee_L = \vee$ . Consider the partition  $\mathcal{A} = \{\{1\}, \{2, 4\}, \{3\}\}$ , which is in  $L$ . We denote the elements of the quotient set  $\mathcal{C}/\mathcal{A} = \{1, 24, 3\}$  and illustrate the quotient lattice  $L/\mathcal{A}$  in figure 5b. Note that  $L/\mathcal{A}$  is also such that  $\perp_{L/\mathcal{A}} = \perp_{\mathcal{C}/\mathcal{A}}$  and  $\vee_{L/\mathcal{A}} = \vee$ . □*

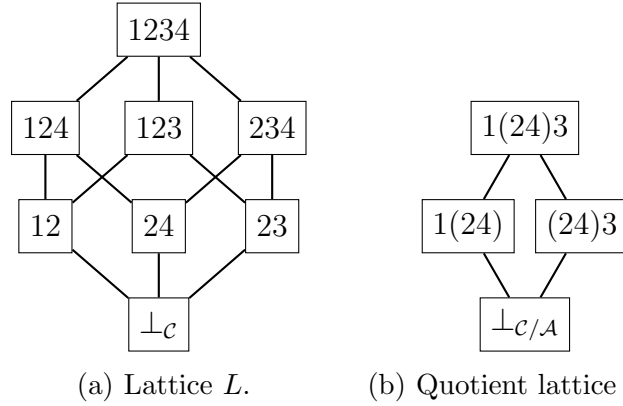

 Figure 5: Illustration of a lattice  $L$  and its quotient lattice  $L/\mathcal{A}$ .

### 3.4. Polydiagonals

We now relate a partition that encodes an equality-based synchrony pattern to its corresponding subset of the state set in the network.

**Definition 3.2.** Given a partition  $\mathcal{A} \in L_{\mathcal{T}}$ , we call the subset of  $\mathbb{X}$

$$\Delta_{\mathcal{A}}^{\mathbb{X}} := \{\mathbf{x} \in \mathbb{X} : \mathcal{A}(c) = \mathcal{A}(d) \implies x_c = x_d\}, \quad (15)$$

the **polydiagonal** of  $\mathcal{A}$  in  $\mathbb{X}$ . □

This means that any  $\mathbf{x} \in \Delta_{\mathcal{A}}^{\mathbb{X}}$  can be given by  $\mathbf{x} = P\bar{\mathbf{x}}$  for some  $\bar{\mathbf{x}}$ , where  $P$  is a partition matrix of  $\mathcal{A}$ . Consider for instance  $\mathcal{A} = \{\{1, 2\}, \{3\}\}$ , represented by  $P = \begin{bmatrix} 1 & 0 \\ 1 & 0 \\ 0 & 1 \end{bmatrix}$ . Then,  $\mathbf{x} = P\bar{\mathbf{x}}$  with  $\bar{\mathbf{x}} = \begin{bmatrix} \bar{x}_1 \\ \bar{x}_2 \end{bmatrix}$  gives us  $\mathbf{x} = \begin{bmatrix} \bar{x}_1 \\ \bar{x}_1 \\ \bar{x}_2 \end{bmatrix}$ .

**Remark 6.** Note that if the state sets  $\{\mathbb{X}_i\}_{i \in \mathcal{T}}$  only have one element, then it is irrelevant to talk about synchronism in the first place. For this reason, we assume that the state sets are non-empty and non-singleton. That is, we can always choose  $x_c \neq x_d$  with  $x_c, x_d \in \mathbb{X}_i$  for  $i = \mathcal{T}(c) = \mathcal{T}(d)$ . □

The partial order relationship between partitions ( $\leq$ ) induces the following inclusion partial order ( $\subseteq$ ) between polydiagonals.

**Lemma 3.10.** Consider partitions  $\mathcal{A}, \mathcal{B} \in L_{\mathcal{T}}$  and their respective polydiagonals  $\Delta_{\mathcal{A}}^{\mathbb{X}}, \Delta_{\mathcal{B}}^{\mathbb{X}}$ . Then,

$$\mathcal{A} \leq \mathcal{B} \iff \Delta_{\mathcal{A}}^{\mathbb{X}} \supseteq \Delta_{\mathcal{B}}^{\mathbb{X}}. \quad (16)$$

□

*Proof.* The forward direction is direct from (10) together with definition 3.2. The backwards direction is proved by showing its contrapositive, that is,  $\neg(\mathcal{A} \leq \mathcal{B}) \implies \neg(\Delta_{\mathcal{A}}^{\mathbb{X}} \supseteq \Delta_{\mathcal{B}}^{\mathbb{X}})$ . If  $\neg(\mathcal{A} \leq \mathcal{B})$ , then there are  $c, d \in \mathcal{C}$  such that  $\mathcal{A}(c) = \mathcal{A}(d)$  and  $\mathcal{B}(c) \neq \mathcal{B}(d)$ . Then, under the assumption that the state sets are non-singleton, there is  $\mathbf{x} \in \Delta_{\mathcal{B}}^{\mathbb{X}}$  such that  $x_c \neq x_d$ , that is,  $\mathbf{x} \notin \Delta_{\mathcal{A}}^{\mathbb{X}}$ , which proves the contrapositive. ■

Moreover, the intersection of two polydiagonals is itself a polydiagonal. In particular, it is related to the join ( $\vee$ ) operation as follows.

**Lemma 3.11.** *Given partitions  $\mathcal{A}_1, \mathcal{A}_2 \in L_{\mathcal{T}}$ , we have that  $\Delta_{\mathcal{A}_1 \vee \mathcal{A}_2}^{\mathbb{X}} = \Delta_{\mathcal{A}_1}^{\mathbb{X}} \cap \Delta_{\mathcal{A}_2}^{\mathbb{X}}$ .  $\square$*

*Proof.* Since  $\mathcal{A}_1 \vee \mathcal{A}_2$  is coarser than both  $\mathcal{A}_1$  and  $\mathcal{A}_2$ , we know from lemma 3.10 that  $\Delta_{\mathcal{A}_1 \vee \mathcal{A}_2}^{\mathbb{X}} \subseteq \Delta_{\mathcal{A}_1}^{\mathbb{X}}$  and  $\Delta_{\mathcal{A}_1 \vee \mathcal{A}_2}^{\mathbb{X}} \subseteq \Delta_{\mathcal{A}_2}^{\mathbb{X}}$ . Therefore,  $\Delta_{\mathcal{A}_1 \vee \mathcal{A}_2}^{\mathbb{X}} \subseteq \Delta_{\mathcal{A}_1}^{\mathbb{X}} \cap \Delta_{\mathcal{A}_2}^{\mathbb{X}}$ . We now prove the converse. Assume  $\mathbf{x} \in \Delta_{\mathcal{A}_1}^{\mathbb{X}} \cap \Delta_{\mathcal{A}_2}^{\mathbb{X}}$ . Then,  $\mathbf{x} \in \Delta_{\mathcal{A}_1}^{\mathbb{X}}$  and  $\mathbf{x} \in \Delta_{\mathcal{A}_2}^{\mathbb{X}}$ . This implies that for every chain of cells  $c = c_1, \dots, c_k = d$  such that either  $\mathcal{A}_1(c_i) = \mathcal{A}_1(c_{i+1})$  or  $\mathcal{A}_2(c_i) = \mathcal{A}_2(c_{i+1})$ , we have that  $x_c = x_d$ . From lemma 3.3, we have that  $\mathbf{x} \in \Delta_{\mathcal{A}_1 \vee \mathcal{A}_2}^{\mathbb{X}}$ . Therefore,  $\Delta_{\mathcal{A}_1}^{\mathbb{X}} \cap \Delta_{\mathcal{A}_2}^{\mathbb{X}} \subseteq \Delta_{\mathcal{A}_1 \vee \mathcal{A}_2}^{\mathbb{X}}$ .  $\blacksquare$

The union of polydiagonals does not necessarily give us another polydiagonal. There exists, however, the smallest polydiagonal that contains the union of two polydiagonals. Note that these properties are analogous to the intersection and union of vector subspaces.

**Lemma 3.12.** *Given partitions  $\mathcal{A}_1, \mathcal{A}_2 \in L_{\mathcal{T}}$ , we have that  $\Delta_{\mathcal{A}}^{\mathbb{X}} \supseteq \Delta_{\mathcal{A}_1}^{\mathbb{X}} \cup \Delta_{\mathcal{A}_2}^{\mathbb{X}}$  if and only if  $\mathcal{A} \leq \mathcal{A}_1 \wedge \mathcal{A}_2$ .  $\square$*

*Proof.* Consider a partition  $\mathcal{A} \in L_{\mathcal{T}}$  such that  $\Delta_{\mathcal{A}}^{\mathbb{X}} \supseteq \Delta_{\mathcal{A}_1}^{\mathbb{X}} \cup \Delta_{\mathcal{A}_2}^{\mathbb{X}}$ . Then,  $\Delta_{\mathcal{A}}^{\mathbb{X}} \supseteq \Delta_{\mathcal{A}_1}^{\mathbb{X}}$  and  $\Delta_{\mathcal{A}}^{\mathbb{X}} \supseteq \Delta_{\mathcal{A}_2}^{\mathbb{X}}$ . From lemma 3.10, this means that  $\mathcal{A} \leq \mathcal{A}_1$  and  $\mathcal{A} \leq \mathcal{A}_2$ , therefore  $\mathcal{A} \leq \mathcal{A}_1 \wedge \mathcal{A}_2$ .

We now prove the converse. It is enough to show that  $\mathcal{A}_1 \wedge \mathcal{A}_2$  satisfies the inclusion condition since from lemma 3.10, any partition finer than it would also satisfy it. Since  $\mathcal{A}_1 \wedge \mathcal{A}_2$  is finer than both  $\mathcal{A}_1$  and  $\mathcal{A}_2$ , we know that  $\Delta_{\mathcal{A}_1 \wedge \mathcal{A}_2}^{\mathbb{X}} \supseteq \Delta_{\mathcal{A}_1}^{\mathbb{X}}$  and  $\Delta_{\mathcal{A}_1 \wedge \mathcal{A}_2}^{\mathbb{X}} \supseteq \Delta_{\mathcal{A}_2}^{\mathbb{X}}$ . Therefore,  $\Delta_{\mathcal{A}_1 \wedge \mathcal{A}_2}^{\mathbb{X}} \supseteq \Delta_{\mathcal{A}_1}^{\mathbb{X}} \cup \Delta_{\mathcal{A}_2}^{\mathbb{X}}$ .  $\blacksquare$

### 3.5. Invariance of polydiagonals

We now investigate the properties of a function that preserves equality-based synchrony patterns.

**Definition 3.3.** *If for a  $\mathcal{G}$ -admissible function  $f: \mathbb{X} \rightarrow \mathbb{Y}$  and a partition  $\mathcal{A} \in L_{\mathcal{T}}$  we have*

$$f(\Delta_{\mathcal{A}}^{\mathbb{X}}) \subseteq \Delta_{\mathcal{A}}^{\mathbb{Y}}, \quad (17)$$

*then  $\mathcal{A}$  is  $f$ -invariant.*

*Furthermore, if for  $F \subseteq \mathcal{F}_{\mathcal{G}}$ ,  $\mathcal{A}$  is  $f$ -invariant for every  $f \in F$ , then we say that  $\mathcal{A}$  is  $F$ -invariant.  $\square$*

Note that if  $\mathcal{A}$  is  $f$ -invariant, then for every  $\mathbf{x} \in \mathbb{X}$  such that  $\mathbf{x} = P\bar{\mathbf{x}}$ , with  $P$  representing  $\mathcal{A}$ , there is  $\bar{\mathbf{y}}$  such that  $f(P\bar{\mathbf{x}}) = P\bar{\mathbf{y}}$ . This means that there is a function  $\bar{f}: \bar{\mathbb{X}} \rightarrow \bar{\mathbb{Y}}$  with sets  $\bar{\mathbb{X}} := \mathbb{X}^{\bar{\mathbf{k}}}$  and  $\bar{\mathbb{Y}} := \mathbb{Y}^{\bar{\mathbf{k}}}$ , for an appropriate  $\bar{\mathbf{k}} \geq \mathbf{0}_{|T|}$ , such that

$$f(P\bar{\mathbf{x}}) = P\bar{f}(\bar{\mathbf{x}}). \quad (18)$$

Consider again  $\mathcal{A} = \{\{1, 2\}, \{3\}\}$ , represented by  $P = \begin{bmatrix} 1 & 0 \\ 1 & 0 \\ 0 & 1 \end{bmatrix}$ . Then,  $\mathcal{A}$  is  $f$ -invariant if  $f\left(\begin{bmatrix} \bar{x}_1 \\ \bar{x}_1 \\ \bar{x}_2 \end{bmatrix}\right) = \begin{bmatrix} \bar{y}_1 \\ \bar{y}_1 \\ \bar{y}_2 \end{bmatrix}$ . That is,  $f\left(P\begin{bmatrix} \bar{x}_1 \\ \bar{x}_2 \end{bmatrix}\right) = P\begin{bmatrix} \bar{y}_1 \\ \bar{y}_2 \end{bmatrix}$ . This means that  $f$  induces a related function  $\bar{f}\left(\begin{bmatrix} \bar{x}_1 \\ \bar{x}_2 \end{bmatrix}\right) = \begin{bmatrix} \bar{y}_1 \\ \bar{y}_2 \end{bmatrix}$ .

**Corollary 3.3.** *The trivial partition  $\perp$  is always  $\mathcal{F}_G$ -invariant.*  $\square$

**Lemma 3.13.** *Consider partitions  $\mathcal{A}_1, \mathcal{A}_2 \in L_{\mathcal{T}}$  and  $f \in \mathcal{F}_G$  such that  $\mathcal{A}_1, \mathcal{A}_2$  are both  $f$ -invariant. Then,  $\mathcal{A}_1 \vee \mathcal{A}_2$  is also  $f$ -invariant.*  $\square$

*Proof.* Take any  $\mathbf{x} \in \Delta_{\mathcal{A}_1 \vee \mathcal{A}_2}^{\mathbb{X}} = \Delta_{\mathcal{A}_1}^{\mathbb{X}} \cap \Delta_{\mathcal{A}_2}^{\mathbb{X}}$ . Then,  $\mathbf{x} \in \Delta_{\mathcal{A}_1}^{\mathbb{X}}$  and  $\mathbf{x} \in \Delta_{\mathcal{A}_2}^{\mathbb{X}}$ . From assumption, we have  $f(\mathbf{x}) \in \Delta_{\mathcal{A}_1}^{\mathbb{Y}}$  and  $f(\mathbf{x}) \in \Delta_{\mathcal{A}_2}^{\mathbb{Y}}$ , that is,  $f(\mathbf{x}) \in \Delta_{\mathcal{A}_1}^{\mathbb{Y}} \cap \Delta_{\mathcal{A}_2}^{\mathbb{Y}} = \Delta_{\mathcal{A}_1 \vee \mathcal{A}_2}^{\mathbb{Y}}$ . Therefore,  $\mathcal{A}_1 \vee \mathcal{A}_2$  is  $f$ -invariant.  $\blacksquare$

**Corollary 3.4.** *Consider partitions  $\mathcal{A}_1, \mathcal{A}_2 \in L_{\mathcal{T}}$  and  $F \subseteq \mathcal{F}_G$  such that  $\mathcal{A}_1, \mathcal{A}_2$  are both  $F$ -invariant. Then,  $\mathcal{A}_1 \vee \mathcal{A}_2$  is also  $F$ -invariant.*  $\square$

*Proof.* From definition,  $\mathcal{A}_1, \mathcal{A}_2$  being  $F$ -invariant implies that they are  $f$ -invariant for every  $f \in F$ . Then, from lemma 3.13,  $\mathcal{A}_1 \vee \mathcal{A}_2$  is also  $f$ -invariant for every  $f \in F$ . That is,  $\mathcal{A}_1 \vee \mathcal{A}_2$  is  $F$ -invariant.  $\blacksquare$

**Remark 7.** *Note that only being interested in a particular subset of admissible functions  $F \subseteq \mathcal{F}_G$  is quite natural. In particular, the definition of  $\mathcal{F}_G$  does not include any type of smoothness assumption. In general, we could be interested in admissible functions that are constructed through of oracle components that have more properties than the minimal ones described in definition 2.2. For instance, an oracle component such that a cell becomes insensitive to cells that are on the same state, corresponds, under the current formalism, to the following constraint.*

$$\hat{f}_i\left(x; \begin{bmatrix} w_{i_1} \\ \mathbf{w} \end{bmatrix}, \begin{bmatrix} x \\ \mathbf{x} \end{bmatrix}\right) = \hat{f}_i(x; \mathbf{w}, \mathbf{x}). \quad (19)$$

*This assumption is present, for instance in the Kuramoto model. Note that this makes the cells of such a system always insensitive to self-loops.*  $\square$

We can now show that the sets of  $F$ -invariant partitions form lattices.

**Theorem 3.2.** *Denote by  $L_F$  the subset of partitions in  $L_{\mathcal{T}}$  that are  $F$ -invariant, with  $F \subseteq \mathcal{F}_G$ . Then,  $L_F$  is a lattice whose minimal element  $\perp_F$  is the trivial partition  $\perp$  and whose join operation  $\vee_F$  is the partition join  $\vee$  as described in lemma 3.3.*  $\square$

*Proof.* We know that  $L_{\mathcal{T}}$  is finite, therefore,  $L_F$  is also finite. From corollary 3.3, we know that  $\perp \in L_F$  for all  $F \subseteq \mathcal{F}_G$ . Since  $\perp$  is the finest partition, we have that  $\perp_F = \perp$ .

Consider any  $\mathcal{A}_1, \mathcal{A}_2 \in L_F$ . Then, from corollary 3.4, we know that  $\mathcal{A}_1 \vee \mathcal{A}_2 \in L_F$ . Any partition coarser than  $\mathcal{A}_1$  and  $\mathcal{A}_2$  has to be coarser than  $\mathcal{A}_1 \vee \mathcal{A}_2$ . Therefore,  $\vee_F = \vee$ . From lemma 3.5, we know that  $L_F$  is a lattice.  $\blacksquare$

**Remark 8.** Note that  $L_\emptyset = L_{\mathcal{T}}$  since being  $\emptyset$ -invariant is vacuously satisfied.  $\square$

**Corollary 3.5.** Denote by  $L_f$  (instead of by  $L_{\{f\}}$ ) the subset of partitions in  $L_{\mathcal{T}}$  that are  $f$ -invariant, with  $f \in \mathcal{F}_{\mathcal{G}}$ . Then, for all  $F \subseteq \mathcal{F}_{\mathcal{G}}$ , we have that  $L_F = \bigcap_{f \in F} L_f$ .  $\square$

**Corollary 3.6.** For every  $F_1, F_2 \subseteq \mathcal{F}_{\mathcal{G}}$ , we have that

- (i) If  $F_1 \subseteq F_2$ , then  $L_{F_1} \supseteq L_{F_2}$ .
- (ii)  $L_{F_1 \cup F_2} = L_{F_1} \cap L_{F_2}$ .
- (iii)  $L_{F_1 \cap F_2} \supseteq L_{F_1} \cup L_{F_2}$ .

$\square$

From item i of corollary 3.6, we know that  $L_{\mathcal{F}_{\mathcal{G}}}$  is the smallest possible lattice of invariant partitions.

We have shown in lemma 3.6 that for a lattice  $L$  such that  $\perp_L = \perp$  and  $\vee_L = \vee$ , there exists of a function  $\text{cir}_L$  that assigns to each element in  $L_{\mathcal{T}}$  an element of  $L$ . Since every  $F$ -invariant lattice satisfies these assumptions, we have the following.

**Corollary 3.7.** Consider a  $F$ -invariant lattice  $L_F$ , with  $F \subseteq \mathcal{F}_{\mathcal{G}}$ . Given any partition  $\mathcal{A} \in L_{\mathcal{T}}$ , there is a partition  $\mathcal{B} \in L_F$  that is the coarsest one in  $L_F$  such that  $\mathcal{B} \leq \mathcal{A}$ . This establishes the function  $\text{cir}_F: L_{\mathcal{T}} \rightarrow L_F$ .  $\square$

**Corollary 3.8.** Consider partitions  $\mathcal{A}_1, \mathcal{A}_2 \in L_F$ , with  $F \subseteq \mathcal{F}_{\mathcal{G}}$ . Then  $\mathcal{A}_1 \wedge_F \mathcal{A}_2 = \text{cir}_F(\mathcal{A}_1 \wedge \mathcal{A}_2)$ .  $\square$

In summary, we have seen that the join operation ( $\vee$ ) as described in lemma 3.3 is fundamental with regard to the study of invariance in polydiagonals. In particular, it corresponds to the fact that the intersection of invariant polydiagonals gives us another invariant polydiagonal. On the other hand, the meet operation is not fixed. It is dependent on the particular lattice  $L$  and does not present a clear intuitive meaning. In fact, from lemma 3.5, its existence can be seen as a mere consequence of a minimal partition  $\perp_L$  together with some join operation  $\vee_L$ . Since we have that  $\vee_L = \vee$  for all the lattices we are interested in ( $F$ -invariant lattices), we see that the join operation is the most convenient of the two fundamental operations on lattices and we focus on it in this work.

### 3.6. Balanced partitions

We now show that if the connectivity structure of a network  $\mathcal{G}$  respects certain conditions, it enforces certain polydiagonals to be invariant, regardless of the particular choice of admissible  $f \in \mathcal{F}_{\mathcal{G}}$ .

**Definition 3.4.** Consider a network  $\mathcal{G}$  defined on a cell set  $\mathcal{C}$  with a cell type partition  $\mathcal{T}$  and an in-adjacency matrix  $M$ . A partition  $\mathcal{A} \in L_{\mathcal{T}}$  with characteristic matrix  $P$  is said to be **balanced** on  $\mathcal{G}$  if for all  $c, d \in \mathcal{C}$

$$\mathcal{A}(c) = \mathcal{A}(d) \implies \mathbf{m}_c P = \mathbf{m}_d P, \quad (20)$$

where  $\mathbf{m}_c, \mathbf{m}_d$  are the rows of matrix  $M$  corresponding to cells  $c$  and  $d$ , respectively.  $\square$

Note that a partition is balanced if and only if there is a matrix  $Q$  of elements in the appropriate monoids  $\{\mathcal{M}_{ij}\}_{i,j \in \mathcal{T}}$  such that

$$MP = PQ. \quad (21)$$

A balanced partition is usually indicated with the symbol  $\bowtie$  and we denote the set of all balanced partitions in a given network  $\mathcal{G}$  by  $\Lambda_{\mathcal{G}}$ .

In [13] it was shown that for the unweighted formalism,  $\Lambda_{\mathcal{G}}$  forms a lattice under the partition refinement relation ( $\leq$ ), as described in (10). We show that this follows easily from the results in section 3.5.

**Corollary 3.9.** The trivial partition  $\perp$  is always balanced.  $\square$

*Proof.* For any  $M$ , the condition (21) is satisfied with  $P = I$  and  $Q = M$ .  $\blacksquare$

The following was proven in [4] for the weighted formalism.

**Lemma 3.14.** Consider balanced partitions  $\bowtie_1, \bowtie_2 \in \Lambda_{\mathcal{G}}$ . Then,  $\bowtie_1 \vee \bowtie_2$  is also balanced.  $\square$

Using lemma 3.5 again, the following is an immediate consequence of corollary 3.9 and lemma 3.14.

**Corollary 3.10.** Given a network  $\mathcal{G}$ , the set of balanced partitions  $\Lambda_{\mathcal{G}}$  forms a lattice whose minimal element  $\perp_{\mathcal{G}}$  is the trivial partition  $\perp$  and whose join operation  $\vee_{\mathcal{G}}$  is the partition join  $\vee$  as described in lemma 3.3.  $\square$

From lemma 3.6, the following is immediate.

**Corollary 3.11.** Given any partition  $\mathcal{A} \in L_{\mathcal{T}}$ , there is a partition  $\bowtie \in \Lambda_{\mathcal{G}}$  that is the coarsest one in  $\Lambda_{\mathcal{G}}$  such that  $\bowtie \leq \mathcal{A}$ .  $\square$

This implies the existence of a *cir* function from  $L_{\mathcal{T}}$  to  $\Lambda_{\mathcal{G}}$ , which we denote by just *cir*. Then, we have the following.

**Corollary 3.12.** Consider balanced partitions  $\bowtie_1, \bowtie_2 \in \Lambda_{\mathcal{G}}$ . Then,  $\bowtie_1 \wedge_{\mathcal{G}} \bowtie_2 = \text{cir}(\bowtie_1 \wedge \bowtie_2)$ .  $\square$

The particular *cir* function associated with  $\Lambda_{\mathcal{G}}$  is easy to compute and was extended in [4] for the general weighted case.

In order to present the interesting properties of balanced partitions, we require the following result, which relates partitions and oracle components.

**Lemma 3.15.** *For any oracle component  $\hat{f}_i \in \hat{\mathcal{F}}_i$ , we have that*

$$\hat{f}_i(x; \mathbf{w}, P\bar{\mathbf{x}}) = \hat{f}_i(x; P^\top \mathbf{w}, \bar{\mathbf{x}}), \quad (22)$$

where  $P$  is a partition matrix of appropriate dimensions such that the vectors  $\mathbf{w}$  and  $P\bar{\mathbf{x}}$  have elements of matching cell types.  $\square$

*Proof.* We prove this by induction. Consider fixed integers  $n, k$  such that  $0 < k < n$ . Assume (22) applies to all partition matrices of dimension  $n \times (k + 1)$  as long as it is applied to suitable (type matching)  $\mathbf{w}$  and  $\bar{\mathbf{x}}$ . Note that any partition matrix  $P$  of dimension  $n \times k$  can be obtained by taking some partition matrix  $\bar{P}$  of dimension  $n \times (k + 1)$  and merging together two of its columns. That is,  $P = \bar{P}p\sigma$ , with

$$p = \begin{bmatrix} 1 & \mathbf{0}^\top \\ 1 & \mathbf{0}^\top \\ \mathbf{0} & \mathbf{I}_{k-1} \end{bmatrix} \text{ and where } \sigma \text{ is a permutation matrix of dimension } k \times k.$$

Consider one such  $P$  and any suitable  $\mathbf{w}$  and  $\bar{\mathbf{x}}$ . Then,  $\hat{f}_i(x; \mathbf{w}, P\bar{\mathbf{x}}) = \hat{f}_i(x; \mathbf{w}, \bar{P}(p\sigma\bar{\mathbf{x}}))$ . From assumption, we can apply (22) with respect to  $\bar{P}$ , which gets us  $\hat{f}_i(x; \bar{P}^\top \mathbf{w}, p\sigma\bar{\mathbf{x}})$ . Due to the particular shape of  $p$ , applying (22) with regard to  $p$  is equivalent to item ii of definition 2.2. This gives us  $\hat{f}_i(x; p^\top \bar{P}^\top \mathbf{w}, \sigma\bar{\mathbf{x}})$ . Similarly, we can apply (22) with regard to  $\sigma$  since it corresponds to item i of definition 2.2. Note that since  $\sigma$  is a permutation matrix, we have that  $\sigma^{-1} = \sigma^\top$ . Therefore, this becomes  $\hat{f}_i(x; \sigma^\top p^\top \bar{P}^\top \mathbf{w}, \bar{\mathbf{x}}) = \hat{f}_i(x; (\bar{P}p\sigma)^\top \mathbf{w}, \bar{\mathbf{x}}) = \hat{f}_i(x; P^\top \mathbf{w}, \bar{\mathbf{x}})$ , which proves that (22) is satisfied for any partition matrix  $P$  of size  $n \times k$ . In the base case  $k = n$ , the partition matrix is in fact a permutation, therefore, it is direct from item i of definition 2.2, which concludes the proof.  $\blacksquare$

A more convoluted version of lemma 3.15 was originally part of the definition of oracle components in [4]. We had it in place of items i and ii in definition 2.2. We just proved lemma 3.15 using items i and ii. Furthermore, it is straightforward that these items are just particular cases of lemma 3.15. Therefore, the two definitions are equivalent.

**Remark 9.** *Note that lemma 3.15 is valid for all inputs such that the evaluation is meaningful. That is, whenever the domain (1) is respected. Furthermore, it can be seen that vectors  $\mathbf{w}$  and  $P\bar{\mathbf{x}}$  having elements of matching cell types is equivalent to  $P^\top \mathbf{w}$  and  $\bar{\mathbf{x}}$  having elements of matching cell types and the sum  $P^\top \mathbf{w}$  being well-defined. That is, each sum operates on elements of the same commutative monoid.  $\square$*

Having proven this, we can now state the following result, which underlines the importance of balanced partitions in the study of invariance.

**Theorem 3.3.** *Consider a balanced partition  $\bowtie \in \Lambda_{\mathcal{G}}$  on a network  $\mathcal{G}$  and any  $\mathcal{G}$ -admissible function  $f \in \mathcal{F}_{\mathcal{G}}$ . Then,  $\bowtie$  is  $f$ -invariant.  $\square$*

*Proof.* Consider any  $\bowtie \in \Lambda_{\mathcal{G}}$  and a state in the related polydiagonal  $\mathbf{x} \in \Delta_{\bowtie}^{\mathbf{x}}$ . That is,  $\mathbf{x} = P\bar{\mathbf{x}}$  for some  $\bar{\mathbf{x}}$ , where  $P$  is a partition matrix of  $\bowtie$ .

For any pair of cells  $c, d \in \mathcal{C}$  such that  $\bowtie(c) = \bowtie(d)$ , we have that  $x_c = x_d$ . Furthermore, from definition 3.4, we have that  $P^\top \mathbf{m}_c^\top = P^\top \mathbf{m}_d^\top$ . Therefore,  $\hat{f}_i(x_c; P^\top \mathbf{m}_c^\top, \bar{\mathbf{x}}) = \hat{f}_i(x_d; P^\top \mathbf{m}_d^\top, \bar{\mathbf{x}})$  for any  $\hat{f}_i \in \hat{\mathcal{F}}_i$ , with  $i = \mathcal{T}(c) = \mathcal{T}(d)$ .

Using lemma 3.15, this becomes  $\hat{f}_i(x_c; \mathbf{m}_c^\top, P\bar{\mathbf{x}}) = \hat{f}_i(x_d; \mathbf{m}_d^\top, P\bar{\mathbf{x}})$ , which from definition 2.3 is equivalent to  $f_c(P\bar{\mathbf{x}}) = f_d(P\bar{\mathbf{x}})$ . This means that for every  $\mathcal{G}$ -admissible function  $f \in \mathcal{F}_{\mathcal{G}}$ , there is a  $\bar{f}$  such that  $f(P\bar{\mathbf{x}}) = P\bar{f}(\bar{\mathbf{x}})$ . That is,  $\bowtie$  is  $f$ -invariant. ■

Which is equivalent to the following statement.

**Corollary 3.13.** *Given a network  $\mathcal{G}$ , we have that  $\Lambda_{\mathcal{G}} \subseteq L_F$ , for any  $F \subseteq \mathcal{F}_{\mathcal{G}}$ .* □

**Theorem 3.4.** *Consider a partition  $\mathcal{A} \leq \mathcal{T}$  on some network  $\mathcal{G}$ . If  $\mathcal{A}$  is  $\mathcal{F}_{\mathcal{G}}$ -invariant, then  $\mathcal{A}$  is balanced on  $\mathcal{G}$ .* □

Which is equivalent to the following statement.

**Corollary 3.14.** *Given a network  $\mathcal{G}$ , we have that  $\Lambda_{\mathcal{G}} \supseteq L_{\mathcal{F}_{\mathcal{G}}}$ .* □

Note that  $L_{\mathcal{F}_{\mathcal{G}}}$  is the smallest possible lattice of invariant partitions. In [1, 2, 3], theorem 3.4 was derived by proving a stronger result. In particular, by showing that exists some subset  $F \subseteq \mathcal{F}_{\mathcal{G}}$  such that  $\Lambda_{\mathcal{G}} \supseteq L_F$ . This type of results is of interest since one might only be interested in certain subclasses of admissible functions and not the full  $\mathcal{F}_{\mathcal{G}}$ .

This stronger result, which was originally hid away in their proof of the unweighted version of theorem 3.4, was made explicit and generalized in [4] for the general weighted formalism.

From and corollaries 3.13 and 3.14 the following is now immediate.

**Corollary 3.15.** *Given a network  $\mathcal{G}$ , we have that  $\Lambda_{\mathcal{G}} = L_{\mathcal{F}_{\mathcal{G}}}$ .* □

### 3.7. Quotient networks

In this section we describe how the behavior of a network  $\mathcal{G}$  when evaluated at some polydiagonal  $\Delta_{\bowtie}^{\times}$  for some balanced partition  $\bowtie$  can be described by a smaller network  $\mathcal{Q}$ .

**Definition 3.5.** *Consider a network  $\mathcal{G}$  defined on a cell set  $\mathcal{C}_{\mathcal{G}}$  with a cell type partition  $\mathcal{T}_{\mathcal{G}}$  and an in-adjacency matrix  $M$ . Take a balanced partition  $\bowtie \in \Lambda_{\mathcal{G}}$ .*

*The **quotient network**  $\mathcal{Q}$  of  $\mathcal{G}$  over  $\bowtie$ , denoted  $\mathcal{Q} := \mathcal{G}/\bowtie$ , is defined on a cell set  $\mathcal{C}_{\mathcal{Q}} := \mathcal{C}_{\mathcal{G}}/\bowtie$  with a cell type partition  $\mathcal{T}_{\mathcal{Q}} := \mathcal{T}_{\mathcal{G}}/\bowtie$  and an in-adjacency matrix  $Q$  given by  $MP = PQ$ , where  $P$  represents  $\bowtie$ .* □

**Remark 10.** *We assume that a particular ordering has been chosen for the sets of cells  $\mathcal{C}_{\mathcal{G}}$  and  $\mathcal{C}_{\mathcal{Q}}$ . Then, the partition  $P$  representing  $\bowtie$  and the in-adjacency matrices  $M$  and  $Q$  are uniquely defined.* □

**Lemma 3.16.** *Consider a balanced partition  $\bowtie_{01} \in \Lambda_{\mathcal{G}_0}$  on a network  $\mathcal{G}_0$  and its respective quotient network  $\mathcal{G}_1 = \mathcal{G}_0/\bowtie_{01}$ . For a partition  $\bowtie_{02}$  such that  $\bowtie_{01} \leq \bowtie_{02}$ , define  $\bowtie_{12} := \bowtie_{02}/\bowtie_{01}$ . Then,  $\bowtie_{02} \in \Lambda_{\mathcal{G}_0}$  if and only if  $\bowtie_{12} \in \Lambda_{\mathcal{G}_1}$ . Furthermore, if  $\bowtie_{02}$  and  $\bowtie_{12}$  satisfy this, then  $\mathcal{G}_0/\bowtie_{02} = \mathcal{G}_1/\bowtie_{12}$ .* □

From theorem 3.3, we know that any balanced partition  $\bowtie \in \Lambda_{\mathcal{G}}$  is  $f$ -invariant for any  $f \in \mathcal{F}_{\mathcal{G}}$ . Note that in (18) it was shown that for a partition  $\mathcal{A}$  and a function  $f$  such that  $\mathcal{A}$  is  $f$ -invariant, then,  $f$ , when evaluated on  $\Delta_{\mathcal{A}}^{\times}$  can be determined by a simpler function  $\bar{f}$ . We will see that for the case of balanced partitions this function is particularly noteworthy.

**Definition 3.6.** Consider a network  $\mathcal{G}$  and a balanced partition  $\bowtie \in \Lambda_{\mathcal{G}}$ . Let  $f \in \mathcal{F}_{\mathcal{G}}$ . The **quotient function**  $g := f/\bowtie$  is defined through constraining  $f$  to the polydiagonal  $\Delta_{\bowtie}^{\times}$ . That is,

$$f(P\bar{\mathbf{x}}) = Pg(\bar{\mathbf{x}}). \quad (23)$$

□

We now show that the quotient function is very intimately related to the quotient network.

**Theorem 3.5.** Consider networks  $\mathcal{G}$  and  $\mathcal{Q}$  such that  $\mathcal{Q} = \mathcal{G}/\bowtie$  for some balanced partition  $\bowtie \in \Lambda_{\mathcal{G}}$ . Then, for any  $f \in \mathcal{F}_{\mathcal{G}}$ , which is given by  $f = \hat{f}|_{\mathcal{G}}$ , for some  $\hat{f} \in \hat{\mathcal{F}}_T$ , we have that its quotient function  $g = f/\bowtie$  is given by  $g = \hat{f}|_{\mathcal{Q}}$ . Therefore,  $g \in \mathcal{F}_{\mathcal{Q}}$ . □

Now that we understand the relationship between  $f \in \mathcal{F}_{\mathcal{G}}$  and its quotient  $g = f/\bowtie$  in terms of oracle functions, the following is clear.

**Corollary 3.16.** Consider networks  $\mathcal{G}$  and  $\mathcal{Q}$  such that  $\mathcal{Q} = \mathcal{G}/\bowtie$  for some balanced partition  $\bowtie \in \Lambda_{\mathcal{G}}$ . Then, for any  $g \in \mathcal{F}_{\mathcal{Q}}$ , there is some  $f \in \mathcal{F}_{\mathcal{G}}$  such that  $g = f/\bowtie$ . □

Note that corollary 3.16 only refers to existence, not to uniqueness. That is, it could be possible to have  $f_1, f_2 \in \mathcal{F}_{\mathcal{G}}$  such that  $f_1 \neq f_2$  but  $g = f_1/\bowtie = f_2/\bowtie$ . They will, however, match when evaluated at the polydiagonal  $\Delta_{\bowtie}^{\times}$ .

**Example 3.7.** Consider the given partition  $\mathcal{A} = \{\{1,2\}, \{3\}\}$  on the **CCN** of example 2.1 (figure 2). One partition matrix of  $\mathcal{A}$  is

$$P = \begin{bmatrix} 1 & 0 \\ 1 & 0 \\ 0 & 1 \end{bmatrix}, \quad (24)$$

in which each column identifies one of the colors of the partition. From this we obtain the product

$$MP = \begin{bmatrix} 1 & 1 \\ 1 & 1 \\ 2 & 1 \end{bmatrix}. \quad (25)$$

Note that rows 1 and 2 are the same and the respective cells are of the same cell type. That means that for any admissible  $f$  we have  $f_1(\mathbf{x}) = f_2(\mathbf{x})$  when  $x_1 = x_2$ .

Observe that this is in agreement with the functional form we wrote in (7),(8).

Since the rows of  $MP$  respect an equality relationship according to  $\mathcal{A}$ , then  $\mathcal{A}$  is balanced



and there is a quotient matrix  $Q$  that obeys the balanced condition (21). In fact, the quotient matrix  $Q$  is

$$Q = \begin{bmatrix} 1 & 1 \\ 2 & 1 \end{bmatrix}, \quad (26)$$

which is directly obtained from  $MP$  by compressing its rows according to  $\mathcal{A}$ .

The behavior of this **CCN** when  $x_1 = x_2$  is then described by the smaller **CCN** given by the quotient matrix  $Q$  which is represented in figure 6b. The coloring is a way of

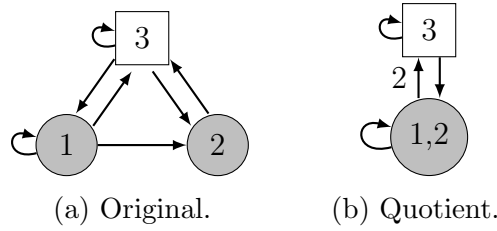

Figure 6: Color-coded network of figure 2 and its quotient over the balanced partition  $\{\{1, 2\}, \{3\}\}$ .

representing the partition  $\mathcal{A} = \{\{1, 2\}, \{3\}\}$  over which the quotient is done. Note that in both figure 6a and figure 6b each gray cell receives one connection from a gray cell and one connection from a white cell. On the other hand, each white cell receives a connection from a white cell and two connections from a gray cell. The function  $g = f/\boxtimes$  has the following structure

$$g_{12}(\mathbf{x}) = \hat{f}_1(x_{12}; \begin{bmatrix} 1 & 1 \end{bmatrix}^\top, \mathbf{x}), \quad (27)$$

$$g_3(\mathbf{x}) = \hat{f}_2(x_3; \begin{bmatrix} 2 & 1 \end{bmatrix}^\top, \mathbf{x}), \quad (28)$$

where  $\hat{f} \in \hat{\mathcal{F}}_T$  is any oracle function such that  $f = \hat{f}|_{\mathcal{G}}$ .  $\square$

We now extend the concept of quotient of admissible functions to sets of admissible functions.

**Definition 3.7.** Consider networks  $\mathcal{G}$  and  $\mathcal{Q}$  such that  $\mathcal{Q} = \mathcal{G}/\boxtimes$  for some  $\boxtimes \in \Lambda_{\mathcal{G}}$ . Given any subset of  $\mathcal{G}$ -admissible functions  $F_{\mathcal{G}} \subseteq \mathcal{F}_{\mathcal{G}}$ , we define its quotient  $F_{\mathcal{Q}} = F_{\mathcal{G}}/\boxtimes$  as the subset of  $\mathcal{F}_{\mathcal{Q}}$  such that  $g \in F_{\mathcal{Q}}$  if and only if there is some  $f \in F_{\mathcal{G}}$  such that  $g = f/\boxtimes$ .  $\square$

Note that from corollary 3.16 it is immediate that  $\mathcal{F}_{\mathcal{G}}/\boxtimes = \mathcal{F}_{\mathcal{Q}}$ . That is,  $\mathcal{F}_{\mathcal{G}}/\boxtimes = \mathcal{F}_{\mathcal{G}/\boxtimes}$ .

We are now ready to study the relation between the invariant lattices  $L_{F_{\mathcal{G}}}$  of a network  $\mathcal{G}$  and corresponding invariant lattice of its quotient network  $\mathcal{Q} = \mathcal{G}/\boxtimes$ .

The following is direct from lemma 3.16.

**Corollary 3.17.** Consider networks  $\mathcal{G}$  and  $\mathcal{Q}$  such that  $\mathcal{Q} = \mathcal{G}/\boxtimes$  for some  $\boxtimes \in \Lambda_{\mathcal{G}}$ . Then,  $\Lambda_{\mathcal{Q}} = \Lambda_{\mathcal{G}/\boxtimes}$ .  $\square$

We now generalize this to lattices of  $F$ -invariant partitions.

**Theorem 3.6.** *Consider networks  $\mathcal{G}$  and  $\mathcal{Q}$  such that  $\mathcal{Q} = \mathcal{G}/\bowtie$  for some  $\bowtie \in \Lambda_{\mathcal{G}}$ , and subsets  $F_{\mathcal{G}} \subseteq \mathcal{F}_{\mathcal{G}}$ ,  $F_{\mathcal{Q}} \subseteq \mathcal{F}_{\mathcal{Q}}$  such that  $F_{\mathcal{Q}} = F_{\mathcal{G}}/\bowtie$ .*

*Then, for partitions  $\mathcal{A}_{\mathcal{G}} \leq \mathcal{T}_{\mathcal{G}}$  and  $\mathcal{A}_{\mathcal{Q}} \leq \mathcal{T}_{\mathcal{Q}}$  such that  $\mathcal{A}_{\mathcal{G}} \geq \bowtie$  and  $\mathcal{A}_{\mathcal{Q}} = \mathcal{A}_{\mathcal{G}}/\bowtie$ , we have that  $\mathcal{A}_{\mathcal{G}} \in L_{F_{\mathcal{G}}}$  if and only if  $\mathcal{A}_{\mathcal{Q}} \in L_{F_{\mathcal{Q}}}$ . That is,  $L_{F_{\mathcal{Q}}} = L_{F_{\mathcal{G}}}/\bowtie$ .  $\square$*

*Proof.* We consider the partitions  $\bowtie$ ,  $\mathcal{A}_{\mathcal{G}}$  and  $\mathcal{A}_{\mathcal{Q}}$  to be represented by partition matrices  $P$ ,  $P_{\mathcal{G}}$  and  $P_{\mathcal{Q}}$  respectively, such that  $P_{\mathcal{G}} = PP_{\mathcal{Q}}$ .

Assume  $\mathcal{A}_{\mathcal{G}} \in L_{F_{\mathcal{G}}}$ . Note that for any  $g \in F_{\mathcal{Q}}$ , there is some  $f \in F_{\mathcal{G}}$  such that  $g = f/\bowtie$ . Then, from the fact that  $\bowtie$  is balanced, we know from definition 3.6 that  $f(P_{\mathcal{G}}\bar{x}) = f(PP_{\mathcal{Q}}\bar{x}) = P_{\mathcal{G}}(P_{\mathcal{Q}}\bar{x})$ . On the other hand, from the fact that  $\mathcal{A}_{\mathcal{G}} \in L_{F_{\mathcal{G}}}$  we know that  $f(P_{\mathcal{G}}\bar{x}) = P_{\mathcal{G}}\bar{f}(\bar{x}) = PP_{\mathcal{Q}}\bar{f}(\bar{x})$  for some  $\bar{f}$ . Therefore,  $P_{\mathcal{G}}(P_{\mathcal{Q}}\bar{x}) = PP_{\mathcal{Q}}\bar{f}(\bar{x})$ . Since  $P$  always has full column rank, it is left-invertible, which means that  $g(P_{\mathcal{Q}}\bar{x}) = P_{\mathcal{Q}}\bar{f}(\bar{x})$ . That is,  $\mathcal{A}_{\mathcal{Q}}$  is  $g$ -invariant for any  $g \in F_{\mathcal{Q}}$ , from which we conclude that  $\mathcal{A}_{\mathcal{G}} \in L_{F_{\mathcal{G}}}$  implies  $\mathcal{A}_{\mathcal{Q}} \in L_{F_{\mathcal{Q}}}$ . We now prove the converse direction.

Assume  $\mathcal{A}_{\mathcal{Q}} \in L_{F_{\mathcal{Q}}}$ . Note that for any  $f \in F_{\mathcal{G}}$ , its quotient  $g = f/\bowtie$  is in  $F_{\mathcal{Q}}$ . Then, from the fact that  $\mathcal{A}_{\mathcal{Q}} \in L_{F_{\mathcal{Q}}}$  we know that  $g(P_{\mathcal{Q}}\bar{x}) = P_{\mathcal{Q}}\bar{g}(\bar{x})$  for some  $\bar{g}$ . Multiplying on the left by  $P$  gives us  $Pg(P_{\mathcal{Q}}\bar{x}) = PP_{\mathcal{Q}}\bar{g}(\bar{x}) = P_{\mathcal{G}}\bar{g}(\bar{x})$ . On the other hand, from the fact that  $\bowtie$  is balanced, we have from definition 3.6 that  $Pg(P_{\mathcal{Q}}\bar{x}) = f(PP_{\mathcal{Q}}\bar{x}) = f(P_{\mathcal{G}}\bar{x})$ . Therefore,  $f(P_{\mathcal{G}}\bar{x}) = P_{\mathcal{G}}\bar{g}(\bar{x})$ . That is,  $\mathcal{A}_{\mathcal{G}}$  is  $f$ -invariant for any  $f \in F_{\mathcal{G}}$ , from which we conclude that  $\mathcal{A}_{\mathcal{Q}} \in L_{F_{\mathcal{Q}}}$  implies  $\mathcal{A}_{\mathcal{G}} \in L_{F_{\mathcal{G}}}$ , which completes the proof.  $\blacksquare$

Note that this is in agreement with corollary 3.17 when we consider the particular case  $F_{\mathcal{G}} = \mathcal{F}_{\mathcal{G}}$  and  $F_{\mathcal{Q}} = \mathcal{F}_{\mathcal{Q}}$ . The following is now immediate from theorem 3.6 and lemma 3.9.

**Corollary 3.18.** *Consider networks  $\mathcal{G}$  and  $\mathcal{Q}$  such that  $\mathcal{Q} = \mathcal{G}/\bowtie$  for some  $\bowtie \in \Lambda_{\mathcal{G}}$ , and subsets  $F_{\mathcal{G}} \subseteq \mathcal{F}_{\mathcal{G}}$ ,  $F_{\mathcal{Q}} \subseteq \mathcal{F}_{\mathcal{Q}}$  such that  $F_{\mathcal{Q}} = F_{\mathcal{G}}/\bowtie$ .*

*Then, for  $\mathcal{A} \leq \mathcal{T}_{\mathcal{G}}$  such that  $\mathcal{A} \geq \bowtie$ , we have that*

$$\text{cir}_{F_{\mathcal{G}}}(\mathcal{A})/\bowtie = \text{cir}_{F_{\mathcal{Q}}}(\mathcal{A}/\bowtie). \quad (29)$$

$\square$

## 4. Network connectivity

In this section we summarize the definitions and notation necessary to study the connectivity of a directed network and relate those characteristics to its dynamics.

### 4.1. Neighborhoods and reachability

**Definition 4.1.** *The **in-neighborhood**  $\mathcal{N}^-$  of a cell  $c \in \mathcal{C}$ , is the subset of cells  $d \in \mathcal{C}$  such that the total of directed edges from  $d$  to  $c$  has a non-zero weight. Similarly, its **out-neighborhood**, denoted  $\mathcal{N}^+(c)$ , is the subset of cells  $d \in \mathcal{C}$  such that the total of directed edges from  $c$  to  $d$  has a non-zero weight.  $\square$*

In our context, this means that if  $M$  is an in-adjacency matrix of a network, we have that  $\mathcal{N}^-(c) = \{d \in \mathcal{C}: m_{cd} \neq 0_{ij}, i = \mathcal{T}(c), j = \mathcal{T}(d)\}$ . Note that the commutative monoid structure allows us to encode arbitrary (finite) edges from a cell  $d$  to a cell  $c$  using a single element. This definition says that even if there are non-zero edges from  $d$  to  $c$ , if their total effect is equivalent to a non-edge ( $0_{ij}$ ), then  $d$  is not in  $\mathcal{N}^-(c)$ .

**Remark 11.** We often denote  $c \in \mathcal{N}^-(d)$ , or equivalently,  $d \in \mathcal{N}^+(c)$ , by  $c \rightarrow d$ .  $\square$

**Definition 4.2.** The **cumulative in-neighborhood**  $\mathcal{V}^-$  of a cell  $c \in \mathcal{C}$ , is defined as  $\mathcal{V}^-(c) := c \cup \mathcal{N}^-(c)$ .  $\square$

**Definition 4.3.** The  $k^{\text{th}}$  cumulative in-neighborhood  $\mathcal{V}_k^-$  of a cell  $c \in \mathcal{C}$ , is defined recursively as

$$\mathcal{V}_0^-(c) := c, \quad (30)$$

$$\mathcal{V}_k^-(c) := \bigcup_{d \in \mathcal{V}_{k-1}^-(c)} \mathcal{V}^-(d), \quad k > 0. \quad (31)$$

That is, the set of cells from which there is a directed path of at most  $k$  edges that ends at  $c$ . Note that  $\mathcal{V}_1^- = \mathcal{V}^-$ . The  $k^{\text{th}}$  cumulative out-neighborhood  $\mathcal{V}_k^+$  is defined similarly by replacing the signs.  $\square$

**Lemma 4.1.** The sequence  $(\mathcal{V}_k^-)_{k \geq 0}$  is monotonically increasing, that is,

$$\mathcal{V}_k^-(c) \subseteq \mathcal{V}_{k+1}^-(c), \quad k \geq 0.$$

Moreover, if  $\mathcal{V}_k^-(c) = \mathcal{V}_{k+1}^-(c)$  for some  $k \geq 0$ , then the recursion (31) has reached a fixed point, which means that  $\mathcal{V}_k^-(c) = \mathcal{V}_n^-(c)$  for all  $n \geq k$ .  $\square$

This result motivates the following definition.

**Definition 4.4.** The **in-reachability**  $\mathcal{R}^-$  of a cell  $c \in \mathcal{C}$ , is defined as

$$\mathcal{R}^-(c) := \bigcup_{k \geq 0} \mathcal{V}_k^-(c). \quad (32)$$

That is, the set of cells from which there is a finite directed path that ends at  $c$ .

The out-reachability  $\mathcal{R}^+$  is defined similarly by replacing the signs.  $\square$

**Remark 12.** We often denote  $c \in \mathcal{R}^-(d)$ , or equivalently,  $d \in \mathcal{R}^+(c)$ , by  $c \rightsquigarrow d$ , illustrating that there is a direct path starting at cell  $c$  and ending at cell  $d$ .  $\square$

**Corollary 4.1.** For any cell  $c$  we have that  $\mathcal{V}_k^-(c) \subseteq \mathcal{R}^-(c)$  for all  $k \geq 0$ . Moreover, when considering a finite amount of cells, equality is achieved at some finite  $k$ .  $\square$

**Corollary 4.2.** If  $c \in \mathcal{R}^-(d)$ , then  $\mathcal{R}^-(c) \subseteq \mathcal{R}^-(d)$ . That is, if  $c \rightsquigarrow d$ , then, for every cell  $e$  such that  $e \rightsquigarrow c$  we also have that  $e \rightsquigarrow d$ .  $\square$

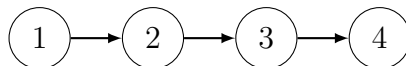

Figure 7: Simple chain of 4 cells.

**Example 4.1.** Consider the simple network in figure 7. Cell 3 receives an edge from cell 2, that is,  $\mathcal{N}^-(3) = \{2\}$ . Its cumulative in-neighborhood is given by  $\mathcal{V}^-(3) = 3 \cup \mathcal{N}^-(3) = \{2, 3\}$ . Using the definition, its second cumulative in-neighborhood is  $\mathcal{V}_2^-(3) = \mathcal{V}^-(2) \cup \mathcal{V}^-(3)$ , which results in  $\{1, 2\} \cup \{2, 3\} = \{1, 2, 3\}$ , which are the cells that have a directed path to cell 3 with a length of two or less. Note that this is already the maximal cumulative in-neighborhood of cell 3 since  $\mathcal{V}_3^-(3) = \mathcal{V}^-(1) \cup \mathcal{V}^-(2) \cup \mathcal{V}^-(3)$  again equals  $\{1, 2, 3\}$ . That is,  $\mathcal{V}_2^-(3) = \mathcal{R}^-(3)$ .

Furthermore, the point at which the cumulative in-neighborhoods equals the in-reachability set depends on the particular cell of the network. For instance, we have that  $\mathcal{V}_0^-(1) = \mathcal{R}^-(1) = \{1\}$  and  $\mathcal{V}_3^-(4) = \mathcal{R}^-(4) = \{1, 2, 3, 4\}$ .

Finally, we have that  $\mathcal{R}^-(1) \subset \mathcal{R}^-(2) \subset \mathcal{R}^-(3) \subset \mathcal{R}^-(4)$  since each cell has a direct path to every cell that is identified with an higher number. In particular, the set inclusions are strict, that is, there are no two cells with the same in-reachability set. Note that this would require directed loops, that is,  $\mathcal{R}^-(c) = \mathcal{R}^-(d)$  is equivalent to  $\mathcal{R}^-(c) \subseteq \mathcal{R}^-(d)$  and  $\mathcal{R}^-(d) \subseteq \mathcal{R}^-(c)$ , which implies  $c \in \mathcal{R}^-(d)$  and  $d \in \mathcal{R}^-(c)$ . That is,  $c \rightsquigarrow d$  and  $d \rightsquigarrow c$ .  $\square$

#### 4.2. Dynamics from in-neighborhoods

Consider a network  $\mathcal{G}$  and an  $\mathcal{G}$ -admissible state set  $\mathbb{X}$  such that a state  $\mathbf{x} \in \mathbb{X}$  evolves (either discretely or continuously) according to a  $\mathcal{G}$ -admissible function  $f \in \mathcal{F}_{\mathcal{G}}$ . That is,

$$\mathbf{x}^+ / \dot{\mathbf{x}} = f(\mathbf{x}). \quad (33)$$

From the definition of admissibility, the component  $f_c$  of an  $\mathcal{G}$ -admissible function  $f$  is only dependent on the states associated with the cells in  $\mathcal{V}^-(c)$ . This allows us to relate the dynamics of the system to the neighborhoods of cells. We now show how  $\mathcal{V}_k^-$  in particular is related to the evolution of an admissible system in both the discrete and continuous cases.

**Theorem 4.1.** Consider a network that evolves discretely according to a function  $f \in \mathcal{F}_{\mathcal{G}}$ . Then,  $x_c[n], x_c[n+1], \dots, x_c[n+k]$  are fully determined by the set of states  $\{x_d[n]\}$ , with  $d \in \mathcal{V}_k^-(c)$ .  $\square$

*Proof.* It is enough to just prove that  $x_c[n+k]$  is fully determined, the rest comes directly from the monotonicity of  $(\mathcal{V}_k^-)_{k \geq 0}$ .

The proof is by induction. Assume this to be true for some  $k \geq 0$ . Then,  $x_c[n+k+1]$  is fully determined by the set of states  $\{x_d[n+1]\}$  with  $d \in \mathcal{V}_k^-(c)$ . From  $f$  being  $\mathcal{G}$ -admissible, the states  $\{x_d[n+1]\}$  themselves are fully determined by  $\{x_e[n]\}$  with  $e \in \mathcal{V}_1^-(d)$  for each  $d \in \mathcal{V}_k^-(c)$ . This means that  $x_c[n+k+1]$  is fully determined by the states  $\{x_d[n]\}$  with  $d \in \mathcal{V}_{k+1}^-(c)$ , which proves the induction step. The base case  $k = 0$  is trivial.  $\blacksquare$

**Theorem 4.2.** Consider a system that evolves continuously according to a function  $f \in \mathcal{F}_{\mathcal{G}}$ . Then, assuming sufficient differentiability, the derivatives up to  $k^{\text{th}}$  order at

time  $t$ , that is,  $x_c(t), \dot{x}_c(t), \dots, x_c^{(k)}(t)$  are fully determined by the set of states  $\{x_d(t)\}$ , with  $d \in \mathcal{V}_k^-(c)$ .  $\square$

*Proof.* It is enough to just prove that  $x_c^{(k)}(t)$  is fully determined, the rest comes directly from the monotonicity of  $(\mathcal{V}_k^-)_{k \geq 0}$ .

The proof is by induction. Assume this to be true for some  $k \geq 0$ . Then, there is a function  $g$  such that

$$x_c^{(k)}(t) = g(\{x_d(t) : d \in \mathcal{V}_k^-(c)\}).$$

Differentiating on both sides gives

$$x_c^{(k+1)}(t) = \sum_{d \in \mathcal{V}_k^-(c)} \frac{\partial g}{\partial x_d} x_d^{(1)}(t).$$

From  $f$  being  $\mathcal{G}$ -admissible, the first derivatives  $\{x_d^{(1)}(t)\}$  are fully determined by  $\{x_e(t)\}$  with  $e \in \mathcal{V}_1^-(d)$  for each  $d \in \mathcal{V}_k^-(c)$ . This means that  $x_c^{(k+1)}(t)$  is fully determined by the states  $\{x_d(t)\}$  with  $d \in \mathcal{V}_{k+1}^-(c)$ . The base case  $k = 0$  is trivial.  $\blacksquare$

We now show that knowledge about the in-reachability  $\mathcal{R}^-$  of a cell fully defines its evolution.

**Theorem 4.3.** *Consider a network that evolves either discretely or continuously, according to a function  $f \in \mathcal{F}_{\mathcal{G}}$ . Then, the whole  $(x_c[k])_{k \geq n} / x_c(\cdot)$  is fully determined by the set of states  $x_d[n] / x_d(t)$  for  $d \in \mathcal{R}^-(c)$ .*  $\square$

*Proof.* From corollary 4.2, we know that for any in-reachability set  $\mathcal{R}^-(c) = \mathcal{S}$ , any cell  $d \in \mathcal{S}$  has its own in-reachability contained within that same set. That is,  $\mathcal{R}^-(d) \subseteq \mathcal{S}$ . Since  $\mathcal{V}^-(d) \subseteq \mathcal{R}^-(d)$ , we have that  $\mathcal{V}^-(d) \subseteq \mathcal{S}$ .

From admissibility, we know that the dynamics of a cell  $d$  are a function of the states of the cells in  $\mathcal{V}^-(d)$ . Therefore, we can constrain our network to the subset of cells  $\mathcal{S}$  while preserving all their dependencies within that same set. That is, knowledge about the initial conditions of the cells  $\mathcal{S}$  is enough to fully determine the evolution of the induced subsystem.  $\blacksquare$

**Remark 13.** *Note that for the discrete time case (theorem 4.1), this result is direct from corollary 4.1. However, to extend the continuous time case (theorem 4.2) in the same manner, we would have to require the dynamics to be analytical, which is usually too much to ask for. Often, only the Lipschitz condition is assumed. Our approach in the previous proof works for both the discrete and continuous cases.*  $\square$

**Corollary 4.3.** *Consider a subset of cells  $\mathcal{S}$  in a network that is an in-reachability set. That is,  $\mathcal{S} = \mathcal{R}^-(c) \subseteq \mathcal{C}$  for some  $c \in \mathcal{C}$ . Then, for any solution  $\mathbf{x}(t)$  of the whole system, constraining  $\mathbf{x}(t)$  to the cells in  $\mathcal{S}$  gives us a valid solution to the subnetwork induced by  $\mathcal{S}$ . Conversely, for a solution  $\mathbf{x}_{\mathcal{S}}(t)$  on the subnetwork, there will be a solution on the whole network that is an extension of it.*  $\square$

*Proof.* This is direct from theorem 4.3.  $\blacksquare$

### 4.3. Strongly connected components and root dependency

To study the in-reachability sets  $\mathcal{R}^-$  of the network, it is useful to decompose its graph into strongly connected components (**SCC**).

**Definition 4.5.** Two cells  $c, d \in \mathcal{C}$  are said to be **strongly connected** if  $\mathcal{R}^-(c) = \mathcal{R}^-(d)$ . That is, there are directed paths  $d \rightsquigarrow c$  and  $c \rightsquigarrow d$ .  $\square$

**Remark 14.** Note that the strongly connected property induces a partition on the set of cells  $\mathcal{C}$ . The subsets of this partition are called the **SCCs**.  $\square$

Since two cells in the same SCC have exactly the same in-reachability set, that is  $\mathcal{R}^-(c) = \mathcal{R}^-(d)$  for all  $c, d \in \mathcal{S}_i$ , we simply refer to it as  $\mathcal{R}^-(\mathcal{S}_i)$ .

**Definition 4.6.** The **condensation graph** is obtained by representing each SCC  $\mathcal{S}_i$  by a block and connecting  $\mathcal{S}_i \rightarrow \mathcal{S}_j$  for  $i \neq j$ , if there are cells  $c_i \in \mathcal{S}_i, c_j \in \mathcal{S}_j$  such that  $c_i \rightarrow c_j$ .  $\square$

The diagram obtained is **blockwise acyclic**. Note that for  $c_i \in \mathcal{S}_i, c_j \in \mathcal{S}_j, i \neq j$ , the existence of a directed path  $c_i \rightsquigarrow c_j$  is equivalent to the existence of a directed path  $\mathcal{S}_i \rightsquigarrow \mathcal{S}_j$  in the condensation graph. Moreover, if in the condensation graph there is a direct path  $\mathcal{S}_i \rightsquigarrow \mathcal{S}_j$  then  $\mathcal{S}_i \subseteq \mathcal{R}^-(\mathcal{S}_j)$ .

This decomposition can be done very efficiently in time  $O(|\mathcal{C}| + |\mathcal{E}|)$ , where  $\mathcal{E}$  denotes the set of edges, using for instance Tarjan's algorithm [14].

Building on the concept of SCCs, we are now ready to define a decomposition based on root dependency components (**RDC**).

**Definition 4.7.** An SCC  $\mathcal{S}_i$  is called a **root** if there are no other SCCs that have a directed path to it. That is,  $\mathcal{S}_i = \mathcal{R}^-(\mathcal{S}_i)$ .  $\square$

**Definition 4.8.** Two cells  $c, d \in \mathcal{C}$  are said to have the same **root dependency** if  $\mathcal{R}^-(c), \mathcal{R}^-(d)$  contain **exactly** the same subset of roots.  $\square$

**Remark 15.** Note that the property of having the same root dependency induces a partition on the set of cells  $\mathcal{C}$ . The subsets of this partition are called the **root dependency components**. Moreover, note that in network with  $n$  roots, this partition has at most  $2^n - 1$  disjoint subsets, since there is no cell that does not depend on any root.  $\square$

The following is straightforward from the definitions.

**Corollary 4.4.** The partition formed by the SCCs is finer than the one formed by the RDCs.  $\square$

**Example 4.2.** Consider the network in figure 8a. Note that it has four different SCCs. In particular,  $\mathcal{S}_1 = \{1, 2, 3\}$ ,  $\mathcal{S}_2 = \{4\}$ ,  $\mathcal{S}_3 = \{5\}$  and  $\mathcal{S}_4 = \{6, 7\}$ . This induces the partition  $\{\{1, 2, 3\}, \{4\}, \{5\}, \{6, 7\}\}$  on the set of cells in the network. We form the condensation graph at figure 8b by representing each SCC by a block and connecting them appropriately. That is, we have that  $2 \rightarrow 4$ ,  $3 \rightarrow 6$  and  $5 \rightarrow 7$ , which means that we need to connect  $\mathcal{S}_1 \rightarrow \mathcal{S}_2$ ,  $\mathcal{S}_1 \rightarrow \mathcal{S}_4$  and  $\mathcal{S}_3 \rightarrow \mathcal{S}_4$ , respectively.

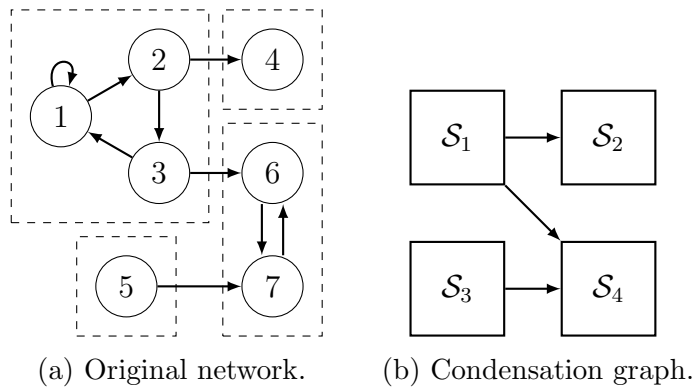

Figure 8: Decomposition of a network into its strongly connected components.

Using the condensation graph, it is very easy to see that the in-reachability sets of the SCCs are  $\mathcal{R}^-(\mathcal{S}_1) = \mathcal{S}_1$ ,  $\mathcal{R}^-(\mathcal{S}_2) = \mathcal{S}_1 \cup \mathcal{S}_2$ ,  $\mathcal{R}^-(\mathcal{S}_3) = \mathcal{S}_3$  and  $\mathcal{R}^-(\mathcal{S}_4) = \mathcal{S}_1 \cup \mathcal{S}_3 \cup \mathcal{S}_4$ . This means that the network has two roots,  $\mathcal{S}_1$  and  $\mathcal{S}_3$ . With two roots, we can partition the cells of the network in, at most, three RDCs. That is, the ones that depend on the root  $\mathcal{S}_1$  but not  $\mathcal{S}_3$  ( $\mathcal{S}_1 \cup \mathcal{S}_2$ ), the ones that depend on  $\mathcal{S}_3$  but not  $\mathcal{S}_1$  ( $\mathcal{S}_3$ ) and the ones that depend on both  $\mathcal{S}_1$  and  $\mathcal{S}_3$  ( $\mathcal{S}_4$ ). Therefore, the partition induced by the RDCs is  $\{\mathcal{S}_1 \cup \mathcal{S}_2, \mathcal{S}_3, \mathcal{S}_4\} = \{\{1, 2, 3, 4\}, \{5\}, \{6, 7\}\}$ , which is coarser than the partition of SCCs.  $\square$

## 5. In-reachability based classification of synchrony partitions

Motivated by the influence of that different types of in-neighborhoods have on the dynamics of a network, we introduce an in-reachability based classification scheme for general partitions.

### 5.1. Strong, rooted and weak partitions

In this section we classify the colors of partitions according to their relationship to the structure of the network. To this purpose, we pay particular attention to the in-reachability sets, which fully determine the dynamical evolution of the cells, and the SCCs, which are the natural way of segmenting them.

Consider the network in figure 8. Note that  $\mathcal{S}_1$  and  $\mathcal{S}_3$  are roots, that is,  $\mathcal{R}^-(\mathcal{S}_1) = \mathcal{S}_1$  and  $\mathcal{R}^-(\mathcal{S}_3) = \mathcal{S}_3$ . From theorem 4.3, the evolution of each of those sets can be completely determined without regard to the rest of the network. That is, for any  $\mathcal{G}$ -admissible function  $f$ , we can constrain and evaluate it separately in the sets of cells  $\mathcal{S}_1, \mathcal{S}_3$ .

Consider a partition  $\mathcal{A}$  in this network such that there are cells in  $\mathcal{S}_1$  and  $\mathcal{S}_3$  that share the same color, that is, there are two cells  $c_1 \in \mathcal{S}_1, c_3 \in \mathcal{S}_3$  such that  $\mathcal{A}(c_1) = \mathcal{A}(c_3)$ .

Since the two SCCs evolve completely decoupled from one another, any disturbance on  $c_1$  would not be felt by  $c_3$  and vice-versa. Moreover, there is no cell that could simultaneously affect both  $c_1$  and  $c_3$  and act as a pacemaker to drive them to a common

state. However, this lack of feedback between these cells does not mean that it would be impossible for the synchrony pattern determined by  $\mathcal{A}$  to appear in a physical system. That, is for states sufficiently close to the polydiagonal  $\Delta_{\mathcal{A}}^{\times}$  to be driven back to  $\Delta_{\mathcal{A}}^{\times}$ , or at least stay close to it. This could be achieved if, for instance, both  $x_{c_1}(t)$  and  $x_{c_3}(t)$  converge to the same stable equilibrium point.

On the other hand, if  $x_{c_1}(t), x_{c_3}(t)$  converge to the same limit cycle, we would not expect such synchrony space to be stable, since there would be no mechanism that could counteract a possible phase offset. In particular, note that if  $\mathbf{x}_{\mathcal{S}_1}(t)$  is a solution for the subnetwork induced by  $\mathcal{S}_1$ , the time shifted version  $\mathbf{x}_{\mathcal{S}_1}(t - \delta)$  is also a solution. Therefore, phase synchronism with  $\mathcal{S}_3$  would never happen unless we started with precise initial conditions.

Assume now that instead, there are two cells  $c_2 \in \mathcal{S}_2, c_4 \in \mathcal{S}_4$  of the same color, that is  $\mathcal{A}(c_2) = \mathcal{A}(c_4)$ . Their in-reachability sets are  $\mathcal{R}^-(\mathcal{S}_2) = \mathcal{S}_2 \cup \mathcal{S}_1$  and  $\mathcal{R}^-(\mathcal{S}_4) = \mathcal{S}_4 \cup \mathcal{S}_1 \cup \mathcal{S}_3$  respectively. Now, although there is still no feedback between one another, their in-reachability sets intersect in  $\mathcal{S}_1$ . Thus, it could still be possible for  $c_2$  and  $c_4$  to maintain synchronism with non-trivial behavior if  $\mathcal{S}_1$  is driving them to do so.

This shows that the structure of the network can make a crucial difference in the qualitative behavior of the invariant synchrony patterns, which motivates the following definitions.

**Definition 5.1.** A color  $A$  on a partition of a network  $\mathcal{G}$  is

- **Strong** if all the cells of that color are in the same SCC. That is,

$$c, d \in A \implies \mathcal{R}^-(c) = \mathcal{R}^-(d), \quad (34)$$

or equivalently,

$$\bigcap_{c \in A} \mathcal{R}^-(c) = \bigcup_{c \in A} \mathcal{R}^-(c). \quad (35)$$

- **Rooted** if it is not strong but there is some cell (root) in  $\mathcal{G}$  that has a directed path to all the cells of that color. That is,

$$\emptyset \subset \bigcap_{c \in A} \mathcal{R}^-(c) \subset \bigcup_{c \in A} \mathcal{R}^-(c). \quad (36)$$

- **Weak** if it is neither strong nor rooted. That is,

$$\bigcap_{c \in A} \mathcal{R}^-(c) = \emptyset. \quad (37)$$

□

Clearly, every color is of one, and only one, of these three types. The following properties are direct from the definition.

**Lemma 5.1.** Consider a strong color  $A_s$ , a rooted color  $A_r$ , and a weak color  $A_w$ . Then, the following is true

- If  $A \subseteq A_s$ , then  $A$  is strong.
- If  $A \subseteq A_r$ , then  $A$  is either rooted or strong.



- If  $A_r \subseteq A$ , then  $A$  is either rooted or weak.
- If  $A_w \subseteq A$ , then  $A$  is weak.

□

Note that this definition is with respect to a particular color and the connectivity of  $\mathcal{G}$ . That is, it evaluates a dangling color, without the need for considering an underlying partition or even worrying if it is balanced or not.

Using the classification of individual colors, we classify a whole partition according to the following definition.

**Definition 5.2.** *A partition  $\mathcal{A}$  on a network  $\mathcal{G}$  is*

- **Strong** if all of its colors are strong.
- **Rooted** if it is not strong but all of its colors are either rooted or strong. That is, it has at least one rooted color.
- **Weak** if any of its colors is weak.

□

Clearly, every partition is of one, and only one, of these three types. Similarly to lemma 5.1, the following properties are direct.

**Lemma 5.2.** *Consider a strong partition  $\mathcal{A}_s$ , a rooted partition  $\mathcal{A}_r$  and a weak partition  $\mathcal{A}_w$ . Then, the following is true*

- If  $\mathcal{A} \leq \mathcal{A}_s$ , then  $\mathcal{A}$  is strong.
- If  $\mathcal{A} \leq \mathcal{A}_r$ , then  $\mathcal{A}$  is either rooted or strong.
- If  $\mathcal{A}_r \leq \mathcal{A}$ , then  $\mathcal{A}$  is either rooted or weak.
- If  $\mathcal{A}_w \leq \mathcal{A}$ , then  $\mathcal{A}$  is weak.

□

The following is straightforward.

**Corollary 5.1.** *If  $A$  is a singleton color, then is it strong. Furthermore, the trivial partition  $\perp$ , which only has singleton colors is always strong.*

□

We now relate our classification of partitions to the network connectivity according to the decomposition into SCCs and RDCs, as defined in section 4.3. The two following results are direct from the definitions.

**Lemma 5.3.** *A partition is strong if and only if it is finer than the partition of SCCs.*

□

We use the term **non-weak** to denote partitions or colors that are not weak, that is, either rooted or strong.

**Lemma 5.4.** *A partition finer than the partition of RDCs is non-weak.*

□

In section 3.5 we have seen that every subset of partitions that are  $F$ -invariant always forms a lattice  $L_F$ , regardless of the particular subset of functions  $F \subseteq \mathcal{F}_{\mathcal{G}}$  of interest. Furthermore, we know that its minimal element is always the trivial partition  $\perp$ , which is strong. Also, given any two partitions  $\mathcal{A}_1, \mathcal{A}_2 \in L_F$ , their least upper bound is always given by  $\mathcal{A}_1 \vee \mathcal{A}_2$ , where  $\vee$  denotes the partition join operation as defined in lemma 3.3. We now show how the join operation interacts with the proposed classification scheme.

**Lemma 5.5.** *For any pair of strong partitions  $\mathcal{A}_1, \mathcal{A}_2$  on a network  $\mathcal{G}$ , their join  $\mathcal{A} = \mathcal{A}_1 \vee \mathcal{A}_2$  is strong.  $\square$*

*Proof.* Since  $\mathcal{A}_1, \mathcal{A}_2$  are strong, from lemma 5.3, they are finer than the partition of SCCs. Then,  $\mathcal{A} = \mathcal{A}_1 \vee \mathcal{A}_2$  is also finer than the partition of SCCs. From lemma 5.3 again,  $\mathcal{A}$  is strong.  $\blacksquare$

This result, together with lemma 5.2, allows us to understand how the join operation affects our connectivity-based classification of general partitions. This is summarized in table 1, where  $S$ ,  $R$  and  $W$  denote the partition classifications of strong, rooted and weak, respectively. So far we have not made any assumptions about the partitions.

Table 1: Join table for general partitions.

$\vee$	S	R	W
S	S	R/W	W
R	R/W	R/W	W
W	W	W	W

Moreover, we see in table 1 that there are entries in which the classification is not completely defined. In particular, there are cases where the result of the join could be either rooted or weak ( $R/W$ ).

Denote the subset of strong partitions in a lattice  $L_F$  by  $L_F^S$  and the subset of non-weak partitions by  $L_F^{NW}$ . Then, we have that

$$L_F^S \subseteq L_F^{NW} \subseteq L_F. \tag{38}$$

From lemma 5.5, together with the fact that the trivial partition  $\perp$  is strong, we know that  $L_F^S$  always forms a sublattice of  $L_F$  with a top element  $\top_F^S$ . On the other hand,  $L_F^{NW}$  might or might not be a lattice. This is illustrated in the following example.

**Example 5.1.** *Consider the network in figure 9a and its respective lattice of balanced partitions  $\Lambda$  in figure 9b. Consider the full edges to have a weight of 1 and the dashed edges to have weights of  $-1$ .*

*In the lattice schematics, the partitions are colored according to their type such that strong partitions are in white, rooted ones are light gray and weak ones are in dark gray. Note that  $\Lambda^S$ , consisting of partitions in white, forms a sublattice of  $\Lambda$  with top partition*

$\top^S = 12/34$ . On the other hand,  $\Lambda^{NW}$  does not form a lattice. In particular, if we join one of  $12/45$ ,  $12/345$  with one of  $25/34$ ,  $125/34$ , we get  $12345$ , which is a weak partition.  $\square$

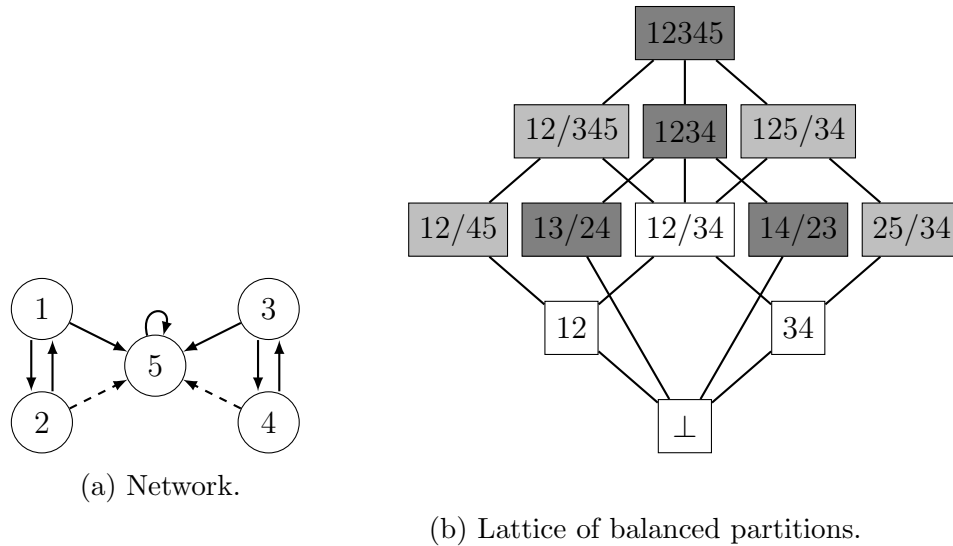

Figure 9: A network and its lattice of balanced partitions.

From lemma 5.2, we know that knowledge of the top partition  $\top_F$  of a lattice  $L_F$ , with  $F \subseteq \mathcal{F}_G$ , can give us important information about the whole lattice.

**Corollary 5.2.** *If the top partition  $\top_F$  of a lattice  $L_F$ , with  $F \subseteq \mathcal{F}_G$ , is non-weak, then all of its partitions are non-weak. Moreover, if  $\top_F$  is strong, then all partitions are also strong.*  $\square$

We now show how the top strong partition  $\top_F^S$  is given in terms of the  $cir_F$  function.

**Corollary 5.3.** *Consider a network  $\mathcal{G}$  with cell type partition  $\mathcal{T}$ . Represent its SCCs according to a partition  $\mathcal{A}$ . Then,  $\top_F^S = cir_F(\mathcal{T} \wedge \mathcal{A})$ .*  $\square$

Note that  $L_F^{NW}$  is not necessarily a lattice and there might exist multiple locally maximal non-weak partitions, as in example 5.1. In the following section we see that under some relatively tame assumptions, the resulting join table becomes much cleaner and we can guarantee that  $L_F^{NW}$  is a lattice with some top partition  $\top_F^{NW}$ .

## 5.2. Neighborhood color matching

In this section we present a sequence of progressively weaker assumptions about a partition on a network. We show that the weakest of them is enough to fix the remaining uncertain entries of table 1 into table 2.

We use the notation convention  $\mathcal{A}(\mathbf{s}) := \bigcup_{c \in \mathbf{s}} \mathcal{A}(c)$ . That is,  $\mathcal{A}(\mathbf{s})$  denotes a subset of colors that are present in the set of cells  $\mathbf{s} \subseteq \mathcal{C}$ , according to the coloring assigned by  $\mathcal{A}$ .

**Definition 5.3.** Consider a function  $\mathcal{U}$  that assigns to each cell a subset of cells, that is,  $\mathcal{U}: \mathcal{C} \rightarrow 2^{\mathcal{C}}$ . Then, a partition  $\mathcal{A}$  on  $\mathcal{C}$  is  $\mathcal{U}$ -**matched** if for every cell of any given color, the set of colors after applying  $\mathcal{U}$  are exactly the same. That is,

$$\mathcal{A}(c) = \mathcal{A}(d) \implies \mathcal{A}(\mathcal{U}(c)) = \mathcal{A}(\mathcal{U}(d)). \quad (39)$$

□

**Corollary 5.4.** The trivial partition  $\perp$  is  $\mathcal{U}$ -matched for every function  $\mathcal{U}$ . □

In this work, we are interested in the situation where the function  $\mathcal{U}$  in definition 5.3 denotes a neighborhood as described in section 4.1, such as  $\mathcal{N}^-$ ,  $\mathcal{V}^-$ ,  $\mathcal{V}_k^-$  or  $\mathcal{R}^-$ .

**Corollary 5.5.** If a partition  $\mathcal{A}$  is  $\mathcal{N}^-$ -matched, then, it is  $\mathcal{V}^-$ -matched. □

*Proof.* If  $\mathcal{A}(c) = \mathcal{A}(d)$ , from assumption we have that  $\mathcal{A}(\mathcal{N}^-(c)) = \mathcal{A}(\mathcal{N}^-(d))$ . Then, we have that

$$\begin{aligned} \mathcal{A}(c) \cup \mathcal{A}(\mathcal{N}^-(c)) &= \mathcal{A}(d) \cup \mathcal{A}(\mathcal{N}^-(d)) \\ \mathcal{A}(c \cup \mathcal{N}^-(c)) &= \mathcal{A}(d \cup \mathcal{N}^-(d)) \\ \mathcal{A}(\mathcal{V}^-(c)) &= \mathcal{A}(\mathcal{V}^-(d)). \end{aligned}$$

■

**Lemma 5.6.** If a partition  $\mathcal{A}$  is  $\mathcal{V}^-$ -matched, then, it is  $\mathcal{V}_k^-$ -matched for every  $k \geq 1$ . □

*Proof.* The proof is by induction. We assume that the statement applies to a given  $k$ . That is,  $\mathcal{A}$  is both  $\mathcal{V}^-$ -matched and  $\mathcal{V}_k^-$ -matched. Then, we know that

$$\mathcal{A}(\mathcal{V}_{k+1}^-(c)) = \mathcal{A}\left(\bigcup_{c^* \in \mathcal{V}_k^-(c)} \mathcal{V}^-(c^*)\right) = \bigcup_{c^* \in \mathcal{V}_k^-(c)} \mathcal{A}(\mathcal{V}^-(c^*)),$$

where the first equality comes from (31) and the second from how we defined the notation of applying  $\mathcal{A}$  to a set. Since  $\mathcal{A}$  is  $\mathcal{V}^-$ -matched, we know that  $\mathcal{A}(\mathcal{V}^-(c^*))$  only depends on the color of the cell  $c^*$ . Moreover, since  $\mathcal{A}$  is also  $\mathcal{V}_k^-$ -matched we know that  $\mathcal{A}(c) = \mathcal{A}(d)$  implies  $\mathcal{A}(\mathcal{V}_k^-(c)) = \mathcal{A}(\mathcal{V}_k^-(d))$ , which means that  $c^* \in \mathcal{V}_k^-(c)$  and  $d^* \in \mathcal{V}_k^-(d)$  index the exact same set of colors. Therefore,  $\mathcal{A}(\mathcal{V}_{k+1}^-(c)) = \mathcal{A}(\mathcal{V}_{k+1}^-(d))$ .

The base case  $k = 1$  is trivial since  $\mathcal{V}_1^- = \mathcal{V}^-$ . ■

**Corollary 5.6.** If a partition defined on a finite set of cells is  $\mathcal{V}^-$ -matched, then it is also  $\mathcal{R}^-$ -matched. □

*Proof.* This is direct from lemma 5.6 and corollary 4.1. ■

We have seen in corollary 5.5 that a  $\mathcal{N}^-$ -matched partition is also  $\mathcal{V}^-$ -matched. The next very trivial example shows that the converse is not necessarily true.

**Example 5.2.** Consider the network in figure 10, which is colored with only one color (white). Note that  $\mathcal{N}^-(1) = \{\}$  is empty and  $\mathcal{N}^-(2) = \{1\}$  contains the white color. Therefore, the partition is not  $\mathcal{N}^-$ -matched. On the other hand, we have that  $\mathcal{V}^-(1) = \{1\}$  and  $\mathcal{V}^-(2) = \{1, 2\}$  which means that the partition is  $\mathcal{V}^-$ -matched.  $\square$

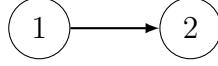

Figure 10: Partition that is not  $\mathcal{N}^-$ -matched but is  $\mathcal{V}^-$ -matched.

We have also seen in corollary 5.6 that a  $\mathcal{V}^-$ -matched partition is also  $\mathcal{R}^-$ -matched. In the next example we disprove the converse statement.

**Example 5.3.** Consider the network in figure 11. Note that  $\mathcal{V}^-(1) = \{1, 4\}$  contains only white colors and  $\mathcal{V}^-(4) = \{2, 3, 4\}$  contains white and gray colors. Therefore, the partition is not  $\mathcal{V}^-$ -matched. On the other hand, we have that  $\mathcal{R}^-(1) = \mathcal{R}^-(4)$  and  $\mathcal{R}^-(2) = \mathcal{R}^-(3)$ , which means that the partition is  $\mathcal{R}^-$ -matched.  $\square$

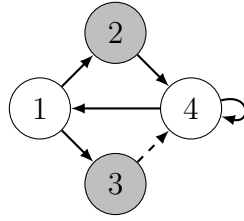

Figure 11: Partition that is not  $\mathcal{V}^-$ -matched but is  $\mathcal{R}^-$ -matched.

In summary, we have shown that the sequence:  $\mathcal{N}^-$ -matched,  $\mathcal{V}^-$ -matched and  $\mathcal{R}^-$ -matched lists progressively weaker assumptions. Note that in example 5.3 the in-reachability sets are, in fact, all the same. The following result should be obvious from the definitions.

**Corollary 5.7.** In a network that is a SCC, every partition is  $\mathcal{R}^-$ -matched.  $\square$

More generally,

**Corollary 5.8.** Every strong partition is  $\mathcal{R}^-$ -matched.  $\square$

We now show that the tamest assumption we described ( $\mathcal{R}^-$ -matched) is enough to allow the following results.

**Lemma 5.7.** If a non-weak partition is  $\mathcal{R}^-$ -matched, then it is finer than the partition of RDCs.  $\square$

*Proof.* Consider some network with  $n$  roots  $\mathcal{S}_1, \dots, \mathcal{S}_n$  and a partition  $\mathcal{A}$  that is non-weak and  $\mathcal{R}^-$ -matched. Note that  $\mathcal{S}_i \cap \mathcal{S}_j = \mathcal{R}^-(\mathcal{S}_i) \cap \mathcal{R}^-(\mathcal{S}_j) = \emptyset$  for all  $i \neq j$ . Then, since  $\mathcal{A}$  is non-weak, we have that  $\mathcal{A}(\mathcal{R}^-(\mathcal{S}_i)) \cap \mathcal{A}(\mathcal{R}^-(\mathcal{S}_j)) = \emptyset$ . That is, each root in the network contains a distinct set of colors.

Consider a cell  $c$  that shares a color with a root. That is,  $\mathcal{A}(c) = k$  for some  $k \in \mathcal{A}(\mathcal{S}_i)$ . Then, since  $\mathcal{A}$  is  $\mathcal{R}^-$ -matched, we have that  $\mathcal{A}(\mathcal{R}^-(c)) = \mathcal{A}(\mathcal{S}_i)$ . Since the set of colors in each root are distinct, this means that  $\mathcal{A}(\mathcal{R}^-(c)) \cap \mathcal{A}(\mathcal{S}_j) = \emptyset$  for all  $j \neq i$ . This implies  $\mathcal{R}^-(c) \cap \mathcal{S}_j = \emptyset$  for all  $j \neq i$ . That is, if some cell in the network shares its color with a root, then that cell cannot depend (in the  $\mathcal{R}^-$  sense) on any other roots. Since it is impossible to not depend on any roots at all, this implies that  $\mathcal{R}^-(c) \supseteq \mathcal{S}_i$ . That is, if a cell shares its color with a root, then it depends on that root (and no others). Finally, consider  $c, d$  such that  $\mathcal{A}(c) = \mathcal{A}(d)$ . Then, from  $\mathcal{A}$  being  $\mathcal{R}^-$ -matched we have that  $\mathcal{A}(\mathcal{R}^-(c)) = \mathcal{A}(\mathcal{R}^-(d))$ . Since  $\mathcal{R}^-(c)$  and  $\mathcal{R}^-(d)$  share the exact same set of colors, they also share the same subset of colors that are present in roots. From what we have shown before, depending on a color shared by a root implies depending on the root itself. Therefore, cells of the same color depend on exactly the same roots, which means that the partition is finer than the partition of RDCs. ■

We now show how the top non-weak partition  $\top_F^{NW}$  is given in terms of the  $cir_F$  function for the case where we know that all rooted partitions are  $\mathcal{R}^-$ -matched.

**Corollary 5.9.** *Consider a network  $\mathcal{G}$  with cell type partition  $\mathcal{T}$ . Represent its RDCs according to a partition  $\mathcal{B}$ . Assume all its rooted partitions are  $\mathcal{R}^-$ -matched. Then,  $\top_F^{NW} = cir_F(\mathcal{T} \wedge \mathcal{B})$ . □*

We are now ready to prove the following result.

**Lemma 5.8.** *For any pair of non-weak  $\mathcal{R}^-$ -matched partitions  $\mathcal{A}_{nw_1}, \mathcal{A}_{nw_2}$ , their join  $\mathcal{A}_{nw} = \mathcal{A}_{nw_1} \vee \mathcal{A}_{nw_2}$  is also non-weak. □*

*Proof.* From lemma 5.7 we know that  $\mathcal{A}_{nw_1}, \mathcal{A}_{nw_2}$  are both finer than the partition of RDCs. Therefore, their join  $\mathcal{A}_{nw}$  is also going to be finer. From lemma 5.4 we know that it is also non-weak. ■

The following result is straightforward from the general case illustrated in table 1, together with lemma 5.8.

**Corollary 5.10.** *Consider partitions  $\mathcal{A}_s, \mathcal{A}_{r_1}, \mathcal{A}_{r_2}$  such that  $\mathcal{A}_s$  is strong and  $\mathcal{A}_{r_1}, \mathcal{A}_{r_2}$  are rooted and  $\mathcal{R}^-$ -matched. Then,  $\mathcal{A}_s \vee \mathcal{A}_{r_1}$  and  $\mathcal{A}_{r_1} \vee \mathcal{A}_{r_2}$  are rooted. □*

This means that for the case where rooted partitions are  $\mathcal{R}^-$ -matched, table 1 simplifies into table 2. Furthermore, under such conditions we know that  $L_F^{NW}$  is a sublattice of  $L_F$ . This is illustrated in the following example.

**Example 5.4.** *Consider the network in figure 12a and its respective lattice of balanced partitions  $\Lambda$  in figure 12b. Note that  $\Lambda^S$  and  $\Lambda^{NW}$  are both lattices with top partitions  $\top^S = \perp$  and  $\top^{NW} = 13/24$ , respectively. Note that every balanced partition in this network is  $\mathcal{R}^-$ -matched, therefore table 2 applies. In the following section we will see that this fact is immediate from the network not allowing edge cancelings. □*

Table 2: Join table when rooted partitions are  $\mathcal{R}^-$ -matched.

$\vee$	S	R	W
S	S	R	W
R	R	R	W
W	W	W	W

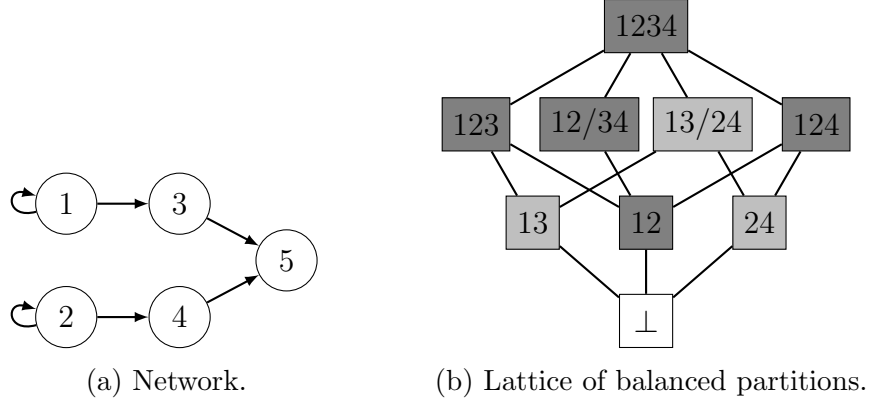

Figure 12: A network and its lattice of balanced partitions.

### 5.3. Neighborhood color invariance

We now introduce a property that is stronger than definition 5.3, that only applies to balanced partitions, since it is related to the respective quotient network.

**Definition 5.4.** Consider a balanced partition  $\bowtie \in \Lambda_{\mathcal{G}}$  on a network  $\mathcal{G}$  and its respective quotient network  $\mathcal{Q} = \mathcal{G}/\bowtie$ . Take a particular type of neighborhood  $\mathcal{U} \in \{\mathcal{N}^-, \mathcal{V}^-, \mathcal{V}_k^-, \mathcal{R}^-\}$  such that  $\mathcal{U}_{\mathcal{G}}$  and  $\mathcal{U}_{\mathcal{Q}}$  are the corresponding functions on  $\mathcal{G}$  and  $\mathcal{Q}$ , respectively. Then, we say that  $\bowtie$  is  $\mathcal{U}$ -invariant if

$$d \in \mathcal{U}_{\mathcal{G}}(c) \implies \bowtie(d) \in \mathcal{U}_{\mathcal{Q}}(\bowtie(c)), \quad (40)$$

or equivalently,

$$\bowtie(\mathcal{U}_{\mathcal{G}}(c)) \subseteq \mathcal{U}_{\mathcal{Q}}(\bowtie(c)) \quad (41)$$

for all  $c \in \mathcal{C}_{\mathcal{G}}$ . □

We note that the converse property of definition 5.4 is always satisfied.

**Lemma 5.9.** Consider a balanced partition  $\bowtie \in \Lambda_{\mathcal{G}}$  on a network  $\mathcal{G}$  and its respective quotient network  $\mathcal{Q} = \mathcal{G}/\bowtie$ . Then, for every color  $A \in \bowtie$ , which maps into the cell  $k_A \in \mathcal{C}_{\mathcal{Q}}$ , we have that

$$k_A \in \mathcal{U}_{\mathcal{Q}}(\bowtie(c)) \implies A \cap \mathcal{U}_{\mathcal{G}}(c) \neq \emptyset, \quad (42)$$

or equivalently,

$$\mathcal{U}_{\mathcal{Q}}(\bowtie(c)) \subseteq \bowtie(\mathcal{U}_{\mathcal{G}}(c)) \quad (43)$$

for all  $c \in \mathcal{C}_{\mathcal{G}}$ . □

*Proof.* Firstly, we define  $B \in \bowtie$  to be the color of  $c$ , mapping into the cell  $k_B \in \mathcal{C}_{\mathcal{Q}}$ .

Assume  $k_A \in \mathcal{N}_{\mathcal{Q}}^-(k_B)$ . Then, from the definition of  $\mathcal{N}^-$ , we have a non-zero entry  $q_{k_B k_A} \neq 0_{ij}$ , with  $i = \mathcal{T}_{\mathcal{Q}}(k_B) = \mathcal{T}_{\mathcal{G}}(B)$  and  $j = \mathcal{T}_{\mathcal{Q}}(k_A) = \mathcal{T}_{\mathcal{G}}(A)$  in the in-adjacency matrix  $Q$  associated with the quotient network  $\mathcal{Q}$ . Then, from the definition of quotient network, we have that  $\sum_{d \in A \cap \mathcal{N}_{\mathcal{G}}^-(c)} w_{cd} = q_{k_B k_A}$ . Since  $q_{k_B k_A} \neq 0_{ij}$ , this means that  $A \cap \mathcal{N}_{\mathcal{G}}^-(c)$  is non-empty. That is, the statement is true for the case  $\mathcal{U} = \mathcal{N}^-$ .

We now prove the case  $\mathcal{U} = \mathcal{V}^-$ . Assume  $k_A \in \mathcal{V}_{\mathcal{Q}}^-(\bowtie(c))$ . Then,  $k_A \in \{k_B \cup \mathcal{N}_{\mathcal{Q}}^-(k_B)\}$ . Consider the case  $k_A = k_B$ . Then,  $c \in A \cap \mathcal{V}_{\mathcal{G}}^-(c)$ , which makes the set non-empty. Consider now the case  $k_A \in \mathcal{N}_{\mathcal{Q}}^-(k_B)$ . Then, since the statement is true for  $\mathcal{U} = \mathcal{N}^-$ ,  $A \cap \mathcal{N}_{\mathcal{G}}^-(c)$  is non-empty. Therefore,  $A \cap \mathcal{V}_{\mathcal{G}}^-(c) \supseteq A \cap \mathcal{N}_{\mathcal{G}}^-(c)$  is also non-empty, which concludes the proof for  $\mathcal{U} = \mathcal{V}^-$ .

We now prove the case  $\mathcal{U} = \mathcal{V}_k^-$  for every  $k \geq 1$ . The proof is by induction. Assume it to be true for a given  $k$ . Consider  $k_A \in \mathcal{V}_{k+1, \mathcal{Q}}^-(k_B)$ . Then,  $k_A \in \bigcup_{k_C \in \mathcal{V}_k^-(k_B)} \mathcal{V}_{\mathcal{Q}}^-(k_C)$ . That is,  $k_A \in \mathcal{V}_{\mathcal{Q}}^-(k_C)$  for at least one particular  $k_C \in \mathcal{V}_k^-(k_B)$ . Then, since the case  $\mathcal{U} = \mathcal{V}_k^-$  is true from assumption, we have that  $C \cap \mathcal{V}_{k, \mathcal{G}}^-(c) \neq \emptyset$ , where  $C \in \bowtie$  is the color that maps into cell  $k_C$ . We choose a particular cell  $d \in C \cap \mathcal{V}_{k, \mathcal{G}}^-(c)$ . Then,  $\bowtie(d) = k_C$ . Furthermore, since we know that the case  $\mathcal{U} = \mathcal{V}^-$  is true,  $k_A \in \mathcal{V}_{\mathcal{Q}}^-(k_C)$  implies  $A \cap \mathcal{V}_{\mathcal{G}}^-(d) \neq \emptyset$ . Finally, note that  $A \cap \mathcal{V}_{k+1, \mathcal{G}}^-(c) \supseteq A \cap \mathcal{V}_{\mathcal{G}}^-(d)$  since  $d \in \mathcal{V}_k^-(c)$ , which means that  $A \cap \mathcal{V}_{k+1, \mathcal{G}}^-(c)$  is also non-empty. This concludes the induction step. The base case  $k = 1$  is trivial since  $\mathcal{V}_1^- = \mathcal{V}^-$ .

Finally, the case  $\mathcal{U} = \mathcal{R}^-$  is immediate from corollary 4.1.  $\blacksquare$

The following is immediate from definition 5.4 and lemma 5.9.

**Corollary 5.11.** *Consider a balanced partition  $\bowtie \in \Lambda_{\mathcal{G}}$  on a network  $\mathcal{G}$  and its respective quotient network  $\mathcal{Q} = \mathcal{G}/\bowtie$ . Then,  $\bowtie$  is  $\mathcal{U}$ -invariant if and only if*

$$\bowtie(\mathcal{U}_{\mathcal{G}}(c)) = \mathcal{U}_{\mathcal{Q}}(\bowtie(c)) \quad (44)$$

for all  $c \in \mathcal{C}_{\mathcal{G}}$ .  $\square$

We now show that definition 5.4 is a stronger property than the one in definition 5.3.

**Lemma 5.10.** *If a balanced partition  $\bowtie$  is  $\mathcal{U}$ -invariant, then, it is  $\mathcal{U}$ -matched.*  $\square$

*Proof.* Consider cells  $c, d \in \mathcal{C}_{\mathcal{G}}$  in a network  $\mathcal{G}$  such that  $\bowtie(c) = \bowtie(d)$ . Then, we have that  $\mathcal{U}_{\mathcal{Q}}(\bowtie(c)) = \mathcal{U}_{\mathcal{Q}}(\bowtie(d))$  in the quotient network  $\mathcal{Q} = \mathcal{G}/\bowtie$ . Since  $\bowtie$  is  $\mathcal{U}$ -invariant, from corollary 5.11 we have that  $\bowtie(\mathcal{U}_{\mathcal{G}}(c)) = \bowtie(\mathcal{U}_{\mathcal{G}}(d))$ . Therefore,  $\bowtie$  is  $\mathcal{U}$ -matched.  $\blacksquare$

**Lemma 5.11.** *Consider a  $\mathcal{U}$ -invariant balanced partition  $\bowtie \in \Lambda_{\mathcal{G}}$  on a network  $\mathcal{G}$  and its respective quotient network  $\mathcal{Q} = \mathcal{G}/\bowtie$ . Then, for a partition  $\mathcal{A}$  such that  $\bowtie \leq \mathcal{A} \leq \mathcal{T}_{\mathcal{G}}$ , we have that*

$$\mathcal{A}(\mathcal{U}_{\mathcal{G}}(c)) = \mathcal{A}/\bowtie(\mathcal{U}_{\mathcal{Q}}(\bowtie(c))) \quad (45)$$

for all  $c \in \mathcal{C}_{\mathcal{G}}$ .  $\square$

*Proof.* From the fact that  $\bowtie \leq \mathcal{A}$ , we have that  $\mathcal{A}(\mathcal{U}_{\mathcal{G}}(c)) = \mathcal{A}/\bowtie(\bowtie(\mathcal{U}_{\mathcal{G}}(c)))$ . Since  $\bowtie$  is  $\mathcal{U}$ -invariant, from corollary 5.11, this becomes  $\mathcal{A}/\bowtie(\mathcal{U}_{\mathcal{Q}}(\bowtie(c)))$ .  $\blacksquare$



**Lemma 5.12.** *Consider a  $\mathcal{U}$ -invariant balanced partition  $\bowtie \in \Lambda_{\mathcal{G}}$  on a network  $\mathcal{G}$  and its respective quotient network  $\mathcal{Q} = \mathcal{G}/\bowtie$ . Then, for a partition  $\mathcal{A}$  such that  $\bowtie \leq \mathcal{A} \leq \mathcal{T}_{\mathcal{G}}$ , we have that  $\mathcal{A}$  is  $\mathcal{U}$ -matched in  $\mathcal{G}$  if and only if  $\mathcal{A}/\bowtie$  is  $\mathcal{U}$ -matched in  $\mathcal{Q}$ .  $\square$*

*Proof.* Firstly, note that  $\mathcal{A}/\bowtie$  being  $\mathcal{U}$ -matched in  $\mathcal{Q}$ , from definition, means that  $\mathcal{A}/\bowtie(\bowtie(c)) = \mathcal{A}/\bowtie(\bowtie(d))$  implies  $\mathcal{A}/\bowtie(\mathcal{U}_{\mathcal{Q}}(\bowtie(c))) = \mathcal{A}/\bowtie(\mathcal{U}_{\mathcal{Q}}(\bowtie(d)))$ . This simplifies into  $\mathcal{A}(c) = \mathcal{A}(d)$  implies  $\mathcal{A}/\bowtie(\mathcal{U}_{\mathcal{Q}}(\bowtie(c))) = \mathcal{A}/\bowtie(\mathcal{U}_{\mathcal{Q}}(\bowtie(d)))$ . Therefore, we have to prove that if  $\mathcal{A}(c) = \mathcal{A}(d)$ , then  $\mathcal{A}(\mathcal{U}_{\mathcal{G}}(c)) = \mathcal{A}(\mathcal{U}_{\mathcal{G}}(d))$  is equivalent to  $\mathcal{A}/\bowtie(\mathcal{U}_{\mathcal{Q}}(\bowtie(c))) = \mathcal{A}/\bowtie(\mathcal{U}_{\mathcal{Q}}(\bowtie(d)))$ . Since  $\bowtie$  is  $\mathcal{U}$ -invariant, this is immediate from lemma 5.11.  $\blacksquare$

**Lemma 5.13.** *Consider a  $\mathcal{U}$ -invariant balanced partition  $\bowtie_{01} \in \Lambda_{\mathcal{G}}$  on a network  $\mathcal{G}$  and its respective quotient network  $\mathcal{Q}_1 = \mathcal{G}/\bowtie_{01}$ . Then, for a balanced partition  $\bowtie_{02}$  such that  $\bowtie_{01} \leq \bowtie_{02}$ , we have that  $\bowtie_{02}$  is  $\mathcal{U}$ -invariant in  $\mathcal{G}$  if and only if  $\bowtie_{12} := \bowtie_{02}/\bowtie_{01}$  is  $\mathcal{U}$ -invariant in  $\mathcal{Q}_1$ .  $\square$*

*Proof.* From corollary 5.11, we have that  $\bowtie_{02}$  being  $\mathcal{U}$ -invariant in  $\mathcal{G}$  means that  $\bowtie_{02}(\mathcal{U}_{\mathcal{G}}(c)) = \mathcal{U}_{\mathcal{Q}_2}(\bowtie_{02}(c))$ , with  $\mathcal{Q}_2 := \mathcal{G}/\bowtie_{02}$ , for all  $c \in \mathcal{C}_{\mathcal{G}}$ . This can be rewritten, using  $\bowtie_{12}$  as  $\bowtie_{12}(\bowtie_{01}(\mathcal{U}_{\mathcal{G}}(c))) = \mathcal{U}_{\mathcal{Q}_2}(\bowtie_{12}(\bowtie_{01}(c)))$ . Since from assumption,  $\bowtie_{01}$  is  $\mathcal{U}$ -invariant, this can be equivalently written as  $\bowtie_{12}(\mathcal{U}_{\mathcal{Q}_1}(\bowtie_{01}(c))) = \mathcal{U}_{\mathcal{Q}_2}(\bowtie_{12}(\bowtie_{01}(c)))$ , for all  $c \in \mathcal{C}_{\mathcal{G}}$ . Using the mapping  $d = \bowtie_{01}(c)$ , it is easy to see that this is equivalent to  $\bowtie_{12}(\mathcal{U}_{\mathcal{Q}_1}(d)) = \mathcal{U}_{\mathcal{Q}_2}(\bowtie_{12}(d))$ , for all  $d \in \mathcal{C}_{\mathcal{Q}_1}$ . Since from lemma 3.16 we know that  $\mathcal{Q}_2 = \mathcal{Q}_1/\bowtie_{12}$ , this is equivalent to  $\bowtie_{12}$  being  $\mathcal{U}$ -invariant in  $\mathcal{Q}_1$ .  $\blacksquare$

Similarly to the  $\mathcal{U}$ -matched case, we have the following results.

**Corollary 5.12.** *The trivial partition  $\perp$  is  $\mathcal{U}$ -invariant for every  $\mathcal{U} \in \{\mathcal{N}^-, \mathcal{V}^-, \mathcal{V}_k^-, \mathcal{R}^-\}$ .  $\square$*

**Corollary 5.13.** *If a balanced partition  $\bowtie$  is  $\mathcal{N}^-$ -invariant, then, it is  $\mathcal{V}^-$ -invariant.  $\square$*

*Proof.* Consider cells  $c, d \in \mathcal{C}_{\mathcal{G}}$  in a network  $\mathcal{G}$  such that  $c \in \mathcal{V}_{\mathcal{G}}^-(d)$ . Then,  $c \in \{d \cup \mathcal{N}_{\mathcal{G}}^-(d)\}$ . Consider the case  $c = d$ . Then,  $\bowtie(c) \in \mathcal{V}_{\mathcal{Q}}^-(\bowtie(c))$  in the quotient network  $\mathcal{Q} = \mathcal{G}/\bowtie$ , is immediate from the definition of  $\mathcal{V}^-$ . Consider now that  $c \in \mathcal{N}_{\mathcal{G}}^-(d)$ . Then, from  $\bowtie$  being  $\mathcal{N}^-$ -invariant, we have that  $\bowtie(c) \in \mathcal{N}_{\mathcal{Q}}^-(\bowtie(d))$ , which implies  $\bowtie(c) \in \mathcal{V}_{\mathcal{Q}}^-(\bowtie(d))$ .  $\blacksquare$

**Lemma 5.14.** *If a balanced partition  $\bowtie$  is  $\mathcal{V}^-$ -invariant, then, it is  $\mathcal{V}_k^-$ -invariant for every  $k \geq 1$ .  $\square$*

*Proof.* The proof is by induction. We assume that the statement applies to a given  $k$ . That is,  $\bowtie$  is both  $\mathcal{V}^-$ -invariant and  $\mathcal{V}_k^-$ -invariant. Consider cells  $c, d \in \mathcal{C}_{\mathcal{G}}$  in a network  $\mathcal{G}$  such that  $c \in \mathcal{V}_{k+1\mathcal{G}}^-(d)$ . Then,  $c \in \bigcup_{d^* \in \mathcal{V}_{k\mathcal{G}}^-(d)} \mathcal{V}_{\mathcal{G}}^-(d^*)$ . That is,  $c \in \mathcal{V}_{\mathcal{G}}^-(d^*)$  for at least one particular  $d^* \in \mathcal{V}_{k\mathcal{G}}^-(d)$ .

Then, from  $\bowtie$  being  $\mathcal{V}^-$ -invariant and  $\mathcal{V}_k^-$ -invariant, we have that  $\bowtie(c) \in \mathcal{V}_{\mathcal{Q}}^-(\bowtie(d^*))$  and  $\bowtie(d^*) \in \mathcal{V}_{k\mathcal{Q}}^-(\bowtie(d))$ , respectively, in the quotient network  $\mathcal{Q} = \mathcal{G}/\bowtie$ . Therefore,  $\bowtie(c) \in \mathcal{V}_{k+1\mathcal{Q}}^-(\bowtie(d))$ , which means that  $\bowtie$  is  $\mathcal{V}_{k+1}^-$ -invariant.

The base case  $k = 1$  is trivial since  $\mathcal{V}_1^- = \mathcal{V}^-$ .  $\blacksquare$

**Corollary 5.14.** *If a balanced partition  $\bowtie$  defined on a finite set of cells is  $\mathcal{V}^-$ -invariant, then it is also  $\mathcal{R}^-$ -invariant.  $\square$*

*Proof.* This is direct from lemma 5.14 and corollary 4.1.  $\blacksquare$

We note that the concept of  $\mathcal{U}$ -invariance generalizes the concept of spurious partitions, which was defined in [15]. In particular, it corresponds to partitions not being  $\mathcal{N}^-$ -invariant. This is illustrated in the following example.

**Example 5.5.** *Consider the network in figure 13a. Note that for a general admissible function  $f \in \mathcal{F}_G$ ,  $f_3$  depends on the states of cells 1, 2. However, when the state is in  $\Delta_{\bowtie}^{\times}$  with  $\bowtie = \{\{1, 2\}, \{3\}, \{4\}\}$ , the total effect of cells 1, 2 on cell 3 cancels and 3 acts as if there were no edges coming from those cells.  $\square$*

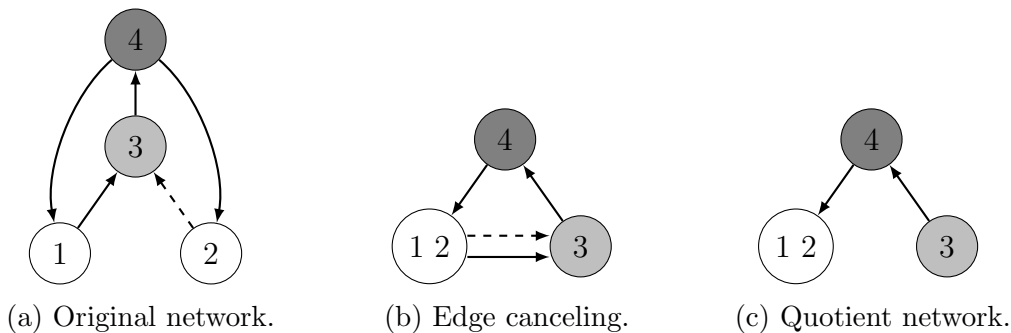

Figure 13: Example of a spurious (not  $\mathcal{N}^-$ -invariant) partition.

Note that the partition in example 5.5 is  $\mathcal{N}^-$ -matched despite not being  $\mathcal{N}^-$ -invariant. That is, while being  $\mathcal{N}^-$ -matched is a sufficient condition for a partition to be  $\mathcal{N}^-$ -matched, it is not a necessary one. We now present an example that clarifies why the edge canceling in a balanced partition that is not  $\mathcal{N}^-$ -invariant might lead to it not being  $\mathcal{N}^-$ -matched.

**Example 5.6.** *Consider the network in figure 14a, which is colored according to a balanced partition that is not  $\mathcal{N}^-$ -invariant (that is, it is spurious). Note that  $\mathcal{N}^-(1) = \{1\}$  contains only white colors and  $\mathcal{N}^-(4) = \{1, 2, 3\}$  contains white and gray colors. The fact that the edges coming from cells 2 and 3 cancel each other is exactly what allows this partition to be balanced despite this difference.  $\square$*

We have seen in corollary 5.13 that a  $\mathcal{N}^-$ -invariant partition is also  $\mathcal{V}^-$ -invariant. The next example shows that the converse is not necessarily true.

**Example 5.7.** *Consider the network in figure 15a, which is colored with a single color, according to the balanced partition  $\{\{1, 2, 3\}\}$ . Note that in this network, both the  $\mathcal{N}^-$  and  $\mathcal{V}^-$  in-neighborhoods of white cells contain white cells. On the other hand, in the quotient network in figure 15b, we see that  $\mathcal{N}^-$  of its only existing cell is empty. Therefore, this partition is not  $\mathcal{N}^-$ -invariant. It is, however,  $\mathcal{V}^-$ -invariant.  $\square$*

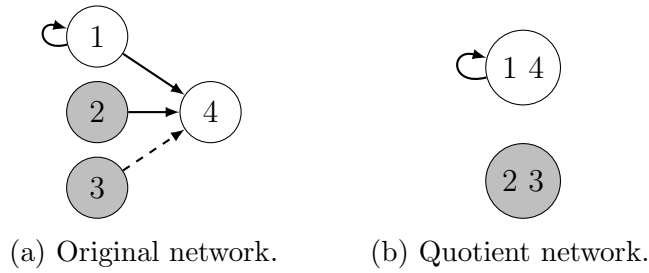

Figure 14: Example of a partition that is neither  $\mathcal{N}^-$ -invariant nor  $\mathcal{N}^-$ -matched.

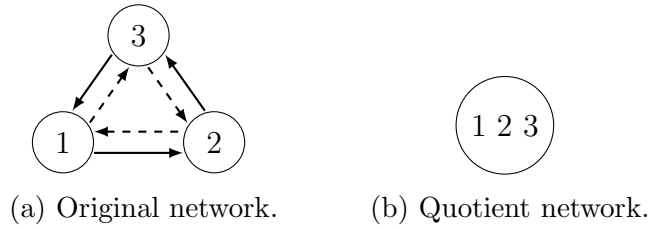

Figure 15: Example of a partition that is not  $\mathcal{N}^-$ -invariant but is  $\mathcal{V}^-$ -invariant.

We have also seen in corollary 5.14 that a  $\mathcal{V}^-$ -invariant partition is also  $\mathcal{R}^-$ -invariant. In the next example we disprove the converse statement.

**Example 5.8.** Consider the network in figure 16a, which is colored according to the balanced partition  $\{\{1\}, \{2, 3\}, \{4\}\}$ . Note that in the original network  $\mathcal{G}$ , we have that  $\mathcal{V}^-(1) = \{1, 2, 3, 4\}$ . That is, white cells have white, light gray and dark gray colors in its  $\mathcal{V}^-$  neighborhood. On the other hand, in the quotient, the white cell only has white and dark gray colors in its  $\mathcal{V}^-$  neighborhood, which means that the partition is not  $\mathcal{V}^-$ -invariant. However, it is clear that the partition is  $\mathcal{R}^-$ -invariant, since in both the original network and in the quotient, all in-reachability sets  $\mathcal{R}^-$  contain all the three colors of the partition.  $\square$

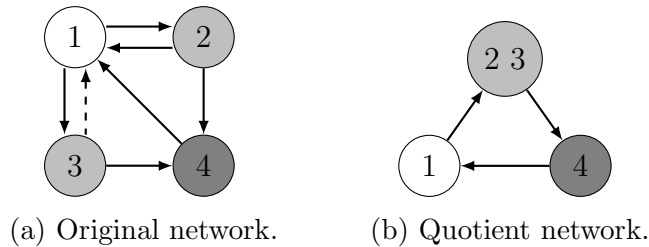

Figure 16: Example of a partition that is not  $\mathcal{V}^-$ -invariant but is  $\mathcal{R}^-$ -invariant.

In summary, we have shown that the sequence:  $\mathcal{N}^-$ -invariant,  $\mathcal{V}^-$ -invariant and  $\mathcal{R}^-$ -invariant lists progressively weaker assumptions.

**Remark 16.** Refer back to example 5.4. Note that the network only contains positive weights, which means that no matter which quotient we apply, there will be no edge

canceling. That is, every balanced partition is immediately guaranteed to be  $\mathcal{N}^-$ -invariant. Then, it is also  $\mathcal{R}^-$ -invariant, which from lemma 5.10 means that they are  $\mathcal{R}^-$ -matched.  $\square$

We now show that the tamest assumption we defined in this section ( $\mathcal{R}^-$ -invariant) is enough to allow the following results.

**Lemma 5.15.** *Consider a  $\mathcal{R}^-$ -invariant balanced partition  $\bowtie \in \Lambda_{\mathcal{G}}$  on a network  $\mathcal{G}$  and its respective quotient network  $\mathcal{Q} = \mathcal{G}/\bowtie$ . If a partition  $\mathcal{A}$  such that  $\bowtie \leq \mathcal{A} \leq \mathcal{T}_{\mathcal{G}}$  is strong in  $\mathcal{G}$ , then  $\mathcal{A}/\bowtie$  is strong in  $\mathcal{Q}$ .  $\square$*

*Proof.* Firstly, note that  $\mathcal{A}/\bowtie$  being strong in  $\mathcal{Q}$ , from definition, means that  $\mathcal{A}/\bowtie(\bowtie(c)) = \mathcal{A}/\bowtie(\bowtie(d))$  implies  $\mathcal{R}_{\mathcal{Q}}^-(\bowtie(c)) = \mathcal{R}_{\mathcal{Q}}^-(\bowtie(d))$ . This simplifies into  $\mathcal{A}(c) = \mathcal{A}(d)$  implies  $\mathcal{R}_{\mathcal{Q}}^-(\bowtie(c)) = \mathcal{R}_{\mathcal{Q}}^-(\bowtie(d))$ . Assume  $\mathcal{A}(c) = \mathcal{A}(d)$ . Then, from  $\mathcal{A}$  being strong in  $\mathcal{G}$ , we have that  $\mathcal{R}_{\mathcal{G}}^-(c) = \mathcal{R}_{\mathcal{G}}^-(d)$ , which implies  $\bowtie(\mathcal{R}_{\mathcal{G}}^-(c)) = \bowtie(\mathcal{R}_{\mathcal{G}}^-(d))$ . Since  $\bowtie$  is  $\mathcal{R}^-$ -invariant, we have from corollary 5.11 that  $\mathcal{R}_{\mathcal{Q}}^-(\bowtie(c)) = \mathcal{R}_{\mathcal{Q}}^-(\bowtie(d))$ , which concludes the proof.  $\blacksquare$

**Lemma 5.16.** *Consider a  $\mathcal{R}^-$ -invariant balanced partition  $\bowtie \in \Lambda_{\mathcal{G}}$  on a network  $\mathcal{G}$  and its respective quotient network  $\mathcal{Q} = \mathcal{G}/\bowtie$ . If a partition  $\mathcal{A}$  such that  $\bowtie \leq \mathcal{A} \leq \mathcal{T}_{\mathcal{G}}$  is non-weak in  $\mathcal{G}$ , then  $\mathcal{A}/\bowtie$  is non-weak in  $\mathcal{Q}$ .  $\square$*

*Proof.* Assume  $\mathcal{A}$  is non-weak in  $\mathcal{G}$ . Then, for every color  $A \in \mathcal{A}$ , we have that  $\bigcap_{c \in A} \mathcal{R}_{\mathcal{G}}^-(c) \neq \emptyset$ . Then, we have that  $\bowtie(\bigcap_{c \in A} \mathcal{R}_{\mathcal{G}}^-(c)) \neq \emptyset$ . Note that  $\bigcap_{c \in A} \bowtie(\mathcal{R}_{\mathcal{G}}^-(c)) \supseteq \bowtie(\bigcap_{c \in A} \mathcal{R}_{\mathcal{G}}^-(c))$ , therefore,  $\bigcap_{c \in A} \bowtie(\mathcal{R}_{\mathcal{G}}^-(c)) \neq \emptyset$ . Since  $\bowtie$  is  $\mathcal{R}^-$ -invariant, we have from corollary 5.11 that  $\bigcap_{c \in A} \mathcal{R}_{\mathcal{Q}}^-(\bowtie(c)) \neq \emptyset$ . This can be written as  $\bigcap_{\bowtie(c) \in A/\bowtie} \mathcal{R}_{\mathcal{Q}}^-(\bowtie(c)) \neq \emptyset$ , which means that  $\mathcal{A}/\bowtie$  is non-weak in  $\mathcal{Q}$ .  $\blacksquare$

These results are summarized in the left hand side of table 3, where, as before,  $S$ ,  $R$  and  $W$  denote the partition classifications of strong, rooted and weak, respectively. The right hand side is easily seen to be equivalent to the left one. Note that for table 3

Table 3: Relation between partitions and their quotients over a  $\mathcal{R}^-$ -invariant partition.

$\mathcal{A}, \mathcal{G} \rightarrow \mathcal{A}/\bowtie, \mathcal{Q}$	$\mathcal{A}/\bowtie, \mathcal{Q} \rightarrow \mathcal{A}, \mathcal{G}$
S	S
R	S/R
W	S/R/W
S	S/R/W
R	R/W
W	W

to apply, we require the partition we quotient over ( $\bowtie$ ) to be  $\mathcal{R}^-$ -invariant. We now present some examples that show that these results do not apply if this assumption is not satisfied.

**Example 5.9.** Consider the network  $\mathcal{G}$  in figure 17a, which is colored according to the balanced partition  $\bowtie = \{\{1, 2\}, \{3\}\}$ . Note that  $\mathcal{R}_{\mathcal{G}}^-(3) = \{1, 2, 3\}$ . That is, gray cells have white and gray colors in its  $\mathcal{R}_{\mathcal{G}}^-$  neighborhood. On the other hand, in the quotient network  $\mathcal{Q}$  in figure 17b, we have that  $\mathcal{R}_{\mathcal{Q}}^-(3) = \{3\}$ . That is, the gray cell only has the gray color in its  $\mathcal{R}_{\mathcal{Q}}^-$  neighborhood. Therefore,  $\bowtie$  is not  $\mathcal{R}^-$ -invariant. Consider now the partition  $\mathcal{A} = \{\{1, 2, 3\}\}$ . Although this partition is rooted in  $\mathcal{G}$ , its quotient  $\mathcal{A}/\bowtie = \{\{12, 3\}\}$  is weak in  $\mathcal{G}$ .  $\square$

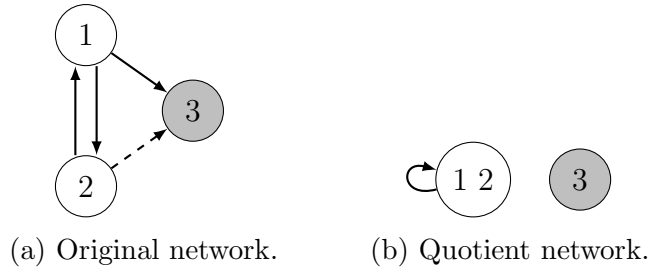

Figure 17: Example of a quotient over a partition that is not  $\mathcal{R}^-$ -invariant.

**Example 5.10.** Consider the network  $\mathcal{G}$  in figure 18a, which is colored according to the balanced partition  $\bowtie = \{\{1, 2\}, \{3, 4\}\}$ . Note that  $\mathcal{G}$  consist of a single SCC. Therefore, each cell has white and gray colors in its  $\mathcal{R}_{\mathcal{G}}^-$  neighborhood. On the other hand, in the quotient network  $\mathcal{Q}$  in figure 18b, we have that  $\mathcal{R}_{\mathcal{Q}}^-(12) = \{12\}$ . That is, the white cell only has the gray color in its  $\mathcal{R}_{\mathcal{Q}}^-$  neighborhood. Therefore,  $\bowtie$  is not  $\mathcal{R}^-$ -invariant. Consider now the partition  $\mathcal{A} = \{\{1, 2, 3, 4\}\}$ . Although this partition is strong in  $\mathcal{G}$ , its quotient  $\mathcal{A}/\bowtie = \{\{12, 34\}\}$  is weak in  $\mathcal{G}$ .  $\square$

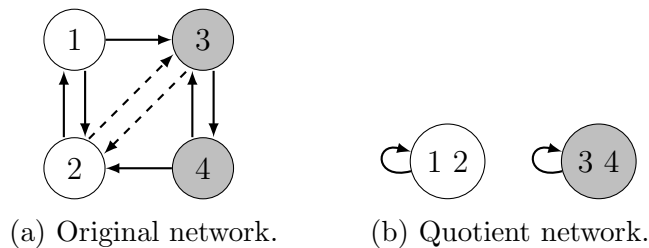

Figure 18: Example of a quotient over a partition that is not  $\mathcal{R}^-$ -invariant.

We now present examples where table 3 does indeed apply.

**Example 5.11.** Consider the network in figure 19a and its respective lattice of balanced partitions  $\Lambda_{\mathcal{G}}$  in figure 19b. We define the quotient networks  $\mathcal{Q}_1 := \mathcal{G}/\bowtie_1$ ,  $\mathcal{Q}_2 := \mathcal{G}/\bowtie_2$  over the balanced partitions  $\bowtie_1 = \{\{1, 2\}, \{3\}, \{4\}\}$  and  $\bowtie_2 = \{\{1\}, \{2\}, \{3, 4\}\}$ , respectively. Note that both  $\bowtie_1$  and  $\bowtie_2$  are  $\mathcal{R}^-$ -invariant, therefore, table 3 applies. The set of partitions in  $\Lambda_{\mathcal{G}}$  that are coarser than  $\bowtie_1$  are  $\{\{1, 2\}, \{3\}, \{4\}\}$  ( $\bowtie_1$  itself) and  $\{\{1, 2\}, \{3, 4\}\}$ , which are both weak. In the lattice  $\Lambda_{\mathcal{Q}_1}$  these two partitions correspond to  $\perp_{\mathcal{Q}_1}$  and  $\{\{12\}, \{3, 4\}\}$ , which are strong and rooted, respectively.

The set of partitions in  $\Lambda_{\mathcal{G}}$  that are coarser than  $\bowtie_2$  are  $\{\{1\}, \{2\}, \{3, 4\}\}$  ( $\bowtie_2$  itself) and  $\{\{1, 2\}, \{3, 4\}\}$ , which are rooted and weak respectively. In the lattice  $\Lambda_{\mathcal{Q}_2}$  these two partitions correspond to  $\perp_{\mathcal{Q}_2}$  and  $\{\{1, 2\}, \{34\}\}$ , which are strong and weak respectively.  $\square$

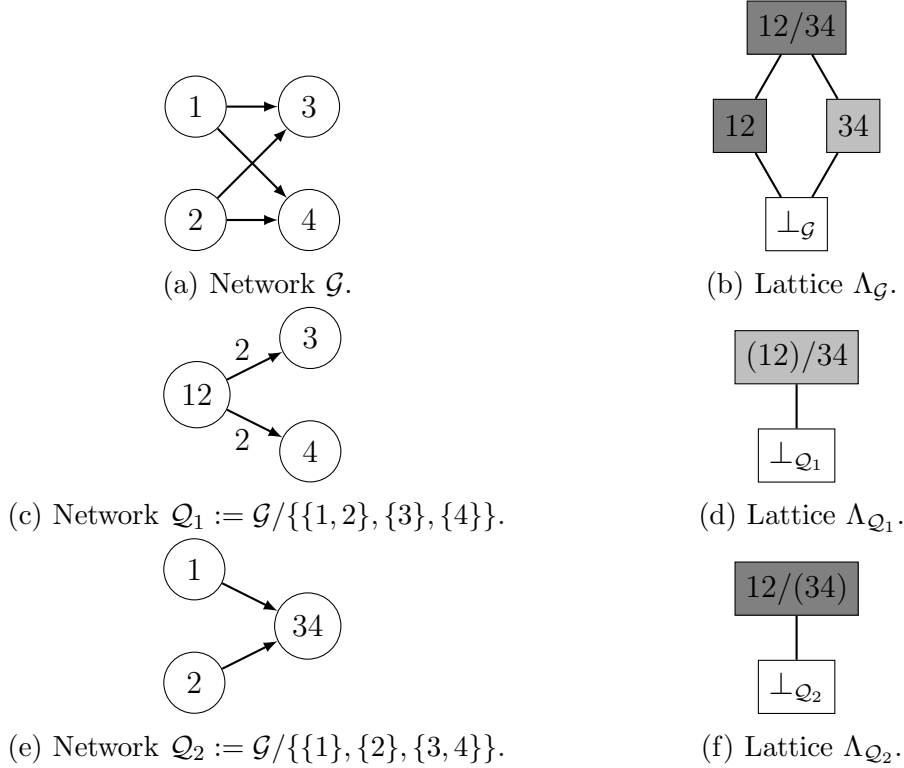

Figure 19: Lattices of balanced partitions of a network and its quotients.

Note that we can always quotient a network over the trivial partition. That is,  $\mathcal{Q} := \mathcal{G}/\perp_{\mathcal{G}}$ . Consider we encode  $\perp_{\mathcal{G}}$  through the identity mapping. In such case we have that  $\mathcal{G} = \mathcal{Q}$  and  $L_{F_{\mathcal{Q}}} = L_{F_{\mathcal{G}}}/\perp_{\mathcal{G}} = L_{F_{\mathcal{G}}}$ . Therefore, every partition in  $L_{F_{\mathcal{G}}}$  maps to itself in  $L_{F_{\mathcal{Q}}}$ . This implies the cases  $S \rightarrow S$ ,  $R \rightarrow R$  and  $W \rightarrow W$  in the left side of table 3.

On the other hand, for the case  $\mathcal{Q} := \mathcal{G}/\bowtie$  and  $L_{F_{\mathcal{Q}}} = L_{F_{\mathcal{G}}}/\bowtie$ , for any  $\bowtie \in \Lambda_{\mathcal{G}}$  we have that  $\bowtie/\bowtie = \perp_{\mathcal{Q}}$ . Since  $\perp_{\mathcal{Q}}$  is always strong in  $\mathcal{Q}$ , this covers the cases  $S/R/W \rightarrow S$  in the left side of table 3. This means that most of the cases of table 3 were forced. The remaining case  $W \rightarrow R$ , was illustrated in example 5.11. That is, the interest of this result lies in the fact that it excludes most of the non-forced cases.

## 6. Conclusion

In this paper we study the connection between the dynamics of a cell and its different types of cumulative in-neighborhoods.

We first study the structure of general lattices of synchronism, which is the set of

partitions that represent equality-based synchrony patterns that are invariant under a given subset of admissible functions.

We then analyze in a qualitative way the relation between the colors of a partition and the connectivity structure of the network.

This motivates the classification scheme developed in this work, which can be applied to generic partitions, without any assumptions such as being balanced, exo-balanced or any similar properties.

Multiple examples illustrating our classification scheme are provided.

## Acknowledgments

This work was supported in part by the FCT Project RELIABLE (PTDC/EEL-AUT/3522/2020), funded by FCT/MCTES and in part by the National Science Foundation under Grant No. ECCS-2029985. The work of P. Sequeira was supported by a Ph.D. Scholarship, grant SFRH/BD/119835/2016 from Fundação para a Ciência e a Tecnologia (FCT), Portugal (POCH program).

## References

- [1] Ian Stewart, Martin Golubitsky, and Marcus Pivato. Symmetry groupoids and patterns of synchrony in coupled cell networks. *SIAM Journal on Applied Dynamical Systems*, 2(4):609–646, 2003.
- [2] Martin Golubitsky, Ian Stewart, and Andrei Török. Patterns of synchrony in coupled cell networks with multiple arrows. *SIAM Journal on Applied Dynamical Systems*, 4(1):78–100, 2005.
- [3] Martin Golubitsky and Ian Stewart. Nonlinear dynamics of networks: the groupoid formalism. *Bulletin of the american mathematical society*, 43(3):305–364, 2006.
- [4] Pedro M Sequeira, António P Aguiar, and João Hespanha. Commutative monoid formalism for weighted coupled cell networks and invariant synchrony patterns. *SIAM Journal on Applied Dynamical Systems*, 20(3):1485–1513, 2021.
- [5] Alex Arenas, Albert Díaz-Guilera, Jürgen Kurths, Yamir Moreno, and Changsong Zhou. Synchronization in complex networks. *Physics reports*, 469(3):93–153, 2008.
- [6] Florian Dörfler and Francesco Bullo. Synchronization in complex networks of phase oscillators: A survey. *Automatica*, 50(6):1539–1564, 2014.
- [7] Francisco A Rodrigues, Thomas K DM Peron, Peng Ji, and Jürgen Kurths. The kuramoto model in complex networks. *Physics Reports*, 610:1–98, 2016.
- [8] Manuela AD Aguiar and Ana Paula S Dias. Synchronization and equitable partitions in weighted networks. *Chaos: An Interdisciplinary Journal of Nonlinear Science*, 28(7):073105, 2018.
- [9] John M Neuberger, Nandor Sieben, and James W Swift. Invariant synchrony subspaces of sets of matrices. *SIAM Journal on Applied Dynamical Systems*, 19(2):964–993, 2020.
- [10] Manuela Aguiar and Ana Dias. Synchrony and antisynchrony in weighted networks. *SIAM Journal on Applied Dynamical Systems*, 20(3):1382–1420, 2021.
- [11] John W Aldis. A polynomial time algorithm to determine maximal balanced equivalence relations. *International Journal of Bifurcation and Chaos*, 18(02):407–427, 2008.
- [12] Pedro Sequeira, João P Hespanha, and A Pedro Aguiar. Decomposition of admissible functions in weighted coupled cell networks. *arXiv preprint arXiv:2201.04972*, 2022.
- [13] Ian Stewart. The lattice of balanced equivalence relations of a coupled cell network. In *Mathematical Proceedings of the Cambridge Philosophical Society*, volume 143, pages 165–183. Cambridge University Press, 2007.

- [14] Robert Tarjan. Depth-first search and linear graph algorithms. *SIAM journal on computing*, 1(2):146–160, 1972.
- [15] Manuela AD Aguiar, Ana Paula S Dias, and Flora Ferreira. Patterns of synchrony for feed-forward and auto-regulation feed-forward neural networks. *Chaos: An Interdisciplinary Journal of Nonlinear Science*, 27(1):013103, 2017.