

New bijective proofs pertaining to alternating sign matrices

Takuya Inoue *

Abstract

The alternating sign matrices-descending plane partitions (ASM-DPP) bijection problem is one of the most intriguing open problems in bijective combinatorics, which is also relevant to integrable combinatorics. The notion of a signed set and a signed bijection is used in [Fischer, I. & Konvalinka, M., *Electron. J. Comb.*, 27 (2020) 3-35.] to construct a bijection between $ASM_n \times DPP_{n-1}$ and $DPP_n \times ASM_{n-1}$. Here, we shall construct a more natural alternative to a signed bijection between alternating sign matrices and shifted Gelfand-Tsetlin patterns which is presented in that paper, based on the notion of compatibility which we introduce to measure the naturalness of a signed bijection. In addition, we give a bijective proof for the refined enumeration of an extension of alternating sign matrices with $n + 3$ statistics, first proved in [Fischer, I. & Schreier-Aigner, F., *Advances in Mathematics* 413 (2023) 108831.].

Contents

1	Introduction	2
2	Preliminaries	4
2.1	Signed Sets	4
2.2	Sijections	5
2.2.1	Composition of sijections	6
2.2.2	Cartesian products of sijections	8
2.2.3	Disjoint unions of sijections	10
3	Compatibility	11
4	About Gelfand-Tsetlin patterns	13
4.1	Definitions	13
4.2	Known sijections relevant to Gelfand-Tsetlin patterns	14
4.3	New compatibility properties	18
4.4	Gelfand-Tsetlin Graph sequences	22
4.5	Preparation for Section 5	25

*Graduate School of Mathematical Sciences, the University of Tokyo, 3-8-1 Komaba, Meguro-ku, 153-8914 Tokyo, Japan. Email: inoue@ms.u-tokyo.ac.jp

5	New sijections pertaining to monotone triangles	25
5.1	Definitions	26
5.1.1	Monotone Triangles	26
5.1.2	Generalized Monotone Triangles	26
5.1.3	Shifted Gelfand-Tsetlin Patterns	32
5.2	Generalized Inversion Numbers	34
5.2.1	Generalized Inversion Numbers for Monotone Triangles	34
5.2.2	Generalized Inversion Numbers for Generalized Monotone Triangles	35
5.2.3	Generalized Inversion Numbers for Shifted Gelfand-Tsetlin Patterns	37
5.3	A sijection $\text{GMT}(\mathbf{k}) \rightsquigarrow \text{SGT}(\mathbf{k})$	37
5.4	A more natural sijection $\text{GMT}(\mathbf{k}) \rightsquigarrow \text{SGT}(\mathbf{k})$	40
5.5	About the choice of the parameter x in the construction	43
5.6	A natural sijection $\text{GMT}(\mathbf{k}) \rightsquigarrow \text{AR}_n \times \text{SGT}(\mathbf{k})$	46
6	Conclusions	49

1 Introduction

An alternating sign matrix with rank n is defined as an $n \times n$ matrix that satisfies the conditions:

- each entry is $-1, 0$ or 1 ,
- for each row and column the sum is 1 ,
- for each row and column the nonzero entries alternate in sign.

Below is an example of a rank 4 alternating sign matrix:

$$\begin{pmatrix} 0 & 0 & 1 & 0 \\ 1 & 0 & -1 & 1 \\ 0 & 1 & 0 & 0 \\ 0 & 0 & 1 & 0 \end{pmatrix}.$$

Combinatorics concerning alternating sign matrices provides one of the most intriguing open problems in bijective combinatorics, which is called the ASM-DPP bijection problem [3, 13]. Here, DPP stands for descending plane partitions, which are plane partitions subject to some conditions and equipped with the notion of rank. It has been known for some time that for any $n \in \mathbb{Z}_{>0}$ the number of alternating sign matrices with rank n is equal to that of descending plane partitions with rank n (conjectured in 1983 by W. H. Mills, David P. Robbins and Howard Rumsey, Jr. [11], and proved in 1996 by Doron Zeilberger [14] and by Greg Kuperberg [10] independently). However, no explicit bijections between them have been found so far.

Ilse Fischer and Matjaž Konvalinka use the notions of a signed set and a signed bijection (which we shall call a *sijection* in the style of Fischer and Konvalinka) to tackle the problem in [7, 8]. These are defined as follows:

- A signed set is a pair of disjoint finite sets,
- A sijection from a signed set $S = (S^+, S^-)$ to a signed set $T = (T^+, T^-)$ is a bijection between $S^+ \sqcup T^-$ and $S^- \sqcup T^+$.

For more details, see Section 2. Fischer and Konvalinka did not construct the desired bijection, but they did construct a bijection between $\text{ASM}_n \times \text{DPP}_{n-1}$ and $\text{DPP}_n \times \text{ASM}_{n-1}$, where ASM_n and DPP_n are the set of alternating sign matrices and descending plane partitions with rank n , respectively. In Section 5, we will investigate the sijections constructed in [7], between alternating sign matrices and so-called shifted Gelfand-Tsetlin patterns, and obtain some new combinatorial results. A shifted Gelfand-Tsetlin pattern is a combinatorial object defined in [7] to clarify the combinatorial meaning of the operator formula for the enumeration of alternating sign matrices. For more details, see Section 5.

Before explaining our method of investigation, let us introduce some other previous works on the ASM-DPP bijection problem, done by Roger E. Behrend, Philippe Di Francesco and Paul Zinn-Justin [1, 2]. Their research concerns refined enumerations of these two objects, and they find that the two refined enumerations with respect to certain quadruplets of statistics coincide with each other. The statistics on alternating sign matrices they consider are:

- the column number of the 1 in the first row (note that only one 1 exists in that row),
- the (generalized) inversion number (for a detailed definition see Section 5),
- the number of -1 in the matrix,
- the number of 0's to the right of the 1 in the last row

For example, the statistics are 3, 2, 1 and 1 in the example we introduced in the first paragraph.

The main idea of the present paper is the notion of compatibility, which is defined as follows:

A sijection φ from $S = (S^+, S^-)$ to $T = (T^+, T^-)$ is *compatible* with a statistic function $\eta: S^+ \sqcup S^- \sqcup T^+ \sqcup T^- \rightarrow \mathbb{Z}^d$ if it holds that:

$$\forall s \in S^+ \sqcup T^-, \eta(\varphi(s)) = \eta(s).$$

This means that the statistic η is preserved under the action of φ . In Section 4, we interpret the sijections relevant to Gelfand-Tsetlin patterns that are constructed in [7] in the light of the notion of compatibility. This interpretation gives us some new knowledge about these objects. With the notion of integrable systems of combinatorial objects, which will also be defined in that section, we will describe the combinatorial structure of Gelfand-Tsetlin patterns. This result leads us to a new computational proof of the enumeration of Gelfand-Tsetlin patterns with a bottom row that is not strictly increasing. Furthermore, inspired by this new proof, we obtain a new generalization of Gelfand-Tsetlin patterns and a signed enumeration of the objects.

The notion of compatibility also helps us to import Di Francesco et al.'s results to Fischer and Konvalinka's work. We know the meaningful statistics according to the refined enumerations, so with these statistics and the notion of compatibility, we are able to measure the naturalness of constructed sijections. In Section 5, we will extend the definition of two of the four statistics to shifted Gelfand-Tsetlin patterns and discuss the compatibility with these two statistics. In fact, Fischer and Konvalinka's construction is not compatible with one of these statistics. We will construct a new sijection between the two objects which is compatible with both of the statistics. Therefore, according to the notion of compatibility, our construction can be considered more natural than Fischer and Konvalinka's.

In fact, in [9] Fischer and Schreier-Aigner obtain a more elaborate result to do with a refined enumeration of alternating sign matrices and descending plane partitions. Amongst others, they provide a refined enumeration of some extensions of alternating sign matrices with $n + 3$ statistics. With a slight modification, this result can be recognized as a refined enumeration of generalized monotone triangles, which is defined in Section 5. It is expressed as follows (for detailed definitions, see Section 5):

$$\prod_{i=1}^n (uX_i + vX_i^{-1} + w) \prod_{1 \leq p < q \leq n} \left(uE_{k_p} + vE_{k_q}^{-1} + wE_{k_p}E_{k_q}^{-1} \right) \tilde{s}_{(k_n, k_{n-1}, \dots, k_1)}(X_1, X_2, \dots, X_n).$$

We recognize this expression as a refined enumeration of the Cartesian product of arrow rows and shifted Gelfand-Tsetlin patterns, where arrow rows will be defined in Section 5. Then, we give a bijective proof for the refined enumeration of generalized monotone triangles by appropriately defining the $n + 3$ statistics on the Cartesian product and constructing a sijection between generalized monotone triangles and the Cartesian product that is compatible with these statistics. For more details, see Subsection 5.6.

As a last remark in this section we explain the choice of title captions in this paper, in which we construct many sijections. On the one hand, such constructions constitute proof of the existence of the sijections, but on the other hand the constructions themselves also become objects that will be used in later propositions and/or theorems. Therefore, not only the existence but also the explicit construction of each sijection is important. Thus, when we describe a construction of a sijection in detail we will use “Construction” as a title caption instead of “Proposition”, “Theorem” or “Proof”. This convention is partially derived from Fischer and Konvalinka’s papers [7, 8].

2 Preliminaries

2.1 Signed Sets

A *signed set* is a pair of disjoint finite sets. For a signed set S , we call its first (resp. second) element the *plus part* (resp. *minus part*) of S and denote it by S^+ (resp. S^-). Namely, $S = (S^+, S^-)$. For a signed set S , we call the set $S^+ \sqcup S^-$ the support of S and denote it by $\text{supp}(S)$. The *size* of a signed set S is defined by $\#S = \#S^+ - \#S^-$, where we denote the size of a set X by $\#X$.

Next, we define some basic notions relevant to signed sets. (See also [7].)

- The *opposite* of a signed set S is $-S := (S^-, S^+)$.
- The *disjoint union* of two signed sets S and T is $S \sqcup T := (S^+ \sqcup T^+, S^- \sqcup T^-)$.
- The *Cartesian product* of two signed sets S and T is

$$S \times T := (S^+ \times T^+ \sqcup S^- \times T^-, S^+ \times T^- \sqcup S^- \times T^+).$$

We define the disjoint union and the Cartesian product of a finite number of signed sets in the same manner. In addition, we can define a *disjoint union with signed index* of a family of signed sets indexed by a signed set (to be rigorous, indexed by the support of the signed set) in the following way.

Definition 2.1. Let T be a signed set and $\{S_t\}_{t \in \text{supp}(T)}$ a family of signed sets. The disjoint union with signed index in T of $\{S_t\}_{t \in \text{supp}(T)}$ is

$$\bigsqcup_{t \in T} S_t := \left(\bigsqcup_{t \in T^+} (S_t^+) \sqcup \bigsqcup_{t \in T^-} (S_t^-), \bigsqcup_{t \in T^+} (S_t^-) \sqcup \bigsqcup_{t \in T^-} (S_t^+) \right).$$

We denote an element of $\bigsqcup_{t \in T} S_t$ as (s_t, t) for $s_t \in \text{supp}(S_t)$. For simplicity, we will sometimes denote an element of $\bigsqcup_{u \in U} \bigsqcup_{t \in T} S_{t,u}$ as $(s_{t,u}, t, u)$ instead of $((s_{t,u}, t), u)$.

Let us define a *signed interval*, which is the most basic example of a signed set. For any two integers a and b , a signed interval $\underline{[a, b]}$ is defined by,

$$\underline{[a, b]} = \begin{cases} ([a, b] \cap \mathbb{Z}, \emptyset) & (a < b), \\ (\emptyset, \emptyset) & (a = b), \\ (\emptyset, [b, a] \cap \mathbb{Z}) & (a > b). \end{cases}$$

It is noteworthy that we use half-open intervals to describe signed intervals instead of closed intervals as in [7, 8]. Because of this, we have $\underline{[b, a]} = -\underline{[a, b]}$. This relation is crucial and many properties of Gelfand-Tsetlin patterns are easier to establish using this notation. For more information, see section 4.

2.2 Sijections

A *sijection* φ from a signed set S to a signed set T is an involution on $\text{supp}(S) \sqcup \text{supp}(T)$ such that $\varphi(S^+ \sqcup T^-) = S^- \sqcup T^+$, namely a sijection φ is a bijection between $S^+ \sqcup T^-$ and $S^- \sqcup T^+$. We denote it by $S \rightsquigarrow T$. If there is a sijection from S to T , then $\#S = \#T$ holds. This relation is an analogy of the relation between ordinary sets and a bijection. In particular, if $S^- = T^- = \emptyset$, then we can interpret S and T as ordinary sets and a sijection between them as an ordinary bijection.

A sijection φ can be also recognized as a triplet of a sign-preserving bijection from a subset of S to a subset of T , a sign-reversing involution on the remaining part of S , and a sign-reversing involution on the remaining part of T . Figure 1 below illustrates this interpretation of a sijection. In the figure, the upper-left square represents the set S^+ , and similarly for the other three squares. The symbol \rightsquigarrow was inspired by the figure.

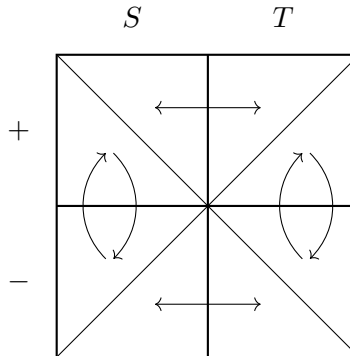

Figure 1: An illustration of a sijection

The simplest example of a sijection is the *identity sijection* id_S , defined by

$$\begin{array}{c} S \circ\!\!\!\circlearrowleft S \\ s \longleftarrow\!\!\!\longrightarrow s \end{array}$$

for any signed set S . Let us introduce a few more examples which we shall use in later Sections.

Example 2.2. For any integers a, b and c , we can construct a sijection $\varphi: \underline{[a, b]} \circ\!\!\!\circlearrowleft \underline{[a, c]} \sqcup \underline{[c, b]}$ as follows:

In case $a < b < c$, for $x \in \underline{[a, b]}$, $\varphi(x) = x \in \underline{[a, c]}$ and for $x \in \underline{[a, b]} \subset \underline{[a, c]}$ (i.e. as an element of the codomain), $\varphi(x) = x \in \underline{[a, b]}$. The remaining part of $\underline{[a, c]}$ can be related to $\underline{[c, b]}$.

A similar construction can be given in the other cases.

This sijection is simple but plays an important role in Fischer and Konvalinka's constructions [7, 8].

Example 2.3. Let S, T be signed sets and $\varphi: S \circ\!\!\!\circlearrowleft T$ a sijection. Then, we have a sijection $S \sqcup -T \circ\!\!\!\circlearrowleft (\emptyset, \emptyset)$. In particular, we have $S \sqcup -S \circ\!\!\!\circlearrowleft (\emptyset, \emptyset)$ derived from the identity sijection on S .

2.2.1 Composition of sijections

A composition of sijections is defined as follows [7].

Lemma & Definition 2.4 ([7, Proposition 2 (1)]). Let S, T, U be signed sets and $\varphi: S \circ\!\!\!\circlearrowleft T$, $\psi: T \circ\!\!\!\circlearrowleft U$ sijections. For $s \in \text{supp}(S)$, we define $\psi \circ \varphi(s)$ as the last well-defined element in the sequence

$$s, \varphi(s), \psi(\varphi(s)), \varphi(\psi(\varphi(s))), \dots$$

Similarly, for $u \in \text{supp}(U)$, we define $\psi \circ \varphi(u)$ as the last well-defined element in the sequence

$$u, \psi(u), \varphi(\psi(u)), \psi(\varphi(\psi(u))), \dots$$

Then, $\psi \circ \varphi$ is a sijection from S to U , and we call it the composition of φ and ψ .

First we should clarify what we mean by “the last well-defined element in the sequence $s, \varphi(s), \psi(\varphi(s)), \varphi(\psi(\varphi(s))), \dots$ ”. For example if $\varphi(s)$ belongs to $\text{supp}(S)$, then $\psi(\varphi(s))$ is not defined because the domain of ψ is $\text{supp}(T) \sqcup \text{supp}(U)$. Therefore, $(\psi \circ \varphi)(s)$ is $\varphi(s)$ in this case. For the original proof of the lemma, see [4]. Here, we give an alternative proof of this fact using the language of graphs. A graph in the proof might have multiple edges, so we fix notations relevant to multisets. We use double braces to describe a multiset, and use the symbol “+” to describe a sum of multisets.

Proof of Lemma & Definition 2.4. Consider a graph with vertices $V = \text{supp}(S) \sqcup \text{supp}(T) \sqcup \text{supp}(U)$ and edges $E = R + B$, where

$$\begin{aligned} R &= \{ \{ \{v, \varphi(v)\} \mid v \in S^+ \sqcup T^- \} \} \\ B &= \{ \{ \{v, \psi(v)\} \mid v \in T^+ \sqcup U^- \} \}. \end{aligned}$$

Note that the graph is an undirected bipartite graph, where one part is $S^+ \sqcup T^- \sqcup U^+$ and the other part is $S^- \sqcup T^+ \sqcup U^-$. We consider painting edges in R with red and those in B with blue. Then, by the definitions, each vertex belongs to at most one red edge and at most one blue edge. Because of the degrees of the vertices, the graph consists of line graphs and cycles. Moreover, all the endpoints of these line graphs belong to $\text{supp}(S) \sqcup \text{supp}(U)$ and for each line graph or cycle the color of the edges alternate. Please refer to Figure 2 below for an example: dashed edges represent blue ones and the others red ones. In addition, the shape of a node corresponds to which part it belongs to.

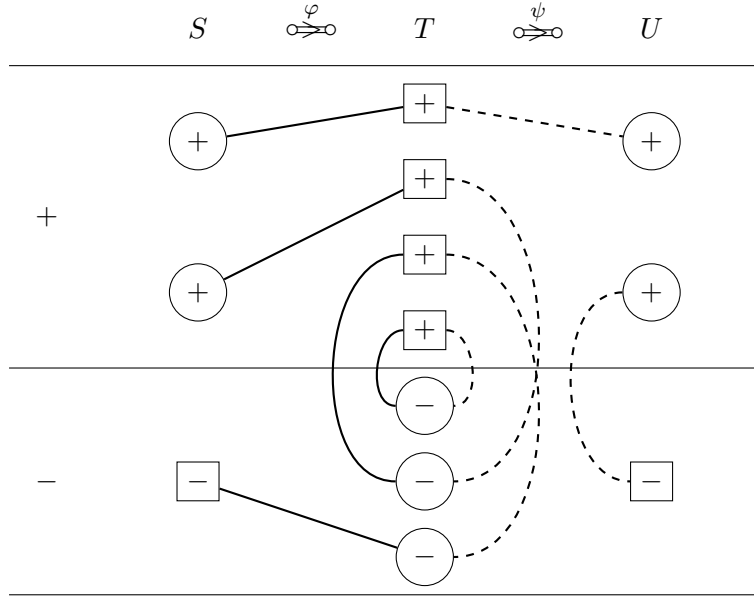

Figure 2: A composition of sijections

Consider $s \in \text{supp}(S)$. The degree of s is 1, so it is an endpoint of a line graph. Therefore, $\psi \circ \varphi(s)$ is the other endpoint of the line graph. If $\psi \circ \varphi(s) \in \text{supp}(S)$, the first edge and the last edge in the line graph are both red, so its length is odd. Thus, s and $\psi \circ \varphi(s)$ belong to different parts of G as a bipartite graph. Therefore, the sign of $\psi \circ \varphi(s)$ is different from that of s . In the other case, namely when $\psi \circ \varphi(s) \in \text{supp}(U)$, the length of the line graph is even and $\psi \circ \varphi(s)$ belongs to the same part as s , so the sign of $\psi \circ \varphi(s)$ is equal to that of s .

For $u \in \text{supp}(U)$, we can give a similar proof. Therefore, $\psi \circ \varphi$ is a well-defined sijection from S to U . \square

Relating to this proof we define a graph $G = (V, E)$ of a sijection $\varphi: S \rightsquigarrow T$ as follows:

$$V := \text{supp}(S) \sqcup \text{supp}(T),$$

$$E := \{ \{v, \varphi(v)\} \mid v \in S^+ \sqcup T^- \}.$$

This notion is useful to prove some lemmas and to understand properties of sijections. For example,

with this language, the sijection $\varphi: [1, 3] \sqcup [3, 2] \rightsquigarrow [1, 2]$ in Example 2.2 is described as:

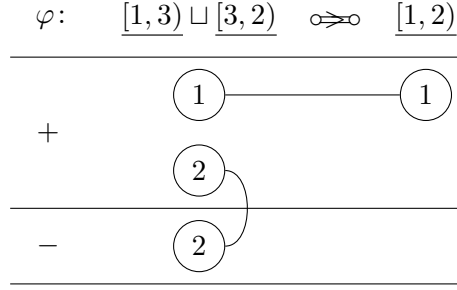

Last, we prove that compositions of sijections have the associative property.

Proposition 2.5 ([4], Corollary 3). *Let S, T, U and V be signed sets and $\varphi: S \rightsquigarrow T$, $\psi: T \rightsquigarrow U$, and $\xi: U \rightsquigarrow V$ sijections. Then,*

$$\xi \circ (\psi \circ \varphi) = (\xi \circ \psi) \circ \varphi.$$

Proof. Consider a graph with vertices $\text{supp}(S) \sqcup \text{supp}(T) \sqcup \text{supp}(U) \sqcup \text{supp}(V)$ and edges $\{\{v, \varphi(v)\} \mid v \in S^+ \sqcup T^-\} + \{\{v, \psi(v)\} \mid v \in T^+ \sqcup U^-\} + \{\{v, \xi(v)\} \mid v \in U^+ \sqcup V^-\}$. This graph consists of line graphs and cycles. Moreover, for any endpoint v of a line graph the other endpoint of the line graph is $(\xi \circ (\psi \circ \varphi))(v) = ((\xi \circ \psi) \circ \varphi)(v)$. \square

2.2.2 Cartesian products of sijections

The definition of the Cartesian product of sijections is a bit more complicated. For sijections $\varphi_i: S_i \rightsquigarrow T_i$ ($i = 1, 2$), we can construct a sijection $\varphi_1 \times \varphi_2$ between $S_1 \times S_2$ and $T_1 \times T_2$ as follows:

For $s = (s_1, s_2) \in \text{supp}(S_1 \times S_2) = \text{supp}(S_1) \times \text{supp}(S_2)$,

$$(\varphi_1 \times \varphi_2)(s) = \begin{cases} (\varphi_1(s_1), s_2) & \varphi_1(s_1) \in \text{supp}(S_1), \\ (s_1, \varphi_2(s_2)) & \varphi_1(s_1) \in \text{supp}(T_1) \text{ and } \varphi_2(s_2) \in \text{supp}(S_2), \\ (\varphi_1(s_1), \varphi_2(s_2)) & \varphi_1(s_1) \in \text{supp}(T_1) \text{ and } \varphi_2(s_2) \in \text{supp}(T_2), \end{cases}$$

and for $t = (t_1, t_2) \in \text{supp}(T_1 \times T_2) = \text{supp}(T_1) \times \text{supp}(T_2)$,

$$(\varphi_1 \times \varphi_2)(t) = \begin{cases} (\varphi_1(t_1), t_2) & \varphi_1(t_1) \in \text{supp}(T_1), \\ (t_1, \varphi_2(t_2)) & \varphi_1(t_1) \in \text{supp}(S_1) \text{ and } \varphi_2(t_2) \in \text{supp}(T_2), \\ (\varphi_1(t_1), \varphi_2(t_2)) & \varphi_1(t_1) \in \text{supp}(S_1) \text{ and } \varphi_2(t_2) \in \text{supp}(S_2). \end{cases}$$

It is easy to check that this sijection is indeed an involution on $\text{supp}(S_1 \times S_2) \sqcup \text{supp}(T_1 \times T_2)$ and that it meets the sign conditions:

- if $(\varphi_1 \times \varphi_2)(s) \in \text{supp}(S_1 \times S_2)$, the sign of $(\varphi_1 \times \varphi_2)(s)$ is equal to the sign of s ,
- if $(\varphi_1 \times \varphi_2)(s) \in \text{supp}(T_1 \times T_2)$, the sign of $(\varphi_1 \times \varphi_2)(s)$ is different from the sign of s ,

- and similar results are true for $t \in \text{supp}(T_1 \times T_2)$.

Therefore, it is indeed a sijection. Additionally, this definition has the associative property.

Proposition 2.6. *Let $\varphi_i: S_i \rightsquigarrow T_i$ be a sijection for $i = 1, 2, 3$. Then, we have*

$$(\varphi_1 \times \varphi_2) \times \varphi_3 = \varphi_1 \times (\varphi_2 \times \varphi_3).$$

Proof. Regardless of how one puts the parentheses, if all φ_i send s_i to T_i , then $s = (s_1, s_2, s_3)$ corresponds to $(\varphi_1(s_1), \varphi_2(s_2), \varphi_3(s_3))$. Otherwise, only the leftmost element s_i of s such that $\varphi_i(s_i) \in S_i$ is replaced with $\varphi_i(s_i)$. \square

Thus, we can define the Cartesian product of a finite number of sijections as follows. (See also Proposition 2(2) of [7].)

Definition 2.7. Let $S_1, S_2, \dots, S_k, T_1, T_2, \dots, T_k$ be signed sets and let $\varphi_i: S_i \rightsquigarrow T_i$ be a sijection for $i = 1, 2, \dots, k$. We define

$$\varphi_1 \times \varphi_2 \times \dots \times \varphi_k = (\dots((\varphi_1 \times \varphi_2) \times \varphi_3) \times \dots) \times \varphi_k.$$

Let $s = (s_1, s_2, \dots, s_k) \in \text{supp}(S_1 \times S_2 \times \dots \times S_k) = \text{supp}(S_1) \times \text{supp}(S_2) \times \dots \times \text{supp}(S_k)$. Then, according to the proof of Proposition 2.6, when $\varphi_i(s_i) \in \text{supp}(T_i)$ for all $i = 1, 2, \dots, k$, we have

$$(\varphi_1 \times \varphi_2 \times \dots \times \varphi_k)(s) = (\varphi_1(s_1), \varphi_2(s_2), \dots, \varphi_k(s_k)).$$

Otherwise, we have

$$(\varphi_1 \times \varphi_2 \times \dots \times \varphi_k)(s) = (s_1, s_2, \dots, s_{j-1}, \varphi_j(s_j), s_{j+1}, \dots, s_k),$$

where j is the minimum index such that $\varphi_j(s_j) \in \text{supp}(S_j)$. For an element of $\text{supp}(T_1 \times T_2 \times \dots \times T_k)$, a similar expression can be given.

Remark. *We remark on a disadvantageous feature of this Cartesian product of sijections. Let $\varphi_i: S_i \rightsquigarrow T_i$ and $\psi_i: T_i \rightsquigarrow U_i$ be sijections for $i = 1, 2$. In general, it does not hold that*

$$(\psi_1 \times \psi_2) \circ (\varphi_1 \times \varphi_2) = (\psi_1 \circ \varphi_1) \times (\psi_2 \circ \varphi_2). \quad (*)$$

For example, let $S = (\{A\}, \emptyset)$, $T = (\{A, B\}, \{B^\dagger\})$ and define a sijection φ as

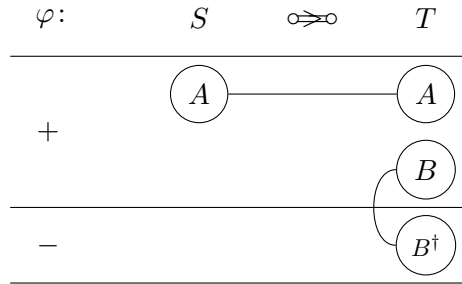

If the relation (*) is always true, it must hold that

$$(id_T \times \varphi) \circ (\varphi \times id_S) = \varphi \times \varphi = (\varphi \times id_T) \circ (id_S \times \varphi).$$

However, we have by a simple calculation that

$$((id_T \times \varphi) \circ (\varphi \times id_S))((B, B)) = (B, B^\dagger) \neq (B^\dagger, B) = ((\varphi \times id_T) \circ (id_S \times \varphi))((B, B)),$$

so we have a contradiction. Thus, the relation $(*)$ is not always true.

This feature is inevitable, namely it is not due to a defect in the definition. For instance, in the above situation, we cannot determine which of (B, B^\dagger) and (B^\dagger, B) should be $(\varphi \times \varphi)((B, B))$ a priori because of symmetry.

2.2.3 Disjoint unions of sijections

For sijections $\varphi_i: S_i \twoheadrightarrow T_i$ ($i = 1, 2$), the disjoint union $\varphi_1 \sqcup \varphi_2: S_1 \sqcup S_2 \twoheadrightarrow T_1 \sqcup T_2$ is defined by

$$(\varphi_1 \sqcup \varphi_2)(s) = \begin{cases} \varphi_1(s) & s \in \text{supp}(S_1) \sqcup \text{supp}(T_1), \\ \varphi_2(s) & s \in \text{supp}(S_2) \sqcup \text{supp}(T_2). \end{cases}$$

We define the disjoint union of a finite number of sijections in the same manner. Considering the graph of sijections, the disjoint union is just a juxtaposition, so we have $(\varphi_1 \sqcup \varphi_2) \sqcup \varphi_3 = \varphi_1 \sqcup (\varphi_2 \sqcup \varphi_3)$.

Next, we define the disjoint union with signed index of a family of sijections.

Definition 2.8 (Proposition 2(3) in [7]). Let T, \tilde{T} be signed sets and $\psi: T \twoheadrightarrow \tilde{T}$ a sijection. Assume that we have signed sets $\{S_t\}_{t \in \text{supp}(T) \sqcup \text{supp}(\tilde{T})}$ and sijections $\{\varphi_t: S_t \twoheadrightarrow S_{\psi(t)}\}_{t \in T^+ \sqcup \tilde{T}^-}$. Let $\varphi_t = \varphi_{(\psi(t))}$ for $t \in T^- \sqcup \tilde{T}^+$. Then, we have a sijection φ from $\bigsqcup_{t \in T} S_t$ to $\bigsqcup_{t \in \tilde{T}} S_t$ defined by

$$\varphi((s_t, t)) = \begin{cases} (\varphi_t(s_t), t) & \text{if } \varphi_t(s_t) \in T, \\ (\varphi_t(s_t), \psi(t)) & \text{if } \varphi_t(s_t) \in \tilde{T}. \end{cases}$$

We denote it by $\bigsqcup_{t \in T \sqcup \tilde{T}} \varphi_t$.

Considering the graphs of sijections, the disjoint union of this type is also a juxtaposition. Therefore, it is indeed a sijection. When $T = \tilde{T}$ and $\psi = id_T$ hold, the situation becomes simple. Then, when we have sijections $\{\varphi_t: S_t \twoheadrightarrow \tilde{S}_t\}_{t \in \text{supp}(T)}$, by applying the definition we have

$$\bigsqcup_{t \in T} \varphi_t: \bigsqcup_{t \in T} S_t \twoheadrightarrow \bigsqcup_{t \in T} \tilde{S}_t.$$

The constructions of sijections in the following Examples (2.9 - 2.12) become trivial by considering their graphs. In particular, they can be decomposed to a bijection between plus parts and one between minus parts. Therefore, we shall use “=” to describe these sijections in later constructions of much more complicated sijections.

Example 2.9. Let S, T_1 and T_2 be signed sets. Then, we have a sijection

$$S \times (T_1 \sqcup T_2) \twoheadrightarrow (S \times T_1) \sqcup (S \times T_2).$$

Example 2.10. Let S_1 and S_2 be signed sets and $\{T_{s_1, s_2}\}_{s_1 \in \text{supp}(S_1), s_2 \in \text{supp}(S_2)}$ a family of signed sets. Then, we have a sijection

$$\bigsqcup_{s_1 \in S_1} \bigsqcup_{s_2 \in S_2} T_{s_1, s_2} \twoheadrightarrow \bigsqcup_{s_2 \in S_2} \bigsqcup_{s_1 \in S_1} T_{s_1, s_2}.$$

Example 2.11. Let U be a signed set and $\{T_u\}_{u \in \text{supp}(U)}$, $\{S_{t,u}\}_{u \in \text{supp}(U), t \in \text{supp}(T_u)}$ families of signed sets. Then, we have a sijection

$$\bigsqcup_{u \in U} \bigsqcup_{t \in T_u} S_{t,u} \overset{\circ}{\cong} \bigsqcup_{t \in \bigsqcup_{u \in U} T_u} S_{t,u}.$$

Example 2.12. Let T, U be signed sets and $\{S_v\}_{v \in \text{supp}(T) \sqcup \text{supp}(U)}$ a family of signed sets. Then, we have a sijection

$$\bigsqcup_{t \in T} S_t \sqcup \bigsqcup_{u \in U} S_u \overset{\circ}{\cong} \bigsqcup_{v \in T \sqcup U} S_v.$$

As a last remark in this section, in the following we fix operator precedence for signed sets as:

1. taking opposite $(-)$,
2. the Cartesian products (\times) ,
3. disjoint unions (\sqcup) .

3 Compatibility

We introduce the notion of *compatibility*, the most important idea in this paper.

Definition 3.1. A *statistic* of a signed set is a function on (at least) its support. Let S, T be signed sets and let η be a statistic of $S \sqcup T$. A sijection $\phi: S \overset{\circ}{\cong} T$ is *compatible with η* if

$$\forall s \in \text{supp}(S \sqcup T), \eta(\phi(s)) = \eta(s).$$

The codomain of statistics does not matter, so we will not pay attention to it. For simplicity, we will sometimes write $s \overset{\circ}{\in} S$ instead of $s \in \text{supp}(S)$.

Compatibility is a generalization of the notion of *normality* which is introduced in [7]. For example, let us consider the sijection φ in Example 2.2, which is normal in the language of [7]. We can recognize each element of the support of $\overline{[a, b]} \sqcup (\overline{[a, c]} \sqcup \overline{[c, b]})$ as an integer in the canonical way, so we can define a canonical \mathbb{Z} -valued statistic of $\overline{[a, b]} \sqcup (\overline{[a, c]} \sqcup \overline{[c, b]})$. The sijection φ is compatible with this statistic. We call statistics of this type *normal* statistics. The precise definition is given in Definition 3.5.

Compatibility is preserved under compositions and so is normality.

Lemma 3.2. Let $\phi: S \overset{\circ}{\cong} T$, $\psi: T \overset{\circ}{\cong} U$ be sijections and η a statistic of $S \sqcup T \sqcup U$. If ϕ and ψ are compatible with η , then $\psi \circ \phi$ is compatible with η .

Proof. For any $s \overset{\circ}{\in} S$, $\eta(s) = \eta(\phi(s)) = \eta(\psi(\phi(s))) = \dots$ while they are well-defined. Therefore, $\eta(s) = \eta(\psi \circ \phi(s))$. The same is true for an element of $\text{supp}(U)$. \square

As well as for compositions, compatibility is preserved under disjoint unions and Cartesian products.

Lemma 3.3. Let $\varphi_i: S_i \twoheadrightarrow T_i$ be a sijection compatible with a statistic η_i for $i = 1, 2$. When we define a statistic $\eta = \eta_1 \sqcup \eta_2$ by

$$\eta(u) = (\eta_1 \sqcup \eta_2)(u) = \begin{cases} \eta_1(u) & (u \overset{\circ}{\in} S_1 \sqcup T_1) \\ \eta_2(u) & (u \overset{\circ}{\in} S_2 \sqcup T_2), \end{cases}$$

$\varphi_1 \sqcup \varphi_2$ is compatible with $\eta_1 \sqcup \eta_2$.

Lemma 3.4. Let $\varphi_i: S_i \twoheadrightarrow T_i$ be a sijection compatible with a statistic η_i for $i = 1, 2$. When we define a statistic $\eta = \eta_1 \times \eta_2$ by

$$\eta((u_1, u_2)) = (\eta_1 \times \eta_2)(u) = (\eta_1(u_1), \eta_2(u_2)),$$

$\varphi_1 \times \varphi_2$ is compatible with $\eta_1 \times \eta_2$.

By these definitions, a disjoint union and the Cartesian product of more than two sijections can be treated in the same manner. Furthermore, in the situation of definition 2.8, if sijections $\{\varphi_t\}_{t \in T \sqcup \tilde{T}}$ are compatible with some statistic η , then $\bigsqcup_{t \in T \sqcup \tilde{T}} \varphi_t$ is also compatible with η . Proofs can be given either by considering the graphs of sijections or by using the definitions.

In addition, if we have a sijection $\psi: T \twoheadrightarrow \tilde{T}$ compatible with some statistic η and signed sets $\{S_t\}_{t \in \eta(\text{supp}(T) \sqcup \text{supp}(\tilde{T}))}$ then we have, by applying the definition 2.8, a sijection

$$\bigsqcup_{t \in T \sqcup \tilde{T}} \text{id}_{S_{\eta(t)}}: \bigsqcup_{t \in T} S_{\eta(t)} \twoheadrightarrow \bigsqcup_{t \in \tilde{T}} S_{\eta(t)}.$$

Furthermore, this sijection is compatible with the ‘forgetful’ statistic:

$$\eta_f: \text{supp} \left(\bigsqcup_{t \in T} S_{\eta(t)} \sqcup \bigsqcup_{t \in \tilde{T}} S_{\eta(t)} \right) \rightarrow \bigcup_{t \in \eta(\text{supp}(T) \sqcup \text{supp}(\tilde{T}))} \text{supp}(S_t).$$

Definition 3.5. A *normal* signed set is a signed interval or a signed set that is made by finite operations of disjoint union or Cartesian product of signed intervals. For a signed interval, its *normal statistic* is the inclusion map to \mathbb{Z} . For two pairs of normal signed sets and their normal statistics (S_1, η_1) , (S_2, η_2) , we define the normal statistic of $S_1 \sqcup S_2$ by $\eta_1 \sqcup \eta_2$ as in Lemma 3.3 and the normal statistic of $S_1 \times S_2$ by $\eta_1 \times \eta_2$ as in Lemma 3.4.

Remark. These definitions are similar to those of elementary signed sets and normality in [7].

We prepare one notation for later use.

Definition 3.6. Let S be a signed set and η a statistic of S . For an element $a \in \eta(\text{supp}(S))$, we define the restriction of S as follows:

$$S \upharpoonright_{\eta=a} = (\{s \in S^+ \mid \eta(s) = a\}, \{s \in S^- \mid \eta(s) = a\}).$$

Let us explain the motivation for introducing the notion of compatibility. In bijective combinatorics, one always wants to construct a more natural bijection. However, which one is more natural than the other is controversial. The notion of compatibility is an answer to this question. Namely,

a bijection (or a sijection) which is compatible with a finer statistic is more natural, where the size of the image of a statistic determines how fine it is. Unfortunately, when a sijection $\Gamma: S \circ \rightleftarrows T$ is given, we can always construct one of the finest but trivial statistic $\eta: \text{supp}(S \sqcup T) \rightarrow S^+ \sqcup T^-$ such that

$$\begin{aligned} \forall s \in S^+ \sqcup T^-, \eta(s) = s, \\ \forall s \in S^- \sqcup T^+, \eta(s) = \Gamma(s). \end{aligned}$$

Nevertheless, the notion of compatibility is useful because we can translate naturality of a sijection into one of a statistic through it. When a seemingly natural sijection is given, we can explain why it is truly natural through compatibility. This process sometimes leads us to novel combinatorial structures. Our first application of compatibility concerns Gelfand-Tsetlin patterns. It is an example of this type of application of compatibility. For more details, see section 4.

In another interpretation, a construction of a sijection with compatibility gives a bijective proof of a refined enumeration. In this context, first, a seemingly natural statistic is given according to a computational proof of a refined enumeration. After that, we try to construct a sijection compatible with the statistic. In fact, the existence is guaranteed through the computational proof but we need to find an algorithm to construct it. Our second application of compatibility is of this type. We define statistics on alternating sign matrices and shifted Gelfand-Tsetlin patterns by referring to refined enumerations for alternating sign matrices [1, 2], and construct a sijection which is compatible with the statistics. The construction is similar to Fischer and Konvalinka's work [7], but our construction is more elementary. For more details, see section 5.

In the first type of application we make a statistic referring to a sijection and vice versa in the second type of application. Either way, we have to obtain a pair of a seemingly natural statistic and a seemingly natural sijection compatible with the statistic to state that they are truly natural.

4 About Gelfand-Tsetlin patterns

4.1 Definitions

A classical Gelfand-Tsetlin pattern is a triangular array $(a_{i,j})_{1 \leq j \leq i \leq n}$ of integers such that for any $1 \leq j \leq i \leq n-1$, it holds that $a_{i+1,j} \leq a_{i,j} \leq a_{i+1,j+1}$. When the elements are arranged as follows

$$\begin{array}{cccccccc} & & & & & & & a_{1,1} \\ & & & & & & & a_{2,1} & a_{2,2} \\ & & & & & & & a_{3,1} & a_{3,2} & a_{3,3} \\ & & & & & & & \ddots & \vdots & \ddots \\ & & & & & & & a_{n,1} & \cdots & \cdots & a_{n,n} \end{array}$$

each element is greater than or equal to the element left-below and is less than or equal to the element right-below. We call the sequence $(a_{n,1}, a_{n,2}, \dots, a_{n,n})$ the bottom row of a monotone triangle $(a_{i,j})_{i,j}$. For reasons that will become clear afterwards, we shall modify this definition a bit. We impose the condition

$$1 \leq \forall j \leq \forall i \leq n-1, a_{i+1,j} \leq a_{i,j} < a_{i+1,j+1}, \quad (1)$$

instead of $a_{i+1,j} \leq a_{i,j} \leq a_{i+1,j+1}$. Clearly, the original Gelfand-Tsetlin patterns with bottom row (k_1, k_2, \dots, k_n) are in one-to-one correspondence with the new ones with bottom row

$(k_1, k_2 + 1, \dots, k_n + n - 1)$. Indeed, an original Gelfand-Tsetlin pattern $(a_{i,j})_{ij}$ can be thought of as corresponding to a new one $(a_{i,j} + j - 1)_{ij}$. For example,

$$\begin{array}{ccc} & 3 & \\ & 1 & 3 \\ 1 & 3 & 4 \end{array} \mapsto \begin{array}{ccc} & 3 & \\ & 1 & 4 \\ 1 & 4 & 6 \end{array}$$

A generalization of classical Gelfand-Tsetlin patterns is introduced in [7]. The signed set of the generalization is defined as follows, where because of the modification of the condition (1) we use half-open intervals instead of closed intervals.

Definition 4.1. For $k \in \mathbb{Z}$, define $\text{GT}(k) = (\{k\}, \emptyset)$, and for $\mathbf{k} = (k_1, k_2, \dots, k_n) \in \mathbb{Z}^n$, $n \geq 2$, define $\text{GT}(\mathbf{k})$ recursively as

$$\text{GT}(\mathbf{k}) = \text{GT}(k_1, k_2, \dots, k_n) = \bigsqcup_{\mathbf{l} \in \underline{[k_1, k_2]} \times \dots \times \underline{[k_{n-1}, k_n]}} \text{GT}(\mathbf{l}).$$

4.2 Known bijections relevant to Gelfand-Tsetlin patterns

Fischer and Konvalinka construct some bijections relevant to Gelfand-Tsetlin pattern in [7]. In this subsection, we explain these known results. Using our notations, it is easy to describe the results and the constructions become transparent, which is why we choose to give considerable details for them although they are essentially the same as Fischer and Konvalinka's work.

Construction 4.2 (Problem 4 in [7]). Let $\mathbf{a} = (a_1, a_2, \dots, a_n) \in \mathbb{Z}^n$, $\mathbf{b} = (b_1, b_2, \dots, b_n) \in \mathbb{Z}^n$ and $x \in \mathbb{Z}$. We construct a bijection

$$\rho = \rho_{\mathbf{a}, \mathbf{b}, x}: \bigsqcup_{\mathbf{l} \in \underline{[a_1, b_1]} \times \underline{[a_2, b_2]} \times \dots \times \underline{[a_n, b_n]}} \text{GT}(\mathbf{l}) \xrightarrow{\cong} \bigsqcup_{\mathbf{m} \in S_1 \times S_2 \times \dots \times S_n} \text{GT}(\mathbf{m}, x),$$

where $S_i = (\{a_i\}, \{b_i\})$, $\mathbf{m} = (m_1, m_2, \dots, m_n)$ and $\text{GT}(\mathbf{m}, x) = \text{GT}(m_1, m_2, \dots, m_n, x)$.

First, we construct the following bijection.

Subconstruction 4.2.1 (Problem 2. in [7]). We construct a bijection

$$\beta = \beta_{\mathbf{a}, \mathbf{b}, x}: \underline{[a_1, b_1]} \times \underline{[a_2, b_2]} \times \dots \times \underline{[a_n, b_n]} \xrightarrow{\cong} \bigsqcup_{\mathbf{m} \in S_1 \times S_2 \times \dots \times S_n} \underline{[m_1, m_2]} \times \underline{[m_2, m_3]} \times \dots \times \underline{[m_{n-1}, m_n]} \times \underline{[m_n, x]},$$

which is compatible with the normal statistic. The construction is by induction on n . If $n = 1$, it coincides with Example 2.2. If $n > 1$, we have, by induction,

$$\begin{aligned} & \underline{[a_1, b_1]} \times \underline{[a_2, b_2]} \times \dots \times \underline{[a_n, b_n]} \\ & \xrightarrow{\cong} \underline{[a_1, b_1]} \times \bigsqcup_{(\mathbf{m}_2, \mathbf{m}_3, \dots, \mathbf{m}_n) \in S_2 \times S_3 \times \dots \times S_n} \underline{[m_2, m_3]} \times \dots \times \underline{[m_{n-1}, m_n]} \times \underline{[m_n, x]} \\ & \xrightarrow{\cong} \bigsqcup_{(\mathbf{m}_2, \mathbf{m}_3, \dots, \mathbf{m}_n) \in S_2 \times S_3 \times \dots \times S_n} \underline{[a_1, b_1]} \times \underline{[m_2, m_3]} \times \dots \times \underline{[m_{n-1}, m_n]} \times \underline{[m_n, x]}. \end{aligned}$$

Here, we have $\underline{[a_1, b_1]} \xrightarrow{\cong} \underline{[a_1, m_2]} \sqcup \underline{[m_2, b_1]} = \underline{[a_1, m_2]} \sqcup -\underline{[b_1, m_2]} = \bigsqcup_{m_1 \in S_1} \underline{[m_1, m_2]}$, then the construction is completed. The compatibility is induced in the obvious way. \square

We return to the construction of ρ . By using the subconstruction and Example 2.11, and considering a disjoint union with signed index of $\text{id}_{\text{GT}(\mathbf{1})}$, we obtain a sijection

$$\begin{aligned}
\coprod_{\mathbf{l} \in \underline{[a_1, b_1]} \times \underline{[a_2, b_2]} \times \cdots \times \underline{[a_n, b_n]}} \text{GT}(\mathbf{1}) &\overset{\circ}{\cong} \coprod_{\mathbf{l} \in \coprod_{\mathbf{m} \in S_1 \times S_2 \times \cdots \times S_n} \underline{[m_1, m_2]} \times \underline{[m_2, m_3]} \times \cdots \times \underline{[m_{n-1}, m_n]} \times \underline{[m_n, x]}} \text{GT}(\mathbf{1}) \\
&= \coprod_{\mathbf{m} \in S_1 \times S_2 \times \cdots \times S_n} \left(\coprod_{\mathbf{l} \in \underline{[m_1, m_2]} \times \underline{[m_2, m_3]} \times \cdots \times \underline{[m_{n-1}, m_n]} \times \underline{[m_n, x]}} \text{GT}(\mathbf{1}) \right) \\
&= \coprod_{\mathbf{m} \in S_1 \times S_2 \times \cdots \times S_n} \text{GT}(\mathbf{m}, x),
\end{aligned}$$

which completes the construction. \square

Construction 4.3 (Problem 5 in [7]). We construct the following sijections:

1. for any $\mathbf{k} = (k_1, k_2, \dots, k_n) \in \mathbb{Z}^n$ and $i \in \{1, 2, \dots, n-1\}$,

$$\pi = \pi_{\mathbf{k}, i}: \text{GT}(k_1, k_2, \dots, k_n) \overset{\circ}{\cong} -\text{GT}(k_1, k_2, \dots, k_{i-1}, k_{i+1}, k_i, k_{i+2}, \dots, k_n),$$

2. for any $\mathbf{a} = (a_1, a_2, \dots, a_n), \mathbf{b} = (b_1, b_2, \dots, b_n) \in \mathbb{Z}^n$ satisfying $a_i = b_i$ and $a_{i+1} = b_{i+1}$ for some $i \in \{1, 2, \dots, n-1\}$,

$$\sigma = \sigma_{\mathbf{a}, \mathbf{b}, i}: \coprod_{\mathbf{l} \in \underline{[a_1, b_1]} \times \underline{[a_2, b_2]} \times \cdots \times \underline{[a_n, b_n]}} \text{GT}(\mathbf{1}) \overset{\circ}{\cong} (\emptyset, \emptyset).$$

The construction is by induction on n . For an $n \geq 1$, if we have π_n then we construct σ_n by

$$\begin{aligned}
&\coprod_{\mathbf{l} \in \underline{[a_1, b_1]} \times \underline{[a_2, b_2]} \times \cdots \times \underline{[a_n, b_n]}} \text{GT}(\mathbf{1}) \\
&= \coprod_{\substack{\mathbf{l} \in \underline{[a_1, b_1]} \times \underline{[a_2, b_2]} \times \cdots \times \underline{[a_n, b_n]} \\ \text{s.t. } l_i < l_{i+1}}} \text{GT}(\mathbf{1}) \sqcup \coprod_{\substack{\mathbf{l} \in \underline{[a_1, b_1]} \times \underline{[a_2, b_2]} \times \cdots \times \underline{[a_n, b_n]} \\ \text{s.t. } l_i > l_{i+1}}} \text{GT}(\mathbf{1}) \\
&\overset{\pi}{\cong} \coprod_{\substack{\mathbf{l} \in \underline{[a_1, b_1]} \times \underline{[a_2, b_2]} \times \cdots \times \underline{[a_n, b_n]} \\ \text{s.t. } l_i < l_{i+1}}} \text{GT}(\mathbf{1}) \sqcup \coprod_{\substack{\mathbf{l} \in \underline{[a_1, b_1]} \times \underline{[a_2, b_2]} \times \cdots \times \underline{[a_n, b_n]} \\ \text{s.t. } l_i < l_{i+1}}} -\text{GT}(\mathbf{1}) \\
&= \coprod_{\substack{\mathbf{l} \in \underline{[a_1, b_1]} \times \underline{[a_2, b_2]} \times \cdots \times \underline{[a_n, b_n]} \\ \text{s.t. } l_i < l_{i+1}}} (\text{GT}(\mathbf{1}) \sqcup -\text{GT}(\mathbf{1})) \\
&\overset{\text{E. 2.3}}{\cong} (\emptyset, \emptyset),
\end{aligned}$$

where E. 2.3 stands for Example 2.3. Note that when $l_i = l_{i+1}$, $\text{GT}(\mathbf{1}) = (\emptyset, \emptyset)$.

Next, we construct π_n from σ_{n-1} . (Note that when $n = 1$ there is nothing to prove.) For $x_1, x_2, x_3, x_4 \in \mathbb{Z}$, we have sijections compatible with the normal statistics

$$\begin{aligned}
\underline{[x_1, x_2]} \times \underline{[x_2, x_3]} &\overset{\circ}{\cong} -\underline{[x_2, x_1]} \times (\underline{[x_2, x_1]} \sqcup \underline{[x_1, x_3]}) \\
&\overset{\circ}{\cong} -\underline{[x_2, x_1]} \times \underline{[x_2, x_1]} \sqcup -\underline{[x_2, x_1]} \times \underline{[x_1, x_3]}
\end{aligned}$$

and

$$\begin{aligned}
\underline{[x_1, x_2]} \times \underline{[x_2, x_3]} \times \underline{[x_3, x_4]} &\xrightarrow{\cong} (\underline{[x_1, x_3]} \sqcup \underline{[x_3, x_2]}) \times \underline{[x_3, x_2]} \times (\underline{[x_3, x_2]} \sqcup \underline{[x_2, x_4]}) \\
&\xrightarrow{\cong} -\underline{[x_1, x_3]} \times \underline{[x_3, x_2]} \times \underline{[x_3, x_2]} \sqcup -\underline{[x_1, x_3]} \times \underline{[x_3, x_2]} \times \underline{[x_2, x_4]} \\
&\quad \sqcup -\underline{[x_3, x_2]} \times \underline{[x_3, x_2]} \times \underline{[x_3, x_2]} \sqcup -\underline{[x_3, x_2]} \times \underline{[x_3, x_2]} \times \underline{[x_2, x_4]}.
\end{aligned}$$

From these sijections and σ_{n-1} we can construct π_n . For example, when $n = 5$ and $i = 3$, we have

$$\begin{aligned}
\text{GT}(\mathbf{1}) &= \bigsqcup_{\mathbf{m} \in \underline{[l_1, l_2]} \times \underline{[l_2, l_3]} \times \underline{[l_3, l_4]} \times \underline{[l_4, l_5]}} \text{GT}(\mathbf{m}) \\
&\xrightarrow{\cong} \bigsqcup_{\mathbf{m} \in -\underline{[l_1, l_2]} \times \underline{[l_2, l_4]} \times \underline{[l_4, l_3]} \times \underline{[l_4, l_3]}} \text{GT}(\mathbf{m}) \sqcup \bigsqcup_{\mathbf{m} \in -\underline{[l_1, l_2]} \times \underline{[l_2, l_4]} \times \underline{[l_4, l_3]} \times \underline{[l_3, l_5]}} \text{GT}(\mathbf{m}) \\
&\quad \sqcup \bigsqcup_{\mathbf{m} \in -\underline{[l_1, l_2]} \times \underline{[l_4, l_3]} \times \underline{[l_4, l_3]} \times \underline{[l_4, l_3]}} \text{GT}(\mathbf{m}) \sqcup \bigsqcup_{\mathbf{m} \in -\underline{[l_1, l_2]} \times \underline{[l_4, l_3]} \times \underline{[l_4, l_3]} \times \underline{[l_3, l_5]}} \text{GT}(\mathbf{m}) \\
&\xrightarrow{\sigma} (\emptyset, \emptyset) \sqcup - \bigsqcup_{\mathbf{m} \in \underline{[l_1, l_2]} \times \underline{[l_2, l_4]} \times \underline{[l_4, l_3]} \times \underline{[l_3, l_5]}} \text{GT}(\mathbf{m}) \sqcup (\emptyset, \emptyset) \sqcup (\emptyset, \emptyset) \\
&= - \bigsqcup_{\mathbf{m} \in \underline{[l_1, l_2]} \times \underline{[l_2, l_4]} \times \underline{[l_4, l_3]} \times \underline{[l_3, l_5]}} \text{GT}(\mathbf{m}) = -\text{GT}(l_1, l_2, l_4, l_3, l_5),
\end{aligned}$$

which completes the construction. \square

Construction 4.4 (Problem 6 in [7]). Let $\mathbf{k} = (k_1, k_2, \dots, k_n) \in \mathbb{Z}^n$ and $x \in \mathbb{Z}$. We construct a sijection

$$\tau = \tau_{\mathbf{k}, x}: \text{GT}(k_1, k_2, \dots, k_n) \xrightarrow{\cong} \bigsqcup_{i=1}^n \text{GT}(k_1, k_2, \dots, k_{i-1}, x, k_{i+1}, \dots, k_n).$$

When $n = 1$, it is trivial. In the following we assume that $n \geq 2$. First, we construct the following sijection.

Subconstruction 4.4.1 (Problem 3. in [7]). We construct a sijection compatible with the normal statistic

$$\begin{aligned}
\gamma = \gamma_{\mathbf{k}, x}: &\underline{[k_1, k_2]} \times \underline{[k_2, k_3]} \times \cdots \times \underline{[k_{n-1}, k_n]} \\
&\xrightarrow{\cong} \bigsqcup_{i=1}^n \underline{[k_1, k_2]} \times \underline{[k_2, k_3]} \times \cdots \times \underline{[k_{i-2}, k_{i-1}]} \times \underline{[k_{i-1}, x]} \times \underline{[x, k_{i+1}]} \times \cdots \times \underline{[k_{n-1}, k_n]} \\
&\quad \sqcup \bigsqcup_{i=1}^{n-2} \underline{[k_1, k_2]} \times \cdots \times \underline{[k_{i-1}, k_i]} \times \underline{[k_{i+1}, x]} \times \underline{[k_{i+1}, x]} \times \underline{[k_{i+2}, k_{i+3}]} \times \cdots \times \underline{[k_{n-1}, k_n]},
\end{aligned}$$

where we replaced k_i with x in the first term and $\underline{[k_i, k_{i+1}]}$ and $\underline{[k_{i+1}, k_{i+2}]}$ with $\underline{[k_{i+1}, x]}$ in the second term. The construction is by induction on n . If $n = 2$, it coincides with Example 2.2. For

$n > 2$, we have

$$\begin{aligned}
& \bigsqcup_{i=1}^n \underline{[k_1, k_2]} \times \underline{[k_2, k_3]} \times \cdots \times \underline{[k_{i-2}, k_{i-1}]} \times \underline{[k_{i-1}, x]} \times \underline{[x, k_{i+1}]} \times \cdots \times \underline{[k_{n-1}, k_n]} \\
& \sqcup - \left(\bigsqcup_{i=1}^{n-1} \underline{[k_1, k_2]} \times \underline{[k_2, k_3]} \times \cdots \times \underline{[k_{i-2}, k_{i-1}]} \times \underline{[k_{i-1}, x]} \times \underline{[x, k_{i+1}]} \times \cdots \times \underline{[k_{n-2}, k_{n-1}]} \right) \times \underline{[k_{n-1}, k_n]} \\
& \rightsquigarrow \left(\prod_{i=1}^{n-3} \underline{[k_i, k_{i+1}]} \right) \times \left(\underline{[k_{n-2}, x]} \times \underline{[x, k_n]} \sqcup \underline{[k_{n-2}, k_{n-1}]} \times \underline{[k_{n-1}, x]} \sqcup - \underline{[k_{n-2}, x]} \times \underline{[k_{n-1}, k_n]} \right)
\end{aligned}$$

and

$$\begin{aligned}
& \bigsqcup_{i=1}^{n-2} \underline{[k_1, k_2]} \times \cdots \times \underline{[k_{i-1}, k_i]} \times \underline{[k_{i+1}, x]} \times \underline{[k_{i+1}, x]} \times \underline{[k_{i+2}, k_{i+3}]} \times \cdots \times \underline{[k_{n-1}, k_n]} \\
& \sqcup - \left(\bigsqcup_{i=1}^{n-3} \underline{[k_1, k_2]} \times \cdots \times \underline{[k_{i-1}, k_i]} \times \underline{[k_{i+1}, x]} \times \underline{[k_{i+1}, x]} \times \underline{[k_{i+2}, k_{i+3}]} \times \cdots \times \underline{[k_{n-2}, k_{n-1}]} \right) \times \underline{[k_{n-1}, k_n]} \\
& \rightsquigarrow \left(\prod_{i=1}^{n-3} \underline{[k_i, k_{i+1}]} \right) \times \underline{[k_{n-1}, x]} \times \underline{[k_{n-1}, x]}.
\end{aligned}$$

Therefore the following completes the construction of γ :

$$\begin{aligned}
& \underline{[k_{n-2}, x]} \times \underline{[x, k_n]} \sqcup \underline{[k_{n-2}, k_{n-1}]} \times \underline{[k_{n-1}, x]} \sqcup \underline{[k_{n-1}, x]} \times \underline{[k_{n-1}, x]} \\
& \rightsquigarrow \underline{[k_{n-2}, x]} \times \underline{[x, k_n]} \sqcup \underline{[k_{n-2}, x]} \times \underline{[k_{n-1}, x]} \rightsquigarrow \underline{[k_{n-2}, x]} \times \underline{[k_{n-1}, k_n]}. \quad \square
\end{aligned}$$

We return to the construction of τ . By using Example 2.12, the sijection γ and the sijection σ constructed in Construction 4.3, we have

$$\begin{aligned}
\text{GT}(\mathbf{k}) &= \bigsqcup_{\mathbf{l} \in \underline{[k_1, k_2]} \times \cdots \times \underline{[k_{n-1}, k_n]}} \text{GT}(\mathbf{l}) \\
&\rightsquigarrow \bigsqcup_{\mathbf{l} \in \bigsqcup_{i=1}^n \underline{[k_1, k_2]} \times \underline{[k_2, k_3]} \times \cdots \times \underline{[k_{i-2}, k_{i-1}]} \times \underline{[k_{i-1}, x]} \times \underline{[x, k_{i+1}]} \times \cdots \times \underline{[k_{n-1}, k_n]}} \text{GT}(\mathbf{l}) \\
&\quad \sqcup \bigsqcup_{\mathbf{l} \in \bigsqcup_{i=1}^{n-2} \underline{[k_1, k_2]} \times \cdots \times \underline{[k_{i-1}, k_i]} \times \underline{[k_{i+1}, x]} \times \underline{[k_{i+1}, x]} \times \underline{[k_{i+2}, k_{i+3}]} \times \cdots \times \underline{[k_{n-1}, k_n]}} \text{GT}(\mathbf{l}) \\
&\rightsquigarrow \bigsqcup_{i=1}^n \text{GT}(k_1, k_2, \dots, k_{i-1}, x, k_{i+1}, \dots, k_n) \sqcup (\emptyset, \emptyset) \\
&= \bigsqcup_{i=1}^n \text{GT}(k_1, k_2, \dots, k_{i-1}, x, k_{i+1}, \dots, k_n).
\end{aligned}$$

The construction is thus completed. \square

4.3 New compatibility properties

We define a statistic η_{row} of Gelfand-Tsetlin patterns. First, we define a set of multisets

$$\text{MS}(\mathbb{Z}, n) = \{ \{ \{ k_1, k_2, \dots, k_n \} \mid k_1 \leq k_2 \leq \dots \leq k_n \} \simeq \mathbb{Z}^n / \mathfrak{S}_n,$$

where we use double braces to describe a multiset. We define \mathcal{A}_{row} by

$$\mathcal{A}_{\text{row}} = \bigcup_{i=1}^{\infty} \mathcal{A}_{\text{row}}^i, \quad \mathcal{A}_{\text{row}}^i = \text{MS}(\mathbb{Z}, 1) \times \text{MS}(\mathbb{Z}, 2) \times \dots \times \text{MS}(\mathbb{Z}, i).$$

Then, we define η_{row} as follows.

- For $k \in \text{GT}(k)$, $\eta_{\text{row}}(k) = \{ \{ k \} \} \in \text{MS}(\mathbb{Z}, 1) = \mathcal{A}_{\text{row}}^1$.
- For $T \in \text{GT}(\mathbf{k})$, where $\mathbf{k} \in \mathbb{Z}^n$ and $n \geq 2$, we have $T' \in \text{GT}(\mathbf{1})$ such that $T = (T', \mathbf{k})$, where $\mathbf{1}$ is the second bottom row of T . Then, we define

$$\eta_{\text{row}}(T) = (\eta_{\text{row}}(T'), \{ \{ k_1, k_2, \dots, k_n \} \}) \in \mathcal{A}_{\text{row}}^{n-1} \times \text{MS}(\mathbb{Z}, n) = \mathcal{A}_{\text{row}}^n.$$

For example,

$$\eta_{\text{row}} \left(\begin{array}{ccc} & & 4 \\ & 2 & 5 \\ 2 & & 7 \end{array} \right) = (\{ \{ 4 \} \}, \{ \{ 2, 5 \} \}, \{ \{ 2, 5, 7 \} \}).$$

The following theorem is the main result of this section.

Theorem 4.5. *The sijections π and σ in Construction 4.3 are compatible with the statistic η_{row} .*

Proof. The proof is by tracing the constructions. First, the compatibility of σ follows from the compatibility of π . Next, the compatibility of π follows from the compatibility of σ without the bottom row. The sijection π acts on the bottom row as swapping an element with the next element, so it does not affect the value of η_{row} . Therefore, π and σ are compatible with the statistic η_{row} . \square

The theorem means that the sijection π acts on $\text{GT}(\mathbf{k})$ as a permutation of elements in each row. This result is one of the most important reasons why we use half-open intervals to describe signed intervals and Gelfand-Tsetlin patterns. Based on the theorem, we can decompose the equinumerous relation of Gelfand-Tsetlin patterns by using the statistic η_{row} . Namely, we have

$$\text{GT}(k_1, k_2, \dots, k_n) \Big|_{\eta_{\text{row}}=A} \overset{\circ}{\cong} -\text{GT}(k_1, k_2, \dots, k_{i-1}, k_{i+1}, k_i, k_{i+2}, \dots, k_n) \Big|_{\eta_{\text{row}}=A}$$

from the compatibility with η_{row} of the sijection π . When \mathbf{l} is a permutation of \mathbf{k} , we have $\#\text{GT}(\mathbf{k}) \Big|_{\eta_{\text{row}}=A} = \text{sgn } s \cdot \#\text{GT}(\mathbf{l}) \Big|_{\eta_{\text{row}}=A}$, where s is a permutation of $\{1, 2, \dots, n\}$ such that $l_i = k_{s(i)}$ and $\text{sgn } s$ means the sign of s . Let $(a_{i,j})_{1 \leq j \leq i \leq n}$ be the elements of A as

$$A = (\{ \{ a_{1,1} \} \}, \{ \{ a_{2,1}, a_{2,2} \} \}, \dots, \{ \{ a_{n,1}, a_{n,2}, \dots, a_{n,n} \} \}), \quad a_{i,j} \leq a_{i,j+1} (\forall 1 \leq j < i \leq n),$$

and let $\mathbf{a} = (a_{n,1}, a_{n,2}, \dots, a_{n,n})$. When $(a_{i,j})_{ij}$ form a classical Gelfand-Tsetlin pattern, namely when for any $1 \leq j \leq i \leq n-1$, $a_{i+1,j} \leq a_{i,j} < a_{i+1,j+1}$ holds, we have $\#\text{GT}(\mathbf{a}) \Big|_{\eta_{\text{row}}=A} = 1$. Therefore, we have $\#\text{GT}(\tilde{\mathbf{a}}) \Big|_{\eta_{\text{row}}=A} = \text{sgn } s$, where $s \in \mathfrak{S}_n$ and $\tilde{\mathbf{a}}_i = \mathbf{a}_{s(i)}$. Otherwise, when $(a_{i,j})_{ij}$ do not form a classical Gelfand-Tsetlin pattern, $\#\text{GT}(\tilde{\mathbf{a}}) \Big|_{\eta_{\text{row}}=A} = 0$ for any $\tilde{\mathbf{a}} \in \mathbb{Z}^n$. To describe what occurs in this situation, we need some new notions.

Definition 4.6. A system of combinatorial objects consists of

- a set $\{A_\lambda\}_{\lambda \in \Lambda}$ of combinatorial objects,
- a set $\{\varphi_\mu\}_{\mu \in M}$ of sijections between combinatorial objects,
- a source function $s: M \rightarrow \Lambda$ and a target function $t: M \rightarrow \Lambda$ such that $\varphi_\mu: A_{s(\mu)} \overset{\circ}{\rightrightarrows} A_{t(\mu)}$ holds for any $\mu \in M$.

We define an *integrability condition* for a pair of combinatorial objects $(A_\lambda, A_{\lambda'})$ as follows:

There exists a path of sijections from A_λ to $A_{\lambda'}$, namely $(\mu_1, \mu_2, \dots, \mu_k) \in M^k$ such that $s(\mu_1) = \lambda$, $t(\mu_i) = s(\mu_{i+1})$ for any $1 \leq i \leq k-1$ and $t(\mu_k) = \lambda'$. In addition, the composition $\varphi_{\mu_k} \circ \varphi_{\mu_{k-1}} \circ \dots \circ \varphi_{\mu_1}$ is independent to the choice of the path.

When any pair of combinatorial objects meets the integrability condition, we say the system is *integrable*. In addition, when any pair $(A_\lambda, A_{\lambda'})$ of combinatorial objects such that $A_\lambda^- = A_{\lambda'}^- = \emptyset$ meets the integrability condition, we say the system is *partially integrable*.

The following lemma is useful to prove a system is partially integrable.

Lemma 4.7. Let $(\{A_\lambda\}_{\lambda \in \Lambda}, \{\varphi_\mu\}_{\mu \in M}, s, t)$ be a system of combinatorial objects. When the system is strongly connected, namely for any pair $(\lambda, \lambda') \in \Lambda^2$ there exists a path of sijection from A_λ to $A_{\lambda'}$, the system is partially integrable if and only if it meets the following condition:

There exists $\lambda \in \Lambda$ such that $A_\lambda^- = \emptyset$ and (A_λ, A_λ) meets the integrability condition.

Proof. (\Rightarrow) trivial. (\Leftarrow) Let $\lambda_1, \lambda_2 \in \Lambda$ such that $A_{\lambda_1}^- = A_{\lambda_2}^- = \emptyset$. Since the system is strongly connected, there is a path of sijection from A_{λ_1} to A_{λ_2} . Let $\psi, \tilde{\psi}$ be compositions of sijections from A_{λ_1} to A_{λ_2} along two different paths. Since $A_{\lambda_1}^- = A_{\lambda_2}^- = \emptyset$, they are ordinary bijections. Similarly, we can take sijections $\varphi_1: A_\lambda \overset{\circ}{\rightrightarrows} A_{\lambda_1}$, $\varphi_2: A_\lambda \overset{\circ}{\rightrightarrows} A_{\lambda_2}$ in the system and they are also bijections. From the integrability condition for (A_λ, A_λ) , we have $\varphi_2 \circ \psi \circ \varphi_1^{-1} = \varphi_2 \circ \tilde{\psi} \circ \varphi_1^{-1}$, namely $\psi = \tilde{\psi}$. Since this means that $(A_{\lambda_1}, A_{\lambda_2})$ meets the integrability condition, the system is partially integrable. \square

In bijective (as well as in *surjective*) combinatorics, our goal is to construct larger (partially) integrable systems of combinatorial objects. In this sense, to construct a compatible sijection is a weak goal. For a strongly connected system $(\{A_\lambda\}_{\lambda \in \Lambda}, \{\varphi_\mu\}_{\mu \in M}, s, t)$ and a statistic η on $\bigsqcup_{\lambda \in \Lambda} \text{supp}(A_\lambda)$, we say the system is compatible with η when each φ_μ is compatible with η . If the statistic η is injective on $\text{supp}(A_\lambda)$ (note that this requires $A_\lambda^- = \emptyset$), according to the lemma, the system is partially integrable.

For instance, in the case of Gelfand-Tsetlin patterns the system with $\mathbf{k} \in \mathbb{Z}^n$ is described as

- a set of combinatorial objects: $\{\text{GT}(\mathbf{l}) \mid \mathbf{l} \text{ is a permutation of } \mathbf{k}\}$,
- a set of sijections: $\{\pi_{\mathbf{l}, i} \mid \mathbf{l} \text{ is a permutation of } \mathbf{k} \text{ and } i \in \{1, 2, \dots, n\}\}$.

Then the system is compatible with η_{row} . Since η_{row} is injective on $\text{supp}(\text{GT}(\mathbf{k}))$ when \mathbf{k} is increasing, the system is partially integrable. Therefore, the above discussion results in the following corollary.

Corollary 4.8. Let $\mathbf{k} \in \mathbb{Z}^n$ and $\mathfrak{S}\mathbf{k} = \{\mathbf{l} \mid \mathbf{l} \text{ is a permutation of } \mathbf{k}\}$. Then, $\{GT(\mathbf{l})\}_{\mathbf{l} \in \mathfrak{S}\mathbf{k}}$ and $\{\pi_{\mathbf{l},i}\}_{\mathbf{l} \in \mathfrak{S}\mathbf{k}, i \in \{1,2,\dots,n\}}$ form a partially integrable system of combinatorial objects.

Remark. In this remark, we explain why the definition of “partially integrable” is needed, or in other words why “integrable” is too strict. For this purpose, we give an example of a partially integrable system of combinatorial objects which is not integrable. Let $\varphi: S \twoheadrightarrow T$ be the sijection constructed in the remark of Section 2.2.2. We consider the system described as

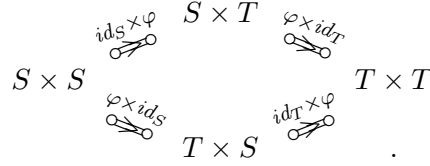

Here, when we define a system by a diagram as above, if the diagram includes $\psi: U \twoheadrightarrow V$ then the system includes not only $\psi: U \twoheadrightarrow V$ but also $\psi^{-1}: V \twoheadrightarrow U$. We showed that $(id_T \times \varphi) \circ (\varphi \times id_S) \neq (\varphi \times id_T) \circ (id_S \times \varphi)$ in the remark. Therefore, the system is not integrable. However, by Lemma 4.7, this system is partially integrable because of $\#(S \times S)^+ = 1$ and $\#(S \times S)^- = 0$.

This example is very simple and a similar situation occurs in general when we take the Cartesian product of two or more sijection that have some cancellations. Therefore, there are no integrable systems that do not involve at least some trivial cases.

Last, we give a new partially computational proof of the signed enumeration of the Gelfand-Tsetlin patterns, inspired by the results of this section. The enumeration for a strictly increasing $\mathbf{k} \in \mathbb{Z}^n$ is known to be (for example, see [12])

$$\#GT(\mathbf{k}) = \prod_{1 \leq i < j \leq n} \frac{k_j - k_i}{j - i},$$

and we prove that the result is true for general cases in a computational way. Note that the combinatorial proof of this equation follows from the sijection $GT(\mathbf{k}') \twoheadrightarrow GT(\mathbf{k})$, where $\mathbf{k} \in \mathbb{Z}^n$ is arbitrary and \mathbf{k}' is a weakly increasing sequence such that $\{\{\mathbf{k}\}\} = \{\{\mathbf{k}'\}\}$. Before explaining our proof, let us prepare one definition. For $\mathbf{k} \in \mathbb{Z}^n$, we define $\text{sgn}(\mathbf{k})$ as the sign of a permutation $s \in \mathfrak{S}_n$ such that $k_{s(1)} < k_{s(2)} < \dots < k_{s(n)}$ when all elements of \mathbf{k} are distinct. Otherwise, we define $\text{sgn}(\mathbf{k}) = 0$.

Proposition 4.9. Let $\mathbf{k} \in \mathbb{Z}^n$ and let A be an element of \mathcal{A}_{row}^n such that $\{\{\mathbf{k}\}\} = A_n \in MS(\mathbb{Z}, n)$. Then, we have

$$\#GT(\mathbf{k}) \Big|_{\eta_{row}=A} = \begin{cases} \text{sgn}(\mathbf{k}) & \text{when } A \text{ forms a classical Gelfand-Tsetlin pattern,} \\ 0 & \text{otherwise.} \end{cases}$$

In particular,

$$\#GT(\mathbf{k}) = \text{sgn}(\mathbf{k}) \cdot \#GT(\mathbf{k}') = \prod_{1 \leq i < j \leq n} \frac{k_j - k_i}{j - i},$$

where \mathbf{k}' is an increasing sequence such that $\{\{\mathbf{k}\}\} = \{\{\mathbf{k}'\}\}$.

Computational proof of Proposition 4.9. The proof is given by induction on n . For $n = 1$, this is trivial. For $n > 1$, let $A' \in \mathcal{A}_{\text{row}}^{n-1}$ such that $A = (A', \{\{\mathbf{k}\}\})$. Then, we have

$$\#GT(\mathbf{k}) \big|_{\eta_{\text{row}}=A} = \sum_{\mathbf{l} \in \underline{[k_1, k_2]} \times \underline{[k_2, k_3]} \times \cdots \times \underline{[k_{n-1}, k_n]}} \#GT(\mathbf{l}) \big|_{\eta_{\text{row}}=A'}.$$

Let $a_1 \leq a_2 \leq \cdots \leq a_{n-1}$ be the elements of A_{n-1} . If they are not distinct, A' does not form a classical Gelfand-Tsetlin pattern and neither does A . Therefore, in this case we obtain the result that $\#GT(\mathbf{k}) \big|_{\eta_{\text{row}}=A} = 0$. In the following, we assume that $a_1 < a_2 < \cdots < a_{n-1}$.

Now, with the assumption of the induction, we have

$$\begin{aligned} \#GT(\mathbf{k}) \big|_{\eta_{\text{row}}=A} &= \sum_{\mathbf{l} \in \underline{[k_1, k_2]} \times \underline{[k_2, k_3]} \times \cdots \times \underline{[k_{n-1}, k_n]}} \#GT(\mathbf{l}) \big|_{\eta_{\text{row}}=A'} \\ &= \sum_{\substack{\mathbf{l} \in \underline{[k_1, k_2]} \times \underline{[k_2, k_3]} \times \cdots \times \underline{[k_{n-1}, k_n]} \\ \text{s.t. } \{\{\mathbf{l}\}\} = A_{n-1}}} \#GT(\mathbf{l}) \big|_{\eta_{\text{row}}=A'} \\ &= \mathbf{1}_{A' \text{ forms a classical Gelfand-Tsetlin pattern}} \\ &\quad \times \sum_{\substack{\mathbf{l} \in \underline{[k_1, k_2]} \times \underline{[k_2, k_3]} \times \cdots \times \underline{[k_{n-1}, k_n]} \\ \text{s.t. } \{\{\mathbf{l}\}\} = A_{n-1}}} \text{sgn}(\mathbf{l}). \end{aligned}$$

For $i \in \{1, 2, \dots, n\}$, let t_i be the integer such that $a_{t_i-1} < k_i \leq a_{t_i}$, where we define $a_0 = -\infty$ and $a_n = +\infty$. Then, it is sufficient to show that

$$\sum_{\substack{\mathbf{l} \in \underline{[k_1, k_2]} \times \underline{[k_2, k_3]} \times \cdots \times \underline{[k_{n-1}, k_n]} \\ \text{s.t. } \{\{\mathbf{l}\}\} = A_{n-1}}} \text{sgn}(\mathbf{l}) = \begin{cases} \text{sgn}(\mathbf{k}) & \text{if } t_1, t_2, \dots, t_n \text{ are distinct,} \\ 0 & \text{otherwise,} \end{cases}$$

because A forms a classical Gelfand-Tsetlin pattern if and only if so does A' and t_1, t_2, \dots, t_n are distinct. Let e_1, e_2, \dots, e_{n-1} be the canonical basis of \mathbb{R}^{n-1} and $f_i = \sum_{j=1}^{i-1} e_j$ for $i \in \{1, 2, \dots, n\}$. Then, we have

$$\sum_{\substack{\mathbf{l} \in \underline{[k_1, k_2]} \times \underline{[k_2, k_3]} \times \cdots \times \underline{[k_{n-1}, k_n]} \\ \text{s.t. } \{\{\mathbf{l}\}\} = A_{n-1}}} \text{sgn}(\mathbf{l}) = \det(f_{t_2} - f_{t_1}, f_{t_3} - f_{t_2}, \dots, f_{t_n} - f_{t_{n-1}}).$$

If $t_i = t_j$ for some $1 \leq i < j \leq n$, then $f_{t_{i+1}} - f_{t_i}, f_{t_{i+2}} - f_{t_{i+1}}, \dots, f_{t_j} - f_{t_{j-1}}$ are not linearly independent. Thus, if t_1, t_2, \dots, t_n are not distinct, the determinant is equal to zero. Otherwise, we consider the anti-symmetric property with respect to (t_1, t_2, \dots, t_n) , which is obtained from the following calculations:

$$\begin{aligned} &\det(\cdots, f_i - f_j, f_j - f_k, f_k - f_l, \cdots) \\ &= \det(\cdots, (f_i - f_j) + (f_j - f_k), f_j - f_k, (f_k - f_l) + (f_j - f_k), \cdots) \\ &= \det(\cdots, f_i - f_k, f_j - f_k, f_j - f_l, \cdots) \\ &= -\det(\cdots, f_i - f_k, f_k - f_j, f_j - f_l, \cdots), \end{aligned}$$

$$\begin{aligned} \det(f_i - f_j, f_j - f_k, \cdots) &= \det(f_i - f_j, (f_i - f_j) + (f_j - f_k), \cdots) \\ &= -\det(f_j - f_i, f_i - f_k, \cdots), \end{aligned}$$

$$\begin{aligned}\det(\cdots, f_i - f_j, f_j - f_k) &= \det(\cdots, (f_i - f_j) + (f_j - f_k), f_j - f_k) \\ &= -\det(\cdots, f_i - f_k, f_k - f_j).\end{aligned}$$

Since $\det(f_2 - f_1, f_3 - f_2, \dots, f_n - f_{n-1}) = 1$, the determinant is equal to the sign of $\mathbf{T} = (t_1, t_2, \dots, t_n)$ and thus to $\text{sgn}(\mathbf{k})$. \square

4.4 Gelfand-Tsetlin Graph sequences

In this subsection, we will define a generalization of Gelfand-Tsetlin patterns and we extend the scope of the results in this section to these objects. The generalization is also a generalization of Gelfand-Tsetlin tree sequences, which is introduced in [5]. In particular, we prove the same claim as Proposition 4.9 for the generalized Gelfand-Tsetlin patterns, which leads us to the notion of ‘‘Gelfand-Tsetlin graph sequences’’, a more generalized version of Gelfand-Tsetlin tree sequences.

Definition 4.10. Let $n \in \mathbb{Z}$ and $\mathbf{k} \in \mathbb{Z}^n$, and for $1 \leq j \leq i \leq n-1$ let $p_{i,j}, q_{i,j}$ be positive integers less than or equal to $i+1$. Then, we define the signed set $\text{GGT}(\mathbf{k}; \{p_{i,j}\}, \{q_{i,j}\})$ of *generalized Gelfand-Tsetlin patterns* with bottom row \mathbf{k} and parameters $\{p_{i,j}\}, \{q_{i,j}\}$ as:

- when $n = 1$, $\text{GGT}(\mathbf{k}; \{p_{i,j}\}, \{q_{i,j}\}) = (\{k\}, \emptyset)$,
- otherwise,

$$\begin{aligned}\text{GGT}(\mathbf{k}; \{p_{i,j}\}, \{q_{i,j}\}) \\ = \bigsqcup_{\mathbf{l} \in \underline{[k_{p_{n-1,1}, k_{q_{n-1,1}}]} \times [k_{p_{n-1,2}, k_{q_{n-1,2}}]} \times \cdots \times [k_{p_{n-1, n-1}, k_{q_{n-1, n-1}}]}} \text{GGT}(\mathbf{l}; \{p_{i,j}\}, \{q_{i,j}\}).\end{aligned}$$

When we set $p_{i,j} = j$ and $q_{i,j} = j+1$ for all $1 \leq i \leq j \leq n-1$, then this definition coincides with the definition of (original) Gelfand-Tsetlin patterns $\text{GT}(\mathbf{k})$. This definition is also a generalization of Gelfand-Tsetlin tree sequences. We consider the graph G_i for $i \in \{1, 2, \dots, n\}$ with vertices $\{1, 2, \dots, i+1\}$ and (named) edges $\{j: p_{i,j} \rightarrow q_{i,j} \mid 1 \leq j \leq i\}$, where $s \rightarrow t$ denotes a directed edge from s to t . When all G_i are trees (note that here the directions of edges do not matter), the definition of the generalized Gelfand-Tsetlin patterns coincides with a signed set of Gelfand-Tsetlin tree sequences with some parameters or its opposite. To explain the relation between them, we define the sign of parameters $\{p_{i,j}\}, \{q_{i,j}\}$.

Definition 4.11. Let $n \in \mathbb{Z}$ and for $1 \leq j \leq i \leq n-1$ and let $p_{i,j}, q_{i,j}$ be positive integers less than or equal to $i+1$. Let G_i be the graph described above. We define the sign of $p_{i,j}, q_{i,j}$ as follows and denote it by $\text{sgn}(\{p_{i,j}\}, \{q_{i,j}\})$:

- when G_i is not a tree for some $i \in \{1, 2, \dots, n-1\}$, the sign is 0.
- otherwise, the sign is $\prod_{i=1}^{n-1} (-1)^{\#\{j \mid 1 \leq j \leq i, p_{i,j} = r_i(j)\}} \cdot \text{sgn}(r_i)$, where r_i is a bijection from $\{0, 1, \dots, i\}$ to $\{1, 2, \dots, i+1\}$ constructed as below and its sign is defined by $\text{sgn}(r_i) = \text{sgn}(r_i - 1)$ (note that $r_i - 1$ is a permutation of $\{0, 1, \dots, i\}$):

We choose $r_i(0) \in \{1, 2, \dots, i+1\}$ arbitrarily. For $j \in \{1, 2, \dots, i\}$, if $p_{i,j}$ is further from $r_i(0)$ than $q_{i,j}$ in G_i with the geodesic distance, let $r_i(j) = p_{i,j}$ and otherwise let $r_i(j) = q_{i,j}$.

In fact, the sign of r_i is independent of the choice of $r_i(0)$. For a proof, see [5].

When the sign is $+1$, the definition of the generalized Gelfand-Tsetlin patterns coincides with the signed set of Gelfand-Tsetlin tree sequences and when the sign is -1 it coincides with the opposite. Conversely, Gelfand-Tsetlin tree sequences are always expressed as generalized Gelfand-Tsetlin patterns with some parameters. The notion of generalized Gelfand-Tsetlin patterns is a true generalization of Gelfand-Tsetlin tree sequences, but we will prove that $\#GGT(\mathbf{k}; \{p_{i,j}\}, \{q_{i,j}\}) = 0$ when some G_i is not a tree (See proposition 4.12).

We define the statistic η_{row} in a similar way for Gelfand-Tsetlin patterns, namely

- for $k \in GGT(k; \emptyset, \emptyset)$, $\eta_{\text{row}}(k) = \{\{k\}\} \in MS(\mathbb{Z}, 1) = \mathcal{A}_{\text{row}}^1$.
- for $T \in GGT(\mathbf{k}; \{p_{i,j}\}, \{q_{i,j}\})$, where $\mathbf{k} \in \mathbb{Z}^n$ and $n \geq 2$, we have $T' \in GGT(\mathbf{l}; \{p_{i,j}\}, \{q_{i,j}\})$ such that $T = (T', \mathbf{k})$, where \mathbf{l} is the second bottom row of T . Then, we define

$$\eta_{\text{row}}(T) = (\eta_{\text{row}}(T'), \{\{k_1, k_2, \dots, k_n\}\}) \in \mathcal{A}_{\text{row}}^{n-1} \times MS(\mathbb{Z}, n) = \mathcal{A}_{\text{row}}^n.$$

Proposition 4.12 (cf. Proposition 4.9). *Let $n \in \mathbb{Z}$ and $\mathbf{k} \in \mathbb{Z}^n$, and for $1 \leq j \leq i \leq n-1$ let $p_{i,j}, q_{i,j}$ be positive integers less than or equal to $i+1$. Moreover, let A be an element of $\mathcal{A}_{\text{row}}^n$ such that $\{\{\mathbf{k}\}\} = A_n \in MS(\mathbb{Z}, n)$. Then, we have*

$$\begin{aligned} \#GGT(\mathbf{k}; \{p_{i,j}\}, \{q_{i,j}\}) \Big|_{\eta_{\text{row}}=A} \\ = \begin{cases} \text{sgn}(\mathbf{k}) \cdot \text{sgn}(\{p_{i,j}\}, \{q_{i,j}\}) & \text{when } A \text{ forms a classical Gelfand-Tsetlin pattern,} \\ 0 & \text{otherwise.} \end{cases} \end{aligned}$$

In particular,

$$\begin{aligned} \#GGT(\mathbf{k}; \{p_{i,j}\}, \{q_{i,j}\}) &= \text{sgn}(\mathbf{k}) \cdot \text{sgn}(\{p_{i,j}\}, \{q_{i,j}\}) \cdot \#GT(\mathbf{k}') \\ &= \text{sgn}(\{p_{i,j}\}, \{q_{i,j}\}) \cdot \prod_{1 \leq i < j \leq n} \frac{k_j - k_i}{j - i}, \end{aligned}$$

where \mathbf{k}' is an increasing sequence such that $\{\{\mathbf{k}\}\} = \{\{\mathbf{k}'\}\}$.

Proof. When all G_i are trees, the proof is almost the same as the proof of Proposition 4.9 and it is sufficient to show that for $n \geq 2$

$$\begin{aligned} \sum_{\mathbf{l} \in \underline{[k_{p_{n-1,1}}, k_{q_{n-1,1}}]} \times \underline{[k_{p_{n-1,2}}, k_{q_{n-1,2}}]} \times \dots \times \underline{[k_{p_{n-1,n-1}}, k_{q_{n-1,n-1}}]} \text{ s.t. } \{\{\mathbf{l}\}\} = A_{n-1}} \text{sgn}(\mathbf{l}) \\ = \begin{cases} \text{sgn}(\mathbf{k}) \cdot \frac{\text{sgn}(\{p_{i,j}\}_{1 \leq j \leq i \leq n-1}, \{q_{i,j}\}_{1 \leq j \leq i \leq n-1})}{\text{sgn}(\{p_{i,j}\}_{1 \leq j \leq i \leq n-2}, \{q_{i,j}\}_{1 \leq j \leq i \leq n-2})} & \text{if } t_1, t_2, \dots, t_n \text{ are distinct,} \\ 0 & \text{otherwise,} \end{cases} \quad (\dagger) \end{aligned}$$

instead of

$$\sum_{\mathbf{l} \in \underline{[k_1, k_2]} \times \underline{[k_2, k_3]} \times \dots \times \underline{[k_{n-1}, k_n]} \text{ s.t. } \{\{\mathbf{l}\}\} = A_{n-1}} \text{sgn}(\mathbf{l}) = \begin{cases} \text{sgn}(\mathbf{k}) & \text{if } t_1, t_2, \dots, t_n \text{ are distinct,} \\ 0 & \text{otherwise.} \end{cases}$$

(For the definition of the invariants, see the proof of Proposition 4.9.) Here, the LHS is equal to

$$\begin{aligned} & \det \left(f_{t_{q_{n-1,1}}} - f_{t_{p_{n-1,1}}}, f_{t_{q_{n-1,2}}} - f_{t_{p_{n-1,2}}}, \dots, f_{t_{q_{n-1,n-1}}} - f_{t_{p_{n-1,n-1}}} \right) \\ &= (-1)^{\#\{j|1 \leq j \leq n-1, p_{n-1,j}=r(j)\}} \cdot \det \left(f_{t_{r(1)}}, f_{t_{r(2)}}, \dots, f_{t_{r(n-1)}} \right) \\ &= (-1)^{\#\{i|1 \leq i \leq n-1, p_{n-1,j}=r(j)\}} \cdot \operatorname{sgn}(\mathbf{T}) \cdot \operatorname{sgn}(r), \end{aligned}$$

where $r = r_{n-1}$ is the bijection defined in Definition 4.11 with $r(0) = 1$. Note that we defined $\operatorname{sgn}(\mathbf{T}) = 0$ when \mathbf{T} has duplicates. It immediately implies (†) by the definition of the sign of parameters.

When some G_i is not a tree, let i be the minimum such index. When $i < n-1$, by the induction, the statement becomes trivial because it holds that $\#GGT(\mathbf{l}; \{p_{i,j}\}_{1 \leq j \leq i \leq n-2}, \{q_{i,j}\}_{1 \leq j \leq i \leq n-2}) = 0$ independent of \mathbf{l} . Otherwise, it is sufficient to show that the determinant

$$\det \left(f_{t_{q_{n-1,1}}} - f_{t_{p_{n-1,1}}}, f_{t_{q_{n-1,2}}} - f_{t_{p_{n-1,2}}}, \dots, f_{t_{q_{n-1,n-1}}} - f_{t_{p_{n-1,n-1}}} \right)$$

is equal to 0. Now, G_{n-1} has n vertices and $n-1$ edges but it is not a tree. Therefore, G_{n-1} has at least one cycle. (Here, we forget the direction of the edges.) When the edges j_1, j_2, \dots, j_ℓ form a cycle, then $f_{t_{q_{n-1,j_1}}} - f_{t_{p_{n-1,j_1}}}, f_{t_{q_{n-1,j_2}}} - f_{t_{p_{n-1,j_2}}}, \dots, f_{t_{q_{n-1,j_\ell}}} - f_{t_{p_{n-1,j_\ell}}}$ are not linearly independent, which implies that the determinant is 0. \square

This proposition is an answer to Fischer's question relevant to the notion of *Gelfand-Tsetlin Graph sequences* in [5]:

“ we want to mention an obvious generalization of Gelfand-Tsetlin tree sequences, which we do not consider in this article, but might be interesting to look at: the notion of admissibility makes perfect sense if the tree T is replaced by any other graph. Are there any nice assertions to be made on “Gelfand-Tsetlin graph sequences”? ”

We can also interpret the proposition via the notions of signed sets, sijections and compatibility. This interpretation results in the following corollary.

Corollary 4.13. *Let $n, \mathbf{k}, \{p_{i,j}\}, \{q_{i,j}\}$ and A be the parameters defined in the above proposition. Then, there exists a sijection between $GGT(\mathbf{k}; \{p_{i,j}\}, \{q_{i,j}\})|_{\eta_{\text{row}}=A}$ and a signed set S that is compatible with η_{row} , where*

$$S = \begin{cases} (\emptyset, \emptyset) & \text{when } \operatorname{sgn}(\{p_{i,j}\}, \{q_{i,j}\}) = 0, \\ GT(\mathbf{k})|_{\eta_{\text{row}}=A} & \text{when } \operatorname{sgn}(\{p_{i,j}\}, \{q_{i,j}\}) = +1, \\ -GT(\mathbf{k})|_{\eta_{\text{row}}=A} & \text{when } \operatorname{sgn}(\{p_{i,j}\}, \{q_{i,j}\}) = -1. \end{cases}$$

This corollary states only the existence of such sijections. It should be possible to construct them explicitly by generalizing the constructions in this section with the combinatorial operations illustrated in [5].

4.5 Preparation for Section 5

For use in Section 5 we check the compatibilities of the sijections constructed in the present section. First, we define statistics $\eta_{\text{row},i}$ on Gelfand-Tsetlin patterns with the length of the bottom row $\geq i$ as $\eta_{\text{row},i} = (\eta_{\text{row}})_i$. Moreover, we define a \mathbb{Z} -valued statistic η_{top} of Gelfand-Tsetlin patterns as $\eta_{\text{top}} = (\eta_{\text{row},1})_1$.

For example,

$$\eta_{\text{row},1} \left(\begin{array}{cccc} & & 4 & \\ & 2 & & 5 \\ 2 & & 5 & 7 \end{array} \right) = \{4\}, \quad \eta_{\text{row},3} \left(\begin{array}{cccc} & & 4 & \\ & 2 & & 5 \\ 2 & & 5 & 7 \end{array} \right) = \{2, 5, 7\},$$

and

$$\eta_{\text{top}} \left(\begin{array}{cccc} & & 4 & \\ & 2 & & 5 \\ 2 & & 5 & 7 \end{array} \right) = 4.$$

In addition, we define η_{top} for a signed set which is in the form of $\bigsqcup_{s \in S} \text{GT}(\mathbf{k}_s)$ by

$$\text{for } (T, s) \in \bigsqcup_{s \in S} \text{GT}(\mathbf{k}_s), \quad \eta_{\text{top}}((T, s)) = \eta_{\text{top}}(T).$$

For $\eta_{\text{row},i}$, we define these values on such signed sets similarly. Note that these definitions are compatible with that for Gelfand-Tsetlin patterns and the relation $\text{GT}(\mathbf{k}) = \bigsqcup_{\mathbf{l} \in \underline{[k_1, k_2]} \times \cdots \times \underline{[k_{n-1}, k_n]}} \text{GT}(\mathbf{l})$.

Proposition 4.14. *The sijection ρ in Construction 4.2 is compatible with η_{top} , $\eta_{\text{row},1}$, $\eta_{\text{row},2}$, \dots , $\eta_{\text{row},n}$.*

Proof. The sijection is constructed as a disjoint union of $\text{id}_{\text{GT}(\mathbf{l})}$. Therefore, the top n rows are preserved under ρ . In particular, ρ is compatible with the statistics. \square

Proposition 4.15. *The sijections π , σ in Construction 4.3 are compatible with η_{top} , $\eta_{\text{row},1}$, $\eta_{\text{row},2}$, \dots , $\eta_{\text{row},n}$.*

Proof. It follows directly from Theorem 4.5. \square

Proposition 4.16. *The sijection τ in Construction 4.4 is compatible with $\eta_{\text{row},1}$, $\eta_{\text{row},2}$, \dots , $\eta_{\text{row},n-1}$. In particular, it is compatible with η_{top} when $n \geq 2$.*

Proof. As in the proof of Proposition 4.14, a disjoint union of $\text{id}_{\text{GT}(\mathbf{l})}$ is compatible with the statistics. The sijection σ is also compatible, so the sijection τ , which is constructed by composing them, is also compatible. \square

5 New sijections pertaining to monotone triangles

In this section, we simplify the sijection between alternating sign matrices and shifted Gelfand-Tsetlin patterns that is constructed in [7], and using the notion of compatibility we argue that it is more natural than the conventional one. First, in 5.1 we give definitions of some combinatorial objects. After that we define *generalized inversion numbers* for these combinatorial objects in 5.2. In 5.3 and 5.4 we construct a sijection and prove the compatibility of our construction with two statistics, one of which is the generalized inversion numbers we defined.

Definition 5.1. For $\mathbf{k} \in \mathbb{Z}^n$, a generalized monotone triangle with bottom row \mathbf{k} is a sequence $(\mathbf{k}^{(n)} = \mathbf{k}, \mu^{(n)}, \mathbf{k}^{(n-1)}, \mu^{(n-1)}, \dots, \mathbf{k}^{(1)}, \mu^{(1)}) \in \mathbb{Z}^n \times \text{AR}_n \times \mathbb{Z}^{n-1} \times \text{AR}_{n-1} \times \dots \times \mathbb{Z}^1 \times \text{AR}_1$ such that for $1 \leq i \leq n-1$, $\mathbf{k}^{(i)} \in \mu^{(i+1)}(\mathbf{k}^{(i+1)})$. More formally, the signed set of generalized monotone triangles with bottom row \mathbf{k} is

$$\text{GMT}(\mathbf{k}) := \bigsqcup_{\mu^{(n)} \in \text{AR}_n} \bigsqcup_{\mathbf{k}^{(n-1)} \in \mu^{(n)}(\mathbf{k})} \bigsqcup_{\mu^{(n-1)} \in \text{AR}_{n-1}} \bigsqcup_{\mathbf{k}^{(n-2)} \in \mu^{(n-1)}(\mathbf{k}^{(n-1)})} \dots \bigsqcup_{\mu^{(2)} \in \text{AR}_2} \bigsqcup_{\mathbf{k}^{(1)} \in \mu^{(2)}(\mathbf{k}^{(2)})} \text{AR}_1$$

Another interpretation of a generalized monotone triangle is given by the (extended) arrowed monotone triangles which are introduced in [9]. An arrowed monotone triangle is a triangular array of integers such that each entry is decorated by \swarrow , \nearrow or \nwarrow with some condition. The condition used in our variant is described as follows:

For each entry a that is not in bottom row, let b, c be the left-below and the right-below entry and let μ_b, μ_c be the decoration of b, c . Then, $a \in \underline{[b + \delta_{\nearrow}(\mu_b), c - \delta_{\swarrow}(\mu_c)]}$ holds.

For $(\mathbf{k}^{(n)}, \mu^{(n)}, \mathbf{k}^{(n-1)}, \mu^{(n-1)}, \dots, \mathbf{k}^{(1)}, \mu^{(1)}) \in \text{GMT}(\mathbf{k})$, $(\mathbf{k}_1, \mathbf{k}_2, \dots, \mathbf{k}_n)$ is an arrowed monotone triangle when it is decorated by $(\mu_1, \mu_2, \dots, \mu_n)$. In particular, $(\mathbf{k}_1, \mathbf{k}_2, \dots, \mathbf{k}_n)$ is a classical monotone triangle with bottom row \mathbf{k} when \mathbf{k} is strictly increasing.

Example. Let $\mathbf{k} = (1, 3, 5)$ and $\mu = (\swarrow, \nwarrow, \nearrow)$. Then, we have

$$\mu(\mathbf{k}) = \underline{[1, 2]} \times \underline{[4, 5]} = (\{(1, 4)\}, \emptyset).$$

Next, let $\mathbf{k}^{(2)} = (1, 4)$ and $\mu^{(2)} = (\nwarrow, \nwarrow)$, we have $\mu^{(2)}(\mathbf{k}^{(2)}) = \underline{[2, 3]}$. From the above, for example we have

$$((\swarrow), (2), (\nwarrow, \nwarrow), (1, 4), (\swarrow, \nwarrow, \nearrow)) \overset{\circ}{\in} \text{GMT}((1, 3, 5)),$$





and its sign is -1 . With the interpretation as an arrowed monotone triangle, we sometimes describe it by

$$\left(\begin{array}{cccc} & & 2 & \\ & 1 & 4 & \\ 1 & 3 & 5 & \end{array} , \begin{array}{ccc} & \nwarrow & \nwarrow \\ \nwarrow & \nwarrow & \nearrow \end{array} \right) \overset{\circ}{\in} \text{GMT}((1, 3, 5)).$$

To see that our generalized monotone triangle is indeed a generalization of a monotone triangle, we construct a sijection $\iota_{\text{MT}(\mathbf{k})}: \text{MT}(\mathbf{k}) \overset{\circ}{\rightsquigarrow} \text{GMT}(\mathbf{k})$ for a strictly increasing $\mathbf{k} \in \mathbb{Z}^n$.

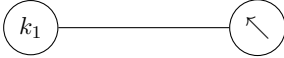
Construction 5.2. We construct a sijection $\iota_{\text{MT}(\mathbf{k})}: \text{MT}(\mathbf{k}) \overset{\circ}{\rightsquigarrow} \text{GMT}(\mathbf{k})$ for a strictly increasing $\mathbf{k} \in \mathbb{Z}^n$. For $n = 1$, $\text{MT}(\mathbf{k}) = (\{k_1\}, \emptyset)$ and $\text{GMT}(\mathbf{k}) = \text{AR}_1$. We define $\iota_{\text{MT}(\mathbf{k})}$ as

$$\varphi: \quad \text{MT}(\mathbf{k}) \quad \overset{\circ}{\rightsquigarrow} \quad \text{GMT}(\mathbf{k})$$

+		
-		

For $n > 1$, it is sufficient to construct a sijection $\Xi_{\mathbf{k}}: \text{MT}(\mathbf{k}) \rightsquigarrow \bigsqcup_{\mu \in \text{AR}_n} \bigsqcup_{\mathbf{l} \in \mu(\mathbf{k})} \text{MT}(\mathbf{l})$. Indeed, the construction is completed by induction on n :

$$\text{MT}(\mathbf{k}) \rightsquigarrow \bigsqcup_{\mu \in \text{AR}_n} \bigsqcup_{\mathbf{l} \in \mu(\mathbf{k})} \text{MT}(\mathbf{l}) \rightsquigarrow \bigsqcup_{\mu \in \text{AR}_n} \bigsqcup_{\mathbf{l} \in \mu(\mathbf{k})} \text{GMT}(\mathbf{l}) = \text{GMT}(\mathbf{k}).$$

Note that for any $\mu \in \text{AR}_n$ and a strictly increasing $\mathbf{k} \in \mathbb{Z}^n$, every element of $\mu(\mathbf{k})$ is weakly increasing. For an $\mathbf{l} \in \mu(\mathbf{k})$ that is not strictly increasing, it holds that $l_i = l_{i+1}$ for some $1 \leq i \leq n-1$, and thus $\text{GT}(\mathbf{l}) = (\emptyset, \emptyset)$ holds. Therefore, the induction runs.

Let us now construct $\Xi_{\mathbf{k}}$. First, we decompose the LHS of the sijection $\Xi_{\mathbf{k}}: \text{MT}(\mathbf{k}) \rightsquigarrow \bigsqcup_{\mu \in \text{AR}_n} \bigsqcup_{\mathbf{l} \in \mu(\mathbf{k})} \text{MT}(\mathbf{l})$ with respect to the second bottom row. Let $\text{MT}(\mathbf{k}, \mathbf{l})$ be a signed set of monotone triangles whose bottom row is \mathbf{k} and whose second bottom row is \mathbf{l} , then

$$\text{MT}(\mathbf{k}) = \bigsqcup_{\mathbf{l} \in \mathbb{Z}^{n-1}} \text{MT}(\mathbf{k}, \mathbf{l}),$$

where \mathbb{Z}^{n-1} is identified with the signed set $(\mathbb{Z}^{n-1}, \emptyset)$, and the same identification shall be used in the following without mentioning. Here, in case $\mathbf{l} \in \bigcup_{\mu \in \text{AR}_n} \text{supp}(\mu(\mathbf{k}))$ we have $\text{MT}(\mathbf{k}, \mathbf{l}) = \text{MT}(\mathbf{l})$, and otherwise $\text{MT}(\mathbf{k}, \mathbf{l}) = (\emptyset, \emptyset)$. Consequently, we have

$$\text{MT}(\mathbf{k}) = \bigsqcup_{\mathbf{l} \in \bigcup_{\mu \in \text{AR}_n} \text{supp}(\mu(\mathbf{k}))} \text{MT}(\mathbf{l}).$$

Let \mathcal{M}_1 be a signed set defined by $\mathcal{M}_1^\pm = \{\mu \in \text{AR}_n^\pm \mid \mathbf{l} \in \text{supp}(\mu(\mathbf{k}))\}$. Then, we have

$$\bigsqcup_{\mu \in \text{AR}_n} \bigsqcup_{\mathbf{l} \in \mu(\mathbf{k})} \text{MT}(\mathbf{l}) = \bigsqcup_{\mathbf{l} \in \mathbb{Z}^{n-1}} \bigsqcup_{\mu \in \mathcal{M}_1} \text{MT}(\mathbf{l}) = \bigsqcup_{\mathbf{l} \in \bigcup_{\mu \in \text{AR}_n} \text{supp}(\mu(\mathbf{k}))} \bigsqcup_{\mu \in \mathcal{M}_1} \text{MT}(\mathbf{l}).$$

Therefore, it is sufficient to construct a sijection $(\{\cdot\}, \emptyset) \rightsquigarrow \mathcal{M}_1$ for $\mathbf{l} \in \bigcup_{\mu \in \text{AR}_n} \text{supp}(\mu(\mathbf{k}))$. Now, $\text{supp}(\mathcal{M}_1)$ is described as follows, when it is not empty:

$$\text{supp}(\mathcal{M}_1) = \left\{ \mu \in \text{AR}_n \left| \begin{array}{l} \mu_i = \swarrow \text{ when } i \leq n-1 \text{ and } k_i = l_i, \\ \mu_i = \nearrow \text{ when } i \geq 2 \text{ and } k_i = l_{i-1} + 1 \\ \text{otherwise, } \mu_i \in \{\swarrow, \nearrow, \swarrow \nearrow\} \end{array} \right. \right\}.$$

Let μ_1 be an arrow row such that

$$(\mu_1)_i = \begin{cases} \nearrow & \text{when } i \geq 2 \text{ and } k_i = l_{i-1} + 1, \\ \swarrow & \text{otherwise,} \end{cases}$$

and the following rule then defines a sijection $(\{\cdot\}, \emptyset) \rightsquigarrow \mathcal{M}_1$:

An arrow row $\mu_1 \in \mathcal{M}_1^+$ corresponds to a unique element of LHS of the sijection $\Xi_{\mathbf{k}}$. For any other element μ of \mathcal{M}_1 , there exists a minimum index i such that $\mu_i \neq (\mu_1)_i$. The counterpart of μ is given by adding/removing \swarrow to/from μ_i . \square

Remark. This construction is similar to Problem 7 in [7]. The most important difference with that reference is the definition of $(\mu_1)_n$, which is crucial from the viewpoint of compatibility. For more details, see Proposition 5.5.

The following proposition shows that the generalized monotone triangles are indeed a generalization of monotone triangles.

Proposition 5.3. *Let $\mathbf{k} \in \mathbb{Z}^n$ such that \mathbf{k} is strictly increasing. Let η_{MT} be a $MT(\mathbf{k})$ -valued statistic of $MT(\mathbf{k}) \sqcup GMT(\mathbf{k})$ such that*

$$\begin{aligned} \forall s \in MT(\mathbf{k}), \eta_{MT}(s) &= s, \\ \forall s = \left(\mathbf{k}^{(n)}, \mu^{(n)}, \mathbf{k}^{(n-1)}, \mu^{(n-1)}, \dots, \mathbf{k}^{(1)}, \mu^{(1)} \right) \in GMT(\mathbf{k}), \eta_{MT}(s) &= (\mathbf{k}_1, \mathbf{k}_2, \dots, \mathbf{k}_n). \end{aligned}$$

Then, $\iota_{MT(\mathbf{k})}: MT(\mathbf{k}) \rightsquigarrow GMT(\mathbf{k})$ in Construction 5.2 is compatible with η_{MT} .

Proof. For $n = 1$, this is trivial. For $n > 1$, the second bottom row is preserved because of the construction, and the proof is completed by induction on n . \square

The top of a generalized monotone triangle T is defined by $\eta_{\text{top}} = \eta_{\text{top}}(\eta_{MT}(T))$. According to Proposition 5.3, the sijection $\iota_{MT(\mathbf{k})}$ in Construction 5.2 is compatible with η_{top} .

Remark. In [7], the definition of a monotone triangle with generic bottom row is given as a triangular array. First one defines a binary relation $\mathbf{l} \prec \mathbf{k}$ for $\mathbf{l} \in \mathbb{Z}^{n-1}$ and $\mathbf{k} \in \mathbb{Z}^n$ as:

$$\mathbf{l} \prec \mathbf{k} \Leftrightarrow \begin{cases} \text{for } i \in \{1, 2, \dots, n-1\}, l_i \text{ is in the closed interval between } k_i \text{ and } k_{i+1} - 1, \\ \text{if } k_{i-1} < k_i < k_{i+1} \text{ for some } i \in \{2, \dots, n-1\}, \text{ then } l_{i-1} \neq k_i - 1 \text{ or } l_i \neq k_i, \\ \text{if } k_i > l_i = k_{i+1} - 1 \text{ for some } i \in \{1, \dots, n-1\}, \text{ then } i \leq n-2 \text{ and } l_{i+1} = k_{i+1}, \\ \text{if } k_i = l_i \geq k_{i+1} \text{ for some } i \in \{1, \dots, n-1\}, \text{ then } i \geq 2 \text{ and } l_{i-1} = k_i - 1. \end{cases}$$

Then, a monotone triangle with bottom row \mathbf{k} is a triangular array $(k_1, k_2, \dots, k_n) \in \mathbb{Z} \times \mathbb{Z}^2 \times \dots \times \mathbb{Z}^n$ such that $k_1 \prec k_2 \prec \dots \prec k_n = k$. The sign of a monotone triangle (k_1, k_2, \dots, k_n) is $(-1)^r$, where r is the sum of:

- the number of (i, j) such that $1 \leq j < i \leq n$ and $k_{i,j} \geq k_{i,j+1}$,
- the number of (i, j) such that $1 \leq j+2 \leq i \leq n$, $k_{i,j} \geq k_{i,j+1} \geq k_{i,j+2}$, $k_{i-1,j} = k_{i,j+1} - 1$ and $k_{i-1,j+1} = k_{i,j+1}$.

Note that we modified the definition following our use of half-open intervals.

This definition might seem strange but it is in fact correct. The purpose of this remark is to explain why. According to Construction 5.2, we first define $\mathcal{M}_{\mathbf{k}, \mathbf{l}}$ as:

- $\text{supp}(\mathcal{M}_{\mathbf{k}, \mathbf{l}}) = \{\mu \in \text{supp}(AR_n) \mid \mathbf{l} \in \text{supp}(\mu(\mathbf{k}))\}$,
- The sign of $\mu \in \text{supp}(\mathcal{M}_{\mathbf{k}, \mathbf{l}})$ is the product of:
 - the sign of μ as an element of AR_n ,
 - the sign of \mathbf{l} as an element of $\mu(\mathbf{k})$.

Then, we have

$$\bigsqcup_{\mu \in AR_n} \bigsqcup_{\mathbf{l} \in \mu(\mathbf{k})} MT(\mathbf{l}) = \bigsqcup_{\mathbf{l} \in \mathbb{Z}^{n-1}} \bigsqcup_{\mu \in \mathcal{M}_{\mathbf{k}, \mathbf{l}}} MT(\mathbf{l}).$$

We define $\mathbf{l} \prec' \mathbf{k} \Leftrightarrow \#\mathcal{M}_{\mathbf{k},\mathbf{l}} \neq 0$ and our variant of a monotone triangle is a triangular array $(k_1, k_2, \dots, k_n) \in \mathbb{Z} \times \mathbb{Z}^2 \times \dots \times \mathbb{Z}^n$ such that $k_1 \prec' k_2 \prec' \dots \prec' k_n = k$. If $\#\mathcal{M}_{\mathbf{k},\mathbf{l}} = 0, \pm 1$ holds for any $\mathbf{l} \in \mathbb{Z}^{n-1}$ and $\mathbf{k} \in \mathbb{Z}^n$ such that $\#MT(\mathbf{l}) \neq 0$, then we can set the sign of the monotone triangles for us to construct the sijection

$$MT(\mathbf{k}) \circ \cong \bigsqcup_{\mu \in AR_n} \bigsqcup_{\mathbf{l} \in \mu(\mathbf{k})} MT(\mathbf{l})$$

in the way similar to Construction 5.2. We prove that when $\#MT(\mathbf{l}) \neq 0$ it holds that $\#\mathcal{M}_{\mathbf{k},\mathbf{l}} = 0, \pm 1$. First, we define a function $f: \text{supp}(AR_n) \rightarrow \{0, 1\}^{2n}$ by

$$\mu \mapsto (\delta_{\prec}(\mu_1), \delta_{\succ}(\mu_1), \delta_{\prec}(\mu_2), \delta_{\succ}(\mu_2), \dots, \delta_{\prec}(\mu_n), \delta_{\succ}(\mu_n)).$$

Then, the image of f is

$$\{(a_{1,0}, a_{1,1}, a_{2,0}, a_{2,1}, \dots, a_{n,0}, a_{n,1}) \in \{0, 1\}^{2n} \mid \forall i \in \{1, 2, \dots, n\}, a_{i,0} + a_{i,1} \geq 1\}.$$

We fix $\mathbf{l} \in \mathbb{Z}^{n-1}$ and $\mathbf{k} \in \mathbb{Z}^n$. For $\mu \in \text{supp}(AR_n)$ to be included $\text{supp}(\mathcal{M}_{\mathbf{k},\mathbf{l}})$ we have to impose some conditions on it. In detail, the conditions are described as follows:

		conditions on a	trans. mat.
$k_{i+1} \geq k_i + 2,$	$l_i = k_i$	$a_{i,1} = 0$	A_1
	$l_i = k_{i+1} - 1$	$a_{i+1,0} = 0$	A_2
	$k_i < l_i < k_{i+1} - 1$	True	A_3
	otherwise	False	O
$k_{i+1} = k_i + 1,$	$l_i = k_i = k_{i+1} - 1$	$a_{i,1} = a_{i+1,0}$	A_4
	otherwise	False	O
$k_{i+1} \leq k_i,$	$l_i = k_i$	$a_{i,1} = 1$	$-A_5$
	$l_i = k_{i+1} - 1$	$a_{i+1,0} = 1$	$-A_6$
	$k_{i+1} - 1 < l_i < k_i$	True	$-A_3$
	otherwise	False	O

where $i \in \{1, 2, \dots, n-1\}$, $(a_{1,0}, a_{1,1}, a_{2,0}, a_{2,1}, \dots, a_{n,0}, a_{n,1}) = f(\mu)$ and the data in the last column will be explained later. For $j \in \{1, 2, \dots, n\}$ and $t \in \{0, 1\}$, we define signed sets $B_{j,t}$ by

$$\text{supp}(B_{j,t}) = \#\{(a_{1,0}, a_{1,1}, a_{2,0}, a_{2,1}, \dots, a_{j,0}) \in \{0, 1\}^{2j-1} \mid a_{j,0} = t \text{ and for } i \in \{1, 2, \dots, j-1\}, \text{ it meets the condition described above and } a_{i,0} + a_{i,1} \geq 1\},$$

with the sign of $(a_{1,0}, a_{1,1}, a_{2,0}, a_{2,1}, \dots, a_{j,0})$ being $(-1)^r$, where r is the sum of:

- the number of integers $i \in \{1, 2, \dots, j-1\}$ such that $a_{i,0} = a_{i,1} = 1$,
- the number of integers $i \in \{1, 2, \dots, j-1\}$ such that $k_i + a_{i,1} > k_{i+1} - a_{i+1,0}$.

We denote the size of $B_{j,t}$ by $b_{j,t}$. Furthermore, we define the transition matrix by the relation

$$\begin{pmatrix} b_{j+1,0} \\ b_{j+1,1} \end{pmatrix} = T_j \begin{pmatrix} b_{j,0} \\ b_{j,1} \end{pmatrix},$$

where $j \in \{1, 2, \dots, n-1\}$. Then the value of $\#\mathcal{M}_{\mathbf{k}, \mathbf{l}}$ is expressed as

$$\#\mathcal{M}_{\mathbf{k}, \mathbf{l}} = \begin{pmatrix} 1 & 0 \\ 0 & 1 \end{pmatrix} T_{n-1} T_{n-2} \cdots T_1 \begin{pmatrix} 1 \\ 1 \end{pmatrix}.$$

We can calculate T_j from the value of k_j, k_{j+1} and l_j . The results are described in the last column of the above table, where

$$\begin{aligned} A_1 &= \begin{pmatrix} 0 & 1 \\ 0 & 1 \end{pmatrix}, & A_2 &= \begin{pmatrix} 1 & 0 \\ 0 & 0 \end{pmatrix}, & A_3 &= \begin{pmatrix} 1 & 0 \\ 1 & 0 \end{pmatrix}, \\ A_4 &= \begin{pmatrix} 0 & 1 \\ -1 & 1 \end{pmatrix}, & A_5 &= \begin{pmatrix} 1 & -1 \\ 1 & -1 \end{pmatrix}, & A_6 &= \begin{pmatrix} 0 & 0 \\ 1 & 0 \end{pmatrix}. \end{aligned}$$

Here, in order to use the condition $\#MT(\mathbf{l}) \neq 0$, we prove the following lemma. For $\mathbf{m} = (m_i)_i \in \mathbb{Z}^d$, if there exists an integer $1 \leq i \leq d-2$ such that $m_i = m_{i+1} - 1 = m_{i+2} - 2$, we say it is partially successive.

Lemma 5.4. For a partially successive sequence $\mathbf{m} \in \mathbb{Z}^d$, we have $\#MT(\mathbf{m}) = 0$.

Proof. We prove the stronger statement that $MT(\mathbf{m}) = (\emptyset, \emptyset)$ for such \mathbf{m} . We assume, for the sake of contradiction, that there exists a sequence $\mathbf{m}^{(1)} \prec' \mathbf{m}^{(2)} \prec' \cdots \prec' \mathbf{m}^{(d)} = \mathbf{m}$. Let i be the minimum index such that $\mathbf{m}^{(i)}$ is partially successive and j the minimum index such that $m_j^{(i)} = m_{j+1}^{(i)} - 1 = m_{j+2}^{(i)} - 2$. We calculate $\#\mathcal{M}_{\mathbf{m}^{(i)}, \mathbf{m}^{(i-1)}}$. We set $(\mathbf{k}, \mathbf{l}) = (\mathbf{m}^{(i)}, \mathbf{m}^{(i-1)})$ in the above context and consider the transition matrices. First, we have $T_j = T_{j+1} = A_4$ if they are not O because of the choice of j . Furthermore, we have $m_j^{(i-1)} = m_j^{(i)} = m_{j+1}^{(i-1)} - 1 = m_{j+1}^{(i)} - 1$. Therefore, $m_{j+2}^{(i-1)} \neq m_{j+2}^{(i)}$ if it exists because of the choice of i . Thus, we have $T_{j+2} = A_2, \pm A_3, -A_6, O$ or $j+2 = i$. Similarly, if $j \neq 1$ then $T_{j-1} = A_1, \pm A_3, -A_5, O$. Here, we can decompose A_2, A_3, A_6, O as

$$A_2 = \begin{pmatrix} 1 \\ 0 \end{pmatrix} \begin{pmatrix} 1 & 0 \end{pmatrix}, \quad A_3 = \begin{pmatrix} 1 \\ 1 \end{pmatrix} \begin{pmatrix} 1 & 0 \end{pmatrix}, \quad A_6 = \begin{pmatrix} 0 \\ 1 \end{pmatrix} \begin{pmatrix} 1 & 0 \end{pmatrix}, \quad O = \begin{pmatrix} 0 \\ 0 \end{pmatrix} \begin{pmatrix} 1 & 0 \end{pmatrix},$$

and A_1, A_3, A_5, O as

$$A_1 = \begin{pmatrix} 1 \\ 1 \end{pmatrix} \begin{pmatrix} 0 & 1 \end{pmatrix}, \quad A_3 = \begin{pmatrix} 1 \\ 1 \end{pmatrix} \begin{pmatrix} 1 & 0 \end{pmatrix}, \quad A_5 = \begin{pmatrix} 1 \\ 1 \end{pmatrix} \begin{pmatrix} 1 & -1 \end{pmatrix}, \quad O = \begin{pmatrix} 1 \\ 1 \end{pmatrix} \begin{pmatrix} 0 & 0 \end{pmatrix}.$$

Therefore, we have

$$\#\mathcal{M}_{\mathbf{m}^{(i)}, \mathbf{m}^{(i-1)}} = \begin{pmatrix} 1 & 0 \\ 0 & 1 \end{pmatrix} T_{i-1} T_{i-2} \cdots T_1 \begin{pmatrix} 1 \\ 1 \end{pmatrix} = 0.$$

because $\begin{pmatrix} 1 & 0 \\ 0 & 1 \end{pmatrix} A_4^2 \begin{pmatrix} 1 \\ 1 \end{pmatrix} = 0$. This means that $\mathbf{m}^{(i-1)} \not\prec' \mathbf{m}^{(i)}$, and it contradicts the assumption.

Finally, we obtain $MT(\mathbf{m}) = (\emptyset, \emptyset)$, for a partially successive sequence \mathbf{m} . \square

Coming back to the purpose of this remark, according to this lemma, it is sufficient to show that $\#\mathcal{M}_{\mathbf{k}, \mathbf{l}} = 0, \pm 1$ when \mathbf{l} is not partially successive. We assume that \mathbf{l} is not partially successive and $T_j = A_4$ for some j . Then, we have $k_j = l_j = k_{j+1} - 1$, so $j = 1, n-1$ or $l_{j-1} \neq k_j - 1$ or $l_{j+1} \neq k_{j+1}$.

The sign of an arrow pattern is defined as $(-1)^{\#\text{of}\times}$, or more formally, the signed set of arrow patterns with size n is

$$\text{AP}_n = (\{\searrow, \swarrow\}, \{\times\})^{n-1} \times (\{\searrow, \swarrow\}, \{\times\})^{n-2} \times \cdots \times (\{\searrow, \swarrow\}, \{\times\})^1 \simeq (\{\searrow, \swarrow\}, \{\times\})^{\binom{n}{2}},$$

where $\text{AP}_1 = (\{\emptyset\}, \emptyset)$. An arrow pattern $T = (t_{i,j})_{1 \leq i < j \leq n}$ acts on $\mathbf{k} \in \mathbb{Z}^n$ as:

$$c_i(T) = \sum_{j=i+1}^n \delta_{\swarrow}(t_{i,j}) - \sum_{j=1}^{i-1} \delta_{\searrow}(t_{i,j})$$

$$T(\mathbf{k}) = (k_1 + c_1(T), k_2 + c_2(T), \dots, k_n + c_n(T)) \in \mathbb{Z}^n,$$

where $\delta_{\searrow}(\searrow) = \delta_{\searrow}(\times) = 1$, $\delta_{\searrow}(\swarrow) = 0$ and $\delta_{\swarrow}(\swarrow) = \delta_{\swarrow}(\times) = 1$, $\delta_{\swarrow}(\searrow) = 0$. Lastly, the signed set of shifted Gelfand-Tsetlin patterns with bottom row $\mathbf{k} \in \mathbb{Z}^n$ is defined as

$$\text{SGT}(\mathbf{k}) = \bigsqcup_{T \in \text{AP}_n} \text{GT}(T(\mathbf{k})).$$

We define the top of a shifted Gelfand-Tsetlin pattern $(A, T) \overset{\circ}{\in} \text{SGT}(\mathbf{k})$ by $\eta_{\text{top}}((A, T)) = \eta_{\text{top}}(A)$. Note that A is an element of $\text{supp}(\text{GT}(T(\mathbf{k})))$.

Example. Let $T = ((\searrow, \times, \swarrow), (\times, \swarrow), (\swarrow)) \overset{\circ}{\in} \text{AP}_4$. When we arrange its elements as

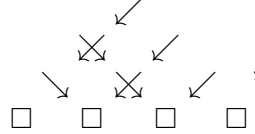

$c_i(T)$ is the number of arrows on the anti-diagonal line of the i -th square from the left and pointing at it, minus the number of arrows on the diagonal line pointing at the square. Then, we have

$$c_1(T) = 2 - 0 = 2, \quad c_2(T) = 2 - 1 = 1, \quad c_3(T) = 1 - 2 = -1, \quad c_4(T) = 0 - 0 = 0.$$

Therefore, when let $\mathbf{k} = (3, 1, 4, 1)$, then $T(\mathbf{k}) = (5, 2, 3, 1)$. Thus, for example we have

$$\left(\begin{array}{cccc} & & 2 & \\ & & 3 & 1 \\ & 4 & 2 & 1 \\ 5 & 2 & 3 & 1 \end{array}, \begin{array}{ccc} & \swarrow & \\ & \times & \swarrow \\ \searrow & \times & \swarrow \end{array} \right) \overset{\circ}{\in} \text{SGT}((3, 1, 4, 1)),$$

and its sign is $(-1)^2 \cdot (-1)^5 = 1$. Last, the value of η_{top} on this element is 2.

Remark. A shifted Gelfand-Tsetlin pattern is introduced in [7] to explain the combinatorial meaning of an ‘operator formula’ stating that

$$MT(\mathbf{k}) = \prod_{1 \leq p < q \leq n} (E_{k_p} + E_{k_q}^{-1} - E_{k_p} E_{k_q}^{-1}) \prod_{1 \leq i < j \leq n} \frac{k_j - k_i}{j - i},$$

where E_x denotes the shift operator, i.e., $E_x p(x) = p(x + 1)$ (This is cited from the theorem in the induction of [7]). It holds that $\text{GT}(\mathbf{k}) = \prod_{1 \leq i < j \leq n} \frac{k_j - k_i}{j - i}$, and the action of an arrow pattern on \mathbf{k} corresponds to the operator part $\prod_{1 \leq p < q \leq n} (E_{k_p} + E_{k_q}^{-1} - E_{k_p} E_{k_q}^{-1})$. In this sense, shifted Gelfand-Tsetlin patterns are a combinatorial realization of this operator formula.

5.2 Generalized Inversion Numbers

In this subsection, we define generalized inversion numbers of alternating sign matrices, monotone triangles, generalized monotone triangles and shifted Gelfand-Tsetlin patterns. First, we recall the definition of an inversion number of a permutation and a permutation matrix. For a permutation $p = (p_1, p_2, \dots, p_n) \in \mathfrak{S}_n$, its inversion number is the number of pairs (i, j) such that $1 \leq i < j \leq n$ and $p(i) > p(j)$. A permutation matrix $A = (a_{ij})_{ij}$ corresponding to p is defined by $a_{ij} = \delta_{j,p(i)}$, and its inversion number is that of p itself. In fact, the inversion number $\eta_{\text{inv}}(A)$ can be described by using the elements of A as below [1]:

$$\eta_{\text{inv}}(A) = \sum_{1 \leq i < i' \leq n, 1 \leq j' \leq j \leq n} a_{ij} a_{i'j'}.$$

This is also the definition of the inversion number for alternating sign matrices. Namely, for an alternating sign matrix $A = (a_{ij})_{ij}$, we define its inversion number by the above equation.

Remark. *This statistic is one of four statistics in Behrend, Di Francesco and Zinn-Justin's refined enumeration of alternating sign matrices and descending plane partitions [1, 2]. As stated in [1], there exists a variant of an inversion number for alternating sign matrices,*

$$\eta_{\text{inv}'}(A) = \sum_{1 \leq i < i' \leq n, 1 \leq j' < j \leq n} a_{ij} a_{i'j'}.$$

However, we adopt the former definition because the corresponding statistic for shifted Gelfand-Tsetlin patterns can be described simply (See 5.2.3).

5.2.1 Generalized Inversion Numbers for Monotone Triangles

We define the inversion number $\eta_{\text{inv}}(B)$ of a monotone triangle $B = (b_{ij})_{1 \leq j \leq i \leq n}$ by

$$\eta_{\text{inv}}(B) = \#\{(i, j) \mid 1 \leq j \leq i \leq n - 1, b_{i+1,j} \leq b_{i,j} = b_{i+1,j+1} - 1\}.$$

This definition is given in [6] without details. In the rest of this subsection, we will show that this definition is compatible with the bijection introduced in 5.1.1. Namely, let A be an alternating sign matrix and B the monotone triangle corresponding to A . We shall prove that $\eta_{\text{inv}}(A) = \eta_{\text{inv}}(B)$. First, we have

$$\begin{aligned} \eta_{\text{inv}}(A) &= \sum_{1 \leq i < i' \leq n, 1 \leq j' \leq j \leq n} a_{ij} a_{i'j'} \\ &= \sum_{1 \leq i' \leq n} \sum_{1 \leq j \leq n} \sum_{1 \leq i < i'} \sum_{1 \leq j' \leq j} a_{ij} a_{i'j'} \\ &= \sum_{1 \leq i' \leq n} \sum_{1 \leq j \leq n} \left(\sum_{1 \leq i < i'} a_{ij} \right) \left(\sum_{1 \leq j' \leq j} a_{i'j'} \right). \end{aligned}$$

Let $c_{i,j} = \sum_{1 \leq i' \leq i} a_{i'j}$ and $d_{i,j} = b_{i,j} - (j - 1)$. Here, these are elements of intermediate products in the bijection between alternating sign matrices and monotone triangles (See 5.1.1). Note that

$c_{ij} \in \{0, 1\}$ by the definition of an alternating sign matrix. Then, we have

$$\sum_{1 \leq i < i'} a_{ij} = 1 \Leftrightarrow c_{i'-1,j} = 1 \Leftrightarrow \exists \tilde{j} \in \{1, 2, \dots, i' - 1\}, d_{i'-1,\tilde{j}} = j.$$

Therefore, we have

$$\begin{aligned} \eta_{\text{inv}}(A) &= \sum_{1 \leq i' \leq n} \sum_{j=d_{i'-1,1}, d_{i'-1,2}, \dots, d_{i'-1,i'-1}} \left(\sum_{1 \leq j' \leq j} a_{i'j'} \right) \\ &= \sum_{1 \leq \tilde{j} \leq i' \leq n-1} \left(\sum_{1 \leq j' \leq d_{i'\tilde{j}}} a_{i'+1,j'} \right) \\ &= \sum_{1 \leq j \leq i \leq n-1} \left(\sum_{1 \leq j' \leq d_{ij}} a_{i+1,j'} \right). \end{aligned}$$

We fix (i, j) such that $1 \leq j \leq i \leq n-1$ and let $k = d_{ij}$. We prove

$$\sum_{1 \leq j' \leq k} a_{i+1,j'} = 1 \Leftrightarrow d_{i+1,j} \leq d_{i,j} = d_{i+1,j+1},$$

by considering the following two possibilities.

- Case 1: Assume that $a_{i+1,k} = -1$. By the definition of an alternating sign matrix, we have $\sum_{1 \leq j' \leq k} a_{i+1,j'} = 0$ and $c_{i+1,k} = 0$. In particular, $c_{i+1,k} = 0$ means $d_{i+1,j+1} \neq k$. Therefore both the RHS and the LHS are false.
- Case 2: Assume that $a_{i+1,k} \in \{0, 1\}$. Since $k = d_{ij}$, we have $c_{i,k} = 1$. Therefore, we have $c_{i+1,k} = 1$ and $a_{i+1,k} = 0$. In particular, the RHS is equivalent to $\#\{j' \mid 1 \leq j' \leq k, c_{i+1,j'} = 1\} = j + 1$, and then it is equivalent to $\sum_{i'=1}^{i+1} \sum_{j'=1}^k a_{i'j'} = j + 1$. Since $\sum_{i'=1}^i \sum_{j'=1}^k a_{i'j'} = \sum_{j'=1}^k c_{ij'} = j$, it is equivalent to the LHS.

From the above, we have

$$\begin{aligned} \eta_{\text{inv}}(A) &= \#\{(i, j) \mid 1 \leq j \leq i \leq n-1, d_{i+1,j} \leq d_{i,j} = d_{i+1,j+1}\} \\ &= \#\{(i, j) \mid 1 \leq j \leq i \leq n-1, b_{i+1,j} \leq b_{i,j} = b_{i+1,j+1} - 1\} =: \eta_{\text{inv}}(B). \end{aligned}$$

5.2.2 Generalized Inversion Numbers for Generalized Monotone Triangles

We define the inversion number of a generalized monotone triangle as the number of \nearrow and \nwarrow it includes. More formally, we define the inversion number of a generalized monotone triangle $T = (\mathbf{k}^{(n)}, \mu^{(n)}, \mathbf{k}^{(n-1)}, \mu^{(n-1)}, \dots, \mathbf{k}^{(1)}, \mu^{(1)}) \in \text{GMT}(\mathbf{k})$ by

$$\eta_{\text{inv}}(T) = \#\{(i, j) \mid 1 \leq j \leq i \leq n, \mu_j^{(i)} = \nearrow \text{ or } \nwarrow\}.$$

The following proposition guarantees that this definition is indeed a generalization of the inversion number for monotone triangles. For this proof, we define the inversion number of an arrow row $\mu \in \text{AR}_n$ as the number of \nearrow and \nwarrow it includes.

Proposition 5.5. *Let $n \in \mathbb{Z}$ and let $\mathbf{k} \in \mathbb{Z}^n$ be strictly increasing. The sijection $\iota_{MT}: MT(\mathbf{k}) \xrightarrow{\circ} GMT(\mathbf{k})$ in Construction 5.2 is compatible with the inversion number.*

Proof. The sijection is constructed by induction on n . When $n = 1$, the compatibility can be checked easily. For $n > 1$, it is constructed along the following relation (see Construction 5.2):

$$MT(\mathbf{k}) \xrightarrow{\circ} \bigsqcup_{\mu \in AR_n} \bigsqcup_{\mathbf{l} \in \mu(\mathbf{k})} MT(\mathbf{l}) \xrightarrow{\circ} \bigsqcup_{\mu \in AR_n} \bigsqcup_{\mathbf{l} \in \mu(\mathbf{k})} GMT(\mathbf{l}) = GMT(\mathbf{k}). \quad (*)$$

We define the inversion number of $(T, \mathbf{l}, \mu) \in \bigsqcup_{\mu \in AR_n} \bigsqcup_{\mathbf{l} \in \mu(\mathbf{k})} MT(\mathbf{l})$ by

$$\eta_{\text{inv}}((T, \mathbf{l}, \mu)) = \eta_{\text{inv}}(\mu) + \eta_{\text{inv}}(T),$$

and the inversion number of $(T, \mathbf{l}, \mu) \in \bigsqcup_{\mu \in AR_n} \bigsqcup_{\mathbf{l} \in \mu(\mathbf{k})} GMT(\mathbf{l})$ by

$$\eta_{\text{inv}}((T, \mathbf{l}, \mu)) = \eta_{\text{inv}}(\mu) + \eta_{\text{inv}}(T).$$

Note that the trivial sijection $\bigsqcup_{\mu \in AR_n} \bigsqcup_{\mathbf{l} \in \mu(\mathbf{k})} GMT(\mathbf{l}) = GMT(\mathbf{k})$ in $(*)$ is compatible with the inversion

number. In addition, the compatibility of the sijection $\bigsqcup_{\mu \in AR_n} \bigsqcup_{\mathbf{l} \in \mu(\mathbf{k})} MT(\mathbf{l}) \xrightarrow{\circ} \bigsqcup_{\mu \in AR_n} \bigsqcup_{\mathbf{l} \in \mu(\mathbf{k})} GMT(\mathbf{l})$

follows from the results for smaller n . According to Lemma 3.2, it is sufficient to show that the sijection $MT(\mathbf{k}) \xrightarrow{\circ} \bigsqcup_{\mu \in AR_n} \bigsqcup_{\mathbf{l} \in \mu(\mathbf{k})} MT(\mathbf{l})$ is compatible with the inversion number.

Let Φ be the sijection $MT(\mathbf{k}) \xrightarrow{\circ} \bigsqcup_{\mu \in AR_n} \bigsqcup_{\mathbf{l} \in \mu(\mathbf{k})} MT(\mathbf{l})$. Because $MT(\mathbf{k})^- = \emptyset$, it is sufficient to show that

$$\eta_{\text{inv}}((T, \mathbf{l}, \mu)) = \eta_{\text{inv}}(\Phi((T, \mathbf{l}, \mu))) \quad (\dagger)$$

for any $(T, \mathbf{l}, \mu) \in \bigsqcup_{\mu \in AR_n} \bigsqcup_{\mathbf{l} \in \mu(\mathbf{k})} MT(\mathbf{l})$. When $\Phi((T, \mathbf{l}, \mu)) \in \bigsqcup_{\mu \in AR_n} \bigsqcup_{\mathbf{l} \in \mu(\mathbf{k})} MT(\mathbf{l})$, (\dagger) follows from the fact that $\Phi((T, \mathbf{l}, \mu))$ is given by adding/removing \nearrow to/from μ of (T, \mathbf{l}, μ) . In the other case μ must be $\mu_{\mathbf{l}}$, where $\mu_{\mathbf{l}}$ is defined in Construction 5.2 as follows:

$$(\mu_{\mathbf{l}})_i = \begin{cases} \nearrow & \text{when } i \geq 2 \text{ and } k_i = l_{i-1} + 1, \\ \nwarrow & \text{otherwise.} \end{cases}$$

Let $T' = \Phi((T, \mathbf{l}, \mu)) \in \text{supp}(MT(\mathbf{k}))$. Since \mathbf{k} is strictly increasing, $k_{i-1} \leq l_{i-1} = k_i - 1$ holds if and only if $(\mu_{\mathbf{l}})_i = \nearrow$. Therefore, the number of \nearrow in $\mu_{\mathbf{l}}$ coincides with $\eta_{\text{inv}}(T') - \eta_{\text{inv}}(T)$. \square

Remark. *We extended the definition of monotone triangles as pure triangular arrays to general bottom rows in the remark of Section 5.1.2, but we cannot define the inversion number for them for the sijection $\iota: MT \xrightarrow{\circ} GMT$ to become compatible with it. For example, let $\mathbf{k} = (3, 1)$ and $\mathbf{l} = (0)$, then we have*

$$\mathcal{M}_{\mathbf{k}, \mathbf{l}} = (\{\nwarrow, \nearrow\}, \{\nwarrow\}) \times (\{\nwarrow\}, \{\nwarrow\}).$$

Then the distribution of η_{inv} on $\mathcal{M}_{\mathbf{k},1}$ is

$$\frac{\eta_{inv} = 0 \quad \eta_{inv} = 1 \quad \eta_{inv} = 2}{1 \quad 3 \quad 2}.$$

Because the sijection ι is compatible with η_{MT} , it cannot be compatible with η_{inv} .

5.2.3 Generalized Inversion Numbers for Shifted Gelfand-Tsetlin Patterns

We define the inversion number of a shifted Gelfand-Tsetlin pattern $(A, T) \in \bigsqcup_{T \in \text{AP}_n} \text{GT}(T(\mathbf{k})) = \text{SGT}(\mathbf{k})$ as the number of \swarrow and \searrow in T . For example, the inversion number of

$$\left(\begin{array}{ccccc} & & 3 & & \\ & 1 & & 4 & \\ & & 5 & & 2 \\ 1 & & & & \end{array}, \begin{array}{ccc} & \swarrow & \\ & & \searrow \\ & & \searrow \end{array} \right) \in \text{SGT}(0, 5, 3),$$

is two. This definition is simple so it is meaningful to ask for compatibility with it. However, Fischer and Konvalinka's construction is not compatible with this statistic. For example, according to their paper [7],

$$\left(\begin{array}{ccccc} & & 2 & & \\ & 1 & & 4 & \\ & & 3 & & 5 \\ 1 & & & & \end{array} \right) \in \text{MT}(1, 3, 5)$$

corresponds to

$$\left(\begin{array}{ccccc} & & 2 & & \\ & 2 & & 4 & \\ & & 3 & & 5 \\ 2 & & & & \end{array}, \begin{array}{ccc} & \swarrow & \\ & & \swarrow \\ & & \swarrow \end{array} \right) \in \text{SGT}(1, 3, 5),$$

but the inversion number of the former is 1, which is different from that of the latter, which is 2. The rest of this section is devoted to the construction of a sijection $\text{GMT}(\mathbf{k}) \rightsquigarrow \text{SGT}(\mathbf{k})$ compatible with these inversion numbers.

5.3 A sijection $\text{GMT}(\mathbf{k}) \rightsquigarrow \text{SGT}(\mathbf{k})$

Fischer and Konvalinka construct a sijection between $\text{GMT}(\mathbf{k})$ and $\text{SGT}(\mathbf{k})$ in [7]. They first construct a sijection $\Phi_{\mathbf{k},x}: \bigsqcup_{\mu \in \text{AR}_n} \bigsqcup_{\mathbf{l} \in \mu(\mathbf{k})} \text{SGT}(\mathbf{l}) \rightsquigarrow \text{SGT}(\mathbf{k})$, and then construct the desired sijection by induction on n as (cf. Construction 5.2):

$$\text{GMT}(\mathbf{k}) = \bigsqcup_{\mu \in \text{AR}_n} \bigsqcup_{\mathbf{l} \in \mu(\mathbf{k})} \text{GMT}(\mathbf{l}) \rightsquigarrow \bigsqcup_{\mu \in \text{AR}_n} \bigsqcup_{\mathbf{l} \in \mu(\mathbf{k})} \text{SGT}(\mathbf{l}) \rightsquigarrow \text{SGT}(\mathbf{k}).$$

For more details, see Problem 10 in [7]. Their construction of Φ is given by composing the four sijections:

$$\begin{aligned}
& \bigsqcup_{\mu \in \text{AR}_n} \bigsqcup_{\mathbf{l} \in \mu(\mathbf{k})} \text{SGT}(\mathbf{1}) \\
& \begin{array}{c} \Phi_1 \\ \circlearrowleft \circlearrowright \end{array} \bigsqcup_{\mu \in \text{AR}_n} \bigsqcup_{T \in \text{AP}_{n-1}} \bigsqcup_{\mathbf{m} \in S_1 \times S_2 \times \cdots \times S_{n-1}} \text{GT}(m_1 + c_1(T), m_2 + c_2(T), \dots, m_{n-1} + c_{n-1}(T), x) \\
& \begin{array}{c} \Phi_2 \\ \circlearrowleft \circlearrowright \end{array} \bigsqcup_{\mu \in \text{AR}_n} \bigsqcup_{T \in \text{AP}_n} \bigsqcup_{\mathbf{m} \in S_1 \times S_2 \times \cdots \times S_{n-1}} \text{GT}(m_1 + c_1(T), m_2 + c_2(T), \dots, m_{n-1} + c_{n-1}(T), x) \\
& \begin{array}{c} \Phi_3 \\ \circlearrowleft \circlearrowright \end{array} \bigsqcup_{\mu \in \text{AR}_n} \bigsqcup_{T \in \text{AP}_n} \bigsqcup_{i=1}^n \text{GT}(k_1 + \delta_{\nearrow}(\mu_1) + c_1(T), \dots, k_{i-1} + \delta_{\nearrow}(\mu_{i-1}) + c_{i-1}(T), \\
& \hspace{15em} x, k_{i+1} - \delta_{\searrow}(\mu_{i+1}) + c_i(T), \dots, k_n - \delta_{\searrow}(\mu_n) + c_{n-1}(T)) \\
& \begin{array}{c} \Phi_4 \\ \circlearrowleft \circlearrowright \end{array} \text{SGT}(\mathbf{k}).
\end{aligned}$$

Here, $S_i = (\{k_i + \delta_{\nearrow}(\mu_i)\}, \{k_{i+1} - \delta_{\searrow}(\mu_{i+1})\})$. Our goal is to obtain a sijection compatible with the statistics η_{top} and η_{inv} by modifying the construction. To describe our construction, we prepare some notations.

- Let Ω be a signed set $(\{0\}, \{1\})$.
- We define a function $m_i: \text{supp}(\text{AR}_n) \times \text{supp}(\text{AP}_{n-1}) \times \text{supp}(\Omega) \rightarrow \mathbb{Z}$ by

$$m_i(\mu, T, 0) = k_i + \delta_{\nearrow}(\mu_i) + c_i(T), \quad m_i(\mu, T, 1) = k_{i+1} - \delta_{\searrow}(\mu_{i+1}) + c_i(T).$$

- We define an involution r on arrows that acts on them as reversing the direction. For example,

$$r(\nearrow) = \searrow, \quad r(\bowtie) = \bowtie.$$

Our construction consists of Φ_1 , a modified Φ_3 and a modified Φ_4 :

$$\begin{aligned}
& \bigsqcup_{\mu \in \text{AR}_n} \bigsqcup_{\mathbf{l} \in \mu(\mathbf{k})} \text{SGT}(\mathbf{1}) \\
& \begin{array}{c} \Phi_1 \\ \circlearrowleft \circlearrowright \end{array} \bigsqcup_{\mu \in \text{AR}_n} \bigsqcup_{T \in \text{AP}_{n-1}} \bigsqcup_{\mathbf{m} \in S_1 \times S_2 \times \cdots \times S_{n-1}} \text{GT}(m_1 + c_1(T), m_2 + c_2(T), \dots, m_{n-1} + c_{n-1}(T), x) \\
& \begin{array}{c} \Phi'_3 \\ \circlearrowleft \circlearrowright \end{array} \bigsqcup_{i=1}^n \bigsqcup_{\mu \in \text{AR}_n} \bigsqcup_{T \in \text{AP}_{n-1}} \text{GT}(m_1(\mu, T, 0), \dots, m_{i-1}(\mu, T, 0), x, m_i(\mu, T, 1), \dots, m_{n-1}(\mu, T, 1)) \\
& \begin{array}{c} \Phi'_4 \\ \circlearrowleft \circlearrowright \end{array} \text{SGT}(\mathbf{k}).
\end{aligned}$$

The sijection Φ'_3 is essentially the same as Φ_3 , but the difference between Φ'_4 and Φ_4 plays a key role for compatibility of Φ . Therefore, we explain the constructions of Φ_1 and Φ'_3 in this subsection as essentially known results and we explain Φ'_4 in the next subsection. The results in this subsection are established in [7]. As was the case in section 4, our explanation is more transparent than the original one because of the use of half-open intervals.

Construction 5.6 (See also Problem. 9 in [7]). We construct Φ_1 . By the definition of shifted Gelfand-Tsetlin patterns and by applying Example 2.10, we have

$$\begin{aligned} \bigsqcup_{\mu \in \text{AR}_n} \bigsqcup_{\mathbf{l} \in \mu(\mathbf{k})} \text{SGT}(\mathbf{l}) &= \bigsqcup_{\mu \in \text{AR}_n} \bigsqcup_{\mathbf{l} \in \mu(\mathbf{k})} \bigsqcup_{T \in \text{AP}_{n-1}} \text{GT}(T(\mathbf{l})) \\ &= \bigsqcup_{\mu \in \text{AR}_n} \bigsqcup_{T \in \text{AP}_{n-1}} \bigsqcup_{\mathbf{l} \in \mu(\mathbf{k})} \text{GT}(T(\mathbf{l})) \\ &= \bigsqcup_{\mu \in \text{AR}_n} \bigsqcup_{T \in \text{AP}_{n-1}} \bigsqcup_{\mathbf{l}' \in \bigsqcup_{\mathbf{l} \in \mu(\mathbf{k})} (\{T(\mathbf{l})\}, \emptyset)} \text{GT}(\mathbf{l}'). \end{aligned}$$

Since

$$\begin{aligned} \bigsqcup_{\mathbf{l} \in \mu(\mathbf{k})} (\{T(\mathbf{l})\}, \emptyset) &= \underline{[k_1 + \delta_{\nearrow}(\mu_1) + c_1(T), k_2 - \delta_{\searrow}(\mu_2) + c_1(T)]} \\ &\quad \times \cdots \times \underline{[k_{n-1} + \delta_{\nearrow}(\mu_{n-1}) + c_{n-1}(T), k_n - \delta_{\searrow}(\mu_n) + c_{n-1}(T)]}, \end{aligned}$$

using ρ from Construction 4.2, we obtain the construction. \square

Construction 5.7 (See also Problem. 9 in [7]). We construct Φ'_3 . Here, we have

$$\begin{aligned} \bigsqcup_{\mu \in \text{AR}_n} \bigsqcup_{T \in \text{AP}_{n-1}} \bigsqcup_{\mathbf{m} \in S_1 \times S_2 \times \cdots \times S_{n-1}} \text{GT}(m_1 + c_1(T), m_2 + c_2(T), \dots, m_{n-1} + c_{n-1}(T), x) \\ = \bigsqcup_{\mu \in \text{AR}_n} \bigsqcup_{T \in \text{AP}_{n-1}} \bigsqcup_{\omega \in \Omega^{n-1}} \text{GT}(m_1(\mu, T, \omega_1), m_2(\mu, T, \omega_2), \dots, m_{n-1}(\mu, T, \omega_{n-1}), x) \\ = \bigsqcup_{\omega \in \Omega^{n-1}} \bigsqcup_{\mu \in \text{AR}_n} \bigsqcup_{T \in \text{AP}_{n-1}} \text{GT}(m_1(\mu, T, \omega_1), m_2(\mu, T, \omega_2), \dots, m_{n-1}(\mu, T, \omega_{n-1}), x). \end{aligned}$$

For $1 \leq i \leq n$, we define $\omega^{(i)} \in \text{supp}(\Omega^{n-1})$ by $\omega_j^{(i)} = \begin{cases} 0 & j < i \\ 1 & j \geq i \end{cases}$. Note that its sign as an element of Ω^{n-1} is $(-1)^{(n-i)}$. Let $\Omega_1 = (\{\omega_n, \omega_{n-2}, \dots\}, \{\omega_{n-1}, \omega_{n-3}, \dots\})$, where $\text{supp}(\Omega_1) = \{\omega_1, \omega_2, \dots, \omega_n\}$. Furthermore, we define Ω_2 by $\Omega_2^\pm = (\Omega^{n-1})^\pm \setminus \Omega_1^\pm$. Then, using π from Construction 4.3, we have

$$\begin{aligned} \bigsqcup_{\omega \in \Omega_1} \bigsqcup_{\mu \in \text{AR}_n} \bigsqcup_{T \in \text{AP}_{n-1}} \text{GT}(m_1(\mu, T, \omega_1), m_2(\mu, T, \omega_2), \dots, m_{n-1}(\mu, T, \omega_{n-1}), x) \\ = \bigsqcup_{i=1}^n \bigsqcup_{\mu \in \text{AR}_n} \bigsqcup_{T \in \text{AP}_{n-1}} (-1)^{(n-i)} \text{GT}(m_1(\mu, T, 0), \dots, m_{i-1}(\mu, T, 0), \\ m_i(\mu, T, 1), \dots, m_{n-1}(\mu, T, 1), x) \\ \overset{\pi}{\circlearrowright} \bigsqcup_{i=1}^n \bigsqcup_{\mu \in \text{AR}_n} \bigsqcup_{T \in \text{AP}_{n-1}} \text{GT}(m_1(\mu, T, 0), \dots, m_{i-1}(\mu, T, 0), x, m_i(\mu, T, 1), \dots, m_{n-1}(\mu, T, 1)). \end{aligned}$$

It is therefore sufficient to construct

$$\bigsqcup_{\omega \in \Omega_2} \bigsqcup_{\mu \in \text{AR}_n} \bigsqcup_{T \in \text{AP}_{n-1}} \text{GT}(m_1(\mu, T, \omega_1), m_2(\mu, T, \omega_2), \dots, m_{n-1}(\mu, T, \omega_{n-1}), x) \circlearrowright (\emptyset, \emptyset).$$

If we fix $\omega \in \overset{\circ}{\Omega}_2$ then, by the definition of Ω_2 , there is a minimum index $i \leq n-2$ such that $\omega_i = 1$ and $\omega_{i+1} = 0$. We define an involution on $\text{AR}_n \times \text{AP}_{n-1}$: $(\mu, T) \leftrightarrow (\mu', T')$ as follows:

- For $1 \leq j \leq i-1$, swap $t_{j,i}$ and $t_{j,i+1}$. Namely, $(t'_{j,i}, t'_{j,i+1}) = (t_{j,i+1}, t_{j,i})$.
- For $i+2 \leq j \leq n$, swap $t_{i,j}$ and $t_{i+1,j}$. Namely, $(t'_{i,j}, t'_{i+1,j}) = (t_{i+1,j}, t_{i,j})$.
- Let $t'_{i,i+1} = r(\mu_{i+1})$ and $\mu'_{i+1} = r(t_{i,i+1})$.
- Other elements are left unchanged.

For example, when $n = 5$ and $i = 2$ the involution can be illustrated as

$$\begin{array}{cccccc}
 & & & & & t_{1,5} \\
 & & & & & \swarrow \\
 & & & & t_{1,4} & t_{2,5} \\
 & & & & \swarrow & \swarrow \\
 & & & t_{1,3} & t_{2,4} & t_{3,5} \\
 & & \swarrow & \swarrow & \swarrow & \swarrow \\
 & t_{1,2} & t_{2,3} & t_{3,4} & t_{4,5} & \\
 & \swarrow & \updownarrow & \swarrow & & \\
 \mu_1 & \mu_2 & \mu_3 & \mu_4 & \mu_5 & .
 \end{array}$$

Then, we have

$$\begin{aligned}
 m_i(\mu, T, 1) &= k_{i+1} - \delta_{\swarrow}(\mu_{i+1}) + c_i(T) = k_{i+1} + \delta_{\swarrow}(\mu'_{i+1}) + c_{i+1}(T') = m_{i+1}(\mu', T', 0), \\
 m_{i+1}(\mu, T, 0) &= k_{i+1} + \delta_{\swarrow}(\mu_{i+1}) + c_{i+1}(T) = k_{i+1} - \delta_{\swarrow}(\mu'_{i+1}) + c_i(T') = m_i(\mu', T', 1),
 \end{aligned}$$

and since the involution acts on (μ, T) as permuting elements it preserves the sign. Therefore, from Construction 4.3, we have

$$\begin{aligned}
 &\text{GT}(m_1(\mu, T, \omega_1), m_2(\mu, T, \omega_2), \dots, m_{n-1}(\mu, T, \omega_{n-1}), x) \\
 &\quad \circ \cong \text{GT}(m_1(\mu', T', \omega_1), m_2(\mu', T', \omega_2), \dots, m_{n-1}(\mu', T', \omega_{n-1}), x).
 \end{aligned}$$

This completes the construction. \square

5.4 A more natural sijection $\text{GMT}(\mathbf{k}) \circ \cong \text{SGT}(\mathbf{k})$

In this section we construct Φ'_4 to complete the construction of the sijection between $\text{GMT}(\mathbf{k})$ and $\text{SGT}(\mathbf{k})$. After that, we prove its compatibility with the top and the inversion number statistics.

Construction 5.8. We shall construct Φ'_4 . First, we construct a bijection $\text{supp}(\text{AR}_n) \times \text{supp}(\text{AP}_{n-1}) \rightarrow \text{supp}(\text{AR}_1) \times \text{supp}(\text{AP}_n)$; $(\mu, T) \mapsto (\mu', T')$ as follows (cf. [7, Problem. 8]):

$$t'_{p,q} = \begin{cases} t_{p,q} & p < q < i \\ t_{p,q-1} & p < i < q \\ t_{p-1,q-1} & i < p < q \\ r(\mu_p) & p < i = q \\ r(\mu_q) & p = i < q \end{cases}$$

$$\mu'_1 = \mu_i.$$

For example, when $n = 5$ and $i = 3$ we have

$$\mu' = (\mu_3), \quad T' = \begin{array}{cccc} & & t_{1,4} & \\ & & t_{1,3} & t_{2,4} \\ & r(\mu_1) & t_{2,3} & r(\mu_5) \\ t_{1,2} & r(\mu_2) & r(\mu_4) & t_{3,4} \end{array}.$$

Since this bijection only rearranges and reverses arrows, it preserves the sign. Therefore, it can be recognized as a sijection $\text{AR}_n \times \text{AP}_{n-1} \overset{\circ}{\rightsquigarrow} \text{AR}_1 \times \text{AP}_n$. In addition we have a sijection $\varphi_{\text{AR}_1}: \text{AR}_1 \overset{\circ}{\rightsquigarrow} (\{\cdot\}, \emptyset)$ defined by

$$\varphi_{\text{AR}_1}: \quad \text{AR}_1 \quad \overset{\circ}{\rightsquigarrow} \quad (\{\cdot\}, \emptyset)$$

$$+ \quad \begin{array}{c} \circlearrowleft \\ \circlearrowright \end{array}$$

$$- \quad \begin{array}{c} \circlearrowleft \\ \circlearrowright \end{array}$$

so we get a sijection $\Psi_{n,i}: \text{AR}_n \times \text{AP}_{n-1} \overset{\circ}{\rightsquigarrow} \text{AP}_n$ such that

$$\begin{aligned} m_j(\mu, T, 0) &= k_j + c_j(\Psi_{n,i}(\mu, T)) && \text{if } j < i, \\ m_j(\mu, T, 1) &= k_{j+1} + c_{j+1}(\Psi_{n,i}(\mu, T)) && \text{if } j \geq i. \end{aligned}$$

By applying this result and Definition 2.8, we have

$$\begin{aligned} &\bigsqcup_{i=1}^n \bigsqcup_{\mu \in \text{AR}_n} \bigsqcup_{T \in \text{AP}_{n-1}} \text{GT}(m_1(\mu, T, 0), \dots, m_{i-1}(\mu, T, 0), x, m_i(\mu, T, 1), \dots, m_{n-1}(\mu, T, 1)) \\ &\overset{\circ}{\rightsquigarrow} \bigsqcup_{i=1}^n \bigsqcup_{T \in \text{AP}_n} \text{GT}(k_1 + c_1(T), \dots, k_{i-1} + c_{i-1}(T), x, k_{i+1} + c_{i+1}(T), \dots, k_n + c_n(T)). \end{aligned}$$

Then, using Example 2.10 and τ in Construction 4.4, we have

$$\begin{aligned} &\bigsqcup_{i=1}^n \bigsqcup_{T \in \text{AP}_n} \text{GT}(k_1 + c_1(T), \dots, k_{i-1} + c_{i-1}(T), x, k_{i+1} + c_{i+1}(T), \dots, k_n + c_n(T)) \\ &= \bigsqcup_{T \in \text{AP}_n} \bigsqcup_{i=1}^n \text{GT}(k_1 + c_1(T), \dots, k_{i-1} + c_{i-1}(T), x, k_{i+1} + c_{i+1}(T), \dots, k_n + c_n(T)) \\ &\overset{\circ}{\rightsquigarrow} \bigsqcup_{T \in \text{AP}_n} \text{GT}(k_1 + c_1(T), k_2 + c_2(T), \dots, k_n + c_n(T)) = \text{SGT}(\mathbf{k}), \end{aligned}$$

which completes the construction. \square

Finally, we obtain the desired sijection.

Construction 5.9. We construct a sijection $\Gamma: \text{GMT}(\mathbf{k}) \rightsquigarrow \text{SGT}(\mathbf{k})$ for any $\mathbf{k} \in \mathbb{Z}^n$, $n \in \mathbb{Z}$. When $n = 1$, $\text{GMT}(\mathbf{k}) = \text{AR}_1$ and $\text{SGT}(\mathbf{k}) = (\{k_1\}, \emptyset)$. Therefore, the construction is given as:

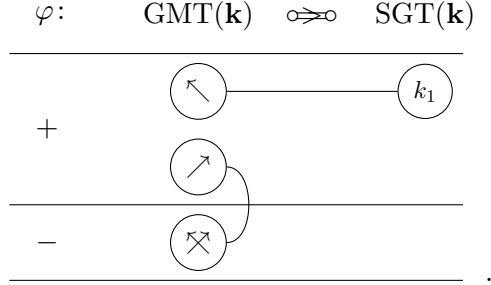

When $n > 1$, the construction is given by induction on n :

$$\text{GMT}(\mathbf{k}) = \bigsqcup_{\mu \in \text{AR}_n} \bigsqcup_{\mathbf{l} \in \mu(\mathbf{k})} \text{GMT}(\mathbf{l}) \rightsquigarrow \bigsqcup_{\mu \in \text{AR}_n} \bigsqcup_{\mathbf{l} \in \mu(\mathbf{k})} \text{SGT}(\mathbf{l}) \xrightarrow{\Phi'} \text{SGT}(\mathbf{k}),$$

where $\Phi' = \Phi'_4 \circ \Phi'_3 \circ \Phi_1$. \square

Last, we check the compatibility of the sijection Γ .

Proposition 5.10. *The sijection Γ in Construction 4.4.1 is compatible with the two statistics η_{top} and η_{inv} . In particular, it is compatible with the statistic $(\eta_{\text{top}}, \eta_{\text{inv}})$.*

Proof. When $n = 1$, this is trivial. In the following, we assume that $n > 1$. First, we define the statistics for the intermediates. For $(T, \mathbf{l}, \mu) \in \bigsqcup_{\mu \in \text{AR}_n} \bigsqcup_{\mathbf{l} \in \mu(\mathbf{k})} \text{GMT}(\mathbf{l})$, we define

$$\begin{aligned} \eta_{\text{top}}((T, \mathbf{l}, \mu)) &= \eta_{\text{top}}(T), \\ \eta_{\text{inv}}((T, \mathbf{l}, \mu)) &= \eta_{\text{inv}}(T) + \eta_{\text{inv}}(\mu), \end{aligned}$$

and for $(T, \mathbf{l}, \mu) \in \bigsqcup_{\mu \in \text{AR}_n} \bigsqcup_{\mathbf{l} \in \mu(\mathbf{k})} \text{SGT}(\mathbf{l})$, we define

$$\begin{aligned} \eta_{\text{top}}((T, \mathbf{l}, \mu)) &= \eta_{\text{top}}(T), \\ \eta_{\text{inv}}((T, \mathbf{l}, \mu)) &= \eta_{\text{inv}}(T) + \eta_{\text{inv}}(\mu). \end{aligned}$$

The trivial sijection $\text{GMT}(\mathbf{k}) = \bigsqcup_{\mu \in \text{AR}_n} \bigsqcup_{\mathbf{l} \in \mu(\mathbf{k})} \text{GMT}(\mathbf{l})$ is compatible with these statistics and the compatibility of the second sijection follows from the cases for smaller n . Therefore, it is sufficient to check the compatibility of Φ' .

- Φ_1 : The compatibility with η_{top} follows from the compatibility of ρ (Proposition 4.14). The sijection does not act on arrows, and hence it is compatible with inversion numbers.
- Φ'_3 : The compatibility with η_{top} follows from the compatibility of π (Proposition 4.15). The sijection acts on arrows as reversing and permuting, and hence it is compatible with inversion numbers.

- Φ'_4 : The compatibility with η_{top} follows from the compatibility of id_{GT} and τ (Proposition 4.16). The sijection acts on arrows as a permutation except for the actions of φ_{AR_1} . Since the actions of φ_{AR_1} do not affect the inversion number, the sijection is compatible with it.

According to Lemma 3.2, the compatibility of $\Phi' = \Phi'_4 \circ \Phi'_3 \circ \Phi_1$ follows from the above. \square

Remark. *One of the advantages of proving refined enumerations with compatibility appears in the way one proves doubly-refined enumerations. If a sijection is compatible with two statistics η_A and η_B then it is also compatible with the pair statistic (η_A, η_B) . In general, however, the result of doubly-refined enumeration with respect to (η_A, η_B) does not follow immediately from the results of refined enumeration with respect to each of η_A and η_B separately.*

5.5 About the choice of the parameter x in the construction

Fischer and Konvalinka's construction as well as ours depends on a parameter x which, in fact, can be made to depend on the other parameters in each sijection that appears in the construction, by induction, notably on \mathbf{k} . Here we show that there exists a choice of x that has particularly nice properties at the level of the sijections. We discuss how to choose the parameter in this subsection. In particular we prove the following proposition.

Proposition 5.11. *Let $\mathbf{k} \in \mathbb{Z}^n$. Then, there exist $X_+, X_- \in \mathbb{Z}$ such that*

$$\begin{aligned} \forall x \geq X_+, \Gamma_{\mathbf{k},x} &= \Gamma_{\mathbf{k},X_+}, \\ \forall x \leq X_-, \Gamma_{\mathbf{k},x} &= \Gamma_{\mathbf{k},X_-}, \end{aligned}$$

where $\Gamma_{\mathbf{k},x}: \text{GMT}(\mathbf{k}) \rightleftarrows \text{SGT}(\mathbf{k})$ is the sijection constructed in Construction 4.4.1.

According to the proposition, we define $\Gamma_{\mathbf{k},\pm\infty} = \Gamma_{\mathbf{k},X_{\pm}}$. Note that X_{\pm} depend on \mathbf{k} . Let $f_t: \mathbb{Z} \rightarrow \mathbb{Z}; k \mapsto k+1$ be a translation. The definition of f_t is extended to \mathbf{Z}^n , GMT and SGT in a natural way. The choice of parameters in $\Gamma_{\mathbf{k},\pm\infty}$ is good in the sense that it satisfies

$$f_t \circ \Gamma_{\mathbf{k},\pm\infty} = \Gamma_{f_t(\mathbf{k}),\pm\infty} \circ f_t.$$

The rest of this subsection is devoted to prove the proposition and the above relation. First we define inclusion relations of signed sets and sijections. Let S and T be signed sets. We say S is included in T and denote it by $S \subset T$ if $S^+ \subset T^+$ and $S^- \subset T^-$ hold. Let $\varphi_i: S_i \rightleftarrows T_i$ ($i = 1, 2$) be sijections. We say φ_1 is included in φ_2 and denote it by $\varphi_1 \subset \varphi_2$ if all of the following conditions are met:

$$S_1 \subset S_2, \quad T_1 \subset T_2, \quad \forall s \in \text{supp}(S_1 \sqcup T_1), \varphi_1(s) = \varphi_2(s).$$

We also define the difference of signed sets and sijections as follows:

- When $S \subset T$, the signed set $T \setminus S$ is $(T^+ \setminus S^+, T^- \setminus S^-)$.
- When $\varphi_i: S_i \rightleftarrows T_i$ ($i = 1, 2$) meet $\varphi_1 \subset \varphi_2$, the sijection $\varphi_2 \setminus \varphi_1: S_2 \setminus S_1 \rightleftarrows T_2 \setminus T_1$ is a restriction of φ_2 .

Then, we have $S \sqcup (T \setminus S) = T$ and $\varphi_2 = \varphi_1 \sqcup (\varphi_2 \setminus \varphi_1)$. The converse is also true. Namely, we have $S \subset S \sqcup T$ and $(S \sqcup T) \setminus S = T$ for any signed sets S and T and $\varphi \subset \varphi \sqcup \psi$ and $(\varphi \sqcup \psi) \setminus \varphi = \psi$ for any sijections φ and ψ . In particular, when $\varphi_i: S_i \twoheadrightarrow T_i$, $\psi_i: T_i \twoheadrightarrow U_i$, ($i = 1, 2$) satisfy $\varphi_1 \subset \varphi_2$, $\psi_1 \subset \psi_2$, we have

$$\psi_2 \circ \varphi_2 = (\psi_1 \sqcup (\psi_2 \setminus \psi_1)) \circ (\varphi_1 \sqcup (\varphi_2 \setminus \varphi_1)) = (\psi_1 \circ \varphi_1) \sqcup ((\psi_2 \setminus \psi_1) \circ (\varphi_2 \setminus \varphi_1)).$$

Therefore, we have $\psi_1 \circ \varphi_1 \subset \psi_2 \circ \varphi_2$. Particularly, if $S_1 = S_2$ and $T_1 = T_2$, then $\psi_1 \circ \varphi_1 = \psi_2 \circ \varphi_2$.

Let $\{\varphi_x\}_{x \in \mathbb{Z}}$ be a sequence of sijections. We say $\{\varphi_x\}_{x \in \mathbb{Z}}$ makes a *chain* in $x \geq X$, when

$$\varphi_X \subset \varphi_{X+1} \subset \varphi_{X+2} \subset \cdots.$$

Similarly, we say $\{\varphi_x\}_{x \in \mathbb{Z}}$ makes a chain in $x \leq X$, when

$$\varphi_X \subset \varphi_{X-1} \subset \varphi_{X-2} \subset \cdots.$$

Proposition 5.12. *Let a, b, x be integers and $\varphi_x: [a, b] \twoheadrightarrow [a, x] \sqcup [x, b]$ the sijection constructed in Example 2.2. Then, $\{\varphi_x\}_{x \in \mathbb{Z}}$ makes a chain in $x \geq \max(a, b)$ and in $x \leq \min(a, b)$.*

Proof. For $x \geq \max(a, b)$, we have $\varphi_{x+1} = \varphi_x \sqcup \psi_x$, where ψ_x is the unique sijection between (\emptyset, \emptyset) and $(\{x\}, \{x\})$. Therefore, $\{\varphi_x\}_{x \in \mathbb{Z}}$ makes a chain in $x \geq \max(a, b)$. We can prove the case $x \leq \min(a, b)$ similarly. \square

We prepare some lemmas to prove Proposition 5.11.

Lemma 5.13. *Let S and T be signed sets such that $S \subset T$. Then, we have $id_S \subset id_T$. In addition, let $\varphi_S: S \sqcup -S \twoheadrightarrow (\emptyset, \emptyset)$ be the sijection induced by id_S as in Construction 2.3. We define φ_T similarly. Then, we have $\varphi_S \subset \varphi_T$.*

Proof. The proof follows immediately from the definitions. \square

Lemma 5.14. *Let $\varphi_i: S_i \twoheadrightarrow T_i$ be sijections for $i = 1, 2$ and $\psi: U \twoheadrightarrow V$ a sijection. Then, we have*

$$\varphi_1 \subset \varphi_2 \Rightarrow \psi \sqcup \varphi_1 \subset \psi \sqcup \varphi_2.$$

and

$$\varphi_1 \subset \varphi_2 \Rightarrow \psi \times \varphi_1 \subset \psi \times \varphi_2.$$

Proof. The proof follows immediately from the definitions. \square

When $\varphi_i: S_i \twoheadrightarrow T_i$ and $\psi_i: U_i \twoheadrightarrow V_i$ are sijections for $i = 1, 2$ such that $\varphi_1 \subset \varphi_2$ and $\psi_1 \subset \psi_2$, then we have from this lemma that

$$\psi_1 \times \varphi_1 \subset \psi_1 \times \varphi_2 \subset \psi_2 \times \varphi_2.$$

Furthermore, for a disjoint union with signed index, the following lemma holds.

Lemma 5.15. *Let $\psi_i: T_i \twoheadrightarrow \tilde{T}_i$ be sijections for $i \in \mathbb{Z}$ such that $\psi_1 \subset \psi_2 \subset \cdots$. Also, for $S = \bigcup_{i=1}^{\infty} (T_i^+) \sqcup \bigcup_{i=1}^{\infty} (\tilde{T}_i^-)$, let $\{\varphi_s: U_s \twoheadrightarrow V_s\}_{s \in S}$ be a family of sijections. Then we have*

$$\bigsqcup_{t \in T_1 \sqcup \tilde{T}_1} \varphi_t \subset \bigsqcup_{t \in T_2 \sqcup \tilde{T}_2} \varphi_t \subset \cdots.$$

Proof. The proof follows immediately from the definitions. \square

Proof of Proposition 5.11. The following claims can be checked by tracing the corresponding construction.

1. The sijection β in Subconstruction 4.2.1 makes a chain in $x \geq \max(a_n, b_n)$ and in $x \leq \min(a_n, b_n)$. This follows from Proposition 5.12, Lemma 5.14 and the induction.
2. The sijection ρ in Construction 4.2 makes a chain in $x \geq \max(a_n, b_n)$ and in $x \leq \min(a_n, b_n)$. This follows from the property of β and Lemma 5.15.
3. The sijection π in Construction 4.3 makes a chain in $k_j \geq \max(k_1, k_2, \dots, k_{j-1}, k_{j+1}, \dots, k_n)$ and in $k_j \leq \min(k_1, k_2, \dots, k_{j-1}, k_{j+1}, \dots, k_n)$ for $j \in \{1, 2, \dots, n\}$. Also, the sijection σ in Construction 4.3 makes a chain in $a_j \geq b_j$, in $a_j \leq b_j$, in $b_j \geq a_j$ and in $b_j \leq a_j$ for $j \in \{1, 2, \dots, i-1, i+2, \dots, n\}$. Furthermore, let $\mathbf{a}' = (a_1, a_2, \dots, a_{i-1}, x, x, a_{i+2}, \dots, a_n)$ and $\mathbf{b}' = (b_1, b_2, \dots, b_{i-1}, x, x, b_{i+2}, \dots, b_n)$. Then, $\sigma_{\mathbf{a}', \mathbf{b}', x}$ makes a chain in $x \geq \max(b_i, b_{i+1})$ and in $x \leq \min(b_i, b_{i+1})$ and $\sigma_{\mathbf{a}, \mathbf{b}', x}$ makes a chain in $x \geq \max(a_i, a_{i+1})$ and in $x \leq \min(a_i, a_{i+1})$. These properties of σ_n follow from Lemma 5.13 and the property of π_n and the property of π_n follows from those of σ_{n-1} . Therefore the proof of these properties is given by induction.
4. The sijection γ in Subconstruction 4.4.1 makes a chain in $x \geq \max(\mathbf{k})$ and in $x \leq \min(\mathbf{k})$. This follows from the lemmas.
5. The sijection τ in Subconstruction 4.4 makes a chain in $x \geq \max(\mathbf{k})$ and in $x \leq \min(\mathbf{k})$. This follows from the properties of γ and σ .
6. The sijection Φ_1 in Construction 5.6 makes a chain in $x \geq \max(\mathbf{k}) + n$ and in $x \leq \min(\mathbf{k}) - n$. This follows from the property ρ .
7. The sijection Φ'_3 in Construction 5.7 makes a chain in $x \geq \max(\mathbf{k}) + n$ and in $x \leq \min(\mathbf{k}) - n$. This follows from the property of π .
8. The sijection Φ'_4 in Construction 5.8 makes a chain in $x \geq \max(\mathbf{k}) + n$ and in $x \leq \min(\mathbf{k}) - n$. This follows from the Lemma 5.15 and the property of τ .
9. The sijection $\Phi' = \Phi'_4 \circ \Phi'_3 \circ \Phi_1$ makes a chain in $x \geq \max(\mathbf{k}) + n$ and in $x \leq \min(\mathbf{k}) - n$. This follows from the properties of Φ_1 , Φ'_3 and Φ'_4 .
10. The sijection Γ in Construction 5.9 makes a chain in $x \geq \max(\mathbf{k}) + n$ and in $x \leq \min(\mathbf{k}) - n$. This follows from the property of Φ' .

Since the domain and codomain of Γ ($\text{GMT}(\mathbf{k})$ and $\text{SGT}(\mathbf{k})$) are independent of the parameter x , we have

$$\begin{aligned} \Gamma_{X_+} &= \Gamma_{X_++1} = \Gamma_{X_++2} = \dots, & \text{where } X_+ &= \max(\mathbf{k}) + n, \\ \Gamma_{X_-} &= \Gamma_{X_- - 1} = \Gamma_{X_- - 2} = \dots, & \text{where } X_- &= \min(\mathbf{k}) - n. \end{aligned}$$

\square

Last, we check the property of $\Phi_{\pm\infty}$ with respect to translations:

$$f_t \circ \Gamma_{\mathbf{k}, \pm\infty} = \Gamma_{f_t(\mathbf{k}), \pm\infty} \circ f_t.$$

By the constructions, we have

$$f_t \circ \Gamma_{\mathbf{k}, x} = \Gamma_{f_t(\mathbf{k}), f_t(x)} \circ f_t.$$

Considering a parameter $x \geq \max(X_+(\mathbf{k}), X_+(f_t(\mathbf{k})))$, we have

$$f_t \circ \Gamma_{\mathbf{k}, +\infty} = \Gamma_{f_t(\mathbf{k}), +\infty} \circ f_t.$$

We can prove a similar result for $-\infty$.

5.6 A natural sijection $\text{GMT}(\mathbf{k}) \overset{\circ}{\rightsquigarrow} \text{AR}_n \times \text{SGT}(\mathbf{k})$

In this subsection, we start with the weighted enumeration formula of a variant of monotone triangles, which is proved in [9]. From this formula, we construct a sijection that is compatible with $n + 3$ statistics between $\text{GMT}(\mathbf{k})$ and $\text{AR}_n \times \text{SGT}(\mathbf{k})$. This serves as a good example of transforming a non-constructive proof for a weighted enumeration formula into a constructive one using the concept of compatibility. First, to align with the terms of [9], we will slightly modify the definitions of the combinatorial objects introduced so far.

- Let $\text{AR}_n = (\{\nwarrow, \nearrow, \nearrow\!\!\!\diagup\}, \emptyset)^n$. The action of an element of AR_n on $\mathbf{k} \in \mathbb{Z}^n$ is defined as before. The definition of Generalized monotone triangles is also modified accordingly.
- Let $\text{AP}_n = (\{\searrow, \swarrow, \swarrow\!\!\!\diagdown\}, \emptyset)^{n-1} \times (\{\searrow, \swarrow, \swarrow\!\!\!\diagdown\}, \emptyset)^{n-2} \times \cdots \times (\{\searrow, \swarrow, \swarrow\!\!\!\diagdown\}, \emptyset)^1$. The action of an element of AP_n on $\mathbf{k} \in \mathbb{Z}^n$ is defined as before. The definition of Shifted Gelfand-Tsetlin patterns is also modified accordingly.

This modification just changes the signs of $\nearrow\!\!\!\diagup$ and $\swarrow\!\!\!\diagdown$. Therefore, except for the parts involving cancellations with $\nearrow \leftrightarrow \nearrow\!\!\!\diagup$ and $\swarrow \leftrightarrow \swarrow\!\!\!\diagdown$, the constructions of the sijection described thus far remain unaffected. In [9], weighted enumerations of several variants of monotone triangles are provided. When rewritten in accordance with the definitions and terminology of this paper, we obtain the following result for the weighted enumeration of generalized monotone triangles. Here, the weighted enumeration of a signed set S is defined as:

$$\sum_{s \in S^+} \text{weight}(s) + \sum_{s \in S^-} \text{weight}(s).$$

Theorem 5.16 (Theorem 2.2 and 3.2 in [9]). *For $T = (\mathbf{k}^{(n)}, \mu^{(n)}, \mathbf{k}^{(n-1)}, \mu^{(n-1)}, \dots, \mathbf{k}^{(1)}, \mu^{(1)}) \overset{\circ}{\in} \text{GMT}(\mathbf{k})$, we define its weight as follows:*

- Let $\eta_u(T)$, $\eta_v(T)$ and $\eta_w(T)$ be the number of \nearrow , \nwarrow and $\nearrow\!\!\!\diagup$ respectively in $\mu^{(1)}, \mu^{(2)}, \dots, \mu^{(n)}$.
- Let $\eta_{X_i}(T) = \sum \mathbf{k}^{(i)} - \sum \mathbf{k}^{(i-1)} + (\# \text{ of } \nearrow \text{ in } \mu^{(i)}) - (\# \text{ of } \nwarrow \text{ in } \mu^{(i)})$, where $\sum \mathbf{k}^{(i)}$ means the summation of entries of $\mathbf{k}^{(i)}$ and we define $\sum \mathbf{k}^{(0)} = 0$.
- Then, the weight of T is $u^{\eta_u(T)} v^{\eta_v(T)} w^{\eta_w(T)} X_i^{\eta_{X_i}(T)}$.

As a result, the weighted enumeration of generalized monotone triangles with bottom row \mathbf{k} is

$$\prod_{i=1}^n (uX_i + vX_i^{-1} + w) \prod_{1 \leq p < q \leq n} (uE_{k_p} + vE_{k_q}^{-1} + wE_{k_p}E_{k_q}^{-1}) \tilde{s}_{(k_n, k_{n-1}, \dots, k_1)}(X_1, X_2, \dots, X_n),$$

where E_x is a shift operator such that $E_x p(x) = p(x+1)$ and $\tilde{s}_{(k_n, k_{n-1}, \dots, k_1)}$ is a transformed Schur polynomial.

The relation between the transformed Schur polynomial \tilde{s} and the extended Schur polynomial s defined in [9] is

$$\tilde{s}_{(k_n, k_{n-1}, \dots, k_1)} = s_{(k_n - (n-1), k_{n-1} - (n-2), \dots, k_1 - 0)}.$$

This difference is the result of our change in convention from closed intervals to half-open ones. For the definition of extended Schur polynomials, which we omit here as it is not necessary for this paper, please see [9]. What is important in this paper is that $\tilde{s}_{(k_n, k_{n-1}, \dots, k_1)}(X_1, X_2, \dots, X_n)$ is the weighted enumeration of $\text{GT}(\mathbf{k})$ with appropriate weight. In fact, for $A \in \text{GT}(\mathbf{k})$ we define $\sum_i(A) = \sum \eta_{\text{row}(A)_i}$, which means that $\sum_i(A)$ is the sum of elements in the i -th row when considering A as a triangular array. Then, we can assign the weight as $\text{weight}(A) = X_i^{\eta_{X_i}(A)}$, where $\eta_{X_i}(A) = \sum_i(A) - \sum_{i-1}(A)$. Based on the observation and the definition of the shift operator, the part of $\prod_{1 \leq p < q \leq n} (uE_{k_p} + vE_{k_q}^{-1} + wE_{k_p}E_{k_q}^{-1}) \tilde{s}_{(k_n, k_{n-1}, \dots, k_1)}(X_1, X_2, \dots, X_n)$ in the weighted enumeration of $\text{GMT}(\mathbf{k})$ is identified with a weighted enumeration of $\text{SGT}(\mathbf{k})$ with appropriate weight. Furthermore, the remaining part is recognized as a weighted enumeration of AR_n with appropriate weight. To summarize the above discussion, the following corollary can be obtained.

Corollary 5.17. *There exists a bijection $\text{GMT}(\mathbf{k}) \xrightarrow{\circ} \text{AR}_n \times \text{SGT}(\mathbf{k})$ which is compatible with the following $n+3$ statistics $\eta_u, \eta_v, \eta_w, \eta_{X_1}, \eta_{X_2}, \dots, \eta_{X_n}$:*

- For GMT side, the definitions of statistics are the same in Theorem 5.16.
- For $(\mu, (A, T)) \in \text{AR}_n \times \text{SGT}(\mathbf{k})$, where $A \in \text{GT}(T(\mathbf{k}))$, we define its statistics as follows:

$$\begin{aligned} \eta_u((\mu, (A, T))) &= (\# \text{ of } \nearrow \text{ in } \mu) + (\# \text{ of } \swarrow \text{ in } T), \\ \eta_v((\mu, (A, T))) &= (\# \text{ of } \nwarrow \text{ in } \mu) + (\# \text{ of } \searrow \text{ in } T), \\ \eta_w((\mu, (A, T))) &= (\# \text{ of } \nearrow \searrow \text{ in } \mu) + (\# \text{ of } \nwarrow \swarrow \text{ in } T), \\ \eta_{X_i}((\mu, (A, T))) &= \eta_{X_i}(A) + \delta_{\nearrow}(\mu_i) - \delta_{\nwarrow}(\mu_i). \end{aligned}$$

The rest of this subsection is devoted to actually constructing this bijection.

Construction 5.18. We shall construct a bijection which satisfies the conditions described in Corollary 5.17. The construction is by induction on n . If $n = 1$, it is trivial since we have

$\text{GMT}(\mathbf{k}) = \text{AR}_1$ and $\text{SGT}(\mathbf{k}) = \text{GT}(\mathbf{k}) = (\{k\}, \emptyset)$. If $n > 1$, it is given as follows:

$$\begin{aligned}
\text{GMT}(\mathbf{k}) &= \bigsqcup_{\mu \in \text{AR}_n} \bigsqcup_{l \in \mu(\mathbf{k})} \text{GMT}(\mathbf{l}) \\
&\xrightarrow{\cong} \bigsqcup_{\mu \in \text{AR}_n} \bigsqcup_{l \in \mu(\mathbf{k})} (\text{AR}_{n-1} \times \text{SGT}(\mathbf{l})) \\
&= \text{AR}_{n-1} \times \bigsqcup_{\mu \in \text{AR}_n} \bigsqcup_{l \in \mu(\mathbf{k})} \text{SGT}(\mathbf{l}) \\
&\xrightarrow{\text{id}_{\text{AR}_{n-1}} \times \Phi_1} \text{AR}_{n-1} \times \bigsqcup_{\mu \in \text{AR}_n} \bigsqcup_{T \in \text{AP}_{n-1}} \bigsqcup_{\mathbf{m} \in S_1 \times S_2 \times \dots \times S_{n-1}} \\
&\quad \text{GT}(m_1 + c_1(T), m_2 + c_2(T), \dots, m_{n-1} + c_{n-1}(T), x) \\
&\xrightarrow{\text{id}_{\text{AR}_{n-1}} \times \Phi'_3} \text{AR}_{n-1} \times \bigsqcup_{i=1}^n \bigsqcup_{\mu \in \text{AR}_n} \bigsqcup_{T \in \text{AP}_{n-1}} \\
&\quad \text{GT}(m_1(\mu, T, 0), \dots, m_{i-1}(\mu, T, 0), x, m_i(\mu, T, 1), \dots, m_{n-1}(\mu, T, 1)) \\
&\xrightarrow{\Phi''_4} \text{AR}_{n-1} \times \text{AR}_1 \times \text{SGT}(\mathbf{k}) \\
&= \text{AR}_n \times \text{SGT}(\mathbf{k}),
\end{aligned}$$

where the assumption of induction is used in the second line. For the definition of Φ_1 , Φ'_3 , S_i and m_i , refer to the Subsection 5.3. In fact, as the constructions of Φ_1 and Φ'_3 do not involve the cancellations $\nearrow \leftrightarrow \nwarrow$ and $\swarrow \leftrightarrow \searrow$, these sijections can be applied directly in the current case. On the other hand, since φ_{AR_1} does involve such cancellations in the construction of Φ'_4 , this construction should be modified. However, the modification is not difficult. Using the bijection $\text{AR}_n \times \text{AP}_{n-1} \rightarrow \text{AR}_1 \times \text{AP}_n$ constructed in Construction 5.8 instead of $\Psi_{n,i}$, we obtain

$$\begin{aligned}
&\bigsqcup_{i=1}^n \bigsqcup_{\mu \in \text{AR}_n} \bigsqcup_{T \in \text{AP}_{n-1}} \text{GT}(m_1(\mu, T, 0), \dots, m_{i-1}(\mu, T, 0), x, m_i(\mu, T, 1), \dots, m_{n-1}(\mu, T, 1)) \\
&\xrightarrow{\cong} \bigsqcup_{i=1}^n \bigsqcup_{(\mu, T) \in \text{AR}_1 \times \text{AP}_n} \text{GT}(k_1 + c_1(T), \dots, k_{i-1} + c_{i-1}(T), x, k_{i+1} + c_{i+1}(T), \dots, k_n + c_n(T)) \\
&= \text{AR}_1 \times \bigsqcup_{i=1}^n \bigsqcup_{T \in \text{AP}_n} \text{GT}(k_1 + c_1(T), \dots, k_{i-1} + c_{i-1}(T), x, k_{i+1} + c_{i+1}(T), \dots, k_n + c_n(T)),
\end{aligned}$$

and the construction of Φ''_4 can be completed as in Construction 5.8.

Next, we will verify that the sijection satisfies the compatibility conditions in Corollary 5.17. First, all the sijections used in the construction act on arrows as reversing and permuting, and hence the sijection is compatible with η_u , η_v and η_w . In addition, it is compatible with $\eta_{X_1}, \eta_{X_2}, \dots, \eta_{X_{n-1}}$ for the same reason as Proposition 5.10. Last, we will prove the sijection is compatible with η_{X_n} . In fact, the value of $\sum_{i=1}^n \eta_{X_i} - \eta_u + \eta_v$ is const. Indeed,

- for $T \in \text{GMT}(\mathbf{k})$, we have

$$\left(\sum_{i=1}^n \eta_{X_i} - \eta_u + \eta_v \right) (T) = \sum_n T = \sum \mathbf{k},$$

- and for $(\mu, (A, T)) \in \text{AR}_n \times \text{SGT}(\mathbf{k})$, we have

$$\left(\sum_{i=1}^n \eta_{X_i} - \eta_u + \eta_v \right) ((\mu, (A, T))) = \sum_n A - (\# \text{ of } \swarrow \text{ in } T) + (\# \text{ of } \searrow \text{ in } T).$$

Here, we have $\sum_n A = \sum T(\mathbf{k})$ from the definition of $\text{SGT}(\mathbf{k})$. Thus, the value is equal to $\sum \mathbf{k}$, based on the definition of $T(\mathbf{k})$.

Therefore, the value of

$$\eta_{X_n} = \left(\sum_{i=1}^n \eta_{X_i} - \eta_u + \eta_v \right) - \left(\sum_{i=1}^{n-1} \eta_{X_i} - \eta_u + \eta_v \right) = \sum \mathbf{k} - \left(\sum_{i=1}^{n-1} \eta_{X_i} - \eta_u + \eta_v \right),$$

is preserved under the action of the sijection. Thus, the sijection is compatible with all $n + 3$ statistics in Corollary 5.17. \square

Remark. In Corollary 5.17, we say there are $n + 3$ statistics with which the sijection is compatible, but some of them are degenerate, as can be understood from the proof of the compatibility in Construction 5.18. In addition to the relation $\sum_{i=1}^n \eta_{X_i} - \eta_u + \eta_v = \sum \mathbf{k}$, we have $\eta_u + \eta_v + \eta_w = \binom{n}{2}$. Thus, there are at most $n + 1$ independent statistics, where we say statistics are independent if there are no relations between them. Note that the number of independent statistics is not essentially meaningful. While it may be considered that the appropriateness of a family of statistics can be measured by how fine it is, we will not delve further into this as it is beyond the scope of this paper.

6 Conclusions

In this paper, we introduce the notion of compatibility of sijections and give transparent proofs of basic properties relevant to signed sets, sijections and the notion of compatibility. In addition, we explain some combinatorial results by means of compatibility. Our main contributions are as follows.

- We find and describe in detail the canonical one-to-one correspondences between Gelfand-Tsetlin patterns with a bottom row and that with a permuted bottom row. This leads us to a new computational proof of the signed enumeration of Gelfand-Tsetlin patterns. In addition, inspired by this proof, we define a generalization of Gelfand-Tsetlin patterns and extend the signed enumeration to this generalization.
- We extend the definition of inversion numbers for shifted Gelfand-Tsetlin patterns and construct a more natural sijection than the conventional one between (generalized) monotone triangles and shifted Gelfand-Tsetlin patterns, through the notion of compatibility with the inversion numbers.
- We give a bijective proof for the refined enumeration of an extension of alternating sign matrices with $n + 3$ statistics, first proved in [9].

We would also like to discuss the possibility of future applications of the notion of compatibility. In fact, we believe it could be applied to many topics in integrable combinatorics. On the one hand we have many determinant formulae in this field. (For example, those derived from the Lindstrom-Gessel-Viennot lemma, the Yang-Baxter equation, etc.) As mentioned in [8], the theory of signed sets and sijections is closely related to linear algebra. Therefore, known computational proofs of determinant formulae can be translated into bijective proofs. On the other hand we have many results about refined enumerations in this field. We should import these results into the bijective proofs through the notion of compatibility, since this may offer hints to construct more natural (or completely new) sijections, as in Section 5. In addition, considering compatibility can lead us to novel combinatorial results, as in Section 4.

Besides the above, the knowledge of this paper could be applied to the results obtained in [8], which is the sequel of the paper we mainly based our paper upon. This might lead to the discovery of novel relations between alternating sign matrices and descending plane partitions.

Acknowledgements

I would like to thank my supervisor, Prof. Ralph Willox for helpful discussions and comments on the manuscript. I would also like to thank Prof. Takafumi Mase for useful discussions. The author is partially supported by FoPM, WINGS Program, the University of Tokyo and JSPS KAKENHI No. 23KJ0795.

References

- [1] Behrend, R.E., Di Francesco, P. & Zinn-Justin, P. (2012). On the weighted enumeration of alternating sign matrices and descending plane partitions. *J. Comb. Theory, Ser. A*, 119(2), 331-363.
- [2] Behrend, R.E., Di Francesco, P. & Zinn-Justin, P. (2013). A doubly-refined enumeration of alternating sign matrices and descending plane partitions. *J. Comb. Theory, Ser. A*, 120(2), 409-432.
- [3] Di Francesco, P. (2013). Integrable combinatorics. In XVIIth International Congress on Mathematical Physics: Aalborg, Denmark, 6-11 August 2012. World Scientific Publishing Co. (pp. 29-51).
- [4] Doyle, P. G. (2019). A category for bijective combinatorics. arXiv:1907.09015 [math.CO].
- [5] Fischer, I. (2012). Sequences of labeled trees related to Gelfand-Tsetlin patterns, *Advances in Applied Mathematics*, 49(3-5), 165-195.
- [6] Fischer, I. (2018). Constant term formulas for refined enumerations of Gog and Magog trapezoids, *J. Comb. Theory, Ser. A*, 158, 560-604.
- [7] Fischer, I. & Konvalinka, M. (2020). A Bijective Proof of the ASM Theorem, Part I: The Operator Formula. *Electron. J. Comb.*, 27(3), 3-35.
- [8] Fischer, I. & Konvalinka, M. (2020). A Bijective Proof of the ASM Theorem Part II: ASM Enumeration and ASM-DPP Relation. *International Mathematics Research Notices*, 2022(10), 7203-7230.
- [9] Fischer, I. & Schreier-Aigner, F. (2023). The relation between alternating sign matrices and descending plane partitions: $n + 3$ pairs of equivalent statistics. *Advances in Mathematics*, 413, 108831.
- [10] Kuperberg, G. (1996). Another proof of the alternating-sign matrix conjecture. *International Mathematics Research Notices*, 1996(3), 139-150.
- [11] Mills, W.H., Robbins, D.P. & Rumsey, H. (1983). Alternating sign matrices and descending plane partitions, *J. Comb. Theory, Ser. A*, 34, 340-359.
- [12] Stanley, R. P. (1999). *Enumerative Combinatorics Vol. 2*. Cambridge University Press.
- [13] Stanley, R. P. (2009). Bijective Proof Problems. <https://klein.mit.edu/~rstan/bij.pdf>
- [14] Zeilberger, D. (1996). Proof of the alternating sign matrix conjecture. *Electron. J. Comb.*, 3(2):Research Paper 13.