

CONFORMAL WELDING OF INDEPENDENT GAUSSIAN MULTIPLICATIVE CHAOS MEASURES

ANTTI KUPIAINEN¹, MICHAEL MCAULEY¹, AND EERO SAKSMAN¹

ABSTRACT. We solve the classical conformal welding problem for a composition of two random homeomorphisms generated by independent Gaussian multiplicative chaos measures with small parameter values. In other words, given two such measures on the boundary of the unit disk we show that there exist conformal maps to complementary domains on the Riemann sphere such that the pushforward of the normalised measures agree on their common boundary.

1. INTRODUCTION AND MAIN RESULT

1.1. Introduction. Schramm-Loewner evolution (SLE) and Liouville quantum gravity (LQG) are two major modern contributions to the field of mathematical physics. The former was first described by Schramm [22] as the scaling limit of loop-erased random walk and is now either known or conjectured to be the scaling limit of many other planar statistical mechanics models at criticality [26, 15, 23]. The latter is a model of random surfaces inspired by the work of Polyakov on conformal field theory [19, 20]. We give more details and some references regarding this model below.

These two objects were elegantly related to one another by Sheffield [25] through conformal welding: roughly speaking, if one takes a particular coupling of a LQG surface and chordal SLE then the SLE curve corresponds to ‘zipping up’ the boundary of the surface in a length-preserving way. This insight is the foundation of many results for SLE, LQG and random planar maps (see [13] for a survey). In particular, in [6] it was extended to loop variants of SLE, see Section 1.4. Our motivation in this work is to provide an alternative path towards this relationship: we show that two independent LQG surfaces can be conformally welded together to generate a random closed curve. We begin with an informal statement of our result.

Let h_1, h_2 be two independent copies of the planar Gaussian free field restricted to the unit circle \mathbb{S}^1 (which we identify with $[0, 1)$). We formally define random measures on $[0, 1)$ by

$$\tau^{(i)}(dx) := e^{\gamma h_i(x)} dx$$

for $\gamma \in [0, \sqrt{2})$ and $i = 1, 2$. (Since h_i is not defined pointwise, this measure must be defined by a normalisation procedure described below.) One can think of $\tau^{(i)}$ as measuring ‘quantum boundary length’ for a LQG surface parameterised by the unit disk (this is a particular case of a Gaussian multiplicative chaos measure). Our main result states that for $\gamma > 0$ sufficiently small, we can map these two surfaces conformally onto disjoint domains in $\hat{\mathbb{C}}$ with common boundary such that the normalised quantum boundary lengths between points coincide for each surface (see Figure 1).

Before discussing our result and its relation to the literature in more detail, it will be helpful for us to give a precise statement and an outline of our method of proof.

¹DEPARTMENT OF MATHEMATICS AND STATISTICS, UNIVERSITY OF HELSINKI

E-mail addresses: antti.kupiainen@helsinki.fi, m.mcauley@cantab.net, eero.saksman@helsinki.fi.

Date: May 30, 2023.

2010 Mathematics Subject Classification. 60G57, 30C62, 60J67.

Key words and phrases. Conformal welding, Gaussian multiplicative chaos, Beltrami equation, Liouville Quantum Gravity.

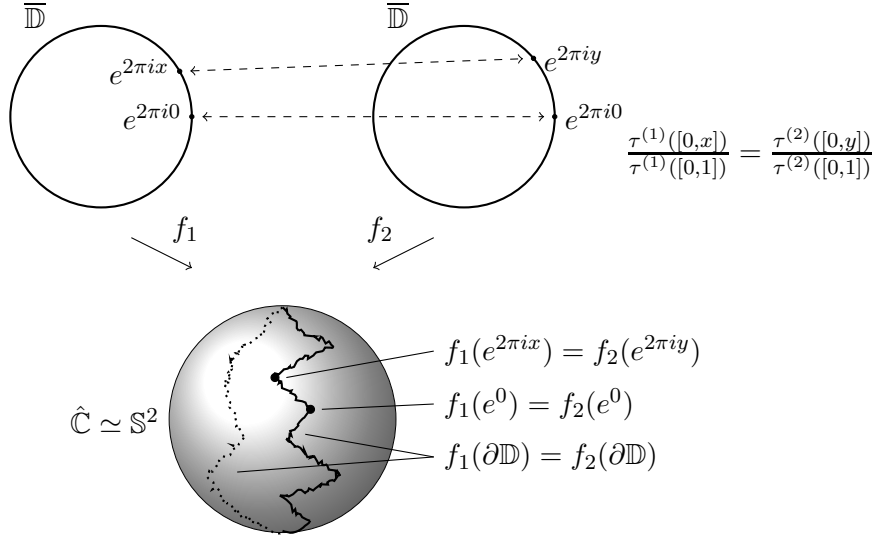

FIGURE 1. The conformal maps f_1, f_2 can be chosen so that $f_1(1) = f_2(1)$ and for $x, y \in [0, 1]$ we have $f_1(e^{2\pi i x}) = f_2(e^{2\pi i y})$ if and only if $\tau^{(1)}([0, x])/\tau^{(1)}([0, 1]) = \tau^{(2)}([0, y])/\tau^{(2)}([0, 1])$. The images of $\partial\mathbb{D}$ under f_1 and f_2 coincide to give a closed curve in \mathbb{C} which we think of as a subset of $\hat{\mathbb{C}} \simeq \mathbb{S}^2$. (Note: this figure is merely illustrative and not a simulation.)

1.2. Statement of main result. The planar Gaussian free field can be thought of intuitively as the Gaussian process h with covariance function

$$\mathbb{E}[h(x)h(y)] = \log \frac{1}{|x - y|}, \quad x, y \in \mathbb{R}^2.$$

The trace of the two-dimensional Gaussian free field on the circle \mathbb{S}^1 is then the restriction of h to \mathbb{S}^1 . There is some subtlety to both of these definitions as this covariance function diverges on the diagonal (and also at infinity, although this won't be relevant for the trace), however they can be made sense of in terms of random distributions. We say that a random distribution g taking values in $\mathcal{D}'(\mathbb{S}^1)$ has covariance kernel $K : \mathbb{S}^1 \times \mathbb{S}^1 \rightarrow \mathbb{R}$ if for any smooth functions $\varphi_1, \varphi_2 : \mathbb{S}^1 \rightarrow \mathbb{R}$

$$\text{Cov}(g(\varphi_1), g(\varphi_2)) = \int_{\mathbb{S}^1 \times \mathbb{S}^1} K(x, y) \varphi_1(x) \varphi_2(y) dm(x) dm(y)$$

where m denotes normalised Lebesgue measure on \mathbb{S}^1 . In the case that g is Gaussian and centred (i.e. $\mathbb{E}[g(\varphi)] = 0$ for every $\varphi \in C^\infty(\mathbb{S}^1)$) its distribution is completely specified by this covariance kernel (see [18] for background on general Gaussian processes). We therefore define the trace of the Gaussian free field on \mathbb{S}^1 to be the centred Gaussian process h taking values in $\mathcal{D}'(\mathbb{S}^1)$ with covariance kernel

$$K(x, y) = \log \frac{1}{|x - y|}, \quad x, y \in \mathbb{S}^1.$$

Identifying \mathbb{S}^1 with $[0, 1)$, the covariance kernel takes the form

$$K(t, u) = \log \frac{1}{2 \sin(\pi|t - u|)}, \quad t, u \in [0, 1).$$

We wish to define a measure τ on $[0, 1)$, identified with \mathbb{S}^1 , by

$$\tau(dx) = e^{\gamma h(x)} dx$$

where $\gamma > 0$ is a parameter. This naive definition is inconsistent since h is not defined pointwise, however it can be justified by taking a limit of regularised versions of h . Different

regularisation procedures are possible (all leading to the same limit, see [24]). We will use a regularisation based on a white noise representation of h from [9] since this representation will be an important part of proving our main result.

We denote by λ the hyperbolic measure on the upper half plane \mathbb{H} , that is $\lambda(dxdy) = (1/y^2)dxdy$. We let W be a periodic Gaussian white noise with respect to this measure defined as follows: W is a centred Gaussian process indexed by

$$\mathcal{B}^*(\mathbb{H}) := \left\{ A \subset \mathbb{H} : A \text{ is Borel, } \lambda(A) < \infty \text{ and } \sup_{(x_1, y_1), (x_2, y_2) \in A} |x_1 - x_2| < \infty \right\}$$

with covariance function

$$\text{Cov}(W(A_1), W(A_2)) = \lambda \left(A_1 \cap \left(\bigcup_{n \in \mathbb{Z}} (A_2 + n) \right) \right).$$

We define the sets

$$\mathcal{H} = \{(x, y) \in \mathbb{H} : |x| < 1/2, y \geq (2/\pi) \tan(|\pi x|)\}, \quad \mathcal{H}_\epsilon = \{(x, y) \in \mathcal{H} : y \geq \epsilon\} \quad \text{for } \epsilon > 0$$

(see Figure 2). Finally we define the Gaussian field $H_\epsilon(\cdot)$ by

$$H_\epsilon(x) = W(\mathcal{H}_\epsilon + x) \quad \text{for } x \in \mathbb{R}/\mathbb{Z} \simeq [0, 1).$$

This is our regularised process which yields h in the limit:

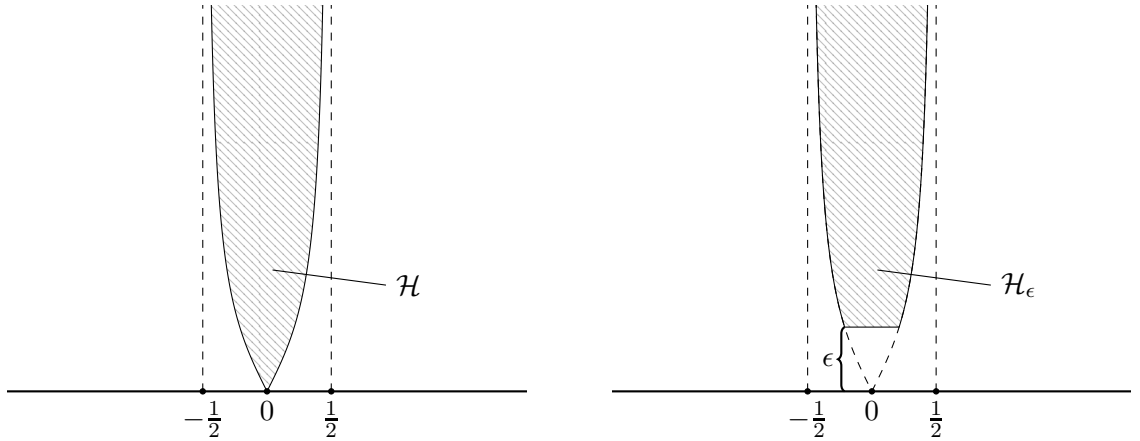

FIGURE 2. The sets \mathcal{H} and \mathcal{H}_ϵ are used to define a white noise representation for the Gaussian free field.

Lemma 1.1 ([8, Lemma 3.4]). *There exists a version of the white noise W such that for all $\epsilon > 0$ the map $x \mapsto H_\epsilon(x)$ is continuous and as $\epsilon \rightarrow 0^+$, $H_\epsilon(\cdot)$ converges in $\mathcal{D}'(\mathbb{S}^1)$ to some $H(\cdot)$ such that*

$$H(\cdot) \sim h + G$$

where $G \sim \mathcal{N}(0, 2 \log(2))$ is a (scalar) Gaussian variable independent of h .

The continuity and convergence stated here follow from standard arguments for random fields (Dudley's theorem). To justify the distribution of $H(\cdot)$, an explicit computation shows that for $t \in (0, 1)$

$$\lambda(H \cap (H + t)) + \lambda(H \cap (H + t - 1)) = 2 \log(2) + \log \frac{1}{2 \sin(\pi t)}$$

matching the covariance function of $h + G$. With this representation, we can now define the desired measure τ .

For any $\gamma > 0$ and bounded Borel function g , the process

$$(1.1) \quad \epsilon \mapsto \int_0^1 g(x) e^{\gamma H_\epsilon(x) - \frac{\gamma^2}{2} \text{Var}[H_\epsilon(x)]} dx$$

is a martingale with respect to decreasing $\epsilon \in (0, 1]$ (this follows easily from the definitions). The martingale is bounded in L^1 and hence converges almost surely. In particular, setting $g \equiv 1$ we see that the family of measures $e^{\gamma H_\epsilon(x) - \frac{\gamma^2}{2} \text{Var}[H_\epsilon(x)]} dx$ indexed by ϵ are bounded in total variation norm. Hence by the generalised form of Prokhorov's theorem, every sequence of such measures has a subsequence which is weak-* convergent. As $\epsilon_n \downarrow 0$, the convergence of (1.1) for, say, all polynomials with rational coefficients shows that the subsequential weak-* limits coincide. Hence we can unambiguously define the almost sure weak-* limit

$$(1.2) \quad \lim_{\epsilon \rightarrow 0^+} e^{\gamma H_\epsilon(x) - \frac{\gamma^2}{2} \text{Var}[H_\epsilon(x)]} e^{-\gamma G} 2^{-\gamma^2} dx =: \tau(dx).$$

Although this definition is valid for all $\gamma > 0$, the limiting measure is known to be trivial (i.e. identically zero) whenever $\gamma^2 \geq 2$ [21].

Let $\tau^{(1)}, \tau^{(2)}$ be independent copies of the measure defined by (1.2). We define the homeomorphisms ϕ_1, ϕ_2 by

$$(1.3) \quad \phi_j(e^{2\pi i x}) := \exp \left(2\pi i \cdot \frac{\tau^{(j)}([0, x])}{\tau^{(j)}([0, 1])} \right) \quad \text{for } j = 1, 2 \text{ and } x \in [0, 1).$$

Our main result is the following:

Theorem 1.2. *There exists $\gamma_0 \in (0, \sqrt{2})$ such that for each $\gamma \in [0, \gamma_0]$ with probability one the following holds: there exist conformal maps*

$$f_1 : \mathbb{D} \rightarrow D, \quad \text{and} \quad f_2 : \mathbb{C} \setminus \overline{\mathbb{D}} \rightarrow \mathbb{C} \setminus \overline{D}$$

(where $D \subset \mathbb{C}$ is some simply connected domain) which may be extended to homeomorphisms of their closures such that $f_1 \circ \phi_1^{-1} = f_2 \circ \phi_2^{-1}$. Moreover the maps f_1 and f_2 are unique up to composition with a Möbius transformation.

Remark 1.3. Small modifications to our proof enable one to treat the case where the γ -exponents of ϕ_1 and ϕ_2 are different and both less than γ_0 . Furthermore, the existence part of the theorem should follow by the method used in this paper for all $\gamma < \sqrt{2}$.

1.3. Outline of proof. Our method of proof can be broken down into the following steps:

Welding via the Beltrami equation: A classical approach to solving the conformal welding problem is through the theory of quasiconformal mappings and the Beltrami equation. (For the purpose of this outline, readers unfamiliar with quasiconformal maps can think of them as simply a generalisation of conformal maps. A definition will be given in Section 2 and further background may be found in [3, 7].)

We extend ϕ_1 and ϕ_2 to $\Phi_1 : \overline{\mathbb{D}} \rightarrow \overline{\mathbb{D}}$ and $\Phi_2 : \mathbb{C} \setminus \overline{\mathbb{D}} \rightarrow \mathbb{C} \setminus \overline{\mathbb{D}}$ respectively via the Beurling-Ahlfors extension (which we describe in Section 2). These extensions are orientation-preserving homeomorphisms which are differentiable almost everywhere. For a function g satisfying the latter properties, we define the complex dilatation μ_g to be the measurable function satisfying $\partial_{\bar{z}} g = \mu_g \partial_z g$ (where $\partial_{\bar{z}} = (1/2)(\partial_x + i\partial_y)$ and $\partial_z = (1/2)(\partial_x - i\partial_y)$ denote the standard Wirtinger derivatives). Considering the Jacobian of g shows that $|\mu_g| < 1$ almost everywhere, so we may define the distortion of g as $K_g := (1 + |\mu_g|)/(1 - |\mu_g|)$. The distortion/dilatation in some sense capture how close the function g is to being conformal, since $\mu_g = 0$ implies that g is holomorphic (up to sets of measure zero). We wish to find a quasiconformal homeomorphism $F : \mathbb{C} \rightarrow \mathbb{C}$ such that

$$(1.4) \quad \mu_F(z) = \begin{cases} \mu_{\Phi_1^{-1}}(z) & \text{if } z \in \mathbb{D} \\ \mu_{\Phi_2^{-1}}(z) & \text{if } z \in \mathbb{C} \setminus \overline{\mathbb{D}}. \end{cases}$$

This is a specific instance of the Beltrami equation. If we could obtain such an F , then the Stoilow factorisation theorem (a uniqueness result for the Beltrami equation) would state that

the functions f_1, f_2 defined by

$$(1.5) \quad \begin{aligned} f_1 &:= F \circ \Phi_1 : \overline{\mathbb{D}} \rightarrow F(\overline{\mathbb{D}}) \\ f_2 &:= F \circ \Phi_2 : \mathbb{C} \setminus \overline{\mathbb{D}} \rightarrow F(\mathbb{C} \setminus \overline{\mathbb{D}}) \end{aligned}$$

are conformal on the interior of their domains. Then by definition

$$f_1 \circ \phi_1^{-1} = F|_{\partial\mathbb{D}} = f_2 \circ \phi_2^{-1}$$

and so f_1 and f_2 would solve our welding problem.

The standard existence theorem for the Beltrami equation asserts that equations of the form (1.4) have a solution whenever the right hand side is bounded (in absolute value) uniformly away from one. This is known as the uniformly elliptic case. Unfortunately this condition is not satisfied in our setting for points close to $\partial\mathbb{D}$; our Beltrami equation is thus described as degenerate.

To make progress, we imitate a classical argument for solving degenerate Beltrami equations that originated with Lehto [16] (see [7, Chapter 20] for a modern treatment and further references). We define a sequence of Beltrami equations by

$$\mu_{F_n}(z) = \begin{cases} \frac{n}{n+1} \mu_{\Phi_1^{-1}}(z) & \text{if } z \in \mathbb{D} \\ \frac{n}{n+1} \mu_{\Phi_2^{-1}}(z) & \text{if } z \in \mathbb{C} \setminus \overline{\mathbb{D}} \end{cases}.$$

Each such equation is uniformly elliptic and so has a well-defined solution. Supposing that the sequence F_n is equicontinuous, the Arzelà-Ascoli theorem produces a subsequential limit which, by standard analytic arguments, may be shown to solve (1.4). It is relatively straightforward to establish equicontinuity away from $\partial\mathbb{D}$ in our setting: this follows from almost sure bounds on the distortion of Φ_1^{-1} and Φ_2^{-1} which are a consequence of well-known moment bounds on $\tau^{(1)}$ and $\tau^{(2)}$ and the definition of the Beurling-Ahlfors extension. It is (apparently) much more challenging to prove equicontinuity on $\partial\mathbb{D}$ and doing so occupies the majority of our paper, as we describe below.

In fact we eventually establish the stronger statement that the family F_n satisfies a uniform Hölder continuity bound on $\partial\mathbb{D}$. This implies that $F(\partial\mathbb{D})$ is a Hölder domain which, by a conformal removability result due to Jones and Smirnov [14], guarantees the uniqueness of our solution to the welding problem.

Hölder continuity via ‘undistorted’ annuli: The primary information we have about the functions F_n is a uniform bound on their distortion and from this we wish to prove a uniform Hölder continuity bound. We make the link between these properties using conformal modulus/extremal length (which is described in Section 2 for those who are unfamiliar with the concept). Specifically it is enough to show that for each point of $\partial\mathbb{D}$ there exists a sequence of shrinking concentric annuli \mathbb{A}_i surrounding the point such that the images of these annuli under any F_n has conformal modulus bounded away from zero (see Figure 3). The latter property follows if the distortion of F_n on each \mathbb{A}_i is not too large (relative to the size of \mathbb{A}_i).

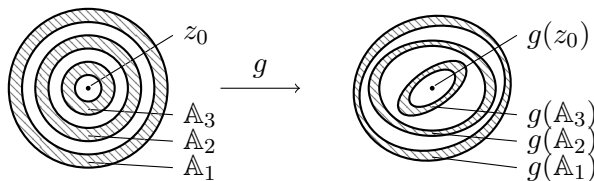

FIGURE 3. To bound the modulus of continuity of a homeomorphism g near a point z_0 , it is enough to show that the images of small annuli \mathbb{A}_i surrounding x are not too ‘distorted’ (i.e. they are not too long or thin). We apply this reasoning to $g = F_n$ around points $z_0 \in \partial\mathbb{D}$.

The distortion of F_n on any \mathbb{A}_i is defined in terms of the distortion of Φ_1 and Φ_2 on $\Phi_1^{-1}(\mathbb{A}_i) \cup \Phi_2^{-1}(\mathbb{A}_i)$. This set would be difficult to work with if we chose the \mathbb{A}_i deterministically,

so instead we define them as images under Φ_1 and Φ_2 of deterministic sets which we call ‘half-annuli’. These sets, and the ensuing arguments, are more easily described by a conformal change of domain.

We identify \mathbb{R} as the periodic extension of $\partial\mathbb{D}$ via $z \mapsto e(z) := \exp(2\pi iz)$ and we define our half annuli as follows: for $t \geq 0$, $x \in \mathbb{R}$ and a small parameter $\rho \in (0, 1)$ let

$$A_t(x) := x + ([-\rho^t, \rho^t] \times [0, \rho^t]) \setminus ((-\rho^{t+1/4}, \rho^{t+1/4}) \times (0, \rho^{t+1/4}))$$

(see Figure 4) and let $\tilde{A}_t(x)$ be the reflection of this set in the real axis. Observe that as t increases, the half-annuli shrink towards the point x .

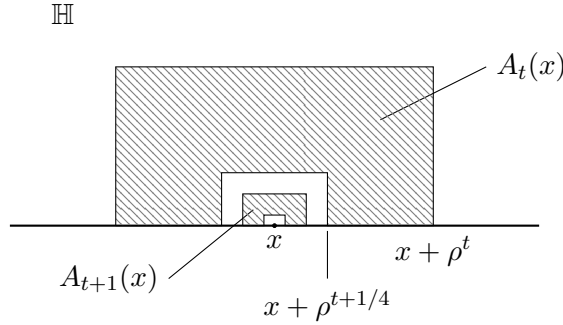

FIGURE 4. The half-annuli $A_t(x)$ and $A_{t+1}(x)$.

For $j = 1, 2$ we let Ψ_j be the periodic extension of $e^{-1} \circ \Phi_j \circ e$ so that Ψ_1 and Ψ_2 are (periodic) homeomorphisms of \mathbb{H} and $\mathbb{C} \setminus \mathbb{H}$ respectively. Suppose that we have a pair of half-annuli $A_t(x)$ and $\tilde{A}_s(y)$ such that the union of their images, under Ψ_1 and Ψ_2 respectively, contains a topological annulus \mathbb{A} and the distortion of $F_n \circ e$ is not too large on \mathbb{A} . Then under our identification of \mathbb{R} and $\partial\mathbb{D}$, this allows us to obtain an annulus around some point in $\partial\mathbb{D}$ on which the distortion of F_n is bounded above (see Figure 5).

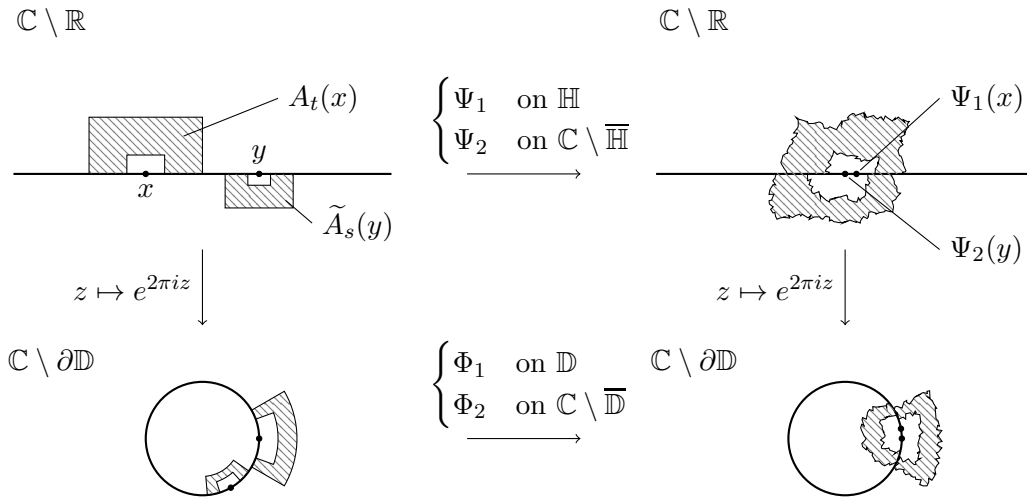

FIGURE 5. The images of the upper and lower half-annuli $A_t(x)$ and $\tilde{A}_s(y)$ may ‘match up’, in the sense that their union contains a topological annulus, if $\Psi_1(x) \approx \Psi_2(y)$. This is equivalent to finding annuli around points of $\partial\mathbb{D}$, although it is notationally easier to work on \mathbb{R} .

Our objective then is to find, for every point in $[0, 1]$, sufficiently many pairs of such half-annuli whose images surround the chosen point. Consider a finely spaced grid of points in $[0, 1]$. A crude union bound argument shows that with high probability, for each x in the

grid we can find a y in the grid such that $\Psi_1(x) \approx \Psi_2(y)$. Roughly speaking this means that the ‘centres’ of the half annuli $\Psi_1(A_t(x))$ and $\Psi_2(\tilde{A}_s(y))$ match and this gives us some hope of finding a suitable annulus in the union of these sets. In turn, this requires that the two image half-annuli are of comparable *size* and each have a somewhat regular *shape*. The elegant definition of the Beurling-Ahlfors extension allows us to translate these geometric properties of the images into simple conditions on the underlying measures $\tau^{(1)}$ and $\tau^{(2)}$. The Borel-Cantelli lemma then shows that it is sufficient for these conditions to hold with high probability for some sequence of values (s_n) , (t_n) and each x and y in the grid.

An approximate decomposition for $\tau^{(1)}$ and $\tau^{(2)}$: The event that the half-annulus $\Psi_1(A_t(x))$ has a sufficiently regular shape and the distortion of $F_n \circ e$ is not too large on this set, which we denote by $\text{Shape}^{(1)}(t)$, is an intersection of events of the form

$$(1.6) \quad \frac{\tau^{(1)}(x + \rho^t I)}{\tau^{(1)}(x + \rho^t J)} \leq c$$

where $I, J \subset [0, 1]$ and $c > 0$ do not depend on t . (The event $\text{Shape}^{(2)}(s)$ is defined analogously.) The event that the half-annuli $\Psi_1(A_t(x))$ and $\Psi_2(\tilde{A}_s(y))$ are of comparable size, denoted $\text{Size}(t, s)$, is roughly of the form

$$(1.7) \quad c^{-1} \leq \frac{\tau^{(1)}(x + [-\rho^t, \rho^t])}{\tau^{(2)}(y + [-\rho^s, \rho^s])} \leq c$$

for some $c > 0$.

We need to show that these events occur for many different values of t and s . To control the dependence between events, we decompose the measures $\tau^{(1)}$ and $\tau^{(2)}$ using the hyperbolic white noise with which they are defined.

Let $\tau_t^{(j)}$ denote the measure constructed analogously to $\tau^{(j)}$ by restricting the hyperbolic white noise to the horizontal strip $\{(u, v) \in \mathbb{H} : v \leq \rho^t\}$. For $t \geq 0$ let $B_t = [-\rho^t, \rho^t]$. From the definition of $\tau^{(j)}$ in (1.2) it may seem plausible to the reader that for large t

$$(1.8) \quad \tau^{(j)}(x + A) \approx \tau_t^{(j)}(x + A \setminus B_{t+3/4}) \exp\left(\gamma H_{\rho^t}^{(j)}(x) - \frac{\gamma^2}{2} \text{Var}[H_{\rho^t}^{(j)}(0)]\right)$$

for intervals A which have length of order ρ^t . We give further heuristics for this in Section 4 where we also verify rigorously that the approximation is valid, with high probability, for many values of t and $j = 1, 2$. The justification follows from essentially elementary methods: moment bounds on $\tau^{(j)}$ and independence of the hyperbolic white noise on disjoint regions.

Reduced size and shape events: The approximate decomposition of $\tau^{(1)}$ and $\tau^{(2)}$ simplifies our events of interest; substituting the right hand side of (1.8) into (1.6) yields the ‘reduced’ shape event

$$\frac{\tau_t^{(1)}(x + (\rho^t I) \setminus B_{t+3/4})}{\tau_t^{(1)}(x + (\rho^t J) \setminus B_{t+3/4})} \leq c'$$

which we denote by $\text{ShapeRed}^{(1)}(t)$. These events are much nicer to work with since they depend on disjoint regions of the hyperbolic white noise for distinct values of t and so are independent. (More precisely, this is true of $\text{ShapeRed}^{(1)}(t)$ and $\text{ShapeRed}^{(1)}(t')$ for $|t' - t| \geq 1$.) We therefore use standard large deviation estimates for Bernoulli random variables to show that the reduced shape events occur for many values of t (for $j = 1, 2$).

Similarly if we substitute (1.8) into (1.7) then we obtain an event of the form

$$1/c' \leq \exp\left(X_{t,s}^{(H)}\right) \frac{\rho^{-t} \tau_t^{(1)}(x + [-\rho^t, \rho^t])}{\rho^{-s} \tau_s^{(2)}(y + [-\rho^s, \rho^s])} \leq c'$$

where

$$X_{t,s}^{(H)} := \gamma H_{\rho^t}^{(1)}(x) - \gamma H_{\rho^s}^{(2)}(y) - \left(1 + \frac{\gamma^2}{2}\right) \log(1/\rho)(t - s).$$

It is relatively easy to control the fraction in the above expression as it has the same independence properties as the events $\text{ShapeRed}^{(j)}(t)$ for different values of t and s .

Our final objective then is to find many values of t and s (which differ by at least one) such that $|X_{t,s}^{(H)}|$ is not too large. From the definition of $H_\epsilon^{(j)}$ it is apparent that $t \mapsto H_{\rho^t}^{(1)}(x)$ is continuous with independent Gaussian increments and so $X_{t,s}^{(H)}$ can be viewed as a difference of two time-changed Brownian motions with drift, where we allow the time parameters t and s to vary independently. This motivates us to find appropriate values of t and s iteratively: given a current value of $X_{t,s}^{(H)}$, we increase either t or s so that the drift term brings our process closer to zero (on average). In this way we define the sequence of points (t_n) and (s_n) . The resulting iterative process is an oscillating random walk (which we define in Section 5.2) and we are able to use basic probabilistic methods to show that $|X_{t_n,s_n}^{(H)}|$ is small for many n with high probability.

1.4. Discussion. Our result contributes to a line of work which originated with the conjecture by Peter Jones that a variant of SLE could be obtained by solving the conformal welding problem for the homeomorphism ϕ_1 defined by (1.3). It was shown in [8] that this problem admits a solution, defining a family of random fractal closed curves. Soon after, Sheffield [25] proved that SLE curves correspond directly to welding two independent Liouville Quantum Gravity surfaces according to their boundary measures. These measures are equivalent to $\tau^{(1)}$ and $\tau^{(2)}$ in our presentation, except defined on $[0, \infty]$. More precisely, Sheffield showed that an SLE curve could be coupled with the Gaussian free field in such a way that two independent measures defined analogously to $\tau^{(1)}$ and $\tau^{(2)}$ can be conformally welded along the curve. In [5] Sheffield's welding result was extended to variants of SLE with two marked points and in [6] to SLE loop measures constructed in [28].

Sheffield's result strongly suggests that Jones' conjecture is in fact correct if one instead solves the conformal welding problem for $\phi_1^{-1} \circ \phi_2$. This, along with the importance of the relationship between SLE and LQG, served as the motivation for our work. Our result differs from that of Sheffield (and subsequent work building upon his) in that we start with two independent measures and show that they can be welded together to form curves. In particular, the existence and properties of SLE (loops) are not used in our work. This approach offers some advantages to studying the relationship between measures and curves: first, it offers a path toward proving continuity of the curves with respect to the parameter γ (see the proof of [8, Theorem 5.3]) and second, it may generalise more readily to other measures. We also believe that it should be possible to extend our method to cover the case when ϕ_1 and ϕ_2 have distinct parameters $\gamma_1 \neq \gamma_2$.

Our approach to solving the welding problem differs in a couple of essential ways from that of [8]. First of all, the deterministic welding argument is now performed by estimating the moduli of the inverse of an extension by using the extension itself. In this way we are led to estimating the Sobolev $H^{1/2}$ -norm of our welding homeomorphism at suitable dyadic intervals. In turn, this can be done conveniently for homeomorphisms via ℓ^2 -sums of (relative) masses of dyadic subintervals, see Lemma 3.7 below. This is actually simpler than the use of 'Lehto integrals' in [8], and so could be used to somewhat streamline the proof of the welding result for ϕ_1 .

However, when dealing with the homeomorphism $\phi = \phi_1^{-1} \circ \phi_2$ we face a new problem: as we are making our estimates for the 'non-inverted' maps (i.e. Φ_1 and Φ_2), we need to match the images of the annuli we are considering (see the right hand side of Figure 5). In principle this can be taken care of by posing extra conditions on the location of the images, but as we need to do this on all scales for a large number of annuli, the 'extra' log-normal scaling factor of multiplicative chaos (i.e. the exponential term in (1.8)) starts to have an effect which must be controlled carefully. This leads to the second main novelty in the techniques of the present paper: we consider an oscillating random walk algorithm in order to find enough matching random annuli, see Section 5.2 below.

The main shortcoming of our result is that it is valid only for small values of γ . (In Sheffield's work, small γ corresponds to small values of κ for $\text{SLE}(\kappa)$.) Most parts of our argument could be extended to all subcritical values of γ , however there are two bottlenecks: first, in Lemma 3.3 it is necessary to match up sequences of image annuli under Ψ_1 and Ψ_2 with high probability. We do this using a rather crude union bound over the centres of the annuli, which necessitates strong probability bounds that hold only for γ less than some explicit constant. Second, in Sections 4.2, 5.3 and 5.4 we give large deviation estimates for the number of image annuli satisfying various conditions. For any $\gamma \in [0, \sqrt{2})$, similar estimates hold for each of the conditions on a constant density subsequence of annuli. In order to have the intersection of these conditions hold for a large number of annuli, we need to show that the individual conditions hold for a subsequence with density close to one, which requires γ to be close to zero.

The number of annuli for which we require the various conditions to hold is dictated by our desire to prove uniform Hölder continuity of the maps F_n , which in turn ensures uniqueness of the welding solution. Proving existence of the welding solution requires only equicontinuity of F_n which corresponds to a much smaller number of annuli. As mentioned in Remark 1.3, we suspect that with a little additional work, our methods would be able to provide such an estimate for all subcritical γ , and hence prove the existence of a welding solution in this case.

In a recent interesting preprint [11], Binder and Kojar prove a number of results for the inverse of the measure $\tau^{(1)}$ with the aim of working towards a solution of the conformal welding problem that we consider. It would be interesting to know if some of the ideas in their work could be combined with our methods to cover larger values of γ .

1.5. Acknowledgements. The first and second authors were supported by the European Research Council (ERC) Advanced Grant QFPROBA (grant number 741487). The third author was supported by the Finnish Academy project 342183 and Center of Excellence FiRST. We thank Kari Astala, Ilya Binder, Peter Jones, Tomas Kojar, and Xin Sun for many valuable discussions.

2. SOLVING THE BELTRAMI EQUATION

In this section we consider a Beltrami equation which is equivalent to our welding problem. We show that this equation may be solved assuming a Hölder continuity bound for approximate solutions. Sections 3-5 will then be dedicated to proving this bound.

We begin by stating some basic properties of the measures $\tau^{(j)}$:

Lemma 2.1. *Let τ be defined according to (1.2) then there exists $c_1, c_2 > 0$ depending on γ such that with probability one, for some C_1, C_2 and any $0 \leq a < b \leq 1$*

$$C_1|b - a|^{c_1} < \tau([a, b]) < C_2|b - a|^{c_2}.$$

Moreover if $\gamma \in [0, \gamma_0]$ and $p \in [1, 2/\gamma_0^2)$ then there exists $C_{\gamma_0} > 0$ such that

$$\mathbb{E}[\tau([a, b])^p] \leq C_{\gamma_0}|b - a|^{\zeta_p(\gamma)}$$

where $\zeta_p(\gamma) := p - \frac{p^2 - p}{2}\gamma^2$ denotes the multifractal spectrum of τ .

Proof. These are both essentially well-known general properties of Gaussian multiplicative chaos measures; the precise statements in our setting are given in [8, Theorem 3.7]. (Note that the cited result is stated only for $p \in (1, 2)$, however its proof of the moment bound holds for all $p \in [1, 2/\gamma_0^2)$.) \square

We can now set up the Beltrami equation. We define the periodic functions $\psi_1, \psi_2 : \mathbb{R} \rightarrow \mathbb{R}$ by

$$\psi_j(n + x) = n + \frac{\tau^{(j)}([0, x])}{\tau^{(j)}([0, 1])} \quad \text{for } x \in [0, 1), n \in \mathbb{Z}.$$

The first part of Lemma 2.1 shows that each ψ_j is a homeomorphism. Next we make use of the Beurling-Ahlfors extension [10]: for $x \in \mathbb{R}$ and $y \in [0, 1]$ we define

$$(2.1) \quad \text{Ext}(\psi_j)(x + iy) = \frac{1}{2} \int_0^1 \psi_j(x + ty) + \psi_j(x - ty) dt + i \int_0^1 \psi_j(x + ty) - \psi_j(x - ty) dt.$$

We use a different definition away from the real axis, to simplify later arguments. Since ψ_j is 1-periodic, for $x \in \mathbb{R}$

$$\text{Ext}(\psi_j)(x + i) = x + i + c_0$$

where $c_0 = \int_0^1 \psi_j(t) dt - 1/2$. Then by defining

$$\text{Ext}(\psi_j)(x + iy) = \begin{cases} x + iy + (2 - y)c_0 & \text{if } 1 < y < 2 \\ x + iy & \text{if } y \geq 2 \end{cases}$$

we see that $\text{Ext}(\psi_j)$ is an extension of ψ_j which is differentiable almost everywhere and equal to the identity for $\text{Im}(z) \geq 2$. We then define $\Psi_1(z) = \text{Ext}(\psi_1)$ and $\Psi_2(z) = \overline{\text{Ext}(\psi_2)}(\bar{z})$ where $\bar{\cdot}$ denotes complex conjugation so that $\Psi_1 : \overline{\mathbb{H}} \rightarrow \overline{\mathbb{H}}$ and $\Psi_2 : \mathbb{C} \setminus \mathbb{H} \rightarrow \mathbb{C} \setminus \mathbb{H}$. Finally we define the homeomorphisms $\Phi_1 : \overline{\mathbb{D}} \rightarrow \overline{\mathbb{D}}$ and $\Phi_2 : \mathbb{C} \setminus \mathbb{D} \rightarrow \mathbb{C} \setminus \mathbb{D}$ by

$$(2.2) \quad \Phi_j(z) = \exp\left(2\pi i \Psi_j\left(\frac{\log z}{2\pi i}\right)\right) \quad \text{for } j = 1, 2.$$

We record here a basic property of the Beurling-Ahlfors extension which we will make use of later:

Lemma 2.2. *Let $D\Psi_1$ denote the derivative of Ψ_1 . For $x \in \mathbb{R}$ and $y \in (0, 1)$*

$$|D\Psi_1(x + iy)| \leq \frac{4|\psi_1(x + y) - \psi_1(x - y)|}{y}.$$

Proof. By definition of the Beurling-Ahlfors extension (2.1), a change of variables and continuity of ψ_1 , we have

$$\begin{aligned} \frac{d}{dx} \text{Re } \Psi_1(x + iy) &= \lim_{h \searrow 0} \frac{1}{2h} \int_{-1}^1 \psi_1(x + h + ty) - \psi_1(x + ty) dt \\ &= \lim_{h \searrow 0} \frac{1}{2hy} \left(\int_{x+y}^{x+y+h} - \int_{x-y}^{x-y+h} \psi_1(u) du \right) = \frac{\psi_1(x + y) - \psi_1(x - y)}{2y}. \end{aligned}$$

Very similar elementary computations show that the partial derivatives of the real/imaginary parts of Ψ_1 are each bounded in absolute value by $y^{-1}|\psi_1(x + y) - \psi_1(x - y)|$, thus proving the statement of the lemma. \square

We now introduce some definitions from the theory of quasiconformal maps, for details and further background we refer the reader to [17, 7]. Recall that for two domains Ω, Ω' the Sobolev space $W_{\text{loc}}^{1,2}(\Omega, \Omega')$ consists of all measurable functions from Ω to Ω' with a weak derivative almost everywhere such that the function and its (weak) derivative are locally square integrable. For $g \in W_{\text{loc}}^{1,2}(\Omega, \Omega')$ we define the complex dilatation μ_g and distortion $K(\cdot, g)$ by

$$\partial_{\bar{z}}g = \mu_g \partial_z g, \quad \text{and} \quad K(z, g) = \frac{1 + |\mu_g(z)|}{1 - |\mu_g(z)|} \quad \text{for a.e. } z \in \Omega.$$

We recall also that an orientation preserving homeomorphic map $g \in W_{\text{loc}}^{1,2}(\Omega, \Omega')$ is called C -quasiconformal if $\|K(z, g)\|_{\infty} \leq C$. A map is called quasiconformal if it is C -quasiconformal for some C .

Since Φ_1 and Φ_2 are C^1 homeomorphisms away from the circles $|z| = 1, e^{\pm 2\pi}, e^{\pm 4\pi}$, by Sard's theorem (and the inverse function theorem) their inverses are continuously differentiable

almost everywhere. Hence these inverses have well defined dilatations and so we may define the measurable functions

$$(2.3) \quad \mu(z) := \begin{cases} \mu_{\Phi_1^{-1}}(z) & \text{if } z \in \mathbb{D} \\ \mu_{\Phi_2^{-1}}(z) & \text{if } z \in \mathbb{C} \setminus \overline{\mathbb{D}}, \end{cases} \quad \text{and} \quad K(z) := \frac{1 + |\mu(z)|}{1 - |\mu(z)|}.$$

If we could find a quasiconformal map $F : \mathbb{C} \rightarrow \mathbb{C}$ such that $\mu_F = \mu$ then a classical line of reasoning (using the Stoilow factorisation theorem) would yield a unique solution to our welding problem. Unfortunately this approach is not feasible in our case since K is unbounded. Beltrami equations with unbounded distortion are known as *degenerate* and there is longstanding interest in solution methods for such equations (see [7, Chapter 20] or [12, Chapter 4] and references therein).

The link between conformal welding and the Beltrami equation persists in the degenerate case: if K is locally bounded on $\mathbb{C} \setminus \partial\mathbb{D}$ and there exists a homeomorphic map $F \in W_{\text{loc}}^{1,1}(\mathbb{C}, \mathbb{C})$ for which $\mu_F = \mu$ almost everywhere then we can construct a solution to the welding problem for ϕ_1^{-1} and ϕ_2^{-1} . To find such an F , we adapt an approach which originated with Lehto in [16] (and was used in a context similar to ours in [8]). We shall define solutions F_n to the Beltrami equation for approximations of μ with bounded distortion and apply the Arzelà-Ascoli theorem to take subsequential limits. The following three lemmas will be required to justify equicontinuity (as an input to Arzelà-Ascoli).

Lemma 2.3. *For $\gamma \in [0, \sqrt{2})$ with probability one $K \in L_{\text{loc}}^\infty(\mathbb{C} \setminus \partial\mathbb{D})$.*

Proof. Since Φ_1, Φ_2 and their inverses are continuously differentiable almost everywhere, a simple calculation using the chain rule shows that

$$|\mu(z)| = \begin{cases} |\mu_{\Phi_1} \circ \Phi_1^{-1}(z)| & \text{for a.e. } z \in \mathbb{D} \\ |\mu_{\Phi_2} \circ \Phi_2^{-1}(z)| & \text{for a.e. } z \in \mathbb{C} \setminus \mathbb{D}, \end{cases}$$

and hence

$$K(z) = \begin{cases} K(\Phi_1^{-1}(z), \Phi_1) & \text{for a.e. } z \in \mathbb{D} \\ K(\Phi_2^{-1}(z), \Phi_2) & \text{for a.e. } z \in \mathbb{C} \setminus \mathbb{D}. \end{cases}$$

The result now follows from arguments in [8] where the distortion of Φ_1 is bounded above by a discrete approximation which can be controlled by moment estimates for Gaussian multiplicative chaos. Specifically [8, Equation (25) and Theorem 2.6] shows that $K(\cdot, \Phi_1)$ is almost surely in $L_{\text{loc}}^\infty(\mathbb{C} \setminus \partial\mathbb{D})$. The same is true of $K(z, \Phi_2)$ since distortion is preserved under reflection in the unit circle (and Φ_2 has the same distribution as Φ_1). \square

Lemma 2.4. *For $\gamma \in [0, \sqrt{2})$ with probability one $K \in L_{\text{loc}}^1(\mathbb{C})$.*

Proof. By Lemma 2.3 it is enough to show that K is integrable on some neighbourhood of $\partial\mathbb{D}$. Let \mathcal{A} be the annulus $\{e^{-2\pi} \leq |z| \leq 1\}$. By a change of variables (which is valid since Φ_1 is C^1 away from the boundary of \mathcal{A})

$$(2.4) \quad \begin{aligned} \int_{\Phi_1(\mathcal{A})} K(z) d\mathcal{H}^2(z) &= \int_{\Phi_1(\mathcal{A})} K(\Phi_1^{-1}(z), \Phi_1) d\mathcal{H}^2(z) = \int_{\mathcal{A}} K(w, \Phi_1) J(w, \Phi_1) d\mathcal{H}^2(w) \\ &= \int_{\mathcal{A}} |D\Phi_1(w)|^2 d\mathcal{H}^2(w) \end{aligned}$$

where $J(w, \Phi_1) = |\partial_z \Phi_1|^2 - |\partial_{\bar{z}} \Phi_1|^2$ denotes the Jacobian of Φ_1 and \mathcal{H}^2 denotes Hausdorff measure. Recall that $\Phi_1 = e \circ \Psi_1 \circ e^{-1}$. Since $|De|$ and $|De^{-1}|$ are bounded by an absolute

constant $c > 0$ on \mathcal{A} , by another change of variables we conclude that

$$\begin{aligned}
(2.5) \quad \int_{\mathcal{A}} |D\Phi_1(w)|^2 d\mathcal{H}^2(w) &\leq c \int_{[0,1] \times [0,1]} |D\Psi_1(x+iy)|^2 dx dy \\
&\leq 16c \int_{[0,1] \times [0,1]} \frac{|\psi_1(x+y) - \psi_1(x-y)|^2}{y^2} dx dy \\
&\leq \frac{16c}{\tau^{(1)}([0,1])^2} \int_{[0,1] \times [0,1]} \frac{\tau^{(1)}([x-y, x+y])^2}{y^2} dx dy
\end{aligned}$$

where the second inequality uses Lemma 2.2. Using monotonicity of $\tau^{(1)}$

$$\begin{aligned}
(2.6) \quad \int_{[0,1] \times [0,1]} \frac{\tau^{(1)}([x-y, x+y])^2}{y^2} dx dy &\leq \sum_{n=0}^{\infty} 2^{2(n+1)} \int_{[0,1]} \int_{[2^{-(n+1)}, 2^{-n}]} \tau^{(1)}([x-y, x+y])^2 dy dx \\
&\leq \sum_{n=0}^{\infty} 2^{n+2} \int_{[0,1]} \tau^{(1)}([x-2^n, x+2^n])^2 dx.
\end{aligned}$$

Splitting the latter integral into a sum over dyadic intervals and using monotonicity of $\tau^{(1)}$ once more

$$\begin{aligned}
\int_{[0,1]} \tau^{(1)}([x-2^n, x+2^n])^2 dx &= \sum_{k=1}^{2^n} \int_{[(k-1)2^{-n}, k2^{-n}]} \tau^{(1)}([x-2^n, x+2^n])^2 dx \\
&\leq \sum_{k=1}^{2^n} 2^{-n} \tau^{(1)}([(k-2)2^n, (k+1)2^n])^2 \\
&\leq 2^{-n} \cdot 3\tau^{(1)}([0,1]) \sup_{k=1, \dots, 2^n} \tau^{(1)}([(k-2)2^n, (k+1)2^n])
\end{aligned}$$

where the final inequality uses additivity of $\tau^{(1)}$. By Lemma 2.1 we see that with probability one this expression is bounded by $C2^{-n}\tau^{(1)}([0,1]) \cdot 2^{-cn}$ for some $C, c > 0$ independent of n . Hence by (2.6)

$$(2.7) \quad \int_{[0,1] \times [0,1]} \frac{\tau^{(1)}([x-y, x+y])^2}{y^2} dx dy \leq 4C\tau^{(1)}([0,1]) \sum_{n=0}^{\infty} 2^{-cn} < \infty.$$

Combining (2.4), (2.5) and (2.7) shows that K is almost surely integrable on $\Phi_1(\mathcal{A}) = \mathcal{A}$. Replacing \mathcal{A} with the annulus $\{1 \leq |z| \leq e^{2\pi}\}$ we can give an identical argument for Φ_2 which proves that K is almost surely integrable on a neighbourhood of $\partial\mathbb{D}$ as required. \square

Lemma 2.5. *There exists a homeomorphism $\eta : [0, \infty) \rightarrow [0, \infty)$ such that if f is any quasiconformal mapping defined on the annulus $A := \{w : |w - w_0| \in (r, R)\}$, then*

$$\frac{\text{diam}_O f(A)}{\text{diam}_I f(A)} \geq \eta \left(\frac{\log(R/r)}{\|K(\cdot, f)\|_{\infty}} \right)$$

where diam_O and diam_I denote the outer and inner diameters of an annulus respectively.

Before proving this lemma, we briefly recall the notion of conformal modulus for a family of curves which will be used here and elsewhere in our arguments. For background and further details, see [2, 17]. Let Γ be a family of locally rectifiable curves with images in some domain $D \subset \mathbb{C}$. The conformal modulus of Γ , denoted $\text{mod } \Gamma$, is given by

$$\inf_{\rho} \int_D \rho^2 dx dy$$

where the infimum is taken over all Borel-measurable functions $\rho \geq 0$ such that $\int_\gamma \rho |dz| \geq 1$ for all $\gamma \in \Gamma$. The conformal modulus of a curve family is invariant under conformal maps (indeed this was the motivation for its introduction) and more generally if g is C -quasiconformal on D then

$$\frac{1}{C} \text{mod } \Gamma \leq \text{mod } g(\Gamma) \leq C \text{mod } \Gamma$$

where $g(\Gamma) = \{g \circ \gamma \mid \gamma \in \Gamma\}$. For a topological annulus $A' \subset \mathbb{C}$, we define $\text{mod } A'$ to be the modulus of all rectifiable curves in A' which have a winding number of one around any point in the bounded component of the complement of A' . For $A = \{w \mid r < |w| < R\}$ a direct computation shows that $\text{mod } A = 2\pi \log(R/r)$.

Proof of Lemma 2.5. Combining [27, Corollary 7.39] and [4, Exercise 5.68 (16)] shows that for any bounded topological annulus $A' \subset \mathbb{C}$

$$\frac{\text{diam}_O A'}{\text{diam}_I A'} \geq \frac{1}{16} e^{\pi \text{mod } A'}.$$

Since the modulus of A is $2\pi \log(R/r)$ and f is quasiconformal

$$\text{mod } f(A) \geq \frac{2\pi}{\|K(\cdot, f)\|_\infty} \log(R/r)$$

which implies the conclusion of the lemma on setting $A' = f(A)$. \square

In order to prove uniqueness of our welding solution, we will require the following criterion for conformal removability due to Jones and Smirnov. We recall that a set $A \subset \mathbb{C}$ is said to be *conformally removable* if any homeomorphism $g : \mathbb{C} \rightarrow \mathbb{C}$ which is conformal on $\mathbb{C} \setminus A$ is conformal on \mathbb{C} . Let $A \subset \mathbb{C}$ be a proper simply connected domain, we say that A is a *Hölder domain* if the Riemann map from \mathbb{D} to A can be extended to a Hölder continuous map on $\overline{\mathbb{D}}$.

Theorem 2.6 ([14, Corollary 2]). *The boundary of a Hölder domain is conformally removable.*

Applying this to our setting, uniqueness of the welding solution will follow if we can prove that our approximate solutions to the Beltrami equation are uniformly Hölder continuous. The following result verifies this.

We define the sequence of quasiconformal maps F_n by

$$(2.8) \quad \partial_{\bar{z}} F_n = \frac{n}{n+1} \mu \partial_z F_n \quad \text{for a.e. } z \in \mathbb{C}.$$

Since the complex dilatation $\frac{n}{n+1} \mu$ is uniformly bounded away from 1, classical results state that this equation can be solved for each $n \in \mathbb{N}$. Specifically [7, Theorem 5.3.2] states that for each n there exists a unique quasiconformal homeomorphism $F_n : \mathbb{C} \rightarrow \mathbb{C}$ solving the above equation such that

$$(2.9) \quad F_n(z) = z + O(1/z) \quad \text{as } z \rightarrow \infty.$$

Theorem 2.7. *There exists $\gamma_0 \in (0, \sqrt{2})$ such that for $\gamma \in [0, \gamma_0]$ the collection of maps F_n is uniformly Hölder continuous on $\partial\mathbb{D}$ with probability one.*

The proof of this result, given in Sections 3-5, is the most technically challenging part of our work. We are now able to prove our main result. Our proof follows that of [7, Theorem 20.9.4].

Proof of Theorem 1.2. By Theorem 2.7 the sequence F_n almost surely satisfies a uniform Hölder bound on $\partial\mathbb{D}$. We fix a realisation of ϕ_1, ϕ_2 for which this bound holds and also Lemmas 2.3 and 2.4 apply. Hereafter we can argue in a purely deterministic way.

We wish to prove equicontinuity of the sequences F_n and F_n^{-1} . Beginning with the latter, it is clearly sufficient to prove equicontinuity of the inverses of

$$G_n(z) := e^{-4\pi} F_n(e^{4\pi} z).$$

Since the G_n have complex dilatation supported on $\overline{\mathbb{D}}$ we may apply [7, Lemma 20.2.3] which states that

$$|G_n^{-1}(z) - G_n^{-1}(w)| \leq \frac{16\pi^2}{\log(e + 1/|z - w|)} \left(|z|^2 + |w|^2 + \int_{\mathbb{D}} K(\cdot, G_n) \right).$$

By our earlier application of Lemma 2.3, the integral here is bounded uniformly over n and so we deduce the requisite equicontinuity for G_n^{-1} .

We now turn to proving equicontinuity of the sequence F_n . By the uniform Hölder bound of Theorem 2.7, the sequence is clearly equicontinuous on $\partial\mathbb{D}$. So we consider a point $z \in \mathbb{C} \setminus \partial\mathbb{D}$ and choose R such that $B(z, 2R) \subset \mathbb{C} \setminus \partial\mathbb{D}$. For all $n \in \mathbb{N}$, $K(\cdot, F_n) \leq K(\cdot)$ and since the latter is locally bounded, by Lemma 2.5 we see that

$$\frac{\text{diam}F_n(B(z, R))}{\text{diam}F_n(B(z, r))} \rightarrow \infty$$

uniformly in n as $r \rightarrow 0$. Since the F_n are conformal for $|z| > e^{4\pi}$ and normalised at infinity, Koebe's 1/4 theorem shows that $\text{diam}F_n(B(z, R))$ is bounded above uniformly in n and so we deduce the required equicontinuity at points of $\mathbb{C} \setminus \partial\mathbb{D}$.

Applying the Arzelà-Ascoli theorem to F_n and F_n^{-1} we may pass to a subsequence and find a continuous map $F : \mathbb{C} \rightarrow \mathbb{C}$ such that $F_n \rightarrow F$ and $F_n^{-1} \rightarrow F^{-1}$ locally uniformly. Consider now the derivatives of F_n ; we have the elementary distortion identity

$$(2.10) \quad |DF_n(z)| \leq \sqrt{K(z, F_n)J(z, F_n)} \leq \sqrt{K(z)J(z, F_n)}$$

where we recall that DF_n denotes the derivative of F_n and $J(\cdot, F_n)$ denotes its Jacobian. Since F_n is analytic outside the disc of radius $e^{4\pi}$ and has the expansion $F_n(z) = z + O(1/z)$ at ∞ , the area formula [7, Theorem 2.10.1] implies that $\int_{B(0, r)} J(z, F_n)$ is bounded above uniformly over n for any $r \geq e^{4\pi}$. By Lemma 2.4 K is also locally integrable and so applying Hölder's inequality to (2.10) shows that DF_n is uniformly integrable on any compact domain. Hence passing to a further subsequence, DF_n converges weakly in $L_{\text{loc}}^1(\mathbb{C})$ to a limit (this result is sometimes known as the Dunford-Pettis theorem) which must be the derivative of F and so $F \in W_{\text{loc}}^{1,1}(\mathbb{C})$.

Next we must show that $\mu_F = \mu$ almost everywhere. Let $\phi \in C_0^\infty(\mathbb{C})$, then by definition of F_n and weak convergence of the derivatives of F_n

$$(2.11) \quad \int_{\mathbb{C}} \phi (\mu_n - \mu) \partial_z F_n = \int_{\mathbb{C}} \phi (\partial_{\bar{z}} F_n - \mu \partial_z F_n) \rightarrow \int_{\mathbb{C}} \phi (\partial_{\bar{z}} F - \mu \partial_z F)$$

as $n \rightarrow \infty$. Again using identity (2.10) and Hölder's inequality

$$\begin{aligned} \left| \int_{\mathbb{C}} \phi (\mu_n - \mu) \partial_z F_n \right| &\leq \int_{B(0, e^{4\pi})} |\phi| |\mu_n - \mu| |DF_n| \leq \int_{B(0, e^{4\pi})} |\phi| |\mu_n - \mu| \sqrt{KJ(\cdot, F_n)} \\ &\leq \|\phi\|_\infty \left(\int_{B(0, e^{4\pi})} |\mu_n - \mu| K \right)^{1/2} \left(\int_{B(0, e^{4\pi})} J(\cdot, F_n) \right)^{1/2}. \end{aligned}$$

Applying the dominated convergence theorem to the first integral in this upper bound (and recalling that the second is uniformly bounded over n by the area theorem) we see that the left hand side of (2.11) converges to zero. Hence F satisfies the desired Beltrami equation.

We now show that existence of such an F implies the existence of a unique solution to our specified welding problem. We define the maps

$$\begin{aligned} f_1 &:= F \circ \Phi_1 : \overline{\mathbb{D}} \rightarrow F(\overline{\mathbb{D}}) \\ f_2 &:= F \circ \Phi_2 : \mathbb{C} \setminus \mathbb{D} \rightarrow F(\mathbb{C} \setminus \mathbb{D}) \end{aligned}$$

and observe that

$$f_1 \circ \phi_1^{-1} = F|_{\partial\mathbb{D}} = f_2 \circ \phi_2^{-1}.$$

Since K is locally bounded on $\mathbb{C} \setminus \partial\mathbb{D}$ we can apply the Stoilow factorisation theorem [7, Theorem 5.5.1] locally to conclude that f_1 and f_2 are holomorphic and hence solve the welding problem for $\phi_1^{-1} \circ \phi_2$.

To see that the solution is unique (up to Möbius transformations), observe that by Hölder continuity of $F|_{\partial\mathbb{D}}$ and the Jones-Smirnov theorem (Theorem 2.6) the image $F(\partial\mathbb{D})$ is conformally removable. Suppose that $g_1 : \overline{\mathbb{D}} \rightarrow \overline{\Omega}$ and $g_2 : \mathbb{C} \setminus \mathbb{D} \rightarrow \mathbb{C} \setminus \Omega$ is another solution to the welding problem, then the function defined by

$$\begin{cases} g_1 \circ f_1^{-1}(z) & \text{if } z \in F(\overline{\mathbb{D}}) \\ g_2 \circ f_2^{-1}(z) & \text{if } z \in F(\mathbb{C} \setminus \mathbb{D}) \end{cases}$$

is a homeomorphism of \mathbb{C} and conformal off $F(\partial\mathbb{D})$. By conformal removability of the latter set, this map is a Möbius transformation, as required. \square

3. CONDITIONS FOR HÖLDER CONTINUITY

In this section we derive a number of probabilistic statements for events defined by $\tau^{(1)}$ and $\tau^{(2)}$ which imply the conclusion of Theorem 2.7. (These statements are then proven in Sections 4 and 5). We proceed in two steps:

- (1) First we show that Hölder continuity of F_n follows if for any point $x \in \partial\mathbb{D}$, with high probability there exists a sequence of concentric annuli \mathbb{A}_i around x such that $F_n(\mathbb{A}_i)$ has conformal modulus bounded away from zero.
- (2) Next we use basic properties of the conformal modulus and the Beurling-Ahlfors extension to derive conditions on $\tau^{(1)}$ and $\tau^{(2)}$ which ensure that such annuli exist.

3.1. Hölder continuity via ‘good’ annuli. The homeomorphisms F_n , for which we wish to prove uniform Hölder continuity, are characterised by their distortions, which are bounded above by K . Therefore the proof of Theorem 2.7 requires us to translate bounds on the distortion of a function into bounds on its modulus of continuity. We make this link by considering how the function behaves on small annuli centred around points of $\partial\mathbb{D}$. More precisely if we can show that the image of many such annuli have conformal modulus bounded away from zero, then standard estimates allow us to conclude that the function is Hölder continuous on $\partial\mathbb{D}$. This method is implicit in the approach of Lehto [16] to solving degenerate Beltrami equations. The following deterministic lemma makes these ideas rigorous:

We say that a topological annulus $\mathbb{A} \subset \mathbb{C}$ *surrounds* a set $B \subset \mathbb{C}$ if B is contained in the bounded component of \mathbb{A}^c .

Lemma 3.1. *Let $c_1, c_2, c_3, \delta > 0$ and let $f : \mathbb{C} \rightarrow \mathbb{C}$ be a homeomorphism. For each $N \in \mathbb{N}$ let $U_1^{(N)}, \dots, U_{m_N}^{(N)}$ be a partition of $\partial\mathbb{D}$ such that each $U_j^{(N)}$ is connected and has diameter at least $e^{-c_1 N}$. Suppose that for some $N_0 \in \mathbb{N}$ and all $N > N_0$ the following holds: for each $j = 1, \dots, m_N$ there exists a disjoint sequence of topological annuli $\mathbb{A}_1, \dots, \mathbb{A}_{\delta N}$, such that*

- (1) \mathbb{A}_k surrounds \mathbb{A}_{k+1} for all k
- (2) $\mathbb{A}_{\delta N}$ surrounds $U_j^{(N)}$
- (3) The outer diameter of $f(\mathbb{A}_1)$ is at most c_2
- (4) For each k , $\text{mod}f(\mathbb{A}_k) > c_3$

then there exists $C_1, C_2 > 0$ depending only on $c_1, c_2, c_3, \delta, N_0$ such that

$$|f(z_1) - f(z_2)| \leq C_1 |z_1 - z_2|^{C_2}$$

for all $z_1, z_2 \in \partial\mathbb{D}$.

Remark 3.2. In the statement above, δN need not be an integer and so $\mathbb{A}_{\delta N}$ should rigorously be interpreted as $\mathbb{A}_{\lfloor \delta N \rfloor}$ where $\lfloor \delta N \rfloor$ is the integer part of δN . To ease notation we use this convention throughout the paper for integer values indices.

Proof. For $N > N_0$ and $j \in \{1, \dots, m_N\}$ let $\hat{\mathbb{A}}(j)$ be the smallest topological annulus containing $\mathbb{A}_1, \dots, \mathbb{A}_{\delta N}$ (as defined in the statement of the proposition). In other words, the complement of $\hat{\mathbb{A}}(j)$ is made up of the unbounded component of \mathbb{A}_1^c and the bounded component of $\mathbb{A}_{\delta N}^c$. Since $f(\hat{\mathbb{A}}(j))$ contains $f(\mathbb{A}_k)$ for each $k = 1, \dots, \delta N$ the standard composition

law for conformal modulus [2, Theorem 4.2] implies that $\text{mod}f(\hat{\mathbb{A}}(j)) \geq \sum_k \text{mod}f(\mathbb{A}_k)$. By assumption, the latter is at least $c_3(\delta N - 1)$. We recall from the proof of Lemma 2.5 that for any topological annulus $A' \subset \mathbb{C}$

$$\frac{\text{diam}_O A'}{\text{diam}_I A'} \geq \frac{1}{16} e^{\pi \text{mod} A'}.$$

Applying this to $A' = f(\hat{\mathbb{A}}(j))$ we have

$$\text{diam} f(U_j^{(N)}) \leq \text{diam}_I f(\hat{\mathbb{A}}(j)) \leq 16e^{-\pi c_3(\delta N - 1)} \text{diam}_O(f(\mathbb{A}_1)) \leq 16c_2 e^{-\pi(c_3 \delta N - 1)}.$$

Hölder continuity of f now follows from an elementary argument: let $z_1, z_2 \in \partial\mathbb{D}$ with $e^{-c_1(N+1)} \leq |z_1 - z_2| \leq e^{-c_1 N}$ then there is a unique $U_{j_1}^{(N)} \ni z_1$ and $U_{j_2}^{(N)} \ni z_2$. By the assumptions on our partition, these two sets must be the same or else touching (i.e. they have a common limit point). Hence by our upper bound on the diameter of their images, we conclude that

$$|f(z_1) - f(z_2)| \leq 2 \cdot 16c_2 e^{-\pi c_3(\delta N - 1)}$$

which completes the proof of the proposition. \square

Our aim is to apply this lemma to $f = F_n$ and so we might wonder how best to choose a partition and sequences of annuli satisfying the conditions of the lemma?

One might initially choose the \mathbb{A}_i of the previous lemma to be regular annuli centred at equally spaced points on $\partial\mathbb{D}$ which would clearly satisfy the conditions for the partition $U_1^{(n)}, \dots, U_{m_n}^{(n)}$. However since the distortion K is defined in terms of Φ_1^{-1}, Φ_2^{-1} this would require us to find the inverse images of these regular annuli under random homeomorphisms, and then control the distortion of Φ_1, Φ_2 on these sets. This seems difficult if not unfeasible.

Instead we consider deterministic families of regular annuli centred at points of $\partial\mathbb{D}$ and then we map them under Φ_1, Φ_2 to obtain random annuli on which it is easier to control the distortion K (see the bottom panel of Figure 5). This introduces a new difficulty; if A is some topological annulus which intersects both components of $\mathbb{C} \setminus \mathbb{D}$ and we map it using Φ_1 on \mathbb{D} and Φ_2 on $\mathbb{C} \setminus \mathbb{D}$ then its image will no longer be a topological annulus in general. Our method will be to consider families of ‘half-annuli’ inside and outside \mathbb{D} and allow for the possibility that the images under Φ_1 and Φ_2 respectively of different families will match up to form ‘composite annuli’. If we could find enough such composite annuli around each point of $\partial\mathbb{D}$ (such that their images under F_n have conformal modulus bounded away from zero) then we could apply Lemma 3.1 to deduce Hölder continuity. The following lemma gives an explicit statement of this fact.

For notational convenience we will find it simpler to define our half-annuli on $\mathbb{C} \setminus \mathbb{R}$ and work with Ψ_1, Ψ_2 before mapping back to $\mathbb{C} \setminus \partial\mathbb{D}$ (see Figure 5 again). Specifically we denote

$$D[x, r] = [x - r, x + r] \times [0, r], \quad A_t(x) = \text{Clos}(D[x, \rho^t] \setminus D[x, \rho^{t+1/4}])$$

where $\text{Clos}(\cdot)$ denotes the topological closure and $\rho \in (0, 1)$ will be specified later. Furthermore let $\tilde{D}[x, r]$ and $\tilde{A}_t(x)$ be the reflections of $D[x, r]$ and $A_t(x)$ respectively in \mathbb{R} . Recall that we denote the map $z \mapsto e^{2\pi iz}$ by $e(\cdot)$. We let $c_0 > 0$ be a random variable which will be specified in the following lemmas. For $x, y \in [0, 1]$ and $s, t \geq 0$ let $\text{Ann}(x, t, y, s, N)$ be the event that there exists a topological annulus \mathbb{A} such that

- (1) $\mathbb{A} \subseteq \Psi_1(A_t(x)) \cup \Psi_2(\tilde{A}_s(y))$,
- (2) \mathbb{A} surrounds $\Psi_2([y, y + \rho^{(1+\epsilon)5N}])$ and
- (3) $\text{mod} F_n \circ e(\mathbb{A}) > c_0$ for all n .

See Figure 6.

Lemma 3.3. *Let $\delta, \epsilon, C > 0$, $\rho \in (0, 1)$ and a random variable $c_0 > 0$ be given and let F_n be the collection of maps defined by (2.8) and (2.9). Let $\text{AnnSeq}(x, y, N)$ denote the event that there exist two sequences t_1, t_2, \dots and s_1, s_2, \dots satisfying*

- (1) $t_m - t_{m-1}, s_m - s_{m-1} \geq 1/4$ for all $m \geq 2$

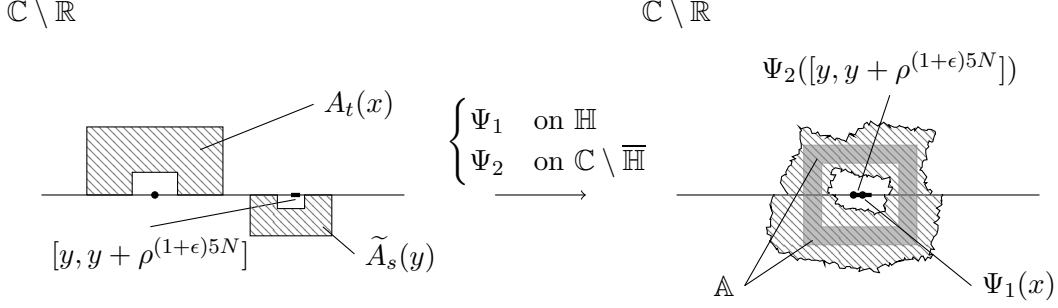

FIGURE 6. An illustration of the event $\text{Ann}(x, t, y, s, N)$. The images of the two half-annuli must ‘match up’ to contain a topological annulus \mathbb{A} which surrounds the interval $\Psi_2([y, y + \rho^{(1+\epsilon)5N}])$. We will later construct \mathbb{A} with straight edges as illustrated, although this is not important for our arguments.

$$(2) \sum_{t_m, s_m \leq 5N} \mathbf{1}_{\text{Ann}(x, t_m, y, s_m, N)} > \delta N.$$

Finally let $\text{Match}(x, y, N)$ denote the event that

$$\Psi_1(x) \in \Psi_2\left([y, y + \rho^{(1+\epsilon)5N}]\right).$$

and suppose that

$$\mathbb{P}(\text{AnnSeq}(x, y, N)^c \cap \text{Match}(x, y, N)) < C\rho^{(2+3\epsilon)5N}$$

for all $x, y \in [0, 1]$ and all $N \in \mathbb{N}$, then with probability one the functions $(F_n)_{n \in \mathbb{N}}$ are uniformly Hölder continuous on $\partial\mathbb{D}$.

Proof. Let $P_N = \{0 = x_0^{(N)}, x_1^{(N)}, \dots, x_{m_N}^{(N)} = 1\}$ where $x_{i+1}^{(N)} - x_i^{(N)} \in [(1/2)\rho^{(1+\epsilon)5N}, \rho^{(1+\epsilon)5N}]$ for all i . For $x \in P_N$ let x^* be the unique point in P_N such that

$$\Psi_2(x^*) \leq \Psi_1(x) < \Psi_2(x^* + \rho^{(1+\epsilon)5N})$$

(i.e. $\text{Match}(x, x^*, N)$ occurs). By the union bound and the assumption of the lemma

$$\begin{aligned} \mathbb{P}(\text{AnnSeq}(x, x^*, N)^c) &= \mathbb{P}\left(\bigcup_{y \in P_N} \text{AnnSeq}(x, y, N)^c \cap \{x^* = y\}\right) \\ (3.1) \quad &\leq \sum_{y \in P_N} \mathbb{P}(\text{AnnSeq}(x, y, N)^c \cap \text{Match}(x, y, N)) \\ &\leq \sum_{y \in P_N} C\rho^{(2+3\epsilon)5N} \leq 2C\rho^{(1+2\epsilon)5N}. \end{aligned}$$

Summing this expression over all $x \in P_N$ and all $N \in \mathbb{N}$ we obtain a finite expression. Hence by the first Borel-Cantelli lemma, there exists N_0 such that for all $N > N_0$ and all $x \in P_N$, the event $\text{AnnSeq}(x, x^*, N)$ occurs.

We now apply Lemma 3.1 to F_n for each $n \in \mathbb{N}$. Specifically we let

$$U_j^{(N)} = e \circ \Psi_2\left([x_{j-1}^{(N)}, x_j^{(N)}]\right),$$

these sets clearly form a partition of $\partial\mathbb{D}$ since $\Psi_2 : [0, 1] \rightarrow [0, 1]$ is a homeomorphism. Moreover since Ψ_2 is Hölder continuous almost surely (Lemma 2.1), the elements of the partition will have sufficiently large diameter. We choose the sequence of concentric annuli to be $e(\mathbb{A}_m)$ where \mathbb{A}_m is defined by the event $\text{Ann}(x, t_m, x^*, s_m)$ whenever it occurs. By assumption we have at least δN such annuli and the conditions on t_m, s_m ensure that they satisfy the four conditions of Lemma 3.1 for $f = F_n$ (the third condition follows from applying

Koebe's 1/4 theorem at infinity). We conclude that the F_n are uniformly Hölder continuous on $\partial\mathbb{D}$ as required. \square

Remark 3.4. In the remainder of our work, the reader will see that the parameter $\epsilon > 0$ plays no essential role. More precisely, for any $\epsilon > 0$ all of our later proofs would be valid by reducing γ (the parameter of our measures) sufficiently. Therefore we now fix a value of $\epsilon > 0$ once and for all. Our motivation for working with an arbitrary value rather than simplifying notation by setting $\epsilon = 1$, is that this generality may be useful in the future for extending our results to higher values of γ .

3.2. Constructing annuli. In order to apply Lemma 3.3 we need to find conditions on ψ_1 and ψ_2 which ensure that pairs of half-annuli $\Psi_1(A_{t_m}(x)), \Psi_2(\tilde{A}_{s_m}(y))$ will contain a complete annulus for which the images under F_n have good conformal moduli.

The first order of business is constructing topological annuli. The Beurling-Ahlfors extension allows us to give some crude geometric estimates on the images of (half)-annuli without much difficulty:

Lemma 3.5. *Let $g : \mathbb{R} \rightarrow \mathbb{R}$ be an increasing homeomorphism and G its Beurling-Ahlfors extension (either the original version defined in [10] or the adjusted version defined in Section 2). Recalling that $D[x, r] = [x - r, x + r] \times [0, r]$ we have for $0 < r < R \leq 1$*

$$G(D[x, R] \setminus D[x, r]) \supseteq D[g(x), R'] \setminus D[g(x), r']$$

where

$$R' = \frac{1}{2} \min_{k=1, \dots, 8} g\left(x - R + \frac{kR}{4}\right) - g\left(x - R + \frac{(k-1)R}{4}\right)$$

$$r' = g(x + 2r) - g(x - 2r).$$

Proof. Without loss of generality, we may assume $x = 0$. From the definition of the Beurling-Ahlfors extension in (2.1), we see that for $u + iv \in D[0, r]$ we have

$$|\operatorname{Re} G(u + iv) - g(0)| \leq \max\{g(2r) - g(0), g(0) - g(-2r)\}$$

$$\operatorname{Im} G(u + iv) \leq g(2r) - g(-2r).$$

Combining these estimates proves that $G(D[x, r]) \subseteq D[g(x), r']$.

Next we observe, again by the definition in (2.1), that for $u \in \mathbb{R}$ and $v \in [0, 1]$

$$\operatorname{Im} G(u + iv) \geq \frac{1}{2}(g(u + v/2) - g(u - v/2)).$$

If $u + iv \in [(k-5)R/4 + iR/2, (k-4)R/4 + iR/2]$ for some $k = 1, \dots, 8$ then since g is increasing, we see $\operatorname{Im} G(u + iv) \geq \frac{1}{2}(g((k-4)R/4) - g((k-5)R/4))$. Therefore on the line segment $[-R + iR/2, R + iR/2]$, the imaginary part of G is bounded below by R' .

Finally we note that on $[R, R + iR/2]$ the real part of G is bounded below by $g(R/2)$ whilst on $[-R, -R + iR/2]$ there is a corresponding upper bound of $g(-R/2)$. Since G is a homeomorphism of \mathbb{H} , the union of the previous three line segments will form a path in \mathbb{H} with end-points in \mathbb{R} . The bounds on the real and imaginary parts of this image ensure that $G(D[x, R]) \supseteq D[g(x), R']$. Combined with the earlier statement for $D[x, r]$, this proves the lemma. \square

Next we need to give lower bounds on the conformal modulus of the images of annuli under F_n . We obtain bounds in terms of the distortion of these maps directly from the definition of conformal modulus:

Lemma 3.6. *Let $A \subset \mathbb{C}$ be a compact topological annulus and f be a quasiconformal map defined on some neighbourhood of A , then*

$$\operatorname{mod} f(A) \geq \frac{(\operatorname{Th} A)^2}{\int_A K(z, f) d\mathcal{H}^2(z)}$$

where $\text{Th}(A)$ is the thickness of A (i.e. the distance between the components of its complement) and \mathcal{H}^2 denotes Hausdorff measure.

Proof. Let $\mathcal{C}_{f(A)}$ denote the set of rectifiable, injective curves in $f(A)$ joining the inner and outer boundary components. An elementary calculation for regular annuli [3, Examples 2-3] (along with conformal invariance of the modulus - recall the definition given after the statement of Lemma 2.5) shows that $\text{mod } \mathcal{C}_{f(A)} = 1/\text{mod } f(A)$. Let \mathcal{C}_A be defined analogously to $\mathcal{C}_{f(A)}$. Since f is quasiconformal, we can map between \mathcal{C}_A and $\mathcal{C}_{f(A)}$ up to sets of conformal modulus zero. More precisely, by [16, III Theorem 6.2] there exist $\mathcal{C}'_A \subseteq \mathcal{C}_A$ and $\mathcal{C}'_{f(A)} \subseteq \mathcal{C}_{f(A)}$ such that

$$\gamma \in \mathcal{C}'_A \Leftrightarrow f \circ \gamma \in \mathcal{C}'_{f(A)} \quad \text{and} \quad \text{mod } \mathcal{C}_A \setminus \mathcal{C}'_A = \text{mod } \mathcal{C}_{f(A)} \setminus \mathcal{C}'_{f(A)} = 0.$$

Therefore $\text{mod } \mathcal{C}'_{f(A)} = \text{mod } \mathcal{C}_{f(A)} = 1/\text{mod } f(A)$. Moreover the proof of the cited result shows that for $\gamma \in \mathcal{C}'(A)$ the derivative of $f \circ \gamma$ is equal to $Df(\gamma_t)\gamma'_t$ for almost every t where Df denotes the (total) derivative of f .

We define a non-negative measurable function ρ by

$$\rho(w) := (\text{Th}A)^{-1} (|\partial_z f| - |\partial_{\bar{z}} f|)^{-1} \circ f^{-1}(w)$$

for $w \in f(A)$. Given $\tilde{\gamma} \in \mathcal{C}'_{f(A)}$, the curve $\gamma := f^{-1} \circ \tilde{\gamma}$ is rectifiable. By the above expression for the derivative of $\tilde{\gamma} = f \circ \gamma$

$$\int_{\tilde{\gamma}} \rho(w) |dw| = (\text{Th}A)^{-1} \int_{\gamma} \frac{|Df(z)dz|}{|\partial_z f| - |\partial_{\bar{z}} f|} \geq (\text{Th}A)^{-1} \int_{\gamma} |dz| \geq 1$$

where the inequality follows because for $\zeta \in \mathbb{C}$ we have $Df(z)\zeta = \partial_z f(z)\zeta + \partial_{\bar{z}} f(z)\bar{\zeta}$. Hence by the definition of conformal modulus

$$\frac{1}{\text{mod } f(A)} = \text{mod } \mathcal{C}'_{f(A)} \leq \int_{f(A)} \rho^2(w) d\mathcal{H}^2(w) = (\text{Th}A)^{-2} \int_{f(A)} \frac{d\mathcal{H}^2(w)}{(|\partial_z f| - |\partial_{\bar{z}} f|)^2}.$$

Recalling that the Jacobian of f can be written as $|\partial_z f|^2 - |\partial_{\bar{z}} f|^2$, by the change of variables formula for quasiconformal maps [7, Theorem 3.8.1], the rightmost term above is equal to

$$(\text{Th}A)^{-2} \int_A \frac{|\partial_z f| + |\partial_{\bar{z}} f|}{|\partial_z f| - |\partial_{\bar{z}} f|} d\mathcal{H}^2(z) = (\text{Th}A)^{-2} \int_A K(z, f) d\mathcal{H}^2(z).$$

Combining the previous two equations completes the proof. \square

We will apply the previous lemma with $f = F_n$ and A contained in the union of the images under Ψ_1 and Ψ_2 of two half-annuli. The thickness of this annulus will be controlled by Lemma 3.5 and the average distortion on the annulus is bounded by a change of variables:

Lemma 3.7. *Let $\mathcal{A} = D[0, R] \setminus D[0, r]$ for some $0 < r < R < 1$ then*

$$\begin{aligned} \int_{\Psi_1(\mathcal{A})} K(z, \Psi_1^{-1}) d\mathcal{H}^2(z) &\leq 2^5 |\psi_1(2R) - \psi_1(-2R)|^2 \\ &\quad + 2^7 \sum_{m=0}^{\infty} \sum_{\ell \in S(m, r, R)} |\psi_1((\ell + 2)R2^{-m}) - \psi_1((\ell - 2)R2^{-m})|^2 \end{aligned}$$

where $S(m, r, R) := \{\ell \in \mathbb{Z} \mid r \leq R2^{-m}|\ell| \leq R\}$. Moreover the same inequality holds if we replace Ψ_1, ψ_1 by Ψ_2, ψ_2 and reflect \mathcal{A} in the real axis.

Proof. This follows from essentially the same argument as in the proof of Lemma 2.4. By a change of variables and Lemma 2.2

$$\int_{\Psi_1(\mathcal{A})} K(z, \Psi_1^{-1}) d\mathcal{H}^2(z) = \int_{\mathcal{A}} |D\Psi_1(w)|^2 d\mathcal{H}^2(w) \leq 16 \int_{\mathcal{A}} \frac{|\psi_1(x+y) - \psi_1(x-y)|^2}{y^2} dx dy.$$

Let $\mathcal{A}_1 = [-r, r] \times [r, R]$ and $\mathcal{A}_2 = \mathcal{A} \setminus \mathcal{A}_1$. Since ψ_1 is increasing

$$\begin{aligned} \int_{\mathcal{A}_1} \frac{|\psi_1(x+y) - \psi_1(x-y)|^2}{y^2} dx dy &\leq |\psi_1(2R) - \psi_1(-2R)|^2 \int_{-r}^r \int_r^R \frac{1}{y^2} dy dx \\ &\leq 2|\psi_1(2R) - \psi_1(-2R)|^2. \end{aligned}$$

Turning to \mathcal{A}_2 and again using the fact that ψ_1 is increasing;

$$\begin{aligned} \int_{\mathcal{A}_2} \frac{|\psi_1(x+y) - \psi_1(x-y)|^2}{y^2} dx dy &\leq \sum_{m=0}^{\infty} R^{-2} 2^{2(m+1)} \int_{\mathcal{A}_2 \cap \{R2^{-(m+1)} < y \leq R2^{-m}\}} |\psi_1(x + R2^{-m}) - \psi_1(x - R2^{-m})|^2 dx dy \\ &\leq \sum_{m=0}^{\infty} R^{-1} 2^{m+2} \int_{[-R, r] \cup [r, R]} |\psi_1(x + R2^{-m}) - \psi_1(x - R2^{-m})|^2 dx. \end{aligned}$$

By similar reasoning, for each m

$$\begin{aligned} \int_{[-R, r] \cup [r, R]} |\psi_1(x + R2^{-m}) - \psi_1(x - R2^{-m})|^2 dx &\leq \sum_{\ell \in S(m, r, R)} \int_{[(\ell-1)R2^{-m}, (\ell+1)R2^{-m}]} |\psi_1((\ell+2)R2^{-m}) - \psi_1((\ell-2)R2^{-m})|^2 dx \\ &\leq \sum_{\ell \in S(m, r, R)} R2^{-m+1} |\psi_1((\ell+2)R2^{-m}) - \psi_1((\ell-2)R2^{-m})|^2 \end{aligned}$$

and combining the previous four displayed equations completes the proof of the lemma. \square

Combining the previous three lemmas, we may now give sufficient conditions (in terms of ψ_1 and ψ_2) to construct topological annuli which satisfy the assumptions of Lemma 3.3. Letting $\rho, \epsilon \in (0, 1)$ and $x, y \in [0, 1]$ be given, for $t \geq 0$, $\ell \in \mathbb{Z}$ and $m \in \mathbb{N}$ we define

$$B_t = [-\rho^t, \rho^t], \quad J_{t, \ell} = \left[\rho^t \frac{\ell-5}{4}, \rho^t \frac{\ell-4}{4} \right], \quad I_{m, \ell, t} = [(\ell-2)\rho^t 2^{-m}, (\ell+2)\rho^t 2^{-m}]$$

and

$$\begin{aligned} \text{Shape}^{(1)}(t) &:= \left\{ \min_{l=1, \dots, 8} \frac{\tau^{(1)}(x + J_{t, \ell})}{\tau^{(1)}(x + B_t)} \geq 2^{-9} \right\} \cap \left\{ \frac{\tau^{(1)}(x + 2B_{t+1/4})}{\tau^{(1)}(x + B_t)} \leq 2^{-33} \right\} \cap \\ &\quad \left\{ \frac{\tau^{(1)}(x + 2B_t)}{\tau^{(1)}(x + B_t)} \leq 2^7 \right\} \cap \left\{ \sum_{m=0}^{\infty} \sum_{\ell \in S(m, \rho^{t+1/4}, \rho^t)} \frac{\tau^{(1)}(x + I_{m, \ell, t})^2}{\tau^{(1)}(x + B_t)^2} \leq 2^{13} \right\}. \end{aligned}$$

Intuitively this event controls the ‘shape’ of the image $\Psi^{(1)}(A_t(x))$. We define $\text{Shape}^{(2)}(t)$ analogously after replacing x by y and $\tau^{(1)}$ by $\tau^{(2)}$. We further define $\text{Centre}(N)$ for $N \in \mathbb{N}$ and $\text{Size}(t, s)$ for $t, s \geq 0$ by

$$\text{Centre}(N) := \left\{ \frac{\tau^{(2)}([y, y + \rho^{(1+\epsilon)5N}])}{\tau^{(2)}(y + B_{5N+1})} \leq 2^{-23} \right\}$$

and

$$\text{Size}(t, s) := \left\{ 2^{-11} \leq \frac{\tau^{(1)}(x + B_t)}{\tau^{(1)}([0, 1])} / \frac{\tau^{(2)}(y + B_s)}{\tau^{(2)}([0, 1])} \leq 2^{11} \right\}.$$

The former event, combined with $\text{Match}(x, y, N)$, ensures that $\Psi^{(1)}(x)$ and $\Psi^{(2)}(y)$ are very close. The latter event controls the relative sizes of $\Psi^{(1)}(A_t(x))$ and $\Psi^{(2)}(\tilde{A}_t(y))$. Note that these events depend on x and y but this is suppressed in the notation. For all of the events

above, we interpret the sets as being defined on \mathbb{R}/\mathbb{Z} (so for example $B_t = [-\rho^t, \rho^t] = [0, \rho^t] \cup [1 - \rho^t, 1]$).

Proposition 3.8. *Let $0 \leq t, s \leq 5N$ and $\rho \in (0, 1)$ and define*

$$\text{Ann}'(x, t, y, s, N) := \text{Size}(t, s) \cap \text{Shape}^{(1)}(t) \cap \text{Shape}^{(2)}(s) \cap \text{Centre}(N).$$

There exists a random variable $c_0 > 0$ (depending only on $\tau^{(j)}([0, 1])$ for $j = 1, 2$) such that for all $x, y \in [0, 1]$

$$\text{Ann}'(x, t, y, s, N) \cap \text{Match}(x, y, N) \subseteq \text{Ann}(x, t, y, s, N)$$

where $\text{Match}(x, y, N)$ and $\text{Ann}(x, t, y, s)$ are as defined in Lemma 3.3. In particular, the statement of Lemma 3.3 is valid with $\text{Ann}'(\cdot)$ replacing $\text{Ann}(\cdot)$.

Proof. By Lemma 3.5 (applied to $g = \psi_1$) on $\text{Shape}^{(1)}(t) \cap \text{Size}(t, s)$ we have

$$\begin{aligned} \Psi_1(A_t(x)) &\supseteq D \left[\psi_1(x), \frac{1}{2} \min_{\ell=1, \dots, 8} \frac{\tau^{(1)}(x + J_{t, \ell})}{\tau^{(1)}([0, 1])} \right] \setminus D \left[\psi_1(x), \frac{\tau^{(1)}(x + 2B_{t+1/4})}{\tau^{(1)}([0, 1])} \right] \\ &\supseteq \psi_1(x) + \frac{\tau^{(1)}(x + B_t)}{\tau^{(1)}([0, 1])} D[0, 2^{-10}] \setminus D[0, 2^{-33}] \\ &\supseteq \psi_1(x) + \frac{\tau^{(2)}(y + B_s)}{\tau^{(2)}([0, 1])} D[0, 2^{-21}] \setminus D[0, 2^{-22}]. \end{aligned}$$

Similarly on $\text{Shape}^{(2)}(s)$ we have

$$\Psi_2(\tilde{A}_s(y)) \supseteq \psi_2(y) + \frac{\tau^{(2)}(y + B_s)}{\tau^{(2)}([0, 1])} \tilde{D}[0, 2^{-10}] \setminus \tilde{D}[0, 2^{-33}].$$

On the event $\text{Centre}(N) \cap \text{Match}(x, y, N)$, we see that

$$|\psi_2(y) - \psi_1(x)| \leq \frac{\tau^{(2)}([y, y + \rho^{(1+\epsilon)5N}])}{\tau^{(2)}([0, 1])} \leq 2^{-23} \frac{\tau^{(2)}(y + B_s)}{\tau^{(2)}([0, 1])}$$

which combined with the previous inclusion implies that

$$(3.2) \quad \Psi_2(\tilde{A}_s(y)) \supseteq \psi_1(x) + \frac{\tau^{(2)}(y + B_s)}{\tau^{(2)}([0, 1])} \tilde{D}[0, 2^{-11}] \setminus \tilde{D}[0, 2^{-22}].$$

We therefore define

$$\mathbb{A} := \psi_1(x) + 2^{-22} \frac{\tau^{(2)}(y + B_s)}{\tau^{(2)}([0, 1])} [-2, 2]^2 \setminus [-1, 1]^2 \subseteq \Psi_1(A_t(x)) \cup \Psi_2(\tilde{A}_s(y))$$

which is a topological annulus that surrounds $\Psi_2(y + [0, \rho^{(1+\epsilon)N}])$.

By Lemma 3.7 (applied to $g = \psi_1, \psi_2$) on $\text{Shape}^{(1)}(t) \cap \text{Size}(t, s)$ we have

$$\int_{\Psi_1(A_t(x))} K(z, \Psi_1^{-1}) d\mathcal{H}^2(z) \leq (2^{19} + 2^{20}) \tau^{(1)}(x + B_t)^2 \leq 2^{43} \tau^{(1)}([0, 1])^2 \left(\frac{\tau^{(2)}(y + B_s)}{\tau^{(2)}([0, 1])} \right)^2$$

and on $\text{Shape}^{(2)}(s)$

$$\int_{\Psi_2(\tilde{A}_s(y))} K(z, \Psi_2^{-1}) d\mathcal{H}^2(z) \leq 2^{21} \tau^{(2)}([0, 1])^2 \left(\frac{\tau^{(2)}(y + B_s)}{\tau^{(2)}([0, 1])} \right)^2.$$

It follows easily from the chain rule for Wirtinger derivatives that the distortion is preserved under pre- or post-composition by a conformal map. More precisely, for differentiable maps f

and g , if g is conformal then $K(z, f \circ g) = K(g(z), f)$ and if f is conformal then $K(z, f \circ g) = K(z, g)$. Using this observation along with the definition of K in (2.3), we see that for all n

$$\begin{aligned} \int_{\mathbb{A}} K(z, F_n \circ e) d\mathcal{H}^2(z) &\leq \int_{\mathbb{A}} K(e(z)) d\mathcal{H}^2(z) \\ &\leq \int_{\Psi_1(A_t(x))} K(z, \Phi_1^{-1} \circ e) d\mathcal{H}^2(z) + \int_{\Psi_2(\tilde{A}_s)} K(z, \Phi_2^{-1} \circ e) \\ &= \int_{\Psi_1(A_t(x))} K(z, \Psi_1^{-1}) d\mathcal{H}^2(z) + \int_{\Psi_2(\tilde{A}_s)} K(z, \Psi_2^{-1}) \end{aligned}$$

where the final equality uses the fact that $e \circ \Psi_j^{-1} = \Phi_j^{-1} \circ e$. Combining the previous bounds with Lemma 3.6 we have

$$\text{mod } F_n \circ e(\mathbb{A}_{t,s}) \geq \frac{2^{-44}}{2^{43}(\tau^{(1)}([0,1]^2 + \tau^{(2)}([0,1]))^2)}$$

which completes the proof of the lemma on defining c_0 to be the right hand side. \square

4. AN APPROXIMATE DECOMPOSITION FOR THE MEASURES

To summarise the analysis of the previous section: if we can show that $\text{Ann}'(x, t_m, y, s_m, N)$ occurs for sufficiently many pairs (t_m, s_m) with high probability then we may deduce the desired Hölder continuity bound on the family of maps F_n . The events $\text{Ann}'(x, t, y, s, N)$ (defined in terms of the measures $\tau^{(1)}$ and $\tau^{(2)}$) have strong dependence for different values of t and s . In this section we show that for many values of t and s , the measures $\tau^{(1)}$ and $\tau^{(2)}$ can be approximately decomposed over different scales. This decomposition will allow us to control the dependence between the events $\text{Ann}'(\cdot)$.

4.1. Outline of the decomposition. We begin by roughly describing the decomposition and giving some intuition for why it is useful.

Recall that for $a > 0$, the continuous Gaussian process $H_a(\cdot)$ is defined in Lemma 1.1 with respect to the white noise above height a . For $u \in [0, 1]$, $0 < a \leq b$ and $j = 1, 2$ we define

$$\begin{aligned} E^{(j)}(u, a) &:= \exp\left(\gamma H_a^{(j)}(u) - \frac{\gamma^2}{2} \text{Var}[H_a^{(j)}(0)]\right), \\ E^{(j)}(u, a, b) &:= \frac{E^{(j)}(u, a)}{E^{(j)}(u, b)}. \end{aligned}$$

For $t \geq 0$, let $\tau_t^{(j)}$ denote the measure $\tau^{(j)}$ defined by the restriction of the white noise to $\{(x, y) \in \mathbb{H} \mid y \leq \rho^t\}$. More precisely, $\tau_t^{(j)}$ is defined as in (1.2) after replacing \mathcal{H} by $\{(x, y) \in \mathcal{H} \mid y \leq \rho^t\}$ in Lemma 1.1. Then by independence of the white noise process on disjoint domains

$$(4.1) \quad \tau_t^{(j)}(du) = \lim_{\xi \rightarrow 0^+} E^{(j)}(u, \xi, \rho^t) e^{-\gamma G 2^{\gamma^2}} du, \quad \text{and} \quad \tau^{(j)}(du) = \lim_{\xi \rightarrow 0^+} E^{(j)}(u, \xi) e^{-\gamma G 2^{\gamma^2}} du$$

where convergence is in the weak-* topology.

Now consider the events $\text{Shape}^{(1)}(t)$, $\text{Shape}^{(2)}(s)$ and $\text{Size}(t, s)$. For the moment, to simplify exposition, let us treat $\tau^{(1)}([0, 1])$ and $\tau^{(2)}([0, 1])$ as constants, set $x, y = 0$ and assume that t, s are integers. Our events of interest are therefore determined by $\tau^{(1)}$ restricted to B_t and $\tau^{(2)}$ restricted to B_s . The essence of our argument is the approximation

$$(4.2) \quad \tau^{(j)}(I) \simeq \tau_t^{(j)}(I \setminus B_{t+3/4}) \cdot E^{(j)}(0, \rho^t)$$

for intervals $I \subset B_t$ which are not too small. Intuitively this follows from (4.1) by replacing $E^{(j)}(u, \xi, \rho^t)$ with $E^{(j)}(u, \xi)/E^{(j)}(0, \rho^t)$ and treating $B_{t+3/4}$ as negligible. Note that $\tau^{(j)}(I)$ is determined by the behaviour of the hyperbolic white noise on the region shown in Figure 7a whilst our approximation depends only on the smaller region shown in Figure 7b.

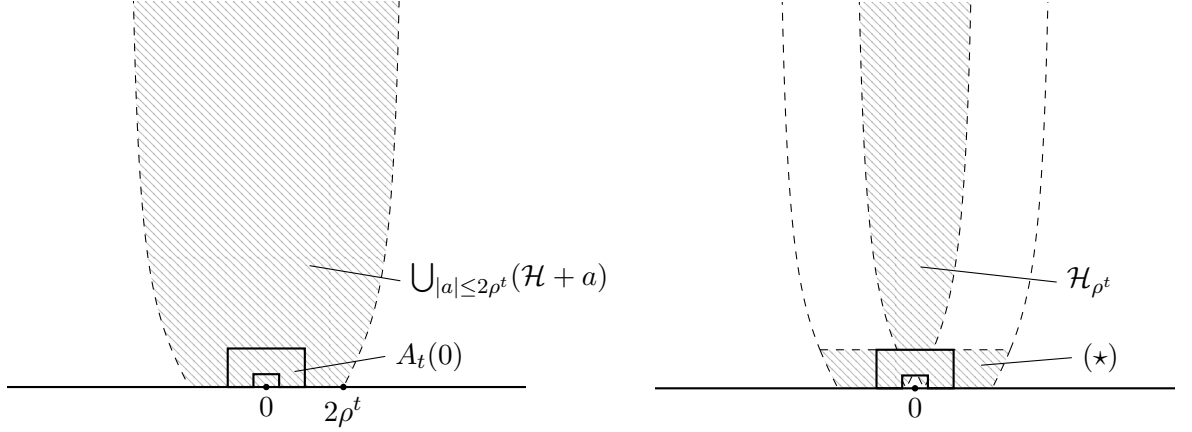

(a) The restriction of $\tau^{(1)}$ to B_t is determined by the white noise restricted to $\bigcup_{|a| \leq 2\rho^t} (\mathcal{H} + a)$.

(b) The approximation in (4.2) is determined by the white noise restricted to $\mathcal{H}_{\rho^t} \cup (\star)$ where $(\star) = \bigcup_{\rho^{t+1/4} \leq |a| \leq 2\rho^t} (\mathcal{H} + a) \cap \{y \leq \rho^t\}$.

FIGURE 7

If we substitute the right hand side of (4.2) into $\text{Shape}^{(1)}(t)$ then the exponential terms cancel and we obtain an intersection of events of the form

$$(4.3) \quad \frac{\tau_t^{(1)}((\rho^t \cdot I) \setminus B_{t+3/4})}{\tau_t^{(1)}((\rho^t \cdot J) \setminus B_{t+3/4})} \leq c$$

for intervals I, J which each have length of order 1. These events depend (through the hyperbolic white noise) on disjoint regions for distinct integer values of t (see Figure 8) and so are independent. Moreover as t increases, a basic scaling argument for the white noise shows that $\rho^{-t} \tau_t^{(1)}(\rho^t \cdot \cdot)$ converges in distribution to a non-degenerate random measure. Hence the intersection of events of the form (4.3) will approach an i.i.d. sequence for large values of t , so we can easily prove large deviation bounds for the number of such events which occur.

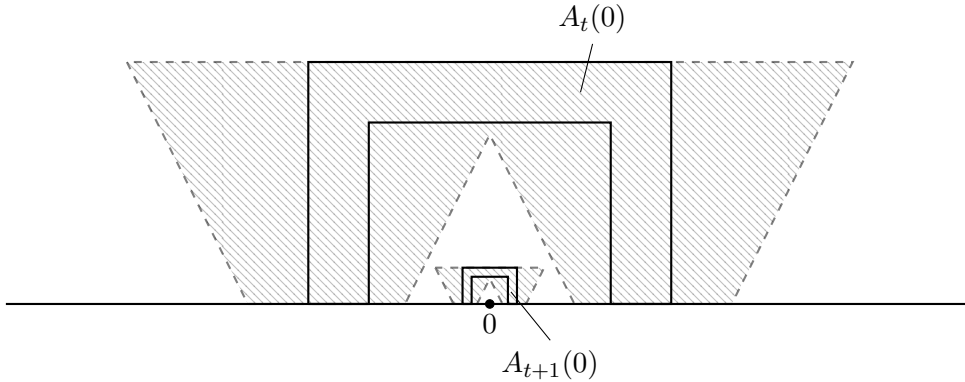

FIGURE 8. Events of the form (4.3) are determined by the white noise restricted to the shaded region containing $A_t(0)$. Such regions are disjoint for t and $t + 1$, implying that the corresponding events are independent. (Note: this illustration is not to scale.)

Turning to $\text{Size}(t, s)$, if we now replace $\tau^{(1)}(B_t)$ and $\tau^{(2)}(B_s)$ by their approximations according to (4.2) then we obtain an event of the form

$$(4.4) \quad c^{-1} \leq \frac{\rho^{-t} \tau^{(1)}(B_t \setminus B_{t+3/4})}{\rho^{-s} \tau^{(2)}(B_s \setminus B_{s+3/4})} \cdot \exp(\star) \leq c$$

where

$$\star = \gamma H_{\rho^t}^{(1)}(x) - \gamma H_{\rho^s}^{(2)}(y) - (1 + \gamma^2/2)(t - s) \log(1/\rho).$$

(Note that we have treated $\tau^{(1)}([0, 1])$ and $\tau^{(2)}([0, 1])$ as constants and approximated the variance of $H_{\xi}^{(j)}(0)$ by $\log(1/\xi)$.) By a simple telescoping:

$$\gamma H_{\rho^t}^{(1)}(x) - t(1 + \gamma^2/2) \log(1/\rho) = \gamma H_0^{(1)}(x) + \sum_{k=1}^t (\gamma H_{\rho^k}^{(1)}(x) - \gamma H_{\rho^{k-1}}^{(1)}(x) - (1 + \gamma^2/2) \log(1/\rho)),$$

the terms making up \star can be expressed as sums of independent Gaussian variables (see Figure 9). Proving that (4.4) occurs for many values of t and s thus reduces to the study of two independent, biased random walks. We analyse this situation in Section 5.

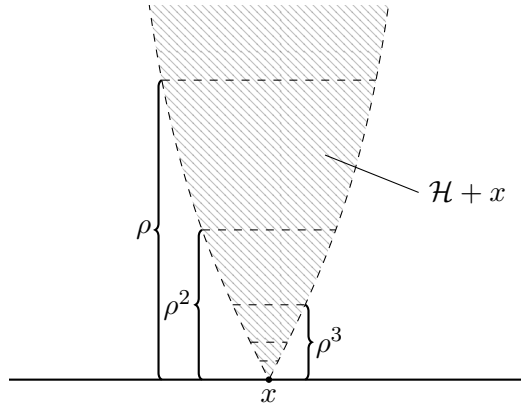

FIGURE 9. The Gaussian variable $H_{\rho^{t+1}}^{(1)}(x) - H_{\rho^t}^{(1)}(x)$ is determined by the white noise restricted to $(\mathcal{H} + x) \cap \{\rho^{t+1} \leq y \leq \rho^t\}$ and so these variables are independent for different integer values of t .

4.2. Sufficient conditions for the approximation. We now begin to justify the approximation described above rigorously. In this subsection we introduce a number of events which ensure that (4.2) is valid, allow us to deal with non-integer values of t and s and justify treating $\tau^{(1)}([0, 1])$ and $\tau^{(2)}([0, 1])$ as constants (for our purposes). In the next subsection we will show that these events occur with high probability for many values of t and s .

Upper-scale correlations: First we consider how to approximate the term $E^{(j)}(u, \epsilon, \rho^t)$ in (4.1). For $k \in \mathbb{N} \cup \{0\}$ and a Borel set I , we define

$$\mathcal{S}_k^{(1)}(I) := \sup_{u \in I} \frac{E^{(1)}(u, \rho^{k+1}, \rho^k)}{E^{(1)}(x, \rho^{k+1}, \rho^k)}, \quad \mathcal{S}_{-1}^{(1)}(I) := \sup_{u \in I} \frac{E^{(1)}(u, 1)}{E^{(1)}(x, 1)},$$

and we define $\mathcal{I}_k^{(1)}(I)$ to be the corresponding infima. Moreover we define analogous quantities $\mathcal{S}_k^{(2)}(\cdot)$ and $\mathcal{I}_k^{(2)}(\cdot)$ by replacing $E^{(1)}$ with $E^{(2)}$ and x with y .

From (4.1) we see that for any Borel set I and $n \in \mathbb{N}$

$$(4.5) \quad \prod_{k=-1}^{n-1} \mathcal{I}_k^{(1)}(I) \leq \frac{\tau^{(1)}(I)}{\tau_n^{(1)}(I) E^{(1)}(x, \rho^n)} \leq \prod_{k=-1}^{n-1} \mathcal{S}_k^{(1)}(I).$$

Therefore if each of these suprema/infima is close to one, we can justify the first part of our approximation. Accordingly we define the events

$$\begin{aligned} \text{Upp}_{n,k}^{(1)} &:= \left\{ \log \mathcal{S}_k^{(1)}(x + 2B_n) \leq 2^{k-n} \log(2) \right\} \cap \left\{ \log \mathcal{I}_k^{(1)}(x + 2B_n) \geq -2^{k-n} \log(2) \right\}, \\ \text{Upp}_n^{(1)} &:= \bigcap_{k=-1}^{n-1} \text{Upp}_{n,k}^{(j)} \end{aligned}$$

and note that on $\text{Upp}_n^{(1)}$ we have

$$1 \leq \prod_{k=-1}^{n-1} \mathcal{S}_k^{(1)}(x + 2B_n) \leq 2, \quad \text{and} \quad \frac{1}{2} \leq \prod_{k=-1}^{n-1} \mathcal{I}_k^{(1)}(x + 2B_n) \leq 1.$$

We define $\text{Upp}_{n,k}^{(2)}$ and $\text{Upp}_n^{(2)}$ analogously on replacing x by y and $\mathcal{S}_k^{(1)}, \mathcal{I}_k^{(1)}$ by $\mathcal{S}_k^{(2)}, \mathcal{I}_k^{(2)}$. The notation ‘Upp’ (short for upper-scale correlations) is to indicate that these events account for removing the dependency on the two upper regions of white noise in Figure 7b. We can obtain probability bounds on these events using standard estimates for the supremum of a Gaussian process (i.e. the Borell-TIS inequality), and will do so in the next subsection.

Lower-scale correlations: We next wish to justify replacing $\tau_t(I)$ in (4.1) by $\tau_t(I \setminus B_{t+3/4})$ in (4.2). To do so we simply consider events on which the measure of $B_{t+3/4}$ is small relative to that of the sets we are interested in: for $n, k \in \mathbb{N}$ with $k \geq n$ we define

$$\text{Low}_{n,k}^{(1)} := \left\{ \frac{\tau_n^{(1)}(x + B_{k+3/4} \setminus B_{k+7/4})}{\tau_n^{(1)}(x + B_{n+1/2} \setminus B_{n+3/4})} \leq 2^{n-k-41} \right\}, \quad \text{Low}_n^{(1)} := \bigcap_{k=n}^{\infty} \text{Low}_{n,k}^{(1)}.$$

Similarly we define $\text{Low}_{n,k}^{(2)}$ and $\text{Low}_n^{(2)}$ by replacing $\tau_n^{(1)}$ and x with $\tau_n^{(2)}$ and y respectively. By countable additivity of measures, on $\text{Low}_n^{(1)}$ we have

$$(4.6) \quad \frac{\tau_n^{(1)}(x + B_{n+3/4})}{\tau_n^{(1)}(x + B_{n+1/2} \setminus B_{n+3/4})} \leq 2^{-40}.$$

This event accounts for the dependence of the hyperbolic white noise in the lower unshaded region of Figure 7b. In the next subsection we will control the probability of these events using moment bounds on $\tau_n^{(j)}(\cdot)$. In anticipation of this, we observe that the events $\text{Low}_{n_1,k_1}^{(j)}$ and $\text{Low}_{n_2,k_2}^{(j)}$ depend on disjoint regions of the white noise whenever $k_1 + 2 \leq n_2$ (provided that $\rho \leq 1/16$, in which case these regions look qualitatively similar to those in Figure 8) and so are independent.

Fractional-scale correlations: The events defined so far control the behaviour of our measures on integer scales (i.e. for $t, s \in \mathbb{N}$). In order to extend this control to non-integer scales we consider the following event:

$$\text{Frac}_n^{(1)} := \left\{ \sup_{t \in [n, n+1/2]} \sup_{u \in (x+2B_n)} \left| \log E^{(1)}(u, \rho^t, \rho^n) \right| < \log(2) \right\}.$$

On this event, for any $t \in [n, n+1/2]$ and $I \subseteq (x+2B_n)$ we see from (4.1) that

$$(4.7) \quad \frac{1}{2} \tau_n^{(1)}(I) \leq \tau_t^{(1)}(I) \leq 2 \tau_n^{(1)}(I).$$

We define $\text{Frac}_n^{(2)}$ analogously. The probability of these events can once again be controlled through consideration of the supremum of a continuous Gaussian process.

Scaling-limit correlations: In the heuristics of the previous subsection we approximated the variance of $H_\epsilon^{(j)}$ by $\log(1/\epsilon)$. This is useful as it allows us to consider random walks with constant bias in the next section. To justify the approximation, we will define two fields $V^{(1)}$

and $V^{(2)}$ which are close to $H^{(1)}$ and $H^{(2)}$ and satisfy an exact scaling relation (as opposed to the approximate scaling relation satisfied by the $H^{(j)}$).

We define

$$\mathcal{V} = \{(x, y) \in \mathbb{H} \mid 2|x| \leq y \leq 1/2\}$$

and for $0 < \xi \leq 1/2$

$$V_\xi^{(j)}(u) = W^{(j)}((\mathcal{V} + u) \cap \{y \geq \xi\})$$

where $W^{(j)}$ is the white noise associated with the measure $\tau^{(j)}$. Direct computation shows that $\text{Var}[V_\xi^{(j)}(u)] = -\log(\xi)$. Analogously with the measures $\tau_t^{(j)}$ we define $\nu_t^{(j)}$ by

$$(4.8) \quad \lim_{\xi \rightarrow 0^+} \exp\left(\gamma(V_\xi^{(j)}(u) - V_{\rho^t}^{(j)}(u)) - \frac{\gamma^2}{2} \text{Var}[V_\xi^{(j)}(u) - V_{\rho^t}^{(j)}(u)]\right) dx = \nu_t^{(j)}(dx).$$

More precisely, it was shown in [8, Section 3.3] that there exists a version of hyperbolic white noise for which both $V_\xi^{(j)}$ and $H_\xi^{(j)}$ can be defined continuously and the measures $\nu_t^{(j)}$ and $\tau_t^{(j)}$ defined by (1.2) and (4.8) exist.

From Figure 10 we see that \mathcal{V} approximates \mathcal{H} close to the real axis and so we expect that $\nu_t^{(j)}$ should be a good approximation for $\tau_t^{(j)}$ whenever t is large.

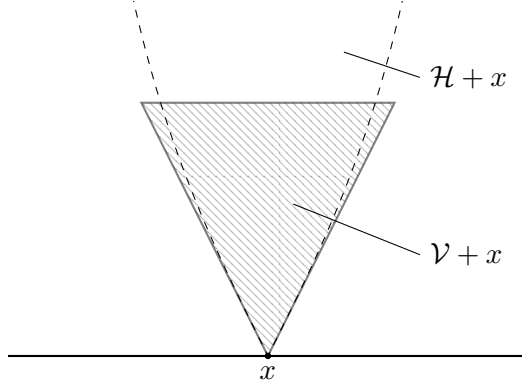

FIGURE 10. The set \mathcal{V} is chosen to approximate \mathcal{H} near the real axis, ensuring that $\tau_t^{(j)}$ and $\nu_t^{(j)}$ are close for large t .

We next define for $t, s \geq 0$

$$X_{t,s}^{(H)} := \gamma H_{\rho^t}^{(1)}(x) - \gamma H_{\rho^s}^{(2)}(y) - \frac{\gamma^2}{2} \left(\text{Var}[H_{\rho^t}^{(1)}(x)] - \text{Var}[H_{\rho^s}^{(2)}(y)] \right) - (t-s) \log(1/\rho)$$

$$X_{t,s}^{(V)} := \gamma V_{\rho^t}^{(1)}(x) - \gamma V_{\rho^s}^{(2)}(y) - \left(\frac{\gamma^2}{2} + 1 \right) (t-s) \log(1/\rho).$$

The former is the expression which we have to show is not too large in order for $\text{Size}(t, s)$ to occur. Our final class of events justifying the approximations described in the previous subsection are

$$\begin{aligned} \text{Scal}(N) := & \left\{ \frac{\tau^{(1)}(x + B_N)}{\tau^{(1)}([0, 1])} < 2^{-1} \right\} \cap \left\{ \frac{\tau^{(2)}(y + B_N)}{\tau^{(2)}([0, 1])} < 2^{-1} \right\} \\ & \cap \left\{ \sup_{t,s \in [N, 5N]} \left| X_{t,s}^{(H)} - X_{N,N}^{(H)} - (X_{t,s}^{(V)} - X_{N,N}^{(V)}) \right| < \log(2) \right\} \end{aligned}$$

defined for $N \in \mathbb{N}$.

Reduced events: Armed with the four previous classes of events we can begin to apply our approximate decomposition to define simplified (or reduced) versions of $\text{Shape}^{(j)}(t)$ and $\text{Size}(t, s)$.

For $t \geq 0$ we define

$$\begin{aligned} \text{ShapeRed}^{(1)}(t) := & \left\{ 1 \leq \tau_t^{(1)}(x + B_t \setminus B_{\lfloor t \rfloor + 3/4}) \rho^{-t} \leq 2^2 \right\} \cap \bigcap_{\ell=1}^8 \left\{ \frac{\tau_t^{(1)}(x + J_{t,\ell} \setminus B_{\lfloor t \rfloor + 3/4})}{\tau_t^{(1)}(x + B_t \setminus B_{\lfloor t \rfloor + 3/4})} \geq 2^{-4} \right\} \\ & \cap \left\{ \frac{\tau_t^{(1)}(x + 2B_{t+1/4} \setminus B_{\lfloor t \rfloor + 3/4})}{\tau_t^{(1)}(x + B_t \setminus B_{\lfloor t \rfloor + 3/4})} \leq 2^{-38} \right\} \cap \left\{ \frac{\tau_t^{(1)}(x + 2B_t \setminus B_{\lfloor t \rfloor + 3/4})}{\tau_t^{(1)}(x + B_t \setminus B_{\lfloor t \rfloor + 3/4})} \leq 2^2 \right\} \\ & \cap \left\{ \sum_{m=0}^{\infty} \sum_{\ell \in S(m, \rho^{t+1/4}, \rho^t)} \frac{\tau_t^{(1)}(x + I_{m,\ell,t})^2}{\tau_t^{(1)}(x + B_t \setminus B_{\lfloor t \rfloor + 3/4})^2} \leq 2^5 \right\}. \end{aligned}$$

Observe that each of the events in this intersection, apart from the first, are obtained from $\text{Shape}^{(1)}(t)$ by replacing $\tau^{(1)}(x + \cdot)$ with $\tau_t^{(1)}(x + \cdot \setminus B_{\lfloor t \rfloor + 3/4})$ and changing the constants slightly. The role of the first event will be explained soon. As the reader may have come to expect, we define $\text{ShapeRed}^{(2)}(t)$ analogously on replacing $\tau^{(1)}$ with $\tau^{(2)}$ and x with y .

Then for $N \in \mathbb{N}$ and $t, s \geq N$ we define

$$\text{SizeRed}(t, s) = \left\{ \left| X_{t,s}^{(V)} - X_{N,N}^{(V)} + X_{N,N}^{(H)} + \log \left(\frac{\tau^{(2)}([0, 1] \setminus (y + B_N))}{\tau^{(1)}([0, 1] \setminus (x + B_N))} \right) \right| \leq \log(2) \right\}.$$

After controlling for the different types of ‘correlation events’ described above, these reduced events imply their original counterparts:

Lemma 4.1. *Let $N \in \mathbb{N}$ and $t, s \in [N, 5N]$. Suppose that $t - \lfloor t \rfloor, s - \lfloor s \rfloor \in [0, 1/2]$. The intersection of the following events:*

$$\begin{aligned} & \text{Upp}_{\lfloor t \rfloor}^{(1)}, \text{Low}_{\lfloor t \rfloor}^{(1)}, \text{Frac}_{\lfloor t \rfloor}^{(1)}, \text{ShapeRed}^{(1)}(t), \\ & \text{Upp}_{\lfloor s \rfloor}^{(2)}, \text{Low}_{\lfloor s \rfloor}^{(2)}, \text{Frac}_{\lfloor s \rfloor}^{(2)}, \text{ShapeRed}^{(2)}(s), \\ & \text{Centre}(N), \text{Scal}(N), \text{SizeRed}(t, s) \end{aligned}$$

is contained in $\text{Ann}'(x, t, y, s, N)$ (as defined in Lemma 3.8).

Proof. From the definition of $\text{Ann}'(x, t, y, s, N)$ we need to show that our list of events imply $\text{Shape}^{(1)}(t)$, $\text{Shape}^{(2)}(s)$ and $\text{Size}(t, s)$. To ease notation we denote $n = \lfloor t \rfloor$ and $k = \lfloor s \rfloor$.

We argue first that $\text{Size}(t, s)$ occurs. Applying (4.5) for $j = 1, 2$ and using $\text{Frac}_n^{(1)}$ and $\text{Frac}_k^{(2)}$ we see that

$$\begin{aligned} \frac{\tau^{(1)}(x + B_t)}{\tau^{(1)}([0, 1])} \frac{\tau^{(2)}([0, 1])}{\tau^{(2)}(y + B_s)} & \leq 2^4 \frac{\tau_t^{(1)}(x + B_t) \rho^{-t}}{\tau_s^{(2)}(y + B_s) \rho^{-s}} \exp(X_{t,s}^{(H)}) \frac{\prod_{i=-1}^{n-1} \mathcal{S}_i^{(1)}(x + B_t)}{\prod_{i=-1}^{k-1} \mathcal{I}_i^{(2)}(y + B_s)} \frac{\tau^{(2)}([0, 1])}{\tau^{(1)}([0, 1])} \\ & \leq 2^8 \exp(X_{t,s}^{(H)}) \frac{\tau^{(2)}([0, 1])}{\tau^{(1)}([0, 1])} \end{aligned}$$

where we have used the first parts of $\text{ShapeRed}^{(1)}(t)$ and $\text{ShapeRed}^{(2)}(s)$ to control the first term on the right hand side and $\text{Upp}_t^{(1)} \cap \text{Upp}_s^{(2)}$ to control the third term. Then using monotonicity of the measure $\tau^{(1)}$ and the second part of $\text{Scal}(N)$

$$\frac{\tau^{(2)}([0, 1])}{\tau^{(1)}([0, 1])} \leq \frac{\tau^{(2)}([0, 1])}{\tau^{(2)}([0, 1] \setminus (y + B_N))} \frac{\tau^{(2)}([0, 1] \setminus (y + B_N))}{\tau^{(1)}([0, 1] \setminus (x + B_N))} \leq 2 \frac{\tau^{(2)}([0, 1] \setminus (y + B_N))}{\tau^{(1)}([0, 1] \setminus (x + B_N))}.$$

Finally we observe that by $\text{SizeRed}(t, s)$ and the third part of $\text{Scal}(N)$

$$\exp(X_{t,s}^{(H)}) \frac{\tau^{(2)}([0, 1] \setminus (y + B_N))}{\tau^{(1)}([0, 1] \setminus (x + B_N))} \leq 2^2.$$

(This follows from summing the two terms inside absolute value signs for the stated events and taking the exponential.) Combining the three previous equations shows that

$$\frac{\tau^{(1)}(x + B_t)}{\tau^{(1)}([0, 1])} \frac{\tau^{(2)}([0, 1])}{\tau^{(2)}(y + B_s)} \leq 2^{11}.$$

An entirely analogous argument applied to the reciprocal of this expression proves the lower bound of 2^{-10} , verifying that $\text{Size}(t, s)$ holds.

It remains to verify that $\text{Shape}^{(1)}(t)$ occurs. (Verification of $\text{Shape}^{(2)}(s)$ requires only minor notational changes and so is omitted.) From (4.7) and (4.6)

$$\frac{\tau_t^{(1)}(x + B_{n+3/4})}{\tau_t^{(1)}(x + B_t \setminus B_{n+3/4})} \leq \frac{\tau_t^{(1)}(x + B_{n+3/4})}{\tau_t^{(1)}(x + B_{n+1/2} \setminus B_{n+3/4})} \leq 2^2 \frac{\tau_n^{(1)}(x + B_{n+3/4})}{\tau_n^{(1)}(x + B_{n+1/2} \setminus B_{n+3/4})} \leq 2^{-38}.$$

From (4.5), (4.7) and the definitions of $\text{Upp}_n^{(1)}$ and $\text{Frac}_n^{(1)}$, for any $I, J \subset (x + 2B_n)$ we have

$$2^{-4} \frac{\tau_t^{(1)}(I)}{\tau_t^{(1)}(J)} \leq \frac{\tau^{(1)}(I)}{\tau^{(1)}(J)} \leq 2^4 \frac{\tau_t^{(1)}(I)}{\tau_t^{(1)}(J)}.$$

We use these two facts repeatedly to show that each part of $\text{Shape}^{(1)}(t)$ is implied by the corresponding part of $\text{ShapeRed}^{(1)}(t)$. To simplify notation, we assume below that $x = 0$. The proof for general $x \in [0, 1]$ follows from shifting every interval by x .

By part 3 of $\text{ShapeRed}^{(1)}(t)$

$$\begin{aligned} \frac{\tau^{(1)}(2B_{t+1/4})}{\tau^{(1)}(B_t)} &\leq 2^4 \frac{\tau_t^{(1)}(2B_{t+1/4})}{\tau_t^{(1)}(B_t)} \leq 2^4 \frac{\tau_t^{(1)}(2B_{t+1/4})}{\tau_t^{(1)}(B_t \setminus B_{n+3/4})} \\ &\leq 2^4 \frac{\tau_t^{(1)}(2B_{t+1/4} \setminus B_{n+3/4})}{\tau_t^{(1)}(B_t \setminus B_{n+3/4})} + 2^4 \frac{\tau_t^{(1)}(B_{n+3/4})}{\tau_t^{(1)}(B_t \setminus B_{n+3/4})} \leq 2^{-33}. \end{aligned}$$

This verifies the second part of $\text{Shape}^{(1)}(t)$.

Similarly by part 2 of $\text{ShapeRed}^{(1)}(t)$, for all $\ell = 1, \dots, 8$

$$\frac{\tau^{(1)}(J_{t,\ell})}{\tau^{(1)}(B_t)} \geq 2^{-4} \frac{\tau_t^{(1)}(J_{t,\ell})}{\tau_t^{(1)}(B_t)} \geq 2^{-4} \frac{\tau_t^{(1)}(J_{t,\ell} \setminus B_{n+3/4})}{\tau_t^{(1)}(B_t)} \geq 2^{-4} \frac{1}{1 + 2^{-38}} \frac{\tau_t^{(1)}(J_{t,\ell} \setminus B_{n+3/4})}{\tau_t^{(1)}(B_t \setminus B_{n+3/4})} \geq 2^{-9}$$

verifying the first part of $\text{Shape}^{(1)}(t)$.

By part 4 of $\text{ShapeRed}^{(1)}(t)$

$$\begin{aligned} \frac{\tau^{(1)}(2B_t)}{\tau^{(1)}(B_t)} &\leq 2^4 \frac{\tau_t^{(1)}(2B_t)}{\tau_t^{(1)}(B_t)} \leq 2^4 \frac{\tau_t^{(1)}(2B_t)}{\tau_t^{(1)}(B_t \setminus B_{n+3/4})} \\ &\leq 2^4 \frac{\tau_t^{(1)}(2B_t \setminus B_{n+3/4})}{\tau_t^{(1)}(B_t \setminus B_{n+3/4})} + 2^4 \frac{\tau_t^{(1)}(B_{n+3/4})}{\tau_t^{(1)}(B_t \setminus B_{n+3/4})} \leq 2^7 \end{aligned}$$

which verifies the third part of $\text{Shape}^{(1)}(t)$.

Finally by part 5 of $\text{ShapeRed}^{(1)}(t)$

$$\sum_m \sum_\ell \frac{\tau^{(1)}(I_{m,\ell,t})^2}{\tau^{(1)}(B_t)^2} \leq 2^8 \sum_m \sum_\ell \frac{\tau_t^{(1)}(I_{m,\ell,t})^2}{\tau_t^{(1)}(B_t)^2} \leq 2^8 \sum_m \sum_\ell \frac{\tau_t^{(1)}(I_{m,\ell,t})^2}{\tau_t^{(1)}(B_t \setminus B_{n+3/4})^2} \leq 2^{13}$$

which proves the fourth and final part of $\text{Shape}^{(1)}(t)$. \square

4.3. Verifying the sufficient conditions. We now show that the events justifying our approximation occur sufficiently often. More precisely, we show that with high probability the events $\text{Upp}_n^{(j)}$, $\text{Low}_n^{(j)}$, $\text{Frac}_n^{(j)}$, $\text{Centre}(N)$ and $\text{Scal}(N)$ occur for many values of n . This will justify restricting our attention to the reduced events $\text{ShapeRed}^{(j)}(t)$ and $\text{SizeRed}(t, s)$ which we analyse in the next section.

The main result of this subsection is:

Proposition 4.2. *For all $\rho > 0$ sufficiently small, $\delta \in (0, 1)$ and $\gamma < \gamma_0(\delta, \rho)$, there exists $C > 0$ such that*

$$\mathbb{P}(\text{Scal}(N) \cap \text{Centre}(N)) > 1 - C\rho^{(2+3\epsilon)5N}$$

and

$$(4.9) \quad \mathbb{P}\left(\text{Approx}^{(j)}(N)\right) > 1 - C\rho^{(2+3\epsilon)5N}$$

for $j = 1, 2$ and $N > N_0(\rho, \delta, \gamma)$, where

$$\text{Approx}^{(j)}(N) := \left\{ \sum_{n=1}^{5N} \mathbb{1}_{\text{Upp}_n^{(j)} \cap \text{Low}_n^{(j)} \cap \text{Frac}_n^{(j)}} > (1 - \delta)5N \right\}.$$

In proving this result, we will make repeated use of the two following estimates: a bound on the supremum of continuous Gaussian processes and a bound on ratios for the measures $\tau^{(j)}$.

Lemma 4.3. *Let Y_t be a continuous, centred Gaussian process indexed by $T := [0, \ell_1] \times \cdots \times [0, \ell_d]$ where $\ell_1 \leq \cdots \leq \ell_d$. Let $\sigma_T^2 = \sup_{t \in T} \mathbb{E}[Y_t^2]$ and suppose that $Y_{t_0} = 0$ almost surely for some $t_0 \in T$. If $\mathbb{E}[|Y_t - Y_s|^2] \leq L|t - s|^\alpha$ for some $\alpha \in (0, 1]$ and all $t, s \in T$, then for all $u \geq 0$*

$$\mathbb{P}\left(\sup_{t \in T} |Y_t| > u\right) < C_{d,\alpha} \left(1 + L^{d/\alpha} \rho_d^d \left(\frac{u}{\sigma_T^2}\right)^{2d/\alpha}\right) e^{-u^2/2\sigma_T^2}$$

where $C_{d,\alpha} > 0$ depends only on d and α .

Proof. We define a normalised process $\tilde{Y}_t := (L\ell_d^\alpha)^{-1/2} Y_{(\ell_1 t_1, \dots, \ell_d t_d)}$ which is indexed by $[0, 1]^d$. Defining the intrinsic metric $d(t, s) = \mathbb{E}[|\tilde{Y}_t - \tilde{Y}_s|^2]^{1/2}$ we have $d(t, s) \leq |t - s|^{\alpha/2}$. Therefore the minimal number of intrinsic metric balls of radius $\delta > 0$ required to cover $[0, 1]^d$ is at most $C_{d,\alpha} \delta^{-2d/\alpha}$. Since $Y_{t_0} = 0$ we have $\sigma_T^2 \leq C_d L \ell_d^\alpha$. These conditions allows us to apply the form of the Borell-TIS inequality stated in [1, Theorem 4.1.2] which gives the above bound. \square

Lemma 4.4. *For all $0 < q_- < q_+$ there exists $\gamma_0, C > 0$ such that the following holds: for all $\gamma \leq \gamma_0$, $j = 1, 2$ and all $J, I \subset [-1/4, 1/4]$ with $|J| \leq |I|$ and mutual distance $\leq 100|I|$*

$$\mathbb{P}\left(\frac{\tau^{(j)}(J)}{\tau^{(j)}(I)} > \lambda\right) \leq C\lambda^{-q_+} \left(\frac{|J|}{|I|}\right)^{q_-}.$$

Proof. For the proof we denote $\nu = \nu^{(j)}$ and $\tau = \tau^{(j)}$ since the index j plays no role. The proof of [8, Lemma 4.4] shows that for any $\gamma < \sqrt{2}$, $1 < q_+ < p < 2/\gamma^2$ and I, J as above

$$(4.10) \quad \left\| \frac{\nu(J)}{\nu(I)} \right\|_{q_+} \leq C \left(\frac{|J|}{|I|}\right)^{\zeta_p(\gamma)/p}$$

where C depends only on q_+ and p and we recall that

$$\zeta_p(\gamma) = p \left(1 - \frac{p-1}{2} \gamma^2\right)$$

denotes the multifractal spectrum of the measures. Lemma 3.6 of [8] states that there exists a positive random variable G with polynomial moments of all orders such that $G^{-1}\nu(\cdot) \leq$

$\tau(\cdot) \leq G\nu(\cdot)$. Moreover G does not depend on γ . We see then by Hölder's inequality that for γ sufficiently small and $p > 2q_+$

$$\mathbb{E} \left[\left(\frac{\tau(J)}{\tau(I)} \right)^{q_+} \right] \leq \mathbb{E}[G^{4q_+}]^{1/2} \mathbb{E} \left[\left(\frac{\nu(J)}{\nu(I)} \right)^{2q_+} \right]^{1/2} \leq C' \left(\frac{|J|}{|I|} \right)^{q_+ \zeta_p(\gamma)/p}.$$

By Markov's inequality

$$\mathbb{P} \left(\frac{\tau(J)}{\tau(I)} > \lambda \right) \leq C' \lambda^{-q_+} \left(\frac{|J|}{|I|} \right)^{q_+ (1 - \frac{p-1}{2} \gamma^2)}.$$

After restricting γ_0 sufficiently small, this exponent matches (or exceeds) the desired one. \square

We can now give a quantitative statement that the increments of ν_t and τ_t are close when t is large:

Lemma 4.5. *For $0 < \delta \leq r \leq 1/4$ and $t \in [0, 1]$ let*

$$U_\delta^r(t) := H_\delta^{(1)}(t) - H_r^{(1)}(t) - (V_\delta^{(1)}(t) - V_r^{(1)}(t)).$$

Then there exist absolute constants $c_0, C_1, C_2 > 0$ such that

$$\sup_{\delta \in (0, r]} \text{Var}[U_\delta^r(0)] \in [c_0 r^2, r^2]$$

and for $u \geq 0$

$$\mathbb{P} \left(\sup_{\delta \in (0, r]} \sup_{t \in [0, 1]} |U_\delta^r(t)| > C_1 u \right) \leq C_2 (1 + u^6 / r^{12}) e^{-u^2 / 2r^2}.$$

Proof. Recalling that λ denotes the hyperbolic measure on the upper half plane, by definition of the fields $H^{(1)}$ and $V^{(1)}$

$$\text{Var}[U_\delta^r(0)] = \lambda \left((\mathcal{V} \setminus \mathcal{H}) \cap \{(a, b) \in \mathbb{R}^2 \mid \delta \leq b \leq r\} \right) = \int_\delta^r \frac{2}{b^2} \left(\frac{b}{2} - \frac{1}{\pi} \arctan(\pi b/2) \right) db.$$

Using the inequality

$$\frac{\pi^2 b^3}{24} - \frac{\pi^4 b^5}{160} \leq \frac{b}{2} - \frac{\arctan(\pi b/2)}{\pi} \leq \frac{\pi^2 b^3}{24}$$

which follows from the series expansion of $\arctan(\cdot)$, the latter integral is at most

$$\int_\delta^r b db = (r^2 - \delta^2)/2 \leq r^2/2$$

and at least

$$\int_\delta^r \frac{\pi^2}{12} b - \frac{\pi^4}{80} b^3 db \geq \frac{\pi^2}{24} (r^2 - \delta^2) - \frac{\pi^4}{320} (r^4 - \delta^4) \geq \left(\frac{\pi^2}{24} - \frac{\pi^2}{32} \right) (r^2 - \delta^2)$$

proving the first statement of the lemma.

Aiming towards Lemma 4.3, for $0 < \eta \leq \delta \leq r$ and $0 \leq s \leq t \leq 1$

$$(4.11) \quad \mathbb{E} [(U_\delta^r(t) - U_\eta^r(s))^2] = \mathbb{E} [(U_\delta^r(t) - U_\delta^r(s))^2] + \mathbb{E} [(U_\delta^r(s) - U_\eta^r(s))^2]$$

using the fact that these terms depend on distinct regions of the white noise. By stationarity and our previous argument

$$(4.12) \quad \mathbb{E} [(U_\delta^r(s) - U_\eta^r(s))^2] = \mathbb{E}[U_\eta^\delta(0)^2] \leq \delta - \eta.$$

Similarly by definition of the white noise W

$$(4.13) \quad \mathbb{E} [(U_\delta^r(t) - U_\delta^r(s))^2] = \lambda \left((\mathcal{V} \setminus \mathcal{H}) \Delta (\mathcal{V} \setminus \mathcal{H} + t - s) \cap \{(a, b) \mid \delta \leq b \leq r\} \right)$$

where Δ denotes the symmetric difference. Using the inequality for $\arctan(\cdot)$ above, the one-dimensional measure of

$$(\mathcal{V} \setminus \mathcal{H}) \Delta (\mathcal{V} \setminus \mathcal{H} + t - s) \cap \{(a, b) \mid b = b_0\}$$

is bounded above by $\min\{2(t-s), 2b_0^3\}$ (see Figure 10). Note that since $r \leq 1/4$ the periodicity of the white noise plays no role. Therefore (4.13) is bounded above by

$$\int_{\delta}^r \frac{2}{b^2} \min\{t-s, b^3\} db \leq \int_0^{\sqrt[3]{t-s}} 2b db + \int_{r \wedge \sqrt[3]{t-s}}^r 2(t-s)/b^2 db \leq 3(t-s)^{2/3}.$$

Combining this with (4.11), (4.12) and (4.13) we may apply Lemma 4.3 for $\alpha = 2/3$ which yields the statement of the lemma. \square

We now prove Proposition 4.2 in a series of steps:

Proof of Proposition 4.2 for $\text{Scal}(N)$ and $\text{Centre}(N)$. Recall that $\epsilon > 0$ was fixed in Section 3. We choose $q^- = (2+3\epsilon)/\epsilon + 1$ and $q_+ = q_- + 1$. By the definition of $\text{Centre}(N)$ and Lemma 4.4, for $\gamma < \gamma_0$ sufficiently small

$$\begin{aligned} \mathbb{P}(\text{Centre}(N)^c) &= \mathbb{P}\left(\frac{\tau^{(2)}([0, \rho^{(1+\epsilon)5N}])}{\tau^{(2)}(B_{5N+1})} > 2^{-23}\right) \leq C 2^{-23q_+} \left(\frac{\rho^{(1+\epsilon)5N}}{2\rho^{5N+1}}\right)^{q_-} \\ &\leq C' 2^{-24q_-} \rho^{(5\epsilon N - 1)q_-}. \end{aligned}$$

By our definition of q_- , the right hand side is at most $C'' \rho^{(2+3\epsilon)5N}$ for N sufficiently large.

Turning to $\text{Scal}(N)$; by Lemma 4.4, for any $1 < q_- < q_+$ we can find $\gamma_0 > 0$ such that for $\gamma \in [0, \gamma_0]$

$$\mathbb{P}\left(\frac{\tau^{(j)}(B_N)}{\tau^{(j)}([0, 1])} > \frac{1}{2}\right) \leq \mathbb{P}\left(\frac{\tau^{(j)}(B_N)}{\tau^{(j)}([-1/4, 1/4])} > \frac{1}{2}\right) \leq C 2^{q_+} (4\rho^N)^{q_-}.$$

For $q_- > 5(2+3\epsilon)$ and $q_+ = q_- + 1$ the right hand side is at most $C' \rho^{(2+3\epsilon)5N}$.

For the final part of $\text{Scal}(N)$ we write

$$X_{t,s}^{(H)} - X_{N,N}^{(H)} - (X_{t,s}^{(V)} - X_{N,N}^{(V)}) = I_t + II_s + III$$

where

$$\begin{aligned} I_t &:= \gamma \left(H_{\rho^t}^{(1)}(x) - H_{\rho^N}^{(1)}(x) - (V_{\rho^t}^{(1)}(x) - V_{\rho^N}^{(1)}(x)) \right) \\ II_s &:= \gamma \left(H_{\rho^s}^{(2)}(y) - H_{\rho^N}^{(2)}(y) - (V_{\rho^s}^{(2)}(y) - V_{\rho^N}^{(2)}(y)) \right) \\ III &:= \frac{\gamma^2}{2} \left(\text{Var}[H_{\rho^t}^{(1)}(0) - H_{\rho^s}^{(1)}(0)] - \text{Var}[V_{\rho^t}^{(1)}(0) - V_{\rho^s}^{(1)}(0)] \right). \end{aligned}$$

We bound the suprema of each of these terms separately. By the first statement of Lemma 4.5, $|III| \leq \gamma^2 \rho^{2N}$. Taking ρ sufficiently small this is less than $\log(2)/3$ for all N . By the second statement of Lemma 4.5 with $u = \log(2)/3C_1$ and $r = \rho^N$

$$\mathbb{P}\left(\sup_{t \geq N} |I_t| > \log(2)/3\right) \leq C'(1 + \rho^{-12N}) \exp(-C\rho^{-2N})$$

for absolute constants $C, C' > 0$. In particular the right-hand side is at most $C'' \rho^{(2+3\epsilon)5N}$. The term II_s has an identical distribution, so the same probability bound holds. Combining this with the bound on III we conclude that

$$\mathbb{P}\left(\sup_{t,s \in [N, 5N]} \left| X_{t,s}^{(H)} - X_{N,N}^{(H)} - (X_{t,s}^{(V)} - X_{N,N}^{(V)}) \right| > \log(2)\right) < 2C'' \rho^{(2+3\epsilon)5N}$$

for all N sufficiently large and hence

$$\mathbb{P}(\text{Scal}(N)^c) < C''' \rho^{(2+3\epsilon)5N}.$$

\square

Lemma 4.6. *For all $\rho > 0$ sufficiently small, $\delta \in (0, 1)$ and $\gamma < \gamma_0(\delta, \rho)$, there exists $C > 0$ such that*

$$\mathbb{P} \left(\sum_{n=1}^{5N} \mathbb{1}_{\text{Frac}_n^{(j)}} > (1 - \delta)5N \right) > 1 - C\rho^{(2+3\epsilon)5N}$$

for $j = 1, 2$ and $N > N_0(\rho, \delta, \gamma)$.

Proof. The key to the proof is that $\text{Frac}_1^{(j)}, \text{Frac}_2^{(j)}, \dots$ are independent (as they depend on the white noise W on disjoint regions) and so we can apply standard large deviation estimates for Bernoulli variables. Specifically if Z_1, Z_2, \dots , are i.i.d. Bernoulli variables with parameter p , then a simple argument using the exponential Markov inequality shows that

$$\mathbb{P} \left(\sum_{i=1}^{5N} Z_i < (1 - \delta)5N \right) \leq e^{-5NI(\delta, p)}$$

where

$$I(\delta, p) = \delta \log \left(\frac{\delta}{p} \right) + (1 - \delta) \log \left(\frac{1 - \delta}{1 - p} \right).$$

Clearly for any value of $\delta \in (0, 1)$, $I(\delta, p) \rightarrow \infty$ as $p \rightarrow 1$. Moreover if we instead suppose that $Z_i \sim \text{Ber}(p_i)$ where $p_i \geq p$ for all i , then the above estimate still holds (to see this one can define $Z_i = \mathbb{1}_{U_i \leq p_i}$ and $\tilde{Z}_i = \mathbb{1}_{U_i \leq p}$ where the U_i are i.i.d. uniform variables on $[0, 1]$). Therefore, if for any $p \in (0, 1)$ we can choose γ_0 (depending on ρ) such that $\mathbb{P}(\text{Frac}_n^{(j)}) \geq p$ for all n , then the statement of the lemma follows.

Recall that $\text{Frac}_n^{(1)}$ is the indicator function for the event that

$$(4.14) \quad \sup_{t \in [n, n+1/2]} \sup_{u \in (x+2B_n)} \left| \gamma(H_{\rho^t}^{(1)}(u) - H_{\rho^n}^{(1)}(u)) - \frac{\gamma^2}{2} \text{Var}[H_{\rho^t}(0) - H_{\rho^n}(0)] \right| < \log(2).$$

We first observe that

$$\begin{aligned} \text{Var}[H_{\rho^t}(0) - H_{\rho^n}(0)] &= \int_{\mathcal{H} \cap \{\rho^t \leq y \leq \rho^n\}} y^{-2} dx dy \leq \int_{\rho^t}^{\rho^n} y^{-2} \int_{-y/2}^{y/2} dx dy \\ &= (t - n) \log(1/\rho) \leq \frac{1}{2} \log(1/\rho). \end{aligned}$$

Therefore taking γ sufficiently small relative to ρ , we have $\frac{\gamma^2}{2} \text{Var}[H_{\rho^t}(0) - H_{\rho^n}(0)] < \log(2)/2$ for all t and n .

Next we define $Y_{t,u} = H_{\rho^t}(x + \rho^n u) - H_{\rho^n}(x + \rho^n u)$ which is a continuous centred Gaussian process on $(t, u) \in [n, n + 1/2] \times [-2, 2]$. Then by independence of the white noise on disjoint domains, for $t > s$

$$\mathbb{E}[|Y_{t,u} - Y_{s,w}|^2] = \mathbb{E}[|Y_{t,u} - Y_{s,u}|^2] + \mathbb{E}[|Y_{s,u} - Y_{s,w}|^2].$$

Our previous calculation shows that the first term on the right hand side is bounded above by $|t - s| \log(1/\rho)$. The second term is given by

$$\lambda((\rho^n u + \mathcal{H}) \Delta (\rho^n w + \mathcal{H}) \cap \{\rho^s \leq y \leq \rho^n\}) \leq 2\rho^n |u - w| \int_{\rho^s}^{\rho^n} y^{-2} dy \leq 2\rho^{-1/2} |u - w|$$

where Δ denotes the symmetric difference, so that

$$\mathbb{E}[|Y_{t,u} - Y_{s,w}|^2] \leq 2\rho^{-1/2} (|u - w| + |t - s|).$$

Finally we observe that

$$\sup_{t,u} \mathbb{E}[Y_{t,u}^2] = \mathbb{E}[Y_{n+1/2,0}^2] \in [c_0 \log(1/\rho), c_1 \log(1/\rho)]$$

for some $0 < c_0 < c_1$ independent of n . Applying Lemma 4.3 to $Y_{t,u}$ with $\alpha = 1$ we see that for any $a > 0$

$$\mathbb{P} \left(\sup_{t \in [n, n+1/2], u \in (x+2B_n)} \gamma |Y_{t,u}| > \gamma a \right) < C(1 + \rho^{-1}a^4)e^{-a^2/2 \log^2(1/\rho)}$$

for an absolute constant $C > 0$. Taking $a = \log(2)/2\gamma$ with γ sufficiently small, depending on ρ , ensures that the probability of the supremum exceeding $\log(2)/2$ is as small as desired. Therefore for each n , $\text{Frac}_n^{(j)}$ will occur with sufficiently high probability completing the proof of the lemma. \square

It remains to prove that the events $\text{Upp}_n^{(j)}$ and $\text{Low}_n^{(j)}$ occur on a sequence of density $1 - \delta$. This will be more challenging due to the dependence between these events. We follow the arguments of [8, Section 4.3], although in some cases our proofs simplify since we consider only small values of γ .

Lemma 4.7. *For all $\rho > 0$ sufficiently small, $\delta \in (0, 1)$ and $\gamma < \gamma_0(\delta, \rho)$, there exists $C > 0$ such that*

$$\mathbb{P} \left(\sum_{n=1}^{5N} \mathbf{1}_{\text{Low}_n^{(j)}} > (1 - \delta)5N \right) > 1 - C\rho^{(2+3\epsilon)5N}$$

for $j = 1, 2$ and $N \in \mathbb{N}$.

Proof. For the proof we write Low_n rather than $\text{Low}_n^{(j)}$ since the index $j = 1, 2$ will play no role. First we claim that for any $q \geq 1$ there exists $C > 0$ such that for all $\rho, \gamma > 0$ sufficiently small

$$\mathbb{P}(\text{Low}_{n,k}^c) < C\rho^{q(k-n+1/4)}.$$

Indeed if we choose $\rho < 2^{-(q+2)}$ then we can apply Lemma 4.4 with $q_+ = q_- + 1 = q + 2$ to see that for γ sufficiently small

$$\begin{aligned} \mathbb{P}(\text{Low}_{n,k}^c) &= \mathbb{P} \left(\frac{\tau_n(B_{k+3/4} \setminus B_{k+7/4})}{\tau_n(B_{n+1/2} \setminus B_{n+3/4})} > 2^{n-k-41} \right) \leq C_0 2^{q+(41+k-n)} \rho^{q-(k-n+1/4)} \\ &\leq C\rho^{q(k-n+1/4)} \end{aligned}$$

where C depends only on q .

Turning to the estimate we wish to prove; by the union bound

$$(4.15) \quad \mathbb{P} \left(\sum_{n=1}^{5N} \mathbf{1}_{\text{Low}_n^c} > \delta 5N \right) \leq \sum_{B \subseteq \{1, \dots, 5N\}, |B| > \delta 5N} \mathbb{P} \left(\bigcap_{n \in B} \text{Low}_n^c \right).$$

In order to bound the expression on the right, we consider a sequence $n_1 < n_2 < \dots < n_M$ and recalling that $\text{Low}_n = \bigcap_{\ell \geq 0} \text{Low}_{n, n+\ell}$ we have

$$\mathbb{P}(\text{Low}_{n_1}^c \cap \dots \cap \text{Low}_{n_M}^c) \leq \sum_{\ell_1=0}^{\infty} \mathbb{P}(\text{Low}_{n_1, n_1+\ell_1}^c \cap \text{Low}_{n_{i_2}}^c \cap \dots \cap \text{Low}_{n_M}^c)$$

where i_2 is chosen as the first index j such that $n_1 + \ell_1 + 1 < n_j$. Iterating this argument we obtain that

$$\mathbb{P}(\text{Low}_{n_1}^c \cap \dots \cap \text{Low}_{n_M}^c) \leq \sum_{r=1}^M \sum_{\ell_1, \dots, \ell_r=0}^{\infty} \mathbb{P} \left(\bigcap_{k=1}^r \text{Low}_{n_{i_k}, n_{i_k}+\ell_k}^c \right)$$

where i_k is defined recursively as the first j such that $n_j > n_{i_{k-1}} + \ell_{k-1} + 1$. Now using the observation from Section 4.2 that Low_{n_1, k_1} and Low_{n_2, k_2} are independent whenever $k_1 + 2 \leq n_2$ along with the estimate above we have

$$\mathbb{P}(\text{Low}_{n_1}^c \cap \dots \cap \text{Low}_{n_M}^c) \leq \sum_{r=1}^M \sum_{\ell_1, \dots, \ell_r} C^r \rho^{q \sum_{k=1}^r (\ell_k + 1/4)}.$$

Next we observe that since

$$\{n_1, \dots, n_M\} \subset \bigcup_{k=1}^r [n_{i_k}, n_{i_k} + \ell_k + 1]$$

and each interval on the right contains at most $\ell_k + 2$ integers, we must have $M \leq \sum_{k=1}^r \ell_k + 2r$. Substituting this into the equation above

$$\begin{aligned} \mathbb{P}(\text{Low}_{n_1}^c \cap \dots \cap \text{Low}_{n_M}^c) &\leq \sum_{r=1}^M C^r \rho^{\frac{q}{10}(M-2r)} \sum_{\ell_1, \dots, \ell_r} \rho^{\frac{9q}{10} \sum_{k=1}^r (\ell_k + 1/4)} \\ &\leq \sum_{r=1}^M C^r \rho^{\frac{q}{10}(M-2r)} \left(\sum_{\ell=0}^{\infty} \rho^{\frac{9q}{10}(\ell+1/4)} \right)^r \leq \sum_{r=1}^M C^r \rho^{\frac{q}{10}(M-2r)} C' \rho^{\frac{9qr}{40}} \end{aligned}$$

where $C' > 0$ is an absolute constant (provided $\rho \leq 1/2$, say). The latter expression can be rearranged as

$$C' \rho^{\frac{q}{10}M} \sum_{r=1}^M C^r \rho^{\frac{9qr}{40}} \leq C' M \rho^{\frac{q}{10}M} \leq C'' \rho^{\frac{q}{11}M}.$$

where we have assumed that $\rho^{q/40} < 1/C$ (recall that C depends on q but not ρ or γ). Substituting this bound into (4.15) we see that

$$\mathbb{P} \left(\sum_{n=1}^{5N} \mathbb{1}_{\text{Low}_n^c} > \delta 5N \right) \leq 2^{5N} C'' \rho^{\frac{q}{11} \delta N}.$$

Choosing q sufficiently large (depending on δ) ensures that the right hand side is at most $C''' \rho^{(2+3\epsilon)5N}$, completing the proof of the lemma. \square

Lemma 4.8. *There exist absolute constants $C_0, c_0 > 0$ such that for all $n \in \mathbb{N}$ and all $k \in \{-1, 0, \dots, n-1\}$*

$$\mathbb{P} \left(\text{Upp}_{n,k}^{(j)} \right) \geq 1 - C_0 \exp \left(\frac{-c_0}{\gamma^2 (4\rho)^{n-k-1}} \right).$$

Proof. As in previous proofs we will omit the superscript j as it plays no role here. Recalling the definition of $\text{Upp}_{n,k}$ at the start of Section 4.2 and noting that

$$\frac{E(u, \rho^{k+1}, \rho^k)}{E(x, \rho^{k+1}, \rho^k)} = \exp \left(\gamma \left(H_{\rho^{k+1}}(u) - H_{\rho^k}(u) - H_{\rho^{k+1}}(x) + H_{\rho^k}(x) \right) \right)$$

we see that a sufficient condition for $\text{Upp}_{n,k}$ is that

$$(4.16) \quad \sup_{u \in x+2B_n} \gamma \left(|H_{\rho^{k+1}}(u) - H_{\rho^{k+1}}(x)| + |H_{\rho^k}(u) - H_{\rho^k}(x)| \right) \leq 2^{k-n} \log(2).$$

(Note this is true even for $k = -1$, although in this case we can ignore the H_{ρ^k} terms in the above expression.)

Letting $Y_u = H_{\rho^k}(u) - H_{\rho^k}(x)$ for $u \in x + 2B_n$ we have

$$\mathbb{E}[(Y_u - Y_w)^2] \leq \lambda((u + \mathcal{H}_{\rho^k})\Delta(w + \mathcal{H}_{\rho^k})) \leq 2|u - w| \int_{\rho^k}^{\infty} y^{-2} dy = 2\rho^{-k}|u - w|.$$

In particular $\sup_{u \in x+2B_n} \mathbb{E}[Y_u^2] \leq 4\rho^{n-k}$. A simple geometric argument shows this bound is tight up to constants: that is $\sup_{u \in x+2B_n} \mathbb{E}[Y_u^2] \geq \mathbb{E}[Y_{x+\rho^n/2}^2] \geq c_0 \rho^{n-k}$ for some $c_0 > 0$ and all $k \leq n$. Since $Y_x = 0$, applying Lemma 4.3 with $\alpha = 1$, $L = 2\rho^{-k}$ and $\ell_d = 4\rho^{-n}$ we have

$$\mathbb{P} \left(\sup_{u \in x+2B_n} \gamma |H_{\rho^k}(u) - H_{\rho^k}(x)| > \gamma a \right) \leq C \left(1 + \rho^{n-k} \frac{a^2}{\rho^{n-k}} \right) e^{-a^2/8\rho^{n-k}}$$

for any $a \geq 0$ where $C > 0$ is an absolute constant. Applying this to both expressions on the left hand side of (4.16) (with $a = 2^{k-n-1} \log(2)$) we see that

$$\mathbb{P}(\text{Upp}_{n,k}^c) \leq c \left(1 + \gamma^{-2} 4^{k-n}\right) \exp\left(-\frac{c'}{\gamma^2 (4\rho)^{n-k-1}}\right)$$

where $c, c' > 0$ are absolute constants. Since $x \mapsto (1+x)e^{-c'/(2x)}$ is bounded above by an absolute constant, the expression above satisfies the bound in the statement of the lemma. \square

Lemma 4.9. *For all $\rho > 0$ sufficiently small, $\delta \in (0, 1)$ and $\gamma < \gamma_0(\delta, \rho)$, there exists $C > 0$ such that*

$$\mathbb{P}\left(\sum_{n=1}^{5N} \mathbf{1}_{\text{Upp}_n^{(j)}} > (1-\delta)5N\right) > 1 - C\rho^{(2+3\epsilon)5N}$$

for $j = 1, 2$ and $N \in \mathbb{N}$.

Proof. We once more suppress the superscript j in our arguments, which roughly follow the proof of Lemma 4.7. By the union bound

$$(4.17) \quad \mathbb{P}\left(\sum_{n=1}^{5N} \mathbf{1}_{\text{Upp}_n^c} > \delta 5N\right) \leq \sum_{B \subset \{1, \dots, 5N\}, |B| > \delta 5N} \mathbb{P}\left(\bigcap_{n \in B} \text{Upp}_n^c\right).$$

For a sequence $n_1 > \dots > n_M$, arguing as in the proof of Lemma 4.7 we have

$$\mathbb{P}(\text{Upp}_{n_1}^c \cap \dots \cap \text{Upp}_{n_M}^c) \leq \sum_{r=1}^M \sum_{\ell_1, \dots, \ell_r} \mathbb{P}\left(\bigcap_{k=1}^r \text{Upp}_{n_{i_k}, n_{i_k} - \ell_k}^c\right)$$

where now $n_{i_{k+1}}$ is the largest n_j less than $n_{i_k} - \ell_k$. Since

$$\{n_1, \dots, n_M\} \subset \bigcup_{k=1}^r [n_{i_k}, n_{i_k} - \ell_k]$$

we have $M \leq \sum_{k=1}^r \ell_k - r$.

Next we observe that the events $\text{Upp}_{n_{i_k}, n_{i_k} - \ell_k}$ are independent for distinct k since they depend on disjoint horizontal strips of the white noise process. Therefore using Lemma 4.8

$$\mathbb{P}(\text{Upp}_{n_1}^c \cap \dots \cap \text{Upp}_{n_M}^c) \leq \sum_{r=1}^M \sum_{\ell_1, \dots, \ell_r} C_0^r \exp\left(\sum_{k=0}^r \frac{-c_0}{\gamma^2 (4\rho)^{\ell_k - 1}}\right).$$

Now we choose $\rho > 0$ small enough that $(4\rho)^{-\ell} \geq 1 + \ell$ for all $\ell \geq 0$ and then $\gamma < 4\rho$. Using this and $\sum_k \ell_k \geq M - r$, the above expression is bounded by

$$\begin{aligned} \sum_{r=1}^M \sum_{\ell_1, \dots, \ell_r} C_0^r \exp\left(\frac{-c_0}{\gamma} \left(r + \sum_{k=0}^r \ell_k\right)\right) &\leq \exp\left(\frac{-c_0}{2\gamma} M\right) \sum_{r=1}^M C_0^r \left(\sum_{\ell \geq 0} \exp\left(\frac{-c_0}{2\gamma} (1 + \ell)\right)\right)^r \\ &\leq \exp\left(\frac{-c_0}{2\gamma} M\right) \sum_{r=1}^M C_0^r C' \exp\left(\frac{-c_0}{2\gamma} r\right) \end{aligned}$$

for some absolute constant $C' > 0$. Choosing γ small enough that $C_0 e^{-c_0/(2\gamma)} \leq 1$ we conclude that

$$\mathbb{P}(\text{Upp}_{n_1}^c \cap \dots \cap \text{Upp}_{n_M}^c) \leq C' M \exp\left(\frac{-c_0}{2\gamma} M\right) \leq C'' \exp\left(\frac{-c'_0}{2\gamma} M\right).$$

Substituting this into (4.17) we obtain

$$\mathbb{P}\left(\sum_{n=1}^{5N} \mathbf{1}_{\text{Upp}_n^c} > \delta 5N\right) \leq 2^{5N} C'' \exp\left(\frac{-c'_0}{2\gamma} \delta 5N\right)$$

and taking γ sufficiently small ensures that this is at most $C\rho^{(2+3\epsilon)5N}$ as required. \square

Proof of Proposition 4.2. We have already proven the required probability bound for $\text{Scal}(\cdot)$ and $\text{Centre}(\cdot)$. Combining Lemmas 4.6, 4.7 and 4.9 with the union bound proves (4.9) with 3δ replacing δ . Since $\delta \in (0, 1)$ was arbitrary, this suffices to prove the proposition. \square

5. LARGE DEVIATION BOUNDS FOR REDUCED EVENTS

In this section we tie together the remaining arguments needed to show that the maps F_n are uniformly Hölder continuous and so complete the proof of our conformal welding result.

5.1. Completing the proof of Hölder continuity. The final ingredient we require to prove the uniform Hölder continuity of Theorem 2.7 is a large deviation bound for the reduced size and shape events described in the previous section:

Proposition 5.1. *For some $\delta > 0$, all $\rho > 0$ sufficiently small, all $\gamma < \gamma_0(\rho)$ and all N sufficiently large the following holds: there exist two random sequences $(t_n)_{n \in \mathbb{N}}$ and $(s_n)_{n \in \mathbb{N}}$ such that*

- (1) $t_n - t_{n-1}, s_n - s_{n-1} \geq 1/4$ for all n
- (2) $t_n - \lfloor t_n \rfloor, s_n - \lfloor s_n \rfloor \in [0, 1/2]$ for all n
- (3) for some $C > 0$ independent of N

$$\mathbb{P} \left(\sum_{n: N \leq t_n, s_n \leq 5N} \mathbb{1}_{\text{ShapeRed}^{(1)}(t_n) \cap \text{ShapeRed}^{(2)}(s_n) \cap \text{SizeRed}(t_n, s_n)} > 11\delta N \right) \geq 1 - C\rho^{(2+3\epsilon)5N}.$$

Armed with this result, and our previous arguments, the proof of Theorem 2.7 becomes straightforward:

Proof of Theorem 2.7. By Lemma 3.3 and Proposition 3.8, uniform Hölder continuity of $(F_n)_{n \in \mathbb{N}}$ follows if we can find two sequences t_n and s_n such that $t_n - t_{n-1}, s_n - s_{n-1} \geq 1/4$ and

$$(5.1) \quad \mathbb{P} \left(\left\{ \sum_{t_n, s_n \leq 5N} \mathbb{1}_{\text{Ann}'(x, t_n, y, s_n, N)} < \delta N \right\} \cap \text{Match}(x, y, N) \right) \leq C\rho^{(2+3\epsilon)5N}.$$

Lemma 4.1 shows that for $t_n, s_n \geq N$ we can replace $\text{Ann}'(x, t_n, y, s_n, N)$ by the intersection of the following events

$$(5.2) \quad \text{Upp}_{\lfloor t_n \rfloor}^{(1)}, \text{Low}_{\lfloor t_n \rfloor}^{(1)}, \text{Frac}_{\lfloor t_n \rfloor}^{(1)}, \text{Upp}_{\lfloor s_n \rfloor}^{(2)}, \text{Low}_{\lfloor s_n \rfloor}^{(2)}, \text{Frac}_{\lfloor s_n \rfloor}^{(2)}, \\ \text{Centre}(N), \text{Scal}(N), \text{ShapeRed}^{(1)}(t_n), \text{ShapeRed}^{(2)}(s_n), \text{SizeRed}(t_n, s_n).$$

Let us choose $\delta > 0$ as given in the statement of Proposition 5.1. Taking $\gamma > 0$ sufficiently small, Proposition 4.2 states that with probability at least $1 - C\rho^{(2+3\epsilon)5N}$ the event $\text{Upp}_m^{(j)} \cap \text{Low}_m^{(j)} \cap \text{Frac}_m^{(j)}$ occurs for at least $(1 - \delta)5N$ points from $m \in \{1, 2, \dots, 5N\}$ and $j \in \{1, 2\}$. Moreover the same proposition gives the same lower bound on the probability of $\text{Centre}(N) \cap \text{Scal}(N)$. Hence by Proposition 5.1 and the union bound, all of the events in (5.2) occur for a sequence of length at least δN with probability at least $1 - C\rho^{(2+3\epsilon)5N}$. This verifies (5.1) and so completes the proof. \square

Let us turn to proving Proposition 5.1. We note that the measures $\tau^{(j)}, \nu^{(j)}, \tau_t^{(j)}, \nu_t^{(j)}$ are all stationary in the sense that $\tau^{(j)}(u + \cdot)$ has the same distribution as $\tau^{(j)}(\cdot)$ for any given $u \in \mathbb{R}$ (and analogous statements hold for the other measures). This fact follows from the corresponding property of the periodic white noise processes used to construct these measures. From the definitions of the events $\text{ShapeRed}^{(j)}(t)$ and $\text{SizeRed}(t, s)$ we see that every interval to which $\tau^{(1)}, \tau_t^{(1)}, \nu^{(1)}$ or $\nu_t^{(1)}$ is applied has been translated by x and similarly the intervals for measures with superscript (2) have been translated by y . In proving Proposition 5.1 it is therefore sufficient to consider the case $x = y = 0$, which will simplify our notation in what follows.

5.2. Oscillating random walk algorithm. We now describe the algorithm for selecting (t_n, s_n) , which forms the basis of Proposition 5.1. We begin with some heuristics. Recall that the event $\text{SizeRed}(t, s)$ occurs if

$$(5.3) \quad \left| \underbrace{X_{t,s}^{(V)} - X_{N,N}^{(V)}}_{(1)} + \underbrace{X_{N,N}^{(H)} + \log \left(\frac{\tau^{(2)}([0,1] \setminus B_N)}{\tau^{(1)}([0,1] \setminus B_N)} \right)}_{(2)} \right| \leq \log(2)$$

where

$$X_{t,s}^{(V)} = \gamma V_{\rho^t}^{(1)}(0) - \gamma V_{\rho^s}^{(2)}(0) - (t-s) \left(1 + \frac{\gamma^2}{2} \right) \log(1/\rho)$$

and $X_{t,s}^{(H)}$ is defined analogously for H . Viewed as a function of t , the process $V_{\rho^t}^{(j)}(0)$ is a Brownian motion with speed $\log(1/\rho)$ and so $X_{t,s}^{(V)}$ can be viewed as a difference of two independent Brownian motions with the same drift (where we allow the time parameters t and s of each Brownian motion to vary independently). In particular

$$(5.4) \quad X_{t+u,s+v}^{(V)} - X_{t,s}^{(V)} \sim \mathcal{N}(d(v-u), \sigma^2(u+v))$$

where

$$(5.5) \quad d := \left(1 + \frac{\gamma^2}{2} \right) \log(1/\rho) \quad \text{and} \quad \sigma^2 := \gamma^2 \log(1/\rho).$$

Therefore increasing one parameter or the other will tend to increase or decrease the value of (1) in (5.3) on average.

The idea of the algorithm is to choose these parameter values t and s iteratively, increasing whichever one will bring the left hand side of (5.3) closer to the target interval $[-\log(2), \log(2)]$. Moreover, we can view expression (2) of (5.3) as an ‘initial distribution’ since for $t, s \geq N$, expression (1) is independent of (2) (as they depend on disjoint regions of the hyperbolic white noise). Therefore the increments will be independent of the left hand side of (5.3).

It will turn out to be convenient to mostly consider integer values of the parameters (this is for consistency with the events defined in earlier sections on integer scales). Then once we find a value of the parameters such that (5.3) is not too large (on the order of d) we choose fractional values for the next increment to obtain a high probability of landing in the target interval. These fractional parameter values will be (t_n, s_n) .

More precisely our algorithm is the following:

Algorithm 5.2. Given $N \in \mathbb{N}$ we define the integer sequences $(i_m, j_m)_{m \geq N}$ inductively as follows:

- Set $i_N = j_N = N$
- Given (i_m, j_m) , define

$$Y_m = X_{i_m, j_m}^{(V)} - X_{N,N}^{(V)} + X_{N,N}^{(H)} + \log \frac{\tau^{(2)}([0,1] \setminus B_N)}{\tau^{(1)}([0,1] \setminus B_N)}$$

- If $Y_m < -d$ then set $(i_{m+1}, j_{m+1}) = (i_m, j_m + 1)$
- If $Y_m > d$ then set $(i_{m+1}, j_{m+1}) = (i_m + 1, j_m)$
- Otherwise set $(i_{m+1}, j_{m+1}) = (i_m + 2, j_m + 2)$.

See Figure 11. We next define the stopping times T_0, T_1, \dots inductively as $T_0 = N - 1$ and

$$T_n = \inf \{ m > T_{n-1} : |Y_m| \leq d \}$$

for $n \in \mathbb{N}$. Then for each n , let u and v be the minimal values in $[1, 3/2] \cup \{2\}$ such that

$$Y_{T_n} + d(v-u) = 0$$

and set

$$(t_n, s_n) = (i_{T_n} + u, j_{T_n} + v).$$

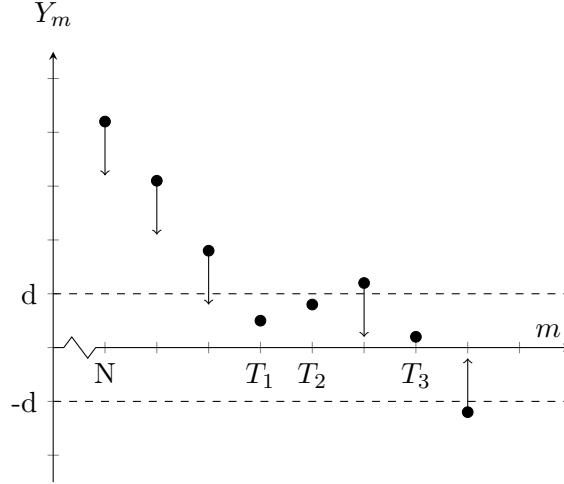

FIGURE 11. The process Y_m described in Algorithm 5.2 can be thought of as an oscillating random walk with Gaussian steps: when Y_m is outside the interval $[-d, d]$ it takes Gaussian steps with expectation $\pm d$ towards the origin (indicated by arrows in the figure). When $|Y_m| \leq d$ the next step has an expectation of zero.

Having now defined our algorithm, we begin to prove Proposition 5.1. The first step is to show that (with high probability) the number of stopping times T_n which occur before time $5N$ is of order N . This ensures that many values of t_n and s_n are bounded above by $5N$. We prove this in the next subsection. The second step is to show that the events of interest (i.e. ShapeRed and SizeRed) occur for many such (t_n, s_n) . This is done in the final subsection.

5.3. Large deviation bounds for occupation time. The stopping times $(T_n)_{n \in \mathbb{N}}$ occur whenever the process $(Y_m)_{m \geq N}$ hits $[-d, d]$. Therefore proving that many T_n occur before $5N$ is equivalent to proving bounds on the occupation time of $[-d, d]$ for $(Y_m)_{m \geq N}$. From (5.4) and Algorithm 5.2, we see that the distribution of $(Y_m)_{m \geq N}$ can be described as follows: for all m , $Y_{m+1} - Y_m$ is independent of Y_N, \dots, Y_m and

$$Y_{m+1} - Y_m \sim \begin{cases} \mathcal{N}(-d, \sigma^2) & \text{if } Y_m > d \\ \mathcal{N}(d, \sigma^2) & \text{if } Y_m < -d \\ \mathcal{N}(0, 4\sigma^2) & \text{if } |Y_m| \leq d. \end{cases}$$

The initial distribution of $(Y_m)_{m \geq N}$ is

$$Y_N = X_{N,N}^{(H)} + \log \frac{\tau^{(2)}([0, 1] \setminus B_N)}{\tau^{(1)}([0, 1] \setminus B_N)}.$$

This process is clearly attracted to the interval $[-d, d]$ and so we should expect it to spend a constant proportion of its time in this interval in the long run. One obstacle to proving a large deviation estimate as $N \rightarrow \infty$ for this occupation time is the fact that the initial distribution Y_N increases in magnitude with N . Fortunately this can be controlled fairly easily using tail bounds for $\tau^{(j)}$ and the Gaussian distribution:

Lemma 5.3 (Initial distribution). *Given $a > 0$, for all $\rho > 0$ sufficiently small and $\gamma < \gamma_0(\rho)$*

$$\mathbb{P} \left(|Y_N| > \frac{dN}{4} \right) \leq C \rho^{(2+3\epsilon)5N}$$

for some $C > 0$ and all N sufficiently large.

Proof. Since $X_{N,N}^{(H)}$ is a centred Gaussian with variance bounded above by $C\gamma^2 N \log(1/\rho)$ for an absolute constant C , using the standard Gaussian tail inequality we have

$$\mathbb{P}\left(|X_{N,N}^{(H)}| > \frac{dN}{4}\right) \leq \exp\left(-d^2 N / (32C\gamma^2 \log(1/\rho))\right).$$

Choosing γ sufficiently small, depending on ρ , we can ensure that the latter is bounded above by $C\rho^{(2+3\epsilon)5N}$.

By the union bound

$$\begin{aligned} \mathbb{P}\left(\left|\log \frac{\tau^{(2)}([0, 1] \setminus B_N)}{\tau^{(1)}([0, 1] \setminus B_N)}\right| > (d/4)N\right) \\ \leq 2\mathbb{P}\left(\tau^{(j)}([0, 1] \setminus B_N) > e^{(d/8)N}\right) + 2\mathbb{P}\left(\tau^{(j)}([0, 1] \setminus B_N)^{-1} > e^{(d/8)N}\right) \\ \leq 2\mathbb{P}\left(\tau^{(j)}([0, 1]) > e^{(d/8)N}\right) + 2\mathbb{P}\left(\tau^{(j)}([0, 1])^{-1} > 2^{-1}e^{(d/8)N}\right) \\ + 2\mathbb{P}\left(\tau^{(j)}(B_N)/\tau^{(j)}([0, 1]) > 2^{-1}\right). \end{aligned}$$

By Proposition 4.2 (specifically the statement for the event $\text{Scal}(N)$) the final term above is at most $C\rho^{(2+3\epsilon)5N}$. Recall from Lemma 2.1 that $\mathbb{E}[\tau^{(j)}([0, 1])^p] < \infty$ for all $p \in (-\infty, 2/\gamma^2)$. We choose $p > (2 + 3\epsilon)40$ which, by (5.5), ensures that $e^{-pd/8} < \rho^{(2+3\epsilon)5}$. Taking γ small enough that $p < 2/\gamma^2$, by the Markov inequality

$$\mathbb{P}(\tau^{(j)}([0, 1]) > e^{(d/8)N}) \leq \mathbb{E}[\tau^{(j)}([0, 1])^p] e^{-(pd/8)N} \leq C_p \rho^{(2+3\epsilon)5N}$$

as required. Similarly

$$\mathbb{P}(\tau^{(j)}([0, 1])^{-1} > 2^{-1}e^{(d/8)N}) \leq \mathbb{E}[\tau^{(j)}([0, 1])^{-p}] 2^p e^{-(pd/8)N} \leq C'_p \rho^{(2+3\epsilon)5N}$$

completing the proof of the lemma. \square

Our next objective is to control how long it takes for Y_m to travel from the (typically large) initial value Y_N to the interval $[-d, d]$. Intuitively this is just the time that a negatively biased random walk started at a large positive value takes to first cross the origin. However since our steps are normally distributed it is possible for the walk to ‘overshoot’ the interval $[-d, d]$ and then become a random walk biased in the opposite direction. We control the overshoot distribution with the following lemma:

Lemma 5.4. *Let $S = \inf\{m \geq N : Y_m \leq d\}$ then for any $a \leq -d$*

$$\mathbb{P}(Y_S < a \mid Y_N > d) \leq C e^{-\frac{a^2}{2\sigma^2}}$$

where $C > 0$ is an absolute constant. Moreover this is true even if we allow Y_N to have an arbitrary distribution (which is independent of $(Y_m - Y_N)_{m>N}$ and not supported on $(-\infty, d]$).

Proof. Throughout this proof we condition on the event $\{Y_N > d\}$ and so we omit this from our notation. By partitioning over the different possible values of S

$$\mathbb{P}(Y_S < a) = \sum_{n=1}^{\infty} \mathbb{P}(Y_n < a \mid S = n) \mathbb{P}(S = n) \leq \sup_{n \in \mathbb{N}} \mathbb{P}(Y_n < a \mid S = n).$$

By definition of S , for a given n

$$\begin{aligned} \mathbb{P}(Y_n < a \mid S = n) &= \mathbb{P}(Y_n < a \mid Y_n \leq d < Y_1, \dots, Y_{n-1}) \\ &= \frac{\mathbb{P}(Y_n < a, Y_{n-1} > d \mid Y_1, \dots, Y_{n-2} > d)}{\mathbb{P}(Y_n \leq d, Y_{n-1} > d \mid Y_1, \dots, Y_{n-2} > d)}. \end{aligned}$$

If we write \tilde{p} for the law of Y_{n-1} conditional on the event $Y_1, \dots, Y_{n-2} > d$, then by independence of increments we can rewrite the above expression as

$$\frac{\int_d^\infty \mathbb{P}(Y_n < a \mid Y_{n-1} = u) d\tilde{p}(u)}{\int_d^\infty \mathbb{P}(Y_n < d \mid Y_{n-1} = u) d\tilde{p}(u)} \leq \sup_{u>d} \frac{\mathbb{P}(Y_n < a \mid Y_{n-1} = u)}{\mathbb{P}(Y_n < d \mid Y_{n-1} = u)}$$

where this inequality follows from simply factoring out the supremum. The distribution of Y_n conditional on $Y_{n-1} = u > d$ is Gaussian with mean $u - d$ and variance σ^2 (independent of n). Therefore we conclude that

$$\mathbb{P}(Y_S < a) \leq \sup_{u \geq d} \mathbb{P}\left(Z < \frac{a + d - u}{\sigma} \mid Z < \frac{2d - u}{\sigma}\right) = \sup_{u \geq 0} \mathbb{P}\left(Z < \frac{a - u}{\sigma} \mid Z < \frac{d - u}{\sigma}\right)$$

where $Z \sim \mathcal{N}(0, 1)$. We can bound this expression using the standard Gaussian tail inequalities

$$\frac{1}{\sqrt{2\pi}} \left(\frac{1}{x} - \frac{1}{x^3}\right) e^{-x^2/2} \leq \mathbb{P}(\mathcal{N}(0, 1) > x) \leq \min\left\{1, \frac{1}{\sqrt{2\pi}x}\right\} e^{-x^2/2}$$

valid for $x > 0$. Applying this with $u \in [0, d + 2\sigma]$ we have

$$\mathbb{P}\left(Z < \frac{a - u}{\sigma} \mid Z < \frac{d - u}{\sigma}\right) \leq \mathbb{P}\left(Z < \frac{a - u}{\sigma}\right) / \mathbb{P}(Z < -2) \leq C e^{-\frac{(a-u)^2}{2\sigma^2}}.$$

Since $a - u \leq a < 0$, the latter is at most $C e^{-a^2/(2\sigma^2)}$. Similarly for $u > d + 2\sigma$

$$\mathbb{P}\left(Z < \frac{a - u}{\sigma} \mid Z < \frac{d - u}{\sigma}\right) \leq \frac{\frac{\sigma}{u-a} e^{-\frac{(u-a)^2}{2\sigma^2}}}{\frac{\sigma}{u-d} \left(1 - \frac{\sigma^2}{(u-d)^2}\right) e^{-\frac{(u-d)^2}{2\sigma^2}}} \leq \frac{u-d}{u-a} \frac{1}{1 - \frac{\sigma^2}{(u-d)^2}} e^{-\frac{a^2 - 2au + 2du - d^2}{2\sigma^2}}.$$

The two fractional terms are bounded above by 1 and $4/3$ respectively for all $u > d + 2\sigma$ whilst the exponential term is bounded above by $e^{-a^2/(2\sigma^2)}$, completing the proof of the lemma. \square

We can now give the desired tail estimate on the first stopping time T_1 , conditional on the initial value Y_N . (In fact by the Markov property, we will be able to apply the following result to each of the stopping times T_n . So this is really the key estimate of the subsection.)

Lemma 5.5 (Burn-in period). *Given $\kappa, \rho \in (0, 1)$, for all $\gamma > 0$ sufficiently small and all $j \in \mathbb{N}$*

$$\mathbb{P}(T_1 - N > j \mid Y_N = u) < \kappa^{2j-8|u|/d}.$$

Proof. We will assume that $u > d$; the case $u < -d$ follows by symmetry of the oscillating random walk about zero and the case $|u| \leq d$ is trivial since this implies $T_1 = N$. We inductively define the stopping times $(S_k)_{k \geq 0}$ by $S_0 := N$,

$$S_{2k+1} = \inf\{m > S_{2k} \mid Y_m \leq d\} \wedge T_1 \quad \text{and} \quad S_{2k} = \inf\{m > S_{2k-1} \mid Y_m \geq -d\} \wedge T_1$$

where $n_1 \wedge n_2 := \min\{n_1, n_2\}$ and as usual the infimum of an empty set is defined to be ∞ . So informally speaking, S_k is the k -th time that the oscillating random walk crosses over the interval $[-d, d]$ without hitting it (see Figure 12). Let η be the number of such crossings, i.e. η is the smallest integer such that

$$(5.6) \quad T_1 - N = \sum_{k=0}^{\eta} S_{k+1} - S_k.$$

Our first goal is to prove a tail bound for η . For $k \in \mathbb{N}$,

$$\mathbb{P}(\eta \geq k \mid \eta \geq k-1) = \mathbb{P}(|Y_{S_k}| > d \mid |Y_{S_{k-1}}| > d).$$

The event $\{|Y_{S_{k-1}}| > d\}$ is measurable with respect to the stopped filtration $\mathcal{F}_{S_{k-1}}$ (where $\mathcal{F}_n = \sigma(Y_1, \dots, Y_n)$ is the natural filtration) and conditioning on this event induces some distribution on $Y_{S_{k-1}}$. We call the distribution Λ_{k-1} and note that Λ_{k-1} is supported on $\mathbb{R} \setminus [-d, d]$. By the strong Markov property then

$$\mathbb{P}(|Y_{S_k}| > d \mid |Y_{S_{k-1}}| > d) = \mathbb{P}(|Y_{S_1}| > d \mid Y_N \sim \Lambda_{k-1})$$

where, in a slight abuse of notation, the latter expression means we consider a random walk with the same distribution as Y_m except that the first variable Y_N has the distribution Λ_{k-1} . By symmetry, the latter expression is equal to

$$\mathbb{P}(Y_{S_1} < -d \mid Y_N \sim \Lambda'_{k-1})$$

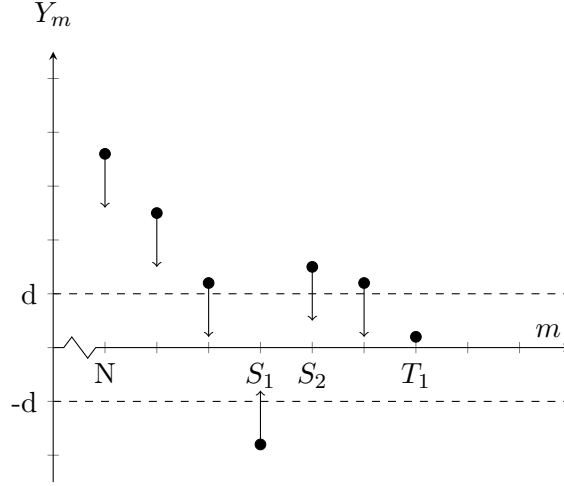

FIGURE 12. An illustration of the stopping times $(S_k)_{k \geq 0}$. Arrows indicate the expected increments of the process Y_m . Roughly speaking, S_{k+1} is the first time after S_k that Y_m ‘crosses over’ the interval $[-d, d]$ before hitting it. For the illustrated process $\eta = 2$ because $T_1 = S_3 > S_2$.

for some Λ'_{k-1} supported on $[d, \infty)$. By Lemma 5.4 this probability is at most $Ce^{-d/(2\sigma^2)}$ for an absolute constant C . Therefore taking σ sufficiently small relative to d we may ensure that for all $k \in \mathbb{N}$, $\mathbb{P}(\eta \geq k \mid \eta \geq k-1)$ is smaller than any given constant. Recalling (5.5) we see that this can be done by taking γ sufficiently small relative to ρ . Hence, by iterated conditioning, we can choose γ small enough that for all $j \in \mathbb{N}$

$$(5.7) \quad \mathbb{P}(\eta > j/8) \leq \frac{1}{3}\kappa^{2j}.$$

With this bound proven, it is now enough for us to control the probability that

$$\sum_{k=0}^{j/8} S_{k+1} - S_k > j.$$

We consider the first term of this sum separately: if $S_1 - S_0 > j/2$ then the first $\lfloor j/2 \rfloor$ increments of the random walk must have negative drift and the sum of these increments and the initial value must be greater than d . Therefore

$$(5.8) \quad \begin{aligned} \mathbb{P}(S_1 - S_0 > j/2 \mid Y_N = u) &\leq \mathbb{P}\left(u + \mathcal{N}(-d\lfloor j/2 \rfloor, \sigma^2\lfloor j/2 \rfloor) > d\right) \\ &= \mathbb{P}\left(\mathcal{N}(0, 1) > \frac{d(\lfloor j/2 \rfloor + 1) - u}{\sigma\sqrt{\lfloor j/2 \rfloor}}\right). \end{aligned}$$

We may assume that $j \geq 4u/d$ since otherwise the statement of the lemma becomes trivial. Hence the above expression is bounded by

$$(5.9) \quad \mathbb{P}\left(\mathcal{N}(0, 1) > \frac{\sqrt{2jd}}{4\sigma}\right) \leq e^{-\frac{jd^2}{16\sigma^2}}$$

using the standard Gaussian tail inequality. Taking σ^2 sufficiently small, we can ensure that this is at most $\kappa^{2j}/3$.

Now moving to the subsequent increments, for any $i \in \mathbb{N}$ by the union bound

$$(5.10) \quad \begin{aligned} \mathbb{P}(S_{k+1} - S_k > i \mid S_1, \dots, S_k) &\leq \mathbb{P}\left(\{S_{k+1} - S_k > i\} \cap \{|Y_{S_k}| \leq id/2\} \mid S_1, \dots, S_k\right) \\ &\quad + \mathbb{P}(|Y_{S_k}| > id/2 \mid S_1, \dots, S_k) \end{aligned}$$

and we consider these two terms in turn. For any increasing sequence $n_1 < \dots < n_k$

$$\begin{aligned} \mathbb{P}(\{S_{k+1} - S_k > i\} \cap \{|Y_{n_k}| \leq i/2\} \mid S_1 = n_1, \dots, S_k = n_k) \\ \leq \mathbb{P}(\{Y_{n_k} - id + Z_i > d\} \cap \{|Y_{n_k}| \leq id/2\} \mid S_1 = n_1, \dots, S_k = n_k) \\ \leq \mathbb{P}(Z_i > id/2 \mid S_1 = n_1, \dots, S_k = n_k) \end{aligned}$$

where $Z_i \sim \mathcal{N}(0, i\sigma^2)$ is independent of S_1, \dots, S_k, Y_{n_k} , which allows us to drop the conditioning and bound the expression by $e^{-id^2/(8\sigma^2)}$. Since this bound is uniform over the choice of n_1, \dots, n_k it holds for the first term on the right hand side of (5.10).

Turning to the second term in (5.10), let us assume that k is odd (a near identical proof holds if k is even). We again fix $n_1 < \dots < n_k$ and define

$$A = \{S_1 = n_1, \dots, S_{k-1} = n_{k-1}\} \cap \{Y_{n_{k-1}}, \dots, Y_{n_k} > d\}$$

so that $A \cap \{Y_{n_k} \leq d\} = \{S_1 = n_1, \dots, S_k = n_k\}$ (this is where we use the fact that k is odd). Then

$$\begin{aligned} \mathbb{P}(|Y_{S_k}| > id/2 \mid S_1 = n_1, \dots, S_k = n_k) &= \mathbb{P}(Y_{S_k} < -id/2 \mid A \cap \{Y_{n_k} \leq d\}) \\ &= \frac{\mathbb{P}(Y_{n_k} < -id/2 \mid A)}{\mathbb{P}(Y_{n_k} \leq d \mid A)} \end{aligned}$$

By conditioning over the different possible values of $Y_{n_{k-1}}$ and using the Markov property, this is at most

$$\sup_{u \geq d} \mathbb{P}(Y_{n_k} - Y_{n_{k-1}} < -id/2 - u \mid Y_{n_k} - Y_{n_{k-1}} < d - u) = \sup_{u \geq 0} \mathbb{P}(Z < -id/2 - u \mid Z < d - u)$$

where $Z \sim \mathcal{N}(0, \sigma^2)$. In the proof of Lemma 5.4 it was shown that this expression is bounded above, for $i \geq 2$, by $Ce^{-i^2d^2/(8\sigma^2)}$. We conclude that the right hand side of (5.10) is bounded above by $C'e^{-id^2/(8\sigma^2)}$ for all $i \geq 2$ and an absolute constant $C' > 0$.

Let $\theta > 1$, then using a standard identity for $\mathbb{E}[\theta^X]$ when X is some random variable taking values in $\{0\} \cup \mathbb{N}$, we have

$$\begin{aligned} \mathbb{E}[\theta^{S_{k+1} - S_k} \mid S_1, \dots, S_k] &= 1 + (\theta - 1) \sum_{i=0}^{\infty} \theta^i \mathbb{P}(S_{k+1} - S_k > i \mid S_1, \dots, S_k) \\ &\leq 1 + (\theta - 1) \left(1 + \theta + \sum_{i=2}^{\infty} \theta^i C' e^{-id^2/(8\sigma^2)} \right) \end{aligned}$$

Thus for each $\theta > 0$ we can choose σ sufficiently small relative to d to ensure that this expression is less than, say, $2\theta^2$.

We now apply this to the sum of crossing times. Let us choose $\theta > 0$ such that $e^{-\theta/4} < \epsilon/2$ (and then take σ sufficiently small to satisfy the previous inequalities for this choice of θ). By the Markov inequality and standard properties of conditional expectation

$$\begin{aligned} \mathbb{P}\left(\sum_{k=1}^{j/8} S_{k+1} - S_k > j/2\right) &\leq \theta^{-j/2} \mathbb{E}\left[\theta^{\sum_{k=1}^{j/8} S_{k+1} - S_k}\right] \\ &\leq \theta^{-j/2} \mathbb{E}\left[\mathbb{E}[\theta^{S_{j/8+1} - S_{j/8}} \mid S_1, \dots, S_{j/8}] \theta^{\sum_{k=1}^{j/8-1} S_{k+1} - S_k}\right] \\ &\leq \theta^{-j/2} 2\theta^2 \mathbb{E}\left[\theta^{\sum_{k=1}^{j/8-1} S_{k+1} - S_k}\right] \leq \dots \leq 2^{j/8} \theta^{-j/4}. \end{aligned}$$

Choosing θ sufficiently large, which in turn requires σ^2 and hence γ sufficiently small, the above expression is at most κ^{2j} . Combining this with (5.6), (5.7) and (5.8)-(5.9) completes the proof of the lemma. \square

Combining this tail bound on T_1 with the Markov property allows us to prove a large deviation bound for the occupation time of the oscillating random walk.

Lemma 5.6 (Occupation time). *Given $\rho > 0$, there exists $\delta > 0$ such that for all $\gamma < \gamma_0(\rho)$*

$$\mathbb{P}(T_{14\delta N} > 3N) < C\rho^{(2+3\epsilon)5N}$$

for some $C > 0$ and all $N \in \mathbb{N}$.

Proof. Defining $\delta' = 14\delta$, let us write

$$T_{\delta'N} = T_0 + \sum_{k=1}^{\delta'N} T_k - T_{k-1}.$$

Our aim is to apply Lemma 5.5 to each term in this sum (using the Markov property). First note that by combining Lemma 5.3 and Lemma 5.5 with $\kappa = \rho^{(2+3\epsilon)5}$, the probability that $T_1 - T_0 > N$ is less than $C\rho^{(2+3\epsilon)5N}$.

Next by the Markov property, for any $k, j \in \mathbb{N}$ we have

$$\begin{aligned} \mathbb{P}(T_k - T_{k-1} > j \mid T_1, \dots, T_{k-1}) &\leq \sup_{u \in [-d, d]} \mathbb{P}(T_k - T_{k-1} > j \mid Y_{T_{k-1}} = u) \\ &= \sup_{u \in [-d, d]} \int_{\mathbb{R} \setminus [-d, d]} \mathbb{P}(T_k - T_{k-1} > j \mid Y_{T_{k-1}+1} = v) p_u(v) dv \end{aligned}$$

where $p_u(v)$ denotes the density of a $\mathcal{N}(u, 4\sigma^2)$ random variable and we have removed $[-d, d]$ from the domain of integration because $T_k - T_{k-1} = 1$ if $Y_{T_{k-1}+1}$ falls in this interval. Since (Y_m) is a time-homogeneous Markov chain, we can apply Lemma 5.5 to bound the latter expression by

$$\sup_{u \in [-d, d]} \int_{\mathbb{R} \setminus [-d, d]} \kappa^{2(j-1)-8|v|/d} p_u(v) dv.$$

As σ decreases to zero, the distribution $p_u(\cdot)$ will concentrate around $u \in [-d, d]$. In particular for $\sigma > 0$ sufficiently small, we can ensure that the above integral is bounded by, say, $\kappa^{2(j-1)-8}$ where $\kappa > 0$ will be specified below.

Now for $\theta > 1$, using the same identity introduced in the proof of Lemma 5.5

$$\begin{aligned} \mathbb{E} [\theta^{T_k - T_{k-1}} \mid T_1, \dots, T_{k-1}] &= 1 + (\theta - 1) \sum_{j=0}^{\infty} \theta^j \mathbb{P}(T_k - T_{k-1} > j \mid T_1, \dots, T_{k-1}) \\ &\leq 1 + (\theta - 1) \left(1 + \sum_{j=1}^{\infty} \theta^j \kappa^{2j-10} \right) = \theta + (\theta - 1) \kappa^{-10} \frac{\theta \kappa^2}{1 - \theta \kappa^2} \end{aligned}$$

where the final inequality holds for $\theta \kappa^2 < 1$. If we take $\kappa^2 = \theta^{-1}/2$ then this expression is bounded by $2^6 \theta^6$. By iterating this inequality (analogously to the argument in the proof of Lemma 5.5) we find that

$$\mathbb{P}(T_{\delta'N} - T_1 > N) \leq \theta^{-N} \mathbb{E} \left[\theta^{\sum_{n=2}^{\delta'N} T_n - T_{n-1}} \right] \leq \theta^{-N} (2\theta)^{6(\delta'N-1)}.$$

Choosing $\delta' < 1/6$ and θ sufficiently large (the latter of which is possible by choosing σ sufficiently small) we find that this expression is at most $\rho^{(2+3\epsilon)5N}$. Combined with the analogous bound for $T_1 - T_0 = T_1 - (N-1)$ this proves the lemma. \square

5.4. Reduced size and shape events.

Lemma 5.7. *For all $\kappa > 0$, all $\rho > 0$ sufficiently small, all $\gamma < \gamma_0(\rho, \kappa)$ and all $M \in \mathbb{N}$ the sequence $(\mathbb{1}_{\text{SizeRed}(t_n, s_n)})_{n=1}^M$ stochastically dominates a sequence of M i.i.d. Bernoulli random variables with parameter $1 - \kappa$.*

Proof. We write $\chi_n = \mathbb{1}_{\text{SizeRed}(t_n, s_n)}$ and define

$$A = \{\chi_1 = a_1, \dots, \chi_n = a_{n-1}\}$$

where $a_1, \dots, a_{n-1} \in \{0, 1\}$. From Algorithm 5.2, we see that conditional on Y_{T_n} , χ_n is independent of $\chi_1, \dots, \chi_{n-1}$. Therefore

$$(5.11) \quad \mathbb{P}(\chi_n = 1 \mid A) = \int_{-d}^d \mathbb{P}(\chi_n = 1 \mid Y_{T_n} = u) dp(u)$$

where p denotes the law of Y_{T_n} conditional on A . We wish to show that this integrand is bounded below by $1 - \kappa$ (for sufficiently small γ). Recall from the definitions in Section 5.2 that

$$\text{SizeRed}(t_n, s_n) = \left\{ \left| Y_{T_n} + X_{t_n, s_n}^{(V)} - X_{i_{T_n}, j_{T_n}}^{(V)} \right| \leq \log(2) \right\}$$

and that, conditional on $Y_{T_n} = u$, $X_{t_n, s_n}^{(V)} - X_{i_{T_n}, j_{T_n}}^{(V)}$ is normally distributed with mean $-u$ and variance bounded above by $4\sigma^2$. Therefore

$$\mathbb{P}(\chi_n = 1 \mid Y_{T_n} = u) \geq \mathbb{P}(2\sigma|Z| \leq \log(2))$$

where $Z \sim \mathcal{N}(0, 1)$. Clearly we can ensure that this probability is greater than $1 - \kappa$ by choosing σ sufficiently small. This is equivalent to choosing $\gamma > 0$ small depending on $\rho, \kappa > 0$. Hence by (5.11) we see that the probability of $\{\chi_n = 1\}$ is at least $1 - \kappa$ independent of conditioning on $\chi_1, \dots, \chi_{n-1}$. This is true for any n , so by iteration we see that χ_1, \dots, χ_M stochastically dominates an i.i.d. sequence of Bernoulli variables with parameter $1 - \kappa$. \square

Lemma 5.8. *The statement of Lemma 5.7 holds if we replace $\text{SizeRed}(t_n, s_n)$ by either $\text{ShapeRed}^{(1)}(t_n)$ or $\text{ShapeRed}^{(2)}(s_n)$ and take t_n, s_n greater than some N_0 depending on ρ, κ .*

Proof. We give only the argument for $\text{ShapeRed}^{(1)}(t_n)$ since the argument for $\text{ShapeRed}^{(2)}(s_n)$ is entirely symmetric. Let $\chi_t = \mathbb{1}_{\text{ShapeRed}^{(1)}(t)}$ and for $m \geq N$ define

$$Z_m = \begin{cases} \chi_{t_n} & \text{if } m - 1 = T_n \text{ for some } n \geq 0 \\ 0 & \text{otherwise.} \end{cases}$$

We first show that $(Y_m, Z_m)_{m \geq N}$ is a Markov chain. In order to construct an explicit filtration, we define a different version of the process as follows: let W_1, W_2, \dots be an independent sequence of hyperbolic white noise processes (as defined in Section 1) and let $\mathcal{F}_m = \sigma(W_1, \dots, W_{2m})$. For each $m \geq N$ we let $(Y_m - Y_{m-1}, Z_m)$ be defined as in Algorithm 5.2 except that $V^{(1)}, \nu^{(1)}, \tau^{(1)}$ etc are sampled using W_{2m-1} and $V^{(2)}, \nu^{(2)}$ etc are sampled using W_{2m} . This does not change the distribution of $(Y_m - Y_{m-1}, Z_m)_{m \geq N}$ since each element of this sequence is determined by the restriction of the white noise to disjoint domains; the original white noise W is independent on these domains and so it does not matter if we instead sample from W_{2m-1} and W_{2m} . To be more precise, $Y_m - Y_{m-1}$ is determined by the white noise for $\nu^{(1)}$ restricted to $\mathcal{V} \cap \{(x, y) \mid \rho^{im} \leq y \leq \rho^{i_{m-1}}\}$ and the white noise for $\nu^{(2)}$ restricted to $\mathcal{V} \cap \{(x, y) \mid \rho^{jm} \leq y \leq \rho^{j_{m-1}}\}$. Similarly Z_m is determined by the white noise for $\nu^{(1)}$ restricted to

$$\bigcup_{\rho^{tn+3/4} \leq |a| \leq 2\rho^{tn}} (\mathcal{V} + a) \cap \{(x, y) \mid y \leq \rho^{i_{m-1}}\}.$$

These regions are disjoint for distinct values of m (Figures 8 and 9 show the corresponding regions with \mathcal{H} instead of \mathcal{V}).

For each $n \in \mathbb{N}$ we note that T_n is a stopping time with respect to (\mathcal{F}_k) and that the events $\text{ShapeRed}^{(1)}(t_1), \dots, \text{ShapeRed}^{(1)}(t_{n-1})$ are measurable with respect to the stopped σ -algebra \mathcal{F}_{T_n} . Therefore to prove the result, it is enough to show that for n sufficiently large

$$\mathbb{E}[\chi_{t_n} \mid \mathcal{F}_{T_n}] \geq 1 - \kappa$$

almost surely. By definition of ShapeRed we see that

$$\chi_{t_n} = G(t_n, W_{2T_n-1})$$

for some measurable function G . Since W_{2T_n-1} is independent of \mathcal{F}_{T_n} and t_n is measurable with respect to this σ -algebra, we see that

$$\mathbb{E}[\chi_{t_n} \mid \mathcal{F}_{T_n}] = \tilde{G}(t_n)$$

where $\tilde{G}(u) := \mathbb{E}[G(u, W_1)] = \mathbb{P}(\text{ShapeRed}^{(1)}(u))$ for any constant $u \geq 1$. Therefore the lemma follows if we can show that the latter probability is at least $1 - \kappa$ for all $u \geq N_0(\rho, \kappa)$. This is precisely the statement of the next lemma. \square

Lemma 5.9. *Given $\kappa > 0$, there exists $\gamma_0 > 0$ such that for all $\gamma \leq \gamma_0$ and all t sufficiently large*

$$\mathbb{P}(\text{ShapeRed}^{(1)}(t)) \geq 1 - \kappa.$$

Proof. Throughout this proof, we denote $\nu_t = \nu_t^{(1)}$ and $\tau_t = \tau_t^{(1)}$ since the superscripts play no role in our argument. For any Borel set $I \subset [0, 1]$ and any $t \geq 1$, it is clear from the definition that

$$\frac{\tau_t(I)}{\nu_t(I)} = \lim_{\delta \downarrow 0} \frac{\int_I \exp(\gamma(H_\delta(a) - H_{\rho^t}(a)) - (\gamma^2/2)\text{Var}[H_\delta(0) - H_{\rho^t}(0)]) da}{\int_I \exp(\gamma(V_\delta(a) - V_{\rho^t}(a)) - (\gamma^2/2)\text{Var}[V_\delta(0) - V_{\rho^t}(0)]) da}$$

is bounded above and below by $\exp(\pm G_{t,\gamma})$ where

$$G_{t,\gamma} = \sup_{\delta \in (0, \rho^t]} \sup_{a \in [0, 1]} \left| \gamma U_\delta^{\rho^t}(a) - \frac{\gamma^2}{2} \text{Var}[U_\delta^{\rho^t}(a)] \right|$$

and we recall the definition of U from Lemma 4.5. Applying this lemma, we see that as $t \rightarrow \infty$, $G_{t,\gamma}$ converges to zero in probability uniformly over γ . Therefore in each of the events defining $\text{ShapeRed}(t)$ we can replace τ_t by ν_t provided we shrink the intervals by some constant. More precisely it is enough to prove that for some $\delta > 0$ and all $t \geq N_0(\rho, \kappa)$, the probability of

$$(5.12) \quad \begin{aligned} & \left\{ 1 + \delta \leq \nu_t(B_t \setminus B_{\lfloor t \rfloor + 3/4}) \rho^{-t} \leq 2^2 - \delta \right\} \cap \bigcap_{\ell=1}^8 \left\{ \frac{\nu_t(J_{t,\ell} \setminus B_{\lfloor t \rfloor + 3/4})}{\nu_t(B_t \setminus B_{\lfloor t \rfloor + 3/4})} \geq 2^{-4} + \delta \right\} \\ & \cap \left\{ \frac{\nu_t(2B_{t+1/4} \setminus B_{\lfloor t \rfloor + 3/4})}{\nu_t(B_t \setminus B_{\lfloor t \rfloor + 3/4})} \leq 2^{-38} - \delta \right\} \cap \left\{ \frac{\nu_t(2B_t \setminus B_{\lfloor t \rfloor + 3/4})}{\nu_t(B_t \setminus B_{\lfloor t \rfloor + 3/4})} \leq 2^2 - \delta \right\} \\ & \cap \left\{ \sum_{m=0}^{\infty} \sum_{\ell \in S(m, \rho^{t+1/4}, \rho^t)} \frac{\nu_t(I_{m,\ell,t})^2}{\nu_t(B_t \setminus B_{\lfloor t \rfloor + 3/4})^2} \leq 2^5 - \delta \right\} \end{aligned}$$

is at least $1 - \kappa/2$.

Next we derive a scaling relation for the measures ν_t which shows that the probability of the previous event is roughly constant over t . Denoting $V_\delta^r(a) := V_\delta(a) - V_r(a)$ for $0 < \delta \leq r \leq 1/2$ and $a, b \in [-1/4, 1/4]$ we have

$$\text{Cov}[V_\delta^r(a), V_\delta^r(b)] = \begin{cases} \log(r/\delta) - |b-a|(1/\delta - 1/r) & \text{if } |b-a| \leq \delta \\ \log(r/|b-a|) - 1 + |b-a|/r & \text{if } \delta < |b-a| \leq r \\ 0 & \text{otherwise.} \end{cases}$$

(Note the restriction on a, b and r ensures that the periodicity of the white noise can be ignored.) This covariance structure is unchanged when all parameters are scaled by a common factor (less than one), more precisely: for $\beta \in (0, 1]$

$$\text{Cov}[V_\delta^r(a), V_\delta^r(b)] = \text{Cov}[V_{\beta\delta}^{\beta r}(\beta a), V_{\beta\delta}^{\beta r}(\beta b)].$$

Therefore we conclude that the two families of random variables

$$\int_{\beta I} \beta^{-1} \exp\left(\gamma V_{\beta\delta}^{\beta r}(x) - \frac{\gamma^2}{2} \text{Var}[V_{\beta\delta}^{\beta r}(0)]\right) dx \quad \text{and} \quad \int_I \exp\left(\gamma V_\delta^r(x) - \frac{\gamma^2}{2} \text{Var}[V_\delta^r(0)]\right) dx$$

indexed by $\delta \in (0, r]$ and Borel sets $I \subset [-1/4, 1/4]$ are equal in distribution. From the definition of ν_t in (4.8) we see that for any $t \geq 1$

$$(5.13) \quad \rho^{-t} \nu_t(\rho^t \cdot) \stackrel{d}{=} \rho^{-1} \nu_1(\rho \cdot) =: \nu_\star(\cdot).$$

(Note we view ν_\star as a measure on $[-2, 2]$ since $\rho \cdot [-2, 2] \subset [-1/4, 1/4]$ so the necessary restriction on a, b above holds.)

In [8, Appendix A] it is shown that there exists a version of $\nu_\star = \nu_\star^{(\gamma)}$ such that for any Borel set I , $\gamma \mapsto \nu_\star^{(\gamma)}(I)$ is analytic. In particular, as $\gamma \downarrow 0$

$$(5.14) \quad \nu_\star^{(\gamma)}(I) \rightarrow \nu_\star^{(0)}(I) = |I|.$$

Turning to the first part of the event (5.12), by monotonicity of ν_t we have the sandwich bound

$$\rho^{-t} \nu_t(B_t \setminus B_{t+3/4}) \leq \rho^{-t} \nu_t(B_t \setminus B_{\lfloor t \rfloor + 3/4}) \leq \rho^{-t} \nu_t(B_t).$$

By (5.13), the left and right expressions here are equal in distribution to

$$\nu_\star([-1, 1] \setminus [-\rho^{3/4}, \rho^{3/4}]) \quad \text{and} \quad \nu_\star([-1, 1])$$

respectively. By (5.14), as $\gamma \downarrow 0$ these converge in probability to $2(1 - \rho^{3/4})$ and 2 respectively. Hence by taking γ sufficiently small, we can ensure that

$$\mathbb{P}(\rho^{-t} \nu_t(B_t \setminus B_{\lfloor t \rfloor + 3/4}) \in [3/2, 5/2])$$

is as close to one as desired.

A very similar sandwiching approach yields the same conclusion for the next three parts of (5.12). The essence of the argument is the deterministic inequalities

$$\begin{aligned} \frac{|J_{t,\ell} \setminus B_{\lfloor t \rfloor + 3/4}|}{|B_t \setminus B_{\lfloor t \rfloor + 3/4}|} &\geq \frac{\frac{1}{4}\rho^t - 2\rho^{t+1/4}}{2\rho^t} = \frac{1}{8} - \rho^{1/4} \\ \frac{|2B_{t+1/4} \setminus B_{\lfloor t \rfloor + 3/4}|}{|B_t \setminus B_{\lfloor t \rfloor + 3/4}|} &\leq \frac{4\rho^{t+1/4}}{2\rho^t - 2\rho^{t+1/4}} \leq \frac{2\rho^{1/4}}{1 - \rho^{1/4}} \\ \frac{|2B_t \setminus B_{\lfloor t \rfloor + 3/4}|}{|B_t \setminus B_{\lfloor t \rfloor + 3/4}|} &\leq \frac{4\rho^t}{2\rho^t - 2\rho^{t+1/4}} \leq \frac{2}{1 - \rho^{1/4}} \end{aligned}$$

all of which satisfy the necessary bounds in (5.12) for ρ sufficiently small.

The final part of (5.12) requires slightly more work since it involves an infinite sum. Recalling the definitions

$$I_{m,\ell,t} = [(\ell - 2)\rho^t 2^{-m}, (\ell + 2)\rho^t 2^{-m}] \quad \text{and} \quad S(m, r, R) = \{\ell \in \mathbb{Z} \mid r \leq |\ell| R 2^{-m} \leq R\},$$

by (5.13)

$$\sum_{m=0}^{\infty} \sum_{\ell \in S(m, \rho^{t+1/4}, \rho^t)} \frac{\nu_t(I_{m,\ell,t})^2}{\nu_t(B_t \setminus B_{\lfloor t \rfloor + 3/4})^2} \leq \sum_{m=0}^{\infty} \sum_{|\ell| \leq 2^m} \frac{\nu_t(I_{m,\ell,t})^2}{\nu_t(B_t \setminus B_{t+1/4})^2} \stackrel{d}{=} \sum_{m=0}^{\infty} \sum_{|\ell| \leq 2^m} \frac{\nu_\star(I_{m,\ell,0})^2}{\nu_\star(B_0 \setminus B_{1/4})^2}.$$

By (4.10), for $\gamma \leq \gamma_0$ sufficiently small, the expectation of the latter quantity is at most

$$\sum_{m=0}^{\infty} 2^{m+1} \cdot C_{\gamma_0} (2^{-m+2})^{3/2} < \infty.$$

Therefore by the Markov inequality we can choose $M \in \mathbb{N}$ (independent of t, γ, ρ) large enough to ensure that

$$\mathbb{P}\left(\sum_{m=M}^{\infty} \sum_{|\ell| \leq 2^m} \frac{\nu_\star(I_{m,\ell,0})^2}{\nu_\star(B_0 \setminus B_{1/4})^2} > \delta\right)$$

is arbitrarily small. For γ sufficiently small, by (5.14) applied to finitely many intervals we know that with probability sufficiently close to one

$$\begin{aligned} \sum_{m=0}^M \sum_{|\ell| \leq 2^m} \frac{\nu_*(I_{m,\ell,0})^2}{\nu_*(B_0 \setminus B_{1/4})^2} &\leq \sum_{m=0}^M \sum_{|\ell| \leq 2^m} \frac{|I_{m,\ell,0}|^2}{|B_0 \setminus B_{1/4}|^2} + \delta \leq \sum_{m=0}^{\infty} 2^{m+1} \frac{2^{-2(m-2)}}{(2(1-\rho^{1/4}))^2} + \delta \\ &\leq \frac{16}{(1-\rho^{1/4})^2} + \delta. \end{aligned}$$

Combined with the previous displayed equations, this proves that the final event of (5.12) occurs with probability arbitrarily close to one for γ sufficiently small, completing the proof of the lemma. \square

Proof of Proposition 5.1. We denote

$$\chi_1(n) = \mathbb{1}_{\text{ShapeRed}^{(1)}(t_n)} \quad \chi_2(n) = \mathbb{1}_{\text{ShapeRed}^{(2)}(s_n)}, \quad \chi_3(n) = \mathbb{1}_{\text{SizeRed}(t_n, s_n)}.$$

By Lemma 5.6 there exists $\delta > 0$ such that for all γ sufficiently small

$$\mathbb{P}(T_{14\delta N} > 3N) < C\rho^{(2+3\epsilon)5N}.$$

From Algorithm 5.2 we see that $t_{14\delta N}, s_{14\delta N} \leq N + 2(T_{14\delta N} - N)$ and so with probability at least $1 - C\rho^{(2+3\epsilon)5N}$

$$(5.15) \quad \sum_{n: N \leq t_n, s_n \leq 5N} \chi_1(n)\chi_2(n)\chi_3(n) \leq \sum_{n=1}^{14\delta N} \chi_1(n)\chi_2(n)\chi_3(n).$$

By Lemma 5.8, for $N \geq N_0$ the sequence $\chi_1(n)$ dominates a Bernoulli sequence with parameter $1 - \kappa$. Therefore by the standard large deviation estimate for Bernoulli variables

$$\mathbb{P}\left(\sum_{n=1}^{14\delta N} \chi_1(n) < (1 - \eta)14\delta N\right) < e^{-32\delta N I(\eta, 1 - \kappa)}$$

where

$$I(\eta, 1 - \kappa) = \eta \log\left(\frac{\eta}{1 - \kappa}\right) + (1 - \eta) \log\left(\frac{1 - \eta}{\kappa}\right).$$

Choosing first η and then κ sufficiently small we may ensure that

$$\mathbb{P}\left(\sum_{n=1}^{14\delta N} \chi_1(n) < 13\delta N\right) < \rho^{(2+3\epsilon)5N}.$$

Applying Lemmas 5.8 to $\chi_2(n)$ and and 5.7 to $\chi_3(n)$, by the union bound we have

$$\mathbb{P}\left(\sum_{n=1}^{14\delta N} \chi_1(n)\chi_2(n)\chi_3(n) < 11\delta N\right) < 3\rho^{(2+3\epsilon)5N}.$$

Combined with (5.15) this proves the statement of the proposition. \square

REFERENCES

- [1] Robert J. Adler and Jonathan E. Taylor. *Random fields and geometry*. Springer Monographs in Mathematics. Springer, New York, 2007.
- [2] Lars V. Ahlfors. *Conformal invariants: topics in geometric function theory*. McGraw-Hill Series in Higher Mathematics. McGraw-Hill Book Co., New York-Düsseldorf-Johannesburg, 1973.
- [3] Lars V. Ahlfors. *Lectures on quasiconformal mappings*, volume 38 of *University Lecture Series*. American Mathematical Society, Providence, RI, second edition, 2006. With supplemental chapters by C. J. Earle, I. Kra, M. Shishikura and J. H. Hubbard.
- [4] Glen D. Anderson, Mavina K. Vamanamurthy, and Matti K. Vuorinen. *Conformal invariants, inequalities, and quasiconformal maps*. Canadian Mathematical Society Series of Monographs and Advanced Texts. John Wiley & Sons, Inc., New York, 1997.
- [5] Morris Ang, Nina Holden, and Xin Sun. Conformal welding of quantum disks. *Electronic Journal of Probability*, 28:1–50, 2023.

- [6] Morris Ang, Nina Holden, and Xin Sun. The SLE loop via conformal welding of quantum disks. *Electronic Journal of Probability*, 28:1–20, 2023.
- [7] Kari Astala, Tadeusz Iwaniec, and Gaven Martin. *Elliptic partial differential equations and quasiconformal mappings in the plane*, volume 48 of *Princeton Mathematical Series*. Princeton University Press, Princeton, NJ, 2009.
- [8] Kari Astala, Peter Jones, Antti Kupiainen, and Eero Saksman. Random conformal weldings. *Acta Math.*, 207(2):203–254, 2011.
- [9] E. Bacry and J. F. Muzy. Log-infinitely divisible multifractal processes. *Comm. Math. Phys.*, 236(3):449–475, 2003.
- [10] A. Beurling and L. Ahlfors. The boundary correspondence under quasiconformal mappings. *Acta Math.*, 96:125–142, 1956.
- [11] Iliia Binder and Tomas Kojar. Inverse of the gaussian multiplicative chaos: Moments. *arXiv preprint arXiv:2305.00360*, 2023.
- [12] Vladimir Gutlyanskii, Vladimir Ryazanov, Uri Srebro, and Eduard Yakubov. *The Beltrami equation*, volume 26 of *Developments in Mathematics*. Springer, New York, 2012. A geometric approach.
- [13] Ewain Gwynne, Nina Holden, and Xin Sun. Mating of trees for random planar maps and liouville quantum gravity: a survey. *arXiv preprint arXiv:1910.04713*, 2019.
- [14] Peter W. Jones and Stanislav K. Smirnov. Removability theorems for Sobolev functions and quasiconformal maps. *Ark. Mat.*, 38(2):263–279, 2000.
- [15] Gregory F. Lawler, Oded Schramm, and Wendelin Werner. Conformal invariance of planar loop-erased random walks and uniform spanning trees. *Ann. Probab.*, 32(1B):939–995, 2004.
- [16] Olli Lehto. Homeomorphisms with a given dilatation. In *Proceedings of the Fifteenth Scandinavian Congress (Oslo, 1968)*, Lecture Notes in Mathematics, Vol. 118, pages 58–73. Springer, Berlin, 1970.
- [17] Olli Lehto and Kaarlo Ilmari Virtanen. *Quasiconformal mappings in the plane*, volume 126. 1973.
- [18] Mikhail Lifshits. *Lectures on Gaussian processes*. SpringerBriefs in Mathematics. Springer, Heidelberg, 2012.
- [19] A. M. Polyakov. Quantum geometry of bosonic strings. *Phys. Lett. B*, 103(3):207–210, 1981.
- [20] A. M. Polyakov. Quantum geometry of fermionic strings. *Phys. Lett. B*, 103(3):211–213, 1981.
- [21] Raoul Robert and Vincent Vargas. Gaussian multiplicative chaos revisited. *The Annals of Probability*, 38(2):605 – 631, 2010.
- [22] Oded Schramm. Scaling limits of loop-erased random walks and uniform spanning trees. *Israel J. Math.*, 118:221–288, 2000.
- [23] Oded Schramm and Scott Sheffield. Harmonic explorer and its convergence to SLE₄. *The Annals of Probability*, 33(6):2127 – 2148, 2005.
- [24] Alexander Shamov. On Gaussian multiplicative chaos. *J. Funct. Anal.*, 270(9):3224–3261, 2016.
- [25] Scott Sheffield. Conformal weldings of random surfaces: SLE and the quantum gravity zipper. *Ann. Probab.*, 44(5):3474–3545, 2016.
- [26] Stanislav Smirnov. Critical percolation in the plane: conformal invariance, Cardy’s formula, scaling limits. *C. R. Acad. Sci. Paris Sér. I Math.*, 333(3):239–244, 2001.
- [27] Matti Vuorinen. *Conformal geometry and quasiregular mappings*, volume 1319 of *Lecture Notes in Mathematics*. Springer-Verlag, Berlin, 1988.
- [28] Dapeng Zhan. SLE loop measures. *Probability Theory and Related Fields*, 179:345–406, 2021.