

# Predictability and Fairness in Load Aggregation with Deadband

F. V. Difonzo, M. Roubalík, J. Marecek, *Member, IEEE*,

**Abstract**—Virtual power plants and load aggregation are becoming increasingly common. There, one regulates the aggregate power output of an ensemble of distributed energy resources (DERs). We consider the notion of predictability and fairness of Marecek et al. [Automatica, Volume 147, January 2023, 110743, arXiv:2110.03001], which suggest that the long-term averages of prices or incentives offered should exist and be independent of the initial states of the operators of the DER, the aggregator, and the power grid. We consider the effects of losses in the alternating current model and the deadband in the controller. This yields a non-linear dynamical system (due to the non-linear losses) exhibiting discontinuities (due to the deadband). Similarly to the case without a deadband, predictability and fairness cannot be guaranteed with many traditional controllers, including the usual proportional-integral (PI) controller with deadband. On the other hand, Filippov invariant measures enable reasoning about predictability and fairness while considering non-linearity of the alternating-current model and deadband.

**Index Terms**—Demand-side management, Load management, Power demand, Deadband, Power systems, Power system analysis computing.

## I. INTRODUCTION

Load aggregation of distributed energy resources (DERs) is an increasingly common response to the increasing integration of intermittent sources of energy [1]. In the European Union, this is now mandated by Regulation (EU) 2019/943 on the internal market for electricity sets, specifically requiring “fair rules”. More recent plans known as the RePowerEUR (COM/2022/230) suggest “fairness and solidarity are defining principles”. The fairness [2] may suggest that similar operators of DER receive a similar treatment in terms of load reductions, disconnections, incentives, prices, or power quality, over the long term, independent of the initial conditions, such as consumption at some point in the past. Below, we define these criteria formally in terms of properties of a certain stochastic model.

The regulation of the aggregate power output [3, 4, e.g.] is challenging for a number of reasons. First, it needs to consider participants of various forms, including roof-top photovoltaic systems, interruptible or deferrable loads, and battery energy storage systems. The load aggregation introduces a new feedback loop [5, 6] into a system. As highlighted by the 2030 roadmap of the IEEE Control systems society [7, cf. Section 2.D], it also presents an important technical challenge in control theory. The modelling of the non-deterministic

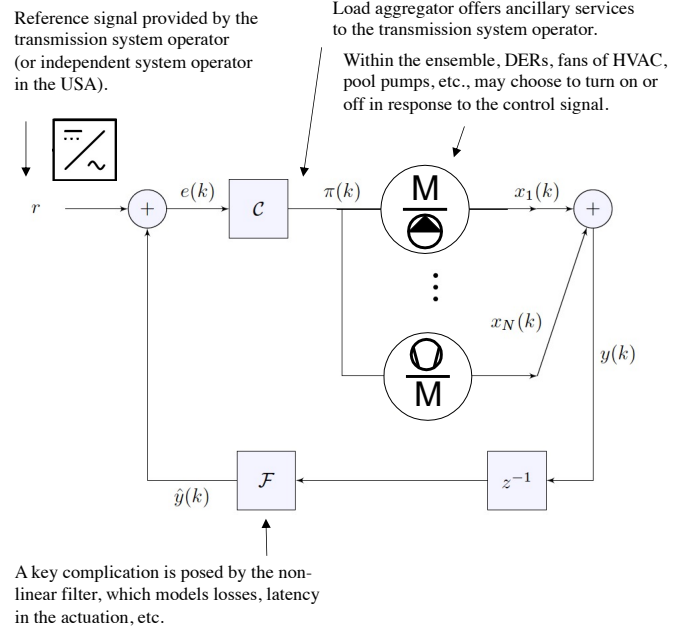

Fig. 1. An illustration of a closed-loop model, taken from [2]. In this paper, we reason about the deadband in the controllers  $\mathcal{C}$ .

behaviour of a time-varying availability of DERs is particularly challenging, especially when one wishes to study the “predictability and fairness” properties of Fioravanti et al. [8, 2], which require certain ergodicity. (Cf. page 43 in [7].) Besides, the system is already non-linear due to the losses in AC transmission and the use of deadband renders the dynamics discontinuous. Recent studies of load aggregation by Li et al. [6], Marecek et al. [2], and Kasis et al. [9, 10] have made a considerable progress in addressing the the closed the closed-loop aspects and the non-linearity of the losses.

In this paper, we aim to address all the challenges concurrently, including the deadband. Mathematically, this requires a fundamentally different approach, utilizing stochastic difference inclusions, rather than stochastic difference equations [8, 2, as in] or difference inclusions [9, 10, as in]. We present a framework for reasoning about ergodic properties of closed-loops with non-smooth controllers, such as deadband, and non-smooth response of the agents. We illustrate the ergodic behaviour in simulations using Matpower [11] on standard IEEE test cases and a test case of [2].

J. Marecek and M. Roubalík are at the Czech Technical University, Prague, the Czech Republic. J. Marecek is also at CEZ a.s.

F. V. Difonzo is at the University of Bari, Italy.

Manuscript received May 30, 2023.

Practically, this is important for two reasons. While deadband has been traditionally used primarily to protect the turbines of thermal and hydropower generators, the DERs such as pool pumps and compressors of HVAC are likewise quite sensitive to short-cycling. Enforcing a no-short-cycling requirement [12] may resemble a deadband in all but name.

Second, predictability and fairness cannot be guaranteed with many traditional controllers used by the load aggregator, including the usual proportional-integral (PI) controller, with or without a deadband. In particular, in the model of Fioravanti et al. [8, 7], the closed-loop system cannot have a unique invariant measure, making it impossible to satisfy the fairness properties, for any controller  $\mathcal{C}$  that is linear and marginally stable with a pole  $s_1 = e^{qj\pi}$  on the unit circle, where  $q$  is a rational number. With deadband, one introduces a discontinuity into the dynamics, which complicates the analysis substantially, but preserves this negative result.

## II. DEFINITIONS

Let us also reiterate some well-known definitions within discrete-time dynamical systems. In general, one may consider:

**Definition 1** (Discrete-time inclusion, [13]). *Let  $F$  be a set-valued map, whose values are closed subsets of  $\mathbb{R}^n$ . Then, a discrete-time inclusion is defined by:*

$$x(k+1) \in F(x(k)), \quad k \geq 0, \quad (1)$$

for some sequence  $\{x(k)\}_{k \in \mathbb{N}} \subseteq \mathbb{R}^n$ .

A natural stochastic extension assigns positive probability of moving from  $x(k)$  to states within  $F(x(k))$ :

**Definition 2** (Markov chain). *Let  $\Sigma$  be a closed subset of  $\mathbb{R}^n$  with the usual Borel  $\sigma$ -algebra  $\mathbb{B}(\Sigma)$ . We call the elements of  $\mathbb{B}(\Sigma)$  events. A Markov chain on  $\Sigma$  is a sequence of  $\Sigma$ -valued random vectors  $\{X(k)\}_{k \in \mathbb{N}}$  with the Markov property, which is the equality of a probability of an event conditioned on past events and probability of the same event conditioned on the current state, i.e., we always have*

$$\begin{aligned} \mathbb{P}(X(k+1) \in \mathcal{G} \mid X(j) = x_j, j = 0, 1, \dots, k) \\ = \mathbb{P}(X(k+1) \in \mathcal{G} \mid X(k) = x_k), \end{aligned}$$

where  $\mathcal{G}$  is an event and  $k \in \mathbb{N}$ . We assume the Markov chain is time-homogeneous. The transition operator  $\mathcal{P}$  of the Markov chain is defined for  $x \in \Sigma$ ,  $\mathcal{G} \in \mathbb{B}(\Sigma)$  by

$$P(x, \mathcal{G}) := \mathbb{P}(X(k+1) \in \mathcal{G} \mid X(k) = x). \quad (2)$$

If the initial condition  $X(0)$  is distributed according to an initial distribution  $\lambda$ , we denote by  $\mathbb{P}_\lambda$  the probability measure induced on the path space, i.e., space of sequences with values in  $\Sigma$ . Conditioned on an initial distribution  $\lambda$ , the random variable  $X(k)$  is distributed according to the probability measure  $\lambda_k$  which is determined inductively by  $\lambda_0 = \lambda$  and

$$\lambda_{k+1}(\mathcal{G}) := \int_{\Sigma} \mathcal{P}(x, \mathcal{G}) \lambda_k(dx), \quad (3)$$

for  $\mathcal{G} \in \mathbb{B}$ .

a) Evolutions of active powers  $(P_1, P_2)$  over time  $t$ .

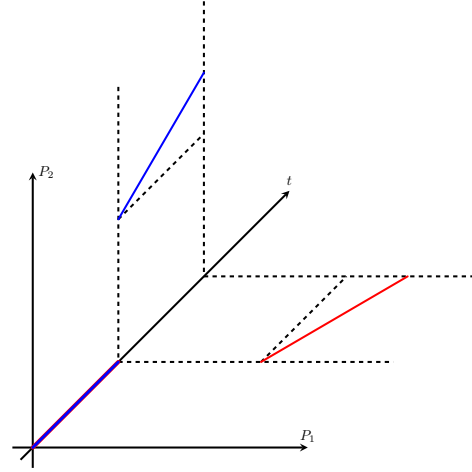

b) Neighbourhoods of evolutions of active powers  $(P_1, P_2)$  over time  $t$ .

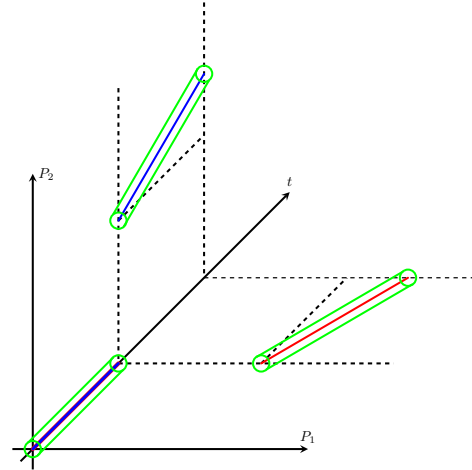

c) Convex hulls of the neighbourhoods of evolutions of active powers  $(P_1, P_2)$  over time  $t$ .

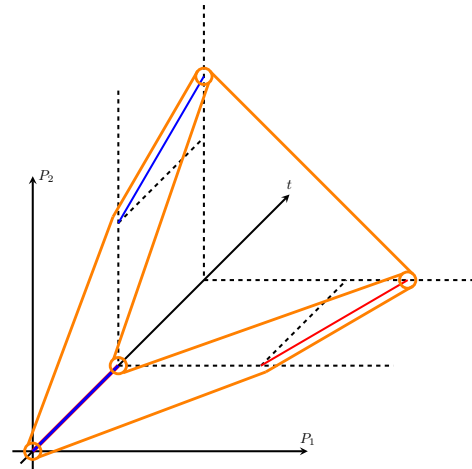

Fig. 2. An illustration of the Filippov convexification in three steps.

A key notion across both Markov chains and other stochastic extensions of differential inclusions is:

**Definition 3** (Invariant measure). *A probability measure  $\mu$  is called invariant with respect to the Markov process  $\{X(k)\}$  if it is a fixed point for the iteration described by (3), i.e., if*

$$\mathcal{P}\mu = \mu \quad (4)$$

*An invariant probability measure  $\mu$  is called attractive, if for every probability measure  $\nu$  the sequence  $\{\lambda_k\}$  defined by (3) with initial condition  $\nu$  converges to  $\mu$  in distribution.*

A generalization thereof is based on:

**Definition 4** (Filippov convexification, [14]). *Let  $f : \mathbb{R}^n \rightarrow \mathbb{R}^n$  be Lebesgue measurable and  $L_{loc}^\infty$ , and let  $x \in \mathbb{R}^n$ . The Filippov convexification of  $f$  at  $x$  is defined as the set-valued map*

$$F[f](x) := \bigcap_{\delta > 0} \bigcap_{\mu(S)=0} \overline{\text{co}}\{f(B(x, \delta)) \setminus S\}, \quad (5)$$

*where  $\mu$  is the Lebesgue measure on  $\mathbb{R}^n$ ,  $\overline{\text{co}}(A)$  is the closed convex hull of a generic set  $A$  and  $B(x, \delta)$  is the open ball centered at  $x$  with radius  $\delta$  (see [14] for further details).*

We refer to Figure 2 for an illustration of the Filippov convexification on a simple example of a 2D example, illustrating the evolution of active-power output of two DERs. Correspondingly:

**Definition 5** (Filippov invariant measure, [15]). *We say that the discrete-time inclusion system (1) preserves a measure  $\mu$  on  $\mathbb{R}^n$  if*

$$\mu(\mathcal{S}_F(A)(k)) = \mu(A), \quad k \in \mathbb{N},$$

*for any Borel subset  $A \subseteq \mathbb{R}^n$ , where*

$$\mathcal{S}_F(A)(k) := \bigcup_{x \in A} \mathcal{S}_F(x)(k),$$

*where  $\mathcal{S}_F(x)$  denotes the set of all maximal solutions to (1), for a given initial condition.*

Finally, in the study of properties of non-linear dynamical systems, let us consider:

**Definition 6** (Comparison functions). *A function  $\gamma : \mathbb{R}^+ \rightarrow \mathbb{R}^+$  is said to be of class  $\mathcal{K}$  if it is continuous, increasing and  $\gamma(0) = 0$ . It is of class  $\mathcal{K}_\infty$  if, in addition, it is proper, i.e., unbounded. A continuous function  $\beta : \mathbb{R}^+ \times \mathbb{R}^+ \rightarrow \mathbb{R}^+$  is said to be of class  $\mathcal{KL}$ , if for all fixed  $t$  the function  $\beta(\cdot, t)$  is of class  $\mathcal{K}$  and for all fixed  $s$ , the function  $\beta(s, \cdot)$  is non-increasing and tends to zero as  $t \rightarrow \infty$ .*

**Definition 7** (Incremental ISS, [16]). *Let  $\mathcal{U}$  denote the set of all input functions  $u : \mathbb{Z}_{\geq k_0} \rightarrow \mathbb{R}^d$ . Suppose,  $F : \mathbb{R}^d \times \mathbb{R}^n \rightarrow \mathbb{R}^n$  is continuous, then the discrete-time non-linear dynamical system*

$$x(k+1) = F(x(k), u(k)), \quad (6)$$

*is called (globally) incrementally input-to-state-stable (incrementally ISS), if there exist  $\beta \in \mathcal{KL}$  and  $\gamma \in \mathcal{K}$  such that for any pair of inputs  $u_1, u_2 \in \mathcal{U}$  and any pair of initial*

*condition  $\xi_1, \xi_2 \in \mathbb{R}^n$ :*

$$\begin{aligned} & \|x(k, \xi_1, u_1) - x(k, \xi_2, u_2)\| \\ & \leq \beta(\|\xi_1 - \xi_2\|, k) + \gamma(\|u_1 - u_2\|_\infty), \quad \forall k \in \mathbb{N}. \end{aligned}$$

In some sense, this paper links the definitions above, in showing when do incremental ISS systems have Filippov invariant measures.

### III. RELATED WORK

#### A. The Model

As in [8, 2], we consider the control of an ensemble of DERs using a control signal  $\pi(k) \in \Pi \subseteq \mathbb{R}$ , which is sent all  $N$  DERs. Each DER  $i$  has a state  $x_i \in \mathbb{R}^{n_i}$  and an associated output  $y_i \in \mathbb{D}_i$ , where the latter is a finite set. The non-deterministic response of agent  $i$  is within a finite set of actions:  $\mathbb{A}_i = \{a_1, \dots, a_{L_i}\} \subset \mathbb{R}^{n_i}$ . The finite set of possible resource demands of agent  $i$  is  $\mathbb{D}_i$ :

$$\mathbb{D}_i := \{d_{i,1}, d_{i,2}, \dots, d_{i,m_i}\}. \quad (7)$$

We assume there are  $w_i \in \mathbb{N}$  state transition maps  $\mathcal{W}_{ij} : \mathbb{R}^{n_i} \rightarrow \mathbb{R}^{n_i}$ ,  $j = 1, \dots, w_i$  for agent  $i$  and  $h_i \in \mathbb{N}$  output maps  $\mathcal{H}_{i\ell} : \mathbb{R}^{n_i} \rightarrow \mathbb{D}_i$ ,  $\ell = 1, \dots, h_i$  for each agent  $i$ . The evolution of the states and the corresponding demands then satisfy:

$$x_i(k+1) \in \{\mathcal{W}_{ij}(x_i(k)) \mid j = 1, \dots, w_i\}, \quad (8)$$

$$y_i(k) \in \{\mathcal{H}_{i\ell}(x_i(k)) \mid \ell = 1, \dots, h_i\}, \quad (9)$$

where the choice of agent  $i$ 's response at time  $k$  is governed by probability functions  $p_{ij} : \Pi \rightarrow [0, 1]$ ,  $j = 1, \dots, w_i$ , respectively  $p'_{i\ell} : \Pi \rightarrow [0, 1]$ ,  $\ell = 1, \dots, h_i$ . Specifically, for each agent  $i$ , we have for all  $k \in \mathbb{N}$  that

$$\mathbb{P}(x_i(k+1) = \mathcal{W}_{ij}(x_i(k))) = p_{ij}(\pi(k)), \quad (10a)$$

$$\mathbb{P}(y_i(k) = \mathcal{H}_{i\ell}(x_i(k))) = p'_{i\ell}(\pi(k)). \quad (10b)$$

Additionally, for all  $\pi \in \Pi$ ,  $i = 1, \dots, N$  it holds that

$$\sum_{j=1}^{w_i} p_{ij}(\pi) = \sum_{\ell=1}^{h_i} p'_{i\ell}(\pi) = 1. \quad (10c)$$

The final equality comes from the fact  $p_{ij}, p'_{i\ell}$  are probability functions. We assume that, conditioned on  $\{x_i(k)\}, \pi(k)$ , the random variables  $\{x_i(k+1) \mid i = 1, \dots, N\}$  are stochastically independent. The outputs  $y_i(k)$  each depend on  $x_i(k)$  and the signal  $\pi(k)$  only.

Let us now model the system of Figure 1 by a Markov chain on a state space representing all the system components. In general, one could consider:

$$\begin{cases} x_i(k+1) \in \{\mathcal{W}_{ij}(x_i(k)) \mid j = 1, \dots, w_i\}, \\ y_i(k) \in \{\mathcal{H}_{i\ell}(x_i(k)) \mid \ell = 1, \dots, h_i\}, \end{cases} \quad (11)$$

$$y(k) = \sum_{i=1}^N y_i(k), \quad (12)$$

$$\mathcal{F} : \begin{cases} x_f(k+1) = \mathcal{W}_f(x_f(k), y(k)), \\ \hat{y}(k) = \mathcal{H}_f(x_f(k), y(k)), \end{cases} \quad (13)$$

$$\mathcal{C} : \begin{cases} x_c(k+1) = \mathcal{W}_c(x_c(k), \hat{y}(k), r), \\ \pi(k) = \mathcal{H}_c(x_c(k), \hat{y}(k), r), \end{cases} \quad (14)$$

In addition, we have (e.g., Dini) continuous probability functions  $p_{ij}, p'_{il} : \Pi \rightarrow [0, 1]$  so that the probabilistic laws (10) are satisfied. If we denote by  $\mathbb{X}_i, i = 1, \dots, N, \mathbb{X}_C$  and  $\mathbb{X}_F$  the state spaces of the agents, the controller and the filter, then the system evolves on the overall state space  $\mathbb{X} := \prod_{i=1}^N \mathbb{X}_i \times \mathbb{X}_C \times \mathbb{X}_F$  according to the dynamics

$$x(k+1) := \begin{pmatrix} (x_i)_{i=1}^N \\ x_f \\ x_c \end{pmatrix} (k+1) \in \{F_m(x(k)) \mid m \in \mathbb{M}\}. \quad (15)$$

where each of the maps  $F_m$  is of the form

$$F_m(x(k)) := \begin{pmatrix} (\mathcal{W}_{ij}(x_i(k)))_{i=1}^N \\ \mathcal{W}_f(x_f(k), \sum_{i=1}^N \mathcal{H}_{il}(x_i(k))) \\ \mathcal{W}_c(x_c(k), \mathcal{H}_f(x_f(k), \sum_{i=1}^N \mathcal{H}_{il}(x_i(k)))) \end{pmatrix} \quad (16)$$

and the maps  $F_m$  are indexed by indices  $m$  from the set

$$\mathbb{M} := \prod_{i=1}^N \{(i, 1), \dots, (i, w_i)\} \times \prod_{i=1}^N \{(i, 1), \dots, (i, h_i)\}. \quad (17)$$

By the independence assumption on the choice of the transition maps and output maps for the agents, for each multi-index  $m = ((1, j_1), \dots, (N, j_N), (1, l_1), \dots, (N, l_N))$  in this set, the probability of choosing the corresponding map  $F_m$  is given by

$$\mathbb{P}(x(k+1) = F_m(x(k))) = \left( \prod_{i=1}^N p_{ij_i}(\pi(k)) \right) \left( \prod_{i=1}^N p'_{il_i}(\pi(k)) \right) =: q_m(\pi(k)). \quad (18)$$

We aim to achieve regulation, with probability 1

$$\sum_{i=1}^N y_i(k) = y(k) \leq r \quad (19)$$

to some reference  $r > 0$ , given by the installed capacity. Further, we aim for predictability, in the sense that for each agent  $i$  there exists a constant  $\bar{r}_i$  such that

$$\lim_{k \rightarrow \infty} \frac{1}{k+1} \sum_{j=0}^k y_i(j) = \bar{r}_i, \quad (20)$$

where the limit is independent of initial conditions. The requirement of fairness is then for the limit  $\bar{r}_i$  to coincide for all  $1 \leq i \leq N$ .

## B. Related Results

Fioravanti et al. [8] consider the behaviour of a simple controller, whose transfer function is not asymptotically stable, in the regulation of a generalization of load aggregation, but without the non-linear filters to model alternating-current transmission losses. (The transfer function is not asymptotically stable in both the PI controller and any controller with any sort of integral action.) Then the authors consider  $N$  agents with states  $x_i, i = 1, \dots, N$  and an upper bound  $m$

on the different values the agents can attain, *i.e.*, for each  $i$  we have  $x_i \in \mathbb{A}_i = \{a_1, \dots, a_{m_i}\} \subset \mathbb{R}$  for a given set  $\mathbb{A}_i$  and  $1 \leq m_i \leq m$ . The behaviour of the agents is governed by probability functions  $p_{il} : \mathbb{R} \rightarrow [0, 1]$  be continuous for all  $i = 1, \dots, N, l = 1, \dots, m_i$ , *i.e.*, if  $\pi(k)$  is the output of  $\mathcal{C}$  at time  $k$ , then  $\mathbb{P}(x_i(k+1) = a_l) = p_{il}(\pi(k))$ . In the feedback system of Figure 1, where  $\mathcal{F} : y \mapsto \hat{y}$  is a finite-memory moving-average (FIR) filter and the controller  $\mathcal{C}$  is marginally stable single-input single-output (SISO) system with a pole  $s_1 = e^{qj\pi}$  on the unit circle where  $q$  is a rational number, Fioravanti et al. [8] show the following:

- (i) The set  $\mathbb{O}_{\mathcal{F}}$  of possible output values of the filter  $\mathcal{F}$  is finite.
- (ii) If the real additive group  $\mathcal{E}$  generated by  $\{r - \hat{y} \mid \hat{y} \in \mathbb{O}_{\mathcal{F}}\}$  with  $r$  from (19) is discrete, then the closed-loop system cannot be uniquely ergodic.
- (iii) For rational  $\mathbb{A}_i \subset \mathbb{Q}$  for all  $i = 1, \dots, N$ ,  $r \in \mathbb{Q}$ , and rational coefficients of the FIR filter  $\mathcal{F}$ , the closed-loop system cannot be uniquely ergodic.

Hence, even though the closed loop performs its regulation function well, it destroys the ergodic properties of the closed loop.

In a recent pioneering study, Li et al. [6] considered the closed-loop system design while quantifying the available flexibility from the aggregator to the system operator, albeit without the non-linearity of the alternating-current model.

In a follow-up study, Marecek et al. [2] extended the results to the non-linearity of the alternating-current model and considered the ergodic properties of incremental input-to-state controllers and filters. In doing so, the authors utilize *iterated function systems* [17, 18, 19] following [8]. Their main result can be phrased as follows:

**Theorem 1** (Marecek et al., [2]). *Consider the feedback system depicted in Figure 1. Assume that each agent  $i \in \{1, \dots, N\}$  has a state governed by the non-linear iterated function system*

$$x_i(k+1) = \mathcal{W}_{ij}(x_i(k)) \quad (21a)$$

$$y_i(k) = \mathcal{H}_{ij}(x_i(k)), \quad (21b)$$

where:

- (i) *we have globally Lipschitz-continuous and continuously differentiable functions  $\mathcal{W}_{ij}$  and  $\mathcal{H}_{ij}$  with global Lipschitz constant  $l_{ij}$ , resp.  $l'_{ij}$*
- (ii) *we have Dini continuous probability functions  $p_{ij}, p'_{il}$  so that the probabilistic laws (10) are satisfied*
- (iii) *there are scalars  $\delta, \delta' > 0$  such that  $p_{ij}(\pi) \geq \delta > 0$ ,  $p'_{il}(\pi) \geq \delta' > 0$  for all  $\pi \in \Pi$  and all  $(i, j)$*
- (iv) *the composition  $F_m$  (16) of agents' transition maps and the probability functions satisfy the contraction-on-average condition. Specifically, consider the space  $\mathbb{X}_a := \prod_{i=1}^N \mathbb{X}_i$  of all agents and the maps  $F_{a,m} : \mathbb{X}_a \rightarrow \mathbb{X}_a$ ,  $(x_i)_{i=1}^N \mapsto (\mathcal{W}_{im}(x_i))_{i=1}^N$  together with the probabilities  $p_m : \Pi \rightarrow [0, 1]$ ,  $m \in \mathbb{M}$ , form an average contraction system in the sense that there exists a constant  $0 < \tilde{c} < 1$*

such that for all  $x, \hat{x} \in \mathbb{X}_a, x \neq \hat{x}, \pi \in \Pi$  we have

$$\sum_m p_m(\pi) \frac{\|F_{a,m}(x) - F_{a,m}(\hat{x})\|}{\|x - \hat{x}\|} < \bar{c}. \quad (22)$$

Then, for every incrementally input-to-state stable controller  $\mathcal{C}$  and every incrementally input-to-state stable filter  $\mathcal{F}$  compatible with the feedback structure, the feedback loop has a unique, attractive invariant measure. In particular, the system is uniquely ergodic.

#### IV. REASONING ABOUT PREDICTABILITY AND FAIRNESS WITH DEADBAND

It is natural to investigate how to generalize the assumptions of Theorem 1, cf. above or [2], to accommodate controllers with a deadband. In particular, it could be that output depends on the state through some piecewise smooth control function  $\phi$ ; for example, the control function  $\phi$  can represent a deadband, is to consider

$$y_i(k) = \mathcal{H}_{ij}(\phi(x_i(k))), \quad (23)$$

where

$$\phi(x) := \begin{cases} x, & |x| \geq \delta, \\ 0, & |x| < \delta, \end{cases} \quad (24)$$

for some  $\delta > 0$ .

This would imply that assumption (i) in Theorem 2 of [2] should be weakened in order to retain, in some extended sense, an attractive invariant measure and unique ergodicity for the resulting system; more specifically, we have to require  $\mathcal{W}_{ij}, \mathcal{H}_{ij}$  to be Lebesgue measurable and  $L_{loc}^\infty$  (see [20]). In doing so, we lose smoothness. A typical approach, then, is to replace the differential (or difference) equations of [2] with some appropriate differential (or difference) inclusions, for which it would be necessary to extend the concept of solution. Thus, this provides a system of the following form

$$\begin{aligned} x_i(k+1) &\in F[\mathcal{W}_{ij}](x_i(k)), \\ y_i(k) &\in F[\mathcal{H}_{ij}](x_i(k)), \end{aligned} \quad (25)$$

where  $F[\mathcal{W}_{ij}], F[\mathcal{H}_{ij}]$  are suitable set-valued maps, generalizing the transition and output maps.

A common approach is to consider the operator  $F[\cdot]$  in (25) to be the Filippov convexification of the original flow:

**Definition 8** (Filippov convexification, [14]). *Let  $f : \mathbb{R}^n \rightarrow \mathbb{R}^n$  be Lebesgue measurable and  $L_{loc}^\infty$ , and let  $x \in \mathbb{R}^n$ . The Filippov convexification of  $f$  at  $x$  is defined as the set-valued map*

$$F[f](x) := \bigcap_{\delta > 0} \bigcap_{\mu(S)=0} \overline{\text{co}}\{f(B(x, \delta)) \setminus S\}, \quad (26)$$

where  $\mu$  is the Lebesgue measure on  $\mathbb{R}^n$ ,  $\overline{\text{co}}(A)$  is the closed convex hull of a generic set  $A$  and  $B(x, \delta)$  is the open ball centered at  $x$  with radius  $\delta$  (see [14] for further details).

The set-valued map, which results from (26), is known to be upper semicontinuous with closed convex values, and Lipschitz continuous under specific assumptions (see [13]). See [21, 22] for a thorough exposition on the topic. The first of

these properties guarantees that (25) admits at least a Filippov solution:

**Definition 9** (Filippov solution, [14]). *A Filippov solution to (25) is a couple of sequences  $\{(x_i(k), y_i(k))\}_{k \in \mathbb{N}}$  such that (25) is satisfied with  $F[\cdot]$  standing for the Filippov convexification of the corresponding flow.*

Then, using the concepts of dissipativity for discontinuous dynamical systems with appropriate storage functions and supply rates (see [23]) one can then try to extend results in Theorem 2 of [2] to (25). This way, one could specialise the notion of a Filippov invariant measure [15] to say that the differential inclusion system (25) preserves a measure  $\mu$  on  $\mathbb{R}^n$  if

$$\mu(\mathcal{S}_F(A)(k)) = \mu(A), \quad k \in \mathbb{N}, \quad (27)$$

for any Borel subset  $A \subseteq \mathbb{R}^n$ , where

$$\mathcal{S}_F(A)(k) := \bigcup_{x \in A} \mathcal{S}_F(x)(k),$$

where  $\mathcal{S}_F(x)$  denotes the set of all maximal solutions to (25), for a given initial condition. Now, within the above setting, one could then prove existence and uniqueness of invariant measures for the resulting Filippov system. In turn, the existence of the unique invariant measure guarantees predictability.

**Remark 1.** *Other types of convexification could be considered in (25), such as Krasovskii convexification, which could be useful for time-varying non-convex optimization problems [24]. However, possibly less is known about invariant measures for the corresponding resulting system than for the Filippov convexification, making them less attractive in the present context.*

As a successive analysis, following [25, 26], optimality for time-invariant discontinuous control systems on the infinite interval utilizing a steady-state Hamilton-Jacobi-Bellman approach for characterizing optimal discontinuous nonlinear feedback controllers can also be considered, together with results gain, sector and disk margin, relative to some suitable performance criterion.

#### V. THE MAIN RESULT

The fundamental result of this section relies on Theorem 1. However, assumptions therein need to be adapted to the discontinuous setting of the present work.

**Theorem 2.** *Consider the feedback system depicted in Figure 1. Assume that each agent  $i \in \{1, \dots, N\}$  has a state governed by the non-linear iterated function system*

$$x_i(k+1) \in F[\mathcal{W}_{ij}](x_i(k)), \quad (28a)$$

$$y_i(k) \in F[\mathcal{H}_{ij}](x_i(k)), \quad (28b)$$

where, for some event  $C^2$ -functions  $h_W, h_H : \mathbb{R}^n \rightarrow \mathbb{R}$ , with 0 as a regular value, it is

$$\mathcal{W}_{ij}(x) = \begin{cases} \mathcal{W}_{ij}^-(x), & h_W(x) < 0, \\ \mathcal{W}_{ij}^+(x), & h_W(x) > 0, \end{cases}$$

and similarly

$$\mathcal{H}_{ij}(x) = \begin{cases} \mathcal{H}_{ij}^-(x), & h_H(x) < 0, \\ \mathcal{H}_{ij}^+(x), & h_H(x) > 0. \end{cases}$$

Further, let  $\{x \in \mathbb{R}^n : h_W(x) = 0\}$ ,  $\{x \in \mathbb{R}^n : h_H(x) = 0\}$  either coincide or be parallel manifolds.

Let us assume that  $\mathcal{W}_{ij}^\pm$ ,  $\mathcal{H}_{ij}^\pm$  and the compositions  $F_m^\pm$  (16) satisfy assumptions in Theorem 1.

Moreover, let us assume that for every invariant measures  $\nu^\pm$  of the feedback loop relative to  $\mathcal{W}_{ij}^\pm$ ,  $\mathcal{H}_{ij}^\pm$ , there exist a measure  $\mu$  and constant values  $\alpha^\pm$  such that  $\nu^\pm = \alpha^\pm \mu$  and

$$\alpha^+ \nabla h(x)^\top \mathcal{W}_{ij}^+ = \alpha^- \nabla h(x)^\top \mathcal{W}_{ij}^-.$$

Then, for every incrementally input-to-state stable controller  $\mathcal{C}$  and every incrementally input-to-state stable filter  $\mathcal{F}$  compatible with the feedback structure, the feedback loop has a unique Filippov invariant measure.

*Proof.* Since  $\mathcal{W}_{ij}^\pm$ ,  $\mathcal{H}_{ij}^\pm$  are locally essentially bounded, from classical results in [14] it follows that both  $F[\mathcal{W}_{ij}^\pm]$  and  $F[\mathcal{H}_{ij}^\pm]$  are upper semicontinuous and have nonempty, compact and convex values. Moreover, from Theorem 1, for every incrementally input-to-state stable controller  $\mathcal{C}$  and every incrementally input-to-state stable filter  $\mathcal{F}$  compatible with the feedback structure, the feedback loop has unique Filippov invariant measures  $\nu^\pm$ . Thus there exist a measure  $\mu$  and constant values  $\alpha^\pm$  such that  $\nu^\pm = \alpha^\pm \mu$ . Then, from [15, Theorem A], Filippov system (28) preserves the measure  $\nu := f\mu$ , where

$$f(x) := \begin{cases} \alpha^-, & h(x) < 0, \\ \alpha^+, & h(x) > 0. \end{cases}$$

If, by contradiction there exists  $\nu' \neq \nu$  Filippov invariant measure for (28), then there would exist, from [15, Theorem A], invariant measures  $\nu'^\pm$  for the feedback loop relative to  $\mathcal{W}_{ij}^\pm$ ,  $\mathcal{H}_{ij}^\pm$ . By uniqueness, these measures must coincide with  $\nu^\pm$ , so that  $\nu' = \nu$ , which is a contradiction. The claim is proved.  $\square$

**Remark 2.** Theorem 2 implies that the piecewise dynamical system associated to (28) is of co-dimension 1. This is needed in order to use results about invariant measures in Filippov system from [15]. At the best of our knowledge, nothing is known about co-dimension 2 Filippov systems, namely the case of general event smooth functions  $h_W, h_H$ . Further notions of ergodicity are an important question for further study, both across the power-systems applications and code non-smooth dynamical systems.

## VI. SIMULATING THE IMPACT OF DEADBAND

Our numerical results are based on simulations utilising Matpower [11], a standard open-source toolkit for power-systems analysis in version 7.1 running on Mathworks Matlab 2019b. We use Matpower's power-flow routine to implement a non-linear filter, which models the losses in the alternating-current model.

We consider two test cases:

- Standard IEEE 30-bus system with assembly of  $N = 50$  agents located at bus n. 2. We aim to regulate the system to the reference signal  $r$ , which is 60.97 MW plus losses at time  $k = 0$ .
- Second test case, closely related to [2], with number of agents  $N = 20$ . The system is regulated to  $r = N/2$ .

The response of each system  $\mathcal{S}_i$  to the control signal  $\pi(k)$  provided by the load aggregator at time  $k$  takes the form of probability functions, which suggest the probability a DERs is committed at time  $k$  as a function of the control signal  $\pi(k)$ . The probability functions are defined as

$$g_{i1}(x_i(k+1) = 1) = 0.02 + \frac{0.95}{1 + \exp(-\xi\pi(k) - x_{01})} \quad (29)$$

modelling the response of this first half of agents, whereas the second half of agents is modelled by probability function:

$$g_{i2}(x_i(k+1) = 1) = 0.98 - \frac{0.95}{1 + \exp(-\xi\pi(k) - x_{02})} \quad (30)$$

Initially, the first ( $N/2$ ) generators are off and the second half of the generators are on. The commitment of the DERs within the ensemble is provided to Matpower which, using a standard power-flow algorithm, computes the active power output  $P(k)$  of the individual DERs:

$$P(k) \in \mathbb{R}^N \quad (31)$$

taking into account losses in transmission. Thus computed active power output is aggregated into the total active power output  $p(k) = \sum P(k)$  of the ensemble. Then, a filter  $\mathcal{F}$  is applied:

$$\hat{p}(k) = \frac{p(k) + p(k-1)}{2} + \text{losses}(k). \quad (32)$$

Notice that here we both smooth the total active power output with a moving-average filter and accommodate the losses in the AC model. The error

$$e(k) = r - \hat{p}(k) \quad (33)$$

between the reference power output  $r$  and the filtered value  $\hat{p}(k)$  is then used as the input for the controller. Output of the controller  $\pi(k)$  is a function of error  $e(k)$  and an inner state of the controller  $x_c(k)$  and the deadband  $\delta$  (24). The control signal is given by the PI regulator or its lag approximant:

$$\pi_{\text{PI}}(k+1) = [K_p e(k) + K_i (x_c(k) + e(k))] \quad (34)$$

$$\pi_{\text{Lag}}(k+1) = [K_p e(k) + K_i (0.99x_c(k) + e(k))] \quad (35)$$

whenever the the error signal is outside of the deadband ( $|e(k)| \geq \delta$ ). If error is within the deadband ( $|e(k)| \leq \delta$ ), the control signal does not change:

$$\pi_{\text{PI}}(k+1) = \pi_{\text{PI}}(k) \quad (36)$$

$$\pi_{\text{Lag}}(k+1) = \pi_{\text{Lag}}(k) \quad (37)$$

The procedure is demonstrated in pseudocode in Algorithm 1.

For the second test case, we repeated the simulations 50 times, considering various time horizon ranging between 5000 and

---

**Simulation 1:** Pseudo-code capturing the closed loop.

---

```

P(0) = power-flow(u(0)) for a given initial commitment u(0)
for i ← 0 to ∞, i.e., each run of the simulation do
  for i ← 1 to kmax, where the length kmax of the time
    horizon is given do
      p(k) = ∑ P(k-1), cf. (31)
      p̂(k) = ℱ(p(k)), e.g. (32)
      e(k) = r - p̂(k), cf. (33)
      if e(k) ≥ δ then
        π(k) = ℒ(e(k)), cf. (36)
      else
        π(k) = π(k-1)
      end
    end
    u(k) = ℒ(π(k)), cf. (29) or (30)
    P(k) = power-flow(u(k)), cf. (31)
  end
end
end

```

---

80000 time steps. Various sizes of dead band were tested, with dead band being a percentage of reference value  $r$ . In Figure 3, the size of dead band is shown to affect mixing time of the system, i.e., the number of steps the system needs to reach a certain neighbourhood of the unique invariant measure. In our case, we check if all pairs of initial states  $x_{c_A}(k=0), x_{c_B}(k=0)$  of the controller, which we test, are within  $0.01\Delta$  with respect to the 2-Wasserstein distance:

$$W(x_{c_A}, x_{c_B}) = \int_0^1 |\hat{F}_A^{-1}(q) - \hat{F}_B^{-1}(q)|^2 dq \leq 0.01\Delta \quad (38)$$

where  $\Delta = W(x_{c_A}(k=1), x_{c_B}(k=1))$  and  $\hat{F}_A, \hat{F}_B$  are estimates of the distribution functions of  $x_{c_A}$  and  $x_{c_B}$ .

Still for the second test case, we repeated the simulation 50 times for varying time horizon from 8000 to 100000 time steps. The results in Figure 4 present the mean over the 50 runs with a solid line and the region of mean  $\pm$  standard deviation as a shaded area. Similarly, results for the MATPOWER test case with and without deadband are presented in Figure 5.

In both test cases, systems behave similarly to results in [2]. Both types of controller (PI and lag approximant) are able to provide regulation to the reference value  $r$ . Only lag approximant, however, provides ergodic regulation in accordance with section . Altered behavior of system with implemented discontinuities can be seen in Figure 3, where the mixing time increases with the size of deadband, due to the fact that responsiveness of the system is decreased by lack of response within the deadband interval.

## VII. CONCLUSIONS AND FURTHER WORK

We have studied the impact of the use of deadband on the notions of predictability of fairness in load aggregation and demand-response management, which relies on the existence of a unique (Filippov) invariant measure for a stochastic model of a closed-loop model of the system.

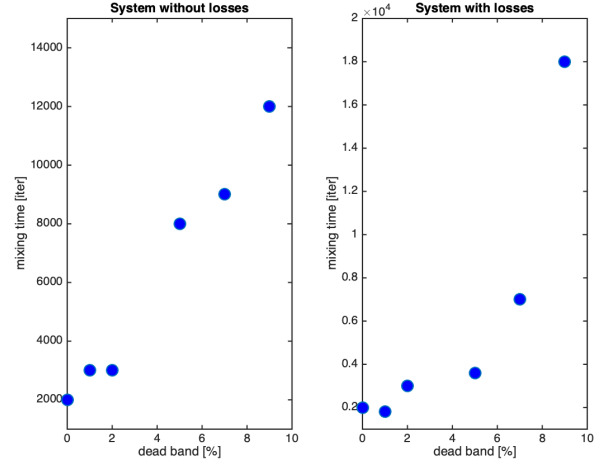

Fig. 3. Mixing time as function of deadband expressed in percentage of reference value  $r$ .

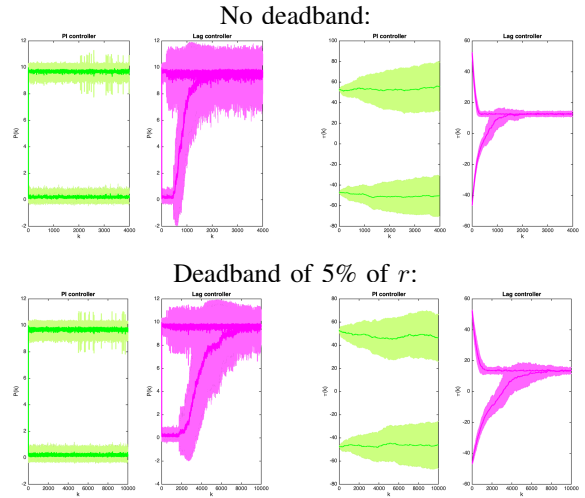

Fig. 4. Results of simulations on the second test case: The state of the controllers (right) and the state of agents (left) utilising probability function  $g_{i1}$  of (29) as functions of time, for the two controllers and two initial states of each of the two controllers.

## REFERENCES

- [1] P. D. Lund, J. Lindgren, J. Mikkola, and J. Salpakari, “Review of energy system flexibility measures to enable high levels of variable renewable electricity,” *Renewable and sustainable energy reviews*, vol. 45, pp. 785–807, 2015.
- [2] J. Marecek, M. Roubalik, R. Ghosh, R. N. Shorten, and F. R. Wirth, “Predictability and fairness in load aggregation and operations of virtual power plants,” *arXiv preprint arXiv:2110.03001*, 2021.
- [3] D. S. Callaway and I. A. Hiskens, “Achieving controllability of electric loads,” *Proceedings of the IEEE*, vol. 99, no. 1, pp. 184–199, Jan 2011.
- [4] P. Pinson, H. Madsen *et al.*, “Benefits and challenges of electrical demand response: A critical review,” *Renewable and Sustainable Energy Reviews*, vol. 39, pp. 686–699, 2014.

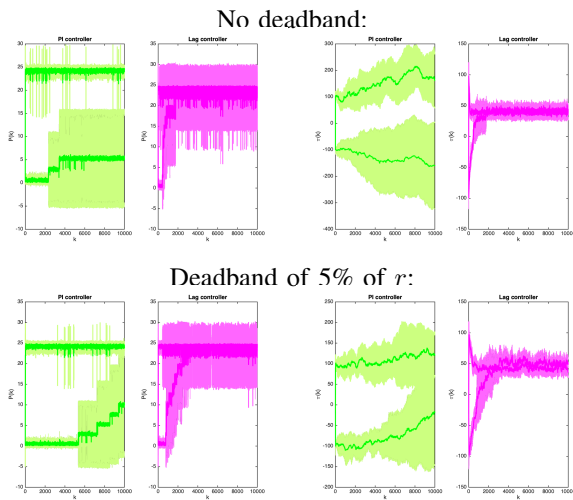

Fig. 5. Results of simulations on IEEE 30-bus test case: The state of the controllers (right) and the state of agents (left) utilising probability function  $g_{i1}$  of (29) as functions of time, for the two controllers and two initial states of each of the two controllers.

- [5] M. Roozbehani, M. A. Dahleh, and S. K. Mitter, “Volatility of power grids under real-time pricing,” *IEEE Transactions on Power Systems*, vol. 27, no. 4, pp. 1926–1940, Nov 2012.
- [6] T. Li, S. H. Low, and A. Wierman, “Real-time flexibility feedback for closed-loop aggregator and system operator coordination,” in *Proceedings of the Eleventh ACM International Conference on Future Energy Systems*, 2020, pp. 279–292.
- [7] K. H. J. Anuradha M. Annaswamy and G. J. Pappas, Eds., *Control for Societal-scale Challenges: Road Map 2030*, 2023, based on the 2022 IEEE CSS Workshop on Control for Societal-Scale Challenges. Sponsored by the IEEE Control Systems Society, International Federation of Automatic Control (IFAC), and National Science Foundation (NSF).
- [8] A. R. Fioravanti, J. Mareček, R. N. Shorten, M. Souza, and F. R. Wirth, “On the ergodic control of ensembles,” *Automatica*, vol. 108, p. 108483, 2019.
- [9] A. Kasis, N. Monshizadeh, and I. Lestas, “A distributed scheme for secondary frequency control with stability guarantees and optimal power allocation,” *Systems & Control Letters*, vol. 144, p. 104755, 2020. [Online]. Available: <https://www.sciencedirect.com/science/article/pii/S0167691120301377>
- [10] —, “Primary frequency regulation in power grids with on–off loads: Chattering, limit cycles and convergence to optimality,” *Automatica*, vol. 131, p. 109736, 2021. [Online]. Available: <https://www.sciencedirect.com/science/article/pii/S0005109821002569>
- [11] R. D. Zimmerman, C. E. Murillo-Sánchez, and R. J. Thomas, “Matpower: Steady-state operations, planning, and analysis tools for power systems research and education,” *IEEE Transactions on power systems*, vol. 26, no. 1, pp. 12–19, 2010.
- [12] B. M. Sanandaji, T. L. Vincent, and K. Poolla, “Ramping rate flexibility of residential hvac loads,” *IEEE Transactions on Sustainable Energy*, vol. 7, no. 2, pp. 865–874, 2016.
- [13] G. Smirnov, *Introduction to the Theory of Differential Inclusions*. Rhode Island: American Mathematical Society, 2002.
- [14] A. Filippov, *Differential Equations with Discontinuous Righthand Sides*. Dordrecht, The Netherlands: Kluwer Academic Publishers, 1988.
- [15] D. Novaes and R. Várao, “A note on invariant measures for Filippov systems,” *Bulletin des Sciences Mathématiques*, vol. 167, p. 102954, 2021.
- [16] D. Angeli, “A Lyapunov approach to incremental stability properties,” *IEEE Transactions on Automatic Control*, vol. 47, no. 3, pp. 410–421, 2002.
- [17] J. H. Elton, “An ergodic theorem for iterated maps,” *Ergodic Theory and Dynamical Systems*, vol. 7, no. 04, pp. 481–488, 1987.
- [18] M. Barnsley, S. Demko, J. Elton, and J. Geronimo, “Invariant measures for Markov processes arising from iterated function systems with place-dependent probabilities,” *Annales de l’institut Henri Poincaré (B) Probabilités et Statistiques*, vol. 24, no. 3, pp. 367–394, 1988.
- [19] M. F. Barnsley, J. H. Elton, and D. P. Hardin, “Recurrent iterated function systems,” *Constructive approximation*, vol. 5, no. 1, pp. 3–31, 1989.
- [20] W. Haddad, “Nonlinear differential equations with discontinuous right-hand sides: Filippov solutions, nonsmooth stability and dissipativity theory, and optimal discontinuous feedback control,” *Communications in Applied Analysis*, vol. 18, 01 2014.
- [21] J. Cortés, “Discontinuous dynamical systems - a tutorial on solutions, nonsmooth analysis, and stability,” *IEEE Control Systems Magazine*, pp. 36–73, 2008.
- [22] J. Cortés and F. Bullo, “Nonsmooth coordination and geometric optimization via distributed dynamical systems,” *SIAM Review*, vol. 51, no. 1, pp. 163–189, 2009.
- [23] T. Sadikhov and W. M. Haddad, “On the Equivalence Between Dissipativity and Optimality of Discontinuous Nonlinear Regulators for Filippov Dynamical Systems,” *IEEE Trans. Autom. Control.*, vol. 59, no. 2, pp. 423–436, 2014. [Online]. Available: <https://doi.org/10.1109/TAC.2013.2283111>
- [24] A. Hauswirth, I. Subotić, S. Bolognani, G. Hug, and F. Dörfler, “Time-varying projected dynamical systems with applications to feedback optimization of power systems,” *2018 IEEE Conference on Decision and Control (CDC)*, pp. 3258–3263, 2018.
- [25] W. M. Haddad and Q. Hui, “Dissipativity theory for discontinuous dynamical systems: Basic input, state, and output properties, and finite-time stability of feedback interconnections,” *Nonlinear Analysis: Hybrid Systems*, vol. 3, no. 4, pp. 551–564, 2009.
- [26] T. Sadikhov and W. M. Haddad, “A Universal Feedback Controller for Discontinuous Dynamical Systems Using Nonsmooth Control Lyapunov Functions,” *Journal of Dynamic Systems, Measurement, and Control*, vol. 137, no. 4, 04 2015.