

UNIVERSAL APPROXIMATION WITH COMPLEX-VALUED DEEP NARROW NEURAL NETWORKS

PAUL GEUCHEN, THOMAS JAHN, AND HANNES MATT

ABSTRACT. We study the universality of complex-valued neural networks with bounded widths and arbitrary depths. Under mild assumptions, we give a full description of those activation functions $\varrho : \mathbb{C} \rightarrow \mathbb{C}$ that have the property that their associated networks are universal, i.e., are capable of approximating continuous functions to arbitrary accuracy on compact domains. Precisely, we show that deep narrow complex-valued networks are universal if and only if their activation function is neither holomorphic, nor antiholomorphic, nor \mathbb{R} -affine. This is a much larger class of functions than in the dual setting of arbitrary width and fixed depth. Unlike in the real case, the sufficient width differs significantly depending on the considered activation function. We show that a width of $2n + 2m + 5$ is always sufficient and that in general a width of $\max\{2n, 2m\}$ is necessary. We prove, however, that a width of $n + m + 4$ suffices for a rich subclass of the admissible activation functions. Here, n and m denote the input and output dimensions of the considered networks.

1. INTRODUCTION

This paper addresses the universality of deep narrow complex-valued neural networks (CVNNs), i.e., the density of neural networks with arbitrarily large depths but bounded widths, in spaces of continuous functions over compact domains with respect to the uniform norm. Our main theorem is as follows.

Theorem 1.1. *Let $n, m \in \mathbb{N}$, and $\varrho : \mathbb{C} \rightarrow \mathbb{C}$ be a continuous function which at some point is real differentiable with non-vanishing derivative. Then $\mathcal{NN}_{n,m,2n+2m+5}^\varrho$ is universal if and only if ϱ is neither holomorphic, nor antiholomorphic, nor \mathbb{R} -affine.*

Here $\mathcal{NN}_{n,m,W}^\varrho$ denotes the set of complex-valued neural networks with input dimension n , output dimension m , activation function ϱ , and W neurons per hidden layer. These neural networks are alternating compositions

$$V_L \circ \varrho^{\times W} \circ \dots \circ \varrho^{\times W} \circ V_1 : \mathbb{C}^n \rightarrow \mathbb{C}^m \quad (1.1)$$

of affine maps $V_1 : \mathbb{C}^n \rightarrow \mathbb{C}^W$, $V_2, \dots, V_{L-1} : \mathbb{C}^W \rightarrow \mathbb{C}^W$, $V_L : \mathbb{C}^W \rightarrow \mathbb{C}^m$, and componentwise applications of the activation function ϱ , see Section 2 for a detailed definition.

Studying the expressivity of neural networks is an important part of the mathematical analysis of deep learning. We contribute a qualitative result in that direction. Such qualitative results naturally precede the investigation of approximation rates, i.e., the decay of approximation errors as the class of approximants increases, and the design of numerical algorithms that output near-to-optimal approximants.

1.1. Related work. In the neural network context, universal approximation theorems date back to the 1980s and 1990s [7, 24], where it was shown that real-valued shallow neural networks with output dimension 1 and a fixed continuous activation function are universal if and only if the activation function is not a polynomial. Modifications of the setting in which universal approximation is studied appear in the neural network literature over the past decades. These variants of the problem refer to, e.g., the input and the output dimension, the target space (typically L_p for $1 \leq p \leq \infty$, continuous

Date: May 30, 2023.

2020 Mathematics Subject Classification. 68T07,41A30,41A63,31A30,30E10.

Key words and phrases. complex-valued neural networks, holomorphic function, polyharmonic function, uniform approximation, universality.

All authors contributed equally to this work.

functions, also modulo the action of a group), the choice of activation functions (only ReLU vs. any continuous non-polynomial function), constraints on either the width or depth of the neural network (narrow vs. wide, shallow vs. deep networks), or constraints on the norm or the sparsity of the weights, see for instance [5, 13, 15, 17, 19, 22, 29] and the references therein. Furthermore, changes in the network architecture [23, 30], the incorporation of randomness [18], and changes in the nature of the inputs [4, 16] are also subjects of investigation in the literature on universal approximation.

Remarkably, the theory mostly covers real-valued neural networks. Yet applications of complex-valued neural networks in image and signal processing, see [12, Chapter 1] and [20, Section II], motivate the theoretical study of their approximative capabilities. To the best of our knowledge, the only qualitative and quantitative results in that direction are [21, 28], and [6, 10], respectively. The article [28] provides a characterization of activation functions, for which shallow CVNNs are universal. This characterization is crucial for the purposes of the paper at hand and is therefore given in Theorem 4.1 below. For both the shallow and the deep narrow (real-valued and complex-valued) neural networks with analytic activation functions, it is shown in [21] that the closures of these classes in $C(K)$ coincides with the closure of polynomials, where K is a compact subset of \mathbb{R}^n or \mathbb{C}^n . An application of the Stone–Weierstrass theorem or Mergelyan’s theorem then yields universality of neural networks in the set of continuous functions in the real-valued case or holomorphic functions in the complex-valued case. The authors of [6] prove quantitative bounds for the approximation of C^k -functions on \mathbb{C}^n using complex-valued neural networks with the modReLU activation function. Those results have recently been generalized in [10], where the same approximation bounds have been proven for the rich class of complex-valued activation functions that are smooth and non-polyharmonic on some non-empty open set. This class in particular includes the modReLU.

1.2. Contribution. In the real-valued case, under mild assumptions on their regularity, activation functions that yield universal neural networks have been characterized. In the complex-valued case, however, such a characterization is only known in the case of neural networks with fixed depths and arbitrary widths. To complete the picture, we give in Theorem 1.1 a characterization of activation functions for which CVNNs with bounded widths and arbitrary depths are universal.

Recall that polynomial activation functions are precisely the ones for which real-valued neural networks with arbitrary widths and fixed depth are not universal, see [15, Section 1]. Yet, in the dual situation, where depth is arbitrary and widths are bounded, polynomial activation functions (of minimum degree 2) do give rise to universal real-valued neural networks, see again [15, Theorem 3.2]. The situation is different in the complex-valued case. For continuous activation functions, Voigtlaender shows in [28, Theorem 1.3] that shallow CVNNs are universal if and only if the activation function is non-polyharmonic. CVNNs of arbitrary widths and fixed depth > 1 are universal if and only if the activation function does not coincide with a polynomial in z and \bar{z} , is not holomorphic, and not antiholomorphic, cf. [28, Theorem 1.4]. In the deep narrow regime studied in Theorem 1.1, the requirements on the activation function for universality are again weaker in the sense that not being a polynomial in z and \bar{z} is replaced by not being \mathbb{R} -affine.

In this work, we consider continuous complex-valued activation functions which have non-vanishing derivative (in the sense of real variables) at some point. Our analysis roughly splits into two parts: polyharmonic and non-polyharmonic activation functions. While this distinction mainly impacts the proof techniques, the bounds on the widths of the CVNNs are actually governed by the fine properties of the Wirtinger derivatives of the activation function at the point of differentiability. Figure 1 is a graphical guide through our results.

For non-polyharmonic activation functions, we show universality of CVNNs with input dimension n and output dimension m , where the number of neurons per hidden layer is $2n + 2m + 1$ or even $n + m + 1$, see Theorem 4.2. The proofs in that case are based on the fact that for non-polyharmonic activation functions shallow CVNNs are universal, as shown by Voigtlaender in [28, Theorem 1.3]. We combine this with an adaptation of the register model technique developed by Kidger and Lyons [15, Theorem 3.2]. There, they used this technique in the real-valued case to deduce universality of deep narrow *real-valued* neural networks from the classical result on universality of shallow real-valued neural networks [7, 24]. For polyharmonic activation functions, we show that CVNNs with input dimension

n , output dimension m , and $2n + 2m + 5$ or even $n + m + 4$ neurons per hidden layer are universal, see Theorem 5.3. This is done by approximating polynomials in z and \bar{z} uniformly on compact sets and invoking the Stone–Weierstrass theorem.

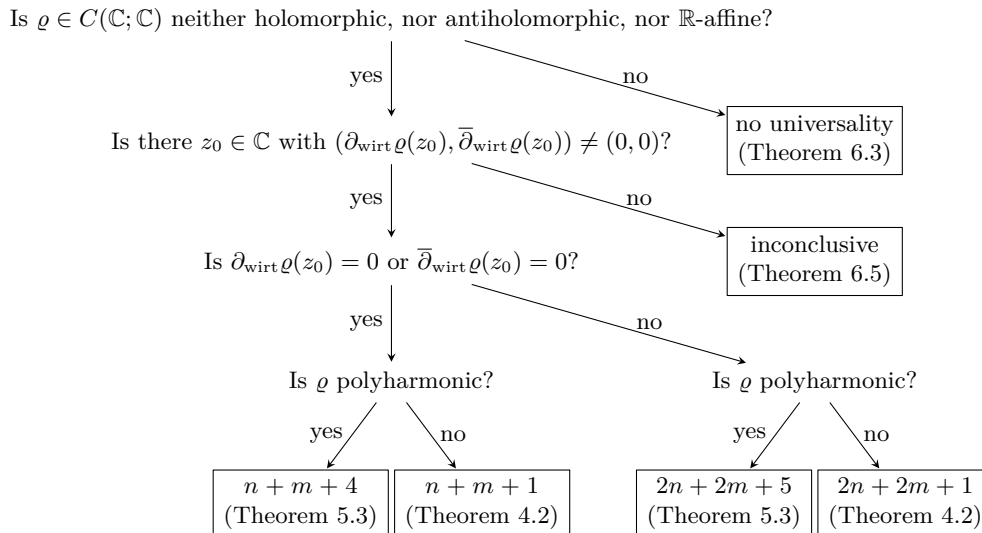

FIGURE 1. Our results in a nutshell.

1.3. Organization of our paper. In Section 2 we fix our notation and recall some basics from complex analysis, the theory of neural networks, and functional analysis. Section 3 introduces the register model and shows how the identity map on \mathbb{C} and complex conjugation can be approximated using CVNNs. For non-polyharmonic functions, the proof of Theorem 1.1 can be found in Section 4. In Section 5, we present the proof of universality claimed in Theorem 1.1 in the case of polyharmonic activation functions which are neither holomorphic, nor antiholomorphic, nor \mathbb{R} -affine. In Section 6, we show that CVNNs whose activation function is holomorphic or antiholomorphic or \mathbb{R} -affine are never universal, regardless of the number of neurons per hidden layer, and derive a lower bound on the minimum width necessary for universality. In the appendix, we provide basics on the relationship between local uniform convergence and universal approximation, and on Taylor approximations in terms of Wirtinger derivatives.

2. PRELIMINARIES

In this section, we recall facts from complex analysis, functional analysis, and the theory of neural networks behind the phrases in Theorem 1.1. The presentation is loosely based on [25, Chapter 7], [26, Chapter 11], and [11, Section 1].

2.1. Complex analysis. We use the symbols \mathbb{N} , \mathbb{R} , and \mathbb{C} to denote the natural, real, and complex numbers, respectively. By $\text{Re}(z)$, $\text{Im}(z)$, and \bar{z} , we denote the componentwise real part, imaginary part, and complex conjugate of a vector $z \in \mathbb{C}^n$, respectively. We call the function $\varrho : \mathbb{C} \rightarrow \mathbb{C}$ *partially differentiable* at z_0 , if the *partial derivatives*

$$\frac{\partial \varrho}{\partial x}(z_0) := \lim_{\mathbb{R} \setminus \{0\} \ni h \rightarrow 0} \frac{\varrho(z_0 + h) - \varrho(z_0)}{h}$$

and

$$\frac{\partial \varrho}{\partial y}(z_0) := \lim_{\mathbb{R} \setminus \{0\} \ni h \rightarrow 0} \frac{\varrho(z_0 + ih) - \varrho(z_0)}{h}$$

exist. Higher-order partial derivatives are defined in the standard manner. We write $\varrho \in C^k(\mathbb{C}; \mathbb{C})$ if ϱ admits partial derivatives up to order k at each point of \mathbb{C} and the k th-order partial derivatives are

continuous functions $\mathbb{C} \rightarrow \mathbb{C}$. Likewise, we write $\varrho \in C^\infty(\mathbb{C}; \mathbb{C})$ if $\varrho \in C^k(\mathbb{C}; \mathbb{C})$ for all $k \in \mathbb{N}$. If $\frac{\partial \varrho}{\partial x}(z_0)$ and $\frac{\partial \varrho}{\partial y}(z_0)$ exist and the identity

$$\lim_{\mathbb{C} \setminus \{0\} \ni h \rightarrow 0} \frac{\varrho(z_0 + h) - \varrho(z_0) - \frac{\partial \varrho}{\partial x}(z_0) \operatorname{Re}(h) - \frac{\partial \varrho}{\partial y}(z_0) \operatorname{Im}(h)}{h} = 0 \quad (2.1)$$

holds true, then ϱ is called *real differentiable in z_0* with derivative $(\frac{\partial \varrho}{\partial x}(z_0), \frac{\partial \varrho}{\partial y}(z_0))$. Similarly, ϱ is called *complex differentiable in z_0* if

$$\lim_{\mathbb{C} \setminus \{0\} \ni h \rightarrow 0} \frac{\varrho(z_0 + h) - \varrho(z_0) - ch}{h} = 0$$

for some number $c \in \mathbb{C}$, which in that case is given by

$$\partial_{\text{wirt}} \varrho(z_0) := \frac{1}{2} \left(\frac{\partial \varrho}{\partial x}(z_0) - i \frac{\partial \varrho}{\partial y}(z_0) \right).$$

Complex differentiability of ϱ in z_0 can be equivalently stated as

$$\bar{\partial}_{\text{wirt}} \varrho(z_0) := \frac{1}{2} \left(\frac{\partial \varrho}{\partial x}(z_0) + i \frac{\partial \varrho}{\partial y}(z_0) \right) = 0.$$

The differential operators ∂_{wirt} and $\bar{\partial}_{\text{wirt}}$ are called *Wirtinger derivatives*. If $\bar{\partial}_{\text{wirt}} \varrho(z) = 0$ for all $z \in \mathbb{C}$, then ϱ is a *holomorphic* function. The function ϱ is called *antiholomorphic* if the function $\bar{\varrho} : \mathbb{C} \rightarrow \mathbb{C}$, $\bar{\varrho}(z) := \operatorname{Re}(\varrho(z)) - i \operatorname{Im}(\varrho(z))$ is holomorphic or, equivalently, $\partial_{\text{wirt}} \varrho(z) = 0$ for all $z \in \mathbb{C}$. As the linear operator that maps the partial derivatives onto the Wirtinger derivatives is invertible, it follows that $(\frac{\partial \varrho}{\partial x}(z_0), \frac{\partial \varrho}{\partial y}(z_0)) = (0, 0)$ if and only if $(\partial_{\text{wirt}} \varrho(z_0), \bar{\partial}_{\text{wirt}} \varrho(z_0)) = (0, 0)$. Furthermore, the symmetry of mixed partial derivatives implies for $\varrho \in C^2(\mathbb{C}; \mathbb{C})$ that

$$4\partial_{\text{wirt}} \bar{\partial}_{\text{wirt}} \varrho = 4\bar{\partial}_{\text{wirt}} \partial_{\text{wirt}} \varrho = \left(\frac{\partial^2}{\partial x^2} + \frac{\partial^2}{\partial y^2} \right) \varrho =: \Delta \varrho. \quad (2.2)$$

If $\varrho \in C^\infty(\mathbb{C}; \mathbb{C})$ and $\Delta^m \varrho = 0$ for some $m \in \mathbb{N}$, then ϱ is called *polyharmonic of order m* . Because of (2.2), holomorphic and antiholomorphic functions are *harmonic*, i.e., polyharmonic of order 1.

The following lemma generalizes the classical real-valued Taylor expansion to the complex-valued setting; see Lemma B.1 for a proof.

Lemma 2.1. *Let $\varrho \in C(\mathbb{C}; \mathbb{C})$ and $z, z_0 \in \mathbb{C}$. If ϱ is real differentiable in z_0 , then*

$$\varrho(z + z_0) = \varrho(z_0) + \partial_{\text{wirt}} \varrho(z_0) z + \bar{\partial}_{\text{wirt}} \varrho(z_0) \bar{z} + \Theta_1(z) \quad (2.3)$$

for a function $\Theta_1 : \mathbb{C} \rightarrow \mathbb{C}$ with $\lim_{\mathbb{C} \setminus \{0\} \ni z \rightarrow 0} \frac{\Theta_1(z)}{z} = 0$. If $\varrho \in C^2(\mathbb{C}; \mathbb{C})$, then

$$\varrho(z + z_0) = \varrho(z_0) + \partial_{\text{wirt}} \varrho(z_0) z + \bar{\partial}_{\text{wirt}} \varrho(z_0) \bar{z} + \frac{1}{2} \partial_{\text{wirt}}^2 \varrho(z_0) z^2 + \partial_{\text{wirt}} \bar{\partial}_{\text{wirt}} \varrho(z_0) z \bar{z} + \frac{1}{2} \bar{\partial}_{\text{wirt}}^2 \varrho(z_0) \bar{z}^2 + \Theta_2(z) \quad (2.4)$$

for a function $\Theta_2 : \mathbb{C} \rightarrow \mathbb{C}$ with $\lim_{\mathbb{C} \setminus \{0\} \ni z \rightarrow 0} \frac{\Theta_2(z)}{z^2} = 0$.

2.2. Neural networks. A (fully connected feed-forward) *complex-valued neural network* (CVNN) is a function

$$V_L \circ \varrho^{\times N_{L-1}} \dots \circ \varrho^{\times N_1} \circ V_1 : \mathbb{C}^{N_0} \rightarrow \mathbb{C}^{N_L}$$

where

- $L \in \mathbb{N}_{\geq 2}$ is called the *depth* of the CVNN,
- $N_j \in \mathbb{N}$ is the *width* of the j th layer,
- $\max\{N_0, \dots, N_L\}$ is the *width* of the CVNN,
- $V_j : \mathbb{C}^{N_{j-1}} \rightarrow \mathbb{C}^{N_j}$ is a \mathbb{C} -affine map, abbreviated as $V_j \in \operatorname{Aff}(\mathbb{C}^{N_{j-1}}; \mathbb{C}^{N_j})$, i.e., there exist $A_j \in \mathbb{C}^{N_j \times N_{j-1}}$ and $b_j \in \mathbb{C}^{N_j}$ such that $V_j(z) = A_j z + b_j$ for all $z \in \mathbb{C}^{N_{j-1}}$,
- $\varrho^{\times N_j}(z_1, \dots, z_{N_j}) = (\varrho(z_1), \dots, \varrho(z_{N_j}))$ is the componentwise application of a (potentially non-affine) map $\varrho : \mathbb{C} \rightarrow \mathbb{C}$ called the *activation function*.

We refer to the numbers N_0 and N_L as the *input dimension* and *output dimension*, respectively. The layers $1, \dots, L-1$ are the *hidden layers* of the CVNN. Since it is always possible to pad matrices and vectors by additional zero rows and columns, we may and will assume without loss of generality that $N_1 = N_2 = \dots = N_{L-1}$.

We introduce a short-hand notation for the CVNNs that arise this way.

Definition 2.2. Let $n, m, W \in \mathbb{N}$ and $\varrho : \mathbb{C} \rightarrow \mathbb{C}$. We denote by $\mathcal{NN}_{n,m,W}^\varrho$ the set of CVNNs with arbitrary depth L , input dimension n , output dimension m , and $N_j = W$ for $j \in \{1, \dots, L-1\}$.

The elements of $\mathcal{NN}_{n,m,W}^\varrho$ are thus alternating compositions

$$V_L \circ \varrho^{\times W} \circ \dots \circ \varrho^{\times W} \circ V_1 : \mathbb{C}^n \rightarrow \mathbb{C}^m \quad (2.5)$$

of \mathbb{C} -affine maps V_j and the componentwise applications of the activation function ϱ . In the subsequent sections Sections 4 and 5, we have $W \geq \max\{n, m\}$, such that W turns out to be the width of the neural networks under consideration.

A typical way of thinking about neural networks is viewing the component functions of $\varrho^{\times N_j} \circ V_j$ as building blocks called *neurons*. Each neuron performs a computation of the form

$$z \mapsto \varrho(w^\top z + b)$$

where z is the output of the previous layer, w a vector of *weights*, and b a number called *bias*.

Since the composition of affine maps is affine, it is also possible to think about neural networks as maps

$$(\Psi_L \circ \varrho^{\times W} \circ \Phi_L) \circ (\Psi_{L-1} \circ \varrho^{\times W} \circ \Phi_{L-1}) \cdots \circ (\Psi_1 \circ \varrho^{\times W} \circ \Phi_1),$$

where each of the maps Φ_k, Ψ_k is affine. This allows to perceive shallow networks, see Definition 2.3, as building blocks for neural networks. This point of view is similar to the notion of *enhanced neurons* in [15].

For a fixed activation function ϱ , different choices of the \mathbb{C} -affine functions V_j may lead to the same composite function (2.5). In view of this, both depth and width of a CVNN are not properties of the function (2.5) but of the tuple (V_1, \dots, V_L) . For this reason, a different terminology is sometimes used in the literature where (V_1, \dots, V_L) is called the *neural network* and (2.5) is its *realization*, cf. [11, Section 1].

Apart from the choice of the activation function ϱ , restrictions on the depth or the width are common ingredients in the analysis of (fully connected feed-forward) neural networks. A CVNN is called *shallow* if its depth equals 2, and *deep* otherwise.

Definition 2.3. Let $n, m \in \mathbb{N}$ and $\varrho : \mathbb{C} \rightarrow \mathbb{C}$. We denote by $\mathcal{SN}_{n,m}^\varrho$ the set of *shallow CVNNs*, i.e., CVNNs with depth $L = 2$, input dimension n , and output dimension m .

In contrast to shallowness, *narrowness* is not an individual property of CVNNs but a class property. A set \mathcal{F} of CVNNs is said to be *narrow* if it does not contain CVNNs of arbitrarily large widths, i.e., if $\mathcal{F} \subseteq \mathcal{NN}_{n,m,W}^\varrho$ for suitable $n, m, W \in \mathbb{N}$ and $\varrho : \mathbb{C} \rightarrow \mathbb{C}$.

2.3. Functional analysis. On \mathbb{C}^m , consider the topology induced by the Euclidean norm

$$\|(z_1, \dots, z_m)\|_{\mathbb{C}^m} = \left(\sum_{j=1}^m |z_j|^2 \right)^{\frac{1}{2}}.$$

We denote by

$$B_\delta(z_0) := \{z \in \mathbb{C}^m : \|z - z_0\|_{\mathbb{C}^m} < \delta\}$$

and

$$\bar{B}_\delta(z_0) := \{z \in \mathbb{C}^m : \|z - z_0\|_{\mathbb{C}^m} \leq \delta\}$$

the open and the closed ball with center $z_0 \in \mathbb{C}^m$ and radius $\delta > 0$, respectively. For $K \subseteq \mathbb{C}^n$, we denote the vector space of continuous functions $K \rightarrow \mathbb{C}^m$ by $C(K; \mathbb{C}^m)$. When $K \subseteq \mathbb{C}^n$ is compact, the expression

$$\|f\|_{C(K; \mathbb{C}^m)} := \sup_{z \in K} \|f(z)\|_{\mathbb{C}^m}$$

defines a norm on $C(K; \mathbb{C}^m)$, called the *uniform norm*, which renders $C(K; \mathbb{C}^m)$ a Banach space. The convergence of a sequence $(f_j)_{j \in \mathbb{N}}$ of elements $f_j \in C(K; \mathbb{C}^m)$ to a limit $f \in C(K; \mathbb{C}^m)$ is written as $f_j \rightarrow f$ as $j \rightarrow \infty$, *uniformly on K* . Similarly, a sequence $(f_j)_{j \in \mathbb{N}}$ of functions $f_j \in C(\mathbb{C}^n; \mathbb{C}^m)$ is said to converge *locally uniformly* to a function $f \in C(\mathbb{C}^n; \mathbb{C}^m)$ if it converges uniformly to f on every compact subset $K \subseteq \mathbb{C}^n$. Since compositions of continuous functions are continuous, we have $\mathcal{NN}_{n,m,W}^\varrho \subseteq C(\mathbb{C}^n; \mathbb{C}^m)$ when $\varrho \in C(\mathbb{C}; \mathbb{C})$. The main objective of the paper at hand is to show that under certain additional assumptions on ϱ and W , the elements of $\mathcal{NN}_{n,m,W}^\varrho$ are arbitrarily close to the elements of $C(\mathbb{C}^n; \mathbb{C}^m)$ in the following sense.

Definition 2.4. We say that a function class $\mathcal{F} \subseteq C(\mathbb{C}^n; \mathbb{C}^m)$ has the *universal approximation property* or is *universal* if for every function $g \in C(\mathbb{C}^n; \mathbb{C}^m)$, every compact subset $K \subseteq \mathbb{C}^n$ and every $\varepsilon > 0$ there is a function $f \in \mathcal{F}$ such that

$$\sup_{z \in K} \|f(z) - g(z)\|_{\mathbb{C}^m} < \varepsilon.$$

The universal approximation property is equivalent to saying that for every function $g \in C(\mathbb{C}^n; \mathbb{C}^m)$ there is a sequence $(f_j)_{j \in \mathbb{N}}$ with $f_j \in \mathcal{F}$ for every $j \in \mathbb{N}$ that converges locally uniformly to g . We elaborate this equivalence in Appendix A.

3. BUILDING BLOCKS AND REGISTER MODEL

In this section we introduce various *building blocks* for complex-valued networks, i.e., small neural network blocks that are able to represent elementary functions (e.g., the complex identity $\text{id}_{\mathbb{C}}$ or complex conjugation $\overline{\text{id}_{\mathbb{C}}}$) up to an arbitrarily small approximation error. These building blocks are used in Sections 4 and 5 to construct the deep narrow networks that we use to approximate a given continuous function. Throughout the chapter, we assume that the used activation function $\varrho : \mathbb{C} \rightarrow \mathbb{C}$ is differentiable (in the real sense) at one point with non-vanishing derivative at that point. In fact, the strategy for constructing these building blocks is always going to be similar: By using the first- and second-order Taylor expansion of the activation function ϱ as introduced in Lemma 2.1 one can localize the activation function around its point of differentiability where it behaves like a complex polynomial in z and \bar{z} of degree 1 and 2, respectively. This enables us to extract elementary functions from that Taylor expansion.

Proposition 3.1 is fundamental for the universality results introduced in Sections 4 and 5. It shows that it is possible to uniformly approximate the complex identity or complex conjugation on compact sets using neural networks with a single hidden layer and width at most 2. If the activation function (or its complex conjugate) is not just real but even complex differentiable, the width can be reduced to 1. See Figure 2 for an illustration of the building blocks.

Proposition 3.1. *Let $\varrho \in C(\mathbb{C}; \mathbb{C})$ be real differentiable in $z_0 \in \mathbb{C}$ with $(\partial_{\text{wirt}}\varrho(z_0), \bar{\partial}_{\text{wirt}}\varrho(z_0)) \neq (0, 0)$. Furthermore, let $K \subseteq \mathbb{C}$ be compact and $\varepsilon > 0$.*

(i) *If $\partial_{\text{wirt}}\varrho(z_0) \neq 0$ and $\bar{\partial}_{\text{wirt}}\varrho(z_0) = 0$ there are $\phi, \psi \in \text{Aff}(\mathbb{C}; \mathbb{C})$ such that*

$$\sup_{z \in K} |(\psi \circ \varrho \circ \phi)(z) - z| < \varepsilon.$$

(ii) *If $\partial_{\text{wirt}}\varrho(z_0) = 0$ and $\bar{\partial}_{\text{wirt}}\varrho(z_0) \neq 0$ there are $\phi, \psi \in \text{Aff}(\mathbb{C}; \mathbb{C})$ such that*

$$\sup_{z \in K} |(\psi \circ \varrho \circ \phi)(z) - \bar{z}| < \varepsilon.$$

(iii) *If $\partial_{\text{wirt}}\varrho(z_0) \neq 0 \neq \bar{\partial}_{\text{wirt}}\varrho(z_0)$ there are $\phi \in \text{Aff}(\mathbb{C}; \mathbb{C}^2)$ and $\psi \in \text{Aff}(\mathbb{C}^2; \mathbb{C}^2)$ such that*

$$\sup_{z \in K} \|(\psi \circ \varrho^{\times 2} \circ \phi)(z) - (z, \bar{z})\|_{\mathbb{C}^2} < \varepsilon$$

Proof. The key idea of the proof is to use the affine maps to localize the activation function around its point of differentiability, where it behaves like its derivative, i.e., like a linear map in z and \bar{z} , and then to invoke Lemma 2.1. Recall that Lemma 2.1 yields the existence of a function $\Theta : \mathbb{C} \rightarrow \mathbb{C}$ satisfying $\lim_{z \rightarrow 0} \frac{\Theta(z)}{z} = 0$ and

$$\varrho(z + z_0) = \varrho(z_0) + \partial_{\text{wirt}}\varrho(z_0)z + \bar{\partial}_{\text{wirt}}\varrho(z_0)\bar{z} + \Theta(z)$$

for every $z \in \mathbb{C}$.

If $\bar{\partial}_{\text{wirt}}\varrho(z_0) = 0$ and $\partial_{\text{wirt}}\varrho(z_0) \neq 0$ we see for every $h > 0$ that

$$\frac{\varrho(z_0 + hz) - \varrho(z_0)}{\partial_{\text{wirt}}\varrho(z_0)h} = z + \frac{\Theta(hz)}{\partial_{\text{wirt}}\varrho(z_0)h} \quad \text{for all } z \in K. \quad (3.1)$$

Similarly, if $\bar{\partial}_{\text{wirt}}\varrho(z_0) \neq 0$ and $\partial_{\text{wirt}}\varrho(z_0) = 0$ we get

$$\frac{\varrho(z_0 + hz) - \varrho(z_0)}{\bar{\partial}_{\text{wirt}}\varrho(z_0)h} = \bar{z} + \frac{\Theta(hz)}{\bar{\partial}_{\text{wirt}}\varrho(z_0)h} \quad \text{for all } z \in K. \quad (3.2)$$

If $\partial_{\text{wirt}}\varrho(z_0) \neq 0 \neq \bar{\partial}_{\text{wirt}}\varrho(z_0)$ consider

$$\frac{i\varrho(z_0 + hz) + \varrho(z_0 + ihz) - (1+i)\varrho(z_0)}{2ih\partial_{\text{wirt}}\varrho(z_0)} = z + \frac{i\Theta(hz) + \Theta(ihz)}{2ih\partial_{\text{wirt}}\varrho(z_0)} \quad (3.3)$$

as well as

$$\frac{-i\varrho(z_0 + hz) + \varrho(z_0 + ihz) - (1-i)\varrho(z_0)}{-2ih\bar{\partial}_{\text{wirt}}\varrho(z_0)} = \bar{z} + \frac{-i\Theta(hz) + \Theta(ihz)}{-2ih\bar{\partial}_{\text{wirt}}\varrho(z_0)}. \quad (3.4)$$

Since K is compact there exists $L > 0$ satisfying $|z| \leq L$ for all $z \in K$. Let $\varepsilon' > 0$ be arbitrary and take $\delta > 0$ such that

$$\left| \frac{\Theta(w)}{w} \right| < \frac{\varepsilon'}{L}$$

for every $w \in \mathbb{C} \setminus \{0\}$ with $|w| < \delta$. Let $h \in (0, \delta/L)$ and $z \in K$. Since $|hz| < \delta$ we see for every $z \in K \setminus \{0\}$ that

$$\left| \frac{\Theta(hz)}{h} \right| \leq L \cdot \left| \frac{\Theta(hz)}{hz} \right| < \varepsilon'$$

and since ε' has been taken arbitrarily

$$\limsup_{h \downarrow 0} \sup_{z \in K} \frac{\Theta(hz)}{h} = 0.$$

Here, we used $\Theta(0) = 0$. Thus, Equations (3.1) to (3.4) yield the claim by taking h sufficiently small. \square

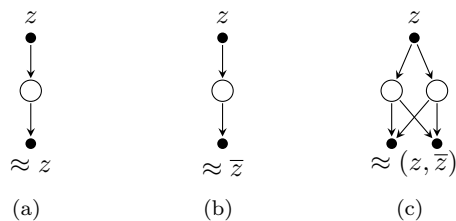

FIGURE 2. Illustration of the neural network building blocks from Proposition 3.1. Neurons in the input and output layers are depicted in filled dots at the top and bottom, respectively. Applications of the activation function ϱ are shown as circles.

Proposition 3.2 is important for the case of polyharmonic activation functions which is considered in Section 5. It essentially states that, given an activation function which is not \mathbb{R} -affine, one can approximate one of the functions $z \mapsto z\bar{z}$, $z \mapsto z^2$ or $z \mapsto \bar{z}^2$ by using a shallow neural network of width 4, see Figure 3 for an illustration.

Proposition 3.2. *Let $\varrho \in C^2(\mathbb{C}; \mathbb{C})$ be not \mathbb{R} -affine, let $K \subseteq \mathbb{C}$ compact and $\varepsilon > 0$. Then there exist $\phi \in \text{Aff}(\mathbb{C}; \mathbb{C}^4)$, $\psi \in \text{Aff}(\mathbb{C}^4; \mathbb{C})$ such that at least one of the three inequalities*

$$\begin{aligned} \sup_{z \in K} |(\psi \circ \varrho^{\times 4} \circ \phi)(z) - z\bar{z}| &< \varepsilon, \\ \sup_{z \in K} |(\psi \circ \varrho^{\times 4} \circ \phi)(z) - z^2| &< \varepsilon, \\ \sup_{z \in K} |(\psi \circ \varrho^{\times 4} \circ \phi)(z) - \bar{z}^2| &< \varepsilon \end{aligned}$$

holds true.

Proof. Since ϱ is not \mathbb{R} -affine, there exists $z_0 \in \mathbb{C}$ such that $\partial_{\text{wirt}}^2 \varrho(z_0) \neq 0$, $\partial_{\text{wirt}} \bar{\partial}_{\text{wirt}} \varrho(z_0) \neq 0$, or $\bar{\partial}_{\text{wirt}}^2 \varrho(z_0) \neq 0$, see, e.g., Proposition B.2. Using the second-order Taylor expansion stated in Lemma 2.1, there is a function $\Theta : \mathbb{C} \rightarrow \mathbb{C}$ satisfying $\lim_{z \rightarrow 0} \frac{\Theta(z)}{z^2} = 0$ and

$$\varrho(z + z_0) = \varrho(z_0) + \partial_{\text{wirt}} \varrho(z_0)z + \bar{\partial}_{\text{wirt}} \varrho(z_0)\bar{z} + \frac{1}{2} \partial_{\text{wirt}}^2 \varrho(z_0)z^2 + \partial_{\text{wirt}} \bar{\partial}_{\text{wirt}} \varrho(z_0)z\bar{z} + \frac{1}{2} \bar{\partial}_{\text{wirt}}^2 \varrho(z_0)\bar{z}^2 + \Theta(z)$$

for every $z \in \mathbb{C}$. Applying this identity to $z = w$ and $z = -w$ and adding up, we infer for any $w \in \mathbb{C}$ that

$$\varrho(z_0 + w) + \varrho(z_0 - w) = 2\varrho(z_0) + \partial_{\text{wirt}}^2 \varrho(z_0)w^2 + 2\partial_{\text{wirt}} \bar{\partial}_{\text{wirt}} \varrho(z_0)w\bar{w} + \bar{\partial}_{\text{wirt}}^2 \varrho(z_0)\bar{w}^2 + \Theta(w) + \Theta(-w).$$

Let $h > 0$ and $z \in K$. If $\partial_{\text{wirt}} \bar{\partial}_{\text{wirt}} \varrho(z_0) \neq 0$, we see with $w = hz$ and $w = ihz$ that

$$\begin{aligned} &\frac{\varrho(z_0 + hz) + \varrho(z_0 - hz) + \varrho(z_0 + ihz) + \varrho(z_0 - ihz) - 4\varrho(z_0)}{4h^2 \partial_{\text{wirt}} \bar{\partial}_{\text{wirt}} \varrho(z_0)} \\ &= z\bar{z} + \frac{\Theta(hz) + \Theta(-hz) + \Theta(ihz) + \Theta(-ihz)}{4h^2 \partial_{\text{wirt}} \bar{\partial}_{\text{wirt}} \varrho(z_0)}. \end{aligned} \quad (3.5)$$

If $\partial_{\text{wirt}} \bar{\partial}_{\text{wirt}} \varrho(z_0) = 0$ and $\partial_{\text{wirt}}^2 \varrho(z_0) \neq 0$, consider $w = hz$ and $w = \sqrt{i}hz$, where \sqrt{i} is a fixed square root of i :

$$\begin{aligned} &\frac{\varrho(z_0 + hz) + \varrho(z_0 - hz) - i\varrho(z_0 + \sqrt{i}hz) - i\varrho(z_0 - \sqrt{i}hz) + 2(-1 + i)\varrho(z_0)}{2h^2 \partial_{\text{wirt}}^2 \varrho(z_0)} \\ &= z^2 + \frac{\Theta(hz) + \Theta(-hz) - i\Theta(\sqrt{i}hz) - i\Theta(-\sqrt{i}hz)}{2h^2 \partial_{\text{wirt}}^2 \varrho(z_0)}. \end{aligned} \quad (3.6)$$

Last, if $\partial_{\text{wirt}}^2 \varrho(z_0) = \partial_{\text{wirt}} \bar{\partial}_{\text{wirt}} \varrho(z_0) = 0$ consider $w = hz$:

$$\frac{\varrho(z_0 + hz) + \varrho(z_0 - hz) - 2\varrho(z_0)}{h^2 \bar{\partial}_{\text{wirt}}^2 \varrho(z_0)} = \bar{z}^2 + \frac{\Theta(hz) + \Theta(-hz)}{h^2 \bar{\partial}_{\text{wirt}}^2 \varrho(z_0)}. \quad (3.7)$$

Since K is bounded, there is $L > 0$ with $|z| \leq L$ for every $z \in K$. For given $\varepsilon' > 0$ there exists $\delta > 0$ such that

$$\left| \frac{\Theta(w)}{w^2} \right| < \frac{\varepsilon'}{L^2}$$

for every $w \in \mathbb{C} \setminus \{0\}$ with $|w| < \delta$. Hence, we see for every $h \in (0, \delta/L)$ and all $z \in K \setminus \{0\}$ that

$$\left| \frac{\Theta(hz)}{h^2} \right| \leq L^2 \cdot \left| \frac{\Theta(hz)}{(hz)^2} \right| < \varepsilon'$$

where we used that $|hz| < \delta$. Therefore, we conclude

$$\limsup_{h \downarrow 0} \sup_{z \in K} \frac{\Theta(hz)}{h^2} = 0,$$

using $\Theta(0) = 0$. The claim then follows from Equations (3.5) to (3.7). \square

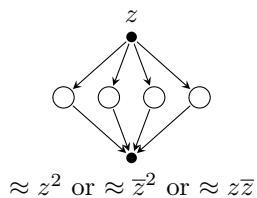

FIGURE 3. Illustration of the neural network building block from Proposition 3.2. Neurons in the input and output layers are depicted in filled dots at the top and bottom, respectively. Applications of the activation function ϱ are shown as circles.

In order to approximate arbitrary polynomials in the variables z_1, \dots, z_n and $\bar{z}_1, \dots, \bar{z}_n$, we will compute iterative products of two complex numbers in Theorem 5.3. The following result enables the approximation of such products. An illustration of the CVNN blocks appearing in the proof are given in Figure 4.

Proposition 3.3. *Let $\varrho \in C^2(\mathbb{C}; \mathbb{C})$ be not \mathbb{R} -affine, $K \subseteq \mathbb{C}^2$ compact, and $\varepsilon > 0$. Then there exist $\phi \in \text{Aff}(\mathbb{C}^2; \mathbb{C}^{12})$ and $\psi \in \text{Aff}(\mathbb{C}^{12}; \mathbb{C})$ such that at least one of the three inequalities*

$$\begin{aligned} \sup_{(z,w) \in K} |(\psi \circ \varrho^{\times 12} \circ \phi)(z,w) - zw| &< \varepsilon, \\ \sup_{(z,w) \in K} |(\psi \circ \varrho^{\times 12} \circ \phi)(z,w) - z\bar{w}| &< \varepsilon, \\ \sup_{(z,w) \in K} |(\psi \circ \varrho^{\times 12} \circ \phi)(z,w) - \bar{z}w| &< \varepsilon \end{aligned}$$

holds true.

Proof. The main steps of the proof are to use a variant of the polarization identity to reconstruct the three multiplication operators from their values on the diagonal, and then to apply Proposition 3.2 to approximate the latter.

Precisely, the construction is as follows: If $\zeta \mapsto \zeta\bar{\zeta} = |\zeta|^2$ can be approximated according to the first case of Proposition 3.2, use the identity

$$\left(\frac{1}{4} + \frac{i}{4}\right) |z+w|^2 + \left(-\frac{1}{4} + \frac{i}{4}\right) |z-w|^2 - \frac{i}{2} |z-iw|^2 = z\bar{w}.$$

In order to approximate $(z,w) \mapsto z\bar{w}$, one needs 4 hidden neurons to approximate $\zeta \mapsto |\zeta|^2$ for each of the 3 linear combinations of z and w , resulting in a total amount of 12 hidden neurons.

If we have the second case of Proposition 3.2, we can approximate $\zeta \mapsto \zeta^2$ using 4 hidden neurons. In this case, consider

$$\frac{1}{4} [(z+w)^2 - (z-w)^2] = zw,$$

so that in total one needs 8 neurons in order to approximate $(z,w) \mapsto zw$. In the last case of Proposition 3.2 we can approximate $\zeta \mapsto \bar{\zeta}^2$ using 4 hidden neurons. Considering

$$\frac{1}{4} \left[\overline{(z+w)^2} - \overline{(z-w)^2} \right] = \bar{z}\bar{w},$$

we infer that $(z,w) \mapsto \bar{z}\bar{w}$ can be approximated using 8 hidden neurons. \square

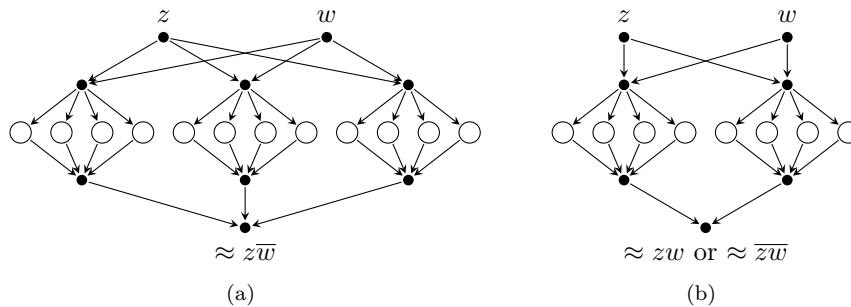

FIGURE 4. Illustration of the neural network building block from Proposition 3.3. Neurons in the input and output layers are depicted in filled dots at the top and bottom, respectively. Applications of the activation function ϱ are shown as circles. From the input values z and w , three or two linear combinations are computed. Then the building block from Figure 3 is inserted to approximate $z \mapsto z^2$, $z \mapsto \bar{z}^2$, or $z \mapsto z\bar{z}$. The results are again combined linearly.

At the end of this section we want to introduce the fundamental concept of the *register model*. This construction has been heavily used in [15] to prove the real-valued counterpart of the theorem established in the present paper. The key idea is to transform a shallow neural network into a deep narrow network by “flipping” the shallow network and only performing one computation per layer. This is formalized in Proposition 3.4 and illustrated in Figure 5.

Proposition 3.4. *Let $n, m, \ell \in \mathbb{N}$ and $\varrho : \mathbb{C} \rightarrow \mathbb{C}$. Denote by $\mathcal{I}_{n,m,n+m+1}^\ell$ the set of register models*

$$T_L \circ \tilde{\varrho} \circ \dots \circ \tilde{\varrho} \circ T_1,$$

where $T_1 \in \text{Aff}(\mathbb{C}^n; \mathbb{C}^{n+m+1})$, $T_L \in \text{Aff}(\mathbb{C}^{n+m+1}; \mathbb{C}^m)$, $T_\ell \in \text{Aff}(\mathbb{C}^{n+m+1}; \mathbb{C}^{n+m+1})$ for $\ell \in \{2, \dots, L-1\}$, and the map $\tilde{\varrho}$ acts on \mathbb{C}^{n+m+1} via

$$\tilde{\varrho} : \mathbb{C}^{n+m+1} \rightarrow \mathbb{C}^{n+m+1}, \quad (\tilde{\varrho}(z_1, \dots, z_{n+m+1}))_j = \begin{cases} \varrho(z_{n+1}), & j = n+1, \\ z_j, & j \neq n+1. \end{cases}$$

Then $\mathcal{SN}_{n,m}^\ell \subseteq \mathcal{I}_{n,m,n+m+1}^\ell$.

Proof. Let $f = V_2 \circ \varrho^{\times(n+m+1)} \circ V_1$ with $V_1 \in \text{Aff}(\mathbb{C}^n; \mathbb{C}^{n+m+1})$ and $V_2 \in \text{Aff}(\mathbb{C}^{n+m+1}; \mathbb{C}^m)$. For $j \in \{1, \dots, m\}$, the j th component function f_j of f can be written as

$$f_j(z) = \left(\sum_{k=1}^{n+m+1} c_{k,j} \varrho(a_k^\top z + b_k) \right) + d_j$$

with suitably chosen $a_k \in \mathbb{C}^n$ and $c_{k,j}, b_k, d_j \in \mathbb{C}$. We define

$$T_1 : \mathbb{C}^n \rightarrow \mathbb{C}^n \times \mathbb{C} \times \mathbb{C}^m, \quad T_1(z) = (z, a_1^\top z + b_1, 0).$$

For $\ell \in \{2, \dots, n+m+1\}$, we define

$$T_\ell : \mathbb{C}^n \times \mathbb{C} \times \mathbb{C}^m \rightarrow \mathbb{C}^n \times \mathbb{C} \times \mathbb{C}^m, \quad T_\ell(z, u, (w_1, \dots, w_m)) = \begin{pmatrix} z \\ a_\ell^\top z + b_\ell \\ w_1 + c_{\ell-1,1}u \\ w_2 + c_{\ell-1,2}u \\ \vdots \\ w_m + c_{\ell-1,m}u \end{pmatrix}.$$

Last, we set

$$T_{n+m+2} : \mathbb{C}^n \times \mathbb{C} \times \mathbb{C}^m \rightarrow \mathbb{C}^m, \quad T_{n+m+2}(z, u, (w_1, \dots, w_m)) = \begin{pmatrix} w_1 + c_{W,1}u + d_1 \\ w_2 + c_{W,2}u + d_2 \\ \vdots \\ w_m + c_{W,m}u + d_3 \end{pmatrix}.$$

Then we have

$$f = T_{n+m+2} \circ \tilde{\varrho} \circ \dots \circ \tilde{\varrho} \circ T_1,$$

which clearly yields $f \in \mathcal{I}_{n,m,n+m+1}^{\varrho}$. □

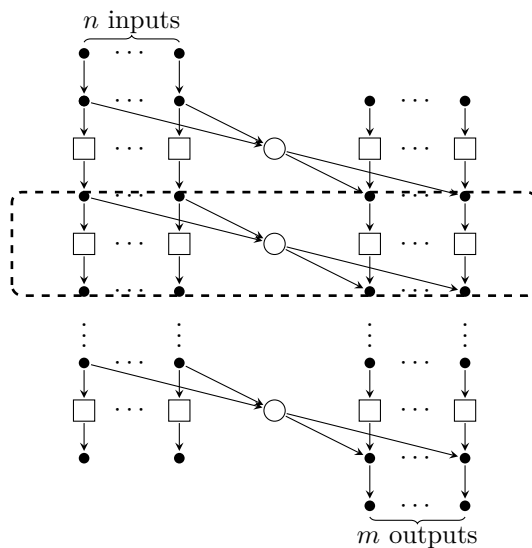

FIGURE 5. Illustration of the register model from Proposition 3.4. Neurons where the complex identity is used as activation function are visualized as squares, whereas neurons using ϱ as activation function are visualized using circles. The in-register neurons (squares on the left) store the input values and pass them to the computation neurons (middle circles). The result of the computations are added up and stored in the out-register neurons (squares on the right). The dashed box highlights one of the blocks that are later replaced using approximations of the complex identity.

4. THE NON-POLYHARMONIC CASE

When the activation function ϱ is not polyharmonic, the universal approximation theorem for shallow CVNNs from [28, Theorem 1.3] is applicable. For convenience, we state the following special case relevant for our investigations.

Theorem 4.1. *Let $n \in \mathbb{N}$ and $\varrho \in C(\mathbb{C}; \mathbb{C})$. Then $\mathcal{SN}_{n,1}^{\varrho}$ is universal if and only if ϱ is not polyharmonic.*

In conjunction with suitable register models, it is possible to construct deep narrow networks to approximate a given continuous function. To do so, it is necessary to approximate the identity function. By assumption, the activation function ϱ is real differentiable at some point $z_0 \in \mathbb{C}$ with non-zero derivative. We consider three different cases. Firstly, if ϱ is even *complex* differentiable at z_0 , Proposition 3.1 yields an approximation of $\text{id}_{\mathbb{C}}$ using shallow CVNNs with activation function ϱ and a width of 1. In that case, the register model can be used where the identity connections have to be replaced by sufficiently good approximations, resulting in a sufficient width of $n + m + 1$. Secondly, if $\bar{\varrho}$ is

complex differentiable at z_0 , we combine the fact that $\mathcal{NN}_{n,m,n+m+1}^{\bar{\varrho}}$ is universal and that $\overline{\text{id}_{\mathbb{C}}}$ can be approximated according to Proposition 3.1 to deduce the universality of $\mathcal{NN}_{n,m,n+m+1}^{\varrho}$. Lastly, if neither of the two former cases happens, we show that a width of $2n + 2m + 1$ is sufficient for CVNNs with activation function ϱ in order to be universal, by combining the register model with the third building block described in Proposition 3.1.

Theorem 4.2. *Let $n, m \in \mathbb{N}$. Assume that $\varrho \in C(\mathbb{C}; \mathbb{C})$ is not polyharmonic and that there exists $z_0 \in \mathbb{C}$ such that ϱ is real differentiable at z_0 with non-zero derivative.*

- (i) *If $\partial_{\text{wirt}}\varrho(z_0) \neq 0$ and $\bar{\partial}_{\text{wirt}}\varrho(z_0) = 0$, then the set $\mathcal{NN}_{n,m,n+m+1}^{\varrho}$ is universal.*
- (ii) *If $\partial_{\text{wirt}}\varrho(z_0) = 0$ and $\bar{\partial}_{\text{wirt}}\varrho(z_0) \neq 0$, then the set $\mathcal{NN}_{n,m,n+m+1}^{\varrho}$ is universal.*
- (iii) *If $\partial_{\text{wirt}}\varrho(z_0) \neq 0$ and $\bar{\partial}_{\text{wirt}}\varrho(z_0) \neq 0$, then the set $\mathcal{NN}_{n,m,2n+2m+1}^{\varrho}$ is universal.*

Proof. Let $f \in C(\mathbb{C}^n; \mathbb{C}^m)$, $K \subseteq \mathbb{C}$ a compact subset, and $\varepsilon > 0$.

Using Theorem 4.1, Proposition 3.4, and the notation introduced therein, we infer that there is a function $g \in \mathcal{I}_{n,m,n+m+1}^{\varrho}$ with

$$\sup_{z \in K} \|f(z) - g(z)\|_{\mathbb{C}^m} < \frac{\varepsilon}{2}.$$

This means that there exist $T_1 \in \text{Aff}(\mathbb{C}^n; \mathbb{C}^{n+m+1})$, $T_L \in \text{Aff}(\mathbb{C}^{n+m+1}; \mathbb{C}^m)$, and $T_\ell \in \text{Aff}(\mathbb{C}^{n+m+1}; \mathbb{C}^{n+m+1})$ for $\ell \in \{2, \dots, L-1\}$ such that

$$g = T_L \circ \tilde{\varrho} \circ T_{L-1} \circ \dots \circ \tilde{\varrho} \circ T_1,$$

where $\tilde{\varrho}: \mathbb{C}^{n+m+1} \rightarrow \mathbb{C}^{n+m+1}$ is given by

$$(\tilde{\varrho}(z_1, \dots, z_{n+m+1}))_j = \begin{cases} z_j, & j \in \{1, \dots, n+m\}, \\ \varrho(z_{n+m+1}), & j = n+m+1. \end{cases}$$

We first prove (i). Combining Proposition 3.1(i), Proposition A.2, and Proposition A.5, we deduce the existence of sequences $(\Psi_j)_{j \in \mathbb{N}}$ and $(\Phi_j)_{j \in \mathbb{N}}$ with $\Psi_j, \Phi_j \in \text{Aff}(\mathbb{C}^{n+m+1}; \mathbb{C}^{n+m+1})$ for $j \in \mathbb{N}$, satisfying

$$\Psi_j \circ \varrho^{\times(n+m+1)} \circ \Phi_j \xrightarrow{j \rightarrow \infty} \tilde{\varrho}$$

locally uniformly. Proposition A.5 now implies that the sequence $(g_j)_{j \in \mathbb{N}}$ given by

$$g_j = T_L \circ \left(\Psi_j \circ \varrho^{\times(n+m+1)} \circ \Phi_j \right) \circ T_{L-1} \circ \dots \circ \left(\Psi_j \circ \varrho^{\times(n+m+1)} \circ \Phi_j \right) \circ T_1$$

converges locally uniformly to g as $j \rightarrow \infty$. Moreover, since the composition of affine maps is affine, we have $g_j \in \mathcal{NN}_{n,m,n+m+1}^{\varrho}$ for all $j \in \mathbb{N}$. Claim (i) now follows from another application of Proposition A.2.

We now deal with (ii). By the fundamental properties of Wirtinger derivatives (see for instance [14, E. 1a]) we compute

$$\partial_{\text{wirt}}\tilde{\varrho}(z_0) = \overline{\partial_{\text{wirt}}\varrho(z_0)} \neq 0 \quad \text{and} \quad \bar{\partial}_{\text{wirt}}\tilde{\varrho}(z_0) = \overline{\partial_{\text{wirt}}\varrho(z_0)} = 0.$$

It is immediate to see that $\varrho \in C^\infty(\mathbb{C}; \mathbb{C})$ if and only if $\bar{\varrho} \in C^\infty(\mathbb{C}; \mathbb{C})$. In that case, it holds $\Delta^m \bar{\varrho} = \overline{\Delta^m \varrho}$ for any $m \in \mathbb{N}_0$. These two properties imply that $\bar{\varrho}$ is non-polyharmonic. From (i) we deduce that the set $\mathcal{NN}_{n,m,n+m+1}^{\bar{\varrho}}$ is universal. We claim that the set $\mathcal{NN}_{n,m,n+m+1}^{\varrho}$ is universal, too. Indeed, let $f \in \mathcal{NN}_{n,m,n+m+1}^{\bar{\varrho}}$ be arbitrary and consider the decomposition

$$f = V_L \circ \bar{\varrho}^{\times(n+m+1)} \circ V_{L-1} \circ \dots \circ \bar{\varrho}^{\times(n+m+1)} \circ V_1$$

with $V_1 \in \text{Aff}(\mathbb{C}^n; \mathbb{C}^{n+m+1})$, $V_\ell \in \text{Aff}(\mathbb{C}^{n+m+1}; \mathbb{C}^{n+m+1})$, and $V_L \in \text{Aff}(\mathbb{C}^{n+m+1}; \mathbb{C}^m)$ for every number $\ell \in \{2, \dots, L-1\}$. From Proposition 3.1(ii) we infer the existence of sequences $(\Phi_j)_{j \in \mathbb{N}}$ and $(\Psi_j)_{j \in \mathbb{N}}$ with $\Phi_j, \Psi_j \in \text{Aff}(\mathbb{C}^{n+m+1}; \mathbb{C}^{n+m+1})$ for $j \in \mathbb{N}$ such that

$$\Psi_j \circ \varrho^{\times(n+m+1)} \circ \Phi_j \xrightarrow{j \rightarrow \infty} \overline{\text{id}_{\mathbb{C}}}^{\times(n+m+1)}$$

locally uniformly. But then we see

$$V_L \circ \left(\Psi_j \circ \varrho^{\times(n+m+1)} \circ \Phi_j \right) \circ \varrho^{\times(n+m+1)} \circ V_{L-1} \circ \dots \circ \left(\Psi_j \circ \varrho^{\times(n+m+1)} \circ \Phi_j \right) \circ \varrho^{\times(n+m+1)} \circ V_1 \xrightarrow{j \rightarrow \infty} f$$

locally uniformly, where the left-hand side is an element of $\mathcal{NN}_{n,m,n+m+1}^{\varrho}$ for every $j \in \mathbb{N}$. Here we applied Proposition A.5. This shows that $\mathcal{NN}_{n,m,n+m+1}^{\tilde{\varrho}}$ is dense in $\mathcal{NN}_{n,m,n+m+1}^{\varrho}$ with respect to local uniform convergence which in turn yields the universality of $\mathcal{NN}_{n,m,n+m+1}^{\varrho}$; cf. Proposition A.2.

The proof of (iii) is analogous. Gluing together one copy of the complex identity $\text{id}_{\mathbb{C}}$ and $n + m$ copies of the function ϕ or (the projection onto the first component of) ψ of Proposition 3.1(iii), respectively, we construct sequences $(\Psi_j)_{j \in \mathbb{N}}, (\Phi_j)_{j \in \mathbb{N}}$ satisfying $\Psi_j \in \text{Aff}(\mathbb{C}^{2n+2m+1}; \mathbb{C}^{n+m+1})$ and $\Phi_j \in \text{Aff}(\mathbb{C}^{n+m+1}; \mathbb{C}^{2n+2m+1})$ for $j \in \mathbb{N}$ such that

$$\Psi_j \circ \varrho^{\times(2n+2m+1)} \circ \Phi_j \xrightarrow{j \rightarrow \infty} \tilde{\varrho}$$

locally uniformly. Because the building blocks consist of 2 neurons in this case, the resulting approximating neural network has width $2n + 2m + 1$ instead of $n + m + 1$. An illustration of the replacement of the in-register and out-register neurons of the register model from Proposition 3.4 using a building block from Proposition 3.1 is given in Figure 6. \square

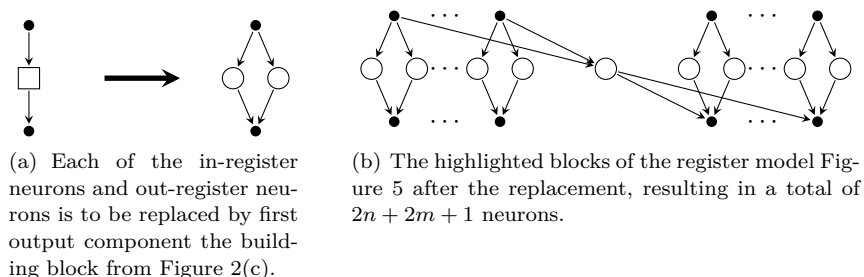

FIGURE 6. Illustration for the proof of Theorem 4.2: Replacement rules for the approximation of register models by CVNNs using building blocks.

Next we provide two examples of activation functions which are used in practice and to which Theorem 4.2 applies.

Example 4.3. The modReLU function has for example been proposed in [2] as a generalization of the classical ReLU to the complex plane. For a parameter $b < 0$ it is defined as

$$\text{modReLU}_b : \mathbb{C} \rightarrow \mathbb{C}, \quad \text{modReLU}_b(z) := \begin{cases} (|z| + b) \frac{z}{|z|}, & |z| + b \geq 0, \\ 0, & \text{otherwise.} \end{cases}$$

An application of Theorem 4.2(iii) shows that for $n, m \in \mathbb{N}$, and $b < 0$, the set $\mathcal{NN}_{n,m,2n+2m+1}^{\text{modReLU}_b}$ is universal.

To this end, let us verify the assumptions of Theorem 4.2 in detail. Since the continuity of modReLU_b is immediate for $z \in \mathbb{C}$ with $|z| \neq -b$, it remains to check the case $|z| = -b$. Take any sequence $(z_j)_{j \in \mathbb{N}}$ with $z_j \rightarrow z$ as $j \rightarrow \infty$, where we assume without loss of generality $|z_j| \geq -b$ for every $j \in \mathbb{N}$. Then $|\text{modReLU}_b(z_j)| = |z_j| + b \rightarrow |z| + b = 0$ as $j \rightarrow \infty$. This shows the continuity of modReLU_b .

In [10, Corollary 5.4] it is shown that for all $z \in \mathbb{C}$ with $|z| > -b$ and all $k, \ell \in \mathbb{N}_0$ one has

$$\partial_{\text{wirt}}^k \bar{\partial}_{\text{wirt}}^\ell \text{modReLU}_b(z) \neq 0.$$

This implies that modReLU_b is non-polyharmonic and $\partial_{\text{wirt}} \text{modReLU}_b(z) \neq 0 \neq \bar{\partial}_{\text{wirt}} \text{modReLU}_b(z)$ for all $z \in \mathbb{C}$ with $|z| > -b$.

Further note that the result from Theorem 4.2 cannot be used to reduce the sufficient width to $n + m + 1$ since it holds $\partial_{\text{wirt}} \text{modReLU}_b(z) \neq 0 \neq \bar{\partial}_{\text{wirt}} \text{modReLU}_b(z)$ for all $z \in \mathbb{C}$ with $|z| > -b$, $\partial_{\text{wirt}} \text{modReLU}_b(z) = \bar{\partial}_{\text{wirt}} \text{modReLU}_b(z) = 0$ for every $z \in \mathbb{C}$ with $|z| < -b$ and modReLU_b is not differentiable in any $z \in \mathbb{C}$ with $|z| = -b$.

Example 4.4. The complex cardioid function has been used in [27] in the context of MRI fingerprinting, where complex-valued neural networks significantly outperformed their real-valued counterparts. It is defined as

$$\text{card} : \mathbb{C} \rightarrow \mathbb{C}, \quad \text{card}(z) := \begin{cases} \frac{1}{2} \left(1 + \frac{\text{Re}(z)}{|z|} \right) z, & z \in \mathbb{C} \setminus \{0\}, \\ 0, & z = 0. \end{cases}$$

An application of Theorem 4.2(i) shows that for $n, m \in \mathbb{N}$ the set $\mathcal{NN}_{n,m,n+m+1}^{\text{card}}$ is universal.

To this end, let us verify the assumptions of Theorem 4.2 in detail. The continuity of card on $\mathbb{C} \setminus \{0\}$ is immediate. Further note that

$$|\text{card}(z)| = \left| \frac{1}{2} \left(1 + \frac{\text{Re}(z)}{|z|} \right) z \right| \leq |z| \rightarrow 0$$

as $z \rightarrow 0$, showing the continuity of card on the entire complex plane \mathbb{C} . Now [10, Corollaries 5.6 and 5.7] show that card is non-polyharmonic and

$$\partial_{\text{wirt}} \text{card}(z) = \frac{1}{2} + \frac{1}{8} \cdot \frac{\bar{z}}{|z|} + \frac{3}{8} \cdot \frac{z}{|z|}, \quad \bar{\partial}_{\text{wirt}} \text{card}(z) = -\frac{1}{8} \cdot \frac{z^3}{|z|^3} + \frac{1}{8} \cdot \frac{z}{|z|}$$

for every $z \in \mathbb{C} \setminus \{0\}$. Hence, we see $\partial_{\text{wirt}} \text{card}(1) = 1$ and $\bar{\partial}_{\text{wirt}} \text{card}(1) = 0$.

5. THE POLYHARMONIC CASE

In this section, we deal with activation functions $\varrho : \mathbb{C} \rightarrow \mathbb{C}$ that are polyharmonic. However, it turns out that this property can be relaxed to only requiring that $\varrho \in C^2(\mathbb{C}; \mathbb{C})$ in order for the proofs to work. The main assumptions of this section can therefore be stated as follows.

Assumption 5.1. *Let $\varrho : \mathbb{C} \rightarrow \mathbb{C}$ be a function satisfying the following conditions:*

- (i) $\varrho \in C^2(\mathbb{C}; \mathbb{C})$,
- (ii) ϱ is not holomorphic,
- (iii) ϱ is not antiholomorphic,
- (iv) ϱ is not \mathbb{R} -affine.

The Stone–Weierstrass theorem states that any continuous function can be arbitrarily well approximated by complex polynomials in z_1, \dots, z_n and $\bar{z}_1, \dots, \bar{z}_n$ in the uniform norm on compact subsets of \mathbb{C}^n . In order to show universality of CVNNs, it suffices therefore to show that such polynomials can be approximated by deep narrow CVNNs to arbitrary precision in the uniform norm on compact sets. We follow an approach similar to that of the register model by preserving the inputs and outputs from layer to layer while gradually performing multiplications to approximate the individual monomials.

Using Proposition 3.1 we derive the following Proposition 5.2. It states that the function $z \mapsto (z, \bar{z})$ can be uniformly approximated on compact sets by a shallow network of width 2.

Proposition 5.2. *Let ϱ satisfy Assumption 5.1, let $K \subseteq \mathbb{C}$ be compact and $\varepsilon > 0$. Then there are maps $\phi \in \text{Aff}(\mathbb{C}; \mathbb{C}^2)$ and $\psi \in \text{Aff}(\mathbb{C}^2; \mathbb{C}^2)$ such that*

$$\sup_{z \in K} \|(\psi \circ \varrho^{\times 2} \circ \phi)(z) - (z, \bar{z})\|_{\mathbb{C}^2} < \varepsilon.$$

Proof. If there is a point $z_0 \in \mathbb{C}$ with $\partial_{\text{wirt}} \varrho(z_0) \neq 0 \neq \bar{\partial}_{\text{wirt}} \varrho(z_0)$, we can directly apply Proposition 3.1(iii). If there is no such point z_0 , we can still find $z_1 \in \mathbb{C}$ with $\partial_{\text{wirt}} \varrho(z_1) \neq 0$ and $z_2 \in \mathbb{C}$ with $\bar{\partial}_{\text{wirt}} \varrho(z_2) \neq 0$, since ϱ is neither holomorphic nor antiholomorphic. By assumption of the nonexistence of $z_0 \in \mathbb{C}$ with $\partial_{\text{wirt}} \varrho(z_0) \neq 0 \neq \bar{\partial}_{\text{wirt}} \varrho(z_0)$, it follows that $\bar{\partial}_{\text{wirt}} \varrho(z_1) = 0$ and $\partial_{\text{wirt}} \varrho(z_2) = 0$, and we can thus apply Proposition 3.1(i) and (ii). \square

In fact, it is possible to show that under the conditions formulated in Assumption 5.1, one can always find a point $z_0 \in \mathbb{C}$ with $\partial_{\text{wirt}} \varrho(z_0) \neq 0 \neq \bar{\partial}_{\text{wirt}} \varrho(z_0)$.

Proposition 5.2 is a central finding, since it implies that we can build from the activation function ϱ constructions that are similar to the register model construction from Proposition 3.4. Together with Proposition 3.3 from Section 3, this leads to the following proof of the sufficiency part of Theorem 1.1.

Theorem 5.3. *Let $n, m \in \mathbb{N}$. Assume that $\varrho \in C(\mathbb{C}; \mathbb{C})$ satisfies Assumption 5.1. Then $\mathcal{NN}_{n,m,2n+2m+5}^{\varrho}$ is universal.*

Moreover, if there is a point $z_0 \in \mathbb{C}$ with either

$$\partial_{\text{wirt}}\varrho(z_0) \neq 0 = \bar{\partial}_{\text{wirt}}\varrho(z_0) \quad \text{or} \quad \partial_{\text{wirt}}\varrho(z_0) = 0 \neq \bar{\partial}_{\text{wirt}}\varrho(z_0), \quad (5.1)$$

then $\mathcal{NN}_{n,m,n+m+4}^{\varrho}$ is universal.

Proof. We first provide a detailed proof of the universality of $\mathcal{NN}_{n,m,2n+2m+5}^{\varrho}$. Afterwards, we comment on how to adapt it to show that a width of $n + m + 4$ is sufficient if (5.1) is fulfilled.

From the Stone–Weierstrass theorem [9, Theorem 4.51], we know that the set of complex polynomials in z_1, \dots, z_n and $\bar{z}_1, \dots, \bar{z}_n$ is dense in $C(K; \mathbb{C})$ with respect to the uniform norm on the compact set $K \subset \mathbb{C}^n$. Hence, it suffices to show that each function $p : K \rightarrow \mathbb{C}^m$, whose components are polynomials in z_1, \dots, z_n and $\bar{z}_1, \dots, \bar{z}_n$ can be uniformly approximated on K by CVNNs of width $2n + 2m + 5$. Let $p = (p_1, \dots, p_m)$ be such a function and decompose $p_\ell = \sum_{j=1}^{L_\ell} a_{j,\ell} p_{j,\ell}$ with each $p_{j,\ell}$ being a monomial (i.e., a product of some of the variables $z_1, \dots, z_n, \bar{z}_1, \dots, \bar{z}_n$), and $a_{j,\ell} \in \mathbb{C}$ for $\ell \in \{1, \dots, m\}$ and $j \in \{1, \dots, L_\ell\}$. We now construct a CVNN that approximates p sufficiently well on K .

The idea is to construct a register-like model where each layer consists of $2n + m + 1$ neurons with $2n$ *in-register neurons* storing the input values and their complex conjugates, m *out-register neurons*, and one *computation neuron*, see Figure 7.

For $k \in \{1, 2, 3\}$, let $\text{mul}_k : \mathbb{C}^2 \rightarrow \mathbb{C}$ be maps defined as $\text{mul}_1(z, w) := zw$, $\text{mul}_2(z, w) := z\bar{w}$, and $\text{mul}_3(z, w) := \bar{z}w$ for all $z, w \in \mathbb{C}$. From Proposition 3.3 we know that there is $\text{mul} \in \{\text{mul}_1, \text{mul}_2, \text{mul}_3\}$ that can be uniformly approximated by shallow CVNNs with activation function ϱ and a width of 12. The available multiplication mul is fixed from now on. Each of the computation neurons takes two inputs and performs the multiplication mul .

We first sketch how to compute and save a single monomial of degree $l \in \mathbb{N}$. Let $q = z_{k_\ell} \cdot z_{k_{\ell-1}} \cdots z_{k_1}$ be such a monomial, where we assume for now that it includes no conjugated variables. We further assume that in every computation neuron we could perform a multiplication. The out-register neurons are initialized with 0 and the computation neuron is initialized with 1. Then the desired monomial can be computed iteratively as $z_{k_\ell} \cdot (z_{k_{\ell-1}} \cdots (z_{k_1} \cdot 1) \cdots)$: in each layer, we pass to the computation neuron the currently needed variable z_{k_j} and the product obtained from the previous computational neuron. However, in general it might occur that the computational neuron only performs the operation $(z, w) \mapsto z\bar{w}$ or $(z, w) \mapsto \bar{z}w$, and that the desired monomial also includes conjugated variables. Hence, the obtained monomial

$$\zeta_{k_\ell} \cdots \zeta_{k_1} := \text{mul}(z_{k_\ell}, \text{mul}(z_{k_{\ell-1}}, \dots \text{mul}(z_{k_1}, 1) \cdots))$$

might differ from q .

However, by the basic properties of complex conjugation, for every $j \in \{1, \dots, \ell\}$, ζ_{k_j} is either z_{k_j} or \bar{z}_{k_j} . Since the input register saves both the variables and their conjugates, it suffices to pass, if necessary, \bar{z}_{k_j} instead of z_{k_j} from the input register to the computation neuron at the j th step. This ensures that it is always possible to compute the desired monomial.

Let us now describe how the entire polynomial p is computed: In each layer the current value of the computation neuron or its complex conjugate is multiplied with either the value of one of the in-register neurons or its complex conjugate, according to Proposition 3.3. This is performed repeatedly until the first monomial $p_{1,1}$ is completed. Once the first monomial $p_{1,1}$ is realized, it is then multiplied with its coefficient and stored into the first out-register neuron. This is then repeated for the other monomials $p_{j,1}$ and the result is gradually added up in the first out-register neuron which then finally stores the desired polynomial for the first component p_1 . This procedure is then repeated for the other polynomials p_2, \dots, p_m .

The approximation of this type of register model by CVNNs is done using the building blocks from Section 3. An illustration of the replacement rules is shown in Figure 8.

In the following we want to make this idea more precise. To this end, we set up a register model in Step 1, and show in Step 2 how this register model can be uniformly approximated by elements of $\mathcal{NN}_{n,m,2n+2m+12}^{\varrho}$ on compact sets. This yields universality of $\mathcal{NN}_{n,m,2n+2m+12}^{\varrho}$. In Step 2' we

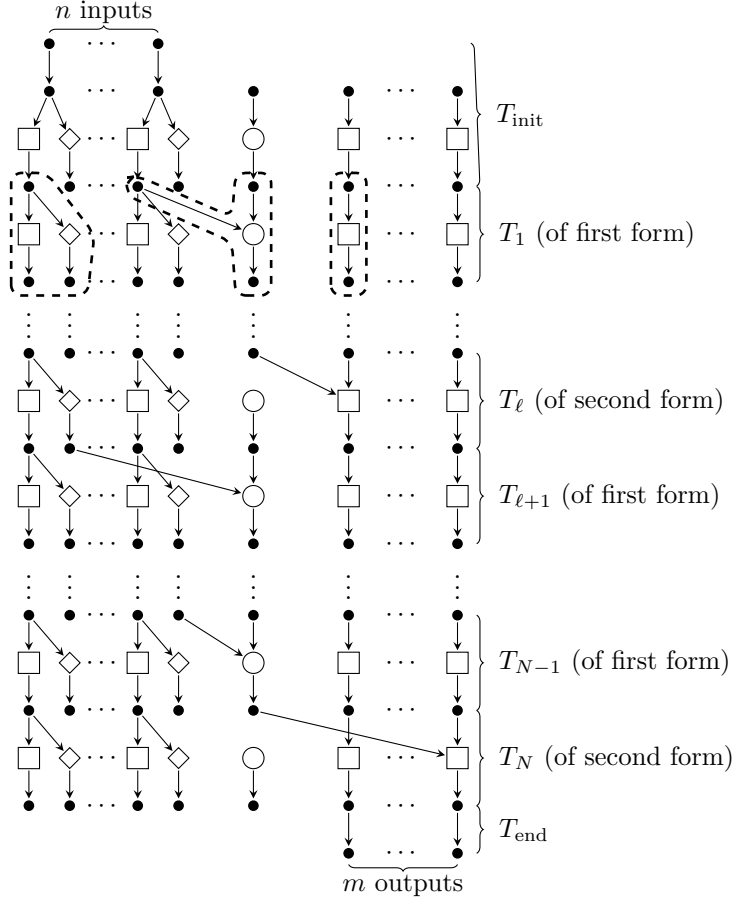

FIGURE 7. The register-like model from Theorem 5.3: Squares and diamonds depict the complex identity map and complex conjugation, respectively. Each circle stands for one of the multiplication operations mul_k from the proof of Theorem 5.3. The choice of the connections from the in-register neurons (left) to the computation neuron (middle) depends on the monomial that is approximated and the operation mul_k that is available (T_ℓ of the first form). One of them is shown in the figure. The connections from the computation neuron (middle) to the out-register neuron (right) are drawn each time the computation of a monomial of one of the m output polynomials is completed (T_ℓ of the second form). The dashed portions of the register model are to be replaced according to Figure 8.

provide a more detailed analysis of the arguments from Step 2 which lead to the claimed universality of $\mathcal{NN}_{n,m,2n+2m+5}^e$.

Step 1. Fix $\text{mul} \in \{\text{mul}_1, \text{mul}_2, \text{mul}_3\}$. We can deduce that we can write p as a composition

$$p = T_{\text{end}} \circ T_N \circ T_{N-1} \circ \dots \circ T_1 \circ T_{\text{init}} \quad (5.2)$$

for some number $N \in \mathbb{N}$ with

$$\begin{aligned} T_{\text{init}} : \mathbb{C}^n &\rightarrow \mathbb{C}^n \times \mathbb{C}^n \times \mathbb{C} \times \mathbb{C}^m, & z &\mapsto (z, \bar{z}, 1, 0), \\ T_{\text{end}} : \mathbb{C}^n \times \mathbb{C}^n \times \mathbb{C} \times \mathbb{C}^m &\rightarrow \mathbb{C}^m, & (z, u, w, v) &\mapsto v \end{aligned}$$

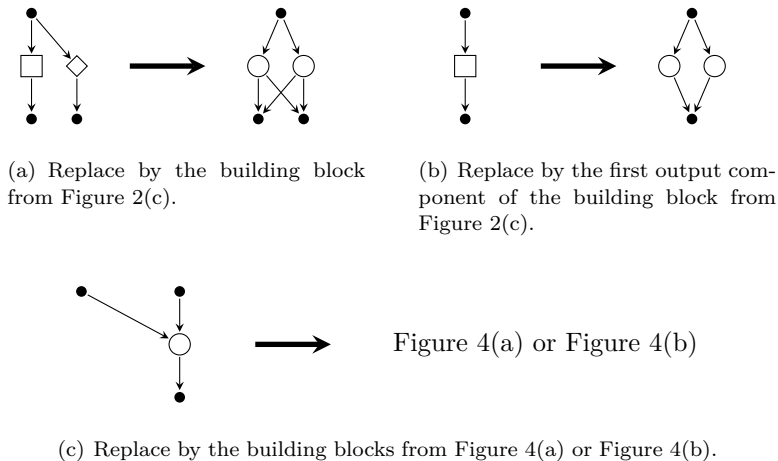

FIGURE 8. Replacement rules for the highlighted portions in Figure 7.

and for every $\ell \in \{1, \dots, N\}$, the map $T_\ell : \mathbb{C}^{2n+m+1} \rightarrow \mathbb{C}^{2n+m+1}$ has one of the two following forms: The first possible form is

$$T_\ell : \mathbb{C}^n \times \mathbb{C}^n \times \mathbb{C} \times \mathbb{C}^m \rightarrow \mathbb{C}^n \times \mathbb{C}^n \times \mathbb{C} \times \mathbb{C}^m, \quad (z, u, w, v) \mapsto (z, \bar{z}, \text{mul}((z, u)_k, w), v)$$

where $(z, u)_k$ denotes the k th component of $(z, u) \in \mathbb{C}^n \times \mathbb{C}^n$ for some $k = k(\ell) \in \{1, \dots, 2n\}$. This function realizes the multiplication of the current value of the computation neuron with one of the values of the in-registers, choosing either a variable or its complex conjugation, depending on k . The second possible form is

$$T_\ell : \mathbb{C}^n \times \mathbb{C}^n \times \mathbb{C} \times \mathbb{C}^m \rightarrow \mathbb{C}^n \times \mathbb{C}^n \times \mathbb{C} \times \mathbb{C}^m, \quad (z, u, w, v) \mapsto (z, u, 1, v + a_{j,k} w e_k)$$

for some $k \in \{1, \dots, m\}$ and $j \in \{1, \dots, L_k\}$. Here, e_k denotes the k th standard basis vector of \mathbb{C}^m . This is the function that adds a finished monomial to the corresponding out-register neuron.

Step 2. To conclude, we see that every function T_ℓ occurring in the composition (5.2) is either an affine map (if it has the second form) or has the property that there are sequences $(\phi_j^\ell)_{j \in \mathbb{N}}$ and $(\psi_j^\ell)_{j \in \mathbb{N}}$ with $\phi_j^\ell \in \text{Aff}(\mathbb{C}^{2n+m+1}; \mathbb{C}^{2n+2m+12})$ and $\psi_j^\ell \in \text{Aff}(\mathbb{C}^{2n+2m+12}; \mathbb{C}^{2n+m+1})$ such that

$$\psi_j^\ell \circ \varrho^{\times(2n+2m+12)} \circ \phi_j^\ell \xrightarrow{j \rightarrow \infty} T_\ell \quad \text{locally uniformly,}$$

where we applied Propositions 3.3 and 5.2. Similarly, one can find sequences $(\phi_j^{\text{init}})_{j \in \mathbb{N}}$ and $(\psi_j^{\text{init}})_{j \in \mathbb{N}}$ with $\phi_j^{\text{init}} \in \text{Aff}(\mathbb{C}^n; \mathbb{C}^{2n})$ and $\psi_j^{\text{init}} \in \text{Aff}(\mathbb{C}^{2n}; \mathbb{C}^{2n+m+1})$ satisfying

$$\psi_j^{\text{init}} \circ \varrho^{\times 2n} \circ \phi_j^{\text{init}} \xrightarrow{j \rightarrow \infty} T_{\text{init}} \quad \text{locally uniformly.}$$

Using Proposition A.5, we obtain the universality of $\mathcal{NN}_{2n+2m+12}^g$.

Step 2'. In the previous step, we approximated in the sense of Proposition A.5 the complex identity neurons and the complex conjugation neurons by the elementary building blocks given in Proposition 3.1, and the multiplication operation mul by the building block given by Proposition 3.3. The latter is a shallow CVNN of width 12. In order to further reduce the width, we will first approximate this shallow CVNN by an appropriate register model according to Proposition 3.4, and only then replace all complex identities and conjugations by the elementary building blocks.

Each of the functions T_1, \dots, T_N occurring in the composition (5.2) is either an affine map (if it has the second form) or has the following property: For each $\ell \in \{1, \dots, N\}$, there are sequences $(\phi_j^\ell)_{j \in \mathbb{N}}$

and $(\psi_j^\ell)_{j \in \mathbb{N}}$ with $\phi_j^\ell \in \text{Aff}(\mathbb{C}^2; \mathbb{C}^{12})$ and $\psi_j^\ell \in \text{Aff}(\mathbb{C}^{12}; \mathbb{C})$ such that $F_j^\ell \xrightarrow{j \rightarrow \infty} T_\ell$ locally uniformly, where we define

$$F_j^\ell : \mathbb{C}^n \times \mathbb{C}^n \times \mathbb{C} \times \mathbb{C}^m \rightarrow \mathbb{C}^n \times \mathbb{C}^n \times \mathbb{C} \times \mathbb{C}^m, \quad (z, u, w, v) \mapsto (z, \bar{z}, \tilde{F}_j^\ell((z, u)_k, w), v)$$

and $\tilde{F}_j^\ell = \psi_j^\ell \circ \varrho^{\times 12} \circ \phi_j^\ell : \mathbb{C}^2 \rightarrow \mathbb{C}$ with $k = k(\ell)$ from the definition of T_ℓ .

Note that $\tilde{F}_j^\ell \in \mathcal{SN}_{2,1}^g \subseteq \mathcal{I}_{2,1,4}^g$ for all $j, \ell \in \mathbb{N}$ thanks to Proposition 3.4. Hence, every function F_j^ℓ can be represented by a (“large”) register model with input and output dimension both equal to $2n + m + 1$ and with $2n + m + 4$ neurons per hidden layer. These $2n + m + 4$ neurons can be grouped as follows: n in-register neurons use the complex identity as activation function and store the n input values, n in-register neurons use the complex conjugation as activation function and store the complex conjugates of those input values, m out-register neurons use the complex identity as activation function and carry the output values of the original polynomial, and 4 neurons for the (“small”) register model that represents \tilde{F}_j^ℓ , of which two in-register neurons and one out-register neurons use the complex identity, and one computation neuron uses ϱ as activation function. Note that one of the two in-register neurons of the small register model stores one of the input variables of the large register model and can therefore be dropped. This results in total in a register model with $n + m + 2$ identity neurons, n conjugation neurons, and 1 neuron using ϱ as its activation function per hidden layer.

Making this more precise, we write

$$F_j^\ell = V_K \circ \tilde{\varrho} \circ V_{K-1} \circ \dots \circ V_2 \circ \tilde{\varrho} \circ V_1,$$

where $\tilde{\varrho}$ is as in Proposition 3.4, i.e., it applies ϱ to the $(2n + 2)$ th input variable, and the identity to all others, and for $r \in \{2, \dots, K - 1\}$, we write

$$\begin{aligned} V_1 : \mathbb{C}^n \times \mathbb{C}^n \times \mathbb{C} \times \mathbb{C}^m &\rightarrow \mathbb{C}^n \times \mathbb{C}^n \times \mathbb{C}^3 \times \mathbb{C}^m, & (z, u, w, v) &\mapsto (z, \bar{z}, \eta_1(z, u, w), v), \\ V_r : \mathbb{C}^n \times \mathbb{C}^n \times \mathbb{C}^3 \times \mathbb{C}^m &\rightarrow \mathbb{C}^n \times \mathbb{C}^n \times \mathbb{C}^3 \times \mathbb{C}^m, & (z, u, w, v) &\mapsto (z, \bar{z}, \eta_r(z, u, w), v) \\ V_K : \mathbb{C}^n \times \mathbb{C}^n \times \mathbb{C}^3 \times \mathbb{C}^m &\rightarrow \mathbb{C}^n \times \mathbb{C}^n \times \mathbb{C} \times \mathbb{C}^m, & (z, u, w, v) &\mapsto (z, \bar{z}, \eta_K(z, u, w), v), \end{aligned}$$

where $\eta_1 \in \text{Aff}(\mathbb{C}^{2n+1}; \mathbb{C}^3)$, $\eta_r \in \text{Aff}(\mathbb{C}^{2n+3}; \mathbb{C}^3)$, and $\eta_K \in \text{Aff}(\mathbb{C}^{2n+3}; \mathbb{C})$.

Now we approximate the functions $\tilde{\varrho} \circ V_r$ for $\ell \in \{1, \dots, r\}$ and V_K by shallow CVNNs in the sense of Proposition A.5. Using Proposition 5.2 in the large register model, we approximate each of the n in-register pairs of input values and their complex conjugates, and each of the out-register neurons by a shallow CVNN with 2 hidden neurons. Similarly, the remaining in-register neuron and the out-register neuron of the small register model are approximated in the same way. This results in shallow CVNNs with $2n + 2m + (2 \cdot 2 + 1) = 2n + 2m + 5$ hidden neurons. Formally, we approximate

- $\tilde{\varrho} \circ V_1$ by a sequence of CVNNs $\psi \circ \varrho^{\times(2n+2m+5)} \circ \phi$ with $\phi \in \text{Aff}(\mathbb{C}^{2n+m+1}; \mathbb{C}^{2n+2m+5})$ and $\psi \in \text{Aff}(\mathbb{C}^{2n+2m+5}; \mathbb{C}^{2n+m+3})$,
- $\tilde{\varrho} \circ V_r$ by a sequence of CVNNs $\psi \circ \varrho^{\times(2n+2m+5)} \circ \phi$ with $\phi \in \text{Aff}(\mathbb{C}^{2n+m+3}; \mathbb{C}^{2n+2m+5})$ and $\psi \in \text{Aff}(\mathbb{C}^{2n+2m+5}; \mathbb{C}^{2n+m+3})$ for $r \in \{2, \dots, K - 1\}$,
- V_K by a sequence of CVNNs $\psi \circ \varrho^{\times(2n+2m+2)} \circ \phi$ with $\phi \in \text{Aff}(\mathbb{C}^{2n+m+3}; \mathbb{C}^{2n+2m+2})$ and $\psi \in \text{Aff}(\mathbb{C}^{2n+2m+2}; \mathbb{C}^{2n+m+1})$.

Overall, we deduce that each function F_j^ℓ with $j \in \mathbb{N}$ and $\ell \in \{1, \dots, N\}$ can be uniformly approximated using CVNNs from $\mathcal{NN}_{2n+m+1, 2n+m+1, 2n+2m+5}^g$. Another application of Proposition A.5 shows that each function T_1, \dots, T_N appearing in (5.2) can be uniformly approximated using CVNNs from $\mathcal{NN}_{2n+m+1, 2n+m+1, 2n+2m+5}^g$. Similar arguments apply to T_{init} and T_{end} in (5.2), and this shows that the polynomial p can be uniformly approximated by CVNNs from $\mathcal{NN}_{n, m, 2n+2m+5}^g$. Since p was arbitrary, this together with the Stone–Weierstrass theorem shows the universality of $\mathcal{NN}_{n, m, 2n+2m+5}^g$.

We now discuss in what way the preceding proof has to be adapted in order to show the universality of $\mathcal{NN}_{n, m, n+m+4}^g$ if (5.1) is fulfilled.

First assume $\partial_{\text{wirt}} \varrho(z_0) \neq 0 = \bar{\partial}_{\text{wirt}} \varrho(z_0)$. Proposition 3.1(i) shows that we can approximate $\text{id}_{\mathbb{C}}$ arbitrarily well using shallow CVNNs of width 1 using ϱ as activation function. We then construct a register-model in the spirit of the first part of Step 1 that has in each layer n in-register neurons, m

out-register neurons, one computation neuron realizing the available multiplication mul_k and a *single* conjugation neuron that stores the conjugated version of one of the in-registers. The idea is that we do not need to store the conjugates of all the inputs in every layer. In fact, it suffices to include one conjugation neuron in which the conjugate of one of the inputs is stored if that input is needed in the current computation step. Approximating the multiplication mul first by shallow networks according to Proposition 3.3 and then replacing these shallow networks by deep register models according to Proposition 3.4 yields that we approximate a given polynomial by large variants of CVNNs with a width of $n + m + 1 + 4$ where $n + m + 3$ neurons use the identity activation function, 1 neuron the conjugation and 1 neuron ϱ as activation function. Note also here that we may omit one of the identity neurons since its value is already contained in either the n in-registers or the conjugation neuron. This leads in total to a network of width $n + m + 4$ with $n + m + 2$ identity neurons, one conjugation neuron and one neuron that uses ϱ as activation function. Now we approximate $n + m + 1$ of these identity neurons in the spirit of Proposition 3.1(i) using shallow CVNNs with activation ϱ of width 1 and the remaining identity neuron together with the conjugation neuron in the spirit of Proposition 5.2 using a shallow CVNN with ϱ activation and a width of 2. This yields the universality of $\mathcal{NN}_{n,m,n+m+4}^\varrho$.

If on the other hand $\partial_{\text{virt}}\varrho(z_0) = 0 \neq \bar{\partial}_{\text{virt}}\varrho(z_0)$ we argue as in the proof of Theorem 4.2(ii): By combining the previous part which yields the universality of $\mathcal{NN}_{n,m,n+m+4}^{\bar{\varrho}}$ and Proposition 3.1(ii) we deduce the universality of $\mathcal{NN}_{n,m,n+m+4}^\varrho$. Notice that ϱ satisfies Assumption 5.1 iff $\bar{\varrho}$ does. \square

6. NECESSITY OF OUR ASSUMPTIONS

The proof of Theorem 1.1 is not yet complete. So far, we have proven that activation functions $\varrho \in C(\mathbb{C}; \mathbb{C})$ which are neither holomorphic, nor antiholomorphic, nor \mathbb{R} -affine yield universality of CVNNs of width $2n+2m+5$, with indicated improvements under additional assumptions. The necessity part is done in this section: If ϱ is holomorphic, antiholomorphic, or \mathbb{R} -affine, then even the set of CVNNs using activation function ϱ with *arbitrary widths and depths* is not universal, cf. Theorem 6.3. Furthermore, Theorem 1.1 states that under the mentioned constraints on the activation function, a width of $2n + 2m + 5$ is sufficient for universality of CVNNs with input dimension n and output dimension m . But could we have done better? In Theorem 6.4 below, we show that for a family of real-valued activation functions, the set $\mathcal{NN}_{n,m,W}^\varrho$ is not universal when $W < \max\{2n, 2m\}$. In our final result Theorem 6.5, we show that real differentiability of the activation function at one point with non-vanishing derivative is not necessary for the universal approximation property of deep narrow CVNNs.

We prepare the proof of Theorem 6.3 by two lemmas, the first of which is about uniform convergence of \mathbb{R} -affine functions.

Lemma 6.1. *Let $n, m \in \mathbb{N}$, $(f_k)_{k \in \mathbb{N}}$ be a sequence of \mathbb{R} -affine functions from \mathbb{R}^n to \mathbb{R}^m and $f : \mathbb{R}^n \rightarrow \mathbb{R}^m$. Let $(f_k)_{k \in \mathbb{N}}$ converge locally uniformly to f . Then f is \mathbb{R} -affine too.*

Proof. Let $A_k \in \mathbb{R}^{m \times n}$ and $b_k \in \mathbb{R}^m$ such that $f_k(x) = A_k x + b_k$. Let $b := f(0)$. Then we have $b_k = f_k(0) \rightarrow f(0) = b$. Furthermore we see for every $j \in \{1, \dots, n\}$ that

$$\|A_k e_j - A_\ell e_j\|_{\mathbb{R}^m} \leq \|A_k e_j + b_k - A_\ell e_j - b_\ell\|_{\mathbb{R}^m} + \|b_k - b_\ell\|_{\mathbb{R}^m} \rightarrow 0$$

as $k, \ell \rightarrow \infty$, uniformly over j , meaning $\max_{j \in \{1, \dots, n\}} \|A_k e_j - A_\ell e_j\|_{\mathbb{R}^m} \rightarrow 0$ as $k, \ell \rightarrow \infty$. Consequently, $(A_k)_{k \in \mathbb{N}}$ is a Cauchy sequence and thus converges to some $A \in \mathbb{R}^{m \times n}$. We claim $f(x) = Ax + b$ for every $x \in \mathbb{R}^n$. Indeed, this follows from

$$\|A_k x + b_k - Ax + b\|_{\mathbb{R}^m} \leq \|A_k x - Ax\|_{\mathbb{R}^m} + \|b_k - b\|_{\mathbb{R}^m} \leq \|A_k - A\|_{\mathbb{R}^{m \times n}} \|x\|_{\mathbb{R}^n} + \|b_k - b\|_{\mathbb{R}^m} \rightarrow 0.$$

as $k \rightarrow \infty$. \square

Our second lemma in preparation of the proof of Theorem 6.3 concerns locally uniform limits of sequences of functions that are either holomorphic or antiholomorphic.

Lemma 6.2. *Let $\mathcal{F} := \{F : \mathbb{C} \rightarrow \mathbb{C} : F \text{ holomorphic or antiholomorphic}\}$ and $(f_k)_{k \in \mathbb{N}}$ be a sequence of functions with $f_k \in \mathcal{F}$ for every $k \in \mathbb{N}$. Let $f : \mathbb{C} \rightarrow \mathbb{C}$ be such that $f_k \rightarrow f$ locally uniformly. Then it holds $f \in \mathcal{F}$.*

Proof. We distinguish two cases:

- (i) If there is a subsequence of $(f_k)_{k \in \mathbb{N}}$ consisting of holomorphic functions, the limit f of this subsequence also has to be holomorphic (see for instance [26, Theorem 10.28]).
- (ii) If there is a subsequence of $(f_k)_{k \in \mathbb{N}}$ consisting of antiholomorphic functions, the limit f of this subsequence also has to be antiholomorphic, where we again apply [26, Theorem 10.28] to the complex conjugates of the functions in this subsequence. \square

The necessity part of Theorem 1.1 is covered by the following theorem.

Theorem 6.3. *Let $n, m \in \mathbb{N}$ and $\varrho : \mathbb{C} \rightarrow \mathbb{C}$ be holomorphic or antiholomorphic or \mathbb{R} -affine. Then $\mathcal{NN}_{n,m}^{\varrho} := \bigcup_{W \in \mathbb{N}} \mathcal{NN}_{n,m,W}^{\varrho}$ is not universal.*

Proof. It suffices to show the claim for $m = 1$, since local uniform approximation in \mathbb{C}^m means componentwise local uniform approximation.

We start with the case $n = 1$. If ϱ is holomorphic or antiholomorphic it follows that all the elements of $\mathcal{NN}_{1,1}^{\varrho}$ are holomorphic or antiholomorphic (see, e.g., [28, Proof of Eq. (4.15), p. 28]). But then it follows from Lemma 6.2 and Proposition A.2 that $\mathcal{NN}_{1,1}^{\varrho}$ is not universal. If ϱ is \mathbb{R} -affine, each element of $\mathcal{NN}_{1,1}^{\varrho}$ is \mathbb{R} -affine (as the composition of \mathbb{R} -affine functions). By Lemma 6.1 and Proposition A.2 it follows that $\mathcal{NN}_{1,1}^{\varrho}$ is not universal.

The case $n > 1$ can be reduced to the case $n = 1$ in the following way: Assume that $\mathcal{NN}_{n,1}^{\varrho}$ is universal and pick any arbitrary function $f \in C(\mathbb{C}; \mathbb{C})$. Let $\pi : \mathbb{C}^n \rightarrow \mathbb{C}$, $\pi(z_1, \dots, z_n) = z_1$ and $\tilde{\pi} : \mathbb{C}^n \rightarrow \mathbb{C}^n$, $\tilde{\pi}(z) = (z, 0, \dots, 0)$. Note that it holds $\pi \circ \tilde{\pi} = \text{id}_{\mathbb{C}}$. By assumption, there is a sequence $(g_k)_{k \in \mathbb{N}}$ with $g_k \in \mathcal{NN}_{n,1}^{\varrho}$ satisfying $g_k \in \mathcal{NN}_{n,1}^{\varrho}$ for $k \in \mathbb{N}$ and $g_k \rightarrow f \circ \pi$ locally uniformly. From Proposition A.5 it follows $g_k \circ \tilde{\pi} \rightarrow f$ locally uniformly. Since $g_k \circ \tilde{\pi} \in \mathcal{NN}_{1,1}^{\varrho}$ for every $k \in \mathbb{N}$ it follows that $\mathcal{NN}_{1,1}^{\varrho}$ is universal, in contradiction to what has just been shown. \square

In the previous sections, we showed that for a large class of activation functions a width of $2n+2m+5$ is sufficient for universality of CVNNs with input dimension n and output dimension m . Following the lines of [5, Lemma 1], we show next that for some activation functions, a width of at least $\max\{2n, 2m\}$ is necessary to guarantee universality.

Theorem 6.4. *Let $n, m \in \mathbb{N}$.*

- (i) *Let $\phi \in C(\mathbb{R}; \mathbb{C})$, and $\varrho : \mathbb{C} \rightarrow \mathbb{C}$ be given by $\varrho(z) := \phi(\text{Re}(z))$. Then $\mathcal{NN}_{n,m,2n-1}^{\varrho}$ is not universal.*
- (ii) *Let $\varrho : \mathbb{C} \rightarrow \mathbb{R}$. Then $\mathcal{NN}_{n,m,2m-1}^{\varrho}$ is not universal.*

Proof. We start with (i). Let $K := [-2, 2]^n + i[-2, 2]^n \subseteq \mathbb{C}^n$ and $f(z) := (\|z\|_{\mathbb{C}^n}, 0, \dots, 0)$ for $z \in \mathbb{C}^n$. Let $g \in \mathcal{NN}_{n,m,2n-1}^{\varrho}$ be arbitrary. From the definition of ϱ , it follows that we may write g as

$$g(z) = \psi(\text{Re}(Vz) + b),$$

where $\psi : \mathbb{C}^{2n-1} \rightarrow \mathbb{C}^m$ is some function, $V \in \mathbb{C}^{(2n-1) \times n}$, $b \in \mathbb{R}^{2n-1}$, and the real part Re is taken componentwise. Interpreting $\text{Re} \circ V$ as an \mathbb{R} -linear function from \mathbb{R}^{2n} to \mathbb{R}^{2n-1} we conclude from $2n-1 < 2n$ that there exists $v \in \mathbb{C}^n$ with $\|v\|_{\mathbb{C}^n} = 1$ satisfying $\text{Re}(Vv) = 0$ and hence

$$g(z+v) = g(z) \text{ for any } z \in \mathbb{C}^n. \quad (6.1)$$

We set $A := B_{0.1}(0)$, $B := B_{0.1}(v) \subseteq \mathbb{C}^n$ and compute

$$\begin{aligned} \int_K \|f(z) - g(z)\|_{\mathbb{C}^m} dz &\geq \int_A \|f(z) - g(z)\|_{\mathbb{C}^m} dz + \int_B \|f(z) - g(z)\|_{\mathbb{C}^m} dz \\ &\stackrel{B=A+v}{=} \int_A (\|f(z) - g(z)\|_{\mathbb{C}^m} + \|f(z+v) - g(z+v)\|_{\mathbb{C}^m}) dz \\ &\stackrel{(6.1)}{\geq} \int_A \|f(z) - f(z+v)\|_{\mathbb{C}^m} dz \geq 0.8 \cdot \lambda^{2n}(A) \end{aligned}$$

with λ^{2n} denoting the $2n$ -dimensional Lebesgue measure. In the last inequality we used

$$\|z\|_{\mathbb{C}^n} - \|z + v\|_{\mathbb{C}^n} \geq \|z + v\|_{\mathbb{C}^n} - \|z\|_{\mathbb{C}^n} \geq \|v\|_{\mathbb{C}^n} - 2\|z\|_{\mathbb{C}^n} \geq 0.8.$$

Hence it follows that $\mathcal{NN}_{n,m,2n-1}^{\varrho}$ is not dense in $C(K; \mathbb{C}^m)$ with respect to the L^1 -norm and thus, using Hölder's inequality, it follows that $\mathcal{NN}_{n,m,2n-1}^{\varrho}$ is not dense in $C(K; \mathbb{C}^m)$ with respect to the L^p -norm for any $p \in [1, \infty]$, so in particular for $p = \infty$ which shows that $\mathcal{NN}_{n,m,2n-1}^{\varrho}$ is not universal.

Next, we prove (ii). To this end, we construct a function $f \in C(\mathbb{C}^n; \mathbb{C}^m)$, a compact set $K \subset \mathbb{C}^n$, and a number $\varepsilon > 0$ such that

$$\sup_{z \in K} \|f(z) - g(z)\|_{\mathbb{C}^m} \geq \varepsilon$$

for all $g \in \mathcal{NN}_{n,m,2m-1}^{\varrho}$. For a moment, fix $g \in \mathcal{NN}_{n,m,2m-1}^{\varrho}$. Since the activation function ϱ is real-valued, the output of the last but one layer of g is a function $\psi : \mathbb{C}^n \rightarrow \mathbb{R}^{2m-1}$. Also, there are a matrix $V \in \mathbb{C}^{m \times (2m-1)}$ and a vector $b \in \mathbb{C}^m$ such that $g(z) = V\psi(z) + b$. With $\mathbb{C}^m \cong \mathbb{R}^{2m}$, we may view V as a linear map $\mathbb{R}^{2m-1} \rightarrow \mathbb{R}^{2m}$, and the range $\{g(z) : z \in \mathbb{C}\}$ of g is thus contained in a $(2m-1)$ -dimensional affine subspace $U = U(g)$ of \mathbb{R}^{2m} . As

$$\sup_{z \in K} \|f(z) - g(z)\|_{\mathbb{R}^{2m}} \geq \sup_{z \in K} \inf_{u \in U(g)} \|f(z) - u\|_{\mathbb{R}^{2m}},$$

it is sufficient for our purposes to find a function $f \in C(\mathbb{C}^n; \mathbb{C}^m)$, a compact set $K \subset \mathbb{C}^n$, and a number $\varepsilon > 0$ such that

$$\inf_U \sup_{z \in K} \inf_{u \in U} \|f(z) - u\|_{\mathbb{R}^{2m}} \geq \varepsilon$$

where the outermost infimum traverses the $(2m-1)$ -dimensional affine subspaces U of \mathbb{R}^{2m} . This is achieved by a function f whose range $\{f(z) : z \in \mathbb{C}\}$ is not contained in any $(2m-1)$ -dimensional affine subspace U of \mathbb{R}^{2m} . A semi-explicit construction is like this:

Let $K := \{(\lambda, 0, \dots, 0) : \lambda \in \mathbb{R}, 0 \leq \lambda \leq 1\} \subseteq \mathbb{C}^n$ and

$$f_1 : \mathbb{C}^n \rightarrow [0, 1], \quad f_1(z_1, \dots, z_n) = \max\{0, \min\{1, \operatorname{Re}(z_1)\}\}.$$

Further let $f_2 : [0, 1] \rightarrow \mathbb{C}^m$ be a parameterization of a curve that along the edges of the cube $Q := [0, 1]^m + i[0, 1]^m \subseteq \mathbb{C}^m \cong \mathbb{R}^{2m}$ passes through all of its vertices $\{0, 1\}^m + i\{0, 1\}^m \subseteq \mathbb{C}^m \cong \mathbb{R}^{2m}$, and $f = f_2 \circ f_1$. From [3, Corollary 2.5], we deduce

$$\inf_U \sup_{z \in K} \inf_{u \in U} \|f(z) - u\|_{\mathbb{R}^{2m}} \geq \frac{1}{2}$$

and this finishes the proof. \square

Note that there are non-polyharmonic functions like $\varrho(z) = e^{\operatorname{Re}(z)}$ but also polyharmonic functions that are neither holomorphic, nor anti-holomorphic, nor \mathbb{R} -affine like $\varrho(z) = \operatorname{Re}(z)^2$ that meet the assumptions made in Theorem 6.4.

Following the ideas from [15, Proposition 4.15] we also want to add a short note on the necessity of the differentiability of the activation function. It turns out that the differentiability of the activation function is *not* a necessary condition for the fact that narrow networks with width $n + m + 1$ using this activation function have the universal approximation property. The proof is in fact identical to the proof presented in [15]. However, we include a detailed proof to clarify that the reasoning also works in the case of activation functions $\mathbb{C} \rightarrow \mathbb{C}$.

Theorem 6.5. *Take any function $w \in C(\mathbb{C}; \mathbb{C})$ which is bounded and nowhere real differentiable. Then $\varrho(z) := \sin(z) + w(z) \exp(-z)$ is also nowhere differentiable and $\mathcal{NN}_{n,m,n+m+1}^{\varrho}$ is universal.*

Proof. Since ϱ is non-polyharmonic (since it is nowhere differentiable) it suffices to show that the identity function can be uniformly approximated on compact sets using compositions of the form $\psi \circ \varrho \circ \phi$ with $\phi, \psi \in \operatorname{Aff}(\mathbb{C}; \mathbb{C})$. Then the statement can be derived similarly to the proof of Theorem 4.2(i).

Therefore, take any compact set $K \subseteq \mathbb{C}$ and $\varepsilon > 0$. Choose $M_1 > 0$ with $|z| \leq M_1$ for every $z \in K$. Take $h > 0$ arbitrary and consider

$$\sup_{z \in K \setminus \{0\}} \left| \frac{\sin(hz) - hz}{h} \right| \leq \sup_{z \in K \setminus \{0\}} M_1 \left| \frac{\sin(hz)}{hz} - 1 \right| \rightarrow 0$$

as $h \rightarrow 0$. Therefore, we may take $h > 0$ with

$$\left| \frac{\sin(hz) - hz}{h} \right| < \frac{\varepsilon}{2}$$

for every $z \in K$. Furthermore, choose $M_2 > 0$ with $|w(z)| \leq M_2$ for every $z \in K$ and pick $k \in \mathbb{N}$ large enough such that

$$\frac{|\exp(-hz)| |\exp(-2\pi k)|}{h} < \frac{\varepsilon}{2M_2}$$

for all $z \in K$. Hence we derive

$$\begin{aligned} & \left| \frac{\sin(hz + 2\pi k) + w(hz + 2\pi k) \exp(-hz - 2\pi k)}{h} - z \right| \\ &= \left| \frac{\sin(hz) + w(hz + 2\pi k) \exp(-hz - 2\pi k)}{h} - z \right| \\ &\leq \left| \frac{\sin(hz) - hz}{h} \right| + M_2 \frac{|\exp(-hz)| |\exp(-2\pi k)|}{h} < \varepsilon. \end{aligned}$$

Thus, we get the claim by defining $\phi(z) := hz + 2\pi k$ and $\psi(z) := \frac{1}{h}z$. \square

APPENDIX A. TOPOLOGICAL NOTES ON LOCALLY UNIFORM CONVERGENCE

In this appendix, we discuss the relationship between locally uniform convergence, the compact open topology, and the universal approximation property introduced in Definition 2.4. Note that [21, Appendix B] is another account on the same topic.

Although locally uniform convergence can be studied more generally for functions defined on a topological space and taking values in a metric space, we restrict ourselves to functions $\mathbb{C}^n \rightarrow \mathbb{C}^m$.

Definition A.1. Let $(f_k)_{k \in \mathbb{N}}$ be a sequence of functions $f_k : \mathbb{C}^n \rightarrow \mathbb{C}^m$ and $f : \mathbb{C}^n \rightarrow \mathbb{C}^m$. The sequence $(f_k)_{k \in \mathbb{N}}$ converges locally uniformly to f , if for every compact set $K \subseteq \mathbb{C}^n$ we have

$$\sup_{z \in K} \|f_k(z) - f(z)\|_{\mathbb{C}^m} \xrightarrow{k \rightarrow \infty} 0.$$

There is a certain equivalence between locally uniform convergence and the universal approximation property introduced in Definition 2.4.

Proposition A.2. Let $\mathcal{F} \subseteq C(\mathbb{C}^n; \mathbb{C}^m)$ and $f \in C(\mathbb{C}^n; \mathbb{C}^m)$. Then the following are equivalent:

(i) For every compact set $K \subseteq \mathbb{C}^n$ and $\varepsilon > 0$, there is a function $g \in \mathcal{F}$ satisfying

$$\|f - g\|_{C(K; \mathbb{C}^m)} < \varepsilon.$$

(ii) There is a sequence $(f_k)_{k \in \mathbb{N}}$ with $f_k \in \mathcal{F}$ for $k \in \mathbb{N}$ such that $(f_k)_{k \in \mathbb{N}}$ converges locally uniformly to f .

Proof. We start with the implication (i) \Rightarrow (ii). Let $f \in C(\mathbb{C}^n; \mathbb{C}^m)$. For every $k \in \mathbb{N}$, choose $f_k \in \mathcal{F}$ with

$$\|f_k - f\|_{C(\overline{B}_k(0); \mathbb{C}^m)} \leq \frac{1}{k}.$$

Then $(f_k)_{k \in \mathbb{N}}$ converges locally uniformly to f , since every compact set $K \subseteq \mathbb{C}^n$ is contained in $\overline{B}_k(0)$ for all $k \geq J$ for some $J \in \mathbb{N}$.

Now we show the implication (ii) \Rightarrow (i). For any compact set $K \subseteq \mathbb{C}^n$ and $\varepsilon > 0$ we know by definition of locally uniform convergence that there is $k \in \mathbb{N}$ satisfying

$$\|f_k - f\|_{C(K; \mathbb{C}^m)} < \varepsilon.$$

Since $f_k \in \mathcal{F}$, this shows (i). \square

In particular, Proposition A.2 yields the following equivalence:

(i') The set \mathcal{F} has the universal approximation property.

(ii') For every $f \in C(\mathbb{C}^n; \mathbb{C}^m)$, there is a sequence $(f_k)_{k \in \mathbb{N}}$ of elements $f_k \in \mathcal{F}$ such that $(f_k)_{k \in \mathbb{N}}$ converges locally uniformly to f .

Next, we show that locally uniform convergence of sequences $(f_k)_{k \in \mathbb{N}}$ of elements $f_k \in C(\mathbb{C}^n; \mathbb{C}^m)$ coincides with convergence with respect to the *compact-open topology*, cf. [8, Definition XII.1.1]. Hence, the compact-open topology is the topology in charge when we speak about universality of a set of continuous functions.

Definition A.3. For each pair of sets $A \subseteq \mathbb{C}^n, B \subseteq \mathbb{C}^m$, we denote

$$(A, B) := \{f \in C(\mathbb{C}^n; \mathbb{C}^m) : f(A) \subseteq B\}.$$

The *compact-open topology* on $C(\mathbb{C}^n; \mathbb{C}^m)$ is then the smallest topology containing the sets (K, V) , where $K \subseteq \mathbb{C}^n$ is compact and $V \subseteq \mathbb{C}^m$ is open.

That this topology indeed induces locally uniform convergence is a direct consequence of [8, Theorem XII.7.2] and \mathbb{C}^m being a metric space.

Proposition A.4. Let $(f_k)_{k \in \mathbb{N}}$ be a sequence of functions with $f_k \in C(\mathbb{C}^n; \mathbb{C}^m)$ and $f \in C(\mathbb{C}^n; \mathbb{C}^m)$. Then the following statements are equivalent.

- (i) The sequence $(f_k)_{k \in \mathbb{N}}$ converges to f in the compact-open topology.
- (ii) The sequence $(f_k)_{k \in \mathbb{N}}$ converges to f locally uniformly.

In the present paper, it is of particular importance that the composition of functions is compatible with locally uniform convergence.

Proposition A.5. Let $(f_k)_{k \in \mathbb{N}}$ and $(g_k)_{k \in \mathbb{N}}$ be two sequences of functions with $f_k \in C(\mathbb{C}^{n_1}; \mathbb{C}^{n_2})$ and $g_k \in C(\mathbb{C}^{n_2}; \mathbb{C}^{n_3})$ for $k \in \mathbb{N}$. Let $f \in C(\mathbb{C}^{n_1}; \mathbb{C}^{n_2})$ and $g \in C(\mathbb{C}^{n_2}; \mathbb{C}^{n_3})$ such that $f_k \rightarrow f$ and $g_k \rightarrow g$ locally uniformly. Then we have

$$g_k \circ f_k \xrightarrow{k \rightarrow \infty} g \circ f$$

locally uniformly.

Proof. Using [8, Theorem XII.2.2], we know that the map

$$C(\mathbb{C}^{n_1}; \mathbb{C}^{n_2}) \times C(\mathbb{C}^{n_2}; \mathbb{C}^{n_3}) \rightarrow C(\mathbb{C}^{n_1}; \mathbb{C}^{n_3}), \quad (h_1, h_2) \mapsto h_2 \circ h_1$$

is continuous, where each space $C(\mathbb{C}^{n_j}; \mathbb{C}^{n_k})$ is equipped with the compact-open topology and Cartesian products of spaces are equipped with the product topology. Note here that we use the fact that \mathbb{C}^{n_1} and \mathbb{C}^{n_3} are Hausdorff spaces and \mathbb{C}^{n_2} is locally compact. Then the claim follows from Proposition A.4. \square

Note that the statement of Proposition A.5 can inductively be extended to the composition of L functions, where L is any natural number.

APPENDIX B. TAYLOR EXPANSION USING WIRTINGER DERIVATIVES

In this appendix we give some details about the Taylor expansion introduced in Lemma 2.1. Furthermore we show that an activation function which is not \mathbb{R} -affine necessarily admits a point where one of the second-order Wirtinger derivatives does not vanish. We begin by restating and proving Lemma 2.1.

Lemma B.1. Let $\varrho \in C(\mathbb{C}; \mathbb{C})$ and $z, z_0 \in \mathbb{C}$. If ϱ is real differentiable in z_0 , then

$$\varrho(z + z_0) = \varrho(z_0) + \partial_{\text{wirt}} \varrho(z_0) z + \bar{\partial}_{\text{wirt}} \varrho(z_0) \bar{z} + \Theta_1(z) \tag{B.1}$$

for a function $\Theta_1 : \mathbb{C} \rightarrow \mathbb{C}$ with $\lim_{\mathbb{C} \setminus \{0\} \ni z \rightarrow 0} \frac{\Theta_1(z)}{z} = 0$. If $\varrho \in C^2(\mathbb{C}; \mathbb{C})$, then

$$\varrho(z + z_0) = \varrho(z_0) + \partial_{\text{wirt}} \varrho(z_0) z + \bar{\partial}_{\text{wirt}} \varrho(z_0) \bar{z} + \frac{1}{2} \partial_{\text{wirt}}^2 \varrho(z_0) z^2 + \partial_{\text{wirt}} \bar{\partial}_{\text{wirt}} \varrho(z_0) z \bar{z} + \frac{1}{2} \bar{\partial}_{\text{wirt}}^2 \varrho(z_0) \bar{z}^2 + \Theta_2(z) \tag{B.2}$$

for a function $\Theta_2 : \mathbb{C} \rightarrow \mathbb{C}$ with $\lim_{\mathbb{C} \setminus \{0\} \ni z \rightarrow 0} \frac{\Theta_2(z)}{z^2} = 0$.

Proof. Equation (B.1) follows from the definition of real differentiability (2.1) by using

$$\frac{\partial \varrho}{\partial x}(z_0) \operatorname{Re}(z) + \frac{\partial \varrho}{\partial y}(z_0) \operatorname{Im}(z) = \frac{\partial \varrho}{\partial x}(z_0) \cdot \frac{1}{2}(z + \bar{z}) + \frac{\partial \varrho}{\partial y} \cdot \frac{1}{2i}(z - \bar{z}) = \partial_{\text{wirt}} \varrho(z_0) z + \bar{\partial}_{\text{wirt}} \varrho(z_0) \bar{z}.$$

In order to prove (B.2) we use the second-order Taylor expansion of ϱ around z_0 which can be found for instance in [1, Theorem VII.5.11] and obtain

$$\varrho(z + z_0) = \varrho(z_0) + \frac{\partial \varrho}{\partial x}(z_0)x + \frac{\partial \varrho}{\partial y}(z_0)y + \frac{1}{2} \frac{\partial^2 \varrho}{\partial x^2}(z_0)x^2 + \frac{\partial^2 \varrho}{\partial x \partial y}(z_0)xy + \frac{1}{2} \frac{\partial^2 \varrho}{\partial y^2}(z_0)y^2 + \Theta_2(z)$$

where $\Theta_2 : \mathbb{C} \rightarrow \mathbb{C}$ satisfies $\lim_{\mathbb{C} \setminus \{0\} \ni z \rightarrow 0} \frac{\Theta_2(z)}{z^2} = 0$. Furthermore, we use the notation $x = \operatorname{Re}(z)$ and $y = \operatorname{Im}(z)$. Letting $x = \frac{1}{2}(z + \bar{z})$, $y = \frac{1}{2i}(z - \bar{z})$ and using

$$\frac{1}{4} \cdot \begin{pmatrix} 1 & -2i & -1 \\ 1 & 0 & 1 \\ 1 & 2i & -1 \end{pmatrix} \begin{pmatrix} \frac{\partial^2}{\partial x^2} \\ \frac{\partial^2}{\partial x \partial y} \\ \frac{\partial^2}{\partial y^2} \end{pmatrix} = \begin{pmatrix} \partial_{\text{wirt}}^2 \\ \partial_{\text{wirt}} \bar{\partial}_{\text{wirt}} \\ \bar{\partial}_{\text{wirt}}^2 \end{pmatrix} \quad (\text{B.3})$$

yields the claim. \square

The following Proposition is required in the proof of Proposition 3.2.

Proposition B.2. *Let $\varrho \in C^2(\mathbb{C}; \mathbb{C})$ be not \mathbb{R} -affine. Then there is a point $z_0 \in \mathbb{C}$ such that either $\partial_{\text{wirt}}^2 \varrho(z_0) \neq 0$, $\partial_{\text{wirt}} \bar{\partial}_{\text{wirt}} \varrho(z_0) \neq 0$ or $\bar{\partial}_{\text{wirt}}^2 \varrho(z_0) \neq 0$.*

Proof. Assume $\partial_{\text{wirt}}^2 \varrho \equiv \partial_{\text{wirt}} \bar{\partial}_{\text{wirt}} \varrho \equiv \bar{\partial}_{\text{wirt}}^2 \varrho \equiv 0$. From the fact that the matrix on the left-hand side in (B.3) is invertible it follows $\frac{\partial^2 \varrho}{\partial x^2} \equiv \frac{\partial^2 \varrho}{\partial x \partial y} \equiv \frac{\partial^2 \varrho}{\partial y^2} \equiv 0$. Since ϱ is \mathbb{R} -affine if and only if $\operatorname{Re}(\varrho)$ and $\operatorname{Im}(\varrho)$ are both \mathbb{R} -affine, we may assume that ϱ is real-valued. It is a well-known fact that a C^1 -function with vanishing gradient is necessarily constant. Applying this fact to $\frac{\partial \varrho}{\partial x}$ and $\frac{\partial \varrho}{\partial y}$ separately shows

$$\nabla \varrho \equiv a$$

for a constant $a \in \mathbb{R}^2$. Let $f(z) := z^\top a$ where $z \in \mathbb{C}$ is treated as an element of \mathbb{R}^2 . Then the gradient of $\varrho - f$ vanishes identically and hence it holds $\varrho - f \equiv b$ for a constant $b \in \mathbb{R}$. This yields

$$\varrho(z) = z^\top a + b \quad \text{for all } z \in \mathbb{C}.$$

But then ϱ is \mathbb{R} -affine. \square

Acknowledgements. The authors thank Felix Voigtlaender for helpful comments. PG acknowledges support by the German Science Foundation (DFG) in the context of the Emmy Noether junior research group VO 2594/1-1.

REFERENCES

- [1] H. Amann and J. Escher, *Analysis. II*, Birkhäuser Verlag, Basel, 2008
- [2] M. Arjovsky, A. Shah, and Y. Bengio, *Unitary evolution recurrent neural networks*, International conference on machine learning, PMLR, 2016, pp. 1120–1128
- [3] R. Brandenburg, *Radii of regular polytopes*, Discrete Comput. Geom. **33** (2005), no. 1, pp. 43–55, DOI: 10.1007/s00454-004-1127-1
- [4] C. Bueno, *Universal approximation for neural nets on sets*, PhD thesis, University of California, Santa Barbara, 2021
- [5] Y. Cai, *Achieve the minimum width of neural networks for universal approximation*, arXiv preprint, 2022, arXiv: 2209.11395
- [6] A. Caragea, D. G. Lee, J. Maly, G. Pfander, and F. Voigtlaender, *Quantitative approximation results for complex-valued neural networks*, SIAM J. Math. Data Sci. **4** (2022), no. 2, pp. 553–580, DOI: 10.1137/21M1429540
- [7] G. Cybenko, *Approximation by superpositions of a sigmoidal function*, Math. Control Signals Systems **2** (1989), no. 4, pp. 303–314, DOI: 10.1007/BF02551274
- [8] J. Dugundji, *Topology*, Allyn and Bacon, Inc., Boston, MA, 1966
- [9] G. B. Folland, *Real analysis: modern techniques and their applications*, 2nd ed ed., Pure and applied mathematics, Wiley, New York, 1999

- [10] P. Geuchen and F. Voigtlaender, *Optimal approximation of C^k -functions using shallow complex-valued neural networks*, arXiv preprint, 2023, arXiv: 2303.16813
- [11] R. Gribonval, G. Kutyniok, M. Nielsen, and F. Voigtlaender, *Approximation spaces of deep neural networks*, *Constr. Approx.* **55** (2022), no. 1, pp. 259–367, DOI: 10.1007/s00365-021-09543-4
- [12] A. Hirose (ed.), *Complex-valued neural networks: Advances and applications*, IEEE Press Series on Computational Intelligence, IEEE Press, Piscataway, NJ; John Wiley & Sons, Inc., Hoboken, NJ, 2013
- [13] V. E. Ismailov and E. Savas, *Measure theoretic results for approximation by neural networks with limited weights*, *Numer. Funct. Anal. Optim.* **38** (2017), no. 7, pp. 819–830, DOI: 10.1080/01630563.2016.1254654
- [14] L. Kaup and B. Kaup, *Holomorphic functions of several variables: An introduction to the fundamental theory*, *De Gruyter Studies in Mathematics*, vol. 3, Walter de Gruyter & Co., Berlin, 1983, DOI: 10.1515/9783110838350
- [15] P. Kidger and T. Lyons, *Universal approximation with deep narrow networks*, *Proceedings of Thirty Third Conference on Learning Theory (J. Abernethy and S. Agarwal, eds.)*, vol. 125, 2020, pp. 2306–2327, <https://proceedings.mlr.press/v125/kidger20a.html>
- [16] X. Li and G. Wang, *Universal approximation of polygonal fuzzy neural networks in sense of K -integral norms*, *Sci. China Inf. Sci.* **54** (2011), no. 11, pp. 2307–2323, DOI: 10.1007/s11432-011-4364-y
- [17] Zh. Lu, H. Pu, F. Wang, Zh. Hu, and L. Wang, *The expressive power of neural networks: a view from the width*, *Advances in Neural Information Processing Systems (I. Guyon, U. Von Luxburg, S. Bengio, H. Wallach, R. Fergus, S. Vishwanathan, and R. Garnett, eds.)*, Curran Associates, Inc., 2017, pp. 1–9, <https://proceedings.neurips.cc/paper/2017/file/32cbf687880eb1674a07bf717761dd3a-Paper.pdf>
- [18] T. Merkh and G. Montúfar, *Stochastic feedforward neural networks: universal approximation*, arXiv preprint, 2019, arXiv: 1910.09763
- [19] N. Murata and S. Sonoda, *Neural network with unbounded activation functions is universal approximator*, *Appl. Comput. Harmon. Anal.* **43** (2017), no. 2, pp. 233–268, DOI: 10.1016/j.acha.2015.12.005
- [20] T. Nitta, *Complex-valued neural networks: Utilizing high-dimensional parameters*, Information Science Reference, New York, NJ, 2009
- [21] J. Park and S. Wojtowytsch, *Qualitative neural network approximation over \mathbb{R} and \mathbb{C} : elementary proofs for analytic and polynomial activation*, arXiv preprint, 2022, arXiv: 2203.13410
- [22] S. Park, C. Yun, J. Lee, and J. Shin, *Minimum width for universal approximation*, arXiv preprint, 2020, arXiv: 2006.08859
- [23] P. Petersen and F. Voigtlaender, *Equivalence of approximation by convolutional neural networks and fully-connected networks*, *Proc. Amer. Math. Soc.* **148** (2020), no. 4, pp. 1567–1581, DOI: 10.1090/proc/14789
- [24] A. Pinkus, *Approximation theory of the MLP model in neural networks*, *Acta numerica*, 1999, *Acta Numer.*, vol. 8, Cambridge Univ. Press, Cambridge, 1999, pp. 143–195, DOI: 10.1017/S0962492900002919
- [25] W. Rudin, *Principles of mathematical analysis*, third ed., International Series in Pure and Applied Mathematics, McGraw-Hill Book Co., New York-Auckland-Düsseldorf, 1976
- [26] ———, *Real and complex analysis*, third ed., McGraw-Hill Book Co., New York, 1987
- [27] P. Virtue, S. X. Yu, and M. Lustig, *Better than real: Complex-valued neural nets for mri fingerprinting*, 2017 IEEE international conference on image processing (ICIP), IEEE, 2017, pp. 3953–3957
- [28] F. Voigtlaender, *The universal approximation theorem for complex-valued neural networks*, *Appl. Comput. Harmon. Anal.* **64** (2023), pp. 33–61, DOI: 10.1016/j.acha.2022.12.002
- [29] D. Yarotsky, *Universal approximations of invariant maps by neural networks*, *Constr. Approx.* **55** (2022), no. 1, pp. 407–474, DOI: 10.1007/s00365-021-09546-1
- [30] D.-X. Zhou, *Universality of deep convolutional neural networks*, *Appl. Comput. Harmon. Anal.* **48** (2020), no. 2, pp. 787–794, DOI: 10.1016/j.acha.2019.06.004

(P. Geuchen) MATHEMATICAL INSTITUTE FOR MACHINE LEARNING AND DATA SCIENCE (MIDS), CATHOLIC UNIVERSITY OF EICHSTÄTT–INGOLSTADT (KU), AUF DER SCHANZ 49, 85049 INGOLSTADT, GERMANY
Email address: paul.geuchen@ku.de

(T. Jahn) MATHEMATICAL INSTITUTE FOR MACHINE LEARNING AND DATA SCIENCE (MIDS), CATHOLIC UNIVERSITY OF EICHSTÄTT–INGOLSTADT (KU), AUF DER SCHANZ 49, 85049 INGOLSTADT, GERMANY
Email address: thomas.jahn@ku.de

(H. Matt) MATHEMATICAL INSTITUTE FOR MACHINE LEARNING AND DATA SCIENCE (MIDS), CATHOLIC UNIVERSITY OF EICHSTÄTT–INGOLSTADT (KU), AUF DER SCHANZ 49, 85049 INGOLSTADT, GERMANY
Email address: hannes.matt@ku.de