

# Segmented GRAND: Combining Sub-patterns in Near-ML Order

Mohammad Rowshan, *Member, IEEE* and Jinhong Yuan, *Fellow, IEEE*

**Abstract**—The recently introduced maximum-likelihood (ML) decoding scheme called guessing random additive noise decoding (GRAND) has demonstrated a remarkably low time complexity in high signal-to-noise ratio (SNR) regimes. However, the complexity is not as low at low SNR regimes and low code rates. To mitigate this concern, we propose a scheme for a near-ML variant of GRAND called ordered reliability bits GRAND (or ORBGRAND), which divides codewords into segments based on the properties of the underlying code, generates sub-patterns for each segment consistent with the syndrome (thus reducing the number of inconsistent error patterns generated), and combines them in a near-ML order using two-level integer partitions of logistic weight. The numerical evaluation demonstrates that the proposed scheme, called segmented ORBGRAND, significantly reduces the average number of queries at any SNR regime. Moreover, the segmented ORBGRAND with abandonment also improves the error correction performance.

**Index Terms**—Error pattern, segment, integer partition, guessing random additive noise decoding, GRAND, ORBGRAND, ordered statistics decoding, maximum likelihood decoding, complexity.

## I. INTRODUCTION

Soft decision-based decoding algorithms can be classified into two major categories [1]: Code structure-based algorithms and reliability-based algorithms or generic decoding algorithms as they usually do not depend on the code structure. In the generic algorithms a.k.a universal algorithms, which is the focus of this paper, the goal is to find the closest modulated codeword to the received sequence using a metric such as the likelihood function. That is, we try to maximize the likelihood in the search towards finding the transmitted sequence. Hence, this category of decoding algorithm is called maximum likelihood (ML) decoding which is known as an optimal decoding approach. Maximum likelihood decoding has been an attractive subject for decades among researchers. Error sequence generation is one of the central problems in any ML decoding scheme. The brute-force approach for ML decoding of a linear  $(n, k)$  block code requires the computation of likelihood or Euclidean distances of  $2^k$  modulated codewords from the received sequence. In general, ML decoding is prohibitively complex for most codes as it was shown to be an NP-complete problem [2]. Hence, the main effort of the researchers has been concentrated on reducing the algorithm's complexity for short block-lengths. Although there are approaches in which the optimal performance is preserved, the ML performance

can be traded off for a significant complexity reduction. Here, we review some of the notable efforts toward complexity reduction in the past decades.

Forney proposed the generalized minimum distance (GMD) decoding algorithm in 1966 [3], where a list of candidate codewords based on the reliability of the received symbols was produced using an algebraic decoder. In 1972, Chase proposed a method [4] in which the search was performed among a fixed number of the error patterns corresponding to a particular number of least reliable bit positions with respect to the minimum distance  $d$  of the underlying code. Chase classified his algorithm into three types, as per the error pattern generation. In another effort, Snyders and Be'ery in 1989 [5] proposed to perform syndrome decoding on the received sequence and then use the syndrome information to modify and improve the original hard-decision decoding.

The best-known generic decoding algorithm is perhaps the information set decoding (ISD) algorithm proposed by Prange in 1962 [6], which was improved by Stern in 1989 [7] and Dumer in 1991 [8]. Following this approach, other generic decoding approaches were developed based on the most reliable basis (MRB), defined as the support of the most reliable independent positions (MRIPs) of the received sequence, hence forming an information set. In these approaches, each error pattern is subtracted from the hard decision of the MRIPs and the corresponding codeword is reconstructed by encoding the corresponding information sequence. In 1974, Dorsch [9] considered error patterns restricted to the MRB in increasing a priori likelihood. Following this approach, Fossorier and Lin in 1995 [10] proposed processing the error patterns in a deterministic order within families of increasing Hamming weight. This algorithm, which is referred to as ordered statistics decoding (OSD), is one of the most popular generic decoding algorithms nowadays. The OSD algorithm permutes the columns of the generator matrix with respect to the reliability of the symbols for every received vector and performs elementary row operations on the independent columns extracted from the permuted generator matrix resulting in the systematic form. The testing error patterns can have a Hamming weight of up to  $l$ ,  $0 \leq l \leq k$  in  $l$ -order OSD, chosen from the most reliable  $k$  positions. Apparently, the main drawback of OSD is the use of row operations to put either the generator matrix or the parity check matrix of the code into systematic form. The complexity of row operation for an  $(n, k)$  linear block code is  $O(n^3 \min\{R, 1 - R\}^2)$  where  $R$  is the code rate. However, since overall complexity is an exponential function of code

Mohammad Rowshan and Jinhong Yuan are with the school of electrical engineering and Telecommunications, University of New South Wales (UNSW) in Sydney, Australia. (e-mail: {m.rowshan,j.yuan}@unsw.edu.au).

length, this preprocessing complexity is negligible. Moreover, having information set in a systematic form is needed only for simplifying further the decoding attempts. Otherwise, the error patterns can be checked without this preprocessing. The OSD algorithm further evolved in 2004 into box-and-match algorithm (BMA) [11] and enhanced BMA [12] where the matching technique was used to reduce time complexity at the cost of space complexity. The matching techniques were employed for fast decoding of polar codes with Reed-Solomon kernel in [13]. It is worth noting that a similar algorithm to BMA, called the sort and match algorithm, was proposed by Dumer in 1991 in [14], [15] which has the same asymptotic complexity as BMA.

In 2018, Duffy et al. [16] suggested a hard-decision scheme in which the error patterns were ordered from most likely to least likely ones based on a statistical channel model, and then the incorrect error patterns were sequentially removed, querying for the first error patterns corresponding to a valid codeword. This original idea, which was later called *guessing random additive noise decoding* (GRAND), further developed into a soft decision scheme or sGRAND where the error patterns were generated based on the symbols' reliability and sequential insertion and removal of the error patterns from an ordered stack until the first valid codeword was found. The sGRAND was shown to be capacity achieving [17] and ML algorithm [18] though it came at a significant computational complexity cost because the error patterns in the stack needed to be sorted after insertion of new patterns into the stack. The approach used in GRAND appears to align with a general optimum technique proposed in [19] to handle the pattern generation with monotonicity [20]. The next evolution in this approach occurred by employing a simple metric that gave the error patterns for testing in a near ML order [21]. This step was a significant boost for GRAND toward making it practical for high rate and short codes. The approximate scheduling of the error sequences is based on distinct integer partitioning of positive integers which is significantly less complex. Alternatively, a sequential algorithmic method to generate error sequences was suggested based on partial ordering and a modified logistic weight in [23] that prioritizes the low-weight error sequences resulting in improving the performance though its pattern generation process is not as simple as integer partitioning process. Several hardware architectures have also been proposed for ORBGRAND in [24], [25], [26], [27].

The main advantage of ORBGRAND is its simplicity in the generation of error patterns in an order near ML by a simple weight function that makes a hardware-friendly algorithm. Unlike some of the other schemes, it does not require any preprocessing, or sorting (except for the reliability order) and it has inherently an early termination mechanism in itself that stops searching after finding the most likely codeword or near that. However, the number of invalid error patterns is significantly high. The aim of this work and our previous work in [28] was to reduce invalid patterns and save computations and time. In constrained GRAND [28], by simply utilizing the structure of a binary linear code, we proposed an efficient

pre-evaluation that constrains the error pattern generation. This approach could save the codebook checking operation. These syndrome-based constraints are extracted from the parity check matrix (with or without matrix manipulation) of the underlying code. We also showed that the size of the search space deterministically reduces by a factor of  $2^p$  where  $p$  is the number of constraints. Note that the constrained error sequence generation does not degrade the error correction performance as it is just discarding the error sequences that do not result in valid codewords. The proposed approach could be applied to other GRAND variants such as SGRAND [18].

In this paper, different from [28], we propose an approach that generates sub-patterns for the segments corresponding to the defined constraints. We simultaneously generate sub-patterns for each segment with odd or even weight, guided by the available information from the syndrome, otherwise with both weights. To address the challenging problem of combining the sub-patterns in an ML order, we propose a customized partition (a.k.a composition [29]) of the logistic weight into segment-specific sub-weights. This composition involves partitioning the logistic weight into non-distinct positive integers, with the number of parts (a.k.a composition order) restricted to the number of segments. Furthermore, our approach allows for zero to be included as an element in the composition. The numerical results show that by employing the proposed method, the average number of attempts reduces significantly compared with the conventional ORBGRAND (i.e., the ORBGRAND without segmentation). This reduction is justified by the expectation of a reduction in search space. Furthermore, we show how this approach can improve the block error rate when employing segmented ORBGRAND with abandonment.

## II. PRELIMINARIES

We denote by  $\mathbb{F}_2$  the binary finite field with two elements. The cardinality of a set is denoted by  $|\cdot|$ . The interval  $[a, b]$  represents the set of all integer numbers in  $\{x : a \leq x \leq b\}$ . The *support* of a vector  $\mathbf{e} = (e_1, \dots, e_n) \in \mathbb{F}_2^n$  is the set of indices where  $\mathbf{e}$  has a nonzero coordinate, i.e.  $\text{supp}(\mathbf{e}) \triangleq \{i \in [1, n] : e_i \neq 0\}$ . The *weight* of a vector  $\mathbf{e} \in \mathbb{F}_2^n$  is  $w(\mathbf{e}) \triangleq |\text{supp}(\mathbf{e})|$ . The all-one vector  $\mathbf{1}$  and all-zero vector  $\mathbf{0}$  are defined as vectors with all identical elements of 1 or 0, respectively. The summation in  $\mathbb{F}_2$  is denoted by  $\oplus$ . The modulo operation (to get the remainder of a division) is denoted by  $\%$ .

### A. ML Decoding and ORBGRAND

A binary code  $\mathcal{C}$  of length  $n$  and dimension  $k$  maps a message of  $k$  bits into a codeword  $\mathbf{c}$  of  $n$  bits to be transmitted over a noisy channel. We assume that we are using binary phase shift keying (BPSK) modulation. The channel alters the transmitted codeword such that the receiver obtains an  $n$ -symbol vector  $\mathbf{r}$ . A ML decoder supposedly compares  $\mathbf{r}$  with all the  $2^k$  modulated codewords in the codebook, and selects

the one closest to  $\mathbf{r}$ . In other words, the ML decoder finds a modulated codeword  $\mathbf{x}(\mathbf{c})$  such that

$$\hat{\mathbf{c}} = \arg \max_{\mathbf{c} \in \mathcal{C}} p(\mathbf{r}|\mathbf{x}(\mathbf{c})). \quad (1)$$

For additive white Gaussian noise (AWGN) channel with noise power of  $\sigma_n^2 = N_0/2$  where  $N_0$  is the noise spectral density, the conditional probability  $p(\mathbf{r}|\mathbf{x}(\mathbf{c}))$  is given by

$$p(\mathbf{r}|\mathbf{x}(\mathbf{c})) = \frac{1}{(\sqrt{\pi N_0})^n} \exp\left(-\sum_{i=1}^n (r_i - x(c_i))^2/N_0\right). \quad (2)$$

Observe that maximizing  $p(\mathbf{r}|\mathbf{x}(\mathbf{c}))$  is equivalent to minimizing

$$d_E^2 = \sum_{i=1}^n (r_i - x(c_i))^2, \quad (3)$$

which is called *squared Euclidean distance* (SED). Therefore, we have

$$\hat{\mathbf{c}} = \arg \max_{\mathbf{c} \in \mathcal{C}} p(\mathbf{r}|\mathbf{x}(\mathbf{c})) = \arg \min_{\mathbf{c} \in \mathcal{C}} (\mathbf{r} - \mathbf{x}(\mathbf{c}))^2. \quad (4)$$

The process of finding  $\mathbf{c}$ , depending on the scheme we employ, may require checking possibly a large number of binary error sequences  $\hat{\mathbf{e}}$  to select the one that satisfies

$$\mathbf{H} \cdot (\theta(\mathbf{r}) \oplus \hat{\mathbf{e}}) = \mathbf{0} \quad (5)$$

where  $\theta(\mathbf{r})$  returns the hard-decision demodulation of the received vector  $\mathbf{r}$  and  $\mathbf{H}$  is the parity check matrix of code  $\mathcal{C}$ ,

$$\mathbf{H} = [\mathbf{h}_1 \mathbf{h}_2 \cdots \mathbf{h}_{n-k}]^T \quad (6)$$

and the  $n$ -element row vectors  $\mathbf{h}_j$  for  $j \in [1, n-k]$  are denoted by  $\mathbf{h}_j = [h_{j,1} \ h_{j,2} \ \cdots \ h_{j,n}]$ . Note that any valid codeword  $\mathbf{c} = \theta(\mathbf{r}) \oplus \hat{\mathbf{e}}$  gives  $\mathbf{H} \cdot \mathbf{c} = \mathbf{0}$ . Here,  $\hat{\mathbf{e}}$  is the binary error sequence that we refer to it as an error pattern in the rest of the paper.

To get the error patterns in ML order, one can 1) generate all possible error patterns  $\hat{\mathbf{e}}$ , that is,  $\sum_{j=1}^n \binom{n}{j}$  patterns, 2) sort them based on a likelihood measure such as the squared Euclidean distance  $(\mathbf{r} - \mathbf{x}(\theta(\mathbf{r}) \oplus \hat{\mathbf{e}}))^2$ , and then 3) check them using (5) one by one from the smallest distance in ascending order. It was numerically shown in [21] that the error patterns generated by all the integer partitions of *logistic weights*  $w_L = 1, 2, \dots, n(n+1)/2$  can give an order close to what we describe earlier. Obviously, the latter method, which is used in ORBGRAND, is more attractive as it does not need any sorting operation over a large set of metrics at every decoding step.

The logistic weight  $w_L$  of a length- $n$  binary vector  $\mathbf{z}$  is defined as [21]

$$w_L(\mathbf{z}) = \sum_{i=1}^n z_i \cdot i \quad (7)$$

where  $z_i \in \mathbb{F}_2$  is the  $i$ -th element of the error pattern  $\hat{\mathbf{e}}$  permuted in the ascending order of the received symbols' reliability  $|r_i|, i \in [1, n]$ . That is, the error pattern is  $\hat{\mathbf{e}} = \pi(\mathbf{z})$  where  $\pi(\cdot)$  is the vector-wise permutation function which maps binary vector  $\mathbf{z}$  to error pattern  $\hat{\mathbf{e}}$ . For element-wise mapping

of this permutation, we will use  $\hat{\pi}(\cdot)$  for mapping the index of any elements in  $\mathbf{z}$  to the corresponding element in  $\hat{\mathbf{e}}$  and  $\hat{\pi}^{-1}(\cdot)$  for the reverse mapping. For the sake of simplicity, we refer to  $w_L(\mathbf{z})$  by  $w_L$ .

To get all binary vectors  $\mathbf{z}$  corresponding to a certain  $w_L$ , there is a simple approach. All coordinates  $j$  in  $\mathbf{z}$ , where  $z_j = 1$  for a certain  $w_L$ , can be obtained from *integer partitions* of  $w_L$  with distinct parts and no parts being larger than the code length  $n$ . Let us define the integer partitions of  $w_L$  mathematically as follows:

**Definition 1.** The integer partitions of  $w_L$  are the elements of any subset  $\mathcal{I} \subset [1, w_L]$  such that

$$w_L = \sum_{j \in \mathcal{I} \subset [1, w_L]} j. \quad (8)$$

Then, the binary vector  $\mathbf{z}$  corresponding to any  $\mathcal{I}$  consists of the elements  $z_j = 1, j \in \mathcal{I}$  and  $z_j = 0, j \notin \mathcal{I}$ .

In Definition 1, we abused the notion of integer partitions and considered a single part/partition as well to cover all the error patterns obtained from every  $w_L$ . Observe that for every  $w_L$ , there exists at least one  $\mathcal{I}$  with a single element  $w_L$ . For instance, for  $w_L = 1, 2$ , we have a single  $\mathcal{I} = \{w_L\}$ . As  $w_L$  gets larger, the number of subsets  $\mathcal{I} \subset [1, w_L]$  increases.

**Example 1.** Suppose we have the received sequence  $\mathbf{r} = [0.5, -1.2, 0.8, 1.8, -1, -0.2, 0.7, -0.9]$ .

We can get the following permutation based on  $|r_i|, i \in [1, 8]$  in ascending order:

$$\hat{\pi} : [1, 2, 3, 4, 5, 6, 7, 8] \rightarrow [6, 1, 7, 3, 8, 5, 2, 4]$$

Assuming we have attempted all the error patterns generated based on  $w_L = 1, 2, 3, 4, 5$  so far. Then, we need to find the error patterns based on  $w_L = 6$ . The integer partitions of  $w_L = 6$  are  $\mathcal{I} = \{6\}, \{1, 5\}, \{2, 4\}$ , and  $\{1, 2, 3\}$  that satisfy  $w_L = \sum_{j \in \mathcal{I}} j, \mathcal{I} \subset [1, 6]$ . We call every element in  $\mathcal{I}$  as a *part*. Then, the  $\mathbf{z}$  vector and the corresponding error patterns after the vector permutation  $\pi$  are

$$\mathbf{z} = [0 \ 0 \ 0 \ 0 \ 0 \ 1 \ 0 \ 0] \rightarrow \hat{\mathbf{e}} = [0 \ 0 \ 0 \ 0 \ 1 \ 0 \ 0 \ 0],$$

$$\mathbf{z} = [1 \ 0 \ 0 \ 0 \ 1 \ 0 \ 0 \ 0] \rightarrow \hat{\mathbf{e}} = [0 \ 0 \ 0 \ 0 \ 0 \ 1 \ 0 \ 1],$$

$$\mathbf{z} = [0 \ 1 \ 0 \ 1 \ 0 \ 0 \ 0 \ 0] \rightarrow \hat{\mathbf{e}} = [1 \ 0 \ 1 \ 0 \ 0 \ 0 \ 0 \ 0],$$

$$\mathbf{z} = [1 \ 1 \ 1 \ 0 \ 0 \ 0 \ 0 \ 0] \rightarrow \hat{\mathbf{e}} = [1 \ 0 \ 0 \ 0 \ 0 \ 1 \ 1 \ 0].$$

These error patterns can be checked using (5) in an arbitrary order. In the next section, we will see that any of these error patterns results in an identical increase in  $d_E^2$  in (3), i.e., they are all located at an identical distance from the received sequence, under some assumption about the distribution of  $|r_i|, i \in [1, n]$ .

**Remark 1.** By statistically analyzing the reliability of the received sequence or any other insight, one can prioritize the low Hamming weight  $\hat{\mathbf{e}}, w_H(\hat{\mathbf{e}})$ 's over large Hamming weight ones, or vice versa. Alternatively, we can limit the scope of attempts to small or large low Hamming weight  $\hat{\mathbf{e}}$ 's. Observe

that as the logistic weight increases, the error patterns with larger Hamming weight can be generated.

### III. NEAR-ML ORDERING OF ERROR PATTERNS WITH LOGISTIC WEIGHT

In this section, we investigate analytically how the error patterns in the ascending order of the logistic weight can follow closely the maximum likelihood order over the AWGN channel. The analysis is based on an assumption made for OR-BGRAND [22], which is in disagreement with the Gaussian distribution in AWGN channel. This assumption is also a basis to devise a similar approach for combining the sub-patterns in the segmented GRAND in Section V.

**Assumption 1.** We assume that the ordered sequence of  $|r_i|, i = 1, 2, \dots, n$  as

$$|r_1| \leq |r_2| \leq |r_3| \leq \dots$$

are placed equidistantly. That is,

$$\delta = |r_{i+1}| - |r_i| = |r_{i+2}| - |r_{i+1}| = \dots$$

Additionally, for some  $\rho \geq 0$ , we define

$$|r_i| = \rho + i \cdot \delta.$$

Now, let us get back to the Euclidean distance. The squared Euclidean distance (SED) as a function of  $\mathbf{z}$  denoted by  $d_E^2(\mathbf{z})$  is

$$d_E^2(\mathbf{z}) = \sum_{i=1}^n (r_i - \mathbf{x}(\theta(r_i) \oplus z_i))^2. \quad (9)$$

and for  $\mathbf{z} = \mathbf{0}$ , we have

$$d_E^2(\mathbf{0}) = \sum_{i=1}^n (r_i - \mathbf{x}(\theta(r_i)))^2$$

which is the minimum SED that we can get. Hence,

$$d_E^2(\mathbf{z}) > d_E^2(\mathbf{0})$$

and the increase of  $d_E^2(\mathbf{z})$  compared to  $d_E^2(\mathbf{0})$ , denoted by  $d^{(+)}$ , is formulated as

$$d_E^2(\mathbf{z}) = d_E^2(\mathbf{0}) + d^{(+)}(\mathbf{z}) \quad (10)$$

for any  $\mathbf{z} \neq \mathbf{0}$ . For the sake of simplicity, we refer to  $d^{(+)}(\mathbf{z})$  by  $d^{(+)}$ .

Observe that  $\mathbf{x}(\theta(r_i)) = \text{sgn}(r_i)$  and when we apply  $z_i = 1$ , the sign changes as follows

$$\mathbf{x}(\theta(r_i) \oplus z_i) = \begin{cases} \text{sgn}(r_i) & z_i = 0, \\ -\text{sgn}(r_i) & z_i = 1. \end{cases} \quad (11)$$

Without loss of generality, we assume  $r_i > 0$  hence  $r_i = i \cdot \delta$  for  $\rho = 0$  any  $i$  with  $z_i = 1$  to make the following discussion easier to follow. Since  $\text{sgn}(r_i) \in \{1, -1\}$  is a bipolar mapping, then, we have

$$(r_i - \mathbf{x}(\theta(r_i) \oplus z_i))^2 = (i \cdot \delta - 1)^2 \quad (12)$$

To begin with, we consider only the error patterns with a single error. For a pattern  $\mathbf{z}$  with  $w(\mathbf{z}) = 1$ , we flip  $z_i = 0$  to  $z_i = 1$  and we get  $(i \cdot \delta + 1)^2$ . Then, the increase in the SED is

$$d^{(+)} = (i \cdot \delta + 1)^2 - (i \cdot \delta - 1)^2 = i(4\delta) = i\Delta. \quad (13)$$

where the notation  $\Delta = 4\delta$  is introduced and it will be used in the rest of this section.

Now, let us take all the error patterns with identical logistic weights. As we know, these patterns can be obtained by integer partitioning with distinct parts. The following proposition discusses the increase in the SED for this case, where the logistic  $w_L$  is found proportional to the increase in distance from the received sequence,  $d^{(+)} = d_E^2(\mathbf{z}) - d_E^2(\mathbf{0})$ . In other words, given Assumption 1, our aim is to show that

$$d^{(+)} \propto w_L. \quad (14)$$

**Proposition 1.** Given an arbitrary logistic weight  $w_L > 0$  and Assumption 1, the increase in the squared Euclidean distance, i.e., the term  $d^{(+)}(\mathbf{z})$  in  $d_E^2(\mathbf{z}) = d_E^2(\mathbf{0}) + d^{(+)}(\mathbf{z})$ , remains constant for all binary vector  $\mathbf{z}$  with  $z_j = 1, j \in \mathcal{I} \subset [1, w_L]$  such that  $w_L = \sum_{j \in \mathcal{I}} j$ . That is, for some  $\Delta > 0$ , we have

$$d^{(+)} = \left( \sum_{j \in \mathcal{I}} j \right) \Delta \text{ for all } \mathcal{I} \subset [1, w_L] \text{ s.t. } w_L = \sum_{j \in \mathcal{I}} j. \quad (15)$$

*Proof.* Suppose  $w_L = i = i_1 + i_2$ . We first compare  $d^{(+)}$  for the error patterns corresponding to  $i$  alone and  $i_1, i_2$  together. We observed the increase in the SED by an error pattern with  $w(\mathbf{z}) = 1$  in (13). Now, if we use an error pattern  $\mathbf{z}$  with weight  $w(\mathbf{z}) = 2$  by flipping  $z_{i_1} = z_{i_2} = 0$  to  $z_{i_1} = z_{i_2} = 1$  given  $w_L(\mathbf{z}) = i = i_1 + i_2$ , we get

$$\begin{aligned} d^{(+)} &= \left( (i_1\delta + 1)^2 + (i_2\delta + 1)^2 \right) - \left( (i_1\delta - 1)^2 + (i_2\delta - 1)^2 \right) \\ &= \left( (i_1\delta + 1)^2 - (i_1\delta - 1)^2 \right) + \left( (i_2\delta + 1)^2 - (i_2\delta - 1)^2 \right) \\ &\stackrel{(13)}{=} i_1\Delta + i_2\Delta = (i_1 + i_2)\Delta \end{aligned}$$

In general, if we use any error pattern  $\mathbf{z}$  with weight larger than  $w(\mathbf{z}) > 1$  given  $w_L(\mathbf{z}) = i$ , we have

$$d^{(+)} = \sum_{j \in \mathcal{I}} \left( (j\delta + 1)^2 - (j\delta - 1)^2 \right) = \left( \sum_{j \in \mathcal{I}} j \right) \Delta. \quad (16)$$

Therefore, as  $i = \sum_{j \in \mathcal{I}} j$ , any error pattern  $\mathbf{z}$  with  $z_j = 1, j \in \mathcal{I}$  and  $\mathcal{I} \subset [1, i]$  gives the same  $d^{(+)}$ . Note that all  $\mathcal{I}$  subsets can be obtained by integer partitioning with distinct parts. ■

Hence, the error patterns with an identical logistic weight will have the identical squared Euclidean distance as well. That is why the order of checking these patterns is arbitrary as suggested in [21].

**Remark 2.** Given two logistic weights of  $w_L = i$  and  $i'$  such that  $i' > i$ . Since  $i'\Delta > i\Delta$  and so the  $d^{(+)}$  corresponding to  $i'$  will be larger, we have  $d_E^2(\mathbf{z}) < d_E^2(\mathbf{z}')$  where  $\mathbf{z}$  and  $\mathbf{z}'$  are the corresponding error patterns to  $w_L = i$  and  $i'$ . Hence, the error pattern(s) with  $w_L = i$  should be checked first in this case.

Recall that we considered Assumption 1 for the analysis in this section which implies a uniform distribution for the received signals. However, this assumption is not realistic as the  $r_i$  values follow the Gaussian distribution. Therefore, the error patterns in the order generated based on the logistic weight may not be aligned precisely with the ML order. As a result, we refer to this order as a near-ML order.

#### IV. SEGMENTED GRAND: ERROR SUB-PATTERNS

As discussed in Section II, the ORBGRAND checks the error patterns  $\hat{\mathbf{e}}$  using (5). In this scheme, we have a single pattern generator that outputs  $\hat{\mathbf{e}}$  in a near-ML order. This may require generating a significant number of patterns to find a valid pattern that passes all the parity constraints in the parity check matrix  $\mathbf{H}$ . In [28], we studied how to constrain this single error pattern generator to output the patterns satisfying one or multiple disjoint constraints. The aim was to avoid the computationally complex operation in (5) in the pattern checking stage and replace it with a computationally simple partial pre-evaluation in the pattern generation stage. Towards this goal, we extracted multiple constraints from the original or manipulated parity check matrix such that the constraints cover disjoint sets of indices in  $[1, n]$ .

In this section, we use the extracted constraints in [28] and we call the corresponding disjoint sets *segments*. Furthermore, we employ multiple error pattern generators associated with the segments to generate short patterns, named *sub-patterns*, satisfying the constraint corresponding to the segments. Hence, unlike in [28], all the generated sub-patterns and the patterns resulting from the combinations of sub-patterns will satisfy all the constraints and we do not discard any generated patterns. However, this advantage comes with the challenging problem of how to order error patterns resulting from the combinations of sub-patterns. We will tackle this problem in the next section. In the rest of this section, we define the segments and the notations needed for the rest of the paper.

Depending on the parity check matrix  $\mathbf{H}$  of the underlying code, we can have at least two segments. Let us denote the total number of segments by  $p$  and the set of coordinates (or indices) of coded symbols in segment  $j$  by  $\mathcal{S}_j$ . Any row  $\mathbf{h}_j, j \in [1, n-k]$ , of matrix  $\mathbf{H}$  can partition the block code into two segments as follows:

$$\begin{aligned}\mathcal{S}_j &= \text{supp}(\mathbf{h}_j), \\ \mathcal{S}'_j &= [1, n] \setminus \text{supp}(\mathbf{h}_j).\end{aligned}$$

Before further discussion, let us define explicitly a segment as follows:

**Definition 2. Error Sub-pattern:** A subset of coordinates in the error pattern  $\hat{\mathbf{e}}$  corresponding to a segment is called an error sub-pattern. In other words, the error sub-pattern corresponding to segment  $j$ , denoted by  $\mathcal{E}_j$ , is defined as

$$\mathcal{E}_j = \mathcal{S}_j \cap \text{supp}(\mathbf{e}). \quad (17)$$

The syndrome can give us some insight into the number of errors in each segment.

**Remark 3.** The corresponding element  $s_j$  in syndrome  $\mathbf{s} = [s_1 \ s_2 \ \dots \ s_{n-k}]$  determines the weight of the corresponding error sub-pattern  $\mathcal{E}_j$  as [28]

$$|\mathcal{E}_j| = |\text{supp}(\mathbf{h}_j) \cap \text{supp}(\mathbf{e})| = \begin{cases} \text{odd} & s_j = 1, \\ \text{even} & s_j = 0, \end{cases} \quad (18)$$

where the even number of errors includes no errors as well. However, the weight of the error sub-pattern corresponding to positions outside  $\text{supp}(\mathbf{h}_j)$ , i.e.,

$$|([1, n] \setminus \text{supp}(\mathbf{h}_j)) \cap \text{supp}(\mathbf{e})| \rightarrow \text{unknown},$$

can be either even or odd as the positions in  $[1, n] \setminus \text{supp}(\mathbf{h}_j)$  are not involved in the parity constraint  $\mathbf{h}_j$ .

Depending on the parity check matrix  $\mathbf{H}$ , we may be able to cover the positions in  $[1, n] \setminus \text{supp}(\mathbf{h}_j)$  by one or more other rows in  $\mathbf{H}$  other than row  $j$ . This can be achieved by matrix manipulation of  $\mathbf{H}$ , i.e., row operation, because the row space is not affected by elementary row operations on  $\mathbf{H}$  (resulting in  $\mathbf{H}'$ ) as the new system of linear equations represented in the matrix form  $\mathbf{H}' \cdot \mathbf{c} = \mathbf{0}$  will have an unchanged solution set  $\mathcal{C}$ .

**Example 2.** Suppose we have three rows of a parity check matrix and the associated syndrome bits as follows:

$$\begin{aligned}\mathbf{h}_{j_1} &= [1 \ 1 \ 1 \ 1 \ 0 \ 1 \ 1 \ 0], \quad s_{j_1} = 0, \\ \mathbf{h}_{j_2} &= [0 \ 1 \ 0 \ 1 \ 0 \ 0 \ 1 \ 0], \quad s_{j_2} = 1, \\ \mathbf{h}_{j_3} &= [0 \ 1 \ 0 \ 1 \ 1 \ 0 \ 1 \ 1], \quad s_{j_3} = 0.\end{aligned}$$

From  $\mathbf{h}_{j_2}$ , we can form two segments corresponding to the following disjoint index sets:

$$\begin{aligned}\mathcal{S}_{j_2} &= \text{supp}(\mathbf{h}_{j_2}) = \{2, 4, 7\}, \\ \mathcal{S}'_{j_2} &= [1, 8] \setminus \text{supp}(\mathbf{h}_{j_2}) = \{1, 3, 5, 6, 8\},\end{aligned}$$

From  $s_{j_2} = 1$ , we understand that

$$\begin{aligned}|\mathcal{S}_{j_2} \cap \text{supp}(\mathbf{e})| &\rightarrow \text{odd}, \\ |\mathcal{S}'_{j_2} \cap \text{supp}(\mathbf{e})| &\rightarrow \text{unknown},\end{aligned}$$

Here, unknown means the weight of error sub-pattern  $\mathcal{E}'_{j_2} = \mathcal{S}'_{j_2} \cap \text{supp}(\mathbf{e})$  can be either even or odd. Hence, we have to generate all the sub-patterns, not constrained to odd or even sub-patterns only. Note that we can efficiently generate only odd or even sub-patterns as illustrated in Section VIII, however in the case of no insight into the number of errors in the segment, we have to generate all possible sub-patterns for that specific segment.

Now, by row operations on  $\mathbf{h}_{j_1}$  and  $\mathbf{h}_{j_3}$ , we can get

$$\begin{aligned}\mathbf{h}'_{j_1} &= \mathbf{h}_{j_1} \oplus \mathbf{h}_{j_2} = [1 \ 0 \ 1 \ 0 \ 0 \ 1 \ 0 \ 0], \quad s'_{j_1} = 1, \\ \mathbf{h}_{j_2} &= [0 \ 1 \ 0 \ 1 \ 0 \ 0 \ 1 \ 0], \quad s_{j_2} = 1, \\ \mathbf{h}'_{j_3} &= \mathbf{h}_{j_3} \oplus \mathbf{h}_{j_2} = [0 \ 0 \ 0 \ 0 \ 1 \ 0 \ 0 \ 1], \quad s'_{j_3} = 0,\end{aligned}$$

where we can form three segments ( $p = 3$ ) with corresponding disjoint index sets

$$\mathcal{S}'_{j_1} = \{1, 3, 6\}, \mathcal{S}_{j_2} = \{2, 4, 7\}, \mathcal{S}'_{j_2} = \{5, 8\},$$

from which we understand that the weight of error sub-patterns are as follows:

$$|\mathcal{S}'_{j_1} \cap \text{supp}(\mathbf{e})| \rightarrow \text{odd},$$

$$|\mathcal{S}_{j_2} \cap \text{supp}(\mathbf{e})| \rightarrow \text{odd},$$

$$|\mathcal{S}'_{j_3} \cap \text{supp}(\mathbf{e})| \rightarrow \text{even}.$$

As practical examples for segmentation, we can give the following codes:

- eBCH code (128, 106): The rows  $\mathbf{h}_1$  and  $\mathbf{h}_2$  in  $\mathbf{H}$  matrix satisfy the relationship  $\text{supp}(\mathbf{h}_2) \subset \text{supp}(\mathbf{h}_1)$  where  $\mathbf{h}_2 = \mathbf{1}$  and  $|\mathbf{h}_1|/2 = |\mathbf{h}_2| = 64$ . Hence, we can modify  $\mathbf{h}_1$  by row operation  $\mathbf{h}'_1 = \mathbf{h}_1 \oplus \mathbf{h}_2$  to get the following two segments:  $\mathcal{S}_2 = \text{supp}(\mathbf{h}_2)$  and  $\mathcal{S}'_1 = \text{supp}(\mathbf{h}'_1)$  where  $\mathcal{S}_2 \cup \mathcal{S}'_1 = [1, 128]$ .
- PAC code (64, 44): The rows  $\mathbf{h}_1$ ,  $\mathbf{h}_4$ , and  $\mathbf{h}_5$  in  $\mathbf{H}$  matrix satisfy the relationship  $\text{supp}(\mathbf{h}_5) \subset \text{supp}(\mathbf{h}_4) \subset \text{supp}(\mathbf{h}_1)$  where  $\mathbf{h}_1 = \mathbf{1}$  and  $|\mathbf{h}_1|/2 = |\mathbf{h}_4| = 2|\mathbf{h}_5| = 32$ . Hence, we can modify  $\mathbf{h}_1$  and  $\mathbf{h}_4$  by row operations  $\mathbf{h}'_1 = \mathbf{h}_1 \oplus \mathbf{h}_4$  and  $\mathbf{h}'_4 = \mathbf{h}_4 \oplus \mathbf{h}_5$  to get the following three segments:  $\mathcal{S}'_1 = \text{supp}(\mathbf{h}'_1)$ ,  $\mathcal{S}'_4 = \text{supp}(\mathbf{h}'_4)$ , and  $\mathcal{S}_5 = \text{supp}(\mathbf{h}_5)$  where  $\mathcal{S}'_1 \cup \mathcal{S}'_4 \cup \mathcal{S}_5 = [1, 64]$ .

Now, we turn our focus to the possible complexity reduction that the segmentation can provide in terms of sorting complexity and membership checking complexity.

**Complexity of Sorting the Received Signals.** In all the variants of GRAND, the received signals should be sorted in ascending order of their absolute values. Let us take Bitonic network sorter with the total number of stages computed based on the sum of the arithmetic progression as [30, Section V]

$$\Psi = \sum_{\psi=1}^{\log_2 n} \psi = \frac{1}{2}(\log_2 n)(1 + \log_2 n). \quad (19)$$

Observe that reduction in  $n$  can significantly reduce  $\Psi$  as a measure of complexity. For instance, given a code with length  $n = 64$  with  $\Psi = 21$ . If it is segmented into two equal segments, then we get  $\Psi = 15$ . Note that the total number of stages in (19) as a measure of time complexity (all nodes in every stage are processed simultaneously) is in order of  $O(\log_2^2 n)$ . Clearly, by segmentation,  $n$  reduces and so does the time complexity.

**Average Number of Queries.** As the reduction in the number of queries depends on the number of parity constraints, let us first see how many segments we can have.

**Remark 4.** The maximum number of segments depends on the underlying code. However, the minimum number of segments is two as was shown in Example 2 by considering either one or two parity check constraints. The latter gives a lower complexity because we get an insight into both segments. The

codes that have a well-structured parity check matrix such as polar codes can form easily more than two segments.

The reduction in the average complexity is also proportional to the reduction in the size of the search space as was shown numerically in [28]. The following lemma shows that the size of the search space reduces by a factor of two and it depends on the total number of parity constraints.

**Lemma 1.** Suppose we have a parity check matrix  $\mathbf{H}$  in which there are  $p$  rows of  $\mathbf{h}_j, j = j_1, j_2, \dots, j_p$  with mutually disjoint index sets  $\mathcal{S}_j = \text{supp}(\mathbf{h}_j)$  that define  $p$  segments, then the size of the search space by these  $p$  parity check equations is

$$\Omega(\mathbf{h}_{j_1}, \dots, \mathbf{h}_{j_p}) = 2^{n-p}. \quad (20)$$

*Proof.* Let us first take a row  $\mathbf{h}_j$  and  $\mathcal{S}_j = \text{supp}(\mathbf{h}_j)$ . In this case, we only consider the error sequences satisfying  $|\mathcal{S}_j \cap \text{supp}(\hat{\mathbf{e}})| \bmod 2 = s_j$  in the search space. Then, the size of the constrained search space will be

$$\Omega(\mathbf{h}_j) = \sum_{\substack{\ell \in [0, |\mathcal{S}_j|]: \\ \ell \bmod 2 = s_j}} \binom{|\mathcal{S}_j|}{\ell} \cdot 2^{n-|\mathcal{S}_j|} = \frac{2^{|\mathcal{S}_j|}}{2} \cdot 2^{n-|\mathcal{S}_j|} = 2^{n-1}. \quad (21)$$

Generalizing (21) for  $p$  constraints, we have

$$\left( \prod_{j=j_1}^{j_p} \sum_{\substack{\ell \in [0, |\mathcal{S}_j|]: \\ \ell \bmod 2 = s_j}} \binom{|\mathcal{S}_j|}{\ell} \right) \cdot 2^{n-\sum_{j=j_1}^{j_p} |\mathcal{S}_j|} = \left( \prod_{j=j_1}^{j_p} 2^{|\mathcal{S}_j|-1} \right) \cdot 2^{n-\sum_{j=j_1}^{j_p} |\mathcal{S}_j|} = 2^{n-p}. \quad \blacksquare$$

So far, we have defined the segments and the corresponding error sub-patterns. In [28], we provided an efficient scheme to evaluate the outputs of a single error pattern generator of the conventional ORBGRAND with respect to the segments' constraint in (18) before checking the codebook membership by (5). The drawback of the proposed method is that we still have to generate invalid patterns although we can discard them to avoid the computationally more complex operation of codebook membership checking.

In this paper, our goal is to entirely avoid generating invalid error patterns with respect to the parity constraints of the segments. To this end, we need multiple error pattern generators that only produce valid sub-patterns simultaneously for the associated segments. Note that we can have a single pattern generator that produces sub-patterns for the segments successively at the cost of longer latency. This sub-pattern-based approach is discussed in the next section in detail. Figs. 1 and 2 illustrate the difference between the approaches in this paper and in [28]. As can be seen, the pre-evaluation in Fig. 1 can save the codebook membership checking operation. Whereas the error patterns generated based on the valid sub-patterns in Fig. 2 do not need any pre-evaluation.

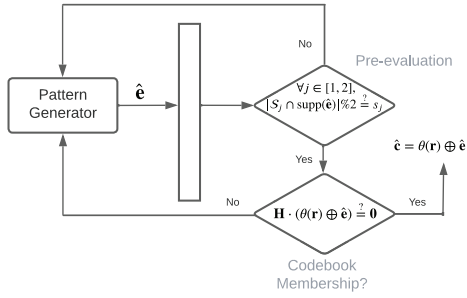

Fig. 1. The error pattern generation process with pre-evaluation in “constrained GRAND” [28] for two constraints.

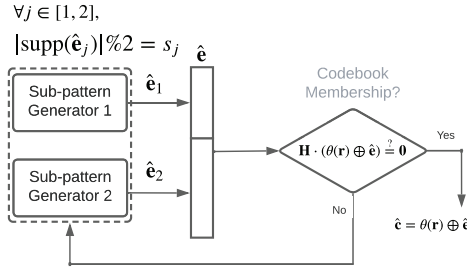

Fig. 2. The proposed error pattern generation approach based on sub-patterns in “segmented GRAND” for two segments.

## V. COMBINING SUB-PATTERNS IN NEAR-ML ORDER

A challenging problem in handling sub-patterns is combining them in order near the ML order. In the conventional ORBGRAND, the logistic weight  $w_L$  is used as a guide to generate error patterns in a near-ML order, i.e., the logistic  $w_L$  is assumed proportional to the increase in distance,  $d^{(+)}$  from the received sequence as shown in (15). As discussed in the previous section, we eventually want to generate sub-patterns for the segments of the underlying code and then combine them. However, we do not know how to combine the sub-patterns from different segments in order to generate the entire pattern in a near-ML order. The trivial way would be generating a set of entire patterns by considering all the possible combinations of the sub-patterns (probably in batches due to the limitation of resources), computing their SEDs, and then sorting them in the ascending order of SED. This method is not of our interest because we need to store many patterns and sort them frequently, similar to what we do in soft-GRAND.

Here, we propose an approach based on a logistic weight  $w_L$ , to preserve the near-ML order in the conventional ORBGRAND, in which we assign sub-weights  $w_L^{(j)}$ ,  $j \in [1, p]$  to  $p$  segments such that

$$w_L = \sum_{j=1}^p w_L^{(j)}. \quad (22)$$

Observe that the combined sub-patterns will still have the same  $w_L$  for any set of  $[w_L^{(1)} \ w_L^{(2)} \ \dots \ w_L^{(p)}]$  that satisfies (22). Now the question is how to get all such sub-weight

vectors  $[w_L^{(1)} \ w_L^{(2)} \ \dots \ w_L^{(p)}]$ . It turns out that by modification of integer partitioning defined in Definition 1, we can obtain all such sub-weights. The difference between the integer partitions in Definition 1 and what we need for sub-weights are as follows: 1) The integer partitions do not need to be distinct (repetition is allowed). That is, two or more segments can have identical sub-weights, 2) the permutation of partitions is allowed, 3) the number of integer partitions (a.k.a part size) is fixed and is equal to the number of segments, and 4) the integer zero is conditionally allowed, i.e., one or more partitions can take zero value given the syndrome element corresponding to the segment is  $s_j = 0$ .

After obtaining the sub-weights, we can use the integer partitions in Definition 1 to get the sub-pattern(s). Hence, we have two levels of integer partitioning in the proposed approach. These two levels are illustrated in Fig. 3. The rest of this section is dedicated to giving the details of this approach starting with some examples for the first level of partitioning and then some definitions and a proposition on how to get all the valid sub-weights for the segments in an efficient way.

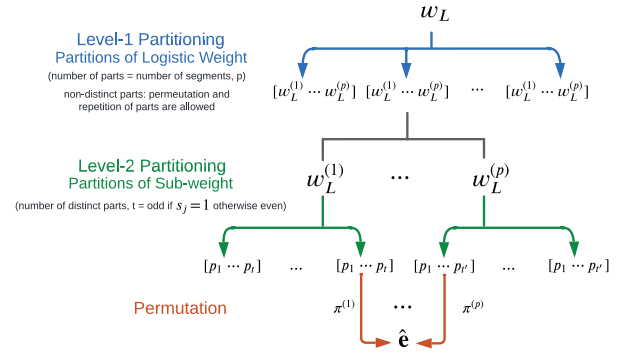

Fig. 3. Two-level integer partitioning to generate error patterns for  $p$  segments. Note that we have  $j \in [1, p]$  and  $t, t'$  are the number of parts (odd, even, or arbitrary when we don't have  $s_j$  for the corresponding segment such as segment  $S'_{j_2}$  in Example 2).

**Example 3.** Suppose the current logistic weight is  $w_L = 5$  and the codeword is divided into three segments,  $p = 3$ , with the corresponding syndrome elements  $s_{j_1} = 0$ ,  $s_{j_2} = 1$  and  $s_{j_3} = 1$ . That is, the weights of the sub-patterns corresponding to the segments are [even, odd, odd], respectively. To generate the sub-patterns for this  $w_L$ , the logistic weights of the segments by the first level of integer partitioning are chosen as

$$[0 \ 1 \ 4], [0 \ 2 \ 3], [0 \ 3 \ 2], [0 \ 4 \ 1], [3 \ 1 \ 1].$$

Observe that the sum of the segment weights is 5 while there are repetitions of weights in  $[3 \ 1 \ 1]$ , permutation of the weights in  $[0 \ 2 \ 3]$  and  $[0 \ 3 \ 2]$ , and zero weight for the segment with  $s_{j_1} = 0$  to allow considering no errors for segment  $j_1$ , i.e., empty sub-pattern. We will discuss later the other details of the sub-pattern generation shown in this example.

Note that the sub-patterns are generated based on the logistic weight of the segments provided in the example above at the

second level of integer partitioning where the parts are distinct integers, in a manner employed in conventional ORBGRAND.

**Example 4.** Suppose we have three segments and  $[w_L^{(1)} w_L^{(2)} w_L^{(3)}] = [0 3 5]$  for  $w_L = 8$ . The integer partitioning of 3 and 5 with distinct parts results in  $[1 2]$  for  $w_L^{(2)} = 3$ , and  $[1 4]$  and  $[2 3]$  for  $w_L^{(3)} = 5$ . Therefore, there are  $1 \times 2 \times 3 = 6$  sub-patterns as follows:

$$\begin{aligned} & [] + [3] + [5], \quad [] + [1 2] + [5], \\ & [] + [3] + [1 4], \quad [] + [1 2] + [1 4], \\ & [] + [3] + [2 3], \quad [] + [1 2] + [2 3]. \end{aligned}$$

**Local permutation.** The integers in the aforementioned sub-patterns refer to the relative position of the symbols in the segments, locally ordered with respect to their reliability. Hence, we need to use a local permutation  $\pi^{(j)}(\cdot)$  for every segment  $j$ , unlike the conventional ORBGRAND where we have only one permutation function  $\hat{\pi}(\cdot)$  as discussed in Section II. The operator “+” denotes the concatenation of the sub-patterns. These patterns can be checked in an arbitrary order as long as they belong to the same  $w_L$ . The local permutation  $\hat{\pi}^{(j)}(\cdot)$  maps a local index in  $[1, |\mathcal{S}_j|]$  belonging to segment  $j$  to the overall index in  $[1, n]$  as

$$\hat{\pi}^{(j)} : \{1, 2, \dots, |\mathcal{S}_j|\} \rightarrow \mathcal{S}_j. \quad (23)$$

From Definition 1, we can define a  $\mathbf{z}_j$  as a binary vector with length  $|\mathcal{S}_j|$  in which  $z_{j,i} = 1$  where  $i \in \mathcal{I} \subset [1, |\mathcal{S}_j|]$  for  $w_L^{(j)} = \sum_{i \in \mathcal{I}} i$ . Then, the element-wise permutation from  $w_L^{(j)}, j = 1, \dots, p$  can be used to flip the relevant positions in an all-zero binary vector with length  $n$  to obtain the error pattern vector  $\mathbf{e}$ , as shown in Fig. 3.

**Example 5.** Suppose we have the received sequence  $\mathbf{r} = [0.5, -1.2, 0.8, 1.8, -1, -0.2, 0.7, -0.9]$  similar to Example 1. We use the segments defined in Example 2 as

$$\mathcal{S}_{j_2} = \{2, 4, 7\}, \quad \mathcal{S}'_{j_2} = \{1, 3, 5, 6, 8\}.$$

Now, the local permutation function based on  $|r_i|, i \in [1, 8]$  in ascending order can be obtained as follows:

$$\begin{aligned} \hat{\pi}^{(j_2)} & : [1, 2, 3] \rightarrow [7, 2, 4] \\ \hat{\pi}'^{(j_2)} & : [1, 2, 3, 4, 5] \rightarrow [6, 1, 3, 8, 5] \end{aligned}$$

Now, let us define an efficient framework for error pattern generation based on sub-patterns that plays the role of guidelines to generate valid sub-patterns only. This framework consists of bases for the formation of error patterns and a minimum logistic weight that each base can take. We begin with defining the bases with respect to the syndrome elements as follows:

**Definition 3. Error Pattern Bases:** A base for the error patterns, denoted by  $[f_1 f_2 \dots f_p]$  for  $p$  segments, determines the

segments contributing their sub-patterns to the error patterns given by logistic weight  $w_L$  as

$$w_L = \sum_{j=1}^p f_j \cdot w_L^{(j)} \quad (24)$$

where  $f_j$  can get the following values:

$$f_j = \begin{cases} \{0, 1\} & s_j = 0, \\ \{1\} & s_j = 1. \end{cases} \quad (25)$$

The segments with  $f_j = 0$  are called *frozen segments* where the sub-pattern contributed by segment  $j$  is empty. The total number of bases is  $\prod_{j=1}^p 2^{1-s_j}$  that can be between 1 and  $2^p$  depending on  $s_j, j \in [1, p]$ .

Note that when  $s_j = 0$  for segment  $j$ , this segment might be error-free. That is the reason why we have error pattern bases excluding the sub-patterns of such segments by setting  $f_j = 0$ . Moreover, when we have  $s_j = 0$  and  $f_j = 1$ , since the segment  $j$  can have sub-patterns with an even weight and the smallest even number of parts is 2, we need to have  $w_L^{(j)} \geq 3$  as  $3 = 1 + 2$  gives the first two most probable erroneous positions. That is, the first error pattern  $\mathbf{z}$  for this segment will be  $z_1 = z_2 = 1$  and  $z_i = 0, i \geq 3$  or  $\mathbf{z} = [1 1 0 \dots 0]$ . On the contrary, we necessarily need  $f_j = 1$  and  $w_L^{(j)} \geq 1$  when  $s_j = 1$ . That is, we cannot have an empty sub-pattern for such segment  $j$  in this case.

**Proposition 2.** Given the segments' syndrome  $[s_1 s_2 \dots s_p]$  and the pattern base  $\mathbf{s} = [f_1 f_2 \dots f_p]$  for  $p$  segments, the minimum  $w_L$  that every pattern base can give is

$$\underline{w}_L(\mathbf{s}) = \sum_{j=1}^p f_j \cdot \underline{w}_L^{(j)}(s_j), \quad (26)$$

where  $\underline{w}_L^{(j)}(s_j)$  is

$$\underline{w}_L^{(j)}(s_j) = 3 - 2s_j. \quad (27)$$

Thus, the overall logistic weight  $w_L(\mathbf{s})$  and sub-weights  $w_L^{(j)}(s_j), j \in [1, p]$  must satisfy

$$w_L(\mathbf{s}) \geq \underline{w}_L(\mathbf{s}) \text{ and } w_L^{(j)}(s_j) \geq \underline{w}_L^{(j)}(s_j). \quad (28)$$

*Proof.* Equation (27) follows from function  $\underline{w}_L^{(j)}(s_j) : \{0, 1\} \rightarrow \{3, 1\}$  as discussed earlier, which maps the minimum non-zero  $w_L^{(j)}$  to 3 when  $s_j = 0$  and maps to 1 when  $s_j = 1$ . Then, Equation (26) clearly holds for the minimum of overall logistic weight which is denoted by  $\underline{w}_L(\mathbf{s})$ . ■

Observe that the base patterns are used to efficiently enforce the minimum weight constraints in (28). The importance of the base patterns is realized when we recall that the level-1 integer partitioning allows permutation and repetition of parts (here, sub-weights).

**Example 6.** Given  $s_1 = 0, s_2 = 1$  and  $s_3 = 1$ , we would have  $2 \times 1 \times 1 = 2$  error pattern bases  $[f_1 f_2 f_3]$  and their minimum weights/sub-weights as follows:

$$[f_1 f_2 f_3] = [0 1 1], \underline{w}_L = 2, [w_L^{(1)} = 0 \ w_L^{(2)} = 1 \ w_L^{(3)} = 1],$$



$$[f_1 \ f_2 \ f_3] = [1 \ 1 \ 1], \underline{w}_L = 5, [\underline{w}_L^{(1)} = 3 \ \underline{w}_L^{(2)} = 1 \ \underline{w}_L^{(3)} = 1].$$

Now, for  $w_L = 4$ , the sub-weights  $[w_L^{(1)} \ w_L^{(2)} \ w_L^{(3)}]$  are  $[0 \ 1 \ 3]$ ,  $[0 \ 2 \ 2]$ , and  $[0 \ 3 \ 1]$ . As can be seen,  $w_L^{(1)} = 0$ , i.e., segment 1 is frozen, and all the sub-weights were generated with the pattern base  $[0 \ 1 \ 1]$ . However, for  $w_L = 5$ , the sub-weights are  $[0 \ 1 \ 4]$ ,  $[0 \ 2 \ 3]$ ,  $[0 \ 3 \ 2]$ ,  $[0 \ 4 \ 1]$ , and  $[3 \ 1 \ 1]$  where the last one is based on the pattern base  $[1 \ 1 \ 1]$  (note that  $\underline{w}_L = 5$  for this base). The analogy to the overall weight and the sub-weights are shown in Fig. 4.

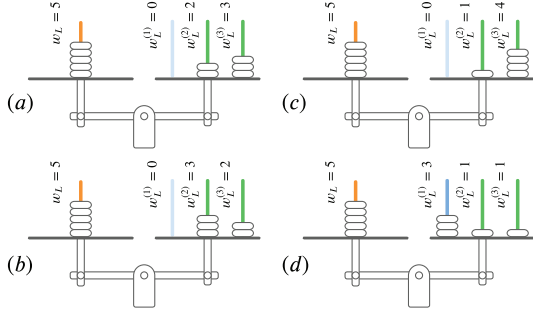

Fig. 4. Analogy of segment weights (or sub-weights) and the overall weight  $w_L = 5$  on a scale. Note that (d) is representing the pattern base  $[1 \ 1 \ 1]$  and the rest are based on the pattern base  $[0 \ 1 \ 1]$  where segment 1 is frozen.

Following the example above, we define our tailored integer partitioning scheme for combining the sub-patterns.

**Definition 4. Logistic Weight and Sub-weights:** Suppose we have a block code with  $p$  segments. The overall logistic weight  $w_L$  can be distributed among segments by sub-weights  $w_L^{(j)} = \kappa_j + c_j$  as

$$w_L = \sum_{j=1}^p f_j \cdot w_L^{(j)} = \sum_{j=1}^p f_j (\kappa_j + c_j), \quad (29)$$

where  $\kappa_j \geq \underline{w}_L^{(j)}$  is the initial value for  $w_L^{(j)}$  and  $c_j \geq 0$  is the increments to get larger  $w_L^{(j)}$ .

**Example 7.** Given  $s_1 = 1$  and  $s_2 = 0$ , we would have  $1 \times 2 = 2$  error pattern bases  $[f_1 \ f_2]$  as follows:

$$[f_1 \ f_2] = [1 \ 0], \underline{w}_L = 1, [\underline{w}_L^{(1)} = 1 \ \underline{w}_L^{(2)} = 0],$$

$$[f_1 \ f_2] = [1 \ 1], \underline{w}_L = 4, [\underline{w}_L^{(1)} = 1 \ \underline{w}_L^{(2)} = 3].$$

As Fig. 5 shows, segment 2 is frozen up to  $w_L = 3$  and all sub-weights are generated by base  $[1 \ 0]$  at level-1 partitioning. Hence no error pattern is allocated to this segment for  $1 \leq w_L \leq 3$ . Note that the all-zero error pattern is not valid in this case, i.e.,  $w_L > 0$ . Furthermore, Fig. 6 shows the two levels of partitioning specifically for  $w_L = 6$  when the partitions  $[w_L^{(1)}, w_L^{(2)}] = [2 \ 4]$  is selected in the first level. Following the permutation functions in Example 5, the error pattern vector  $\mathbf{e}$  is given as well.

The idea of splitting the logistic weight into sub-weights for the segments is based on the assumption that the least

$\mathbf{f} :$	$[1 \ 0]$	$[1 \ 1]$
$\underline{w}_L(\mathbf{s}) :$	1	4
	$[w_L^{(1)} \ w_L^{(2)}]$	$[w_L^{(1)} \ w_L^{(2)}]$
$w_L = 1$	$[1 \ 0]$	
$w_L = 2$	$[2 \ 0]$	
$w_L = 3$	$[3 \ 0]$	
$w_L = 4$	$[4 \ 0]$	$[1 \ 3]$
$w_L = 5$	$[5 \ 0]$	$[2 \ 3], [1 \ 4]$
$w_L = 6$	$[6 \ 0]$	$[3 \ 3], [2 \ 4], [1 \ 5]$

Fig. 5. The sub-weights generated based on  $\mathbf{s} = [s_1 = 1 \ s_2 = 0]$  for two-segment based GRAND. For  $w_L = 1, 2, 3$ , the base  $= [1 \ 0]$  is activated only because the base  $= [1 \ 1]$  has  $\underline{w}_L = 4$ . We have both bases activated for  $w_L \geq 4$ .

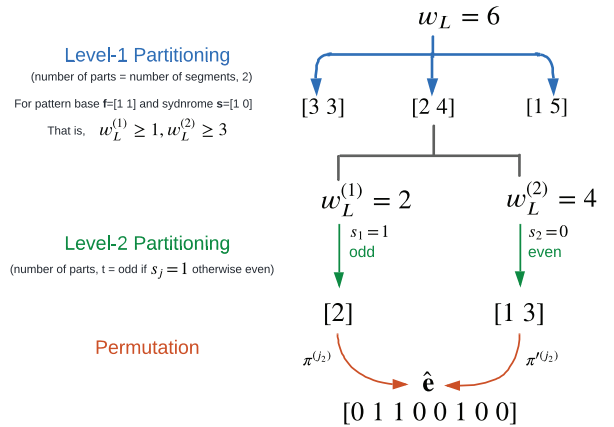

Fig. 6. An example of Two-level error pattern generation based on sub-patterns when  $\mathbf{s} = [s_1 = 1 \ s_2 = 0]$ . Note that  $n_1$  and  $n_2$  are the lengths of segments 1 and 2.

reliable symbols are almost evenly distributed among the segments. The statistical results for 15000 transmissions of eBCH(128,106) codewords over AWGN channel show that this assumption is actually realistic. Fig. 7 shows the distribution of 64 least reliable symbols between two 64-length segments, by locating and counting them in the segments for each transmitted codeword. The mean and standard deviation of the bell-shaped histogram for each segment is 32 and 2.85, respectively. Moreover, as the additive noise follows Gaussian distribution and it is independent and identically distributed among the symbols, these results were expected.

Now, let us look at a realistic example comparing the conventional ORBGRAND with Segmented ORBGRAND in terms of searching for a valid error pattern.

**Example 8.** Suppose a codeword of eBCH code (64,45) is transmitted over an AWGN channel and the hard decision on the received sequence leads to three erroneous bits at coordinates of  $\text{supp}(\mathbf{e}) = [1 \ 15 \ 23]$ . One employs ORBGRAND to find these coordinates. This goal is achieved after 57 attempts sweeping through logistic weights  $w_L = 1 \rightarrow 12$ . Fig. 8 illustrates the Euclidean distance of all queries.

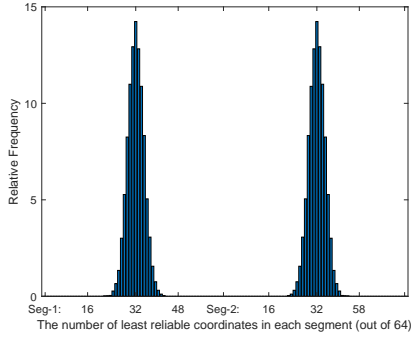

Fig. 7. Distribution of the 64 least reliable coordinates between two segments for the 15000 independent transmissions of eBCH(128,106) codewords.

	$w_L$	$\text{supp}(\hat{e})$	$d_E^2$		$w_L$	$\text{supp}(\hat{e})$	$d_E^2$
1	1	{23}	20.58	8	5	{39, 1}	21.49
2	2	{1}	20.80	9	5	{42}	21.68
3	3	{23, 1}	20.93	...	...	...	...
4	3	{39}	21.14	54	11	{42, 33}	23.57
5	4	{39, 23}	21.27	55	12	{36, 23}	22.95
6	4	{9}	21.35	56	12	{50}	22.98
7	5	{23, 9}	21.48	57	12	{23, 15, 1}	23.10

Now, if one divides the codeword into two equal-length segments with coordinates in  $\mathcal{S}_1, \mathcal{S}_2$  based on two constraints, it turns out that segments 1 and 2 have odd and even numbers of errors since  $s_1 = 1$  and  $s_2 = 0$ . The proposed Segmented ORBGRAND can find the error coordinates in only 7 queries as illustrated in the table below.

	$w_L$	$[w_L^{(1)} w_L^{(2)}]$	$\text{supp}(\hat{e}) \cap \mathcal{S}_1$	$\text{supp}(\hat{e}) \cap \mathcal{S}_2$	$d_E^2$
1	1	[1 0]	{9}	{}	21.35
2	2	[2 0]	{15}	{}	22.54
3	3	[3 0]	{8}	{}	22.71
4	4	[4 0]	{50}	{}	22.98
5	4	[1 3]	{9}	{23, 1}	21.83
6	5	[5 0]	{3}	{}	23.06
7	5	[2 3]	{15}	{23, 1}	23.10

The patterns found by Segmented ORBGRAND are circled in Fig. 8. As can be seen, by segmentation, we can avoid checking many invalid error patterns.

We can combine the sub-patterns generated by  $w_L^{(j)}, j = 1, \dots, p$ , in an arbitrary order as the sub-weights of all the combinations are summed up to  $w_L$ .

## VI. TUNING SUB-WEIGHTS FOR UNEQUAL DISTRIBUTION OF ERRORS AMONG SEGMENTS

In the previous section, we suggested initializing the parameter  $\kappa_j$  by  $\underline{w}_L^{(j)} \in \{1, 3\}$  depending on the value of  $s_j \in \{1, 0\}$ . Although we are considering the AWGN channel where the random noise added to every symbol is independent and identically distributed (i.i.d.), there is a possibility that the distribution of errors is significantly unbalanced, that is, the weight of the error vector in one segment is quite larger than the other one(s). We can get statistical insight into this distribution by counting the low-reliability symbols (or small  $|r_i|$ ) in each segment, denoted by  $a_j$ . Then, we adjust the initialization of  $\kappa_j$ s and make them proportional to the number of symbol positions in the segment with  $|r_i| < \epsilon$  where

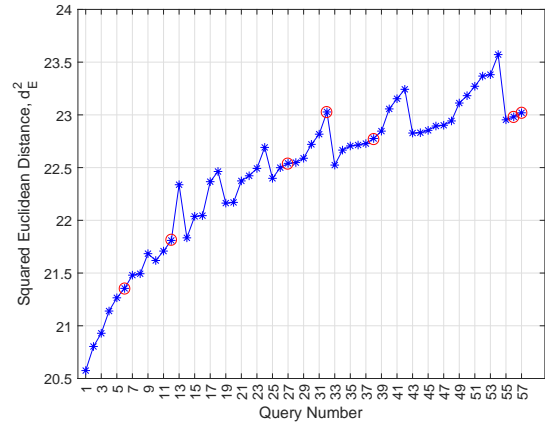

Fig. 8. The squared Euclidean distance of queries up to the first codeword in ORBGRAND. The red circles indicate the queries performed by Segmented ORBGRAND with an order different from ORBGRAND. Note that since the metric is not *monotonically increasing*, i.e., not always increasing or remaining constant, it doesn't give the ML order.

$\epsilon$  is an arbitrary threshold for low-reliability symbols. This will account for the unequal distribution of errors among the segments. Suppose the expected number of errors in a segment with length  $L$  is

$$\mu_e^{(j)} = L \cdot 2P(|r| < \epsilon), \quad (30)$$

where the probability  $Pr(\cdot)$  follows the Gaussian distribution with mean 1 and noise variance  $\sigma_n^2$ . Then, we can adjust  $k_j$  as

$$k_j = \underline{w}_L^{(j)} + \left\lceil \frac{\max\{a_j\} - a_j}{\rho \cdot \mu_e^{(j)}} \right\rceil, \quad (31)$$

where  $\rho \cdot \mu_e^{(j)}$  is used for normalization of the relative difference with the number of low-reliability symbols in the segments. The parameter  $\rho \leq 0$  can be adjusted to get a better result. We denote the second term by  $\tau_j = \left\lceil \frac{\max\{a_j\} - a_j}{\rho \cdot \mu_e^{(j)}} \right\rceil$ . Note that the offset  $\tau_j$  is only for the initialization stage and we should consider it when we conduct integer partitioning of  $w_L^{(j)}$  by subtracting the offset from the segment weight, i.e.,  $w_L^{(j)} - \tau_j$ . Although these adjustments (addition and subtraction of  $\tau_j$ ) seem redundant and ineffective, they will postpone the generation of large-weight patterns for the segment(s) with small  $a_j$ , and hence we will get a different order of patterns that may result in a fewer number of queries for finding a valid codeword. Let us have a look at an example.

**Example 9.** Let us consider two segments with  $L = 32$  elements, the corresponding syndrome element  $s_1 = 1, s_2 = 0$ , threshold  $\epsilon = 0.2$  and  $\mu_e = L \cdot 2Pr(|r| < \epsilon) = 8$ . We realize that there are 11 and 3 elements in segments 1 and 2, respectively, satisfying  $|r_i| < \epsilon$ . Having fewer low-reliability positions than the expected number (i.e.,  $3 < \mu_e$ ) implies that the possibility of facing no errors in segment 2 is larger than having at least 2 errors (recall that the Hamming weight of error sub-pattern for this segment should be even due to  $s = 0$ ). Therefore, in level-1 partitioning, we can increase

the initial sub-weight for this segment from  $\kappa_2 = \underline{w}_L^{(2)} = 3$  to  $\kappa_2 = \underline{w}_L^{(2)} + \tau_2 = 5$  by  $\tau_2 = 2$  assuming  $\rho = 1/2$ . This increase will delay generating sub-patterns with base  $[1 \ 1]$  from  $w_L = 4$  to  $w_L = 6$  in Example 7. This prioritizes checking all sub-patterns with sub-weights  $[4 \ 0]$  and  $[5 \ 0]$  hoping that we find the correct error pattern faster by postponing the less likely error patterns to a later time. Nevertheless, in level-2 partitioning when we want to generate the sub-patterns with sub-weight  $\kappa_2 = 5$  and base  $[1 \ 1]$ , we should subtract  $\tau_2$  from  $\kappa_2 \geq 5$ ; otherwise, we will miss the error patterns with smaller sub-weights, i.e.,  $w_L^{(2)} = 3, 4$ .

The numerical evaluation of this technique for eBCH(128,106) with two segments and  $\rho = 0.3, \epsilon = 0.2$  shown in the table below reveals a slight reduction in the average queries while the BLER remains almost unchanged. The reduction in queries can be attributed to cases where there is an imbalance in the distribution of low-reliability symbols across segments. However, a significant imbalance between segments does not necessarily imply a significant imbalance in the distribution of erroneous coordinates. Consequently, tuning techniques in such scenarios may necessitate relatively larger queries, leading to only a slight reduction overall. These results demonstrate that the original segmented ORBGRAND without tuning overhead is good enough despite not considering the reliability imbalance between the segments. The reason comes from the imperfection of the reliability metric and complexity averaging over all received sequences.

$E_b/N_0$	3.5	4	4.5	5	5.5
without tuning	30685	8358	1750	315	54
with tuning	30492	8110	1661	291	48

## VII. COMPLEXITY ANALYSIS

In this section, we discuss the expected reduction in the complexity (the average number of queries) of the proposed scheme. The overall size of the search space is considered  $2^n$  where we have  $2^k$  valid codewords. Note that the complexity to obtain ML decoding of any GRAND algorithm is upper bounded by a function of the redundancy,  $n - k$  (of order  $2^{n-k}$ ) as a consequence of Theorem 2 in [17].

The search for finding the first valid codeword resembles the geometric distribution where the random variable is defined as the number of failures until the first success. Here, the first success is in fact finding the first valid codeword. However, unlike geometric distribution, every query in ORBGRAND cannot be considered independent as they are checked based on the order given by the weight function. Fig. 9 shows the behaviour of the number of queries to the first valid codeword under ORBGRAND order. This experiment was performed for decoding 80,000 eBCH(64,45) codewords at  $E_b/N_0 = 4$  dB where 44% of the decodings required more than 100 queries. Note that zero queries are considered for checking the hard decision of the received sequence. Due to the special order of queries in ORBGRAND, modelling such a distribution is not trivial. Nevertheless, as expected value is a measure of the central tendency of a probability distribution,

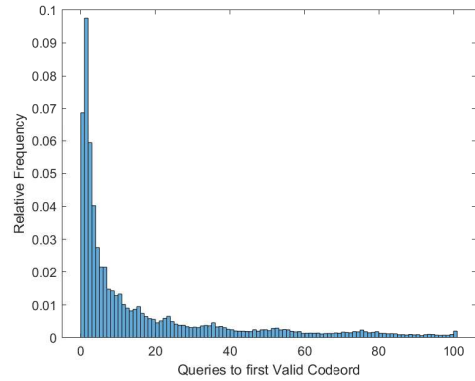

Fig. 9. Relative frequency of the number of queries to the first valid codeword, up to 100 queries. As expected, the relative frequency gradually reduces for larger queries.

and it is calculated as the weighted average of all possible outcomes, where the weights are the probabilities of each outcome. The probability of the outcome, here finding a valid codeword, changes by SNR and by the size of the search space. If we consider  $X$  as a random variable representing the abscissa,  $x_i$  in Fig. 9 and  $p_i$  as the relative frequency, then  $E(X) \approx \sum_i x_i q_i$ . The reduction in the sample space changes (increases) the probability of the outcomes,  $q_i$ . On the other hand, the relative frequency of small  $x_i$  is considerably larger than large ones, the expected value is shifted towards a smaller value, i.e., the expected value of queries will decrease. Furthermore, the probability of finding the first valid codeword after  $k \geq 1$  queries is  $P(X = k) \approx \prod_{i=1}^{k-1} (1 - q_i) q_k$ . Note that unlike geometric distribution, we do not assume  $q_i = q_j$  for any  $i \neq j$ .

Now, let us consider two scenarios:

- **Queries without abandonment:** In this scenario, the segmented ORBGRAND cannot improve the BLER as there is no query constraint for finding the first valid codeword. However, due to the smaller search space, the segmented ORBGRAND is expected to find the codeword with fewer queries, hence it has a lower average complexity. This scenario applies to queries with abandonment given the abandonment threshold  $b$  is large enough to have a valid codeword within. According to Theorem 2 in [17], GRAND algorithms find the error pattern after approximately  $2^{n-k}$  queries. For instance, this approximation of query bound for eBCH(128,106) is 4,194,304.
- **Queries with abandonment:** In this scenario, similar to the queries without abandonment, we have a reduction in complexity. Moreover, the abandonment threshold  $b$  limits the scope of queries leading to potential decoding failure in ORBGRAND. Fig. 10 (a) illustrates the failure due to the limited scope of the search. As can be seen, the reduction of search space in (b) helps the valid codeword fall into the scope of queries with threshold  $b$ . Observe that this scenario is equivalent to an increase in  $b$ .

As the maximum query in practice could be a bottleneck of the

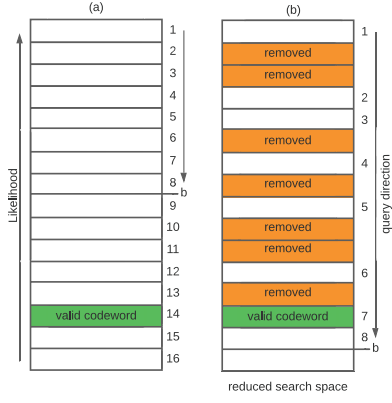

Fig. 10. A sketch showing a stack of candidate sequences sorted in descending order with respect to a likelihood metric (the codeword at the top has the highest likelihood). With no abandonment condition, removing the invalid sequences accelerates reaching the first valid codeword by fewer queries (7 queries versus 14 queries). With abandonment after  $b = 8$  queries, case (a) will fail to reach the valid codeword.

system and therefore it is important to evaluate the decoding performance and complexity under the abandonment scenario, we consider these two scenarios in the evaluation of segmented ORBGRAND in section IX.

### VIII. IMPLEMENTATION CONSIDERATIONS

In this section, we propose a procedure to efficiently perform the first and second levels of weight partitioning with the required number of parts. Recall that in the first level of integer partitioning where we partition  $w_L$  into  $[w_L^{(1)} w_L^{(2)} \dots w_L^{(p)}]$ , every  $w_L^{(j)}$ ,  $j \in [1, p]$  does not need to be a distinct integer, to sum up to  $w_L$  (i.e., repetition is allowed). However, in the second level of integer partitioning, sub-weight  $w_L^{(j)}$  should be partitioned into distinct parts with 1) either an even or odd number of parts if there exists an  $s_j$  associated with the segment, such as segment  $S_{j_2}$  in Example 2, or 2) both even and odd parts if there is no  $s_j$  associated with it, such as segment  $S'_{j_2}$  in Example 2. In [28], we assumed that we generate all distinct parts, regardless of having an even or odd number of parts, and then we discard the unwanted ones by pre-evaluation. Consider the case where we have an all-one row in parity check matrix  $\mathbf{H}$ , i.e., overall parity, if we can generate only odd or even number of distinct parts in level-2 partitioning, instead of discarding the unwanted ones, that can save reduce the number generated patterns for checking by half. We have a similar requirement in the segmented GRAND.

Luckily, there is a simple procedure to generate distinct integers ( for level-2 partitioning) with only an even number of parts or an odd number of parts that is hardware compatible as well. This procedure is illustrated in Algorithm 1. An example for integer partitioning of  $w = 18$  into  $t = 4$  distinct parts is illustrated in Fig. 11. We use this example along with Algorithm 1 to explain the procedure.

The procedure for every integer  $w = w_L^{(j)}$ ,  $j \in [1, p]$  starts with an initial sequence  $\mathbf{p}$  of  $t$  elements as shown below:

This initialization is performed in lines 2-3 of Algorithm 1. Before the generation of the next sequence of integer parts,

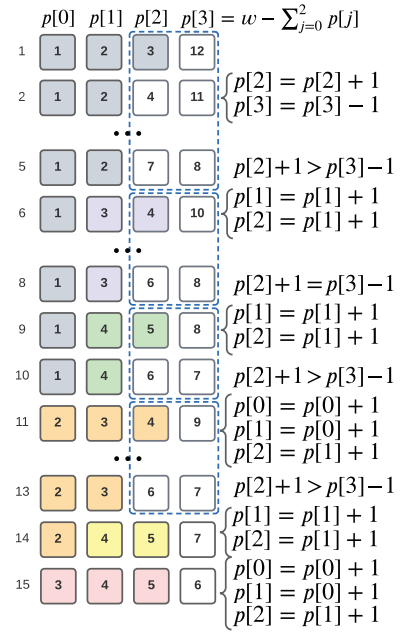

Fig. 11. An example showing integer partitioning procedure for  $w = 18$  into four distinct integers,  $k = 4$ .

$$\mathbf{p} \begin{matrix} p[0] & p[1] & p[2] & \dots & p[t-2] & p[t-1] = w - \sum_{j=0}^{t-2} p[j] \\ \boxed{1} & \boxed{2} & \boxed{3} & \dots & \boxed{t-1} & \boxed{\phantom{t-1}} \end{matrix}$$

we check to see which of the following two operations should be sought.

- 1) Increment-and-decrement: If we have  $p[t-2]+1 < p[t-1]-1$ , we keep the sub-sequence  $p[0], p[1], \dots, p[t-3]$  while incrementing  $p[t-2] = p[t-2] + 1$  and decrementing  $p[t-1] = p[t-1] - 1$ . These operations are performed in the last two parts in white cells, circled by blue dashed lines in Fig. 11 except for the first sequence in the circle that plays the role of the basis for these operations. As long as  $i = 1$  in for loop in lines 12-23 in Algorithm 1, this operation continues to generate new sequences. Resuming this loop is performed by line 21. Note that the assignment in line 14 of Algorithm 1 is the general form for any  $i$ . For instance, we can get line 12 by substituting  $i = 1$  in line 14. Here, we showed them separately because we predominantly have  $i = 1$ .

$$\mathbf{p} \begin{matrix} p[0] & p[1] & p[2] & \dots & p[t-2] & p[t-1] \\ \boxed{\phantom{1}} & \boxed{\phantom{2}} & \boxed{\phantom{3}} & \dots & \boxed{\phantom{t-1}} & \boxed{\phantom{t-1}} \\ \text{unchanged} & & & & \text{incremented} & \text{decremented} \end{matrix}$$

- 2) Re-initialization: If we have  $p[t-2]+1 \geq p[t-1]-1$ , we would have non-distinct parts in the sequence in the case of equality or repeated sequence when inequality holds. Hence, we need to change the other parts, i.e.,  $p[t-1-i]$ ,  $t-1 \leq i \leq 2$ . The extent of change is determined by some  $i > 1$  such that the condition in line 15 is met.

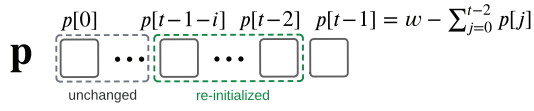

The re-initialization for such an  $i$  will be as follows:

$$[p[t-1-i]+1, p[t-1-i]+2, \dots, p[t-1-i]+i+1]$$

For instance, in Fig. 11, the sequences 6,9, and 14 are re-initialized when  $i = 2$  and the sequences 11 and 15 when  $i = 3$ . Note that when  $i = t - 1$ , i.e., all parts except for  $p[t-1]$  are re-initialized and still the condition  $p[t-2] + 1 \geq p[t-1] - 1$  in line 15 is not met, the process ends. This means all the possible options for parts have been checked.

As mentioned in Section II, no parts can be larger than the length of the code. Here, we need to consider this as well for the length of the segment denoted by  $p_{\max}$  in Algorithm 1 as you can observe in lines 6 and 18.

A similar procedure can be used for the first level of integer partitioning for the error pattern bases by lifting the constraint on the distinctness of the parts and allowing the permutation. However, we need to consider the minimum sub-weight (1 or 3 depending on  $s_j$ ) that each segment can take. Given these differences, one can observe that the initialization of non-frozen segments can allow repetition of 1's or 3's, instead of distinct values of 1, 2, 3,  $\dots$ . For instance, for three segments with  $s_1 = s_2 = 1, s_3 = 0$  and base [1 1 1], we can start the above procedure for  $w_L = 7$  with  $\mathbf{p} = [1 \ 1 \ 5]$ , then we proceed with  $\mathbf{p} = [1 \ 2 \ 4]$ ,  $\mathbf{p} = [1 \ 3 \ 3]$ . The rest are  $\mathbf{p} = [2 \ 1 \ 4]$ ,  $\mathbf{p} = [2 \ 2 \ 3]$ , and finally,  $\mathbf{p} = [3 \ 1 \ 3]$ . In this example, the order of re-initialization is the same as Fig. 11.

## IX. NUMERICAL RESULTS

We consider two sample codes for the numerical evaluation of the proposed approach. The polarization-adjusted convolutional (PAC) code (64,44) [31] is constructed with Reed-Muller-polar rate-profile with design-SNR=2 dB and convolutional generator polynomial [1, 0, 1, 1, 0, 1, 1]. The extended BCH code (128,106) with the primitive polynomial  $D^7 + D^3 + 1$  and  $t = 3$ . Note that the rows  $\mathbf{h}_1$  and  $\mathbf{h}_2$  in  $\mathbf{H}$  matrix for eBCH code (128, 106) satisfy the relationship  $\text{supp}(\mathbf{h}_2) \subset \text{supp}(\mathbf{h}_1)$  where  $\mathbf{h}_2 = \mathbf{1}$  and  $|\mathbf{h}_1|/2 = |\mathbf{h}_2| = 64$ . Hence, for two constraints, we modify  $\mathbf{h}_1$  by  $\mathbf{h}_1 = \mathbf{h}_1 \oplus \mathbf{h}_2$ . Similarly, the rows  $\mathbf{h}_1, \mathbf{h}_4,$  and  $\mathbf{h}_5$  in  $\mathbf{H}$  matrix for PAC code (64, 44) satisfy the relationship  $\text{supp}(\mathbf{h}_5) \subset \text{supp}(\mathbf{h}_4) \subset \text{supp}(\mathbf{h}_1)$  where  $\mathbf{h}_1 = \mathbf{1}$  and  $|\mathbf{h}_1|/2 = |\mathbf{h}_4| = 2|\mathbf{h}_5| = 32$ .

Figs. 12 and 13 show the block error rates (BLER) of the PAC code (64, 44) and the extended BCH code (128,106), respectively, under the conventional ORBGRAND with no constraints (NoC) and the segmented GRAND with the maximum number of queries based on (5) (a.k.a) abandonment threshold  $b = 10^5, 10^6$ . Note that the threshold  $b$  in GRAND algorithms should be approximately  $2^{n-k}$  queries [17, Theorem 2] to find the error pattern and get reasonable performance.

---

### Algorithm 1: Non-recursive integer partitioning to a fixed number of distinct parts

---

**input** : sub-weight  $w$ , part size  $t$ , largest part  $p_{\max} = n$

**output**:  $\mathcal{P}$

```

1  $\mathcal{P} \leftarrow \{\}$ 
2  $\mathbf{p} \leftarrow [1, 2, \dots, t-1]$ 
3  $\mathbf{p} \leftarrow \mathbf{p} + [w - \text{sum}(\mathbf{p})]$ 
4 if  $p[t] \leq p[t-1]$  then
5   return  $\mathcal{P}$ 
6 if  $p[t] \leq p_{\max}$  then
7    $\mathcal{P} \leftarrow \mathcal{P} \cup \{\mathbf{p}\}$ 
8  $\text{incr\_decr} \leftarrow \text{True}$  // Operation:
   Interment-and-decrement
9 while  $\text{True}$  do
10  for  $i$  in  $[1, t-1]$  do
11    if  $i = 1$  then
12       $p^* \leftarrow p[t-1] - 1$ 
13    else
14       $p^* \leftarrow w - (i \cdot p[t-1-i] + \sum_{j=1}^i j) - \sum_{j=0}^{t-2-i} p[j]$ 
15    if  $p[t-1-i] + i < p^*$  then
16       $\mathbf{p} \leftarrow \mathbf{p}[0:t-2-i] + [p[t-1-i]+1, p[t-1-i]+2, \dots, p[t-1-i]+i+1]$ 
17       $\mathbf{p} \leftarrow \mathbf{p} + [w - \text{sum}(\mathbf{p})]$ 
18      if  $p[t-1] \leq p_{\max}$  then
19         $\mathcal{P} \leftarrow \mathcal{P} \cup \{\mathbf{p}\}$ 
20       $\text{incr\_decr} \leftarrow \text{True}$ 
21      break
22    else
23       $\text{incr\_decr} \leftarrow \text{False}$ 
24  if  $\text{incr\_decr} = \text{False}$  and  $i = t-1$  then
25    break
26 return  $\mathcal{P}$ 

```

---

As expected, the average queries reduce significantly for both codes under segmented ORBGRAND. In the case of PAC code (64,44), the average queries become half at high SNR regimes while this reduction is larger at low SNR regimes. The reduction of average queries for eBCH(128,106) is more significant under the same abandonment thresholds as the short PAC code. Note that the average queries for the short PAC code with different  $b$ 's are approaching at high SNR regimes due to the effectiveness of smaller  $b$  at this code length. Furthermore, there is a BLER improvement where  $b = 10^5$  however this improvement diminishes by increasing  $b$  or under no abandonment as we will observe later. Note that unlike the comparisons in [28] where the BLER was fixed and the impact of applying constraints on the average queries was studied, here we fix the maximum number of queries  $b$  for both conventional ORBGRAND and segmented ORBGRAND to have a fair comparison. As discussed in Section VII, in case

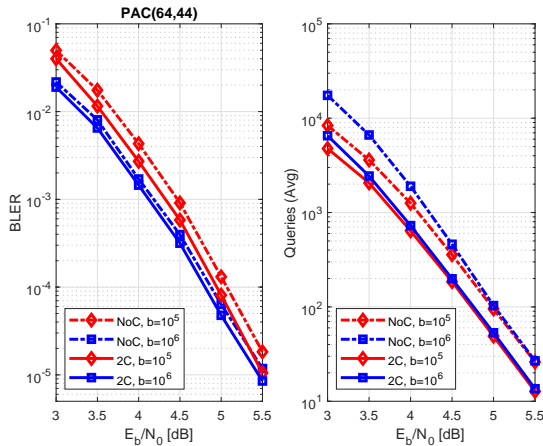

Fig. 12. Performance comparison between three sub-pattern generators based on three constraints (3C) and a single generator with no constraints (NoC). The vertical axis is on the logarithmic scale for both queries and BLER.

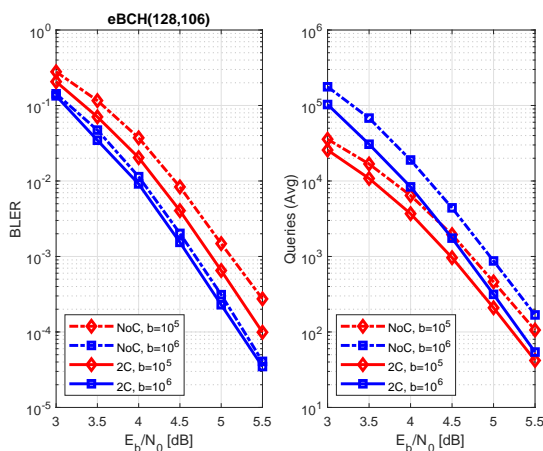

Fig. 13. Performance comparison between three sub-pattern generators based on two constraints (2C) and a single generator with no constraints (NoC).

of decoding failure by ORBGRAND, if we reduce the search space, we don't have to process many invalid error patterns. As a result, the first valid pattern may fall within the abandonment threshold  $b$  and the segmented ORBGRAND would succeed.

The table below shows the average queries of two codes at  $E_b/N_0 = 5$  dB (with two/three constraints, denoted by 2C/3C, and with no constraints/segmentation, denoted by NoC). The average queries reduce by halves (in the case of two segments, it is slightly less than half while in the case of three segments, it is more than half).

	PAC(64,44)		eBCH(128,106)	
	NoC	3C	NoC	2C
$b = 10^3$	95.1	49.0	460.7	208.9
$b = 10^6$	103.3	53.2	872.7	314.9

Note that if we maintain the BLER, the average query reduction is expected to approximately follow Lemma 1 as it was shown numerically in [28]. Note that here, with abandonment threshold, further reduction to meet the expectation in Lemma 1 is traded with BLER improvement.

Now, let us consider ORBGRAND without abandonment.

Fig. 14 compares the BLER and the (average) complexity of eBCH(128,106) under various decoding algorithms. The main benchmark is naturally ORBGRAND. Compared to ORBGRAND, the segmented ORBGRAND reduces the average number of queries by three times, while the BLER remains almost the same as before. We also compare it with the most popular MRB-based decoding algorithm, that is, ordered statistics decoding (OSD) with order  $i$ , as its relationship with its variants such as the box-and-match algorithm (BMA) [11] and enhanced BMA [12] is known. Moreover, the reduction in the complexity of the variant comes at the cost of the increase in space complexity which makes the comparison unfair. For instance, the BMA reduces the computational complexity of OSD roughly by its squared root at the expense of memory, as the BMA with order  $i$  considers all error patterns of weight at most  $2i$  over  $s$  most reliable positions ( $s > k$ ). The BLER of OSD(2) is remarkable compared to other algorithms while it provides a reasonable complexity at low SNR regimes. Whereas ORBGRAND requires considerably fewer queries at high SNR regimes at the cost of degradation in BLER performance.

The other two algorithms used for comparison are Berlekamp-Massey Algorithm and Chase-II algorithm. Chase-II algorithm, denoted by Chase-II( $t$ ), for decoding a code with the error-correcting capability of  $t$  has the computational complexity of order  $2^t \cdot O(\text{HD})$  as it uses a hard decision (HD) decoder, such as the Berlekamp-Massey Algorithm with the complexity of order  $O(n^2)$ , in  $2^t$  times as the decoder attempts all the error patterns with weight up to  $t = \lfloor \frac{d_{min}-1}{2} \rfloor$  over the  $t$  least reliable positions, hence,  $\sum_{j=0}^t \binom{t}{j} = 2^t$ . In the case of eBCH(128,106), we have  $t = 3 = \lfloor \frac{d_{min}-1}{2} \rfloor$  where  $d_{min} = 7$ . As can be seen, the BLER of the Berlekamp-Massey Algorithm and Chase-II algorithm is not comparable with OSD and ORBGRAND though they have a computational complexity of orders  $O(2^{14})$  and  $8 \cdot O(2^{14})$ , respectively. Furthermore, we observed that by increasing the total attempts to  $2^t = 2^8$ , the Chase-II algorithm can approach the BLER of ORBGRAND as shown in Fig. 14.

It is worth noting that our observation showed that OSD(3) with significantly higher complexity, does not meaningfully improve the performance of eBCH(128,106) as OSD(2) has almost reached the ML performance. Hence, we did not plot it to have a fair comparison. Moreover, as can be seen, soft GRAND (sGRAND) as an ML decoder provides similar performance. Note that we did not plot the complexity of sGRAND as it requires sorting at each step which makes it incomparable with others though OSD also needs preprocessing (row operations to get a systematic form) as mentioned in Section I.

## X. CONCLUSION

In this paper, we propose an approach to divide the scope of searching for the error sequence induced by the channel noise with the segmentation approach. Every segment is defined based on the parity constraints extracted from the parity check matrix with or without manipulation (row operations).

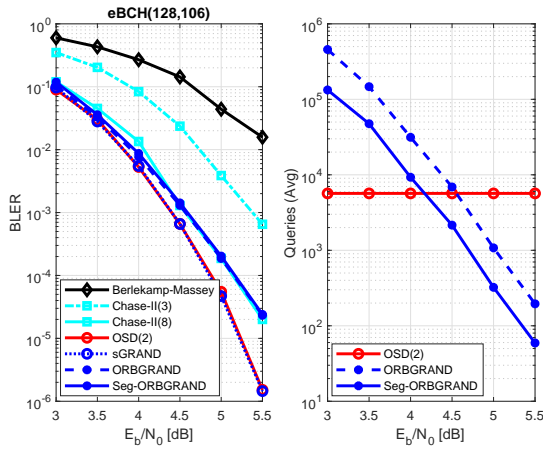

Fig. 14. Performance and complexity comparisons of various decoding algorithms for eBCH(128,106).

Then, we employ multiple error pattern generators, each for one segment. We propose a method to combine these sub-patterns in a near-ML order for checking. As this approach generates valid error patterns with respect to the selected parity constraint, both the average number of queries and the BLER performance improve remarkably.

#### REFERENCES

- [1] S. Lin and D. J. Costello, "Error Control Coding," 2nd Edition, Pearson Prentice Hall, Upper Saddle River, 2004, pp. 544-550.
- [2] E. Berlekamp, R. McEliece, and H. Van Tilborg, "On the inherent intractability of certain coding problems (corresp.)," *IEEE Tran. Inf. Theory*, vol. 24, no. 3, pp. 384-386, 1978.
- [3] G. Forney, "Generalized minimum distance decoding," in *IEEE Transactions on Information Theory*, vol. 12, no. 2, pp. 125-131, April 1966.
- [4] D. Chase, "Class of algorithms for decoding block codes with channel measurement information," in *IEEE Transactions on Information Theory*, vol. 18, no. 1, pp. 170-182, January 1972.
- [5] J. Snyders and Y. Be'ery, "Maximum likelihood soft decoding of binary block codes and decoders for the Golay codes," in *IEEE Transactions on Information Theory*, vol. 35, no. 5, pp. 963-975, Sept. 1989.
- [6] E. Prange, "The use of information sets in decoding cyclic codes," *IRE Transactions on Information Theory*, vol. 8, no. 5, pp. 59, 1962.
- [7] J. Stern, "A method for finding codewords of small weight," *Coding theory and applications*, Springer, vol. 388, pp. 106-113, 1989.
- [8] I. Dumer, "On minimum distance decoding of linear codes," *Proc. 5th Joint Soviet-Swedish Int. Workshop Inform. Theory*, Moscow, pp. 50-52, 1991.
- [9] B. Dorsch, "A decoding algorithm for binary block codes and J-ary output channels," *IEEE Trans. Inf. Theory*, vol. 20, pp. 391-394, 1974.
- [10] M. P. Fossorier and S. Lin, "Soft-decision decoding of linear block codes based on ordered statistics," *IEEE Transactions on Information Theory*, vol. 41, no. 5, pp. 1379-1396, May 1995.
- [11] A. Valembois and M. Fossorier, "Box and match techniques applied to soft-decision decoding," *IEEE Transactions on Information Theory*, vol. 50, no. 5, pp. 796-810, May 2004.
- [12] W. Jin and M. Fossorier, "Towards Maximum Likelihood Soft Decision Decoding of the (255,239) Reed Solomon Code," in *IEEE Transactions on Magnetics*, vol. 44, no. 3, pp. 423-428, March 2008.
- [13] P. Trifonov, "Algebraic Matching Techniques for Fast Decoding of Polar Codes with Reed-Solomon Kernel," 2018 *IEEE International Symposium on Information Theory (ISIT)*, Vail, CO, USA, 2018, pp. 1475-1479.
- [14] I. Dumer, "Sort-and-match algorithm for soft-decision decoding," *IEEE Trans. on Inf. Theory*, 45(7): 2333-2338, Nov. 1999.
- [15] I. Dumer, "Soft decision decoding using punctured codes," *IEEE Trans. Inf. Theory*, vol. 47, no. 1, pp. 59-71, Jan. 2001.
- [16] K. R. Duffy, J. Li, and M. Médard, "Guessing noise, not code-words," in *Proc. IEEE Int. Symp. Inf. Theory*, pp. 671-675, 2018.

- [17] K. R. Duffy, J. Li, and M. Médard, "Capacity-achieving guessing random additive noise decoding," *IEEE Transactions on Information Theory*, vol. 65, no. 7, pp. 4023-4040, July 2019.
- [18] K. R. Duffy and M. Médard, "Guessing random additive noise decoding with soft detection symbol reliability information-SGRAND," in *IEEE International Symposium on Information Theory (ISIT)*, Paris, France, July 2019.
- [19] A. Valembois and M. P. C. Fossorier, "An Improved Method to Compute Lists of Binary Vectors that Optimize a Given Weight Function with Application to Soft Decision Decoding," *IEEE Commun. Lett.*, vol. 5, pp. 456-458, Nov. 2001.
- [20] M. P. C. Fossorier, "Comments on "Guessing Random Additive Noise Decoding (GRAND)" and Related Approaches," ResearchGate, May, 2022.
- [21] K. R. Duffy, "Ordered reliability bits guessing random additive noise decoding," in *IEEE International Conference on Acoustics, Speech and Signal Processing (ICASSP)*, Toronto, Canada, June 2021.
- [22] K. R. Duffy, W. An and M. Médard, "Ordered Reliability Bits Guessing Random Additive Noise Decoding," in *IEEE Transactions on Signal Processing*, vol. 70, pp. 4528-4542, 2022.
- [23] C. Condo, V. Bioglio and I. Land, "High-performance low-complexity error pattern generation for ORBGRAND decoding," 2021 *IEEE Globecom Workshops*, 2021, pp. 1-6.
- [24] S. M. Abbas, T. Tonnellier, F. Ercan, M. Jalaeddine and W. J. Gross, "High-Throughput and Energy-Efficient VLSI Architecture for Ordered Reliability Bits GRAND," in *IEEE Transactions on Very Large Scale Integration (VLSI) Systems*, vol. 30, no. 6, pp. 681-693, June 2022.
- [25] S. M. Abbas, M. Jalaeddine and W. J. Gross, "List-GRAND: A Practical Way to Achieve Maximum Likelihood Decoding," in *IEEE Transactions on Very Large Scale Integration (VLSI) Systems*, vol. 31, no. 1, pp. 43-54, Jan. 2023.
- [26] A. Riaz et al., "Multi-Code Multi-Rate Universal Maximum Likelihood Decoder using GRAND," *ESSCIRC 2021 - IEEE 47th European Solid State Circuits Conference (ESSCIRC)*, 2021, pp. 239-246.
- [27] C. Condo, "A Fixed Latency ORBGRAND Decoder Architecture With LUT-Aided Error-Pattern Scheduling," in *IEEE Transactions on Circuits and Systems I: Regular Papers*, vol. 69, no. 5, pp. 2203-2211, May 2022.
- [28] M. Rowshan and J. Yuan, "Constrained Error Pattern Generation for GRAND," 2022 *IEEE International Symposium on Information Theory (ISIT)*, 2022, pp. 1767-1772, doi: 10.1109/ISIT50566.2022.9834343.
- [29] S. Heubach and T. Mansour, *Combinatorics of Compositions and Words*. Boca Raton, Florida: CRC Press, 2009.
- [30] M. Rowshan and E. Viterbo, "List Viterbi Decoding of PAC Codes," in *IEEE Transactions on Vehicular Technology*, vol. 70, no. 3, pp. 2428-2435, March 2021, doi: 10.1109/TVT.2021.3059370.
- [31] E. Arkan, "From sequential decoding to channel polarization and back again," arXiv preprint arXiv:1908.09594 (2019).