

Probabilistic Wind Power Forecasting with Missing Values via Adaptive Quantile Regression

Honglin Wen, *Member, IEEE*,

Abstract—Missing values challenge the probabilistic wind power forecasting at both parameter estimation and operational forecasting stages. In this paper, we illustrate that we are allowed to estimate forecasting functions for each missing patterns conveniently, and propose an adaptive quantile regression model whose parameters can adapt to missing patterns. For that, we particularly design a feature extraction block within the quantile regression model, where parameters are set as a function of missingness pattern and only account for observed values. To avoid the quantile-crossing phenomena, we design a multi-task model to ensure the monotonicity of quantiles, where higher quantiles are derived by the addition between lower quantiles and non-negative increments modeled by neural networks. The proposed approach is distribution-free and applicable to both missing-at-random and missing-not-at-random cases. Case studies demonstrate that the proposed approach achieves the state-of-the-art in terms of the continuous ranked probability score.

Index Terms—Probabilistic forecasting, machine learning, missing values, adaptive quantile regression, quantile-crossing.

I. INTRODUCTION

Probabilistic wind power forecasting is deemed as the workhorse to accommodate wind power uncertainty in power system operations and electricity markets. It leverages the information up to the current time and communicates the probability distribution of wind power generation at a future time in the forms of quantiles, prediction intervals, densities, etc [1]. It has been adopted in several power system applications such as energy trading [2] as well as reserve management [3], and has attracted increasing interest from the industries [4].

Usually, probabilistic wind power forecasting models are developed in a data-driven manner via parametric or non-parametric approaches [5]. The parametric approach assumes that wind power generation follows some kind of distribution (for instance Gaussian), and estimates the shape parameters via machine learning methods, whereas the non-parametric approach is distribution-free. Among the non-parametric approaches, quantile regression (QR) [6] is the most popular one, since it is easy to use and achieves the state of the art in several forecasting competitions. However, it requires estimating a separate model for each quantile level, which often leads to embarrassing quantile-crossing phenomena, i.e., higher quantiles are smaller than lower quantiles. Recently, it has been proposed a continuous and distribution-free probabilistic forecasting approach, which is allowed to predict the full distribution at once by transforming the base distribution to the desired one [7] and therefore avoids the quantile-crossing phenomena by nature. Specifically, both the base distribution and transforms are learned via machine learning.

Although forecasting approaches and products have developed a lot by leveraging cutting-edge techniques [8], [9] as well as data sharing mechanisms [10]–[12], the forecasting community has less investigated missing values within datasets. In fact, missing values are inevitable in real-world data, which may be caused by sensor failures and communication errors, for instance. In modern statistical theory, missingness mechanisms can be classified into missing completely at random (MCAR), missing at random (MAR), and missing not at random (MNAR) cases, according to if missingness is dependent on observed or missing values. For example, missingness caused by sensor failures usually belongs to the MCAR mechanism (as it is irrelevant to observed or missing values), whereas missingness caused by wind power curtailment belongs to the MNAR mechanism (as it often occurs at high wind speeds, i.e., the missingness depends on missing values). Intuitively, missing values challenge the calculation of model prediction. For that, a natural idea is to impute missing values before training and forecasting [13], which is referred to as the “impute, then predict” strategy. It has also been proposed to perform the imputation and forecasting tasks simultaneously based on deep learning techniques [14], which is adopted in the DeepAR model [15]. However, it is suggested that even optimal single imputed data lead to biased parameter estimation and prediction, since the uncertainty about the missing features is discarded [16]. Alternatively, one can leverage multiple imputations [17], [18] on the training data, and then develop a family of models, but it brings issues with tractability. Therefore, it remains an open issue to develop probabilistic wind power forecasting approaches in the context of missing values.

Compared to the inference with missing values that aims at parameter estimation for probabilistic models or imputation [19], forecasting/prediction with missing values focuses on the quality of forecasts. The seminar works can date back to [20], [21], where authors investigate time series forecasting in the context of missing values via auto-regressive moving average (ARMA) and auto-regressive integrated moving average (ARIMA) models. They represent ARMA and ARIMA models in the state-space form and address the calculation issues aroused by missing values by skipping the state update. It is useful at both model estimation and operational forecasting stages but is restricted to point forecasts and linear models. A robust optimization approach has been proposed in [22], which minimizes the worst-case loss when a proportion of features are missing. Thus, it is applicable to both point and probabilistic forecasting by setting the corresponding loss functions. However, it only focuses on the model estimation stage and requires controlling the number of missing features. In [23], it has been proposed a “universal imputation” strategy based on the assumption that data are MAR, where missing

Honglin Wen is with the Department of Electrical Engineering, Shanghai Jiao Tong University, Shanghai, China, e-mail: (linlin00@sjtu.edu.cn).

values and targets are treated equally, and the focus is on the joint distribution of features and targets. After estimating the joint distribution, the probabilistic forecasts can be derived by marginalization with respect to features. Though it demonstrates better forecasting quality than the common used “impute, then predict” strategy, it relies on the fully conditional specification technique, the training time of which compromises its practical applications. A similar idea can be also found in [24].

In fact, given a missingness pattern of features, one can obtain the Bayes-optimal estimate for the forecasting function, e.g. mean function and quantile function via the typically used forecasting paradigm [16]. It is shown that multi-layer perceptrons (MLPs) can be Bayes consistent even in the MNAR cases [16]. However, it is intractable to train a sub-model for each missingness pattern. For features of dimension d , it may require estimating 2^d sub-models in the worst case [25]. Besides, the samples to train each submodel are considerably reduced, as it treats each missingness pattern separately. Therefore, it is appealing to develop models that are adaptive to several missingness patterns [26]. In this work, we propose an adaptive quantile regression approach by designing models with adaptive parameters and leveraging multiplication with missingness indicator [27]. That is, we set the parameters of the quantile regression model as a function of missing patterns. The model mainly consists of two modules. One is responsible for feature extraction by taking the original features with missing values as inputs, whereas the other is designed for nonlinear mapping. By using masked weight matrices in the feature extraction module, we are allowed to calculate model prediction with observations. Specifically, the bias (a part of parameters) in this module is set as the function of missingness patterns. Then, the latent features are fed into the followed module, i.e., a group of MLPs, which yield several quantile functions guided by corresponding pinball losses. To avoid the quantile-crossing phenomena, we adopt a multi-task framework similar to [28], where the higher quantiles are derived by the addition between lower quantiles and non-negative increments modeled by neural networks. We validate the proposed approach based on data from wind toolkit [29], where values are removed according to designed missingness mechanisms (including MAR and MNAR mechanisms). Case studies demonstrate that the proposed model achieves state-of-the-art in terms of continuous ranked probability score (CRPS), especially in MNAR cases.

In a nutshell, we mainly contribute a probabilistic forecasting approach with missing values by designing quantile regression models with adaptive parameters, which is applicable to both MAR and MNAR cases. The paper is organized as follows. Section II describes the preliminaries of probabilistic wind power forecasting and quantile regression. Section III formulates the problem, whereas section IV presents the proposed approach. Section V presents the setups of case studies and Section VI presents the results. Section VII concludes this paper.

Notations: we denote random variables as uppercase letters (such as Y), and their realizations as lowercase letters (such as y). We denote time as t and use it as subscripts to represent

random variables and realizations at time t , for instance, Y_t and y_t . Missing values are denoted as NA, and the observations blurred with missing values are denoted as $\tilde{y}_t \in \mathbb{R} \cup \text{NA}$. Missingness indicators are the realizations of random variable M_t and denoted as $m_t \in \{0, 1\}$, where $m_t = 1$ implies $\tilde{y}_t = \text{NA}$ and $m_t = 0$ implies $\tilde{y}_t = y_t$.

II. PRELIMINARIES

A. Probabilistic Wind Power Forecasting

Probabilistic Wind Power Forecasting aims at communicating the probabilistic distribution of wind power generation at the future time with a lead time k , i.e., Y_{t+k} . It often relies on a model \mathcal{M} with parameters θ , and leverages the information up to the current time t , i.e., \mathbf{x}_t . The information \mathbf{x}_t may include weather and wind power generation at the previous time. In this work, let us assume that \mathbf{x}_t consists of lagged wind power generation values of length h , i.e., $\mathbf{x}_t = [y_{t-h+1}, y_{t-h+2}, \dots, y_t]^\top$. Denote the cumulative distribution function (c.d.f) of Y_{t+k} as $F_{t+k}(y)$. Then, probabilistic wind power forecasting can be described as

$$\hat{F}_{t+k}(y) = F_{t+k}(y|\mathbf{x}_t; \mathcal{M}, \theta). \quad (1)$$

The model \mathcal{M} can be set as some kind of distributional model such as logit-normal distribution [8]. Alternatively, it can be set as a group of increasing quantiles. Denote the α -th quantile of Y_{t+k} as q_{t+k}^α , which is defined as

$$q_{t+k}^\alpha = F_{t+k}^{-1}(\alpha). \quad (2)$$

Then the forecast for distribution $F_{t+k}(y)$ can be also derived as

$$\{\hat{q}_{t+k}^{\alpha_1}, \hat{q}_{t+k}^{\alpha_2}, \dots, \hat{q}_{t+k}^{\alpha_m}\}, \alpha_1 < \alpha_2 < \dots < \alpha_m,$$

where $\hat{q}_{t+k}^{\alpha_i}$ is the estimated α_i -th quantile. Such quantiles can be derived via quantile regression [6]. Let $g(\mathbf{x}; \theta, \alpha)$ represent a quantile function, such that

$$q_{t+k}^\alpha = g(\mathbf{x}_t; \theta, \alpha). \quad (3)$$

In particular, it can be represented as the inner product of coefficient and latent features learned via machine learning [30]. Denote the coefficient as \mathbf{w} and the features as $\phi(\mathbf{x}_t; \theta_\phi)$, i.e., $\theta = \{\mathbf{w}, \theta_\phi\}$. We describe the function as

$$g(\mathbf{x}_t; \theta, \alpha) = \mathbf{w}^\top \phi(\mathbf{x}_t; \theta_\phi), \quad (4)$$

The parameter θ can be estimated via machine learning based on historical data $\{(\mathbf{x}_t, y_{t+k})|t = 1, 2, \dots, n\}$. Concretely, they are estimated by minimizing the pinball loss \mathcal{L} , i.e.,

$$\mathcal{L} = \frac{1}{n} \sum_t \ell(y_{t+k}, g(\mathbf{x}_t; \theta, \alpha))$$

where $\ell(y_{t+k}, g(\mathbf{x}_t; \theta, \alpha))$ is defined as

$$\begin{aligned} \ell(y_{t+k}, g(\mathbf{x}_t; \theta, \alpha)) = \\ \max(\alpha(y_{t+k} - g(\mathbf{x}_t; \theta, \alpha)), (\alpha - 1)(y_{t+k} - g(\mathbf{x}_t; \theta, \alpha))). \end{aligned} \quad (5)$$

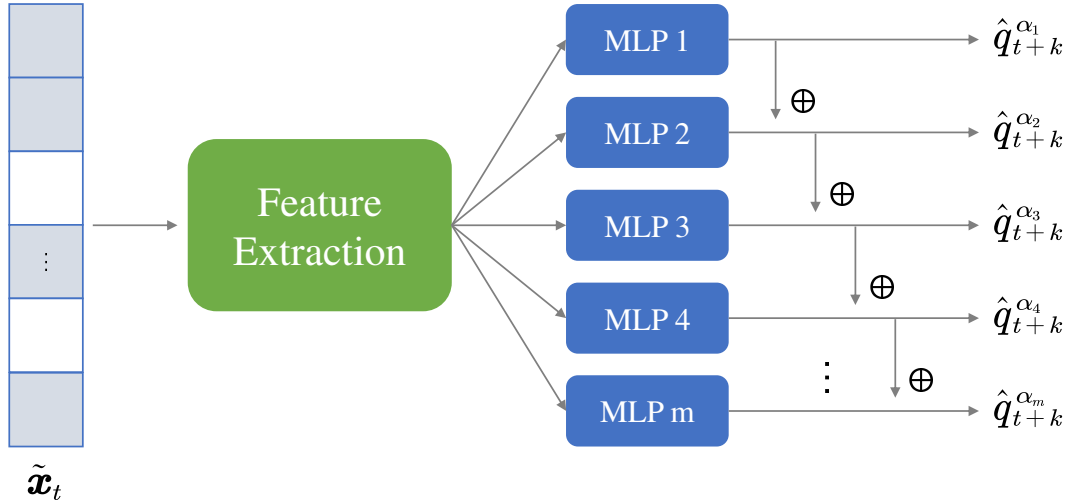

Fig. 1. The sketch of the proposed approach, where blank blocks in $\tilde{\mathbf{x}}_t$ indicate missing values.

B. Missingness Mechanism

In the modern statistical theory [19], missingness mechanisms can be classified into three categories: MCAR, MAR, and MNAR. Intuitively, the observations for both \mathbf{x}_t and y_{t+k} may contain missing values. Therefore, we write the observations as $\tilde{\mathbf{x}}_t$ and \tilde{y}_{t+k} . We introduce a missingness indicator vector $\mathbf{m}_t \in \{0, 1\}^d$ for $\tilde{\mathbf{x}}_t$, which is the realization of a random variable \mathbf{M}_t , s.t., $\tilde{x}_{t,i} = x_{t,i}$ when $m_{t,i} = 0$ and $\tilde{x}_{t,i} = \text{NA}$ when $m_{t,i} = 1$. The observed part of \mathbf{x}_t is denoted as $\mathbf{x}_{o,t} = o(\mathbf{x}_t, \mathbf{m}_t)$, whereas the missing part of \mathbf{x}_t is denoted as $\mathbf{x}_{m,t} = o(\mathbf{x}_t, 1 - \mathbf{m}_t)$.

Taking the multivariable \mathbf{x}_t as an example, the parametric model for the joint distribution of the data sample and its mask is described as

$$f(\mathbf{x}_t, \mathbf{m}_t; \xi, \psi) = f(\mathbf{x}_t; \xi) f(\mathbf{m}_t | \mathbf{x}_t; \psi), \quad (6)$$

where ξ and ψ represent the parameters of distribution for data and mask. The data sample can be split into an observed part $\mathbf{x}_{o,t}$ and a missing part $\mathbf{x}_{m,t}$, i.e., $\mathbf{x}_t = (\mathbf{x}_{o,t}, \mathbf{x}_{m,t})$. Then the missingness mechanism is referred to as MCAR if

$$f(\mathbf{m}_t | \mathbf{x}_t; \psi) = f(\mathbf{m}_t; \psi),$$

which means the missingness is independent of the data sample. The missingness mechanism is referred to as MAR if

$$f(\mathbf{m}_t | \mathbf{x}_t; \psi) = f(\mathbf{m}_t | \mathbf{x}_{o,t}; \psi).$$

That is, the missingness is dependent on $\mathbf{x}_{o,t}$, yet independent of $\mathbf{x}_{m,t}$. Similarly, the missingness mechanism is referred to as MNAR if

$$f(\mathbf{m}_t | \mathbf{x}_t; \psi) = f(\mathbf{m}_t | \mathbf{x}_t^o, \mathbf{x}_t^m; \psi),$$

i.e., the missingness is dependent on both the observed and missing values. In fact, both the real data and missing mechanisms are unavailable. Alternatively, we are only allowed to get access to $(\tilde{\mathbf{x}}_t, \tilde{y}_{t+k})$. In this work, we aim at developing a forecasting approach based on only observations without assumptions on the missingness mechanisms.

III. METHODOLOGY

In this section, we illustrate the approach to develop models directly with observations $(\tilde{\mathbf{x}}_t, \tilde{y}_{t+k})$. In what follows, we first discuss the challenge within the probabilistic wind power forecasting aroused by missing values, i.e., the discrete nature of NA. Then, we describe the idea to deal with such an issue, that is, adapting the model parameters with missingness patterns.

A. Problem Formulation

As $(\tilde{\mathbf{x}}_t, \tilde{y}_{t+k})$ has no contributions to the parameter estimation if \tilde{y}_{t+k} is missing, we only focus on samples where \tilde{y}_{t+k} is observed in the following context. Then, the estimate of parameters is derived via

$$\hat{\theta} = \arg \min_{\theta} \frac{1}{n} \sum_t \ell(\tilde{y}_{t+k}, g(\tilde{\mathbf{x}}_t; \theta, \alpha)), \quad (7)$$

though $\tilde{\mathbf{x}}_t$ contains missing values. Unfortunately, most off-the-shelf machine learning methods do not work with the half-discrete nature of $\mathbb{R} \cup \text{NA}$. Alternatively, we are allowed to estimate a quantile function for each missingness pattern by selecting samples with such missingness pattern, as suggested by [16]. For instance, for a missingness pattern $\mathcal{P}_i \in \{0, 1\}^d$, we denote the corresponding quantile function as $g_{\mathcal{P}_i}$ with parameters θ_i . It is expressed as

$$g_{\mathcal{P}_i}(\tilde{\mathbf{x}}_t; \theta_i, \alpha) = g(\mathbf{x}_{o,t}; \alpha, \theta_i, \mathbf{m}_t = \mathcal{P}_i). \quad (8)$$

Therefore, the quantile function can be constructed as a combination of functions

$$g(\tilde{\mathbf{x}}_t; \theta, \alpha) = \begin{cases} g_{\mathcal{P}_1}(\tilde{\mathbf{x}}_t; \theta_1, \alpha), & \mathbf{m}_t = \mathcal{P}_1, \\ g_{\mathcal{P}_2}(\tilde{\mathbf{x}}_t; \theta_2, \alpha), & \mathbf{m}_t = \mathcal{P}_2, \\ \dots & \dots \\ g_{\mathcal{P}_{2^d}}(\tilde{\mathbf{x}}_t; \theta_{2^d}, \alpha), & \mathbf{m}_t = \mathcal{P}_{2^d}. \end{cases} \quad (9)$$

Intuitively, it requires estimating 2^d sub-models, which scales exponentially with the dimension and is therefore impractical.

B. Method

To address the aforementioned tractability issue, we seek to develop a model whose parameters can adapt to missingness patterns. It is described as

$$g(\tilde{\mathbf{x}}_t; \boldsymbol{\theta}(\mathbf{m}_t), \alpha).$$

For that, we expect the feature function $\phi(\cdot)$ can adapt to missingness patterns, i.e.,

$$g(\tilde{\mathbf{x}}_t; \boldsymbol{\theta}(\mathbf{m}_t), \alpha) = \mathbf{w}^\top \phi(\tilde{\mathbf{x}}_t; \boldsymbol{\theta}_\phi(\mathbf{m}_t)). \quad (10)$$

Specifically, we design the feature function $\phi(\cdot)$ as a composition of $\phi_1(\cdot)$ and $\phi_2(\cdot)$, where $\phi_1(\cdot)$ is a linear function with parameters $\boldsymbol{\theta}_{\phi_1}$ and $\phi_2(\cdot)$ is a nonlinear function with parameters $\boldsymbol{\theta}_{\phi_2}$. We have

$$\phi(\tilde{\mathbf{x}}_t; \boldsymbol{\theta}_\phi(\mathbf{m}_t)) = \phi_2(\phi_1(\tilde{\mathbf{x}}_t; \boldsymbol{\theta}_{\phi_1}(\mathbf{m}_t)), \boldsymbol{\theta}_{\phi_2}), \quad (11)$$

where $\boldsymbol{\theta}_{\phi_1}$ is a function of \mathbf{m}_t . Let \mathbf{z}_t denote the output of $\phi_1(\tilde{\mathbf{x}}_t; \boldsymbol{\theta}_{\phi_1}(\mathbf{m}_t))$, i.e.,

$$\mathbf{z}_t = \phi_1(\tilde{\mathbf{x}}_t; \boldsymbol{\theta}_{\phi_1}(\mathbf{m}_t)).$$

Obviously, NA will not contribute to \mathbf{z}_t . Thus, we define $\phi_1(\cdot)$ as a function that outputs the linear combination of observations in $\tilde{\mathbf{x}}_t$, which is described as

$$\begin{aligned} z_{t,i} &= \sum_{j: m_{t,j}=0} \mathbf{W}_{\phi_1}(\mathbf{m}_t)[i, j] \tilde{x}_{t,j} + \mathbf{b}_{\phi_1}(\mathbf{m}_t)[i] \\ &= \mathbf{W}_{\phi_1}(\mathbf{m}_t)[i, :] \text{diag}(1 - \mathbf{m}_t) \tilde{\mathbf{x}}_t + \mathbf{b}_{\phi_1}(\mathbf{m}_t)[i], \end{aligned} \quad (12)$$

where $\mathbf{W}_{\phi_1}(\mathbf{m}_t)$ and $\mathbf{b}_{\phi_1}(\mathbf{m}_t)$ are the parameters of $\phi_1(\cdot)$, i.e., $\boldsymbol{\theta}_{\phi_1} = \{\mathbf{W}_{\phi_1}(\mathbf{m}_t), \mathbf{b}_{\phi_1}(\mathbf{m}_t)\}$, and $\text{diag}(\cdot)$ returns a square diagonal matrix with the elements of the input vector. Then \mathbf{z}_t is used as the input to $\phi_2(\cdot)$, i.e.,

$$q_{t+k}^\alpha = \mathbf{w}^\top \phi_2(\mathbf{z}_t; \boldsymbol{\theta}_{\phi_2}).$$

IV. PROPOSED APPROACH

With the main idea described in Section III, we now describe the proposed approach in detail. The linear function $\phi_1(\cdot)$ is implemented similar to the NeuMiss block proposed in [27], whereas the nonlinear function $\phi_2(\cdot)$ is implemented as an MLP. In particular, we place the quantile regression model in a multi-task framework and ensure the monotonicity of quantiles. We sketch the proposed approach in Figure 1, which consists of a feature extraction block and several MLPs correlated with previous ones via addition successively.

A. Feature Extraction

In the feature extraction block, we replace NA in $\tilde{\mathbf{x}}_t$ with 0, and denote it as $\hat{\mathbf{x}}_t$, which operates as

$$\hat{\mathbf{x}}_t = \tilde{\mathbf{x}}_t \odot (1 - \mathbf{m}_t),$$

where \odot is an elementwise product operator. Then equation (12) can be also rewritten compactly as

$$\mathbf{z}_t = \mathbf{W}_{\phi_1}(\mathbf{m}_t) \hat{\mathbf{x}}_t + \mathbf{b}_{\phi_1}(\mathbf{m}_t) \quad (13)$$

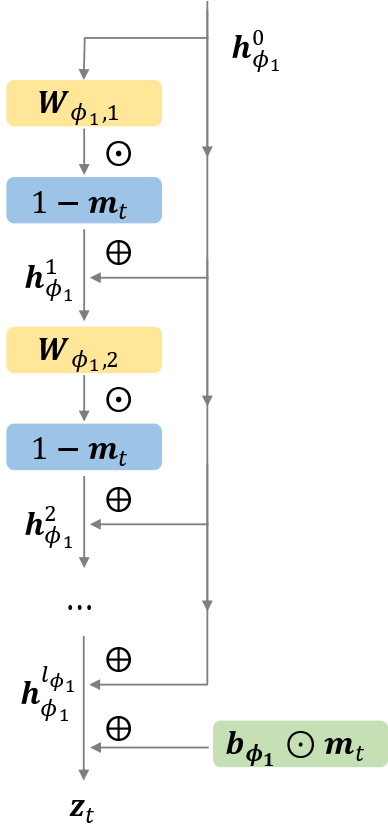

Fig. 2. The structure of feature extraction block.

In particular, we use a special case of adaptive regression where $\mathbf{W}_{\phi_1}(\mathbf{m}_t)$ are static whereas $\mathbf{b}_{\phi_1}(\mathbf{m}_t)$ is a function of the missingness patterns. Specifically, we set $\mathbf{b}_{\phi_1}(\mathbf{m}_t)$ as

$$\mathbf{b}_{\phi_1}(\mathbf{m}_t) = \mathbf{b}_{\phi_1} \odot \mathbf{m}_t. \quad (14)$$

Then equation (13) can be rewritten as

$$\mathbf{z}_t = \mathbf{W}_{\phi_1} \hat{\mathbf{x}}_t + \mathbf{b}_{\phi_1} \odot \mathbf{m}_t. \quad (15)$$

In this work, we design the feature extraction block similar to the NeuMiss model proposed in [27], which is illustrated in Figure 2. Consider that we stack l_{ϕ_1} such blocks via skip connections. For the l -th block, we denote its input as $h_{\phi_1}^{l-1}$, and its output as $h_{\phi_1}^l$. Specially, $h_{\phi_1}^0 = \hat{\mathbf{x}}_t$. For each block, we have

$$h_{\phi_1}^l = \mathbf{W}_{\phi_1}^l h_{\phi_1}^{l-1} \odot (1 - \mathbf{m}_t) + h_{\phi_1}^0, \quad (16)$$

where $\mathbf{W}_{\phi_1}^l$ is the weight matrix in the l -th block. The output of the last block is denoted as $h_{\phi_1}^{l_{\phi_1}}$. Then, the latent features \mathbf{z}_t is derived by adding $h_{\phi_1}^{l_{\phi_1}}$ with $\mathbf{b}_{\phi_1} \odot \mathbf{m}_t$, i.e.,

$$\mathbf{z}_t = h_{\phi_1}^{l_{\phi_1}} + \mathbf{b}_{\phi_1} \odot \mathbf{m}_t, \quad (17)$$

which is further fed into nonlinear functions to yield quantiles.

B. Non-crossing Quantile Regression Neural Network

Specifically, we define a non-negative nonlinear function ϕ_{2,α_i} for each quantile level α_i . Accordingly, we respectively

denote the coefficient and parameters as \mathbf{w}_{α_i} and $\boldsymbol{\theta}_{\phi_2, \alpha_i}$. The quantile function $q_{t+k}^{\alpha_1}$ is derived by the composition of $\phi_1(\cdot)$ and $\phi_{2, \alpha_1}(\cdot)$, i.e.,

$$\begin{aligned} q_{t+k}^{\alpha_1} &= g(\tilde{\mathbf{x}}_t; \boldsymbol{\theta}_1, \alpha_1) \\ &= \mathbf{w}_{\alpha_1}^\top \phi_{2, \alpha_{\phi_1}}(\phi_1(\tilde{\mathbf{x}}_t; \boldsymbol{\theta}_{\phi_1}); \boldsymbol{\theta}_{\phi_2, \alpha_1}). \end{aligned} \quad (18)$$

As for the quantile level α_i ($i > 1$), we derive the quantile function $q_{t+k}^{\alpha_i}$ by adding $q_{t+k}^{\alpha_{i-1}}$ with an increment, which is set as the composition of $\phi_1(\cdot)$ and $\phi_{2, \alpha_i}(\cdot)$. It is described as

$$\begin{aligned} q_{t+k}^{\alpha_i} &= g(\tilde{\mathbf{x}}_t; \boldsymbol{\theta}_i, \alpha_i) \\ &= q_{t+k}^{\alpha_{i-1}} + \mathbf{w}_{\alpha_i}^\top \phi_{2, \alpha_i}(\phi_1(\tilde{\mathbf{x}}_t; \boldsymbol{\theta}_{\phi_1}); \boldsymbol{\theta}_{\phi_2, \alpha_i}). \end{aligned} \quad (19)$$

As ϕ_{2, α_i} is non-negative, we have

$$q_{t+k}^{\alpha_{i-1}} \leq q_{t+k}^{\alpha_i}.$$

Each function ϕ_{2, α_i} is implemented with an l_{ϕ_2} -layer MLP, where each layer takes $\mathbf{h}_{\phi_2, \alpha_i}^{l-1}$ as input, and output $\mathbf{h}_{\phi_2, \alpha_i}^l$. Specially, \mathbf{z}_t is denoted as $\mathbf{h}_{\phi_2, \alpha_i}^0$. The l -th layer operates as

$$\mathbf{h}_{\phi_2, \alpha_i}^l = \mathbf{W}_{\phi_2, \alpha_i}^l \mathbf{h}_{\phi_2, \alpha_i}^{l-1} + \mathbf{b}_{\phi_2, \alpha_i}^l, \quad (20)$$

where $\mathbf{W}_{\phi_2, \alpha_i}^l$ and $\mathbf{b}_{\phi_2, \alpha_i}^l$ respectively represent the weight and bias in this layer. It is followed by a Relu function $\sigma(\cdot)$, which operates as

$$\sigma(\mathbf{h}_{\phi_2, \alpha_i}^l) = \max(\mathbf{h}_{\phi_2, \alpha_i}^l, \mathbf{0}), \quad (21)$$

where \max returns the maximum between $\mathbf{h}_{\phi_2, \alpha_i}^l$ and $\mathbf{0}$ elementwisely.

To estimate all the parameters, we minimize the total loss, which is defined as

$$\mathcal{L} = \frac{1}{n \times m} \sum_t \sum_i \ell(\tilde{y}_{t+k}, g(\tilde{\mathbf{x}}_t; \boldsymbol{\theta}_i, \alpha_i)). \quad (22)$$

V. CASE STUDY

In this section, we describe the data for case validation, which come from the open-source wind toolkit [29]. Then we introduce experimental setups, where missingness is simulated based on different mechanisms. After that, we describe benchmark models and qualification metrics.

A. Data Description

As we focus on very short-term wind power forecasting, here we use a wind power measurement dataset collected from a wind farm located in South Carolina. It is an hourly dataset where values are normalized by its capacity, and spans from 2007 to 2013. In each case, we split the first 70% of data for training models, the following 10% of data for validation, and the last 20% of data for genuine forecast verification.

B. Experimental Setups

In this work, we simulate missingness based on both MAR and MNAR mechanisms. For the MAR mechanism, we consider missingness that spread sporadically and in blocks, though it is independent of the wind power generation value. As for the MNAR mechanism, we consider a self-masking case, where values greater than a threshold will be missing. The designed 3 cases are described as follows:

1) *Case 1*: In this case, we randomly remove 20% of data, which spread sporadically over the dataset.

2) *Case 2*: In this case, we remove data in blocks, which are randomly located over the dataset. The length of each block is uniformly distributed between 5 and 30 steps, whereas the number of blocks is fixed as 300.

3) *Case 3*: In this case, we remove data whose values are greater than 0.87.

In each case, we consider the lead time of 1, 2, and 3, and use wind power generation values at previous time as features. As feature selection is not the focus of this work, we choose it empirically as 6 lags. Sophisticated feature selection approaches can be certainly used.

C. Benchmark Models

Three types of models are considered as benchmarks: naive models, ‘‘impute, then predict’’ strategy-based models, and ‘‘universal imputation’’ strategy-based models. Besides, we set a quantile regression model trained on complete data as a reference. We describe them as follows:

1) *Climatology*: It is a naive model that estimates the empirical distribution of wind power generation based on historical samples.

2) *IM-Gaussian*: It is an ‘‘impute, then predict’’ strategy-based model. Missing values are imputed via MissForest [31], based on which a parametric probabilistic forecasting model with Gaussian distributional assumption is developed.

3) *IM-QR*: It is an ‘‘impute, then predict’’ strategy-based model. Missing values are also imputed via MissForest, based on which quantile regression models are developed.

4) *DeepAR*: It is a state-of-the-art ‘‘impute, then predict’’ strategy-based model where imputation and forecasting are performed simultaneously.

5) *UI*: It is a ‘‘universal imputation’’ strategy-based model proposed in [23] based on a fully conditional specification [18]. For further descriptions, we refer readers to [23].

6) *R-QR*: It is a quantile regression model trained on the complete dataset, which serves as a reference.

D. Qualification Metrics

To assess the quality of forecasts, we verify the calibration and sharpness of forecasts. Concretely, the calibration of predictive densities is assessed with reliability diagrams. The sharpness of forecasts is assessed with the average width of central prediction intervals, which reveals how predictive densities concentrate the information. In addition, we assess the quality of forecasts with a skill score, namely continuous ranked probability score (CRPS). Given the lead time k , we denote the predictive c.d.f for wind power generation at time $t+k$ as \hat{F}_{t+k} , and the real generation value as y_{t+k} . The CRPS is calculated via

$$\text{CRPS}(\hat{F}_{t+k}, y_{t+k}) = \int_y (\hat{F}_{t+k}(y) - \mathcal{I}(y - y_{t+k}))^2 dy,$$

where $\mathcal{I}(\cdot)$ is a step function. We report the average CRPS of all test samples for each lead time. For further information on forecast verification, we refer readers to [1].

TABLE I
THE CRPS VALUES OF FORECASTS BY THE PROPOSED AND BENCHMARK MODELS WITH DIFFERENT LEAD TIMES IN CASE 1 (%).

Lead time	Climatology	IM-Gaussian	IM-QR	DeepAR	UI	R-QR	Proposed
1	18.6	7.5	7.8	7.8	6.9	6.9	7.2
2	18.6	9.9	9.9	10.2	9.1	9.3	9.4
3	18.6	11.7	11.7	12.1	10.9	11.2	11.4

TABLE II
THE CRPS VALUES OF FORECASTS BY THE PROPOSED AND BENCHMARK MODELS WITH DIFFERENT LEAD TIMES IN CASE 2 (%).

Lead time	Climatology	IM-Gaussian	IM-QR	DeepAR	UI	R-QR	Proposed
1	18.6	7.2	7.4	7.4	6.6	6.9	6.4
2	18.6	9.6	9.6	9.9	8.9	9.3	9.2
3	18.6	11.5	11.5	11.7	11.9	11.2	11.2

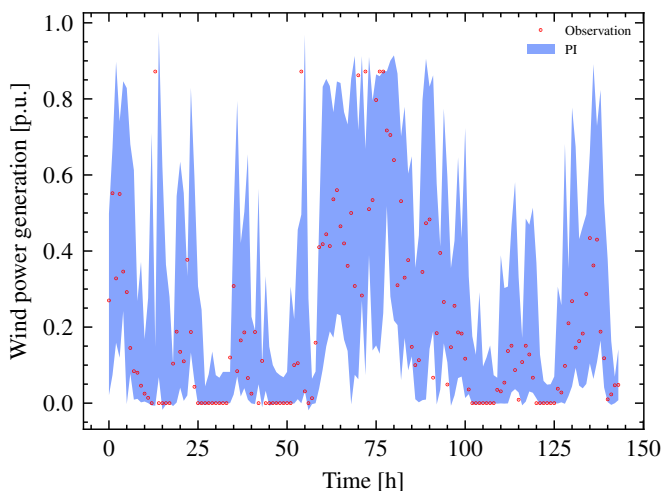

Fig. 3. 90% prediction intervals by the proposed model for 144 successive observations in case 1 when lead time is 1.

VI. RESULTS

The results of the aforementioned three cases are presented in this section, and followed by discussion.

A. Case 1

The CRPS values of forecasts by the proposed and benchmark models are presented in Table I. Intuitively, The performance of climatology is the worst among all models, as it only communicates forecasts via unconditional empirical distribution. Unlike the common situations where QR often outperforms Gaussian distributional models, The performance of IM-Gaussian and IM-QR is quite close, which suggests that imputation has a complex impact on the training of downstream forecasting models. To our surprise, the performance of DeepAR is the worst among the three “impute, then predict” strategy-based models. In fact, DeepAR imputes missing values via the intermediate results of the recurrent neural network during training, which may have a negative impact on forecasting. The performance of UI and the proposed model is comparable to the reference model. Especially, the UI model slightly outperforms the reference model, which may be due

to its robustness to overfitting. The 90% prediction intervals by the proposed model for 144 successive observations when lead time is 1 is shown in Figure 3.

We present the reliability diagrams and prediction interval width of forecasts when $k = 1$ in Figure 4. As shown, the reliability diagrams of “impute, then predict” strategy-based models deviate from the ideal case in relatively further distances. The prediction interval widths of the proposed and benchmark models are comparable, all of which are smaller than that of the reference model. The reliability of DeepAR is the worst among all models, whereas its prediction interval widths are also the smallest. The reliability diagrams of UI and the proposed model are close to the ideal case, which reveals that they lead to little biases in the forecasts. Surprisingly, the reliability of the reference model is worse than the proposed and UI model, while the reference model yields larger prediction interval widths. It may be caused by the overfitting of the reference model.

B. Case 2

The CRPS values of forecasts by the proposed and benchmark models are presented in Table II. In this case, the differences in CRPS values among all models are smaller than those in case 1. Different from the case 1, missingness occurs in blocks in this case, leading to more samples with complete observations. Therefore, missing values have less impact on the quality of forecasts. Among the “impute, then predict” strategy-based models, the performance of DeepAR is still the worst, though the difference between DeepAR and IM-Gaussian/IM-QR is smaller compared to that in case 1. By contrast, the performance of the proposed and UI models is still better than that of “impute, then predict” strategy-based models, which is comparable to the reference model. It suggests that the proposed and UI models are applicable to both sporadic and block missingness.

The reliability diagrams and prediction interval width of forecasts when $k = 1$ are presented in Figure 5. In this case, the reliability of DeepAR is still the worst among all models. It is seen that the reliability diagram of the proposed model fluctuates around the ideal case, though close to the ideal case. It is caused by the monotonicity constraint on the proposed

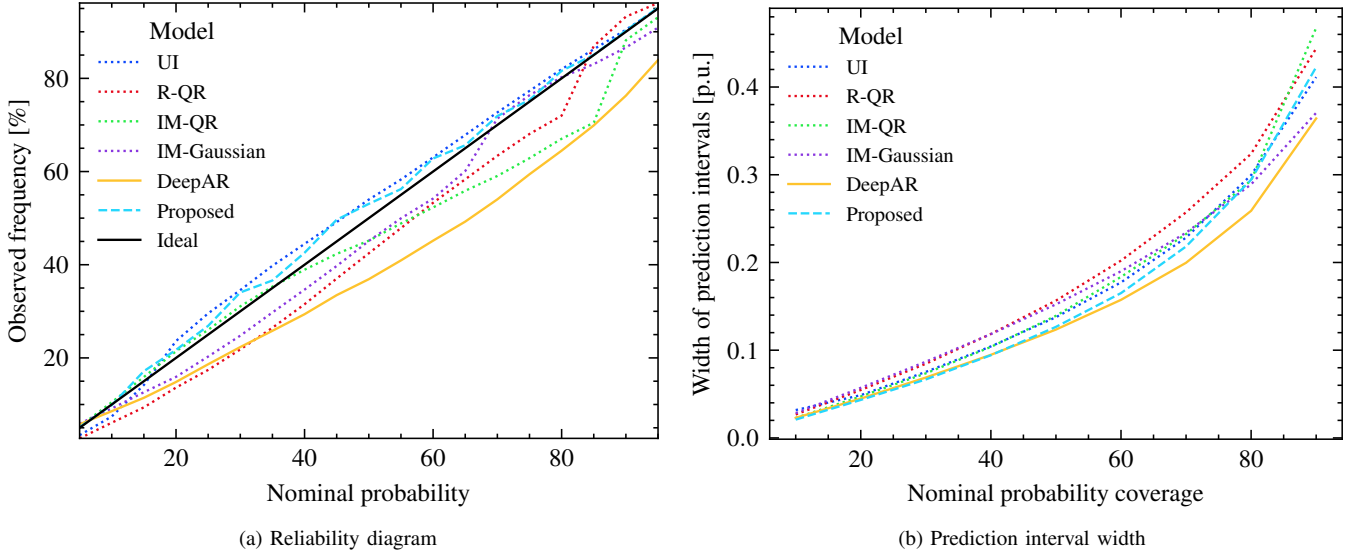

Fig. 4. Reliability and sharpness of forecasts by the proposed and benchmark models with $k = 1$ in case 1.

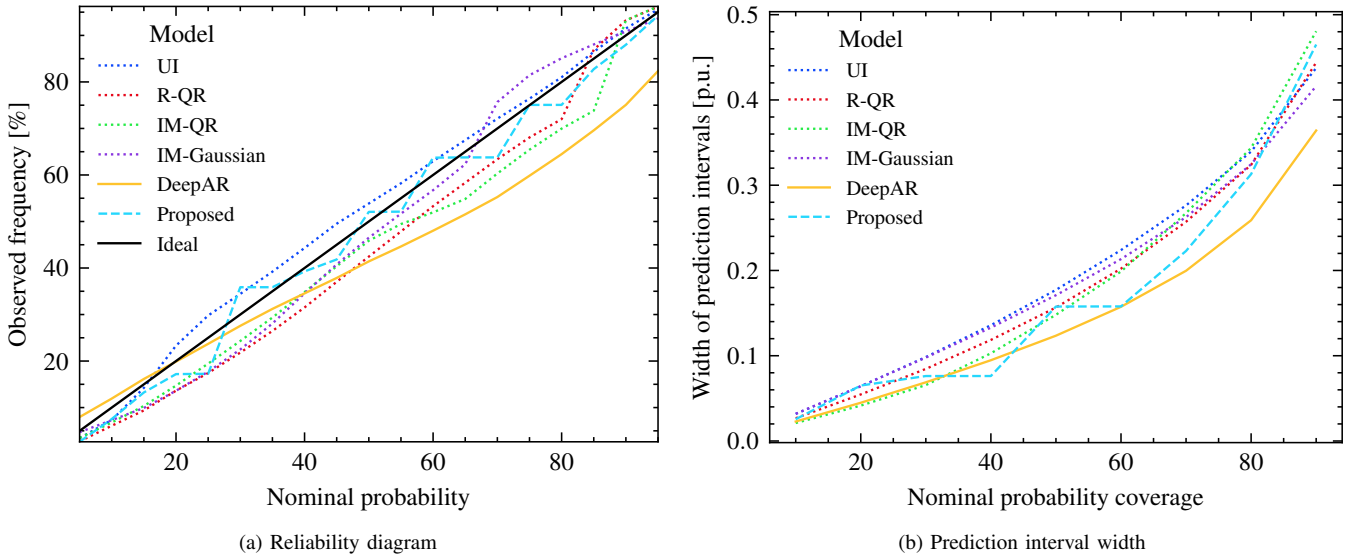

Fig. 5. Reliability and sharpness of forecasts by the proposed and benchmark models with $k = 1$ in case 2.

TABLE III
THE CRPS VALUES OF FORECASTS BY THE PROPOSED AND BENCHMARK MODELS WITH DIFFERENT LEAD TIMES IN CASE 3 (PERCENTAGE).

Lead time	Climatology	IM-Gaussian	IM-QR	DeepAR	UI	R-QR	Proposed
1	15.4	6.6	6.8	7.1	6.4	6.0	6.0
2	15.4	8.6	8.7	9.3	8.3	7.9	8.0
3	15.4	10.1	9.9	10.8	9.5	9.4	9.4

model. Such constraints ensure that higher quantiles are no smaller than lower quantiles, but influence the parameter estimation on the other hand. Further analysis is contained in the following subsection. In general, the performance of the proposed model in reliability and sharpness is quite good.

C. Case 3

We present the CRPS values of forecasts by the proposed and benchmark models in Table III. Compared to cases 1 and 2, all models achieve better performance in CRPS, as high wind power generation values are excluded, which leads to larger forecast errors. Still, the quality of forecasts by the DeepAR model is the worst among all models. The performance of UI and the proposed models is better than that

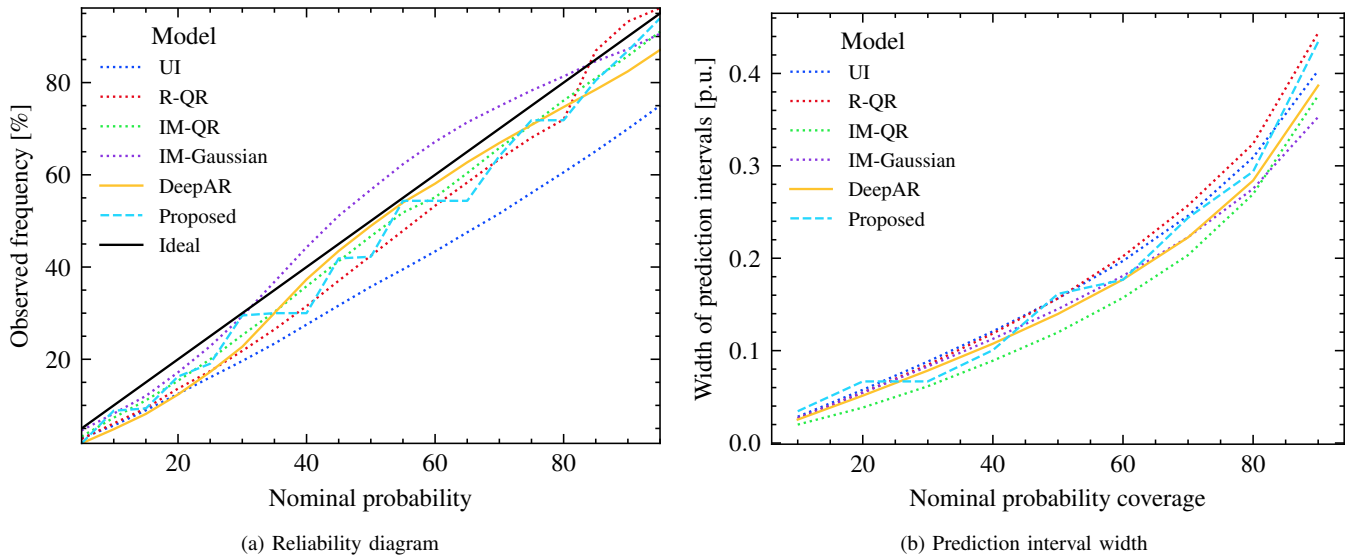

Fig. 6. Reliability and sharpness of forecasts by the proposed and benchmark models with $k = 1$ in case 3.

of “impute, then predict” strategy-based models. Especially the proposed model achieves the best performance among all models, which reveals that the proposed model is applicable to MNAR cases.

The reliability diagrams and prediction interval widths are shown in Figure 6. Unlike in cases 1 and 2, the reliability of UI model deviates from the ideal case to a large extent, which may be due to the fact that fully conditional specification relies on MAR assumption. In the MNAR case, such an assumption leads to more biases in the parameter estimation. By contrast, the proposed model is more applicable to MNAR cases.

D. Discussion on Non-crossing Constraints

As described in Section IV.B, we place hard constraints on quantiles to ensure monotonicity by setting higher quantiles as the addition of lower quantiles and non-negative increments. Certainly, it avoids the embarrassing quantile crossing phenomena. However, such constraints also influence parameter estimation. For illustration, we present the reliability diagrams and prediction interval widths of regular quantile regression and the proposed model based on the setting in case 2 in Figure 7. As shown, the regular quantile regression model leads to a quantile-crossing phenomenon, while the prediction interval widths are wider than those of the regular quantile regression model. In addition, as the proposed model constructs quantiles via addition operation, it can be only calculated sequentially, while the regular quantile regression model is allowed to yield quantiles in parallel.

E. Training Time

We present the training time of all models in Table IV, where time spent on imputation for the “impute, then predict” strategy-based models is not included. It is seen that the proposed model is time-efficient in training. In particular, the training time of UI model (which is based on fully conditional specification here) will increase linearly with the dimension,

whereas that of the proposed model scales sublinearly thanks to the deep learning techniques.

VII. CONCLUSION

In this work, we propose an adaptive quantile regression approach for probabilistic wind power forecasting with missing values within the typically used conditional distribution modeling framework. It is based on deep neural network models, and contains a linear mapping whose bias is adaptive to missingness patterns by design and a nonlinear mapping that is responsible for yielding quantiles. It is applicable to both missing at-random and missing not-at-random cases. In particular, higher quantiles are derived by the addition between lower quantiles and non-negative increments, which avoids the embarrassing quantile-crossing phenomena. Case studies demonstrate that the proposed approach achieves state-of-the-art in terms of CRPS in both missing at-random and missing not-at-random cases, and is time-efficient in training. However, we only consider adaptive bias in this work, more efforts can be taken into developing adaptive weights in the future. Besides, as case studies suggest the hard constraints on quantiles influence the parameter estimation while they ensure the monotonicity, advanced non-crossing quantile regression methods can be investigated.

REFERENCES

- [1] T. Gneiting and M. Katzfuss, “Probabilistic forecasting,” *Annual Review of Statistics and Its Application*, vol. 1, pp. 125–151, 2014.
- [2] P. Pinson, C. Chevallier, and G. N. Kariniotakis, “Trading wind generation from short-term probabilistic forecasts of wind power,” *IEEE Transactions on Power Systems*, vol. 22, no. 3, pp. 1148–1156, 2007.
- [3] M. A. Matos and R. J. Bessa, “Setting the operating reserve using probabilistic wind power forecasts,” *IEEE transactions on power systems*, vol. 26, no. 2, pp. 594–603, 2010.
- [4] S. E. Haupt, M. G. Casado, M. Davidson, J. Dobschinski, P. Du, M. Lange, T. Miller, C. Mohrlen, A. Motley, R. Pestana *et al.*, “The use of probabilistic forecasts: Applying them in theory and practice,” *IEEE Power and Energy Magazine*, vol. 17, no. 6, pp. 46–57, 2019.

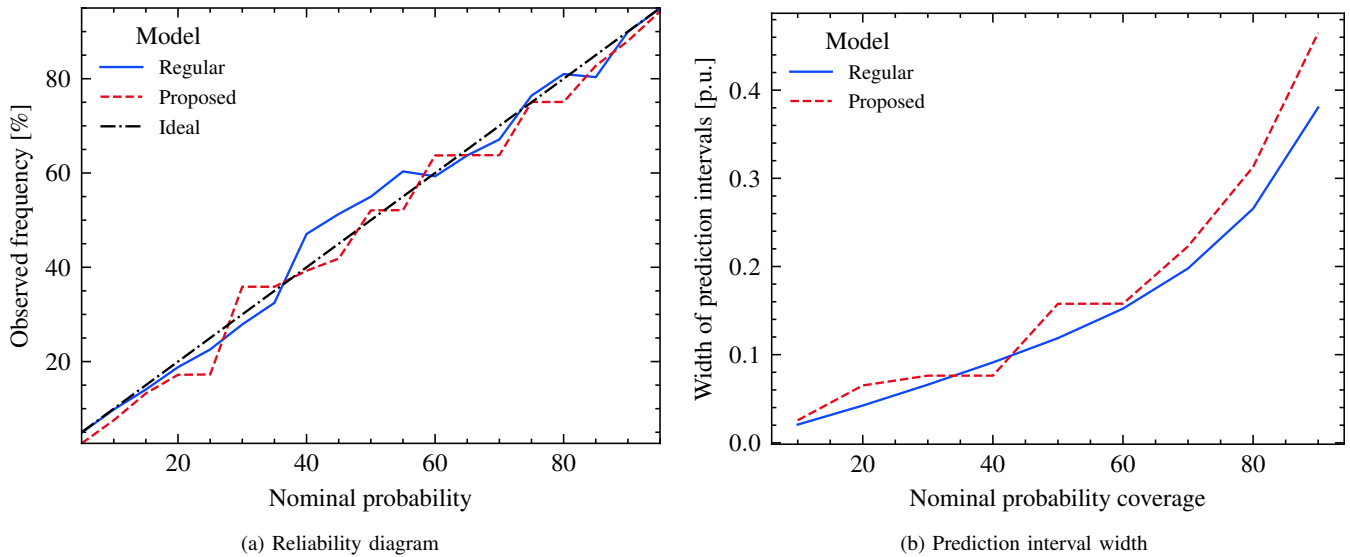

Fig. 7. Reliability and sharpness of forecasts by the proposed and regular quantile regression model with $k = 1$ based on the setting in case 2.

TABLE IV
THE TRAINING TIME OF THE PROPOSED AND BENCHMARK MODELS IN CASE 1 (MINUTES).

Models	Climatology	IM-Gaussian	IM-QR	DeepAR	UI	R-QR	Proposed
Training time	-	32	10	64	41	10	6

- [5] C. Sweeney, R. J. Bessa, J. Browell, and P. Pinson, "The future of forecasting for renewable energy," *Wiley Interdisciplinary Reviews: Energy and Environment*, vol. 9, no. 2, p. e365, 2020.
- [6] R. Koenker and K. F. Hallock, "Quantile regression," *Journal of economic perspectives*, vol. 15, no. 4, pp. 143–156, 2001.
- [7] H. Wen, P. Pinson, J. Ma, J. Gu, and Z. Jin, "Continuous and distribution-free probabilistic wind power forecasting: A conditional normalizing flow approach," *IEEE Transactions on Sustainable Energy*, vol. 13, no. 4, pp. 2250–2263, 2022.
- [8] H. Wen, J. Ma, J. Gu, L. Yuan, and Z. Jin, "Sparse variational gaussian process based day-ahead probabilistic wind power forecasting," *IEEE Transactions on Sustainable Energy*, vol. 13, no. 2, pp. 957–970, 2022.
- [9] H. Zhang, Y. Liu, J. Yan, S. Han, L. Li, and Q. Long, "Improved deep mixture density network for regional wind power probabilistic forecasting," *IEEE Transactions on Power Systems*, vol. 35, no. 4, pp. 2549–2560, 2020.
- [10] L. Cavalcante, R. J. Bessa, M. Reis, and J. Browell, "Lasso vector autoregression structures for very short-term wind power forecasting," *Wind Energy*, vol. 20, no. 4, pp. 657–675, 2017.
- [11] C. Goncalves, R. J. Bessa, and P. Pinson, "Privacy-preserving distributed learning for renewable energy forecasting," *IEEE Transactions on Sustainable Energy*, vol. 12, no. 3, pp. 1777–1787, 2021.
- [12] C. Goncalves, P. Pinson, and R. J. Bessa, "Towards data markets in renewable energy forecasting," *IEEE Transactions on Sustainable Energy*, vol. 12, no. 1, pp. 533–542, 2020.
- [13] R. Tawn, J. Browell, and I. Dinwoodie, "Missing data in wind farm time series: Properties and effect on forecasts," *Electric Power Systems Research*, vol. 189, p. 106640, 2020.
- [14] W. Cao, D. Wang, J. Li, H. Zhou, L. Li, and Y. Li, "Brits: Bidirectional recurrent imputation for time series," *Advances in neural information processing systems*, vol. 31, 2018.
- [15] D. Salinas, V. Flunkert, J. Gasthaus, and T. Januschowski, "Deepar: Probabilistic forecasting with autoregressive recurrent networks," *International Journal of Forecasting*, vol. 36, no. 3, pp. 1181–1191, 2020.
- [16] J. Josse, N. Prost, E. Scornet, and G. Varoquaux, "On the consistency of supervised learning with missing values," *arXiv preprint arXiv:1902.06931*, 2019.
- [17] A. P. Dempster, N. M. Laird, and D. B. Rubin, "Maximum likelihood from incomplete data via the em algorithm," *Journal of the Royal Statistical Society: Series B (Methodological)*, vol. 39, no. 1, pp. 1–22, 1977.
- [18] S. Van Buuren, J. P. Brand, C. G. Groothuis-Oudshoorn, and D. B. Rubin, "Fully conditional specification in multivariate imputation," *Journal of statistical computation and simulation*, vol. 76, no. 12, pp. 1049–1064, 2006.
- [19] R. J. Little and D. B. Rubin, *Statistical analysis with missing data*. John Wiley & Sons, 2019, vol. 793.
- [20] R. H. Jones, "Maximum likelihood fitting of arma models to time series with missing observations," *Technometrics*, vol. 22, no. 3, pp. 389–395, 1980.
- [21] R. Kohn and C. F. Ansley, "Estimation, prediction, and interpolation for arima models with missing data," *Journal of the American statistical Association*, vol. 81, no. 395, pp. 751–761, 1986.
- [22] A. Stratigakos, P. Andrianesis, A. Michiorri, and G. Kariniotakis, "Towards resilient energy forecasting: A robust optimization approach," 2022.
- [23] H. Wen, P. Pinson, J. Gu, and Z. Jin, "Wind energy forecasting with missing values within a fully conditional specification framework," *International Journal of Forecasting*, 2023.
- [24] N. B. Ipsen, P.-A. Mattei, and J. Frellsen, "How to deal with missing data in supervised deep learning?" in *ICLR 2022-10th International Conference on Learning Representations*, 2022.
- [25] P. R. Rosenbaum and D. B. Rubin, "Reducing bias in observational studies using subclassification on the propensity score," *Journal of the American statistical Association*, vol. 79, no. 387, pp. 516–524, 1984.
- [26] D. Bertsimas, A. Delarue, and J. Pauphilet, "Prediction with missing data," *stat*, vol. 1050, p. 7, 2021.
- [27] M. Le Morvan, J. Josse, T. Moreau, E. Scornet, and G. Varoquaux, "Neumiss networks: differentiable programming for supervised learning with missing values," *Advances in Neural Information Processing Systems*, vol. 33, pp. 5980–5990, 2020.
- [28] Y. Park, D. Maddix, F.-X. Aubet, K. Kan, J. Gasthaus, and Y. Wang, "Learning quantile functions without quantile crossing for distribution-free time series forecasting," in *International Conference on Artificial Intelligence and Statistics*. PMLR, 2022, pp. 8127–8150.
- [29] C. Draxl, A. Clifton, B.-M. Hodge, and J. McCaa, "The wind integration national dataset (wind) toolkit," *Applied Energy*, vol. 151, pp. 355–366, 2015.
- [30] C. M. Bishop and N. M. Nasrabadi, *Pattern recognition and machine learning*. Springer, 2006, vol. 4, no. 4.
- [31] D. J. Stekhoven and P. Bühlmann, "Missforest—non-parametric missing value imputation for mixed-type data," *Bioinformatics*, vol. 28, no. 1, pp. 112–118, 2012.