

# Frobenius algebras associated with the $\alpha$ -induction for equivariantly braided tensor categories

Mizuki Oikawa \*

Graduate School of Mathematical Sciences  
The University of Tokyo, Komaba, Tokyo 153-8914, Japan

E-mail: moikawa@ms.u-tokyo.ac.jp

and

RIKEN iTHEMS

Wako, Saitama 351-0198, Japan

E-mail: mizuki.oikawa@riken.jp

*Dedicated to Yasuyuki Kawahigashi on the occasion of his sixtieth birthday*

## Abstract

Let  $G$  be a group. We give a categorical definition of the  $G$ -equivariant  $\alpha$ -induction for a neutral symmetric special  $G$ -equivariant Frobenius algebra in a  $G$ -braided multitensor category, which generalizes the  $\alpha$ -induction for  $G$ -twisted representations of conformal nets. We define a new product of  $G$ -braided multitensor categories and introduce the notion of the neutral double of a split semisimple  $G$ -braided multitensor category. For a neutral symmetric special simple  $G$ -equivariant Frobenius algebra in a split spherical  $G$ -braided fusion category, we construct a  $G$ -equivariant Frobenius algebra, which we call a  $G$ -equivariant  $\alpha$ -induction Frobenius algebra, in the neutral double. This construction generalizes Rehren's construction of  $\alpha$ -induction Q-systems. Finally, we define the notion of the  $G$ -equivariant full center of a neutral symmetric special  $G$ -equivariant Frobenius algebra in a split spherical  $G$ -braided fusion category with nonzero dimension and show that it indeed coincides with the corresponding  $G$ -equivariant  $\alpha$ -induction Frobenius algebra when both of them are well-defined, which generalizes a theorem of Bischoff, Kawahigashi and Longo.

## Contents

<b>1</b>	<b>Introduction</b>	<b>2</b>
<b>2</b>	<b>Preliminaries</b>	<b>3</b>
2.1	Group actions on bicategories . . . . .	3
2.2	Equivariantly braided tensor categories . . . . .	9
2.3	Equivariant Frobenius algebras . . . . .	12
<b>3</b>	<b>Equivariant <math>\alpha</math>-induction</b>	<b>15</b>
3.1	Group actions on the bicategories of equivariant Frobenius algebras . . . . .	16
3.2	Categorical definition of equivariant $\alpha$ -induction . . . . .	20
<b>4</b>	<b>Equivariant <math>\alpha</math>-induction Frobenius algebras</b>	<b>22</b>
4.1	The neutral double of a $G$ -braided tensor category . . . . .	22
4.2	Equivariant $\alpha$ -induction Frobenius algebras . . . . .	25

---

\*The author is supported by RIKEN Junior Research Associate Program.

<b>5</b>	<b>Equivariant full centers</b>	<b>35</b>
5.1	The equivariant full center of a $G$ -equivariant Frobenius algebra . . . . .	35
5.2	Equivariant $\alpha$ -induction Frobenius algebras as equivariant full centers . . . . .	38

# 1 Introduction

In rational conformal field theory, we can construct two-dimensional conformal field theories from a chiral conformal field theory. Mathematically, it corresponds to finding nonnegative integral combinations of some functions on the complex upper half plane which is invariant under the action of the modular group  $SL(2, \mathbb{Z})$ . Such combinations are called modular invariants. It is well-known that the modular invariants for the  $SU(2)$  Wess–Zumino–Witten models admit an A-D-E classification i.e. they correspond to the simply-laced Dynkin diagrams [CIZ87][Kat87].

In the framework of algebraic quantum field theory, a chiral conformal field theory is modeled by a conformal net. When a conformal net  $\mathcal{A}$  satisfies the property called the complete rationality [KLM01, Definition 8], it produces a modular tensor category as its Doplicher–Haag–Roberts (DHR) category [DHR71][DHR74], which is denoted by  $\text{Rep } \mathcal{A}$  in this article, see [KLM01, Corollary 37]. In this case, modular invariants can be formulated as matrices with nonnegative integer coefficients indexed by the simple objects of  $\text{Rep } \mathcal{A}$  that commute with the  $S$  and  $T$  matrices.

It was shown by Böckenhauer, Evans and Kawahigashi [BE98][BE99a][BE99b][BEK99][BEK00] that  $\alpha$ -induction [LR95, Proposition 3.9] is a powerful categorical tool for producing modular invariants. Namely, when a finite index standard extension  $\mathcal{A} \subset \mathcal{B}$  of a completely rational conformal net  $\mathcal{A}$  [LR95, Section 3] is given, the  $\alpha$ -induction for the extension assigns to each DHR endomorphism  $\lambda$  of  $\mathcal{A}$  some (not necessarily DHR) endomorphisms  $\alpha^\pm(\lambda)$  of  $\mathcal{B}$  and indeed  $\langle \alpha^+(\lambda), \alpha^-(\mu) \rangle := \dim \text{Hom}(\alpha^+(\lambda), \alpha^-(\mu))$  for simple objects  $\lambda$  and  $\mu$  of  $\text{Rep } \mathcal{A}$  is a modular invariant matrix [BEK99, Theorem 5.7]. Moreover, Rehren [Reh00] showed that the matrix is physical i.e. he constructed a commutative Q-system  $\bigoplus_{\lambda, \mu} \langle \alpha^+(\lambda), \alpha^-(\mu) \rangle \lambda \boxtimes \bar{\mu}$  in  $\text{Rep } \mathcal{A} \boxtimes (\text{Rep } \mathcal{A})^{\text{rev}}$ , and it was shown by Kong and Runkel [KR09, Theorem 3.22] and Bischoff, Kawahigashi and Longo [BKL15, Proposition 5.2] that any physical modular invariant matrix can be obtained in this fashion.

When a group  $G$  acts on  $\mathcal{A}$ , we can consider the notion of the  $G$ -twisted representations of  $\mathcal{A}$ , which generalizes the notion of the DHR endomorphisms of  $\mathcal{A}$  [Müg05]. Recently, the notion of the  $\alpha$ -induction for  $G$ -twisted representations, which we call  $G$ -equivariant  $\alpha$ -induction, was introduced by Nojima [Noj20]. Then, it is natural to expect that  $G$ -equivariant  $\alpha$ -induction is also a powerful tool for producing modular invariants in some sense. In this article, we generalize some of the classical results introduced above, which gives circumstantial evidence for this expectation.

The main results of this article are twofold. First, we generalize Rehren’s construction of  $\alpha$ -induction Q-systems [Reh00] to  $G$ -equivariant  $\alpha$ -induction (Theorem 4.14). Indeed, this theorem can be stated in a purely algebraic setting. Namely, we construct the  $G$ -equivariant  $\alpha$ -induction Frobenius algebra for a neutral symmetric special simple  $G$ -equivariant Frobenius algebra in a split spherical  $G$ -braided fusion category (see Subsections 2.2 and 2.3 for terminologies). For this, we have to introduce the notion of the *neutral double* of a split semisimple  $G$ -braided multitensor category as an ambient category (Definition 4.8). Second, we generalize [BKL15, Proposition 4.18], which is an important ingredient in the characterization of physical modular invariants in terms of  $\alpha$ -induction [BKL15, Proposition 5.2]. Namely, we introduce the notion of the  $G$ -equivariant full center of a neutral symmetric special  $G$ -equivariant Frobenius algebra in a split spherical  $G$ -braided fusion category with nonzero dimension (Definition 5.11) and show that it indeed coincides with the corresponding  $G$ -equivariant  $\alpha$ -induction Frobenius algebra when both of them are well-defined (Theorem 5.24).

This article is structured as follows. In Section 2, we review some preliminaries on bicategories and multitensor categories equipped with group actions. In particular, we recall the notions of  $G$ -braided multitensor categories and  $G$ -equivariant Frobenius algebras for a group  $G$ . We also introduce an appropriate notion of equivalence between bicategories with group actions. In Section 3, we give the categorical definition of  $G$ -equivariant  $\alpha$ -induction. For this, we define an action of  $G$  on the bicategory of  $G$ -equivariant Frobenius algebras. In Section 4, we define the notion of the neutral double of a split semisimple  $G$ -braided multitensor category and construct the

$G$ -equivariant  $\alpha$ -induction Frobenius algebras. Finally, in Section 5, we define the notion of a  $G$ -equivariant full center and show the coincidence of  $G$ -equivariant  $\alpha$ -induction Frobenius algebras and  $G$ -equivariant full centers.

## 2 Preliminaries

### 2.1 Group actions on bicategories

In this subsection, we recall the notion of group actions on monoidal categories and bicategories and give an appropriate notion of equivalence between bicategories with group actions in two ways.

An *action* of a group  $G$  on a monoidal category  $\mathcal{C}$  is a monoidal functor from the monoidal category  $\underline{G}$  of the elements of  $G$  with only identity morphisms to the monoidal category of the monoidal endofunctors on  $\mathcal{C}$ .

We also have to consider group actions on bicategories in this article (see Subsections 3.1 and 5.2 below). For basic notions of bicategories, see e.g. [Lei04, Section 1.5]. Here we fix our notation: the composition of 1-cells of  $\mathcal{C}$  is denoted by  $\otimes^{\mathcal{C}}$  or  $\otimes$ , for we regard bicategories as generalizations of monoidal categories, and often omitted. The associativity constraint is denoted by  $a^{\mathcal{C}}$ . The unit is denoted by  $1^{\mathcal{C}}$ , and the left and right unit constraints are denoted respectively by  $l^{\mathcal{C}}$  and  $r^{\mathcal{C}}$ . A pseudofunctor  $F : \mathcal{C} \rightarrow \mathcal{D}$  consists of a map  $F$  between 0-cells, functors  $F_{A,B}$  for  $A, B \in \text{Obj}(\mathcal{C})$ , natural isomorphisms  $J_{A,B,C}^F : F_{B,C}(-) \otimes F_{A,B}(-) \cong F_{A,C}(- \otimes -)$  for  $A, B, C \in \text{Obj}(\mathcal{C})$  and  $\varphi_A^F : \mathbf{1}_{F(A)}^{\mathcal{D}} \cong F_{A,A}(1_A^{\mathcal{C}})$  for  $A \in \text{Obj}(\mathcal{C})$ . A pseudonatural transformation  $\tau : F \rightarrow F'$  consists of 1-cells  $\tau_C^0$  for  $C \in \text{Obj}(\mathcal{C})$  and invertible 2-cells  $\tau_{\lambda} : \tau_{C'}^0 \circ F(\lambda) \cong F'(\lambda) \circ \tau_C^0$  for 1-cells  $\lambda : C \rightarrow C'$ . The vertical and horizontal compositions of pseudonatural transformations (see also [BGM19, Section 1.1]) are denoted respectively by  $\circ$  and  $*$ .

By stating the coherence theorem for pseudofunctors [Gur13, Subsection 2.3.3] in the form of “all diagrams commute”, we can see that the 2-cells obtained by vertically and horizontally composing components of  $a^{\mathcal{C}}$ ,  $l^{\mathcal{C}}$  and  $r^{\mathcal{C}}$  of bicategories  $\mathcal{C}$  and  $J^F$ 's and  $\varphi^F$ 's of pseudofunctors  $F$  are indeed canonical, which allows us to suppress these 2-cells. In particular, we may suppress the constraints of the tricategory of bicategories. We can also introduce some graphical representations in the tricategory of bicategories, which are used only in this subsection. A pseudonatural transformation is represented as an arrow from top to bottom, and the vertical and horizontal compositions of pseudonatural transformations are represented respectively by the vertical and horizontal concatenation of arrows. Note that we do not have to be careful of relative vertical positions when taking horizontal concatenations since the comparison constraints between pseudonatural transformations (see [BGM19, Section 1.1]) are canonical by coherence.

An *action* of a group  $G$  on a bicategory  $\mathcal{C}$  is a monoidal pseudofunctor (i.e. a trihomomorphism between monoidal bicategories, see [GPS95, Chapters 2 and 3]) from  $\underline{G}$  to  $\text{End}(\mathcal{C})$ , where  $\underline{G}$  denotes  $G$  regarded as a monoidal bicategory and  $\text{End}(\mathcal{C})$  denotes the monoidal bicategory of the pseudofunctors from  $\mathcal{C}$  to itself, see [BGM19, Sections 1.1 and 2]. More explicitly, an action  $\gamma$  of  $G$  on  $\mathcal{C}$  consists of autoequivalences  $\gamma(g)$  of  $\mathcal{C}$ , pseudonatural equivalences  $\chi_{g,h}^{\gamma} : \gamma(g)\gamma(h) \simeq \gamma(gh)$ , a pseudonatural equivalence  $\iota^{\gamma} : \text{id}_{\mathcal{C}} \simeq \gamma(e)$  and invertible modifications  $\omega_{g,h,k}^{\gamma} : \chi_{gh,f}^{\gamma} \circ (\chi_{g,h}^{\gamma} * \text{id}_{\gamma(f)}) \cong \chi_{g,hf}^{\gamma} \circ (\text{id}_{\gamma(g)} * \chi_{h,f}^{\gamma})$ ,  $\kappa_g^{\gamma} : \chi_{e,g}^{\gamma} \circ (\iota^{\gamma} * \text{id}_{\gamma(g)}) \cong \text{id}_{\gamma(g)}$  and  $\zeta_g^{\gamma} : \chi_{g,e}^{\gamma} \circ (\text{id}_{\gamma(g)} * \iota^{\gamma}) \cong \text{id}_{\gamma(g)}$  for  $g, h, k \in G$ . Graphically, let a fork with two inputs  $\gamma(g)$  and  $\gamma(h)$  and one output  $\gamma(gh)$  denote  $\chi_{g,h}^{\gamma}$ , and let a small circle with one output  $\gamma(e)$  denote  $\iota^{\gamma}$ . Then,  $\omega^{\gamma}$ ,  $\kappa^{\gamma}$  and  $\zeta^{\gamma}$  correspond respectively to associativity and left and right unit properties of an algebra in a weak sense, which satisfy the pentagon and triangle axioms [GPS95, Definition 3.1].

For a 1-cell  $\lambda$  of  $\mathcal{C}$  and  $g \in G$ , the 1-cell  $\gamma(g)(\lambda)$  is often denoted by  ${}^g\lambda$ . Moreover,  ${}^g\lambda\mu$  denotes  ${}^g(\lambda) \otimes \mu$  for  $g \in G$  and 1-cells  $\lambda$  and  $\mu$ , and  ${}^g f \otimes f'$  denotes  ${}^g(f) \otimes f'$  for  $g \in G$  and 2-cells  $f$  and  $f'$  in this article.

An appropriate notion of morphisms between (strict) 2-categories with unital (see [BGM19, Definition 2.1]) group actions is given in [BGM19, Definition 2.3]. Here, we define the notion of equivalences in a general setting.

First, recall that for a biequivalence  $F : \mathcal{C} \rightarrow \mathcal{D}$ , we can take a pseudofunctor  $F^{-1} : \mathcal{D} \rightarrow \mathcal{C}$  with pseudonatural equivalences  $\text{ev}^F : F^{-1}F \simeq \text{id}_{\mathcal{C}}$  and  $\text{coev}^F : \text{id}_{\mathcal{D}} \simeq FF^{-1}$  by fixing data  $F^{-1}(D)$ ,  $\text{coev}_D^{F,0}$  and  $(\text{coev}_D^{F,0})^{\vee}$  for  $D \in \text{Obj}(\mathcal{D})$ , where  ${}^{\vee}$  denotes a left adjoint inverse, and  $F_{\mathcal{C},\mathcal{C}}^{\vee}$

for  $C, C' \in \text{Obj}(\mathcal{C})$ , see e.g. [Lei04, Proposition 1.5.13]. The set of these data is also denoted by  $F^{-1}$  and referred to as an *adjoint inverse* of  $F$ . Another choice of an adjoint inverse only yields a pseudonaturally equivalent pseudofunctor  $F^{-1}$  by a standard duality argument. The pseudonatural equivalences  $\text{ev}^F$  and  $\text{coev}^F$  are graphically represented by arcs as in the case of duality in bicategories. Their adjoint inverses are represented by opposite arcs. We also recall that we have a natural isomorphism  $J_{A,B,C}^{F^\vee} : F_{B,C}^\vee(-) \otimes F_{A,B}^\vee(-) \cong F_{A,C}^\vee(- \otimes -)$  for  $A, B, C \in \text{Obj}(\mathcal{C})$  and an isomorphism  $\varphi_A^{F^\vee} : \mathbf{1}_A^C \cong F_{A,A}^\vee(\mathbf{1}_{F(A)}^D)$  for  $A \in \text{Obj}(\mathcal{C})$  with the coherence conditions as that for pseudofunctors. Then, as in the case of pseudofunctors, we may suppress  $J^{F^\vee}$ 's and  $\varphi^{F^\vee}$ 's.

When a biequivalence  $F : \mathcal{C} \rightarrow \mathcal{D}$  is given, we can transport  $H \in \text{End}(\mathcal{C})$  to  $\text{End}(\mathcal{D})$  by fixing an adjoint inverse  $F^{-1}$  of  $F$  and putting  $\text{Ad}(F)(H) := FHF^{-1} \in \text{End}(\mathcal{D})$ .

**Lemma 2.1.** Let  $F : \mathcal{C} \rightarrow \mathcal{D}$  be a biequivalence between bicategories. Then  $\text{Ad}(F) : \text{End}(\mathcal{C}) \rightarrow \text{End}(\mathcal{D})$  can be regarded as a monoidal pseudofunctor. Another choice of an adjoint inverse of  $F$  only yields a monoidally equivalent (i.e. there exists a triequivalence with an identical 1-cell) one.

*Proof.* Let  $H, K, L, H', K' \in \text{Obj}(\text{End}(\mathcal{C}))$  and let  $\sigma \in \text{Hom}(H, H')$ ,  $\tau \in \text{Hom}(K, K')$  and  $\rho \in \text{Hom}(H', H'')$ . Define functors  $\text{Ad}(F)_{H,H'}$  to be

$$\text{id}_F * - * \text{id}_{F^{-1}} : \text{Hom}(H, H') \rightarrow \text{Hom}(\text{Ad}(F)(H), \text{Ad}(F)(H')).$$

Define  $J_{\rho,\sigma}^{\text{Ad}(F)} : \text{Ad}(F)(\rho) \circ \text{Ad}(F)(\sigma) \cong \text{Ad}(F)(\rho \circ \sigma)$  and  $\varphi_H^{\text{Ad}(F)} : \text{id}_{\text{Ad}(F)(H)} \cong \text{Ad}(F)(\text{id}_H)$  to be canonical isomorphisms, which makes  $\text{Ad}(F)$  into a pseudofunctor by coherence. Define pseudonatural equivalences  $\chi_{H,K}^{\text{Ad}(F),0} := \text{id}_{FH} * \text{ev}^F * \text{id}_{KF^{-1}} : \text{Ad}(F)(H) \text{Ad}(F)(K) \simeq \text{Ad}(F)(HK)$  and define invertible modifications  $\chi_{\sigma,\tau}^{\text{Ad}(F)} : \chi_{H',K'}^{\text{Ad}(F),0} \circ (\text{Ad}(F)(\sigma) * \text{Ad}(F)(\tau)) \cong \text{Ad}(F)(\sigma * \tau) \circ \chi_{H,K}^{\text{Ad}(F),0}$  to be canonical isomorphisms, which give a pseudonatural equivalence  $\chi^{\text{Ad}(F)} := (\chi_{H,K}^{\text{Ad}(F),0}, \chi^{\text{Ad}(F)}) : \text{Ad}(F)(-) \circ \text{Ad}(F)(-) \simeq \text{Ad}(F)(- \circ -)$  by coherence. Put  $\iota^{\text{Ad}(F)} := \text{coev}^F : \text{id}_{\mathcal{D}} \simeq \text{Ad}(F)(\text{id}_{\mathcal{C}}) = FF^{-1}$ . Define modifications  $\omega_{H,K,L}^{\text{Ad}(F)} : \chi_{HK,L}^{\text{Ad}(F),0} \circ (\chi_{H,K}^{\text{Ad}(F),0} * \text{id}_{\text{Ad}(F)(L)}) \cong \chi_{H,KL}^{\text{Ad}(F),0} \circ (\text{id}_{\text{Ad}(F)(H)} * \chi_{K,L}^{\text{Ad}(F),0})$  to be canonical isomorphisms, which give an invertible modification  $\omega^{\text{Ad}(F)} : \chi^{\text{Ad}(F)} \circ (\chi^{\text{Ad}(F)} * \text{id}_{\text{Ad}(F)}) \cong \chi^{\text{Ad}(F)} \circ (\text{id}_{\text{Ad}(F)} * \chi^{\text{Ad}(F)})$  by coherence. Then, Axiom (HTA1) in [GPS95, Definition 3.1] holds by coherence.

Put  $f_D := \text{coev}_D^{F,0}$  for  $D \in \text{Obj}(\mathcal{D})$ . Let  $F^\vee(\lambda)$  denote  $F_{C,C'}^\vee(\lambda)$  for  $\lambda \in \text{Hom}_{\mathcal{D}}(F(C), F(C'))$  and  $C, C' \in \text{Obj}(\mathcal{C})$ . Since  $\text{ev}_C^{F,0} = F^\vee(f_{F(C)}^\vee)$  for  $C \in \text{Obj}(\mathcal{C})$  by construction, we can define an invertible 2-cell

$$\xi_C^F : ((\text{id}_F * \text{ev}^F) \circ (\text{coev}^F * \text{id}_F))_C^0 = F(\text{ev}_C^{F,0}) \text{coev}_{F(C)}^{F,0} = FF^\vee(f_{F(C)}^\vee) f_{F(C)} \rightarrow (\text{id}_F)_C^0 = \mathbf{1}_{F(C)}^D$$

to be  $\text{ev}_{f_{F(C)}}((\widetilde{\text{coev}}_{f_{F(C)}^\vee}^F)^{-1} \otimes \text{id}_{f_{F(C)}})$ , where  $\widetilde{\text{coev}}_\lambda^F$  for  $\lambda \in \text{Hom}_{\mathcal{D}}(F(C), F(C'))$  denotes the component of the coevaluation map for the left adjoint functor  $F_{C,C'}^\vee$ . Since  $F^{-1}(\lambda) = F^\vee(f_{D'}^\vee \lambda f_D^\vee)$  for  $\lambda \in \text{Hom}_{\mathcal{D}}(D, D')$  by construction, we can also define an invertible 2-cell

$$\begin{aligned} \tilde{\xi}_D^F &: ((\text{ev}^F * \text{id}_{F^{-1}}) \circ (\text{id}_{F^{-1}} * \text{coev}^F))_D^0 = \text{ev}_{F^{-1}(D)}^{F,0} F^{-1}(\text{coev}_D^{F,0}) = F^\vee(f_{F^{-1}(D)}^\vee) f_{F^{-1}(D)} f_D f_D^\vee \\ &\rightarrow (\text{id}_{F^{-1}})_D^0 = \mathbf{1}_{F^{-1}(D)}^C \end{aligned}$$

to be  $F^\vee(\text{ev}_{f_{F^{-1}(D)}} \otimes \text{coev}_{f_D}^{-1})$  for  $D \in \text{Obj}(\mathcal{D})$ . We show that  $\xi^F$  and  $\tilde{\xi}^F$  are indeed modifications. For this, recall that  $\widetilde{\text{coev}}^F$  is monoidal i.e.  $\widetilde{\text{coev}}_{\lambda\mu}^F = \widetilde{\text{coev}}_\lambda^F \otimes \widetilde{\text{coev}}_\mu^F$  for  $\lambda \in \text{Hom}_{\mathcal{D}}(F(C'), F(C''))$  and  $\mu \in \text{Hom}_{\mathcal{D}}(F(C), F(C'))$ , and  $\widetilde{\text{coev}}_{\mathbf{1}_D}^F = \text{id}_{\mathbf{1}_D}$  for  $D \in \text{Obj}(\mathcal{D})$ . We also recall that  $\text{coev}_\nu^F = (\widetilde{\text{coev}}_\nu^F \otimes \text{id}_{f_D})(\text{id}_{f_{D'}^\vee} \otimes \text{ev}_{f_D}^{-1})$  for  $\nu \in \text{Hom}_{\mathcal{D}}(D, D')$  and  $\text{ev}_\rho^F = (\tilde{\text{ev}}_\rho^F \otimes \text{id}_{f_{F(C)}^\vee}) F^\vee(\text{ev}_{f_{F(C)'}} \otimes \text{id}_{F(\rho) f_{F(C)}^\vee})$  for  $\rho \in \text{Hom}_{\mathcal{C}}(C, C')$ , where  $\tilde{\text{ev}}^F$  denotes an evaluation map as  $\widetilde{\text{coev}}^F$  does, by construction. Using these properties, we can see by direct computations that  $\xi^F$  and  $\tilde{\xi}^F$  are modifications.

Then, put  $\kappa_H^{\text{Ad}(F)} := \xi^F * \text{id}_{HF^{-1}}$  and  $\zeta_H^{\text{Ad}(F)} := \text{id}_{FH} * \tilde{\xi}^F$  for  $H \in \text{Obj}(\text{End}(\mathcal{C}))$ , which define modifications  $\kappa^{\text{Ad}(F)} : \chi^{\text{Ad}(F)} \circ (\iota^{\text{Ad}(F)} * \text{id}_{\text{Ad}(F)}) \cong \text{id}_{\text{Ad}(F)}$  and  $\zeta^{\text{Ad}(F)} : \chi^{\text{Ad}(F)} \circ (\text{id}_{\text{Ad}(F)} * \iota^{\text{Ad}(F)}) \cong \text{id}_{\text{Ad}(F)}$  by coherence. To check that these modifications satisfy Axiom (HTA2) in

[GPS95, Definition 3.1], it is enough to show  $\text{id}_{\text{ev}^F} \otimes (\text{id}_{F^{-1}} * \xi^F) = \text{id}_{\text{ev}^F} \otimes (\tilde{\xi}^F * \text{id}_F)$ . For this, note that the component of the comparison constant  $\text{ev}^F \circ (\text{id}_{F^{-1}F} * \text{ev}^F) \cong \text{ev}^F \circ (\text{ev}^F * \text{id}_{F^{-1}F})$  for  $C \in \text{Obj}(\mathcal{C})$  is given by  $F^\vee(\text{ev}_{f_{F(C)}} \otimes (\widetilde{\text{coev}}_{f_{F(C)}}^F)^{-1} \otimes \text{id}_{FF^{-1}F(C)})$ . Then, we can find that it is enough to show  $\text{ev}_{f_{F(C)}} \otimes \text{id}_{f_{F(C)}^\vee f_{F(C)}} = \text{id}_{f_{F(C)}^\vee f_{F(C)}} \otimes \text{ev}_{f_{F(C)}}$ , which follows since  $f_{F(C)}^\vee$  is an adjoint inverse. Thus,  $\text{Ad}(F)$  is a monoidal pseudofunctor.

Finally, we show that another choice of an adjoint inverse  $F_2^{-1}$  yields an equivalent monoidal pseudofunctor  $\text{Ad}_2(F)$ . Let  $\tilde{f}_D$  for  $D \in \text{Obj}(\mathcal{D})$  denote  $\text{coev}_D^{F,0}$  for  $F_2^{-1}$ , and let  $F_2^\vee$  denote  $F^\vee$  for  $F_2^{-1}$ . Also, let  $\text{coev}_2^F$  and  $\text{ev}_2^F$  respectively denote  $\text{coev}^F$  and  $\text{ev}^F$  for  $F_2^{-1}$ . For  $H \in \text{Obj}(\text{End}(\mathcal{C}))$ , put  $\eta_H^0 := \text{id}_{FH} * \tau : \text{Ad}(F)(H) \simeq \text{Ad}_2(F)(H)$ , where  $\tau : F^{-1} \simeq F_2^{-1}$  denotes the pseudonatural equivalence obtained from  $\text{coev}_2^F(\text{coev}^F)^\vee : FF^{-1} \simeq FF_2^{-1}$  and  $^\vee$  denotes a left adjoint inverse in  $\text{End}(\mathcal{D})$ , by duality. For  $H, H' \in \text{Obj}(\text{End}(\mathcal{C}))$  and  $\sigma \in \text{Hom}(H, H')$ , define  $\eta_\sigma : \eta_{H'}^0 \circ \text{Ad}(F)(\sigma) \cong \text{Ad}_2(F)(\sigma) \circ \eta_H^0$  to be the canonical isomorphism, which gives a pseudonatural equivalence  $\eta = (\eta^0, \eta) : \text{Ad}(F) \simeq \text{Ad}_2(F)$  by coherence. Then, for  $C \in \text{Obj}(\mathcal{C})$ , define an invertible 2-cell

$$\begin{aligned} \alpha_C : (\text{ev}_2^F \circ (\tau * \text{id}_F))_C^0 &= F_2^\vee(\tilde{f}_{F(C)}^\vee)F^\vee(f_{FF_2^{-1}F(C)}^\vee f_{FF_2^{-1}F(C)} \tilde{f}_{F(C)}^\vee f_{F(C)}^\vee f_{FF^{-1}F(C)}^\vee f_{FF^{-1}F(C)}) \\ &\rightarrow \text{ev}_C^{F,0} = F^\vee(f_{F(C)}^\vee) \end{aligned}$$

to be

$$F^\vee((\text{ev}_{\tilde{f}_{F(C)}} \otimes \text{id}_{f_{F(C)}^\vee})(\text{id}_{\tilde{f}_{F(C)}^\vee} \otimes \text{ev}_{f_{FF_2^{-1}F(C)}} \otimes \text{id}_{\tilde{f}_{F(C)}^\vee f_{F(C)}^\vee} \otimes \text{ev}_{f_{FF^{-1}F(C)}}))(\beta_{\tilde{f}_{F(C)}^\vee} \otimes \text{id}_{\tau_{F(C)}^0}),$$

where  $\beta$  denotes the canonical isomorphism  $F_2^\vee \cong F^\vee$ . It is routine to check that  $\alpha$  is indeed a modification  $\text{ev}_2^F \circ (\tau * \text{id}_F) \cong \text{ev}^F$ . For  $H, K \in \text{Obj}(\text{End}(\mathcal{C}))$ , define  $\Pi_{H,K} : \chi_{H,K}^{\text{Ad}_2(F),0} \circ (\eta_H^0 * \eta_K^0) \cong \eta_{HK}^0 \circ \chi_{H,K}^{\text{Ad}(F),0}$  to be  $\text{id}_{FH} * \alpha * \text{id}_K * \text{id}_\tau$ , which gives a modification  $\Pi : \chi^{\text{Ad}_2(F)} \circ (\eta * \eta) \cong \eta \circ \chi^{\text{Ad}(F)}$  by coherence. Then,  $\eta$  and  $\Pi$  satisfy the condition in [GPS95, pp. 21–22] by coherence. Finally, define  $M : \eta_{\text{id}_C}^0 \circ \iota^{\text{Ad}(F)} \cong \iota^{\text{Ad}_2(F)}$  to be the composition of the modifications in Figure 1, where  $\tilde{\xi}_2^F$  denotes  $\tilde{\xi}^F$  for  $F_2^{-1}$ . Note that e.g.  $\xi^F$  indeed denotes  $(\xi^F * \text{id}_{F_2^{-1}}) \otimes \text{id}_{\text{coev}_2^F}$  etc. Then,  $\eta, \Pi$  and  $M$  satisfy the conditions in [GPS95, pp. 23–24] by  $\text{id}_{\text{ev}^F} \otimes (\text{id}_{F^{-1}} * \xi_2^F) = \text{id}_{\text{ev}^F} \otimes (\tilde{\xi}_2^F * \text{id}_F)$ . Thus,  $(\eta, \Pi, M)$  is a monoidal pseudonatural equivalence  $\text{Ad}(F) \simeq \text{Ad}_2(F)$ .  $\square$

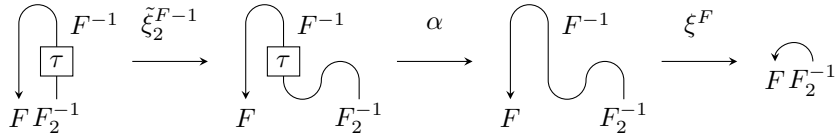

Figure 1: A modification  $M$

**Remark 2.2.** The proof above shows that a biequivalence is indeed a 2-dualizable pseudofunctor in the sense of the tricategory version of [CP22, Definitions 5.1 and 6.1].

**Definition 2.3.** Let  $(\mathcal{C}, \gamma^{\mathcal{C}})$  and  $(\mathcal{D}, \gamma^{\mathcal{D}})$  be pairs of bicategories and actions of a group  $G$ . A  $G$ -biequivalence between  $(\mathcal{C}, \gamma^{\mathcal{C}})$  and  $(\mathcal{D}, \gamma^{\mathcal{D}})$  is the pair  $F = (F, \eta^F)$  of a biequivalence  $F : \mathcal{C} \rightarrow \mathcal{D}$  and a monoidal equivalence  $\eta^F : \text{Ad}(F) \circ \gamma^{\mathcal{C}} \simeq \gamma^{\mathcal{D}}$ .

The existence of a  $G$ -biequivalence between bicategories does not depend on a choice of  $F^{-1}$  by Lemma 2.1.

**Lemma 2.4.**  $G$ -biequivalence is indeed an equivalence relation.

*Proof.* Reflexivity follows since  $\text{Ad}(\text{id}_{\mathcal{C}}) \simeq \text{id}_{\text{End}(\mathcal{C})}$  as monoidal pseudofunctors by coherence. We show transitivity. Let  $F : \mathcal{C} \rightarrow \mathcal{D}$  and  $H : \mathcal{D} \rightarrow \mathcal{E}$  be biequivalences. We fix  $F^{-1}$  and  $H^{-1}$ , set  $(HF)^{-1}(E) := F^{-1}H^{-1}(E)$ ,  $\text{coev}_E^{HF,0} := H(f_{H^{-1}(E)})h_E$  and  $(\text{coev}_E^{HF,0})^\vee := h_E^\vee H(f_{H^{-1}(E)}^\vee)$

for  $E \in \text{Obj}(\mathcal{E})$ , where  $f := \text{coev}^{F,0}$  and  $h := \text{coev}^{H,0}$ , and set  $(HF)^\vee := F^\vee H^\vee$ . Then, for  $\lambda \in \text{Hom}_{\mathcal{E}}(E, E')$ , we have an invertible 2-cell

$$F^\vee(\tilde{\text{ev}}_{f_{H^{-1}(E)}}^H \otimes \text{id}_{H^{-1}(\lambda)} \otimes \tilde{\text{ev}}_{f_{H^{-1}(E)}}^H) : (HF)^{-1}(\lambda) = F^\vee(H^\vee H(f_{H^{-1}(E')})H^{-1}(\lambda)H^\vee H(f_{H^{-1}(E)}^\vee)) \\ \rightarrow F^{-1}H^{-1}(\lambda) = F^\vee(f_{H^{-1}(E')}H^{-1}(\lambda)f_{H^{-1}(E)}^\vee),$$

which defines a pseudonatural equivalence  $\tau : (HF)^{-1} \simeq F^{-1}H^{-1}$ . Moreover, we define an invertible 2-cell

$$(\text{ev}^H \circ \text{Ad}(H)(\text{ev}^F) \circ (\tau * \text{id}_{HF}))_C^0 = F^\vee(f_{F(C)}^\vee f_{F(C)} H^\vee (h_{HF(C)}^\vee) f_{H^{-1}HF(C)}^\vee) \\ \rightarrow \text{ev}_C^{HF,0} = F^\vee(H^\vee (h_{HF(C)}^\vee) H^\vee H(f_{H^{-1}HF(C)}^\vee))$$

for  $C \in \text{Obj}(\mathcal{C})$  to be  $F^\vee((\text{id}_{H^\vee(h_{HF(C)}^\vee)} \otimes (\tilde{\text{ev}}_{f_{H^{-1}HF(C)}}^H)^{-1})(\text{ev}_{f_{F(C)}} \otimes \text{id}_{H^\vee(h_{HF(C)}^\vee)} f_{H^{-1}HF(C)}^\vee))$ , which indeed defines a modification  $\text{ev}^H \circ \text{Ad}(H)(\text{ev}^F) \circ (\tau * \text{id}_{HF}) \cong \text{ev}^{HF}$ . Then, we obtain a monoidal equivalence  $\text{Ad}(HF) \simeq \text{Ad}(H) \text{Ad}(F)$  as in the final part of the proof of Lemma 2.1, and therefore  $G$ -biequivalence is transitive. Finally, we show symmetry. Since  $\text{Ad}(F^{-1}F) \simeq \text{Ad}(F^{-1}) \text{Ad}(F)$  as monoidal pseudofunctors for a biequivalence  $F$  by the argument so far, it is enough to show that for biequivalences  $F, \tilde{F} : \mathcal{C} \rightarrow \mathcal{D}$  with a pseudonatural equivalence  $\tau : F \simeq \tilde{F}$ , we have a monoidal equivalence  $\text{Ad}(F) \simeq \text{Ad}(\tilde{F})$ . Define  $\tilde{\tau} : F^{-1} \simeq \tilde{F}^{-1}$  to be  $(\text{ev}^F * \text{id}_{\tilde{F}^{-1}}) \circ (\text{id}_{F^{-1}} * \tau^\vee * \text{id}_{\tilde{F}^{-1}}) \circ (\text{id}_{F^{-1}} * \text{coev}^{\tilde{F}})$ . Also, define an invertible modification  $\alpha : \text{ev}^{\tilde{F}} \circ (\tilde{\tau} * \tau) \cong \text{ev}^F$  by Figure 2. Then, by putting  $\eta_H := \tau * \text{id}_H * \tilde{\tau}$  and  $\Pi_{H,K} := \text{id}_{FH} * \alpha * \text{id}_{KF^{-1}}$  for  $H, K \in \text{Obj}(\text{End}(\mathcal{C}))$ , we obtain a pseudonatural equivalence  $\eta$  and an invertible modification  $\Pi$  with the condition in [GPS95, pp. 21–22] as in the proof of Lemma 2.1. Define a modification  $M$  by Figure 3. We can see that  $(\eta, \Pi, M)$  is a monoidal equivalence  $\text{Ad}(F) \simeq \text{Ad}(\tilde{F})$  by the duality of  $\tau$ .  $\square$

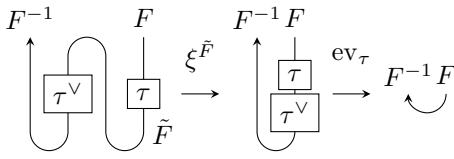

Figure 2: A modification  $\alpha$

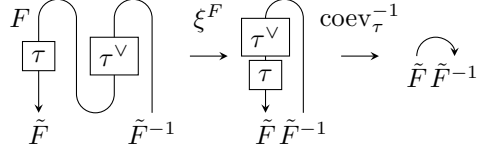

Figure 3: A modification  $M$

By definition [GPS95, Section 3.3], for a  $G$ -biequivalence  $F : (\mathcal{C}, \gamma^{\mathcal{C}}) \rightarrow (\mathcal{D}, \gamma^{\mathcal{D}})$ , the monoidal equivalence  $\eta^F$  consists of pseudonatural equivalences  $\eta_g^F : \text{Ad}(F)(\gamma^{\mathcal{C}}(g)) \simeq \gamma^{\mathcal{D}}(g)$ , invertible modifications  $\Pi_{g,h}^F : \chi_{g,h}^{\gamma^{\mathcal{D}}} \circ (\eta_g^F * \eta_h^F) \cong \eta_{gh}^F \circ \text{Ad}(F)(\chi_{g,h}^{\gamma^{\mathcal{C}}}) \circ \chi_{\gamma^{\mathcal{C}}(g), \gamma^{\mathcal{D}}(h)}^{\text{Ad}(F),0}$  for  $g, h \in G$  and an invertible modification  $M^F : \eta_e^F \circ \text{Ad}(F)(\iota^{\gamma^{\mathcal{C}}}) \circ \iota^{\text{Ad}(F)} \cong \iota^{\gamma^{\mathcal{D}}}$ . Let  $\eta_g^F$  be graphically represented by a fork with three inputs  $F, \gamma^{\mathcal{C}}(g)$  and  $F^{-1}$  and one output  $\gamma^{\mathcal{D}}(g)$ .

Next, we compare our definition with that in [BGM19, Definition 2.3]. Suppose we are given a  $G$ -biequivalence  $F : (\mathcal{C}, \gamma^{\mathcal{C}}) \rightarrow (\mathcal{D}, \gamma^{\mathcal{D}})$ . Then, we obtain  $\tilde{\eta}_g^F : F\gamma^{\mathcal{C}}(g) \simeq \gamma^{\mathcal{D}}(g)F$  for  $g \in G$  by duality: namely, we put  $\tilde{\eta}_g^F := (\eta_g^F * \text{id}_F) \circ (\text{id}_{F\gamma^{\mathcal{C}}(g)} * (\text{ev}^F)^\vee)$ . Moreover, we can define invertible modifications  $\tilde{\Pi}_{g,h}^F : (\chi_{g,h}^{\gamma^{\mathcal{D}}} * \text{id}_F) \circ (\text{id}_{\gamma^{\mathcal{D}}(g)} * \tilde{\eta}_h^F) \circ (\tilde{\eta}_g^F * \text{id}_{\gamma^{\mathcal{C}}(h)}) \cong \tilde{\eta}_{gh}^F \circ (\text{id}_F * \chi_{g,h}^{\gamma^{\mathcal{C}}})$  for  $g, h \in G$  and  $\tilde{M}^F : \tilde{\eta}_e^F \circ (\text{id}_F * \iota^{\gamma^{\mathcal{C}}}) \cong \iota^{\gamma^{\mathcal{D}}} * \text{id}_F$  by Figures 4 and 5. We can check that they satisfy the conditions in Figures 6, 7 and 8, where a crossing from  $F\gamma^{\mathcal{C}}(g)$  to  $\gamma^{\mathcal{D}}(g)F$  denotes  $\tilde{\eta}_g^F$  for  $g \in G$ , with some standard computations, but note that we use  $\text{id}_{\text{ev}^F} \otimes (\text{id}_{F^{-1}} * \xi^F) = \text{id}_{\text{ev}^F} \otimes (\xi^F * \text{id}_F)$  in the check for Figure 8. Conversely, when a biequivalence  $F$  and a triple  $(\tilde{\eta}^F, \tilde{\Pi}^F, \tilde{M}^F)$  with the conditions in Figures 6, 7 and 8 are given, we can construct a triple  $(\eta^F, \Pi^F, M^F)$  by putting  $\eta_g^F := (\text{id}_{\gamma^{\mathcal{D}}(g)} * (\text{coev}^F)^\vee) \circ (\tilde{\eta}_g^F * \text{id}_{F^{-1}})$  for  $g \in G$  and defining  $\Pi_{g,h}^F$  for  $g, h \in G$  and  $M^F$  by Figures 9 and 10. We can see that  $(F, \eta^F, \Pi^F, M^F)$  is a  $G$ -biequivalence, using the following lemma to check the condition in [GPS95, p. 24].

**Lemma 2.5.** For a biequivalence  $F$ , we have  $(\xi^F * \text{id}_{F^{-1}}) \otimes \text{id}_{\text{coev}^F} = (\text{id}_F * \tilde{\xi}^F) \otimes \text{id}_{\text{coev}^F}$ .

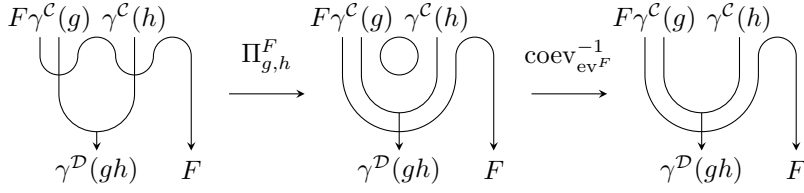

Figure 4: Construction of  $\tilde{\Pi}^F$  from  $\Pi^F$

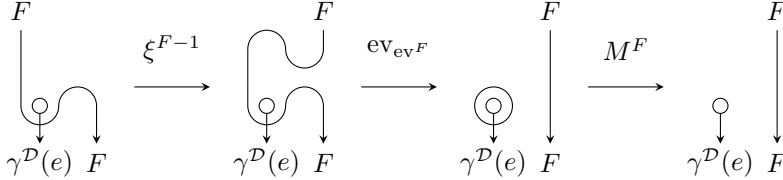

Figure 5: Construction of  $\tilde{M}^F$  from  $M^F$

*Proof.* We already proved  $\text{id}_{\text{ev}^F} \otimes (\text{id}_{F^{-1}} * \xi^F) = \text{id}_{\text{ev}^F} \otimes (\tilde{\xi}^F * \text{id}_F)$  in the proof of Lemma 2.1. Then, from  $(\text{id}_{\text{ev}^F} \otimes (\text{id}_{F^{-1}} * \xi^F))(\text{id}_{\text{ev}^F * \text{ev}^F} \otimes (\tilde{\xi}^F * \text{id}_{\text{coev}^F} * \text{id}_F)) = (\text{id}_{\text{ev}^F} \otimes (\tilde{\xi}^F * \text{id}_F))(\text{id}_{\text{ev}^F * \text{ev}^F} \otimes (\text{id}_{F^{-1}} * \text{id}_{\text{coev}^F} \xi^F))$  we obtain  $\text{id}_{\text{ev}^F * \text{ev}^F} \otimes (\tilde{\xi}^F * \text{id}_{\text{coev}^F} * \text{id}_F) = \text{id}_{\text{ev}^F * \text{ev}^F} \otimes (\text{id}_{F^{-1}} * \text{id}_{\text{coev}^F} \xi^F)$  and therefore  $\text{id}_{\text{ev}^F * \text{ev}^F} \otimes (\text{id}_{F^{-1}} * \xi^F * \text{id}_{F^{-1}F}) \otimes (\text{id}_{F^{-1}} * \text{id}_{\text{coev}^F} * \text{id}_F) = \text{id}_{\text{ev}^F * \text{ev}^F} \otimes (\text{id}_{F^{-1}F} * \xi^F * \text{id}_F) \otimes (\text{id}_{F^{-1}} * \text{id}_{\text{coev}^F} * \text{id}_F)$ . Thus, we obtain the statement since we may compose  $\xi^{F-1} * \tilde{\xi}^{F-1}$  with the modifications in the statement.  $\square$

Thus, we can equivalently define a  $G$ -equivalence to be a tuple  $(F, \tilde{\eta}^F, \tilde{\Pi}^F, \tilde{M}^F)$  with the conditions in Figures 6, 7 and 8, which reduces to [BGM19, Definition 2.3] when the action is unital.

Then, we state the coherence theorem for group actions on bicategories [BGM19, Theorem 3.1] in the form of “all diagrams commute” for our convenience.

**Theorem 2.6.** Let  $\mathcal{C}$  be a bicategory with an action  $\gamma^C$  of a group  $G$ . Define a set  $W = \bigsqcup_{n \geq 0} W_n$  of words recursively by the following rules:  $\mathbf{1}_C^C, (\chi_{g,h}^C)_C^0, (\iota^C)_C^0 \in W_0$  for any 0-cell  $C$  and  $g, h \in G$ ,  $- \in W_1$ ,  $\otimes \in W_2$ ,  $\gamma^C(g) \in W_1$  for  $g \in G$  and  $w'((w_i)_i) \in W_{\sum_i n_i}$  for  $w' \in W_n$  and a family  $(w_i)_{i=1}^n$  with  $w_i \in W_{n_i}$ . Let the functor  $\mathcal{C}^n \rightarrow \mathcal{C}$ , where  $\mathcal{C}^0$  denotes the category with only one object and its identity morphism, corresponding naturally to a word  $w \in W_n$  be denoted again by  $w$ . Define a set  $I$  of morphisms recursively by the following rules: the components of  $a^C, l^C, r^C, J\gamma^C(g)$  and  $\varphi^{\gamma^C(g)}$  are in  $I$ ,  $(\chi_{g,h}^C)_\lambda$  and  $(\iota^C)_\lambda$  for any 1-cell  $\lambda$  and  $g, h \in G$  are in  $I$ ,  $\omega_{g,h,k}^{\gamma^C}, \kappa_g^{\gamma^C}, \zeta_g^{\gamma^C} \in I$  for  $g, h, k \in G$ ,  $f^{-1} \in I$  for  $f \in I$ ,  $f \circ f' \in I$  for  $f, f' \in I$  if it is well-defined and  $w((f_i)_i) \in I$  for  $w \in W_n$  and  $(f_i)_{i=1}^n \subset I$ . Then, for any  $w, w' \in W_n$  and 1-cells  $(\lambda_i)_{i=1}^n$ , a 2-cell  $w((\lambda_i)_i) \rightarrow w'((\lambda_i)_i)$  in  $I$  is unique if it exists.

*Proof.* By the proof of [BGM19, Theorem 3.1], there exists a  $G$ -biequivalence  $F$  from  $\mathcal{C}$  to a 2-category  $\mathcal{D}$  with a strict action  $\gamma^D$  (see [BGM19, Definition 2.2]) such that every equivalence 1-cell is indeed an isomorphism. We regard  $F$  as data  $(F, \tilde{\eta}^F, \tilde{\Pi}^F, \tilde{M}^F)$  as above. We define 2-cells  $C_{(\lambda_i)_i}^v$  for  $v \in W_n$  and 1-cells  $(\lambda_i)_{i=1}^n$  recursively by the following rules:  $C^{\mathbf{1}_C^C} := (\varphi_C^F)^{-1} : F(\mathbf{1}_C^C) \cong \mathbf{1}_{F(C)}^D$  for  $C \in \text{Obj}(\mathcal{C})$ ,  $C_{\lambda,\mu}^{\otimes} := (J_{\lambda,\mu}^F)^{-1} : F(\lambda\mu) \cong F(\lambda)F(\mu)$  for 1-cells  $\lambda$  and  $\mu$  of  $\mathcal{C}$ ,  $C_\lambda^{\gamma^C(g)} := \text{id} \otimes (\tilde{\eta}_g^F)_\lambda : F\gamma^C(g)(\lambda) \cong ((\tilde{\eta}_g^F)_C^0)^{-1} \gamma^D(g)F(\lambda)(\tilde{\eta}_g^F)_C^0$  for  $\lambda \in \text{Hom}_{\mathcal{C}}(C, C')$  and  $g \in G$ ,  $C^{(\chi_{g,h}^C)_C^0} := \text{id} \otimes (\tilde{\Pi}_{g,h}^F)_C^{-1} : F((\chi_{g,h}^C)_C^0) \cong ((\tilde{\eta}_{gh}^F)_C^0)^{-1} \gamma^D(g)((\tilde{\eta}_g^F)_C^0)(\tilde{\eta}_g^F)_{\gamma^C(h)(C)}^0$  for  $C \in \text{Obj}(\mathcal{C})$  and  $g, h \in G$ ,  $C^{(\iota^C)_C^0} := \text{id} \otimes \tilde{M}_C^F : F((\iota^C)_C^0) \cong ((\tilde{\eta}_e^F)_C^0)^{-1}$  for  $C \in \text{Obj}(\mathcal{C})$  and  $C_{(\lambda_i)_i}^{v((w_i)_i)} := v((C_{\lambda_i}^{w_i})_i) \circ C_{(w_i)_i}^v$  for  $v \in W_n$ ,  $(w_i)_{i=1}^n \subset W$  and 1-cells  $(\lambda_i)_{i=1}^n$ .

We show  $C_{(\lambda_i)_i}^w = C_{(\lambda_i)_i}^{w'} \circ F(f)$  for any 2-cell  $f : w((\lambda_i)_i) \rightarrow w'((\lambda_i)_i)$ , which uniquely determines  $f$ . It is enough to prove this when  $f$  is a generator of  $I$ . The statement for  $a^C, l^C, r^C, J\gamma^C(g)$

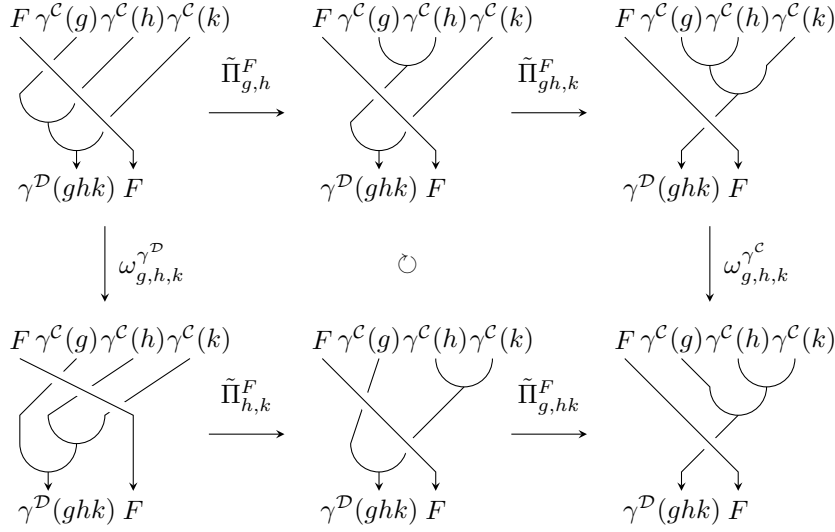

Figure 6: The coherence for  $\omega$ 's

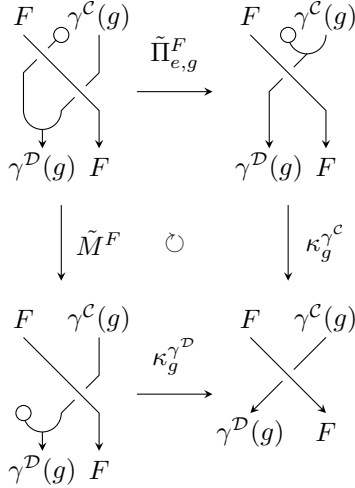

Figure 7: The coherence for  $\kappa$ 's

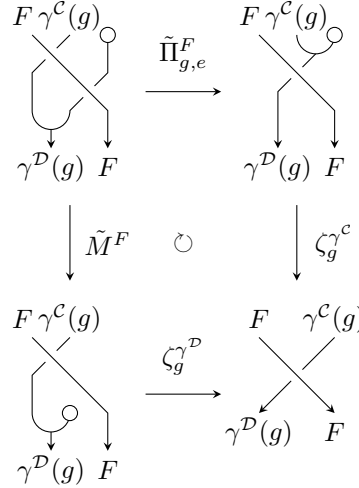

Figure 8: The coherence for  $\zeta$ 's

and  $\varphi^{\gamma^c(g)}$  follows since  $F$  is a pseudofunctor and  $\tilde{\eta}_g^F$  is a pseudonatural transformation for any  $g \in G$ , which is standard. The statement for  $(\chi_{g,h}^{\gamma^c})_\lambda$  and  $(\iota^{\gamma^c})_\lambda$  follows since  $\tilde{\Pi}_{g,h}^F$  and  $\tilde{M}^F$  are modifications. The statement for  $\omega_{g,h,k}^{\gamma^c}$ ,  $\kappa_g^{\gamma^c}$  and  $\zeta_g^{\gamma^c}$  follows from Figures 6, 7 and 8.  $\square$

Thanks to this theorem, we may hereafter suppress the 2-cells in  $I$  in this article. Finally, we return to the case of monoidal categories.

**Definition 2.7.** Let  $(\mathcal{C}, \gamma^c)$  and  $(\mathcal{D}, \gamma^D)$  be monoidal categories with actions of a group  $G$ . A *monoidal  $G$ -equivalence* is a  $G$ -biequivalence with monoidal natural isomorphisms  $\eta_g^F : \text{Ad}(F) \circ \gamma^c(g) \cong \gamma^D(g)$  (see [EGNO15, Definition 2.4.8]) and identical  $\Pi^F$  and  $M^F$ .

As we have already seen, we can give an equivalent definition of a monoidal  $G$ -equivalence with  $\tilde{\eta}^F$ , where  $\tilde{\Pi}^F$  and  $\tilde{M}^F$  are identical. Namely, we can define a  $G$ -biequivalence to be the pair  $(F, \tilde{\eta}^F)$  with  $\tilde{\eta}_{gh}^F = (\text{id} * \tilde{\eta}_h^F) \circ (\tilde{\eta}_g^F * \text{id})$  for  $g, h \in G$  and  $\tilde{\eta}_e^F = \text{id}$ , where we suppressed some natural isomorphisms by Theorem 2.6. Since these equations do not include an adjoint inverse  $F^{-1}$ , we can give the following definition, which recovers that in [Gal17, Section 3.1] for unital actions.



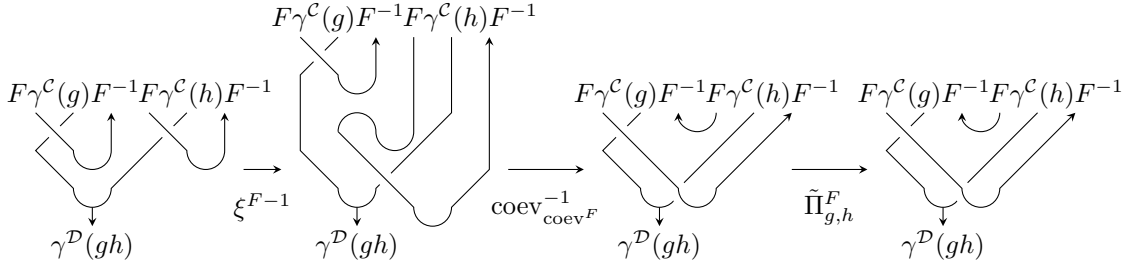

Figure 9: Construction of  $\Pi^F$  from  $\tilde{\Pi}^F$

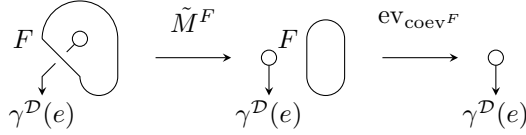

Figure 10: Construction of  $M^F$  from  $\tilde{M}^F$

**Definition 2.8.** Let  $(\mathcal{C}, \gamma^{\mathcal{C}})$  and  $(\mathcal{D}, \gamma^{\mathcal{D}})$  be monoidal categories with actions of a group  $G$ . A *monoidal  $G$ -functor* is the pair  $(F, \tilde{\eta}^F)$  of a monoidal functor  $F$  and a family  $\tilde{\eta}^F$  of monoidal isomorphisms  $\tilde{\eta}_g^F : F\gamma^{\mathcal{C}}(g) \cong \gamma^{\mathcal{D}}(g)F$  for  $g \in G$  with  $\tilde{\eta}_{gh}^F = (\text{id} * \tilde{\eta}_h^F) \circ (\tilde{\eta}_g^F * \text{id})$  for  $g, h \in G$  and  $\tilde{\eta}_e^F = \text{id}$ .

By definition, a monoidal  $G$ -functor is a monoidal  $G$ -equivalence if and only if it is an equivalence as a functor. One can also define the notion of a  *$G$ -pseudofunctor*, recovering [BGM19, Definition 2.3], with Figures 6, 7 and 8 by replacing  $F$  by a general pseudofunctor, which is not necessary for this article.

## 2.2 Equivariantly braided tensor categories

In this subsection, we recall the notion of  $G$ -crossed multitensor categories and  $G$ -braided multitensor categories.

Our terminologies on tensor category theory follow those in [EGNO15]. In particular, a *multitensor category* over a field  $k$  is a locally finite  $k$ -linear abelian rigid monoidal category with a bilinear monoidal product as in [EGNO15, Definition 4.1.1]. A *tensor functor* is an exact faithful  $k$ -linear monoidal functor as in [EGNO15, Definition 4.2.5].

**Remark 2.9.** Although tensor categories that arise in algebraic quantum field theory do not have zero objects as remarked in [Müg05, Remark 2.11], because we are interested only in their rigid subcategories, which are semisimple, we regard such a subcategory as an abelian category by adding a zero object. Note that a linear functor on such a category is automatically exact.

When  $\mathcal{C}$  is moreover a multitensor category, an *action* of  $G$  is a monoidal functor from  $\underline{G}$  to the monoidal category of the tensor autoequivalences on  $\mathcal{C}$ . When  $\mathcal{C}$  is moreover pivotal (see e.g. [EGNO15, Definition 4.7.8]), a *pivotal action* of  $G$  is a monoidal functor from  $\underline{G}$  to the monoidal category of the pivotal tensor autoequivalences on  $\mathcal{C}$ . Recall that a monoidal functor  $F : \mathcal{C} \rightarrow \mathcal{D}$  is *pivotal* when  $\delta^{\mathcal{D}}F = F\delta^{\mathcal{C}}$ , where  $\delta^{\mathcal{C}}$  denotes the pivotal structure of  $\mathcal{C}$ .

First, we recall the notion of a *grading* on a multitensor category. Let  $\{\mathcal{C}_i\}_{i \in I}$  be a family of additive categories. Its *direct sum*  $\mathcal{C} = \bigoplus_{i \in I} \mathcal{C}_i$  is an additive category with a family of additive functors  $\{I_i : \mathcal{C}_i \rightarrow \mathcal{C}\}_{i \in I}$  which has the universality that for any additive category  $\mathcal{D}$  and a family of additive functors  $\{F_i : \mathcal{C}_i \rightarrow \mathcal{D}\}_{i \in I}$  there exists an additive functor  $F : \mathcal{C} \rightarrow \mathcal{D}$  with a family of natural isomorphisms  $\sigma^F = \{\sigma^{F,i} : FI_i \cong F_i\}_{i \in I}$  such that for any other such pair  $(\tilde{F}, \tilde{\sigma}^F)$  and a family of natural transformations  $\{\tau^i : F_i \rightarrow \tilde{F}_i\}_{i \in I}$  we have a unique natural transformation  $\tau : F \rightarrow \tilde{F}$  with  $\tau^i \circ \sigma^{F,i} = \sigma^{\tilde{F},i} \circ \tau I_i$  for any  $i \in I$ . Such a category  $\mathcal{C}$  always exists: indeed, we can explicitly give  $\mathcal{C}$  as the category of families of objects whose all but finite components are zero, see

e.g. [EGNO15, Section 1.3]. The category  $\mathcal{C}$  is unique up to a unique equivalence by universality. We can indeed take  $\sigma^{F,i}$ 's to be identities, and in this case, we refer to the natural transformation  $\tau$  obtained by universality as the *extension* of the original family of natural transformations  $\{\tau^i\}_{i \in I}$ .

We can equivalently define the direct sum  $\mathcal{C} = \bigoplus_{i \in I} \mathcal{C}_i$  to be an additive category which has  $\mathcal{C}_i$ 's as its subcategories such that every object is a direct sum of objects of  $\mathcal{C}_i$ 's and  $\text{Hom}_{\mathcal{C}}(\lambda, \mu) = \{0\}$  for  $\lambda \in \text{Obj}(\mathcal{C}_i)$  and  $\mu \in \text{Obj}(\mathcal{C}_j)$  with  $i \neq j$ . Indeed, the explicit construction above satisfies this property, and conversely by decomposing the objects of  $\mathcal{C}$  we obtain an additive equivalence from  $\mathcal{C}$  to  $\bigoplus_{i \in I} \mathcal{C}_i$ .

The objects in the set  $\text{Homog}(\mathcal{C}) := \bigcup_{i \in I} \text{Obj}(\mathcal{C}_i)$  are called *homogeneous*. We write  $\partial_{\mathcal{C}} \lambda = i$  or simply  $\partial \lambda = i$  if  $\lambda \in \text{Obj}(\mathcal{C}_i)$ . Since  $\text{Obj}(\mathcal{C}_i) \cap \text{Obj}(\mathcal{C}_j)$  consists of the zero objects of  $\mathcal{C}$  for  $i \neq j$ ,  $\partial$  is single-valued on nonzero objects.

By definition, we can always decompose an object into a direct sum of homogeneous objects. The following lemma shows that such a decomposition, which we call a *homogeneous decomposition*, is essentially unique.

**Lemma 2.10.** Let  $\lambda$  be an object of an  $I$ -graded multitensor category and let  $\lambda = \bigoplus_{i \in F} \lambda_i = \bigoplus_{j \in F'} \lambda'_j$  be decompositions in two ways with finite subsets  $F$  and  $F'$  of  $I$ . Then, for every  $i \in F \cap F'$  we have  $\lambda_i \cong \lambda'_i$  as subobjects (i.e. there exists an isomorphism  $f \in \text{Hom}(\lambda_i, \lambda'_i)$  such that  $\iota_i = \iota'_i \circ f$ , where  $\iota_i$  and  $\iota'_i$  denote the morphisms that embeds respectively  $\lambda_i$  and  $\lambda'_i$  into  $\lambda$ ) by a unique subobject isomorphism. Moreover,  $\lambda_i \cong 0$  for every  $i \in F \setminus F'$  and  $\lambda'_j \cong 0$  for every  $j \in F' \setminus F$ .

*Proof.* Let  $p_i$  and  $p'_i$  denote the projections of the decompositions  $\lambda = \bigoplus_i \lambda_i$  and  $\lambda = \bigoplus_j \lambda'_j$  respectively, and let  $\iota_i$  and  $\iota'_j$  denote the corresponding inclusions. Since  $p_i \circ \iota'_j = 0$  and  $p'_j \circ \iota_i = 0$  for  $i \in F$  and  $j \in F' \setminus \{i\}$ , we have  $(p_i \circ \iota'_i) \circ (p'_i \circ \iota_i) = \sum_{j \in F'} p_i \circ \iota'_j \circ p'_j \circ \iota_i = \text{id}_{\lambda_i}$  and similarly  $(p'_i \circ \iota_i) \circ (p_i \circ \iota'_i) = \text{id}_{\lambda'_i}$  for every  $i \in F \cap F'$ . Moreover,  $\iota'_i \circ p'_i \circ \iota_i = \sum_{j \in I} \iota'_j \circ p'_j \circ \iota_i = \iota_i$ , which shows that  $p'_i \circ \iota_i \in \text{Hom}(\lambda_i, \lambda'_i)$  is a subobject isomorphism for every  $i \in F \cap F'$ . Uniqueness follows from  $p'_i \circ \iota_i = \text{id}_{\lambda'_i}$ . When  $i \in F \setminus F'$ , we have  $p_i = \sum_{j \in F'} p_i \circ \iota'_j \circ p'_j = 0$ . Then  $\text{id}_{\lambda_i} = p_i \circ \iota_i = 0$  and therefore  $\lambda_i \cong 0$ . A similar argument gives  $\lambda'_j \cong 0$  for  $j \in F' \setminus F$ .  $\square$

The following notions, which were introduced in [Tur00, Section 2] and [Kir04, Definition 2.1], are what we are interested in.

**Definition 2.11.** Let  $G$  be a group. A  $G$ -grading on a multitensor category  $\mathcal{C}$  is its decomposition into a direct sum  $\mathcal{C} = \bigoplus_{g \in G} \mathcal{C}_g$  of a family  $\{\mathcal{C}_g\}_{g \in G}$  of abelian full subcategories of  $\mathcal{C}$  with  $\text{Obj}(\mathcal{C}_g) \otimes \text{Obj}(\mathcal{C}_h) \subset \text{Obj}(\mathcal{C}_{gh})$  for any  $g, h \in G$ . A multitensor category with a  $G$ -grading is called a  $G$ -graded multitensor category. A  $G$ -graded tensor functor between  $G$ -graded multitensor categories is a tensor functor  $F : \mathcal{C} \rightarrow \mathcal{D}$  with  $F(\text{Obj}(\mathcal{C}_g)) \subset \text{Obj}(\mathcal{D}_g)$  for every  $g \in G$ .

A  $G$ -crossed multitensor category is the pair  $\mathcal{C} = (\mathcal{C}, \gamma^{\mathcal{C}})$  of a pivotal  $G$ -graded multitensor category  $\mathcal{C}$  and a pivotal action  $\gamma^{\mathcal{C}}$  of  $G$  on  $\mathcal{C}$  such that  $\gamma^{\mathcal{C}}(g)(\text{Obj}(\mathcal{C}_h)) \subset \text{Obj}(\mathcal{C}_{ghg^{-1}})$  for  $g, h \in G$ . A  $G$ -crossed functor between  $G$ -crossed multitensor categories is a tensor  $G$ -functor (i.e. a monoidal  $G$ -functor which is a tensor functor as a monoidal functor, see Definition 2.8) which is  $G$ -graded and pivotal. A  $G$ -crossed functor is a  $G$ -crossed equivalence if it is an equivalence as a functor.

A  $G$ -braided multitensor category is the pair  $\mathcal{C} = (\mathcal{C}, b^{\mathcal{C}})$  of a  $G$ -crossed multitensor category  $\mathcal{C}$  and a family  $b^{\mathcal{C}}$  of isomorphisms  $b_{\lambda, \mu}^{\mathcal{C}} : \lambda \mu \cong {}^g \mu \lambda$  for  $\lambda \in \text{Obj}(\mathcal{C}_g), \mu \in \text{Obj}(\mathcal{C})$  and  $g \in G$  which is natural in  $\lambda$  and  $\mu$  such that  ${}^h b_{\lambda, \mu}^{\mathcal{C}} = b_{h\lambda, h\mu}^{\mathcal{C}}, b_{\lambda_1 \lambda_2, \mu}^{\mathcal{C}} = (b_{\lambda_1, g_2 \mu}^{\mathcal{C}} \otimes \text{id}_{\lambda_2}) \circ (\text{id}_{\lambda_1} \otimes b_{\lambda_2, \mu}^{\mathcal{C}})$  and  $b_{\lambda, \mu_1 \mu_2}^{\mathcal{C}} = (\text{id}_{g \mu_1} \otimes b_{\lambda, \mu_2}^{\mathcal{C}}) \circ (b_{\lambda, \mu_1}^{\mathcal{C}} \otimes \text{id}_{\mu_2})$  for  $\lambda \in \text{Obj}(\mathcal{C}_g), \lambda_1 \in \text{Obj}(\mathcal{C}_{g_1}), \lambda_2 \in \text{Obj}(\mathcal{C}_{g_2}), \mu, \mu_1, \mu_2 \in \text{Obj}(\mathcal{C})$  and  $g, h, g_1, g_2 \in G$ , where we suppressed some isomorphisms by Theorem 2.6. We call  $b^{\mathcal{C}}$  the  $G$ -braiding of  $\mathcal{C}$ . A  $G$ -braided functor between  $G$ -braided multitensor categories  $\mathcal{C}$  and  $\mathcal{D}$  is a  $G$ -crossed functor  $F : \mathcal{C} \rightarrow \mathcal{D}$  such that  $F(b_{\lambda, \mu}^{\mathcal{C}}) = ((\tilde{\eta}_g^{\mathcal{D}})_{\mu} \otimes \text{id}_{F(\lambda)}) \circ b_{F(\lambda), F(\mu)}^{\mathcal{D}}$  for  $\lambda \in \text{Obj}(\mathcal{C}_g), \mu \in \text{Obj}(\mathcal{C})$  and  $g \in G$ . A  $G$ -braided functor is a  $G$ -braided equivalence if it is a  $G$ -crossed equivalence.

For a  $G$ -braided multitensor category  $\mathcal{C}$ , we can define a family of isomorphisms  $b^{\mathcal{C}^-}$  by putting  $b_{\mu, \lambda}^{\mathcal{C}^-} := b_{\lambda, \mu}^{\mathcal{C}^{-1}} : {}^g \mu \lambda \cong \lambda \mu$  for  $\lambda \in \text{Obj}(\mathcal{C}_g), \mu \in \text{Obj}(\mathcal{C})$  and  $g \in G$ . We call  $b^{\mathcal{C}^-}$  the *reverse* of  $b^{\mathcal{C}}$ .

Note that we automatically have  $\mathbf{1}_{\mathcal{C}} \in \text{Obj}(\mathcal{C}_e)$  for a  $G$ -graded multitensor category  $\mathcal{C}$ . We also have  $\lambda^{\vee}, {}^{\vee} \lambda \in \text{Obj}(\mathcal{C}_{g^{-1}})$  for  $\lambda \in \text{Obj}(\mathcal{C}_g)$ . The objects in  $\mathcal{C}_e$  are said to be *neutral*.

For a  $G$ -crossed multitensor category  $\mathcal{C}$ ,  $\lambda \in \text{Homog}(\mathcal{C}) \setminus \{0\}$  and  $\mu \in \text{Obj}(\mathcal{C})$ , we let  ${}^\lambda\mu$  denote  $\partial^\lambda\mu$ . Although  $\partial\lambda$  is ill-defined when  $\lambda$  is zero, we often write  ${}^\lambda\mu$  even when  $\lambda$  is possibly zero because we mostly use this notation to consider morphisms that become zero when  $\lambda$  is zero. Then, we have  ${}^{\lambda_1\lambda_2}\mu = {}^{\lambda_1}({}^{\lambda_2}\mu)$  for  $\lambda_1, \lambda_2 \in \text{Homog}(\mathcal{C})$  and  $\mu \in \text{Obj}(\mathcal{C})$  since  $\partial(\lambda_1\lambda_2) = \partial\lambda_1\partial\lambda_2$ . We let  ${}^{\bar{\lambda}}\mu$  denote  $(\partial\lambda)^{-1}\mu$  for  $\lambda \in \text{Homog}(\mathcal{C})$  and  $\mu \in \text{Obj}(\mathcal{C})$ . These notations also apply to morphisms.

A multitensor category that arises in algebraic quantum field theory is indeed a  $*$ -multitensor category i.e. a multitensor category over  $\mathbb{C}$  with a contravariant strict monoidal antilinear involution endofunctor  $*$  that is identical on objects and has positivity, see [Müg03, Section 2.4]. Note that we assume rigidity in our definition. For an action  $\gamma$  of a group  $G$  on a  $*$ -multitensor category, we always assume that  $\gamma(g)$  commutes with the  $*$ -involution for any  $g \in G$ . For a  $G$ -braided  $*$ -multitensor category, we always assume that the components of the  $G$ -braiding are unitary.

The following is our motivating example of a  $G$ -braided ( $*$ -)tensor category.

**Example 2.12.** Let  $\mathcal{A}$  be an irreducible Möbius covariant net with Haag duality on  $\mathbb{R}$ , see e.g. [KL04, Section 2] and [BE98, Section 2.2] for definitions. It is well-known [DHR71, Sections II and IV] (see also [BE98, Section 2]) that the category  $\text{Rep } \mathcal{A}$  of the finite index Doplicher–Haag–Roberts (DHR) endomorphisms of  $\mathcal{A}$  is a braided  $*$ -tensor category. It is known that when a group  $G$  acts on  $\mathcal{A}$  i.e. we have a homomorphism from  $G$  to the automorphism group

$$\text{Aut}(\mathcal{A}) := \{g \in \mathcal{U}(H_{\mathcal{A}}) \mid \mathcal{I} \text{ for } \forall I \in \mathcal{I} \text{ and } g\Omega_{\mathcal{A}} = \Omega_{\mathcal{A}}\}$$

of  $\mathcal{A}$ , where  $\mathcal{U}$  denotes the group of unitary operators,  $H_{\mathcal{A}}$  denotes the Hilbert space of  $\mathcal{A}$ ,  $\mathcal{I}$  denotes the set of the intervals in  $S^1$ ,  $\Omega_{\mathcal{A}}$  denotes the vacuum of  $\mathcal{A}$ , and we do not consider topologies, we can consider the  $G$ -twisted DHR endomorphisms of  $\mathcal{A}$  [Müg05, Definition 2.6], and the category  $G\text{-Rep } \mathcal{A}$  of the finite index  $G$ -twisted DHR endomorphisms of  $\mathcal{C}$  becomes a  $G$ -braided  $*$ -tensor category in such a way that we recover the classical DHR theory when  $G$  is trivial [Müg05, Theorem 2.21], see also [Noj20, Section 3].

We collect here some graphical calculi for  $G$ -braided multitensor categories. Our graphical notation follows that in [BEK99] i.e. a morphism in a monoidal category is represented as an arrow from top to bottom. Now, let  $\mathcal{C}$  be a  $G$ -braided multitensor category. We do not draw the isomorphisms in Theorem 2.6. For  $\lambda \in \text{Homog}(\mathcal{C})$  and  $\mu \in \text{Obj}(\mathcal{C})$ , the component  $b_{\lambda,\mu}^{\mathcal{C}}$  of the  $G$ -braiding is represented by the crossing in Figure 11. The component  $b_{\mu,\lambda}^{\mathcal{C}-}$  of the reverse is represented by the reverse crossing in Figure 12.

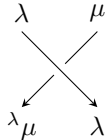

Figure 11: The  $G$ -braiding  $b_{\lambda,\mu}^{\mathcal{C}}$

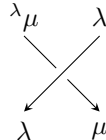

Figure 12: The reverse  $b_{\mu,\lambda}^{\mathcal{C}-}$

The naturality of  $b^{\mathcal{C}}$  is represented in Figure 13, where we may assume  $\partial\lambda = \partial\lambda'$  since otherwise the morphisms in the equation are zero. We also have a similar representation for  $b^{\mathcal{C}-}$ . The first axiom of a  $G$ -braiding says that  ${}^h b_{\lambda,\mu}^{\mathcal{C}}$  and  $b_{\lambda,h\mu}^{\mathcal{C}}$  are represented by the same diagram. The second and third axioms for  $b^{\mathcal{C}}$  are represented in Figure 14.

Since  $\text{coev}_{g\mu}$  and  ${}^g\text{coev}_{\mu}$  (resp.  $\text{ev}_{g\mu}$  and  ${}^g\text{ev}_{\mu}$ , and similar for right duals) are represented by the same diagram for  $\mu \in \text{Obj}(\mathcal{C})$  and  $g \in G$  (see e.g. [EGNO15, Exercise 2.10.6]), for example, we can perform the calculation in Figure 15 by Figures 13 and 14.

The following lemma is the  $G$ -equivariant version of [BEK99, Fig. 27].

**Lemma 2.13.** Let  $\mathcal{C}$  be a  $G$ -braided multitensor category. Let  $\lambda \in \text{Homog}(\mathcal{C})$  and let  $\mu \in \text{Obj}(\mathcal{C})$ . Then, the equations in Figure 16 hold.

*Proof.* By the graphical calculation in Figure 17, the leftmost diagram in Figure 16 is the right inverse of  $b_{\mu,\lambda}^{\mathcal{C}-}$ . One can similarly show that it is also the left inverse and therefore the left equality in Figure 16. The proof of the right equality is similar.  $\square$

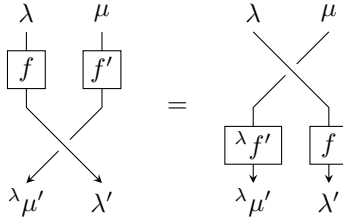

Figure 13: The naturality of a  $G$ -braiding

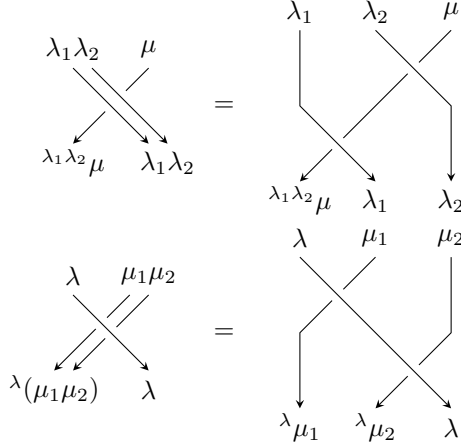

Figure 14: Axioms for the  $G$ -braiding  $b^{\mathcal{C}}$

Let  $\mathcal{C}$  be a  $G$ -braided multitensor category. For any  $\lambda, \mu \in \text{Obj}(\mathcal{C})$  and  $g \in G$ , let a dashed crossing labeled by  $g$  from  $\lambda\mu$  to  ${}^g\mu\lambda$  denote the morphism in Figure 18, where  $i_g$  and  $p_g$  respectively denote the inclusion and projection of  $\lambda_g$  in a homogeneous decomposition  $\lambda = \bigoplus_g \lambda_g$ . Then, this morphism does not depend on the choice of  $i_g$  and  $p_g$  by Lemma 2.10 and the naturality of  $b^{\mathcal{C}}$ . Note also that a dashed crossing is natural.

### 2.3 Equivariant Frobenius algebras

In this subsection, we recall the notion of  $G$ -equivariant Frobenius algebras.

A *Frobenius algebra* in a monoidal category is an algebra object with a compatible coalgebra structure, see e.g. [FFRS06, Section 2.3] for the precise definition and more terminologies. The product, unit, coproduct, and counit of a Frobenius algebra  $A$  are denoted by  $m_A, \eta_A, \Delta_A$ , and  $\varepsilon_A$  respectively.

For a pivotal multitensor category  $\mathcal{C}$ , we say a Frobenius algebra  $A$  in  $\mathcal{C}$  is *symmetric* if  $\delta_A^{\mathcal{C}} = \text{id}_A$  when  $A^\vee$  is taken to be  $A$ , see [FFRS06, Definition 2.22]. When  $A$  is moreover *special* (i.e.  $m_A \circ \Delta_A$  and  $\varepsilon_A \circ \eta_A$  are invertible scalars, see [FFRS06, Definition 2.22(iii)]), the product of the invertible scalars  $m_A \circ \Delta_A$  and  $\varepsilon_A \circ \eta_A$  is equal to  $\dim A$ . Since any symmetric special Frobenius algebra  $A$  has a unique corresponding coalgebra structure  $(\tilde{\Delta}_A, \tilde{\varepsilon}_A)$  with  $\tilde{\Delta}_A m_A = \text{id}_A$  and  $\tilde{\varepsilon}_A \eta_A = \dim A$  (see

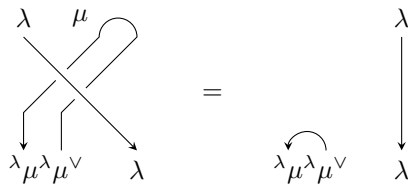

Figure 15: Moving an arc

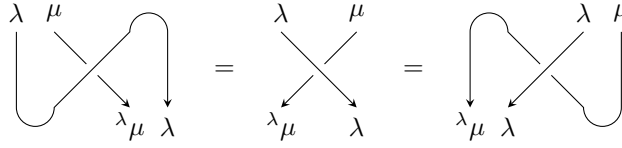

Figure 16: Rotations of a crossing

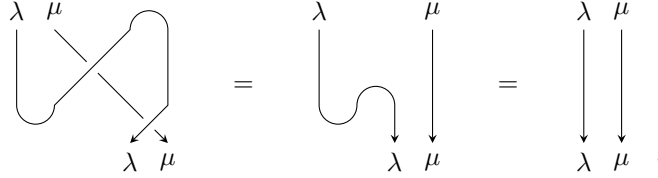

Figure 17: A part of the proof of rotations

e.g. [Müg03, Remark 3.14]), we assume from the beginning that  $\Delta_A m_A = \text{id}_A$  and  $\varepsilon_A \eta_A = \dim A$ .

A *Q-system* in a  $*$ -multitensor category is a triple  $(\theta, w, x)$  such that  $(\theta, x^*, w, x, (\dim \theta)w^*)$  is a special Frobenius algebra, see e.g. [BKLR15, Definition 3.8]. A Q-system is automatically symmetric by definition.

In this article, we have to consider *equivariant* Frobenius algebras. To define this notion, note that if  $A$  is an algebra (resp. Frobenius algebra) in a monoidal category with an action of a group  $G$ , then  ${}^g A = ({}^g A, {}^g m_A, {}^g \eta_A)$  (resp.  ${}^g A = ({}^g A, {}^g m_A, {}^g \eta_A, {}^g \Delta_A, {}^g \varepsilon_A)$ ) is again an algebra (resp. Frobenius algebra).

**Definition 2.14.** Let  $\mathcal{C}$  be a monoidal category with an action of a group  $G$ . A *G-equivariant algebra* in  $\mathcal{C}$  is a pair  $(A, z^A)$  of an algebra  $A$  in  $\mathcal{C}$  and a  $G$ -equivariant structure  $z^A$  on  $A$  (i.e.  $z_{gh}^A = z_g^A z_h^A$  for  $g, h \in G$ , see e.g. [EGNO15, Definition 2.7.2]) such that  $z_g^A : {}^g A \cong A$  is an algebra isomorphism for every  $g \in G$ . Similarly, a *G-equivariant Frobenius algebra* in  $\mathcal{C}$  is a pair  $A = (A, z^A)$  of a Frobenius algebra  $A$  in  $\mathcal{C}$  and a  $G$ -equivariant structure  $z^A$  on  $A$  such that  $z_g^A$  is a Frobenius algebra isomorphism for every  $g \in G$ . A *G-equivariant Q-system* in a  $*$ -multitensor category is a  $G$ -equivariant Frobenius algebra  $A$  such that  $A$  is a Q-system and  $z_g^A$  is unitary for every  $g \in G$ . A *homomorphism* between  $G$ -equivariant Frobenius algebras is a Frobenius algebra homomorphism that is  $G$ -equivariant. By an *isomorphism* between  $G$ -equivariant Q-systems, we always mean a unitary isomorphism.

The following are our motivating examples.

**Example 2.15.** It is well-known [Lon94] (see also [BKLR15, Theorem 3.11]) that a finite index extension of a type III factor  $N$  gives a Q-system in the  $*$ -tensor category  $\text{End}_0(N)$  of the finite index unital  $*$ -endomorphisms of  $N$  (see e.g. [BKLR15, Chapter 2]) up to isomorphisms and vice versa. Indeed, when a group  $G$  acts on  $N$ , we have the adjoint action of  $G$  on  $\text{End}(N)$ , and a

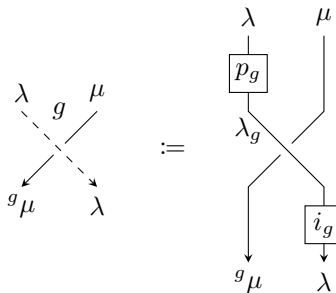

Figure 18: A dashed crossing

finite index extension of  $N$  with an extension of the action of  $G$  corresponds to a  $G$ -equivariant Q-system in  $\text{End}_0(N)$ , see [Noj20, Section 2.4].

**Example 2.16.** Let  $\mathcal{A}$  be an irreducible Möbius covariant net with Haag duality on  $\mathbb{R}$ . It is also known [LR95, Theorem 4.9] that a finite index standard extension  $\mathcal{B}$  of  $\mathcal{A}$  with a standard conditional expectation  $E$  (see [LR95, Definition 3.1] for the definition. Note that if  $\mathcal{B}$  is also a local Möbius covariant net, then it is indeed a standard extension with a standard conditional expectation) similarly corresponds to a Q-system in  $\text{Rep } \mathcal{A}$ .

Suppose we have an action  $\pi_{\mathcal{A}} : G \rightarrow \text{Aut}(\mathcal{A})$  of a group  $G$  on  $\mathcal{A}$ . Then, we have the adjoint action on  $\text{Rep } \mathcal{A}$ , which is the restriction of the action on  $G\text{-Rep } \mathcal{A}$ . For a standard extension  $\mathcal{A} \subset \mathcal{B}$ , let  $\text{Aut}(\mathcal{B})$  denote the group which consists of the unitaries preserving the local algebras and the vacuum as that for the Möbius covariant nets. We say an action  $\pi_{\mathcal{B}} : G \rightarrow \text{Aut}(\mathcal{B})$  of  $G$  on  $\mathcal{B}$  extends the action  $\pi_{\mathcal{A}}$  on  $\mathcal{A}$  if  $\text{Ad } \pi_{\mathcal{B}}(g)(a) = \text{Ad } \pi_{\mathcal{A}}(g)(a)$  for any interval  $I$  in  $\mathbb{R}$ ,  $a \in \mathcal{A}(I)$  and  $g \in G$ , see [BJLP19, Definition 6.2]. Note that in this case  $\text{Ad } \pi_{\mathcal{B}}(g)(\mathcal{A}(I)) \subset \mathcal{A}(I)$  in particular and therefore  $\pi_{\mathcal{B}}(g)$  commutes with the Jones projection  $e_{\mathcal{A}}$  of  $\mathcal{A} \subset \mathcal{B}$ . Hence indeed  $\text{Ad } \pi_{\mathcal{B}}(g) \circ E_I = E_I \circ \text{Ad } \pi_{\mathcal{B}}(g)$  for any interval  $I$  and  $g \in G$  since  $\pi_{\mathcal{B}}(g)E_I(b)\pi_{\mathcal{B}}(g)^{-1}\Omega_{\mathcal{B}} = \pi_{\mathcal{B}}(g)e_{\mathcal{A}}be_{\mathcal{A}}\pi_{\mathcal{B}}(g)^{-1}\Omega_{\mathcal{B}} = e_{\mathcal{A}}\pi_{\mathcal{B}}(g)b\pi_{\mathcal{B}}(g)^{-1}e_{\mathcal{A}}\Omega_{\mathcal{B}} = E_I(\pi_{\mathcal{B}}(g)b\pi_{\mathcal{B}}(g)^{-1})\Omega_{\mathcal{B}}$  for  $b \in \mathcal{B}(I)$ , where  $\Omega_{\mathcal{B}}$  denotes the vacuum of  $\mathcal{A} \subset \mathcal{B}$ . For a local Möbius covariant net  $\mathcal{A}$  with an action  $\pi_{\mathcal{A}}$  of a group  $G$ , we refer to the tuple  $\mathcal{A} \subset \mathcal{B} = (\mathcal{A} \subset \mathcal{B}, E^{\mathcal{B}}, \pi_{\mathcal{B}})$  of a standard extension, a standard conditional expectation and an extension of  $\pi_{\mathcal{A}}$  as a  $G$ -equivariant standard extension of  $(\mathcal{A}, \pi_{\mathcal{A}})$ . An isomorphism between two  $G$ -equivariant extensions  $\mathcal{A} \subset \mathcal{B}_1$  and  $\mathcal{A} \subset \mathcal{B}_2$  is a unitary  $u$  between the Hilbert spaces  $H_{\mathcal{B}_1}$  and  $H_{\mathcal{B}_2}$  on which  $\mathcal{B}_1$  and  $\mathcal{B}_2$  act respectively such that  $u$  is an isomorphism of standard extensions (i.e.  $u$  commutes with  $\mathcal{A}_{\infty} := \bigcup_{I \subset \mathbb{R}} \mathcal{A}(I)$ ,  $u\mathcal{B}_1(I)u^* = \mathcal{B}_2(I)$  for any interval  $I$  and  $u\Omega_{\mathcal{B}_1} = \Omega_{\mathcal{B}_2}$ ) and  $\text{Ad } u \circ \pi_{\mathcal{B}_1} = \pi_{\mathcal{B}_2}$ . Note that  $\text{Ad } u \circ E_I^{\mathcal{B}_1} = E_I^{\mathcal{B}_2} \circ \text{Ad } u$  automatically for any interval  $I$  as above.

We claim that a finite index  $G$ -equivariant standard extension  $\mathcal{A} \subset \mathcal{B}$  corresponds to a  $G$ -equivariant Q-system in  $\text{Rep } \mathcal{A}$  up to isomorphisms (see also a result [BJLP19, Proposition 6.3] for finite group actions on completely rational conformal nets. Note that our proof does not need either the locality of  $\mathcal{B}$  or the finiteness of  $G$ , see Remark 2.17 below).

Suppose a finite index  $G$ -equivariant standard extension  $\mathcal{A} \subset \mathcal{B}$  is given. Then, a corresponding Q-system  $\theta$  is localized in some interval  $I$  and can be restricted to a dual canonical endomorphism of  $\mathcal{A}(J) \subset \mathcal{B}(J)$  for any interval  $J$  including  $I$ . We can give  $z_g \in \text{Hom}_{\text{End}(\mathcal{A}(I))}({}^g\theta|_{\mathcal{A}(I)}, \theta|_{\mathcal{A}(I)})$  for every  $g \in G$  by applying an argument in [Noj20, Lemma 2.8] for the inclusion  $\mathcal{A}(I) \subset \mathcal{B}(I)$ , which is what we want since the argument for  $\mathcal{A}(J) \subset \mathcal{B}(J)$  gives the same morphism  $z_g$  and therefore  $z_g \in \text{Hom}_{\text{End } \mathcal{A}_{\infty}}({}^g\theta, \theta)$ . If we change  $\theta$  for an isomorphic one, then we only get isomorphic  $G$ -equivariant Q-system by [Noj20, Lemma 2.8]. If we change  $\mathcal{B}$  for an isomorphic  $\tilde{\mathcal{B}}$  with a unitary  $u$ , then  $U := \text{Ad } u \circ - \circ \text{Ad } u^*$  is a strict 2-functor between the 2-categories of morphisms of  $\mathcal{A}(I) \subset \mathcal{B}(I)$  and  $\mathcal{A}(I) \subset \tilde{\mathcal{B}}(I)$ , see e.g. [Müg03, Section 1.3] for the 2-category of morphisms. Since  $u$  and therefore  $U$  intertwine group actions,  $U(\theta) = \theta$ , which follows since  $u$  commutes with  $\mathcal{A}_{\infty}$ , is a  $G$ -equivariant Q-system corresponding to  $\tilde{\mathcal{B}}$ . Thus, changing  $\mathcal{B}$  does not affect the resulting  $G$ -equivariant Q-systems.

Conversely, suppose we are given a  $G$ -equivariant Q-system  $(\theta, w, x, z)$  in  $\text{Rep } \mathcal{A}$  that is localized in  $I$ . Then,  $w, x, z_g \in \mathcal{A}(I)$  by the Haag duality on  $\mathbb{R}$  of  $\mathcal{A}$ , and we can construct a finite index standard extension  $\iota : \mathcal{A} \subset \mathcal{B}$  on the GNS Hilbert space  $L^2(\mathcal{B}(I))$  of  $\mathcal{B}(I)$  associated with the vacuum state, see the proof of [LR95, Theorem 4.9]. By [Noj20, Lemma 2.10], we have an extension  $\pi_I^{\mathcal{B}} : G \rightarrow \text{Aut}(\mathcal{B}(I))$  of an action  $\text{Ad } \pi_{\mathcal{A}}|_{\mathcal{A}(I)} : G \rightarrow \text{Aut}(\mathcal{A}(I))$ . Then, for every  $g \in G$ , define a linear operator  $\pi_{\mathcal{B}}(g)$  on  $L^2(\mathcal{B}(I))$  by putting  $\pi_{\mathcal{B}}(g)[b] := [\pi_I^{\mathcal{B}}(g)(b)]$  for  $[b] \in \mathcal{B}(I) \subset L^2(\mathcal{B}(I))$ , which satisfies  ${}^g b := \pi_I^{\mathcal{B}}(g)(b) = \pi_{\mathcal{B}}(g)b\pi_{\mathcal{B}}(g)^{-1}$  for  $b \in \mathcal{B}(I)$ , in particular  ${}^g a = \pi_{\mathcal{B}}(g)a\pi_{\mathcal{B}}(g)^{-1} = \text{Ad } \pi_{\mathcal{A}}(g)(a)$  for  $a \in \mathcal{A}(I)$ , by definition. We show that  $\pi_{\mathcal{B}}(g) \in \text{Aut}(\mathcal{B})$  and therefore  $\pi_{\mathcal{B}}$  is an extension of  $\pi$ . First,  $\pi_{\mathcal{B}}(g)$  is unitary. Indeed,  $\text{Ad } \pi_{\mathcal{B}}(g) \circ E_I^{\mathcal{B}} = E_I^{\mathcal{B}} \circ \text{Ad } \pi_{\mathcal{B}}(g)$  as above since  $\pi_{\mathcal{B}}(g)$  fixes the vacuum and commutes with the Jones projection  $e_{\mathcal{A}}$  by definition. Next, we check that  $\text{Ad } \pi_{\mathcal{B}}(g)(\mathcal{B}(J)) \subset \mathcal{B}(J)$  for an arbitrary interval  $J$ . For this, we show  $\text{Ad } \pi_{\mathcal{B}}(g)(\tilde{a}) = \text{Ad } \pi_{\mathcal{A}}(g)(\tilde{a})$  for  $\tilde{a} \in \mathcal{A}_{\infty}$ . Let  $K$  be an interval containing  $\tilde{a}$ . By construction, we have an element  $v \in \mathcal{B}(I)$  with  $L^2(\mathcal{B}(I)) = v^*L^2(\mathcal{A}(I))$  as a representation of  $\mathcal{A}(K)$ , see the proof of [LR95, Theorem 4.9]. We also have  ${}^g v = z_g^*v$  by [Noj20, Lemma 2.8]. Since  $\pi_{\mathcal{B}}(g)|_{L^2(\mathcal{A}(I))} = \pi_{\mathcal{A}}(g)$  under the identification

$L^2(\mathcal{A}(I)) \cong H_{\mathcal{A}}$  as cyclic representations of  $\mathcal{A}(I)$ , we have

$$\begin{aligned} \pi_{\mathcal{B}}(g)\tilde{a}\pi_{\mathcal{B}}(g)^{-1}v^*[a] &= \pi_{\mathcal{B}}(g)\tilde{a}g^{-1}v^*[g^{-1}a] = \pi_{\mathcal{B}}(g)v^*\theta(\tilde{a})z_{g^{-1}}[g^{-1}a] = {}^g(v)^*\pi_{\mathcal{A}}(g)\theta(\tilde{a})z_{g^{-1}}[g^{-1}a] \\ &= v^*z_g({}^g\theta)(\text{Ad}\pi_{\mathcal{A}}(g)(\tilde{a}))\pi_{\mathcal{A}}(g)z_{g^{-1}}[g^{-1}a] \\ &= v^*\theta(\text{Ad}\pi_{\mathcal{A}}(g)(\tilde{a}))z_g\text{Ad}\pi_{\mathcal{A}}(g)(z_{g^{-1}})[a] = v^*\theta(\text{Ad}\pi_{\mathcal{A}}(g)(\tilde{a}))[a] \\ &= \text{Ad}\pi_{\mathcal{A}}(g)(\tilde{a})v^*[a] \end{aligned}$$

for every  $a \in \mathcal{A}(I)$  and therefore  ${}^g\tilde{a} := \text{Ad}\pi_{\mathcal{B}}(g)(\tilde{a}) = \text{Ad}\pi_{\mathcal{A}}(g)(\tilde{a})$ . Note that we used  $z_e = {}^e z_e = \text{id}_{\theta}$ . Hence in particular  ${}^g\mathcal{A}(J) \subset \mathcal{A}(J)$ . Then, recall that we have a Q-system isomorphism  $u : \theta \cong \tilde{\theta}$ , where  $\tilde{\theta}$  is localized in  $J$ , with  $\mathcal{B}(J) = \mathcal{A}(J)uv$  by construction. We can make  $u$  into a  $G$ -equivariant Q-system isomorphism by putting  $z_g^{\tilde{\theta}} := uz_g{}^g u^*$ . Then,  $z_g^{\tilde{\theta}} \in \mathcal{A}(J)$  by Haag duality and therefore

$${}^g\mathcal{B}(J) = {}^g(\mathcal{A}(J)){}^g(u){}^g v \subset \mathcal{A}(J){}^g(u)z_g^*v = \mathcal{A}(J){}^g(u)z_g^*v = \mathcal{A}(J)(z_g^{\tilde{\theta}})^*uv = \mathcal{A}(J)uv = \mathcal{B}(J).$$

Thus  $\pi_{\mathcal{B}}$  is an extension of  $\pi_{\mathcal{A}}$ . If we change  $\theta$  for an isomorphic  $\tilde{\theta}$  localized in an interval  $J$  with a unitary  $u$  then we construct  $\mathcal{A} \subset \tilde{\mathcal{B}}$  on  $L^2(\tilde{\mathcal{B}}(J))$ . We have the counterpart  $\tilde{v} \in \tilde{\mathcal{B}}(J)$  of  $v$  and  $U : L^2(\mathcal{B}(J)) \rightarrow L^2(\tilde{\mathcal{B}}(J)); [a\tilde{v}] \mapsto au[v]$  ( $a \in \mathcal{A}(J)$ ) defines an isomorphism of standard extensions, see the proof of [LR95, Theorem 4.9]. Moreover,  $U$  intertwines group actions and therefore is an isomorphism of  $G$ -equivariant standard extensions since

$$\begin{aligned} U^*\pi_{\mathcal{B}}(g)U[a\tilde{v}] &= U^*\pi_{\mathcal{B}}(g)au[v] = {}^g(au)U^*[{}^g v] = {}^g(au)z_g^*U^*[v] = {}^g(a)(z_g^{\tilde{\theta}})^*U^*u[v] = [{}^g(a)(z_g^{\tilde{\theta}})^*\tilde{v}] \\ &= \pi_{\tilde{\mathcal{B}}}(g)[a\tilde{v}] \end{aligned}$$

for any  $g \in G$  and  $a \in \mathcal{A}(J)$ . Thus, changing  $\theta$  only yields an isomorphic  $G$ -equivariant extension. Note that in particular, we can harmlessly replace an interval in which a given  $G$ -equivariant Q-system is localized by another (say larger) one. It is easy to see that our constructions are mutually inverse.

**Remark 2.17.** 1. When  $\mathcal{B}$  is the restriction of a local Möbius covariant net with strong additivity, the local algebras on  $S^1$  are generated by the local algebras on  $\mathbb{R}$  and therefore  $\text{Aut}(\mathcal{B})$  defined above coincides with that of a local Möbius covariant net.

2. We consider not only local extensions but also *nonlocal* extensions i.e.  $\mathcal{B}$  is not necessarily a local Möbius covariant net in the example above, which is crucial for the theory of  $\alpha$ -induction, see [BEK00, Section 5].

3. In the example above, the action  $\pi_{\mathcal{A}}$  does not need to be faithful i.e.  $\pi_{\mathcal{A}}$  can have a nontrivial kernel. We encounter such a situation e.g. when  $\mathcal{A} = \mathcal{B}^G$  for a Möbius covariant net  $\mathcal{B}$ .

We collect here some graphical calculi for equivariant algebras. We follow the graphical notations for algebras and Frobenius algebras in [FFRS06, Equation 2.22]. Namely, the product and unit of an algebra are represented respectively by a fork and a small circle.

Let  $A$  be a  $G$ -equivariant algebra. Then, it is graphically represented in Figure 19 that  $z_g^A$  is an algebra homomorphism for  $g \in G$ . The first equality in Figure 19 is often used in the form of Figure 20. When  $A$  is moreover a  $G$ -equivariant Frobenius algebra, we have similar representations of the coassociativity and counit property of  $A$ . It is often used in the form of Figure 21 that  $z^A$  is a  $G$ -equivariant structure. In particular, by putting  $h = g^{-1}$ , we obtain Figure 22 since  $z_g^A z_{g^{-1}}^A = z_e^A = \text{id}_A$ .

Finally, note that when  $A$  is an algebra in a  $G$ -braided multitensor category, we can move the algebra structures through crossings as in Figure 23 by the definition of  $\lambda A$ .

### 3 Equivariant $\alpha$ -induction

The  $\alpha$ -induction for twisted representations of Möbius covariant nets (see Example 2.12) was introduced by Nojima in [Noj20]. In this section, we reformulate this notion in terms of tensor categories (Definition 3.9 and Remark 3.7), which is an equivariant generalization of Ostrik's work [Ost03, Section 5.1], see also [BKLR15, Section 4.6]. For this, we begin with crossed structures on bimodule categories.

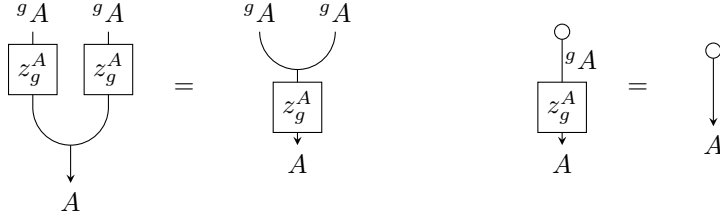

Figure 19:  $z_g^A$  is an algebra homomorphism

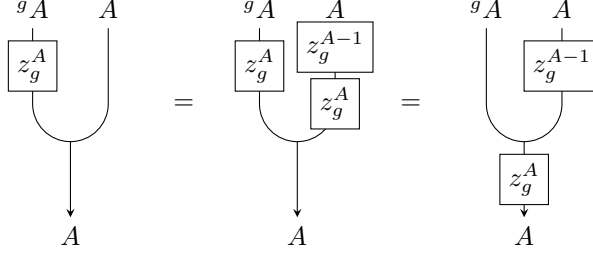

Figure 20: A useful calculus for equivariant algebras

### 3.1 Group actions on the bicategories of equivariant Frobenius algebras

In this subsection, we induce a group action on the bicategory of equivariant Frobenius algebras from that on the ambient multitensor category (Proposition 3.1). We also see that this indeed makes bimodule categories  $G$ -crossed (Proposition 3.5).

It is known [Yam04, Sections 4 and 5] that the special Frobenius algebras in a multitensor category  $\mathcal{C}$  form a rigid bicategory, whose 1-cells are bimodules as in ordinary ring theory. Note that this bicategory is defined only up to equivalences since we have to fix relative tensor products of bimodules to obtain a composition of 1-cells. In particular, for a special Frobenius algebra  $A$  in  $\mathcal{C}$ , the category  $\text{Bimod}_{\mathcal{C}}(A)$  of  $A$ -bimodules in  $\mathcal{C}$  is a multitensor category. A special Frobenius algebra  $A$  is called *simple* if  $\text{Bimod}_{\mathcal{C}}(A)$  is moreover a tensor category i.e.  $\text{End}_{\text{Bimod}_{\mathcal{C}}(A)}(A)$  is one-dimensional, see [FFRS06, Definition 2.26].

Let  $\mathcal{C}$  be a multitensor category with an action of  $G$  and let  $A$  and  $B$  be algebras in  $\mathcal{C}$ . For an  $A$ - $B$ -bimodule  $\lambda = (\lambda, m_{\lambda}^L, m_{\lambda}^R)$  in  $\mathcal{C}$ ,  ${}^g\lambda = ({}^g\lambda, {}^g m_{\lambda}^L, {}^g m_{\lambda}^R)$  is an  ${}^gA$ - ${}^gB$ -bimodule. Note that we can move module products through crossings as in Figure 24 for  $\lambda \in \text{Homog}(\mathcal{C})$  and an  $A$ - $B$ -bimodule  $\mu$  by this definition. We modify this procedure to obtain an action that restricts to the multitensor categories of bimodules.

**Proposition 3.1.** Let  $\mathcal{C}$  be a multitensor category equipped with an action  $\gamma^{\mathcal{C}}$  of a group  $G$ . Let  $\text{Frob}^G(\mathcal{C})$  denote the bicategory of the special  $G$ -equivariant Frobenius algebras in  $\mathcal{C}$ . Then, for a 1-cell  $\lambda = (\lambda, m_{\lambda}^L, m_{\lambda}^R) : A \rightarrow B$  in  $\text{Frob}^G(\mathcal{C})$  and  $g \in G$ , we can give a 1-cell  ${}^g\lambda := ({}^g\lambda, {}^g m_{\lambda}^L \circ (z_g^{A-1} \otimes \text{id}_{\lambda}), {}^g m_{\lambda}^R (\text{id}_{g\lambda} \otimes z_g^{B-1})) : A \rightarrow B$ . This assignment naturally defines an action

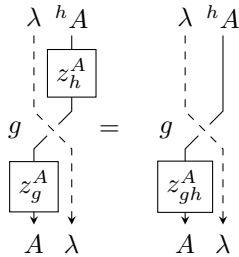

Figure 21:  $z^A$  is a  $G$ -equivariant structure

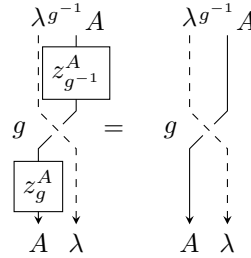

Figure 22:  $z_g^A z_{g^{-1}}^A = \text{id}_A$



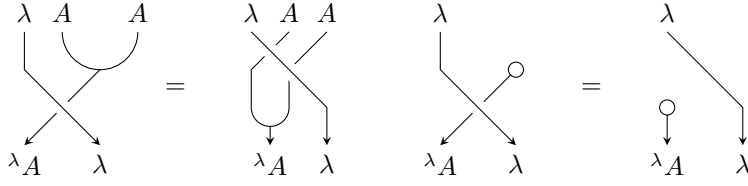

Figure 23: Algebra structures and crossings

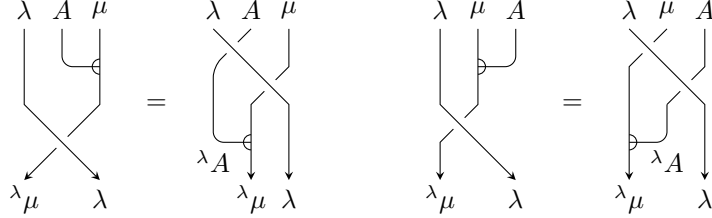

Figure 24: Module products and crossings

of  $G$  on  $\text{Frob}^G(\mathcal{C})$ . Another choice of relative tensor products only yields a  $G$ -biequivalent action.

*Proof.* The assignment  $\gamma(g) : \lambda \mapsto {}^g\lambda$  defined above is well-defined since the graphical calculations in Figures 25 and 26, where  $z := z^B$  and small half circles denote module products as in [BKLR15, Section 3.6], shows that  ${}^g\lambda$  is indeed a left  $B$ -module, and the proof for right  $A$ -modularity is similar. We regard  $\gamma(g)$  as a family of functors by putting  $\gamma(g)(f) := \gamma^{\mathcal{C}}(g)(f)$  for a 2-cell  $f$ .

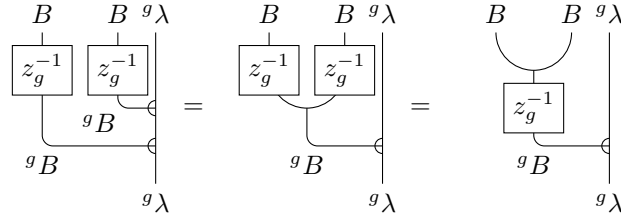

Figure 25: The left associativity of  ${}^g\lambda$

We make  $\gamma(g)$  into a pseudofunctor. For 1-cells  $\lambda : A \rightarrow B$  and  $\mu : B \rightarrow C$ , let  $(\mu \otimes_B \lambda, s_{\mu,\lambda}, r_{\mu,\lambda})$  denote a retract of  $\mu \otimes_C \lambda$  with the idempotent  $e_{\mu,\lambda} := s_{\mu,\lambda} \circ r_{\mu,\lambda}$ . Note that  $s_{\mu,\lambda}$  and  $r_{\mu,\lambda}$  are natural in  $\mu$  and  $\lambda$  by the definition of the bifunctor  $\otimes_B$ . By the graphical calculation in Figure 27, we have  $e_{s_{\mu,\lambda}, {}^g\lambda} = {}^g e_{\mu,\lambda}$  and therefore a unique subobject isomorphism  $J_{\mu,\lambda}^{\gamma(g)} := {}^g(r_{\mu,\lambda}) \circ s_{s_{\mu,\lambda}, {}^g\lambda} : {}^g\mu \otimes_B {}^g\lambda \cong {}^g(\mu \otimes_B \lambda)$ . We can show that the bicategory version of [EGNO15, Diagram 2.23] commutes by  $e_{s_{\mu,\lambda}, {}^g\lambda} = {}^g e_{\mu,\lambda}$  and the naturality of  $s$  and  $r$ . We also put  $\varphi_A^{\gamma(g)} := (z_g^A)^{-1}$  for  $A \in \text{Obj}(\text{Frob}^G(\mathcal{C}))$ , which is an  $A$ -bimodule morphism since  $z_g^A$  is an algebra homomorphism. Then, by the definition of the left and right unit isomorphisms of  $\text{Frob}^G(\mathcal{C})$ , the commutativity of the bicategory versions of [EGNO15, Diagrams 2.25 and 2.26] follows from the definition of  $\gamma$  and the naturality of  $s$ . Thus,  $(\gamma(g), J^{\gamma(g)}, \varphi^{\gamma(g)})$  is a pseudofunctor.

Since  $z_{gh} = z_g^g z_h$ , we have a canonical invertible 2-cell  $(\chi_{g,h}^\gamma)_\lambda : {}^g(h\lambda) \cong {}^{gh}\lambda$  by the coherence in  $\mathcal{C}$ , which gives a pseudonatural equivalence  $\chi_{g,h}^\gamma : \gamma(g)\gamma(h) \simeq \gamma(gh)$  with  $\chi_{g,h}^{\gamma,0} := \mathbf{1}$ . Similarly,  $z_e = \text{id}_B$  gives a pseudonatural equivalence  $\iota^\gamma : \text{id} \simeq \gamma(e)$  with  $\iota^{\gamma,0} = \mathbf{1}$ . We can define all the remaining modifications to be canonical invertible 2-cells, and then  $\gamma$  is an action of  $G$  by coherence. Another choice of relative tensor products only yields a  $G$ -biequivalent action since we get the same  $\chi^\gamma$  and  $\iota^\gamma$ .  $\square$

**Example 3.2.** It is known [BKLR15, Proposition 3.33] that for a type III factor  $N$ , there is a biequivalence between the bicategory of the Q-systems in  $\text{End}_0(N)$  and the 2-category of the finite

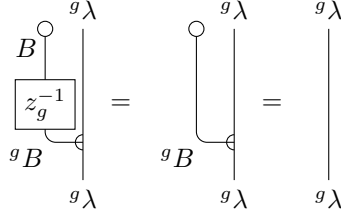

Figure 26: The left unit property of  ${}^g\lambda$

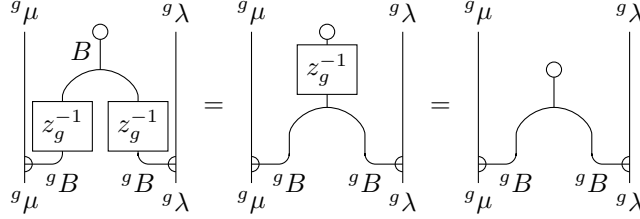

Figure 27:  $e_{g\mu, g\lambda} = e_{\mu, \lambda}$

index extensions of  $N$  whose 1-cells from  $M_1$  to  $M_2$  are the subobjects of  $\iota_2\lambda\bar{\iota}_1$  for  $\lambda \in \text{End}_0(N)$ , where  $\iota_i : N \subset M_i$  for  $i = 1, 2$ . When a group  $G$  acts on  $N$ , in the same way, we have a biequivalence between the bicategory  $\text{Q}^G(\text{End}_0(N))$  of the  $G$ -equivariant Q-systems in  $\text{End}_0(N)$  and the 2-category  $\text{Ext}^G(N)$  of the finite index extensions of  $N$  with  $G$ -actions whose 1-cells are as above. We claim that this biequivalence can be made into a  $G$ -biequivalence, where  $G$  acts on  $\text{Q}^G(\text{End}_0(N))$  by Proposition 3.1 and on  $\text{Ext}^G(N)$  by the adjoint action.

First, note that if a 1-cell  $\lambda$  of  $\text{Q}^G(\text{End}_0(N))$  is standard (see [BKLR15, Section 3.6]), then  ${}^g\lambda$  is again standard for  $g \in G$ . Therefore, the  $G$ -action on  $\text{Q}^G(\text{End}_0(N))$  restricts to the sub-bicategory  $\text{Q}_{\text{st}}^G(\text{End}_0(N))$  whose 1-cells are standard bimodules, and we have a  $G$ -biequivalence  $\text{Q}_{\text{st}}^G(\text{End}_0(N)) \simeq \text{Q}^G(\text{End}_0(N))$  by [BKLR15, Proposition 3.32(i)].

Then, let  $F : \text{Ext}^G(N) \rightarrow \text{Q}_{\text{st}}^G(\text{End}_0(N))$  denote the biequivalence defined by putting  $F(\varphi) := \bar{\iota}_1\varphi\iota_2$  for  $\varphi \in \text{Hom}_{\text{Ext}^G(N)}(M_2, M_1)$ , see [BKLR15, Propositions 3.33 and 3.38]. It is enough to make  $F$  into a  $G$ -biequivalence. For this, note that for  $M \in \text{Obj}(\text{Ext}^G(N))$ , we have  $z_g^{F(M)} \in \text{Hom}(g\bar{\iota}, \bar{\iota})$  for  $g \in G$ , where  $\iota : N \subset M$ , since

$$\begin{aligned} z_g(g\bar{\iota})(nv) &= z_g(g\theta)(n)^g(\theta(z_{g-1}^*x)) = z_g(g\theta)(n)(g\theta)(z_g)^g x = \theta(n)z_g(g\theta)(z_g)^g x = \theta(n)xz_g \\ &= \bar{\iota}(nv)z_g \end{aligned}$$

for  $n \in N$  and  $v := \text{coev}_{\bar{\iota}}$ , where  $\theta := F(M) = \bar{\iota}u$ ,  $x := \bar{\iota}(v)$  and  $z := z^\theta$ . Then, put  $(\tilde{\eta}_g^F)_\varphi := z_g^{F(M_1)^*} \otimes \text{id}_{\varphi\iota_2} : \bar{\iota}_1^g\varphi\iota_2 \cong g(\bar{\iota}_1\varphi\iota_2)$  for  $\varphi \in \text{Hom}_{\text{Ext}^G(N)}(M_2, M_1)$  and  $g \in G$ , which is a bimodule isomorphism since  ${}^g v^* = v^*z_g$ . Since  $s_{F(\varphi), F(\psi)} = \text{id}_{\bar{\iota}_1\varphi} \otimes v_2 \otimes \text{id}_{\psi\iota_3}$  and  $r_{gF(\varphi), gF(\psi)} = \text{id}_{g\bar{\iota}_1^g\varphi} \otimes {}^g v_2^* \otimes \text{id}_{g\psi\iota_3}$  for  $\psi \in \text{Hom}_{\text{Ext}^G(N)}(M_3, M_2)$  and  $g \in G$ , where  $v_2 := \text{coev}_{\bar{\iota}_2}$ , when we take  $F(\varphi) \otimes_{F(M_2)} F(\psi) = F(\varphi\psi)$  by Figure 27 and the proof of [BKLR15, Proposition 3.38], we obtain  $(\tilde{\eta}_g^F)_\varphi\psi = (\tilde{\eta}_g^F)_\varphi \otimes_{F(M_2)} (\tilde{\eta}_g^F)_\psi$  from  ${}^g v^* = v^*z_g$ . Therefore, by putting  $\tilde{\eta}_g^{F,0} := \mathbf{1}$ , we get a pseudonatural equivalence  $\tilde{\eta}_g^F : F\gamma^{\text{Ext}^G(N)}(g) \simeq \gamma^{\text{Q}_{\text{st}}^G(\text{End}_0(N))}(g)F$ . Since  $(\tilde{\eta}_{gh}^F)_\varphi = g(\tilde{\eta}_h^F)_\varphi(\tilde{\eta}_g^F)_{h\varphi}$  by  $z_{gh} = z_g^g z_h$ , we can make  $(F, \tilde{\eta}^F)$  into a  $G$ -biequivalence by coherence.

By definition, the restriction of the action defined in Proposition 3.1 to  $\mathcal{C}$  coincides with  $\gamma^{\mathcal{C}}$ , and that to  $\text{Bimod}_{\mathcal{C}}(A)$  for  $A \in \text{Obj}(\text{Frob}^G(\mathcal{C}))$  is an action on a multitensor category. We show that  $\text{Bimod}_{\mathcal{C}}(A)$  is indeed  $G$ -crossed.

**Proposition 3.3.** Let  $A$  be a symmetric special Frobenius algebra in a pivotal multitensor category  $\mathcal{C}$ . Then,  $\text{Bimod}_{\mathcal{C}}(A)$  is again pivotal. Another choice of relative tensor products only yields an isomorphic pivotal structure. If  $\mathcal{C}$  is moreover a tensor category and  $A$  is simple, then  $\text{Tr}^L(\delta_\lambda^{\text{Bimod}_{\mathcal{C}}(A)} f) = \text{Tr}^L(\delta_\lambda^{\mathcal{C}} f) / \dim_{\delta_{\mathcal{C}}}(A)$  and  $\text{Tr}^R(f\delta_\lambda^{\text{Bimod}_{\mathcal{C}}(A)^{-1}}) = \text{Tr}^R(f\delta_\lambda^{\mathcal{C}^{-1}}) / \dim_{\delta_{\mathcal{C}}}(A)$  for  $f \in$

$\text{End}_{\text{Bimod}_{\mathcal{C}}(A)}(\lambda)$ . In particular,  $\dim_{\delta^{\text{Bimod}_{\mathcal{C}}(A)}}(\lambda) = \dim_{\delta^{\mathcal{C}}}(\lambda) / \dim_{\delta^{\mathcal{C}}}(A)$  for  $\lambda \in \text{Obj}(\text{Bimod}_{\mathcal{C}}(A))$ , and if  $\mathcal{C}$  is spherical, then  $\text{Bimod}_{\mathcal{C}}(A)$  is again spherical. If a group  $G$  acts pivotally on  $\mathcal{C}$  and  $A \in \text{Obj}(\text{Frob}^G(\mathcal{C}))$ , then the induced action of  $G$  on  $\text{Bimod}_{\mathcal{C}}(A)$  is again pivotal.

*Proof.* Let  $\lambda \in \text{Obj}(\text{Bimod}_{\mathcal{C}}(A))$  and let  $m_\lambda$  denote either the left or right module product of  $\lambda$ . By the proof of the rigidity of  $\text{Bimod}_{\mathcal{C}}(A)$  in [Yam04, Section 5], we have  $m_{\lambda^{\vee\vee}} = (m_\lambda)^{\vee\vee}$  in  $\mathcal{C}$  when  $A^\vee$  is taken to be  $A$ . Therefore,  $\delta_\lambda^{\mathcal{C}}$  is an  $A$ -bimodule morphism by the naturality and monoidality of  $\delta^{\mathcal{C}}$  if  $\delta_A^{\mathcal{C}} = \text{id}_A$ . Let us put  $\delta_\lambda^{\text{Bimod}_{\mathcal{C}}(A)} := \delta_\lambda^{\mathcal{C}}$ , which is natural in  $\lambda$  by definition. The monoidality of  $\delta^{\text{Bimod}_{\mathcal{C}}(A)}$  follows from the naturality and monoidality of  $\delta^{\mathcal{C}}$ . Thus,  $\delta^{\text{Bimod}_{\mathcal{C}}(A)}$  is a pivotal structure on  $\text{Bimod}_{\mathcal{C}}(A)$ . Another choice of relative tensor products only yields an isomorphic pivotal structure since an equivalence from the new bimodule category to the original one is defined to be an identity as a functor.

Now, suppose  $\mathcal{C}$  is a tensor category and  $A$  is simple. By the proof of rigidity [Yam04, Section 5], evaluation and coevaluation maps of  $\lambda \in \text{Obj}(\text{Bimod}_{\mathcal{C}}(A))$  are respectively given in Figures 28 and 29 as morphisms in  $\mathcal{C}$ . Then, we find that  $e_{\lambda, \lambda^\vee}$  in  $\text{Tr}^{\text{L}}(\delta_\lambda^{\text{Bimod}_{\mathcal{C}}(A)} f)$  cancels for  $f \in \text{End}_{\text{Bimod}_{\mathcal{C}}(A)}(\lambda)$  by the definition of the left module product of  $\lambda^\vee$ , see [Yam04, Section 5]. Therefore, we have

$$\begin{aligned} \text{Tr}^{\text{L}}(\delta_\lambda^{\text{Bimod}_{\mathcal{C}}(A)} f) &= (\varepsilon_A \eta_A)^{-1} \varepsilon_A \text{Tr}^{\text{L}}(\delta_\lambda^{\text{Bimod}_{\mathcal{C}}(A)} f) \eta_A \\ &= \dim_{\delta^{\mathcal{C}}}(A)^{-1} \varepsilon_A \text{ev}_{\lambda^\vee}^{\text{Bimod}_{\mathcal{C}}(A)} \delta_\lambda^{\text{Bimod}_{\mathcal{C}}(A)} f \text{coev}_\lambda^{\text{Bimod}_{\mathcal{C}}(A)} \eta_A \\ &= \dim_{\delta^{\mathcal{C}}}(A)^{-1} \text{ev}_{\lambda^\vee}^{\mathcal{C}} \delta_\lambda^{\mathcal{C}} f \text{coev}_\lambda^{\mathcal{C}} = \dim_{\delta^{\mathcal{C}}}(A)^{-1} \text{Tr}^{\text{L}}(\delta^{\mathcal{C}} f). \end{aligned}$$

The proof for  $\text{Tr}^{\text{R}}$  is similar. Finally, the last statement follows since the group action on the morphisms of  $\text{Bimod}_{\mathcal{C}}(A)$  coincides with that of  $\mathcal{C}$ .  $\square$

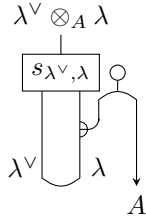

Figure 28: Evaluation in  $\text{Bimod}_{\mathcal{C}}(A)$

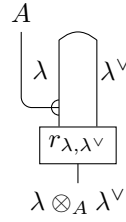

Figure 29: Coevaluation in  $\text{Bimod}_{\mathcal{C}}(A)$

**Remark 3.4.** When  $A$  is moreover swap-commutative in the sense of [FS03, Definition 5.5], each left  $A$ -module can be regarded as an  $A$ -bimodule, and the left  $A$ -modules in  $\mathcal{C}$  form a multitensor subcategory of  $\text{Bimod}_{\mathcal{C}}(A)$ . Thus, the multitensor category of the left  $A$ -modules in  $\mathcal{C}$  inherits the pivotal structure of  $\text{Bimod}_{\mathcal{C}}(A)$ , and Proposition 3.3 reproduces [FS03, Proposition 5.18 and Lemma 5.19] as its corollaries.

**Proposition 3.5.** Let  $\mathcal{C}$  be a  $G$ -crossed multitensor category and let  $A \in \text{Obj}(\text{Frob}^G(\mathcal{C}))$  be symmetric neutral. Then, we can define a  $G$ -grading on  $\text{Bimod}_{\mathcal{C}}(A)$  by putting  $\text{Obj}(\text{Bimod}_{\mathcal{C}}(A)_g) := \{\mu \in \text{Obj}(\text{Bimod}_{\mathcal{C}}(A)) \mid F(\mu) \in \text{Obj}(\mathcal{C}_g)\}$  for  $g \in G$ , where  $F$  denotes the forgetful functor  $\text{Bimod}_{\mathcal{C}}(A) \rightarrow \mathcal{C}$ . Combined with the action defined in Proposition 3.1,  $\text{Bimod}_{\mathcal{C}}(A)$  becomes a  $G$ -crossed multitensor category. Another choice of relative tensor products only yields an isomorphic  $G$ -crossed structure.

*Proof.* By Propositions 3.1 and 3.3, the category  $\text{Bimod}_{\mathcal{C}}(A)$  is equipped with a pivotal  $G$ -action. By the definition of the  $G$ -grading, the homogeneous decomposition in  $\mathcal{C}$  gives that in  $\text{Bimod}_{\mathcal{C}}(A)$ . For  $\lambda \in \text{Obj}(\text{Bimod}_{\mathcal{C}}(A)_g)$  and  $\mu \in \text{Obj}(\text{Bimod}_{\mathcal{C}}(A)_h)$ , since  $A$  is neutral,  $\lambda \otimes_A \mu$  is the cokernel of a morphism  $\lambda \otimes_{\mathcal{C}} A \otimes_{\mathcal{C}} \mu \rightarrow \lambda \otimes_{\mathcal{C}} \mu$  in  $\mathcal{C}_{gh}$ , and therefore  $\lambda \otimes_A \mu \in \text{Obj}(\mathcal{C}_{gh})$ . Finally,  ${}^k(\text{Obj}(\text{Bimod}_{\mathcal{C}}(A)_g)) \subset \text{Obj}(\text{Bimod}_{\mathcal{C}}(A)_{k g k^{-1}})$  for  $k \in G$  since  $\mathcal{C}$  is  $G$ -crossed. Thus,  $\text{Bimod}_{\mathcal{C}}(A)$  is  $G$ -crossed. Another choice of relative tensor products only yields an isomorphic  $G$ -crossed structure as in the proof of Proposition 3.3.  $\square$

### 3.2 Categorical definition of equivariant $\alpha$ -induction

In this subsection, we define  $G$ -equivariant  $\alpha$ -induction (Definition 3.9).

**Proposition 3.6.** Let  $A$  be a neutral  $G$ -equivariant algebra in a  $G$ -braided multitensor category  $\mathcal{C}$ . Put  $m_{A\lambda}^L := m_A \otimes \text{id}_\lambda \in \text{Hom}(AA\lambda, A\lambda)$  and define  $m_{A\lambda}^{\text{R}\pm} \in \text{Hom}(A\lambda A, A\lambda)$  to be the morphisms given in Figure 30 for every  $\lambda \in \text{Obj}(\mathcal{C})$ . Then  $\alpha_A^{G\pm}(\lambda) := (A\lambda, m_{A\lambda}^L, m_{A\lambda}^{\text{R}\pm})$  are  $A$ -bimodules.

Figure 30: The right module structures of  $\alpha_A^{G\pm}(\lambda)$

*Proof.* We only show the statement for  $\alpha_A^{G+}(\lambda)$  because the proof for  $\alpha_A^{G-}$  is similar.  $m_{A\lambda}^L$  and  $m_{A\lambda}^{\text{R}+}$  are denoted respectively by  $m^L$  and  $m^R$  in this proof. First,  $(A\lambda, m^L)$  are left  $A$ -modules since  $(A, m_A)$  is an algebra. Then, the associativity of  $m^R$  follows from the graphical calculation in Figure 31. Note that we have by definition two dashed crossings labeled by, say,  $g, h \in G$ , but only the components labeled by  $g = h$  survive. Note also that we used Figure 23 at the second equation. The right unit property can also be checked easily by a graphical calculation, and therefore  $(A\lambda, m^R)$  is a right  $A$ -module. Finally, the bimodularity of  $\alpha_A^{G+}(\lambda)$  follows from the associativity of  $m_A$ .  $\square$

Figure 31: The right associativity of  $\alpha_A^{G+}(\lambda)$

**Remark 3.7.** When  $A$  is a neutral  $G$ -equivariant Q-system in a  $G$ -braided  $*$ -multitensor category, the bimodules  $\alpha_A^{G\pm}(\lambda)$  defined above are standard. In particular, when  $A \in \text{Rep } \mathcal{A}$  and is localized in an interval  $I$  for a local Möbius covariant net  $\mathcal{A}$  with Haag duality on  $\mathbb{R}$  and a group  $G$  acting on  $\mathcal{A}$ , for every  $\lambda \in \text{Obj}(G\text{-Rep } \mathcal{A})$  we can regard  $\alpha_A^{G\pm}(\lambda)$  as standard  $A$ -bimodules in  $\text{End } \mathcal{A}(I)$  and therefore they correspond to objects in  $\text{End } \mathcal{B}(I)$ , where  $\mathcal{B}$  is the extension of  $\mathcal{A}$  corresponding to  $A$ , by [BKLR15, Proposition 3.32(ii)] via the formula (3.6.3) in [BKLR15, Section 3.6], which gives the equations (4.7) in [Noj20, Section 4.3]. Thus in this case our definition coincides with what is considered in [Noj20].

We regard  $\alpha_A^{G\pm}$  as functors by putting  $\alpha_A^{G\pm} := \text{id}_A \otimes -$  on morphisms.

**Proposition 3.8.** Let  $A$  be a neutral special symmetric  $G$ -equivariant Frobenius algebra in a  $G$ -braided multitensor category  $\mathcal{C}$ . Then,  $\alpha_A^{G^\pm}$  can be regarded as  $G$ -crossed tensor functors.

*Proof.* We only show the statement for  $\alpha := \alpha_A^{G^+}$ . For  $\lambda, \mu \in \text{Obj}(\mathcal{C})$ , the idempotent  $e_{\alpha(\lambda), \alpha(\mu)}$  is given in Figure 32 by definition. We can split it with the morphisms in Figure 33. Indeed,  $s_{\alpha(\lambda), \alpha(\mu)} \circ r_{\alpha(\lambda), \alpha(\mu)} = e_{\alpha(\lambda), \alpha(\mu)}$  follows from the graphical calculation in Figure 32, and  $r_{\alpha(\lambda), \alpha(\mu)} \circ s_{\alpha(\lambda), \alpha(\mu)} = \text{id}_{A\lambda\mu}$  follows from the graphical calculation in Figure 34. Note that we used Figures 20 and 22. Therefore, there exists a canonical isomorphism  $\alpha(\lambda)\alpha(\mu) \cong A\lambda\mu$  in  $\mathcal{C}$ . Since indeed  $s_{\alpha(\lambda), \alpha(\mu)}$  is  $A$ -bimodular by the graphical calculation in Figure 35, where its left  $A$ -modularity follows from the Frobenius property of  $A$ , we have a canonical isomorphism  $J_{\lambda, \mu}^\alpha : \alpha(\lambda)\alpha(\mu) \cong \alpha(\lambda\mu)$ , which makes  $\alpha$  into a tensor functor as in the proof of Proposition 3.1.

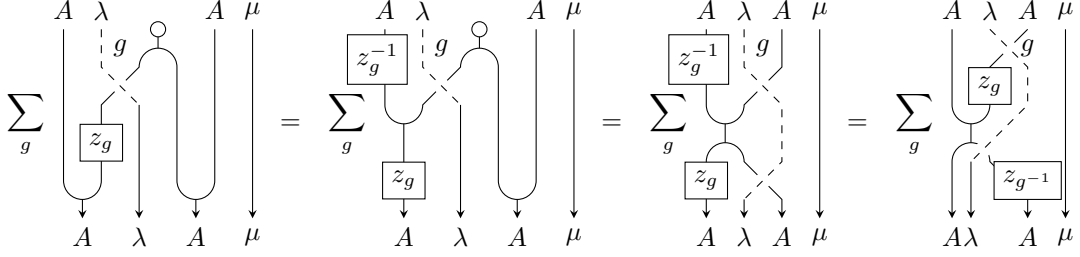

Figure 32: The idempotent  $e_{\alpha(\lambda), \alpha(\mu)}$

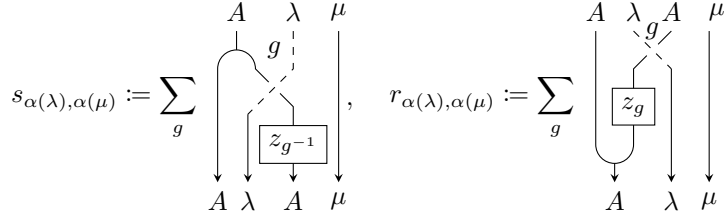

Figure 33: A splitting of  $e_{\alpha(\lambda), \alpha(\mu)}$

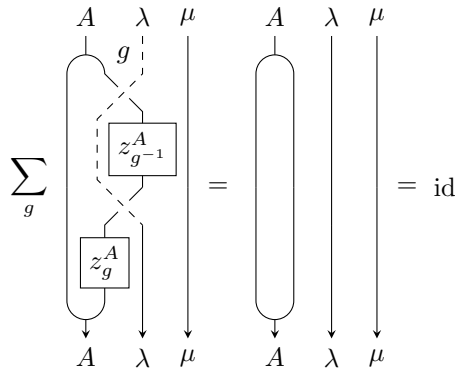

Figure 34:  $r_{\alpha(\lambda), \alpha(\mu)} \circ s_{\alpha(\lambda), \alpha(\mu)} = \text{id}_{A\lambda\mu}$

Put  $(\tilde{\eta}_g^\alpha)_\lambda := z_g \otimes \text{id}_\lambda$  for every  $g \in G$ , which is a left  $A$ -module isomorphism  ${}^g\alpha(\lambda) \cong \alpha({}^g\lambda)$  since  $z_g$  is an algebra homomorphism. It is indeed also right  $A$ -modular by the graphical calculation in Figure 36, where we used  $z_h {}^{hg^{-1}}z_g^{-1} = z_h {}^h z_{g^{-1}} = z_{hg^{-1}}$  for  $g, h \in G$ . The pair  $(\alpha, \tilde{\eta}^\alpha)$  is a tensor  $G$ -functor by  $z_{gh} = z_g {}^g z_h$ . It preserves the gradings since  $A$  is neutral.  $\square$

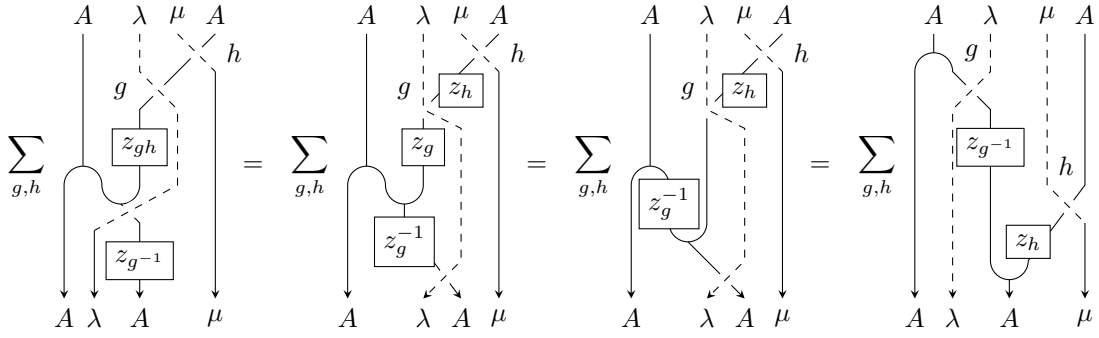

Figure 35: The right  $A$ -modularity of  $s_{\alpha(\lambda), \alpha(\mu)}$

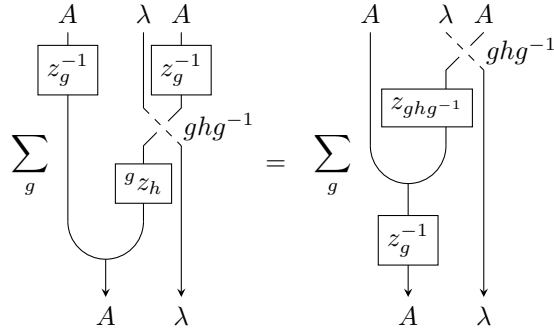

Figure 36: The right  $A$ -modularity of  $(\tilde{\eta}_g^\alpha)_\lambda$

**Definition 3.9.** Let  $A$  be a neutral special  $G$ -equivariant Frobenius algebra in a  $G$ -braided multitensor category  $\mathcal{C}$ . We refer to the  $G$ -crossed tensor functors  $\alpha_A^{G^\pm} : \mathcal{C} \rightarrow \text{Bimod}_{\mathcal{C}}(A)$  as the  $G$ -equivariant  $\alpha$ -induction functors for  $A$ .

## 4 Equivariant $\alpha$ -induction Frobenius algebras

In this section, we construct equivariant  $\alpha$ -induction Frobenius algebras (Theorem 4.14), which generalizes Rehren's work [Reh00] (see also [BKL15, Definition 4.17]) and is one of our main theorems. To give their ambient categories, we introduce the *neutral double* construction (Definition 4.8) for  $G$ -braided multitensor categories.

### 4.1 The neutral double of a $G$ -braided tensor category

In this subsection, we introduce the neutral double construction (Definition 4.8). For this, we begin with crossed products.

**Proposition 4.1.** Let  $G$  be a group. Let  $\mathcal{C}$  be a  $G$ -graded multitensor category and let  $\mathcal{D}$  be a multitensor category with an action  $\gamma^{\mathcal{D}}$  of  $G$ . Then, we can define a bilinear bifunctor  $\otimes : (\mathcal{C} \boxtimes \mathcal{D}) \times (\mathcal{C} \boxtimes \mathcal{D}) \rightarrow \mathcal{C} \boxtimes \mathcal{D}$  by putting  $(c_1 \boxtimes d_1) \otimes (c_2 \boxtimes d_2) := c_1 c_2 \boxtimes {}^{c_2}d_1 d_2$  for  $c_1 \in \text{Obj}(\mathcal{C})$ ,  $c_2 \in \text{Homog}(\mathcal{C})$  and  $d_1, d_2 \in \text{Obj}(\mathcal{D})$  and make  $\mathcal{C} \boxtimes \mathcal{D}$  into a multitensor category, which is denoted by  $\mathcal{C} \times_{\gamma^{\mathcal{D}}} \mathcal{D}$  or simply  $\mathcal{C} \times \mathcal{D}$ . Another choice of the Deligne tensor product  $\mathcal{C} \boxtimes \mathcal{D}$  only yields a strictly isomorphic multitensor category. If  $\mathcal{C}$  and  $\mathcal{D}$  are tensor (resp. multifusion, resp. fusion) categories, then so is  $\mathcal{C} \times \mathcal{D}$ .

*Proof.* Since  $\mathcal{C} \times \mathcal{D} \times \mathcal{C} \times \mathcal{D}$  has a  $G$ -grading  $\bigoplus_{g \in G} \mathcal{C} \times \mathcal{D} \times \mathcal{C}_g \times \mathcal{D}$  and  $\otimes$  is linear exact in each variable (see [EGNO15, Proposition 4.2.1]),  $\otimes$  can be extended to a linear exact functor on

$\mathcal{C} \times \mathcal{D} \times \mathcal{C} \times \mathcal{D}$  and therefore on  $(\mathcal{C} \boxtimes \mathcal{D}) \times (\mathcal{C} \boxtimes \mathcal{D})$ . Since

$$\begin{aligned} ((c_1 \boxtimes d_1) \otimes (c_2 \boxtimes d_2)) \otimes (c_3 \boxtimes d_3) &= c_1 c_2 c_3 \boxtimes \overline{c_3} (\overline{c_2} d_1 d_2) d_3 \\ (c_1 \boxtimes d_1) \otimes ((c_2 \boxtimes d_2) \otimes (c_3 \boxtimes d_3)) &= c_1 c_2 c_3 \boxtimes \overline{c_2 c_3} d_1 \overline{c_3} d_2 d_3 \end{aligned}$$

for  $c_1 \in \text{Obj}(\mathcal{C})$ ,  $c_2, c_3 \in \text{Homog}(\mathcal{C})$  and  $d_1, d_2, d_3 \in \text{Obj}(\mathcal{D})$ , we can define a natural isomorphism  $a : (- \otimes -) \otimes - \cong - \otimes (- \otimes -)$  to be the extension of the canonical isomorphism given by coherence (Theorem 2.6), which satisfies the pentagon axiom by coherence. We put  $\mathbf{1} := \mathbf{1}_{\mathcal{C}} \boxtimes \mathbf{1}_{\mathcal{D}}$  and similarly define left and right unit isomorphisms by coherence. Thus,  $\mathcal{C} \times \mathcal{D}$  turns into a monoidal category. Another choice of  $\mathcal{C} \boxtimes \mathcal{D}$  only yields a strictly isomorphic multitensor category by universality since we define the tensor product by extension.

Next, we show that  $\mathcal{C} \times \mathcal{D}$  is rigid and therefore a multitensor category. As in the proof of [Del90, Proposition 5.17], it is enough to check the rigidity of the objects of  $\mathcal{C}_g \times \mathcal{D}$  for  $g \in G$ . We show that a left dual of  $c \boxtimes d$  for  $c \in \text{Homog}(\mathcal{C})$  and  $d \in \text{Obj}(\mathcal{D})$  is given by  $c^\vee \boxtimes {}^c d^\vee$ . Indeed, since  $(c^\vee \boxtimes {}^c d^\vee)(c \boxtimes d) = c^\vee c \boxtimes d^\vee d$  and  $(c \boxtimes d)(c^\vee \boxtimes {}^c d^\vee) = cc^\vee \boxtimes {}^c (dd^\vee)$ , where we suppressed some isomorphisms by Theorem 2.6, we can define evaluation and coevaluation maps by putting  $\text{ev}_{c \boxtimes d} := \text{ev}_c \boxtimes \text{ev}_d$  and  $\text{coev} := \text{coev}_c \boxtimes {}^c \text{coev}_d$ . The conjugate equations follow from those for  $c$  and  $d$  and therefore  $(c \boxtimes d)^\vee = c^\vee \boxtimes {}^c d^\vee$ . We can also show that  ${}^\vee(c \boxtimes d) = {}^\vee c \boxtimes {}^{c^\vee} d$  and therefore  $\mathcal{C} \times \mathcal{D}$  is rigid.  $\square$

We call  $\mathcal{C} \times \mathcal{D}$  the *crossed product* of  $\mathcal{C}$  and  $\mathcal{D}$ . Let us see that  $\mathcal{C} \times \mathcal{D}$  inherits structures on  $\mathcal{C}$  and  $\mathcal{D}$ .

**Proposition 4.2.** Let  $G$  be a group, let  $\mathcal{C}$  be a  $G$ -graded pivotal multitensor category, and let  $\mathcal{D}$  be a pivotal multitensor category with a pivotal action of  $G$ . Then, the pivotal structures on  $\mathcal{C}$  and  $\mathcal{D}$  induce a pivotal structure  $\delta^{\mathcal{C} \times \mathcal{D}}$  on  $\mathcal{C} \times \mathcal{D}$ . Another choice of  $\mathcal{C} \boxtimes \mathcal{D}$  only yields an isomorphic pivotal structure.

*Proof.* Since  $(c \boxtimes d)^{\vee\vee} = c^{\vee\vee} \boxtimes d^{\vee\vee}$  for  $c \in \text{Obj}(\mathcal{C})$  and  $d \in \text{Obj}(\mathcal{D})$  by the proof of Proposition 4.1, we can define a natural isomorphism  $\delta^{\mathcal{C} \times \mathcal{D}} : \text{id} \cong (-)^{\vee\vee}$  by putting  $\delta_{c \boxtimes d}^{\mathcal{C} \times \mathcal{D}} := \delta_c^{\mathcal{C}} \boxtimes \delta_d^{\mathcal{D}}$ . Since the  $G$ -action on  $\mathcal{D}$  is pivotal, we have

$$\begin{aligned} \delta_{(c_1 \boxtimes d_1) \otimes (c_2 \boxtimes d_2)}^{\mathcal{C} \times \mathcal{D}} &= \delta_{c_1 c_2 \boxtimes \overline{c_2} d_1 d_2}^{\mathcal{C} \times \mathcal{D}} = \delta_{c_1 c_2}^{\mathcal{C}} \boxtimes \delta_{\overline{c_2} d_1 d_2}^{\mathcal{D}} = (\delta_{c_1}^{\mathcal{C}} \otimes \delta_{c_2}^{\mathcal{C}}) \boxtimes (\overline{c_2} \delta_{d_1}^{\mathcal{D}} \otimes \delta_{d_2}^{\mathcal{D}}) \\ &= (\delta_{c_1}^{\mathcal{C}} \boxtimes \delta_{d_1}^{\mathcal{D}}) \otimes (\delta_{c_2}^{\mathcal{C}} \boxtimes \delta_{d_2}^{\mathcal{D}}) = \delta_{c_1 \boxtimes d_1}^{\mathcal{C} \times \mathcal{D}} \otimes \delta_{c_2 \boxtimes d_2}^{\mathcal{C} \times \mathcal{D}} \end{aligned}$$

for  $c_1 \in \text{Obj}(\mathcal{C})$ ,  $c_2 \in \text{Homog}(\mathcal{C})$  and  $d_1, d_2 \in \text{Obj}(\mathcal{D})$  by the monoidality of  $\delta^{\mathcal{C}}$  and  $\delta^{\mathcal{D}}$ . Thus,  $\delta^{\mathcal{C} \times \mathcal{D}}$  is monoidal and therefore a pivotal structure on  $\mathcal{C} \times \mathcal{D}$ . Another choice of  $\mathcal{C} \boxtimes \mathcal{D}$  only yields an isomorphic pivotal structure since we define the pivotal structure by extension.  $\square$

**Remark 4.3.** When  $\mathcal{C}$  and  $\mathcal{D}$  in the proposition above are moreover tensor categories, we have  $\dim_{\delta^{\mathcal{C} \times \mathcal{D}}}(c \boxtimes d) = \dim_{\delta^{\mathcal{C}}}(c) \dim_{\delta^{\mathcal{D}}}(d)$  for  $c \in \text{Obj}(\mathcal{C})$  and  $d \in \text{Obj}(\mathcal{D})$  by definition. In particular, when  $\mathcal{C}$  and  $\mathcal{D}$  are split (i.e.  $\text{End}(\lambda) \cong k$  for any simple object  $\lambda$ , see [EGNO15, Section 4.16]) semisimple spherical tensor categories, since every simple object of  $\mathcal{C} \times \mathcal{D}$  is of the form  $c \boxtimes d$  for some simple objects  $c$  and  $d$  respectively of  $\mathcal{C}$  and  $\mathcal{D}$  by [LF13, Theorem 27], we have  $\dim(\lambda) = \dim(\lambda^\vee)$  for every simple object  $\lambda = c \boxtimes d$  of  $\mathcal{C} \times \mathcal{D}$  by  $(c \boxtimes d)^\vee = c^\vee \boxtimes {}^c d$ , see the proof of Proposition 4.1. Therefore, in this case,  $\mathcal{C} \times \mathcal{D}$  is again a split semisimple spherical tensor category.

**Proposition 4.4.** Let  $\mathcal{C}$  be a  $G$ -crossed multitensor category and let  $\mathcal{D}$  be a multitensor category with an action  $\gamma^{\mathcal{D}}$  of  $G$ . Then, an action of  $G$  is naturally induced on  $\mathcal{C} \times \mathcal{D}$ . Another choice of  $\mathcal{C} \boxtimes \mathcal{D}$  only yields a  $G$ -tensor isomorphic one. When  $\mathcal{D}$  is moreover pivotal and  $\gamma^{\mathcal{C}}$  and  $\gamma^{\mathcal{D}}$  are pivotal actions, the induced action on  $\mathcal{C} \times \mathcal{D}$  is again pivotal.

*Proof.* Define a linear exact functor  $\gamma(g)$  for every  $g \in G$  by putting  $\gamma(g)(c \boxtimes d) := {}^g c \boxtimes {}^g d$  for  $c \in \text{Obj}(\mathcal{C})$  and  $d \in \text{Obj}(\mathcal{D})$ . Since

$$\begin{aligned} \gamma(g)(c_1 \boxtimes d_1) \otimes \gamma(g)(c_2 \boxtimes d_2) &= {}^g c_1 {}^g c_2 \boxtimes {}^{g \overline{c_2} g^{-1}} ({}^g d_1) {}^g d_2 \\ \gamma(g)((c_1 \boxtimes d_1) \otimes (c_2 \boxtimes d_2)) &= {}^g (c_1 c_2) \boxtimes {}^g (\overline{c_2} d_1 d_2) \end{aligned}$$

for  $c_1 \in \text{Obj}(\mathcal{C})$ ,  $c_2 \in \text{Homog}(\mathcal{C})$  and  $d_1, d_2 \in \text{Obj}(\mathcal{D})$  by  $\partial^g c_2 = g \partial c_2 g^{-1}$ , we can define a canonical natural isomorphism  $J^{\gamma(g)}$  by coherence. We similarly have canonical natural isomorphisms  $\chi_{g,h}^\gamma$  for  $g, h \in G$  and  $\iota^\gamma$  by coherence. Thus,  $\gamma$  is an action of  $G$ . Another choice of  $\mathcal{C} \boxtimes \mathcal{D}$  only yields a  $G$ -tensor isomorphic action since we define the action by extension. The last statement follows from the definitions of  $\gamma$  and the pivotal structure  $\delta^{\mathcal{C} \times \mathcal{D}}$ , see the proof of Proposition 4.2.  $\square$

**Proposition 4.5.** Let  $\mathcal{C}$  and  $\mathcal{D}$  be split semisimple  $G$ -crossed multitensor categories. Then, a  $G$ -crossed structure is naturally induced on  $\mathcal{C} \times \mathcal{D}$ . Another choice of  $\mathcal{C} \boxtimes \mathcal{D}$  only yields a  $G$ -crossed isomorphic one.

*Proof.* We already know that  $\mathcal{C} \times \mathcal{D}$  is a pivotal category with a pivotal action of  $G$  by Proposition 4.4. Since  $\mathcal{C} \boxtimes \mathcal{D} = \bigoplus_g \bigoplus_h \mathcal{C}_h \otimes \mathcal{D}_{h^{-1}g}$  follows from [LF13, Theorem 27] by the assumption of split semisimplicity, we put  $(\mathcal{C} \times \mathcal{D})_g := \bigoplus_h \mathcal{C}_h \boxtimes \mathcal{D}_{h^{-1}g}$  for  $g \in G$ . Then, we have  $(\mathcal{C} \times \mathcal{D})_g \otimes (\mathcal{C} \times \mathcal{D})_h$  for  $g, h \in G$  since  $\partial((c_1 \boxtimes d_1)(c_2 \boxtimes d_2)) = \partial(c_1 c_2 \boxtimes \overline{c_2} d_1 d_2) = \partial c_1 \partial d_1 \partial c_2 \partial d_2$  for  $c_1, c_2, d_1, d_2 \in \text{Homog}(\mathcal{C})$  by definition. Thus,  $\mathcal{C} \times \mathcal{D}$  is a  $G$ -graded multitensor category. Moreover,  $\mathcal{C} \times \mathcal{D}$  is  $G$ -crossed since  $\partial^{\mathcal{C} \times \mathcal{D}}(g c \boxtimes g d) = g \partial c g^{-1} g \partial d g^{-1} = g \partial c \partial d g^{-1}$  for  $c \in \text{Homog}(\mathcal{C})$ ,  $d \in \text{Homog}(\mathcal{D})$  and  $g \in G$ . Another choice of  $\mathcal{C} \boxtimes \mathcal{D}$  only yields an isomorphic  $G$ -crossed structure since changing  $\mathcal{C} \boxtimes \mathcal{D}$  preserves  $\mathcal{C}_h \boxtimes \mathcal{D}_{h^{-1}g}$  and therefore yields an isomorphic  $G$ -grading.  $\square$

Next, we show that if  $\mathcal{C}$  and  $\mathcal{D}$  are moreover  $G$ -braided, then we can obtain a  $G$ -braiding on a subcategory of  $\mathcal{C} \times \mathcal{D}$ .

**Proposition 4.6.** Let  $\mathcal{C}$  and  $\mathcal{D}$  be split semisimple  $G$ -crossed multitensor categories. Define a full pivotal multitensor subcategory  $D(\mathcal{C}, \mathcal{D}) := (\mathcal{C} \times \mathcal{D})_e$  of  $\mathcal{C} \times \mathcal{D}$  with the restricted pivotal action  $\gamma^{D(\mathcal{C}, \mathcal{D})}$ . Then, we can define a  $G$ -grading on  $D(\mathcal{C}, \mathcal{D})$  by putting  $D(\mathcal{C}, \mathcal{D})_g := \bigoplus_h \mathcal{C}_g \boxtimes \mathcal{D}_{g^{-1}h}$  for  $g \in G$ , and  $D(\mathcal{C}, \mathcal{D})$  is a  $G$ -crossed multitensor category with respect to this  $G$ -grading. Another choice of  $\mathcal{C} \boxtimes \mathcal{D}$  only yields a  $G$ -crossed isomorphic one.

*Proof.* For  $g, h \in G$ , the monoidal product of objects of  $D(\mathcal{C}, \mathcal{D})_g$  and  $D(\mathcal{C}, \mathcal{D})_h$  is an object of  $D(\mathcal{C}, \mathcal{D})_{gh}$ , and  ${}^g \text{Obj}(D(\mathcal{C}, \mathcal{D})_h) \subset \text{Obj}(D(\mathcal{C}, \mathcal{D})_{ghg^{-1}})$  since  $\mathcal{C}$  is  $G$ -crossed. The last statement follows as in the proof of Proposition 4.5.  $\square$

**Theorem 4.7.** Let  $G$  be a group and let  $\mathcal{C}$  and  $\mathcal{D}$  be split semisimple  $G$ -braided multitensor categories. Then, we can induce a  $G$ -braiding on  $D(\mathcal{C}, \mathcal{D})$ . Another choice of  $\mathcal{C} \boxtimes \mathcal{D}$  only yields an isomorphic  $G$ -braiding.

*Proof.* Since  $(c_1 \boxtimes d_1)(c_2 \boxtimes d_2) = c_1 c_2 \boxtimes \overline{c_2} d_1 d_2 = c_1 c_2 \boxtimes d_2 d_1 d_2$  and  ${}^g(c_2 \boxtimes d_2)(c_1 \boxtimes d_1) = {}^g c_2 c_1 \boxtimes \overline{c_1} d_2 d_1 = {}^{c_1} c_2 c_1 \boxtimes d_2 d_1$  for  $c_1 \boxtimes d_1 \in \text{Obj}(D(\mathcal{C}, \mathcal{D})_g)$  and  $c_2 \boxtimes d_2 \in \text{Homog}(D(\mathcal{C}, \mathcal{D}))$ , we can define a natural isomorphism  $b$  by putting  $b_{c_1 \boxtimes d_1, c_2 \boxtimes d_2} := b_{c_1, c_2}^{\mathcal{C}} \boxtimes b_{d_1, d_2}^{\mathcal{D}-}$ . Then,  ${}^h b_{c_1 \boxtimes d_1, c_2 \boxtimes d_2} = b_{h(c_1 \boxtimes d_1), h(c_2 \boxtimes d_2)}$  for  $h \in G$  by definition. Moreover, for  $c_3 \boxtimes d_3 \in \text{Homog}(D(\mathcal{C}, \mathcal{D}))$ , we have

$$\begin{aligned} b_{(c_1 \boxtimes d_1)(c_2 \boxtimes d_2), c_3 \boxtimes d_3} &= b_{c_1 c_2 \boxtimes \overline{c_2} d_1 d_2, c_3 \boxtimes d_3} = b_{c_1 c_2, c_3}^{\mathcal{C}} \boxtimes b_{\overline{c_2} d_1 d_2, d_3}^{\mathcal{D}-} \\ &= (b_{c_1, c_2}^{\mathcal{C}} \otimes \text{id}_{c_3})(\text{id}_{c_1} \otimes b_{c_2, c_3}^{\mathcal{C}}) \boxtimes (b_{\overline{c_2} d_1, d_3}^{\mathcal{D}-} \otimes \text{id}_{d_2})(\text{id}_{d_3 \overline{c_2} d_1} \otimes b_{d_2, d_3}^{\mathcal{D}-}) \\ &= (b_{c_1, c_2}^{\mathcal{C}} \otimes \text{id}_{c_3})(\text{id}_{c_1} \otimes b_{c_2, c_3}^{\mathcal{C}}) \boxtimes (\overline{c_2} b_{d_1, c_2 d_3}^{\mathcal{D}-} \otimes \text{id}_{d_2})(\overline{c_2 c_3}(\text{id}_{d_1}) \otimes b_{d_2, d_3}^{\mathcal{D}-}) \\ &= (b_{c_1 \boxtimes d_1, c_2 \boxtimes d_2} \otimes \text{id}_{c_3 \boxtimes d_3})(\text{id}_{c_1 \boxtimes d_1} \otimes b_{c_2 \boxtimes d_2, c_3 \boxtimes d_3}) \end{aligned}$$

since  $\partial d_3 = \partial \overline{c_3}$  by definition. Similarly, we have

$$\begin{aligned} b_{c_1 \boxtimes d_1, (c_2 \boxtimes d_2)(c_3 \boxtimes d_3)} &= b_{c_1 \boxtimes d_1, c_2 c_3 \boxtimes \overline{c_3} d_2 d_3} = b_{c_1, c_2 c_3}^{\mathcal{C}} \boxtimes b_{d_1, \overline{c_3} d_2 d_3}^{\mathcal{D}-} \\ &= (\text{id}_{c_1} \otimes b_{c_2, c_3}^{\mathcal{C}})(b_{c_1, c_2}^{\mathcal{C}} \otimes \text{id}_{c_3}) \boxtimes (\text{id}_{\overline{c_3} d_2} \otimes b_{d_1, d_3}^{\mathcal{D}-})(b_{\overline{c_3} d_1, \overline{c_3} d_2}^{\mathcal{D}-} \otimes \text{id}_{d_3}) \\ &= (\text{id}_{c_1} \otimes b_{c_2, c_3}^{\mathcal{C}})(b_{c_1, c_2}^{\mathcal{C}} \otimes \text{id}_{c_3}) \boxtimes (\overline{c_3}(\text{id}_{c_1} d_2) \otimes b_{d_1, d_3}^{\mathcal{D}-})(\overline{c_3} b_{d_1, d_2}^{\mathcal{D}-} \otimes \text{id}_{d_3}) \\ &= (\text{id}_{c_1} \otimes b_{c_2 \boxtimes d_2, c_3 \boxtimes d_3})(b_{c_1 \boxtimes d_1, c_2 \boxtimes d_2} \otimes \text{id}_{c_3 \boxtimes d_3}). \end{aligned}$$

Thus,  $b$  is a  $G$ -braiding on  $D(\mathcal{C}, \mathcal{D})$ .  $\square$

**Definition 4.8.** Let  $\mathcal{C}$  be a  $G$ -braided multitensor category. We refer to the  $G$ -braided multitensor category  $D(\mathcal{C}) := D(\mathcal{C}, \mathcal{C})$  as the *neutral double* of  $\mathcal{C}$ .

$D$  is for Double. When  $G$  is trivial,  $D(\mathcal{C})$  is equal to  $\mathcal{C} \boxtimes \mathcal{C}^{\text{rev}}$  as a braided multitensor category.



## 4.2 Equivariant $\alpha$ -induction Frobenius algebras

In this subsection, we construct equivariant  $\alpha$ -induction Frobenius algebras (Theorem 4.14) and show that it is symmetric and has the equivariant version of commutativity.

First, we introduce the notion of the *conjugate* of a morphism of a  $G$ -braided multitensor category.

**Definition 4.9.** Let  $\mathcal{C}$  be a  $G$ -braided multitensor category. Let  $\{\lambda_i\}_{i=1}^n, \{\mu_j\}_{j=1}^m \subset \text{Homog}(\mathcal{C})$  and let  $f \in \text{Hom}(\lambda_1 \cdots \lambda_n, \mu_1 \cdots \mu_m)$ . Then, the *conjugate*  $\bar{f}$  of  $f$  is defined to be the morphism in Figure 37.

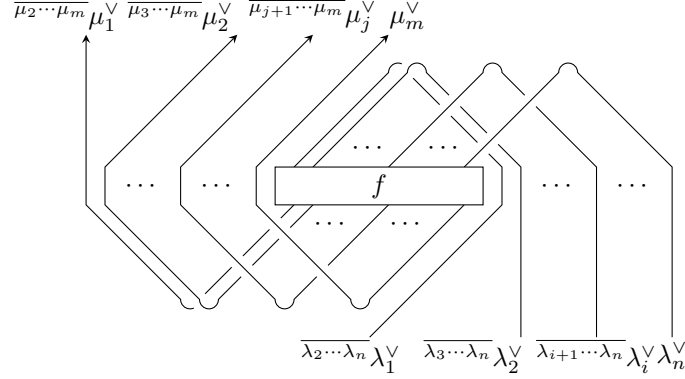

Figure 37: The conjugate  $\bar{f}$  of  $f \in \text{Hom}(\lambda_1 \cdots \lambda_n, \mu_1 \cdots \mu_m)$

**Remark 4.10.** When  $\mathcal{C}$  is an (ordinary) braided  $*$ -multitensor category,  $\bar{f}$  for  $f \in \text{Hom}(\lambda, \mu_1 \mu_2)$  in the sense of [BKL15, Section 4.1] is  $f^*$  in our sense.

**Lemma 4.11.** Let  $\mathcal{C}$  be a  $G$ -braided multitensor category. Let  $\{\lambda_i\}_{i=1}^n, \{\mu_j\}_{j=1}^m, \{\nu_k\}_{k=1}^l \subset \text{Homog}(\mathcal{C})$ ,  $f \in \text{Hom}(\lambda_1 \cdots \lambda_n, \mu_1 \cdots \mu_m)$  and  $f' \in \text{Hom}(\mu_1 \cdots \mu_m, \nu_1 \cdots \nu_l)$ . Then,  $f' \circ f = \bar{f} \circ f'$ .

*Proof.* It follows from the graphical calculation in Figure 38.  $\square$

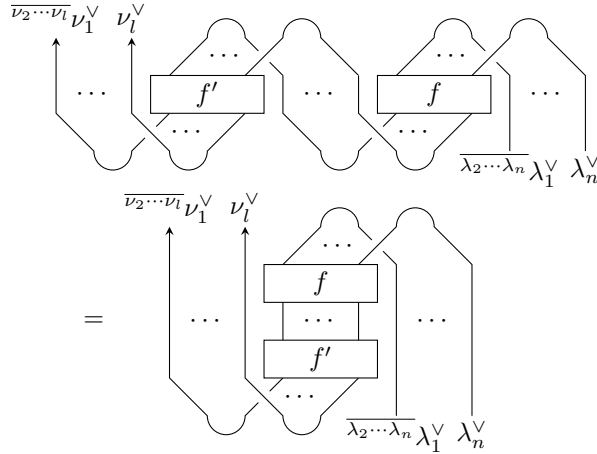

Figure 38: Conjugation is contravariant

**Lemma 4.12.** Let  $\mathcal{C}$  be a  $G$ -braided multitensor category. Let  $\{\lambda_i\}_{i=1}^n, \{\mu_j\}_{j=1}^m, \{\nu_k\}_{k=1}^l, \{\rho_p\}_{p=1}^q$  be families in  $\text{Homog}(\mathcal{C})$  and let  $f \in \text{Hom}(\lambda_1 \cdots \lambda_n, \mu_1 \cdots \mu_m)$  and  $f' \in \text{Hom}(\nu_1 \cdots \nu_l, \rho_1 \cdots \rho_q)$ . Then,  $\bar{f} \otimes f' = \overline{\nu_1 \cdots \nu_l}(f) \otimes f'$ .

*Proof.* We may assume  $\partial(\nu_1 \cdots \nu_l) = \partial(\rho_1 \cdots \rho_q)$  since otherwise  $f' = 0$ . Then, the statement follows from the graphical calculation in Figure 39, where we used the assumption  $\partial(\nu_1 \cdots \nu_l) = \partial(\rho_1 \cdots \rho_q)$  at the final equality.  $\square$

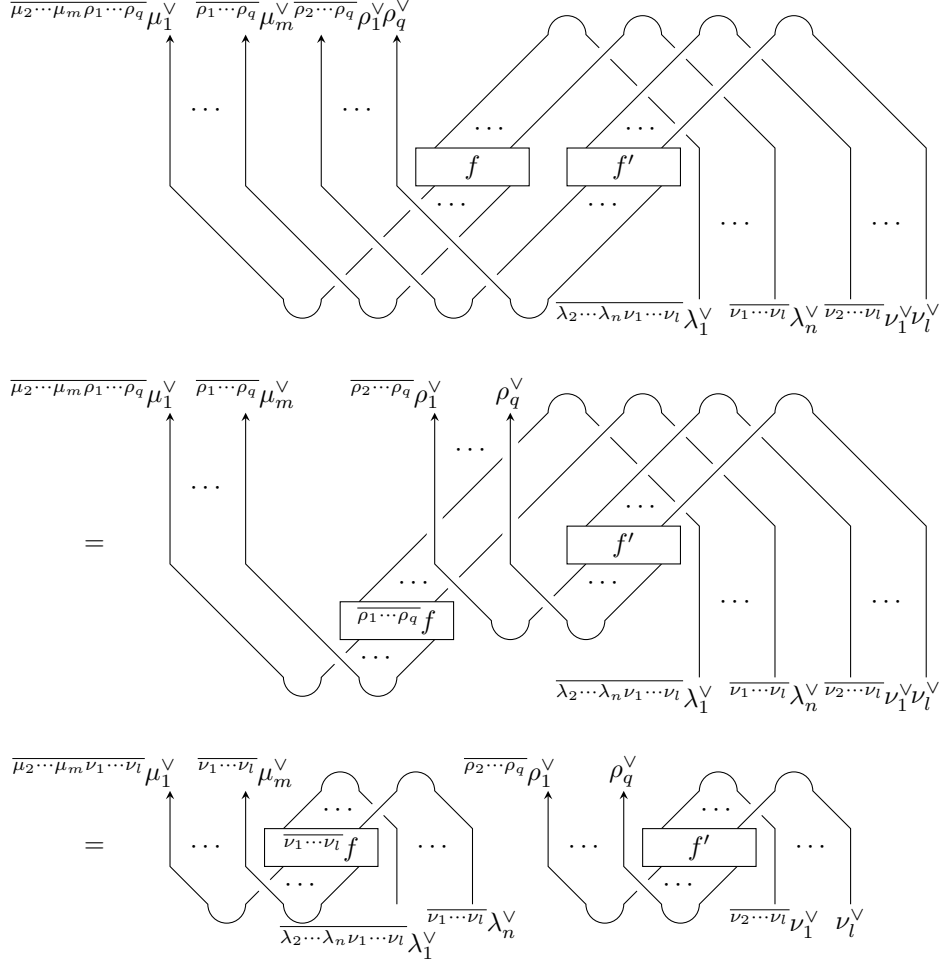

Figure 39: Conjugation and the monoidal product

**Lemma 4.13.** Let  $\mathcal{C}$  be a  $G$ -braided  $*$ -multitensor category. Let  $\{\lambda_i\}_{i=1}^n, \{\mu_j\}_{j=1}^m \subset \text{Homog}(\mathcal{C})$  and let  $f \in \text{Hom}(\lambda_1 \cdots \lambda_n, \mu_1 \cdots \mu_m)$ . Then  $\overline{f^*} = (\overline{f})^*$  if we define  $\overline{f}$  using standard solutions of conjugate equations.

*Proof.* Since standard left and right duals of a morphism in a  $*$ -multitensor category coincide by [LR97, Lemma 3.7], the equation in Figure 40 holds by Figure 16. Therefore, the statement follows by taking  $*$ -involution.

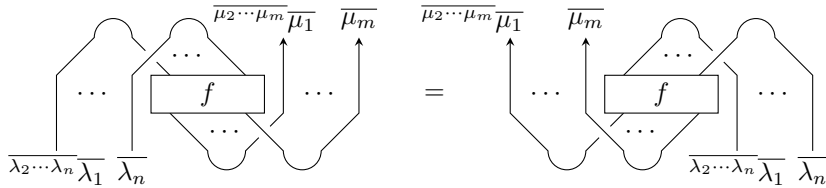

Figure 40: Conjugation and the  $*$ -structure

$\square$

Next, let  $\mathcal{C}$  be a semisimple pivotal tensor category and let  $\text{Tr}$  denote  $\text{Tr}^L(\delta^{\mathcal{C}} -)$ . For  $\lambda, \mu \in \text{Obj}(\mathcal{C})$  with  $d_\lambda := \dim \lambda \neq 0$ , the bilinear form given by putting  $(f', f) := d_\lambda^{-1} \text{Tr}(f' \circ f)$  for  $f \in \text{Hom}(\lambda, \mu)$  and  $f' \in \text{Hom}(\mu, \lambda)$  is nondegenerate by the proof of [Tur16, Lemma II.4.2.3]. Therefore,  $\text{Hom}(\mu, \lambda)$  can be identified with the dual space  $\text{Hom}(\lambda, \mu)^\vee$  of  $\text{Hom}(\lambda, \mu)$ , and for a basis  $\{e_i\}_{i=1}^{\langle \lambda, \mu \rangle}$  of  $\text{Hom}(\lambda, \mu)$ , where  $\langle \lambda, \mu \rangle := \dim \text{Hom}(\lambda, \mu)$ , we can take the corresponding dual basis  $\{\tilde{e}_i\}_{i=1}^{\langle \lambda, \mu \rangle}$  of  $\text{Hom}(\mu, \lambda)$ . Note that if  $\mathcal{C}$  is split and  $\lambda$  is simple, then  $\tilde{e}_i e_j = (\tilde{e}_i, e_j) \text{id}_\lambda = \delta_{ij} \text{id}_\lambda$ .

In particular, when  $\mathcal{C}$  is a  $*$ -tensor category, we can make  $\text{Hom}(\lambda, \mu)$  into a Hilbert space by putting  $(f_1 | f_2) := d_\lambda^{-1} \text{Tr}(f_1^* f_2)$  for  $f_1, f_2 \in \text{Hom}(\lambda, \mu)$ . By the Gram–Schmidt orthonormalization, we can take an orthonormal basis  $\{e_i\}_i$  of  $\text{Hom}(\lambda, \mu)$ . Note that if  $\lambda$  is simple, then  $f_1^* f_2 = (f_1 | f_2) \text{id}_\lambda$  and therefore  $\{e_i\}_i$  is a family of orthogonal isometries with the dual basis  $\{e_i^*\}_i$ .

Now, we can prove one of our main theorems.

**Theorem 4.14.** Let  $A$  be a neutral symmetric special simple  $G$ -equivariant Frobenius algebra in a split  $G$ -braided fusion category  $\mathcal{C}$ . Fix a complete system  $I$  of representatives of the isomorphism classes of the simple objects of  $\mathcal{C}$  and define  $\theta \in \text{Obj}(D(\mathcal{C}))$  by putting

$$\theta := \bigoplus_{\substack{\lambda_1, \lambda_2 \in I \\ \partial \lambda_1 = \partial \lambda_2}} \langle \alpha_A^{G+}(\lambda_1), \alpha_A^{G-}(\lambda_2) \rangle \lambda_1 \boxtimes \lambda_2^\vee.$$

Let  $\eta \in \text{Hom}(\mathbf{1}_{D(\mathcal{C})}, \theta)$  denote the inclusion and let  $\varepsilon \in \text{Hom}(\theta, \mathbf{1}_{D(\mathcal{C})})$  denote the projection multiplied by  $\dim \theta$ . For any  $\lambda_1, \lambda_2 \in I$  with  $\partial \lambda_1 = \partial \lambda_2$ , fix a basis  $\{\phi_l^L\}_l$  of  $\text{Hom}(\alpha_A^{G+}(\lambda_1), \alpha_A^{G-}(\lambda_2))$ . For any  $\lambda, \mu, \nu \in I$ , fix a basis  $\{e_i^{\nu, \lambda \mu}\}_i$  of  $\text{Hom}(\nu, \lambda \mu)$ . Define  $\tilde{m} \in \text{Hom}(\theta^2, \theta)$  and  $\Delta \in \text{Hom}(\theta, \theta^2)$  by putting

$$\begin{aligned} \tilde{m} &:= \bigoplus_{L, M, N} \sum_{i, j} \frac{1}{d_{\nu_1}} \text{Tr}(\tilde{\phi}_n^N \alpha_A^{G-}(\tilde{e}_j^{\nu_2, \lambda_2 \mu_2})(\phi_l^L \otimes \phi_m^M) \alpha_A^{G+}(e_i^{\nu_1, \lambda_1 \mu_1})) (\tilde{e}_i^{\nu_1, \lambda_1 \mu_1} \boxtimes \overline{e_j^{\nu_2, \lambda_2 \mu_2}}) \\ \Delta &:= \bigoplus_{L, M, N} \sum_{i, j} \frac{d_{\lambda_2} d_{\mu_2}}{d_{\nu_2} d_{\nu_1}} \text{Tr}(\alpha_A^{G+}(\tilde{e}_i^{\nu_1, \lambda_1 \mu_1})(\tilde{\phi}_l^L \otimes \tilde{\phi}_m^M) \alpha_A^{G-}(e_j^{\nu_2, \lambda_2 \mu_2}) \phi_n^N) (e_i^{\nu_1, \lambda_1 \mu_1} \boxtimes \overline{e_j^{\nu_2, \lambda_2 \mu_2}}), \end{aligned}$$

where  $L$  is a multi-index  $L = (\lambda_1, \lambda_2, l)$  which consists of  $\lambda_1, \lambda_2 \in I$  with  $\partial \lambda_1 = \partial \lambda_2$  and an integer  $1 \leq l \leq \langle \alpha_A^{G+}(\lambda_1), \alpha_A^{G-}(\lambda_2) \rangle$  and  $M = (\mu_1, \mu_2, m)$  and  $N = (\nu_1, \nu_2, n)$  are similar multi-indices. For any  $g \in G$  and  $\lambda \in I$ , fix an isomorphism  $u_g^\lambda : {}^g \lambda \cong \lambda(g)$ , where  $\lambda(g)$  denotes the object in  $I$  which is isomorphic to  ${}^g \lambda$ . For every  $g \in G$ , define  $z_g \in \text{Hom}({}^g \theta, \theta)$  by putting

$$z_g := \bigoplus_{L, \nu} \frac{1}{d_{\lambda_1}} \text{Tr}(\alpha_A^{G+}(\tilde{u}_g^{\lambda_1}) \tilde{\phi}_l^{L(g)} \alpha_A^{G-}(u_g^{\lambda_2}) \tilde{\eta}_{\lambda_2}^{g-1} \phi_l^L \tilde{\eta}_{\lambda_1}^g) (u_g^{\lambda_1} \boxtimes \overline{u_g^{\lambda_2}}),$$

where  $L(g)$  is the multi-index  $(\lambda_1(g), \lambda_2(g), m)$  and  $\tilde{\eta}_\lambda^g := z_A^{A-1} \otimes_{\mathcal{C}} \text{id}_{{}^g \lambda}$  for  $\lambda \in I$ . Then, the tuple  $\Theta_\alpha^G(A) := (\theta, \tilde{m}, \eta, \Delta, \varepsilon, z)$  is a  $G$ -equivariant Frobenius algebra in  $D(\mathcal{C})$ . If  $\mathcal{C}$  is moreover spherical, then  $\tilde{m} \circ \Delta = \dim \Theta_\alpha^G(A)$ . Another choice of  $\{e_i^{\nu, \lambda \mu}\}_i$ 's and  $u_g^\lambda$ 's yields the same  $G$ -equivariant Frobenius algebra. Another choice of  $I$ , a direct sum and  $\lambda_2^\vee$ 's in the definition of  $\theta$  and  $\{\phi_l^L\}_l$ 's yields an isomorphic  $G$ -equivariant Frobenius algebra. We call  $\Theta_\alpha^G(A)$  the  $G$ -equivariant  $\alpha$ -induction Frobenius algebra associated with  $A$ . When  $A$  is a Q-system in a  $*$ -fusion category  $\mathcal{C}$ , let  $w \in \text{Hom}(\mathbf{1}_{D(\mathcal{C})}, \theta)$  denote the isometric inclusion. Take  $\{\phi_l^L\}_l$ 's and  $\{e_i^{\nu, \lambda \mu}\}_i$ 's to be orthonormal bases and define  $x \in \text{Hom}(\theta, \theta^2)$  to be

$$\bigoplus_{L, M, N} \sum_{i, j} \sqrt{\frac{d_{\lambda_2} d_{\mu_2}}{d_\theta d_{\nu_2}}} \frac{1}{d_{\nu_1}} \text{Tr}(\alpha_A^{G+}(e_i^{\nu_1, \lambda_1 \mu_1})^* (\phi_l^L \otimes \phi_m^M)^* \alpha_A^{G-}(e_j^{\nu_2, \lambda_2 \mu_2}) \phi_n^N) (e_i^{\nu_1, \lambda_1 \mu_1} \boxtimes \overline{e_j^{\nu_2, \lambda_2 \mu_2}}).$$

Take  $u_g^\lambda$ 's to be unitaries and define  $z \in \text{Hom}({}^g \theta, \theta)$  by putting

$$z_g := \bigoplus_{L, \nu} \frac{1}{d_{\lambda_1}} \text{Tr}(\alpha_A^{G+}(u_g^{\lambda_1})^* \phi_l^{L(g)*} \alpha_A^{G-}(u_g^{\lambda_2}) \tilde{\eta}_{\lambda_2}^{g*} \phi_l^L \tilde{\eta}_{\lambda_1}^g) (u_g^{\lambda_1} \boxtimes \overline{u_g^{\lambda_2}}).$$

Then,  $\Theta_\alpha^G(A) := (\theta, w, x, z)$  is a  $G$ -equivariant Q-system. Another choice of  $\{e_i^{\nu, \lambda \mu}\}_i$ 's and  $u_g^\lambda$ 's yields the same  $G$ -equivariant Q-system. Another choice of  $I$ , a direct sum and  $\lambda_2^\vee$ 's in the definition

of  $\theta$  and  $\{\phi_l^L\}_l$ 's yields an isomorphic  $G$ -equivariant  $Q$ -system. We call  $\Theta_\alpha^G(A)$  the  $G$ -equivariant  $\alpha$ -induction  $Q$ -system associated with  $A$ .

*Proof.* First, we note that  $\tilde{m}, \Delta$  and  $z$  are well-defined. Indeed,

$$\begin{aligned} \text{Hom}(\theta, \theta^2) &= \bigoplus_{L, M, N} \text{Hom}(\nu_1 \boxtimes \nu_2^\vee, (\lambda_1 \boxtimes \lambda_2^\vee) \otimes (\mu_1 \boxtimes \mu_2^\vee)) \\ &= \bigoplus_{L, M, N} \text{Hom}(\nu_1 \boxtimes \nu_2^\vee, \lambda_1 \mu_1 \boxtimes \overline{\mu_2} \lambda_2^\vee \mu_2^\vee) \end{aligned}$$

by  $\partial\mu_1 = \partial\mu_2$  and  $e_i^{\nu_1, \lambda_1 \mu_1} \boxtimes \overline{\tilde{e}_j^{\nu_2, \lambda_2 \mu_2}} \in \text{Hom}(\nu_1 \boxtimes \nu_2^\vee, \lambda_1 \mu_1 \boxtimes \overline{\mu_2} \lambda_2^\vee \mu_2^\vee)$  by definition. The coefficient of  $\Delta$  is also well-defined. Indeed, we can take the dual bases  $\{\tilde{e}_i^{\nu, \lambda \mu}\}_i$ 's since  $d_\nu \neq 0$  by [EGNO15, Proposition 4.8.4]. The category  $\text{Bimod}_C(A)$  is a tensor category by assumption, pivotal by Proposition 3.3 and semisimple by [Yam04, Proposition 6.1]. Since  $\dim \alpha_A^{G^\pm}(\lambda) = d_\lambda \neq 0$  for  $\lambda \in I$  by Proposition 4.2, we can take the dual bases  $\{\tilde{\phi}_l^L\}_l$ 's. Thus,  $\Delta$  is well-defined. Similarly,  $m$  and  $z$  are well-defined.

Next, we note that  $\Theta_\alpha^G(A)$  does not depend on a choice of  $\{e_i^{\nu, \lambda \mu}\}_i$ 's since the effect of changing  $\{\tilde{e}_i^{\nu, \lambda \mu}\}_i$ 's in the definition of  $\tilde{m}$  and  $\Delta$  is canceled by the corresponding change of  $\{\tilde{e}_i^{\nu, \lambda \mu}\}_i$ 's. For the same reason, it does not depend on a choice of  $u_g^\lambda$ 's. Note also that another choice of  $\{\phi_l^L\}_l$ 's only yields another direct sum in the definition of  $\theta$ . Once we have shown that  $\Theta_\alpha^G(A)$  is a  $G$ -equivariant Frobenius algebra, we can see that another direct sum yields a canonically isomorphic one since we define structures to be direct sums. Also, another choice of left duals yields a canonically isomorphic one by the definition of conjugation. Another choice of  $I$  yields an isomorphic one by fixing isomorphisms between simple objects.

Then, we show that  $\Theta_\alpha^G(A)$  is a Frobenius algebra. Because the proof is similar to that of [Reh00, Theorem 1.4], we only show coassociativity here. We have

$$\begin{aligned} &(\Delta \otimes \text{id}_\theta)\Delta \\ &= \bigoplus_{L, M, M', N'} \sum_{N, i, j, i', j'} \frac{d_{\lambda_2} d_{\mu_2} d_{\mu_2'}}{d_{\nu_2'} d_{\nu_1} d_{\nu_1'}} \text{Tr}(\alpha_A^{G^+}(\tilde{e}_i^{\nu_1, \lambda_1 \mu_1})(\tilde{\phi}_l^L \otimes \tilde{\phi}_m^M) \alpha_A^{G^-}(e_j^{\nu_2, \lambda_2 \mu_2}) \phi_n^N) \\ &\quad \times \text{Tr}(\alpha_A^{G^+}(\tilde{e}_{i'}^{\nu_1', \nu_1 \mu_1'}) (\tilde{\phi}_n^N \otimes \tilde{\phi}_{m'}^{M'}) \alpha_A^{G^-}(e_{j'}^{\nu_2', \nu_2 \mu_2'}) \phi_{n'}^{N'}) \\ &\quad \times (e_i^{\nu_1, \lambda_1 \mu_1} \otimes \text{id}_{\mu_1'} e_{i'}^{\nu_1', \nu_1 \mu_1'} \boxtimes \overline{\mu_1'} (\tilde{e}_j^{\nu_2, \lambda_2 \mu_2}) \otimes \text{id}_{\mu_2'} \overline{\tilde{e}_{j'}^{\nu_2', \nu_2 \mu_2'}}) \\ &= \bigoplus_{L, M, M', N'} \sum_{N, i, j, i', j'} \frac{d_{\lambda_2} d_{\mu_2} d_{\mu_2'}}{d_{\nu_2'} d_{\nu_1} d_{\nu_1'}} \text{Tr}(\alpha_A^{G^+}(\tilde{e}_i^{\nu_1, \lambda_1 \mu_1})(\tilde{\phi}_l^L \otimes \tilde{\phi}_m^M) \alpha_A^{G^-}(e_j^{\nu_2, \lambda_2 \mu_2}) \phi_n^N) \\ &\quad \times \text{Tr}(\alpha_A^{G^+}(\tilde{e}_{i'}^{\nu_1', \nu_1 \mu_1'}) (\tilde{\phi}_n^N \otimes \tilde{\phi}_{m'}^{M'}) \alpha_A^{G^-}(e_{j'}^{\nu_2', \nu_2 \mu_2'}) \phi_{n'}^{N'}) \\ &\quad \times (e_i^{\nu_1, \lambda_1 \mu_1} \otimes \text{id}_{\mu_1'} e_{i'}^{\nu_1', \nu_1 \mu_1'} \boxtimes \overline{\tilde{e}_{j'}^{\nu_2', \nu_2 \mu_2'}} (\tilde{e}_j^{\nu_2, \lambda_2 \mu_2} \otimes \text{id}_{\mu_2'})) \end{aligned}$$

by  $\partial\mu_1' = \partial\mu_2'$  and Lemmata 4.11 and 4.12. By the cyclicity of the trace, we have

$$\begin{aligned} &\frac{1}{d_{\nu_1}} \text{Tr}(\alpha_A^{G^+}(\tilde{e}_i^{\nu_1, \lambda_1 \mu_1})(\tilde{\phi}_l^L \otimes \tilde{\phi}_m^M) \alpha_A^{G^-}(e_j^{\nu_2, \lambda_2 \mu_2}) \phi_n^N) \\ &= \frac{d_{\nu_2}}{d_{\nu_1}} \frac{1}{d_{\nu_2}} \text{Tr}(\phi_n^N \alpha_A^{G^+}(\tilde{e}_i^{\nu_1, \lambda_1 \mu_1})(\tilde{\phi}_l^L \otimes \tilde{\phi}_m^M) \alpha_A^{G^-}(e_j^{\nu_2, \lambda_2 \mu_2})) \\ &= \left( \frac{d_{\nu_2}}{d_{\nu_1}} \phi_n^N, \alpha_A^{G^+}(\tilde{e}_i^{\nu_1, \lambda_1 \mu_1})(\tilde{\phi}_l^L \otimes \tilde{\phi}_m^M) \alpha_A^{G^-}(e_j^{\nu_2, \lambda_2 \mu_2}) \right). \end{aligned}$$

Note that  $\{d_{\nu_2}/d_{\nu_1} \phi_n^N\}_n$  is the dual basis of  $\{\tilde{\phi}_n^N\}_n$  by the cyclicity of the trace since  $\dim \alpha_A^{G^+}(\nu_1) = d_{\nu_1}$  and  $\dim \alpha_A^{G^-}(\nu_2) = d_{\nu_2}$  by Proposition 3.3. Then, by the Fourier expansion in the basis  $\{\tilde{\phi}_n^N\}$ ,

we obtain

$$\begin{aligned}
& (\Delta \otimes \text{id}_\theta) \Delta \\
&= \bigoplus_{L, M, M', N'} \sum_{\nu_1, \nu_2, i, j, i', j'} \frac{d_{\lambda_2} d_{\mu_2} d_{\mu'_2}}{d_{\nu'_2} d_{\nu'_1}} \\
&\quad \times \text{Tr}(\alpha_A^{G+}(\tilde{e}_{i'}^{\nu'_1, \nu_1 \mu'_1}(\tilde{e}_i^{\nu_1, \lambda_1 \mu_1} \otimes \text{id}_{\mu'_1}))) (\tilde{\phi}_l^L \otimes \tilde{\phi}_m^M \otimes \tilde{\phi}_{m'}^{M'}) \alpha_A^{G-}((e^{\nu_2, \lambda_2 \mu_2} \otimes \text{id}_{\mu'_2}) e_{j'}^{\nu'_2, \nu_2 \mu'_2}) \phi_{n'}^{N'} \\
&\quad \times (e_i^{\nu_1, \lambda_1 \mu_1} \otimes \text{id}_{\mu'_1}) e_{i'}^{\nu'_1, \nu_1 \mu'_1} \boxtimes \overline{e_{j'}^{\nu'_2, \nu_2 \mu'_2}(\tilde{e}_j^{\nu_2, \lambda_2 \mu_2} \otimes \text{id}_{\mu'_2})}.
\end{aligned}$$

By a similar calculation, we obtain

$$\begin{aligned}
& (\text{id}_\theta \otimes \Delta) \Delta \\
&= \bigoplus_{L, M, M', N'} \sum_{\nu_1, \nu_2, i, j, i', j'} \frac{d_{\lambda_2} d_{\mu_2} d_{\mu'_2}}{d_{\nu'_2} d_{\nu'_1}} \\
&\quad \times \text{Tr}(\alpha_A^{G+}(\tilde{e}_{i'}^{\nu'_1, \lambda_1 \nu_1}(\text{id}_{\lambda_1} \otimes \tilde{e}_i^{\nu_1, \mu_1 \mu'_1}))) (\tilde{\phi}_l^L \otimes \tilde{\phi}_m^M \otimes \tilde{\phi}_{m'}^{M'}) \alpha_A^{G-}((\text{id}_{\lambda_2} \otimes e^{\nu_2, \mu_2 \mu'_2}) e_{j'}^{\nu'_2, \lambda_2 \nu_2}) \phi_{n'}^{N'} \\
&\quad \times (\text{id}_{\lambda_1} \otimes e_i^{\nu_1, \mu_1 \mu'_1}) e_{i'}^{\nu'_1, \lambda_1 \nu_1} \boxtimes \overline{e_{j'}^{\nu'_2, \lambda_2 \nu_2}(\text{id}_{\lambda_2} \otimes \tilde{e}_j^{\nu_2, \mu_2 \mu'_2})}.
\end{aligned}$$

Since

$$\{(e_i^{\nu_k, \lambda_k \mu_k} \otimes \text{id}_{\mu'_k}) e_{i'}^{\nu'_k, \nu_k \mu'_k}\}_{\nu_k, i, i'} \quad \text{and} \quad \{(\text{id}_{\lambda_k} \otimes e_i^{\nu_k, \mu_k \mu'_k}) e_{i'}^{\nu'_k, \lambda_k \nu_k}\}_{\nu_k, i, i'}$$

are both bases of  $\text{Hom}(\nu'_k, \lambda_k \mu_k \mu'_k)$  and their dual bases are respectively given by

$$\{\tilde{e}_{i'}^{\nu'_k, \nu_k \mu'_k}(\tilde{e}_i^{\nu_k, \lambda_k \mu_k} \otimes \text{id}_{\mu'_k})\}_{\nu_k, i, i'} \quad \text{and} \quad \{\tilde{e}_{i'}^{\nu'_k, \lambda_k \nu_k}(\text{id}_{\lambda_k} \otimes \tilde{e}_i^{\nu_k, \mu_k \mu'_k})\}_{\nu_k, i, i'}$$

for  $k = 1, 2$ , we can interchange these bases in the representations of  $(\Delta \otimes \text{id}_\theta) \Delta$  and  $(\text{id}_\theta \otimes \Delta) \Delta$  and therefore obtain  $(\Delta \otimes \text{id}_\theta) \Delta = (\text{id}_\theta \otimes \Delta) \Delta$ . We can also show  $\tilde{m} \circ \Delta = d_\theta$  when  $\mathcal{C}$  is spherical as in the proof of [Reh00, Theorem 1.4] by Proposition 3.3.

Finally, we show that  $\Theta_A^G$  is a  $G$ -equivariant Frobenius algebra, which is essentially new. First, we show that  $z_g$  is invertible for every  $g \in G$ . Indeed, we show that the inverse is given by

$$z_g^{-1} = \bigoplus_{L, l'} \frac{1}{d_{\lambda_1}} \text{Tr}(\tilde{\eta}_{\lambda_1}^{g-1g} \tilde{\phi}_l^L \tilde{\eta}_{\lambda_2}^g \alpha_A^{G-}(\tilde{u}_g^{\lambda_2}) \phi_{l'}^{L(g)} \alpha_A^{G+}(u_g^{\lambda_1})) (\tilde{u}_g^{\lambda_1} \boxtimes \overline{u_g^{\lambda_2}})$$

By Lemma 4.11, we have

$$\begin{aligned}
z_g^{-1} z_g &= \bigoplus_L \sum_{l'} \frac{1}{d_{\lambda_1}^2} \text{Tr}(\tilde{\eta}_{\lambda_1}^{g-1g} \tilde{\phi}_l^L \tilde{\eta}_{\lambda_2}^g \alpha_A^{G-}(\tilde{u}_g^{\lambda_2}) \phi_{l'}^{L(g)} \alpha_A^{G+}(u_g^{\lambda_1})) \\
&\quad \times \text{Tr}(\alpha_A^{G+}(\tilde{u}_g^{\lambda_1}) \tilde{\phi}_{l'}^{L(g)} \alpha_A^{G-}(u_g^{\lambda_2}) \tilde{\eta}_{\lambda_2}^{g-1g} \phi_l^L \tilde{\eta}_{\lambda_2}^g).
\end{aligned}$$

By the cyclicity of the trace, we have

$$\frac{1}{d_{\lambda_1}} \text{Tr}(\alpha_A^{G+}(\tilde{u}_g^{\lambda_1}) \tilde{\phi}_{l'}^{L(g)} \alpha_A^{G-}(u_g^{\lambda_2}) \tilde{\eta}_{\lambda_2}^g \phi_l^L (\tilde{\eta}_{\lambda_2}^g)^{-1}) = (\tilde{\phi}_{l'}^{L(g)}, \alpha_A^{G-}(u_g^{\lambda_2}) \tilde{\eta}_{\lambda_2}^g \phi_l^L (\tilde{\eta}_{\lambda_2}^g)^{-1} \alpha_A^{G+}(\tilde{u}_g^{\lambda_1})),$$

so that we obtain

$$z_g^{-1} z_g = \bigoplus_L \frac{1}{d_{\lambda_1}} \text{Tr}(g(\tilde{\phi}_l^L \phi_l^L)) = \bigoplus_L (\tilde{\phi}_l^L, \phi_l^L) = \text{id}_{g_\theta}$$

by the Fourier expansion in the basis  $\{\phi_{l'}^{L(g)}\}_{l'}$  since the group action on  $\text{Bimod}_{\mathcal{C}}(A)$  is pivotal by Proposition 3.3 and therefore preserves traces. We can similarly check  $z_g z_g^{-1} = \text{id}_\theta$ . Thus,  $z_g$  is invertible.

Next, we show that  $(\theta, z)$  is a  $G$ -equivariant object. For any  $g, h \in G$ , we have

$$z_g^g z_h = \bigoplus_{L, L'} \sum_{\nu'} \frac{1}{d_{\lambda_1}^2} \operatorname{Tr}(\alpha_A^{G+}(\tilde{u}_g^{\lambda_1(h)}) \tilde{\phi}_{\nu'}^{L(g)} \alpha_A^{G-}(u_g^{\lambda_2(h)}) \tilde{\eta}_{\lambda_2(h)}^{g-1} {}^g \phi_{\nu'}^{L(h)} \tilde{\eta}_{\lambda_1(h)}^g) \\ \times \operatorname{Tr}(\alpha_A^{G+}(\tilde{u}_h^{\lambda_1}) \tilde{\phi}_{\nu'}^{L(h)} \alpha_A^{G-}(u_h^{\lambda_2}) \tilde{\eta}_{\lambda_2}^{h-1} {}^h \phi_{\nu'}^{L(h)} \tilde{\eta}_{\lambda_1}^h) (u_g^{\lambda_1(h)} {}^g u_h^{\lambda_1} \boxtimes \overline{{}^g \tilde{u}_h^{\lambda_2} \tilde{u}_g^{\lambda_2(h)}})$$

by Lemma 4.11. Since  $\tilde{\eta}_{\lambda_1}^g \alpha_A^{G+}(\tilde{u}_h^{\lambda_1}) = {}^g \alpha_A^{G+}(\tilde{u}_h^{\lambda_1}) \tilde{\eta}_{\lambda_1(h)}^g$  and  $\tilde{\eta}_{\lambda_2(h)}^g {}^g \alpha_A^{G-}(\tilde{u}_h^{\lambda_2}) = \alpha_A^{G-}({}^g \tilde{u}_h^{\lambda_2}) \tilde{\eta}_{\lambda_2}^g$  (see the proof of Proposition 3.8), we have

$$z_g^g z_h = \bigoplus_{L, L'} \frac{1}{d_{\lambda_1}} \operatorname{Tr}(\alpha_A^{G+}({}^g \tilde{u}_h^{\lambda_1} \tilde{u}_g^{\lambda_1(h)}) \tilde{\phi}_{\nu'}^{L(g)} \alpha_A^{G-}(u_g^{\lambda_2(h)} {}^g u_h^{\lambda_2}) \tilde{\eta}_{\lambda_2}^{gh-1} {}^g \phi_{\nu'}^{L(g)} \tilde{\eta}_{\lambda_1}^{gh}) \\ \times (u_g^{\lambda_1(h)} {}^g u_h^{\lambda_1} \boxtimes \overline{{}^g \tilde{u}_h^{\lambda_2} \tilde{u}_g^{\lambda_2(h)}})$$

by the cyclicity of the trace and the Fourier expansion in the basis  $\{\phi_{\nu'}^{L(h)}\}_{\nu'}$ . The right hand side is equal to  $z_{gh}$  since  $u_g^{\lambda_k(h)} {}^g u_h^{\lambda_k}$  is an isomorphism  ${}^{gh} \lambda_k \cong \lambda_k(gh)$  for  $k = 1, 2$  and  $z$  does not depend on a choice of isomorphisms. Therefore,  $(\theta, z)$  is a  $G$ -equivariant object.

Finally, we show that  $z_g$  is a Frobenius algebra homomorphism for every  $g \in G$ . Since we may take a basis of  $\operatorname{Hom}(\alpha_A^{G+}(\mathbf{1}_C), \alpha_A^{G-}(\mathbf{1}_C))$  to be the identity and take  $u_g^{\mathbf{1}_C}$ 's to be canonical isomorphisms, we have  $z_g^g \eta = \eta$  and  $\varepsilon z_g = {}^g \varepsilon$  for every  $g \in G$ . We show  $\Delta z_g = (z_g \otimes z_g)^g \Delta$ . We have

$$\Delta z_g = \bigoplus_{L, M, N} \sum_{n', i, j} \frac{d_{\lambda_2} d_{\mu_2}}{d_{\nu_2} d_{\nu_1^2}} \operatorname{Tr}(\alpha_A^{G+}(\tilde{e}_i^{\nu_1(g), \lambda_1 \mu_1}) (\tilde{\phi}_i^L \otimes \tilde{\phi}_m^M) \alpha_A^{G-}(e_j^{\nu_2(g), \lambda_2 \mu_2}) \phi_{n'}^N) \\ \times \operatorname{Tr}(\alpha_A^{G+}(\tilde{u}_g^{\nu_1}) \tilde{\phi}_{n'}^N \alpha_A^{G-}(u_g^{\nu_2}) \tilde{\eta}_{\nu_2}^{g-1} {}^g \phi_{n'}^N \tilde{\eta}_{\nu_1}^g) (e_i^{\nu_1(g), \lambda_1 \mu_1} u_g^{\nu_1} \boxtimes \overline{\tilde{u}_g^{\nu_2} \tilde{e}_j^{\nu_2(g), \lambda_2 \mu_2}}) \\ = \bigoplus_{L, M, N} \sum_{i, j} \frac{d_{\lambda_2} d_{\mu_2}}{d_{\nu_2} d_{\nu_1}} \operatorname{Tr}(\alpha_A^{G+}(\tilde{u}_g^{\nu_1} \tilde{e}_i^{\nu_1(g), \lambda_1 \mu_1}) (\tilde{\phi}_i^L \otimes \tilde{\phi}_m^M) \alpha_A^{G-}(e_j^{\nu_2(g), \lambda_2 \mu_2} u_g^{\nu_2}) \tilde{\eta}_{\nu_2}^{g-1} {}^g \phi_n^N \tilde{\eta}_{\nu_1}^g) \\ \times (e_i^{\nu_1(g), \lambda_1 \mu_1} u_g^{\nu_1} \boxtimes \overline{\tilde{u}_g^{\nu_2} \tilde{e}_j^{\nu_2(g), \lambda_2 \mu_2}})$$

by Lemma 4.11, the cyclicity of the trace and the Fourier expansion in the basis  $\{\phi_{n'}^N\}_{n'}$ . On the other hand, we have

$$(z_g \otimes z_g)^g \Delta \\ = \bigoplus_{L, M, N} \sum_{\nu', m', i, j} \frac{d_{\lambda_2} d_{\mu_2}}{d_{\nu_2} d_{\lambda_1} d_{\mu_1} d_{\nu_1}} \\ \times \operatorname{Tr}(\alpha_A^{G+}(\tilde{u}_g^{\lambda_1(g^{-1})}) \tilde{\phi}_i^L \alpha_A^{G-}(u_g^{\lambda_2(g^{-1})}) \tilde{\eta}_{\lambda_2(g^{-1})}^{g-1} {}^g \phi_{\nu'}^{L(g^{-1})} \tilde{\eta}_{\lambda_1(g^{-1})}^g) \\ \times \operatorname{Tr}(\alpha_A^{G+}(\tilde{u}_g^{\mu_1(g^{-1})}) \tilde{\phi}_m^M \alpha_A^{G-}(u_g^{\mu_2(g^{-1})}) \tilde{\eta}_{\mu_2(g^{-1})}^{g-1} {}^g \phi_{m'}^{M(g^{-1})} \tilde{\eta}_{\mu_1(g^{-1})}^g) \\ \times \operatorname{Tr}(\alpha_A^{G+}(\tilde{e}_j^{\nu_1, \lambda_1(g^{-1})} \mu_1(g^{-1})) (\tilde{\phi}_{\nu'}^{L(g^{-1})} \otimes \tilde{\phi}_{m'}^{M(g^{-1})}) \alpha_A^{G-}(e_j^{\nu_2, \lambda_2(g^{-1})} \mu_2(g^{-1})) \phi_n^N) \\ \times (u_g^{\lambda_1(g^{-1})} \otimes u_g^{\mu_1(g^{-1})}) {}^g e_i^{\nu_1, \lambda_1(g^{-1})} \mu_1(g^{-1}) \boxtimes \overline{{}^g \tilde{e}_j^{\nu_2, \lambda_2(g^{-1})} \mu_2(g^{-1})} (\tilde{u}_g^{\lambda_2(g^{-1})} \otimes \tilde{u}_g^{\mu_2(g^{-1})})$$

by  $\partial \mu_1 = \partial \mu_2$  and Lemmata 4.11 and 4.12. Since  $\tilde{\eta}^g$  is monoidal by the proof of Proposition 3.8 and

$${}^g \alpha_A^{G+}(\tilde{e}_j^{\nu_1, \lambda_1(g^{-1})} \mu_1(g^{-1})) \tilde{\eta}_{\lambda_1(g^{-1}) \mu_1(g^{-1})}^g = \tilde{\eta}_{\nu_1}^g \alpha_A^{G+}({}^g \tilde{e}_j^{\nu_1, \lambda_1(g^{-1})} \mu_1(g^{-1})) \\ \tilde{\eta}_{\lambda_2(g^{-1}) \mu_2(g^{-1})}^{g-1} {}^g \alpha_A^{G-}(e_j^{\nu_2, \lambda_2(g^{-1})} \mu_2(g^{-1})) = \alpha_A^{G-}({}^g e_j^{\nu_2, \lambda_2(g^{-1})} \mu_2(g^{-1})) \tilde{\eta}_{\nu_2}^{g-1}$$

by definition, we obtain

$$\begin{aligned}
& (z_g \otimes z_g)^g \Delta \\
&= \bigoplus_{L,M,N} \sum_{i,j} \frac{d_{\lambda_2} d_{\mu_2}}{d_{\nu_2} d_{\nu_1}} \\
&\quad \times \text{Tr}(\alpha_A^{G+}(g \tilde{e}_j^{\nu_1, \lambda_1(g^{-1}) \mu_1(g^{-1})}) (\tilde{u}_g^{\lambda_1(g^{-1})} \otimes \tilde{u}_g^{\mu_1(g^{-1})})) (\tilde{\phi}_l^L \otimes \tilde{\phi}_m^M) \\
&\quad \alpha_A^{G-}((u_g^{\lambda_2(g^{-1})} \otimes u_g^{\mu_2(g^{-1})}) g e_j^{\nu_2, \lambda_2(g^{-1}) \mu_2(g^{-1})}) \tilde{\eta}_{\nu_2}^{g-1} g \phi_n^N \tilde{\eta}_{\nu_1}^g) \\
&\quad \times (u_g^{\lambda_1(g^{-1})} \otimes u_g^{\mu_1(g^{-1})}) g e_i^{\nu_1, \lambda_1(g^{-1}) \mu_1(g^{-1})} \overline{\boxtimes} g \tilde{e}_j^{\nu_2, \lambda_2(g^{-1}) \mu_2(g^{-1})} (\tilde{u}_g^{\lambda_2(g^{-1})} \otimes \tilde{u}_g^{\mu_2(g^{-1})})
\end{aligned}$$

by the cyclicity of the trace and the Fourier expansion in these bases  $\{\phi_{l'}^{L(g^{-1})}\}_{l'}$  and  $\{\phi_{m'}^{M(g^{-1})}\}_{m'}$ . Then, comparing the orthonormal bases

$$\{e_i^{\nu_k(g), \lambda_k \mu_k} u_g^{\nu_k}\}_i \quad \text{and} \quad \{(u_g^{\lambda_k(g^{-1})} \otimes u_g^{\mu_k(g^{-1})}) g e_i^{\nu_k, \lambda_k(g^{-1}) \mu_k(g^{-1})}\}_i$$

of  $\text{Hom}({}^g \nu_k, \lambda_k \mu_k)$  for  $k = 1, 2$ , we obtain the conclusion. We can similarly show  $z_g m = m(z_g \otimes z_g)$ . Thus,  $\Theta_\alpha^G(A)$  is a  $G$ -equivariant Frobenius algebra. We can similarly prove the statements for  $\mathcal{Q}$ -systems just by taking bases to be orthonormal and replacing dual bases by  $*$ -conjugated bases.  $\square$

Next, we show that  $\Theta_\alpha^G(A)$  satisfies the  $G$ -equivariant version of commutativity.

**Definition 4.15.** Let  $\mathcal{C}$  be a  $G$ -braided multitensor category  $\mathcal{C}$ . Then, a  $G$ -equivariant algebra  $A$  in  $\mathcal{C}$  is  $G$ -commutative if the equation in Figure 41 holds. Similarly, when  $A$  is a  $G$ -equivariant Frobenius algebra, it is  $G$ -cocommutative if the equation in Figure 42 holds.

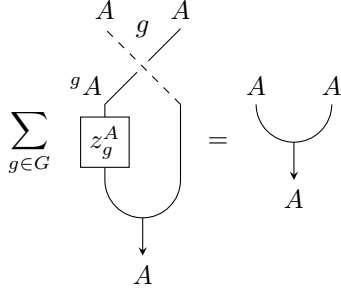

Figure 41:  $G$ -commutativity

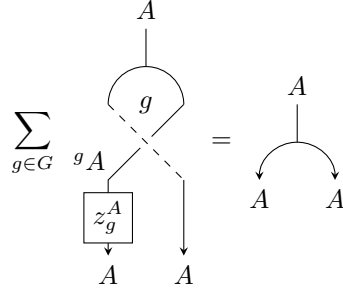

Figure 42:  $G$ -cocommutativity

**Lemma 4.16.** Let  $A$  be a neutral special  $G$ -equivariant Frobenius algebra in a  $G$ -braided multitensor category  $\mathcal{C}$ . Let  $\lambda, \lambda' \in \text{Obj}(\mathcal{C}_g)$  and  $\mu, \mu' \in \text{Obj}(\mathcal{C})$ . Then, for  $f \in \text{Hom}(\alpha_A^{G+}(\lambda), \alpha_A^{G-}(\lambda'))$  and  $f' \in \text{Hom}(\alpha_A^{G+}(\mu), \alpha_A^{G-}(\mu'))$ , we have

$$\begin{aligned}
(\text{id}_A \otimes_C b_{\lambda', \mu'}^{\mathcal{C}})(f \otimes_A f') &= (\tilde{\eta}_{\mu'}^{g-1} f' \tilde{\eta}_\mu^g \otimes_A f)(\text{id}_A \otimes_C b_{\lambda, \mu}^{\mathcal{C}}) \\
(f \otimes_A f')(\text{id}_A \otimes_C b_{\mu, \lambda}^{\mathcal{C}-}) &= (\text{id}_A \otimes_C b_{\mu', \lambda'}^{\mathcal{C}-})(\tilde{\eta}_{\mu'}^{g-1} f' \tilde{\eta}_\mu^g \otimes_A f),
\end{aligned}$$

where  $\tilde{\eta}_\lambda^g := z_g^{A-1} \otimes_C \text{id}_{g\lambda}$ .

*Proof.* The statement for  $b^{\mathcal{C}-}$  follows from the graphical calculations in Figure 43, where  $z := z^A$ . We used the right  $A$ -modularity of  $f$  and the left  $A$ -modularity of  $\tilde{\eta}_{\mu'}^{g-1} f' \tilde{\eta}_\mu^g$  respectively at the second and third equalities in the upper equation. We used the left  $A$ -modularity of  $f$  and the right  $A$ -modularity of  $\tilde{\eta}_{\mu'}^{g-1} f' \tilde{\eta}_\mu^g$  respectively at the second and third equalities in the lower equation. The proof for  $b^{\mathcal{C}}$  is similar.  $\square$

**Lemma 4.17.** Let  $\mathcal{C}$  be a  $G$ -braided multitensor category. Then,  $\overline{b_{\mu, \lambda}^{\mathcal{C}-}} = b_{\lambda^\vee, \mu^\vee}^{\mathcal{C}-}$  for any  $\lambda, \mu \in \text{Homog}(\mathcal{C})$ .

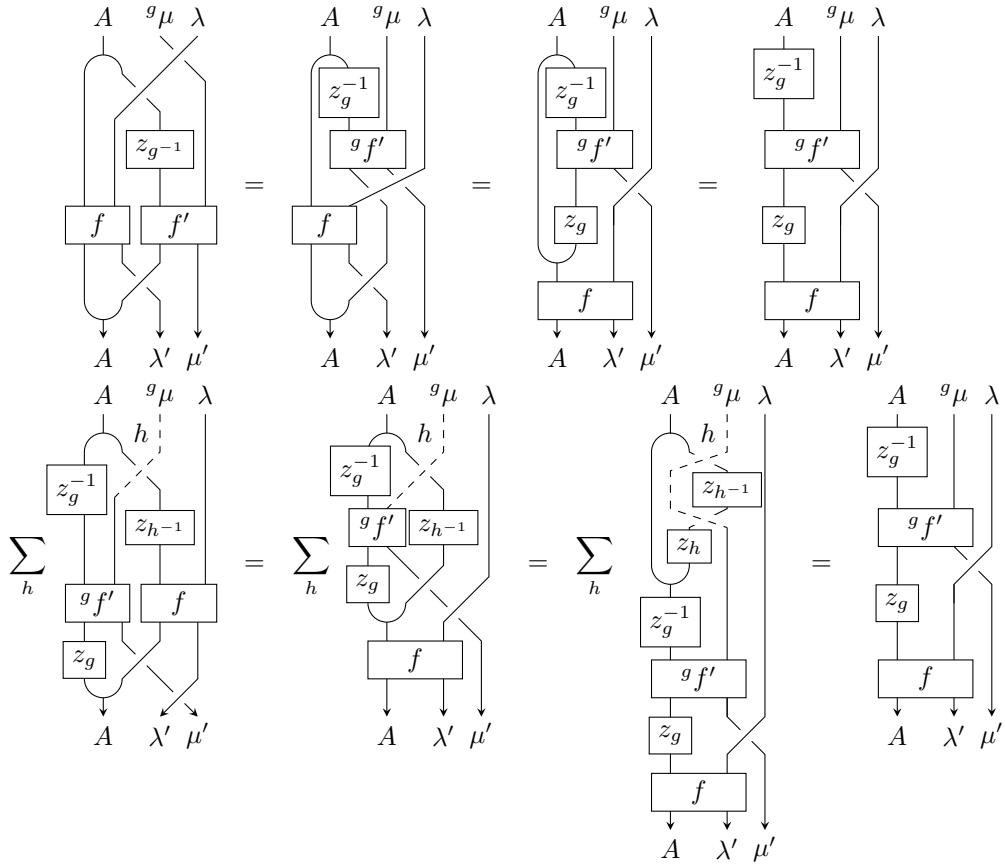

Figure 43: A crossing and equivariant  $\alpha$ -induction

*Proof.* The statement follows from the graphical calculation in Figure 44.  $\square$

**Proposition 4.18.** Let  $A$  be a neutral symmetric special simple  $G$ -equivariant Frobenius algebra in a split  $G$ -braided fusion category  $\mathcal{C}$ . Then, the  $G$ -equivariant  $\alpha$ -induction Frobenius algebra  $\Theta_\alpha^G(A)$  associated with  $A$  is  $G$ -commutative and  $G$ -cocommutative.

*Proof.* Let us follow the notation in Theorem 4.14. We only show cocommutativity because the proof of commutativity is similar. First, note that  $\theta = \bigoplus_{g \in G} \bigoplus_{L, \partial \lambda_1 = g} \lambda_1 \boxtimes \lambda_2^\vee$  is a homogeneous

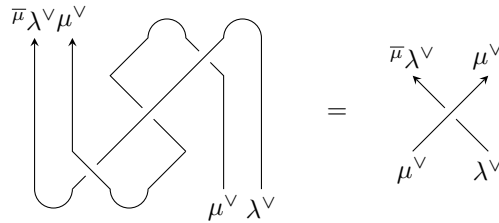

Figure 44: The conjugation of a reverse crossing



decomposition. Therefore, the left-hand side of Figure 42 for  $\theta$  is given by

$$\begin{aligned} & \bigoplus_{L,M,N} \sum_{l',i,j} \frac{d_{\lambda_2} d_{\mu_2}}{d_{\nu_2} d_{\lambda_1} d_{\nu_1}} \text{Tr}(\alpha_A^{G+}(\tilde{u}_{\partial\mu_1}^{\lambda_1(\partial\bar{\mu}_1)}) \tilde{\phi}_l^L \alpha_A^{G-}(u_{\partial\mu_1}^{\lambda_2(\partial\bar{\mu}_1)}) \tilde{\eta}_{\lambda_2(\partial\bar{\mu}_1)}^{\partial\mu_1-1} \mu_1 \phi_{l'}^L(\partial\bar{\mu}_1) \tilde{\eta}_{\lambda_1(\partial\bar{\mu}_1)}^{\partial\mu_1}) \\ & \times \text{Tr}(\alpha_A^{G+}(\tilde{e}_i^{\nu_1, \mu_1(\lambda_1(\partial\bar{\mu}_1))}) (\tilde{\phi}_m^M \otimes \tilde{\phi}_{l'}^L(\partial\bar{\mu}_1)) \alpha_A^{G-}(e_j^{\nu_2, \mu_2(\lambda_2(\partial\bar{\mu}_1))}) \phi_n^N) \\ & \times ((u_{\partial\mu_1}^{\lambda_1(\partial\bar{\mu}_1)} \otimes \text{id}_{\mu_1}) b_{\mu_1, \lambda_1(\partial\bar{\mu}_1)}^C e_i^{\nu_1, \mu_1(\lambda_1(\partial\bar{\mu}_1))} \boxtimes \overline{e_j^{\nu_2, \mu_2(\lambda_2(\partial\bar{\mu}_1))} b_{\lambda_2(\partial\bar{\mu}_1), \mu_2}^{C-} (\tilde{u}_{\partial\mu_1}^{\lambda_2(\partial\bar{\mu}_1)} \otimes \text{id}_{\mu_2})}) \end{aligned}$$

by  $\partial\mu_1 = \partial\mu_2$ ,  $\partial\lambda_1(\partial\bar{\mu}_1) = \partial\lambda_2(\partial\bar{\mu}_1)$  and Lemmata 4.11, 4.12 and 4.17. By the cyclicity of the trace and the Fourier expansion in the basis  $\{\tilde{\phi}_{l'}^L(\partial\bar{\mu}_1)\}_{l'}$ , we get

$$\begin{aligned} & \sum_{l'} \frac{1}{d_{\lambda_1}} \text{Tr}(\alpha_A^{G+}(\tilde{u}_{\partial\mu_1}^{\lambda_1(\partial\bar{\mu}_1)}) \tilde{\phi}_l^L \alpha_A^{G-}(u_{\partial\mu_1}^{\lambda_2(\partial\bar{\mu}_1)}) \tilde{\eta}_{\lambda_2(\partial\bar{\mu}_1)}^{\partial\mu_1-1} \mu_1 \phi_{l'}^L(\partial\bar{\mu}_1) \tilde{\eta}_{\lambda_1(\partial\bar{\mu}_1)}^{\partial\mu_1}) \\ & \quad \times \text{Tr}(\alpha_A^{G+}(\tilde{e}_i^{\nu_1, \mu_1(\lambda_1(\partial\bar{\mu}_1))}) (\tilde{\phi}_m^M \otimes \tilde{\phi}_{l'}^L(\partial\bar{\mu}_1)) \alpha_A^{G-}(e_j^{\nu_2, \mu_2(\lambda_2(\partial\bar{\mu}_1))}) \phi_n^N) \\ & = \text{Tr}(\alpha_A^{G+}(\tilde{e}_i^{\nu_1, \mu_1(\lambda_1(\partial\bar{\mu}_1))}) (\tilde{\phi}_m^M \otimes \bar{\mu}_1 (\tilde{\eta}_{\lambda_1(\partial\bar{\mu}_1)}^{\partial\mu_1} \alpha_A^{G+}(\tilde{u}_{\partial\mu_1}^{\lambda_1(\partial\bar{\mu}_1)}) \tilde{\phi}_l^L \alpha_A^{G-}(u_{\partial\mu_1}^{\lambda_2(\partial\bar{\mu}_1)}) \tilde{\eta}_{\lambda_2(\partial\bar{\mu}_1)}^{\partial\mu_1-1})) \\ & \quad \alpha_A^{G-}(e_j^{\nu_2, \mu_2(\lambda_2(\partial\bar{\mu}_1))}) \phi_n^N). \end{aligned}$$

Then, since

$$\begin{aligned} & (\tilde{\phi}_m^M \otimes \bar{\mu}_1 (\tilde{\eta}_{\lambda_1(\partial\bar{\mu}_1)}^{\partial\mu_1} \alpha_A^{G+}(\tilde{u}_{\partial\mu_1}^{\lambda_1(\partial\bar{\mu}_1)}) \tilde{\phi}_l^L \alpha_A^{G-}(u_{\partial\mu_1}^{\lambda_2(\partial\bar{\mu}_1)}) \tilde{\eta}_{\lambda_2(\partial\bar{\mu}_1)}^{\partial\mu_1-1})) \alpha_A^{G-}(b_{\lambda_2(\partial\bar{\mu}_1), \mu_2}^{C-}) \\ & = \alpha_A^{G+}(b_{\lambda_1(\partial\bar{\mu}_1), \mu_1}^{C-}) ((\alpha_A^{G+}(\tilde{u}_{\partial\mu_1}^{\lambda_1(\partial\bar{\mu}_1)}) \tilde{\phi}_l^L \alpha_A^{G-}(u_{\partial\mu_1}^{\lambda_2(\partial\bar{\mu}_1)})) \otimes \tilde{\phi}_m^M) \end{aligned}$$

by  $\partial\mu_1 = \partial\mu_2$  and Lemma 4.16, the left hand side of Figure 42 is equal to

$$\begin{aligned} & \bigoplus_{L,M,N} \sum_{i,j} \frac{d_{\lambda_2} d_{\mu_2}}{d_{\nu_2} d_{\nu_1}} \text{Tr}(\alpha_A^{G+}(\tilde{e}_i^{\nu_1, \mu_1 \lambda_1(\partial\bar{\mu}_1)}) b_{\lambda_1(\partial\bar{\mu}_1), \mu_1}^{C-} (\tilde{u}_{\partial\mu_1}^{\lambda_1(\partial\bar{\mu}_1)} \otimes \text{id}_{\mu_1})) (\tilde{\phi}_l^L \otimes \tilde{\phi}_m^M) \\ & \quad \alpha_A^{G-}((u_{\partial\mu_1}^{\lambda_2(\partial\bar{\mu}_1)} \otimes \text{id}_{\mu_2}) b_{\mu_2, \lambda_2(\partial\bar{\mu}_1)}^C e_j^{\nu_2, \mu_2 \lambda_2(\partial\bar{\mu}_1)}) \phi_n^N) \\ & \quad \times ((u_{\partial\mu_1}^{\lambda_1(\partial\bar{\mu}_1)} \otimes \text{id}_{\mu_1}) b_{\mu_1, \lambda_1(\partial\bar{\mu}_1)}^C e_i^{\nu_1, \mu_1 \lambda_1(\partial\bar{\mu}_1)} \boxtimes \overline{e_j^{\nu_2, \mu_2(\lambda_2(\partial\bar{\mu}_1))} b_{\lambda_2(\partial\bar{\mu}_1), \mu_2}^{C-} (\tilde{u}_{\partial\mu_1}^{\lambda_2(\partial\bar{\mu}_1)} \otimes \text{id}_{\mu_2})}), \end{aligned}$$

which is equal to  $x$  since  $\{(u_{\partial\mu_1}^{\lambda_k(\partial\bar{\mu}_1)} \otimes \text{id}_{\mu_k}) b_{\mu_k, \lambda_k(\partial\bar{\mu}_1)}^C e_i^{\nu_k, \mu_k \lambda_k(\partial\bar{\mu}_1)}\}_i$  is a basis of  $\text{Hom}(\nu_k, \lambda_k \mu_k)$  and  $\{\tilde{e}_j^{\nu_k, \mu_k(\lambda_k(\partial\bar{\mu}_1))} b_{\lambda_k(\partial\bar{\mu}_1), \mu_k}^{C-} (\tilde{u}_{\partial\mu_1}^{\lambda_k(\partial\bar{\mu}_1)} \otimes \text{id}_{\mu_k})\}_j$  is its dual basis for  $k = 1, 2$ .  $\square$

Finally, we show that  $\Theta_{\alpha}^G(A)$  is symmetric.

**Lemma 4.19.** Let  $\mathcal{C}$  be a  $G$ -braided multitensor category. Then, the identities in Figure 45, where we identified  $\lambda^\vee$  with  ${}^\vee\lambda$  using the pivotal structure of  $\mathcal{C}$ , hold for  $\lambda \in \text{Homog}(\mathcal{C})$ .

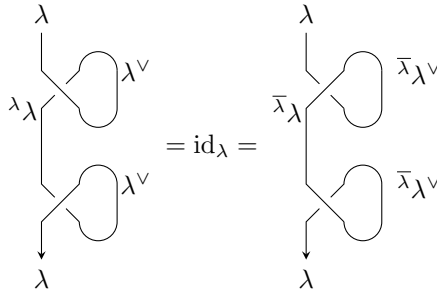

Figure 45: A Reidemeister move for a framed tangle

*Proof.* By some standard graphical calculations, we can show that the morphisms in Figure 46 give the right duality of  $\lambda$ . Then, we obtain the equations in Figure 45 as conjugate equations.  $\square$

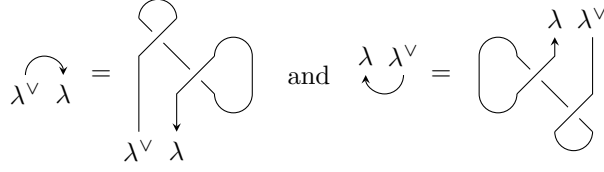

Figure 46: Right duality in a  $G$ -braided multitensor category

**Proposition 4.20.** Let  $A$  be a neutral symmetric special simple  $G$ -equivariant Frobenius algebra in a split spherical  $G$ -braided fusion category  $\mathcal{C}$ . Then,  $\Theta_\alpha^G(A)$  is symmetric.

*Proof.* Let us follow the notation in Theorem 4.14. For every  $\lambda \in I$ , let  $\bar{\lambda}$  denote the element in  $I$  with  $\bar{\lambda} = \lambda^\vee$ . Since  $\mathcal{C}$  is split by assumption,  $\text{Hom}(\mathbf{1}_{\mathcal{C}}, \mu\lambda)$  for  $\lambda, \mu \in I$  is zero if  $\mu \neq \bar{\lambda}$  and one-dimensional if  $\mu = \bar{\lambda}$ . Since  $\Theta_\alpha^G(A)$  does not depend on a choice of a basis of  $\text{Hom}(\mathbf{1}_{\mathcal{C}}, \lambda\bar{\lambda})$ , we may take it to be the right coevaluation  $\text{coev}'_{\lambda}$ . Then, the corresponding dual basis is given by  $\text{ev}_{\lambda}$ .

Now, let us calculate  $\delta_\theta^{D(\mathcal{C})}$ . By the proof of Proposition 4.1, we can take  $\theta^\vee$  to be

$$\bigoplus_L (\alpha_A^{G^+}(\lambda_1), \alpha_A^{G^-}(\lambda_2)) \bar{\lambda}_1 \boxtimes \lambda_1 \bar{\lambda}_2^{-\vee}.$$

Since  $\theta$  is a Frobenius algebra and therefore itself is a left dual, there exists a canonical isomorphism  $\theta^{\vee\vee} \cong \theta$ , which is given in Figure 47.

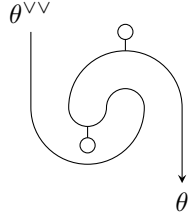

Figure 47: The canonical isomorphism  $\theta^{\vee\vee} \cong \theta$

Then, the composition of  $\delta_\theta^{D(\mathcal{C})}$  and the canonical isomorphism  $\theta^{\vee\vee} \cong \theta$  are given by

$$\bigoplus_L \sum_{l'} \text{Tr}(\alpha_A^{G^+}(\text{ev}_{\lambda_1})(\tilde{\phi}_{l'}^{\bar{L}} \otimes \tilde{\phi}_{l'}^L) \alpha_A^{G^-}(\text{coev}'_{\lambda_2})) \text{Tr}(\alpha_A^{G^-}(\text{ev}_{\lambda_2})(\phi_{l'}^{\bar{L}} \otimes \phi_{l'}^L) \alpha_A^{G^+}(\text{coev}'_{\lambda_1})) f_1^L \boxtimes f_2^L,$$

where  $\bar{L} = (\bar{\lambda}_1, \bar{\lambda}_2, l')$  and  $f_1^L \in \text{End}(\lambda_1)$  and  $f_2^L \in \text{End}(\lambda_2^\vee)$  is given in Figure 48, which are indeed identical. We used Lemma 4.19 in the proof of  $f_2^L = \text{id}_{\lambda_2^\vee}$ . The coefficient cancels as in the proof of  $\tilde{m} \circ \Delta = d_\theta$ , see the proof of [Reh00, Theorem 1.4]. Thus, we obtain  $\delta_\theta^{D(\mathcal{C})} = \text{id}_\theta$  under the canonical identification  $\theta^{\vee\vee} \cong \theta$ .  $\square$

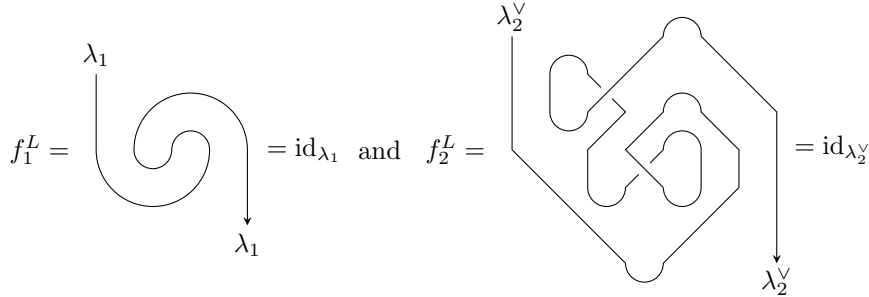

Figure 48: The proof of the symmetry of  $\Theta_\alpha^G(A)$

## 5 Equivariant full centers

Let  $A$  be a neutral symmetric special simple  $G$ -equivariant Frobenius algebra in a split spherical  $G$ -braided fusion category  $\mathcal{C}$ . For  $\lambda, \mu \in \text{Obj}(\mathcal{C})$ , we have

$$\text{Hom}(\alpha_A^{G^+}(\lambda), \alpha_A^{G^-}(\mu)) \subset \text{Hom}({}_A A \lambda, {}_A A \mu) \cong \text{Hom}_{\mathcal{C}}(\lambda, A \mu)$$

by definition, where  ${}_A A \lambda$  denotes  $A \lambda$  as a left  $A$ -module. Then, it is natural to ask if  $\Theta_{\alpha}^G(A)$  can be realized as a subalgebra of a  $G$ -equivariant Frobenius algebra with coefficients  $\langle \lambda, A \mu \rangle$ . In the case where  $G$  is trivial, it is known [BKL15, Proposition 4.18] that the answer is yes and the  $\alpha$ -induction Frobenius algebra  $\Theta_{\alpha}(A)$  is realized as the full center  $Z(A)$  [FFRS08, Definition 4.9] of  $A$ . In this section, we give the equivariant generalization of this theorem.

### 5.1 The equivariant full center of a $G$ -equivariant Frobenius algebra

In this subsection, we define the equivariant generalization of a full center (Definition 5.11). Because it is defined to be a subalgebra of a product algebra as in the case where  $G$  is trivial, we begin with products and subalgebras.

**Proposition 5.1.** Let  $A, B$  be  $G$ -equivariant Frobenius algebras in a  $G$ -braided multitensor category  $\mathcal{C}$ . Then,  $(AB, m_{AB}, \eta_A \otimes \eta_B, \Delta_{AB}, \varepsilon_A \otimes \varepsilon_B, z^A \otimes z^B)$  is a  $G$ -equivariant Frobenius algebra, where  $m_{AB}$  and  $\Delta_{AB}$  are given in Figure 49. If  $A$  and  $B$  are special (resp. symmetric), then so is  $AB$ . If  $A$  and  $B$  are Q-systems in a  $G$ -braided  $*$ -multitensor category, then  $AB$  is again a  $G$ -equivariant Q-system.

Figure 49: The positive product equivariant Frobenius algebra structure

*Proof.* By definition,  $(AB, z^{AB}) = (A, z^A)(B, z^B)$  in  $\mathcal{C}^G$  and the right-hand side induces the stated Frobenius algebra structure on the left-hand side by [FRS02, Proposition 3.22]. Therefore,  $AB$  is a Frobenius algebra. We can also give a direct proof with some graphical calculations in  $\mathcal{C}$ . It follows from the naturality of dashed crossings that  $z_g^{AB}$  is a Frobenius algebra isomorphism. The remaining statements follow easily.  $\square$

**Definition 5.2.** Let  $A$  be a  $G$ -equivariant Frobenius algebra in a  $G$ -crossed multitensor category, and let  $e$  be a Frobenius idempotent for  $A$  i.e. an idempotent in  $\text{End}_{\mathcal{C}}(A)$  that satisfies [FFRS06, Equations 2.54 and 2.55]. We say  $e$  is a  $G$ -equivariant Frobenius idempotent for  $A$  if  $e z_g^A = z_g^{Ag} e$  for every  $g \in G$ . If  $A$  is a  $G$ -equivariant Q-system in a  $G$ -crossed  $*$ -multitensor category and  $e$  is a projection, we say  $e$  is a  $G$ -equivariant Frobenius projection for  $A$ .

**Proposition 5.3.** Let  $A$  be a  $G$ -equivariant Frobenius algebra in a  $G$ -crossed multitensor category  $\mathcal{C}$  and let  $e$  be a  $G$ -equivariant Frobenius idempotent for  $A$  with a retract  $(B, s, r)$ . Then, for any nonzero scalar  $\zeta$ , the tuple  $B_{\zeta} := (B, r m_A(s \otimes s), r \eta_A, \zeta(r \otimes r) \Delta_A s, \zeta^{-1} \varepsilon_A s, \{r z_g^{Ag} s\}_g)$  is a  $G$ -equivariant Frobenius algebra. If moreover  $\mathcal{C}$  is a  $G$ -crossed  $*$ -multitensor category,  $A$  is a  $G$ -equivariant Q-system and  $e$  is a  $G$ -equivariant Frobenius projection,  $B_{\zeta}$  with  $r = s^*$  is a  $G$ -equivariant Q-system.

*Proof.* It is already known that  $B_\zeta$  is a Frobenius algebra, see the proof of [FFRS06, Proposition 2.37]. Since  $e$  is a  $G$ -equivariant Frobenius idempotent, we obtain

$$\begin{aligned} m_B(z_g^B \otimes z_g^B) &= rm_A(ez_g^{Ag}s \otimes ez_g^{Ag}s) = rez_g^{Ag}m_A({}^g s \otimes {}^g s) = rz_g^{Ag}e^g(m_A(s \otimes s)) \\ &= rz_g^{Ag}s^g(rm_A(s \otimes s)) = z_g^{Bg}m_B \\ z_g^{Bg}\eta_B &= rz_g^{Ag}(e\eta_A) = rz_g^{Ag}\eta_A = r\eta_A = \eta_B \end{aligned}$$

for every  $g \in G$ . We can similarly check  $\Delta_B z_g^B = (z_g^B \otimes z_g^B)^g \Delta_B$  and  $\varepsilon^B z_g^B = {}^g \varepsilon^B$ . Therefore  $z_g^B$  is a Frobenius algebra endomorphism of  $B$ . Moreover,

$$z_g^{Bg} r z_g^{A-1} s = rz_g^{Ag} e z_g^{A-1} s = res = \text{id}_B = {}^g r z_g^{A-1} s z_g^B$$

and therefore  $z_g^B$  is an isomorphism. Finally,

$$z_g^{Bg} z_h^B = rz_g^{Ag}(e z_h^{Ah} s) = rez_g^{Ag} z_h^{Agh} s = rz_{gh}^{Agh} s = rz_{gh}^{Agh} s = z_{gh}^B$$

for any  $g, h \in G$ , and therefore  $\{z_g^B\}_g$  gives a  $G$ -equivariant structure on  $B$ . The last statement follows from [BKLR15, Lemma 4.1] and  $z_g^{B-1} = {}^g r z_g^{A-1} s = z_g^{B*}$ .  $\square$

We do not write  $\zeta$  when it is not important.

**Proposition 5.4.** Let  $A$  be a symmetric special  $G$ -equivariant Frobenius algebra in a  $G$ -braided multitensor category  $\mathcal{C}$ . Then,  $P_A^G(\lambda) \in \text{End}(A\lambda)$  defined in Figure 50 for every  $(\lambda, z^\lambda) \in \mathcal{C}^G$  is an idempotent. Moreover,  $P_A^G := P_A^G(\mathbf{1}^{\mathcal{C}})$  is a  $G$ -equivariant Frobenius idempotent for  $A$ . When  $\mathcal{C}$  is a  $G$ -braided  $*$ -multitensor category and  $A$  is a  $Q$ -system,  $P_A^G(\lambda)$  is a projection.

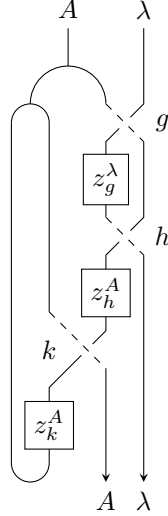

Figure 50:  $P_A^G(\lambda)$

*Proof.* First,  $P_A^{G+}(\lambda)(z_g^A \otimes z_g^\lambda) = (z_g^A \otimes z_g^\lambda)^g P_A^{G+}(\lambda)$  follows from Figure 51. Then, the remaining part of the statement follows from [FRS02, Lemma 5.2], [FFRS06, Lemma 3.10] and [BKLR15, Lemma 4.6] since  $P_A^G(\lambda) = P_{(A, z^A)}((\lambda, z^\lambda))$  in  $\mathcal{C}^G$ . We can also give a direct proof with some graphical calculations, see Figures 68 and 74 below.  $\square$

**Definition 5.5.** Let  $A$  be a symmetric special  $G$ -equivariant Frobenius algebra in a  $G$ -braided multitensor category  $\mathcal{C}$ . We call  $P_A^G$  the  $G$ -equivariant left central idempotent of  $A$ . If  $P_A^G$  is split, then we call the corresponding reduced Frobenius algebra, which is denoted by  $C^G(A)$ , the  $G$ -equivariant left center of  $A$ .

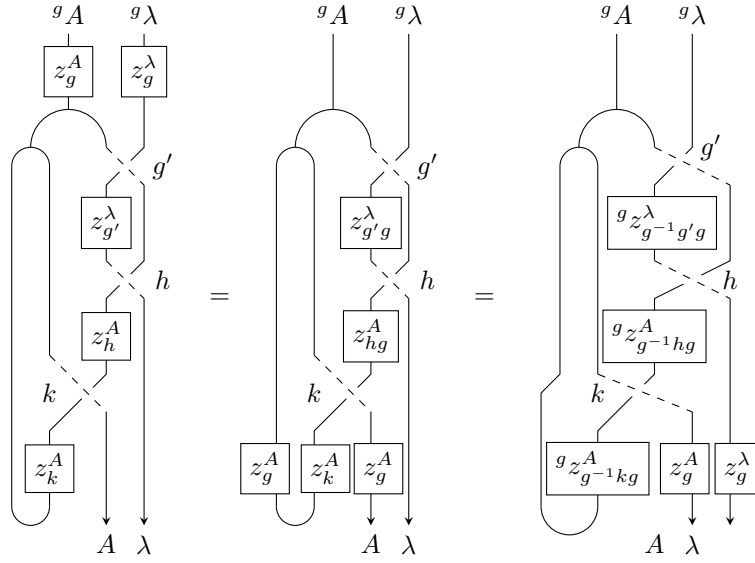

Figure 51:  $P_A^{G+}(\lambda)$  is a  $G$ -equivariant morphism

**Proposition 5.6.** Let  $A$  be a symmetric special  $G$ -equivariant Frobenius algebra in a  $G$ -braided multitensor category  $\mathcal{C}$ . Then,  $C^G(A)$  is symmetric,  $G$ -commutative and  $G$ -cocommutative. If  $A$  is simple, then so is  $C^G(A)$ .

*Proof.*  $(C^G(B), z^{C^G(B)})$  is equal to the left center  $C((B, z^B))$  since  $r$  and  $s$  can be regarded as morphisms in  $\mathcal{C}^G$  for a retract  $(C^G(B), r, s)$  by definition (see Proposition 5.3), and  $sr = P_B^G$  is  $P_{(B, z^B)}$  in  $\mathcal{C}^G$ . Then, the statement follows from [FFRS06, Proposition 2.37 (i) and (ii)].  $\square$

**Remark 5.7.** 1. We can also give the  $G$ -equivariant version of [FFRS06, Proposition 2.25(iii)]: a symmetric  $G$ -equivariant Frobenius algebra in a  $G$ -braided multitensor category is  $G$ -commutative if and only if it is  $G$ -cocommutative.

2. The specialness of  $C^G(A)$  is nontrivial in general, see [FFRS06, Proposition 2.37(iii)].

We need the following lemmata for the next subsection.

**Lemma 5.8.** For symmetric special  $G$ -equivariant Frobenius algebras  $A$  and  $B$  in a  $G$ -braided multitensor category  $\mathcal{C}$ , we have  $P_{AB}^G = P_A^G(C^G(B))$ .

*Proof.*  $P_{AB}^G$  turns into the left central idempotent  $P_{(A, z^A)(B, z^B)}$  in  $\mathcal{C}^G$ . Then, the statement follows from [FFRS06, Proposition 3.14(i)].  $\square$

**Lemma 5.9.** For a  $G$ -commutative (resp.  $G$ -cocommutative) symmetric special  $G$ -equivariant Frobenius algebra  $A$  in a  $G$ -braided multitensor category, we have  $P^G(A) = \text{id}_A$ .

*Proof.* As in the proof of Lemma 5.8, it follows from the classical result [FFRS06, Lemma 2.30] since  $(A, z^A)$  is commutative (resp. cocommutative) in  $\mathcal{C}^G$ .  $\square$

**Definition 5.10.** For a split  $G$ -braided fusion category  $\mathcal{C}$ , we call  $\Theta_{\text{LR}}^G := \Theta_\alpha^G(\mathbf{1}^\mathcal{C})$  the *Longo-Rehren  $G$ -equivariant Frobenius algebra* in  $\mathcal{C}$ .

Finally, note that for a neutral  $G$ -equivariant algebra  $A$  in a  $G$ -crossed multitensor category  $\mathcal{C}$ , the tuple  $(A \boxtimes \mathbf{1}^\mathcal{C}, m_A \boxtimes \text{id}, \eta_A \boxtimes \text{id}, \Delta_A \boxtimes \text{id}, \varepsilon_A \boxtimes \text{id}, z^A \boxtimes \text{id})$  is a  $G$ -equivariant Frobenius algebra in  $D(\mathcal{C})$ . By definition, if  $A$  is symmetric (resp. special), then so is  $A \boxtimes \mathbf{1}^\mathcal{C}$ . Then, we can give the following definition, which is what we want and is the  $G$ -equivariant version of [FFRS08, Definition 4.9].

**Definition 5.11.** Let  $A$  be a neutral symmetric special  $G$ -equivariant Frobenius algebra in a split spherical  $G$ -braided fusion category  $\mathcal{C}$  with  $\dim \mathcal{C} \neq 0$ . Then, we refer to the  $G$ -equivariant Frobenius algebra  $Z^G(A) := C^G((A \boxtimes \mathbf{1}^{\mathcal{C}}) \Theta_{\text{LR}}^G)$  in  $D(\mathcal{C})$  as the  $G$ -equivariant full center of  $A$ .

Note that we need the sphericity of  $\mathcal{C}$  and  $\dim \mathcal{C} \neq 0$  for  $\Theta_{\text{LR}}^G$  to be symmetric special and therefore for  $Z^G(A)$  to be well-defined, see Theorem 4.14 and Proposition 4.20. In particular, when  $\mathcal{C}$  is a  $G$ -braided  $*$ -fusion category, the assumption is always satisfied.

## 5.2 Equivariant $\alpha$ -induction Frobenius algebras as equivariant full centers

In this subsection, we prove the other of our main theorems (Theorem 5.24). Indeed, the proof is given as the equivariant generalization of that of [BKL15, Proposition 4.18], and for this we need to define crossings that arise from  $\alpha$ -induction as in [BEK99, Proposition 3.1].

**Lemma 5.12.** Let  $A$  be a neutral symmetric special  $G$ -equivariant Frobenius algebra in a  $G$ -braided multitensor category  $\mathcal{C}$ . Then, for  $\lambda \in \text{Obj}(\mathcal{C}_g)$  and a left  $A$ -module  $\mu$  in  $\mathcal{C}_h$ , the morphisms in Figures 52 and 53 are left  $A$ -module isomorphisms and natural in  $\lambda$  and  $\mu$ . Similarly, for a right  $A$ -module  $\rho$ , the morphisms in Figures 54 and 55 are right  $A$ -module isomorphisms and natural in  $\lambda$  and  $\rho$ . If  $\mathcal{C}$  is a  $G$ -braided  $*$ -multitensor category,  $A$  is a  $G$ -equivariant Q-system and  $\mu$  and  $\rho$  are standard, then  $B_{\lambda,\mu}^{\pm}$  and  $B_{\rho,\lambda}^{\pm}$  are unitary when we take  $s_{\alpha_A^{G^{\pm}}(\lambda),\mu}$  and  $s_{\rho,\alpha_A^{G^{\pm}}(\lambda)}$  to be isometric.

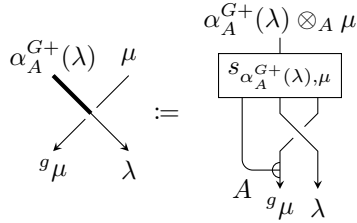

Figure 52:  $B_{\lambda,\mu}^+$

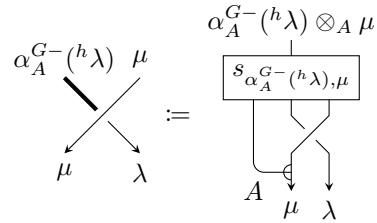

Figure 53:  $B_{\lambda,\mu}^-$

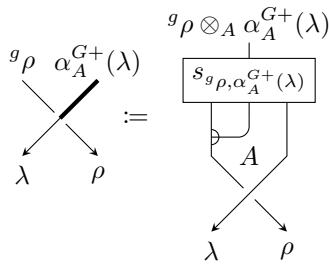

Figure 54:  $B_{\rho,\lambda}^+$

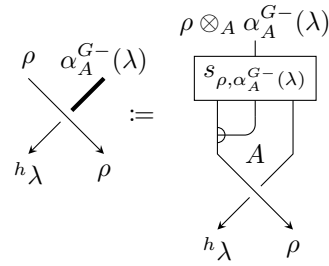

Figure 55:  $B_{\rho,\lambda}^-$

*Proof.* The naturality of the morphisms follows by definition. We only show the remaining statement for  $B_{\lambda,\mu}^+$  and  $B_{\rho,\lambda}^+$  because the proof for  $B_{\lambda,\mu}^-$  and  $B_{\rho,\lambda}^-$  can be obtained just by replacing a crossing by its reverse. The left  $A$ -modularity of  $B_{\lambda,\mu}^+$  follows from that of  $s_{\alpha_A^{G^+}(\lambda),\mu}$  and the associativity of  $g\mu$ . The morphism in Figure 56 is the left inverse of  $B_{\lambda,\mu}^+$  since  $(B_{\lambda,\mu}^+)^{-1}B_{\lambda,\mu}^+$  is equal to  $r_{\alpha_A^{G^+}(\lambda),\mu} f s_{\alpha_A^{G^+}(\lambda),\mu}$  with  $f$  given in Figure 58, where  $z := z^A$ , and is equal to  $(r_{\alpha_A^{G^+}(\lambda),\mu} \circ s_{\alpha_A^{G^+}(\lambda),\mu})^2 = \text{id}_{\alpha_A^{G^+}(\lambda) \otimes_A \mu}$  by the graphical calculation there. It is also the right inverse by Figure 59. Next, the right  $A$ -modularity of  $B_{\rho,\lambda}^+$  follows from Figure 60. Then, similarly to the argument for  $B_{\lambda,\mu}^+$ , we can show by some graphical calculations that the morphism in Figure 57 is the inverse of  $B_{\rho,\lambda}^+$ . The final statement follows from [BKL15, Lemma 3.23] and the definitions of  $(B_{\lambda,\mu}^{\pm})^{-1}$  and  $(B_{\rho,\lambda}^{\pm})^{-1}$ .  $\square$

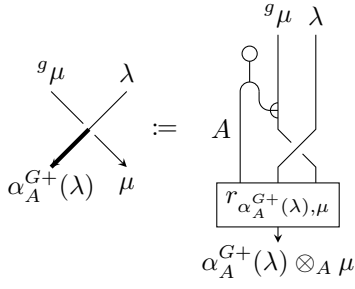

Figure 56: The inverse of  $B_{\lambda, \mu}^+$

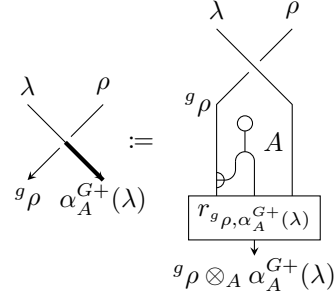

Figure 57: The inverse of  $B_{\rho, \lambda}^+$

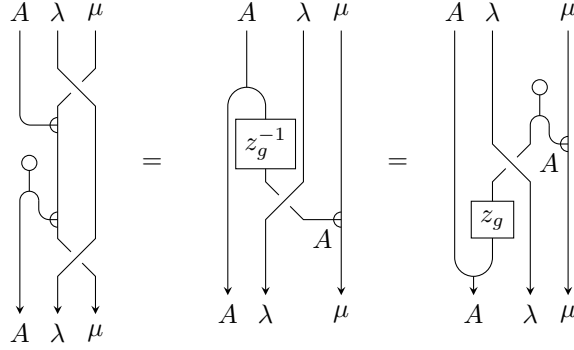

Figure 58: A proof of the left invertibility of  $B_{\lambda, \mu}^+$

We give the following lemmata for later use.

**Lemma 5.13.** Let  $A$  be a neutral symmetric special  $G$ -equivariant Frobenius algebra in a  $G$ -braided multitensor category  $\mathcal{C}$ . Then,  $B_{g\lambda, g\mu}^+ = {}^g B_{\lambda, \mu}^+(\tilde{\eta}_\lambda^g \otimes_A \text{id}_{g\mu})$  and  $B_{g\lambda, g\mu}^- = {}^g B_{\lambda, \mu}^-(g\partial\mu g^{-1} \tilde{\eta}_\lambda^g \otimes_A \text{id}_{g\mu})$ , where  $\tilde{\eta}_\lambda^g := z_g^{A-1} \otimes^{\mathcal{C}} \text{id}_{g\lambda}$ , for  $\lambda \in \text{Homog}(\mathcal{C})$ , a homogeneous left  $A$ -module  $\mu$  in  $\mathcal{C}$  and  $g \in G$ . Similarly,  $B_{g\rho, g\lambda}^+ = {}^g B_{\rho, \lambda}^+(\text{id}_{g\rho} \otimes_A \tilde{\eta}_\lambda^g)$  and  $B_{g\rho, g\lambda}^- = {}^g B_{\rho, \lambda}^-(\text{id}_{g\rho} \otimes_A \tilde{\eta}_\lambda^g)$  for a homogeneous right  $A$ -module  $\rho$  in  $\mathcal{C}$ .

*Proof.* Put  $z := z^A$ . Since  ${}^g z_\lambda^{-1} z_g^{-1} = z_{g\partial\lambda}^{-1}$ , we obtain  ${}^g B_{\lambda, \mu}^+ = B_{g\lambda, g\mu}^+(\tilde{\eta}_\lambda^g \otimes_A \text{id}_\mu)$  from the naturality of  $s$  and the definition of  $m_{\lambda, \mu}^L$ . The proof for  $B_{\rho, \lambda}^\pm$  is similar. The statement for  $B_{\lambda, \mu}^-$  follows from  $z_g^{-1} z_{g\partial\mu g^{-1}} g\partial\mu g^{-1} z_g = z_g^{-1} z_{g\partial\mu} = {}^g z_{\partial\mu}$ .  $\square$

**Lemma 5.14.** Let  $A$  be a neutral special symmetric  $G$ -equivariant Frobenius algebra in a  $G$ -braided multitensor category  $\mathcal{C}$ . Then, the equations in Figures 61 hold for  $\lambda \in \mathcal{C}_g$ , a homogeneous left  $A$ -module  $\mu$  and a homogeneous right  $A$ -module  $\rho$ .

*Proof.* We only show the first equality because the proof of the other is similar. By explicitly writing down canonical morphisms in  $\text{Frob}^G(\mathcal{C})$  as morphisms in  $\mathcal{C}$ , we find that  $r_{\alpha_A^{G^-(\mu\lambda), \mu}}$  and  $s_{\rho, \alpha_A^{G^-(\mu\lambda)}}$  in the definition of  $(B_{\lambda, \mu}^+)^{-1}$  and  $B_{\rho, \lambda}^-$  cancel. Then, the left-hand side of the first equation in Figure 61 is equal to  $(\text{id}_{\rho\mu\lambda} \otimes r_{\rho, \mu}) b_{\rho\mu, \lambda}^{\mathcal{C}}(e_{\rho, \mu} s \otimes \text{id}_\lambda) = b_{\rho \otimes_A \mu, \lambda}^{\mathcal{C}}$ .  $\square$

Thanks to this lemma, we can move an arc along a crossing as in Figure 15 when it contains a thick line segment inside. On the other hand, when thick line segments are outside an arc, we need more arguments to move the arc.

**Lemma 5.15.** Let  $A$  be a neutral symmetric special  $G$ -equivariant Frobenius algebra in a  $G$ -braided multitensor category  $\mathcal{C}$ . Then, the equations in Figure 62 hold for  $\lambda \in \text{Obj}(\mathcal{C}_g)$ , a homogeneous left  $A$ -module  $\mu$  in  $\mathcal{C}$  and a homogeneous right  $A$ -module  $\rho$  in  $\mathcal{C}$ . We also have similar equations for  $\alpha_A^{G^-}$ .

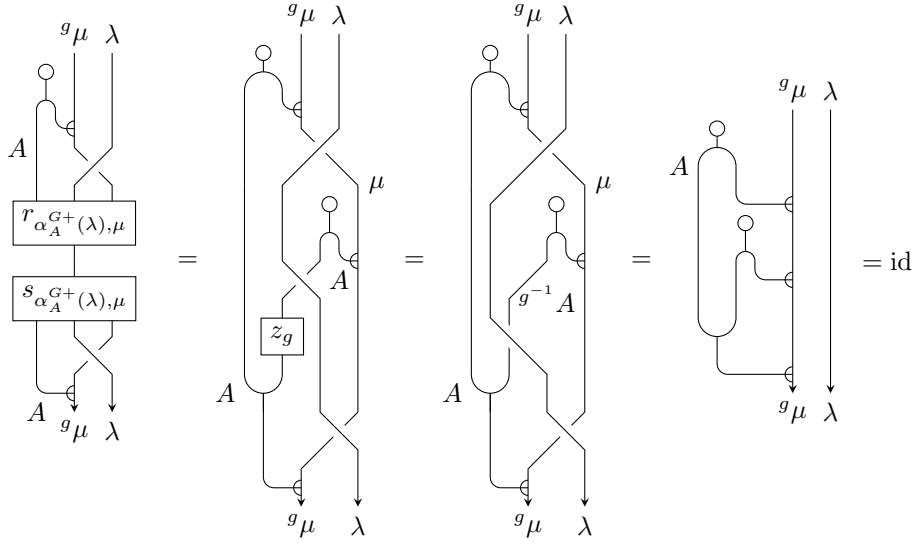

Figure 59: A proof of the right invertibility of  $B_{\lambda, \mu}^+$

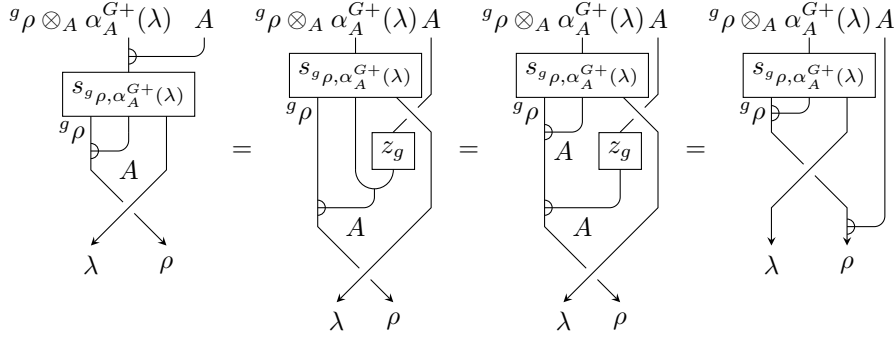

Figure 60: The right  $A$ -modularity of  $B_{\rho, \lambda}^+$

*Proof.* We only show the first equation because the proofs of other equations are similar. By explicitly writing down canonical morphisms in  $\text{Frob}^G(\mathcal{C})$  as morphisms in  $\mathcal{C}$ , we find that the left-hand and right-hand sides of the first equation in Figure 62 are equal to  $r_{g\mu^{\vee}, \alpha_A^{G^+(\lambda)}} f s_{\alpha_A^{G^+(\lambda)}, A}$  with  $f$  given respectively by the leftmost and rightmost diagrams in Figure 63, which proves the statement. Note that we used at the second equality that  $\text{coev}_\mu$  is given by Figure 29 as in the case of bimodules.  $\square$

We can also move thick arcs by the following lemma since  $\alpha_A^{G^\pm}$  are tensor functors and therefore preserve arcs.

**Lemma 5.16.** Let  $A$  be a neutral symmetric special  $G$ -equivariant Frobenius algebra in a  $G$ -braided multitensor category  $\mathcal{C}$ . Then, the equations in Figure 64 hold for  $\lambda_1 \in \text{Obj}(\mathcal{C}_{g_1})$ ,  $\lambda_2 \in$

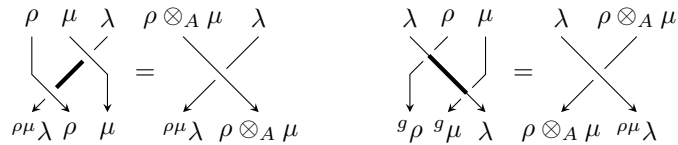

Figure 61: Thick crossings and ordinary crossings



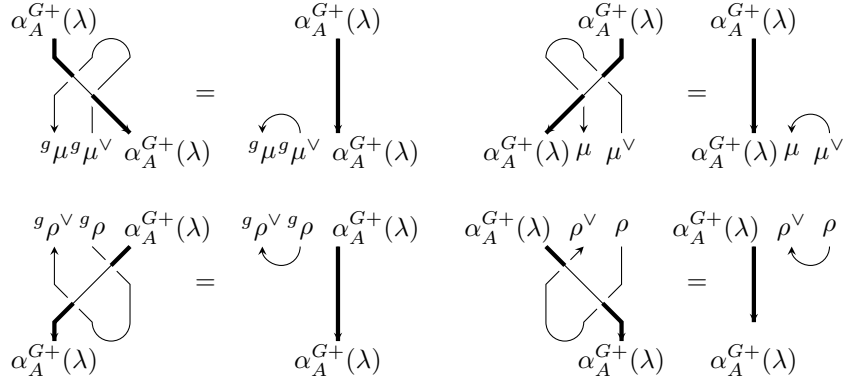

Figure 62: Arcs and thick crossings

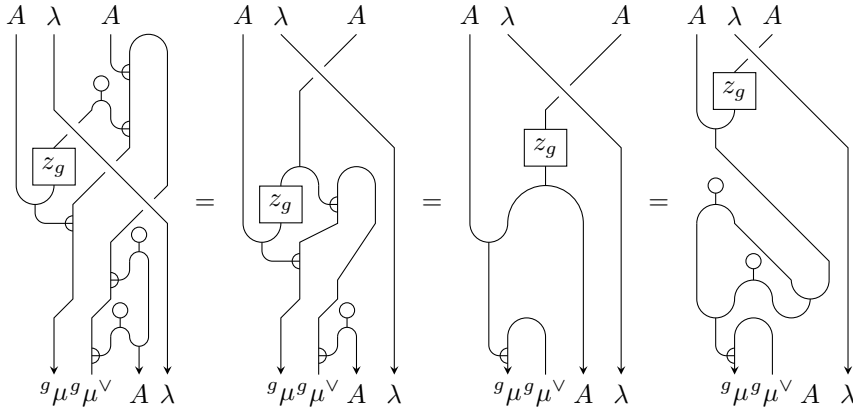

Figure 63: The proof of Figure 62

$\text{Obj}(\mathcal{C}_{g_2})$ , a homogeneous left  $A$ -module  $\mu$  in  $\mathcal{C}$  and a homogeneous right  $A$ -module  $\rho$ . Similar statements hold for  $\alpha_A^{G-}$ .

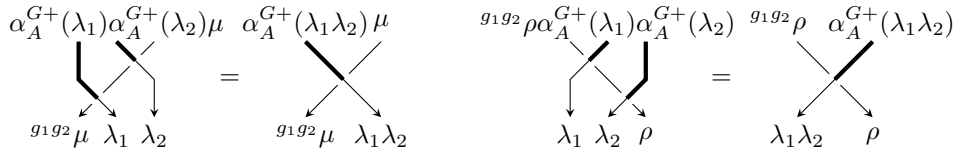

Figure 64: Thick crossings and monoidal products

*Proof.* We only show the first equation because the proofs of other equations are similar. By a similar argument to that in the proof of Lemma 5.14, we see that the left-hand side of the first equation in Figure 64 is equal to  $f(\text{id}_{A\lambda} \otimes s_{\alpha_A^{G+}(\lambda_2), \mu}) s_{\alpha_A^{G+}(\lambda_1), \alpha_A^{G+}(\lambda_2) \otimes_A \mu}$  with  $f$  given by the leftmost diagram in Figure 65, where  $z := z^A$ . On the other hand, since  $r_{\alpha_A^{G+}(\lambda_1), \alpha_A^{G+}(\lambda_2)}$  is given in Figure 33, the right-hand side of the first equation in Figure 64 is equal to  $f(\text{id}_{A\lambda} \otimes s_{\alpha_A^{G+}(\lambda_2), \mu}) s_{\alpha_A^{G+}(\lambda_1), \alpha_A^{G+}(\lambda_2) \otimes_A \mu}$  with  $f$  given by the leftmost diagram in Figure 65, which proves the statement.  $\square$

**Corollary 5.17.** Let  $A$  be a neutral symmetric special  $G$ -equivariant Frobenius algebra in a  $G$ -braided multitensor category  $\mathcal{C}$ . Then, the equations in Figure 66 hold for  $\lambda \in \text{Obj}(\mathcal{C}_g)$ , a homogeneous left  $A$ -module  $\mu$  in  $\mathcal{C}$  and a homogeneous right  $A$ -module  $\rho$ . Similar statements hold for  $\alpha_A^{G-}$ .

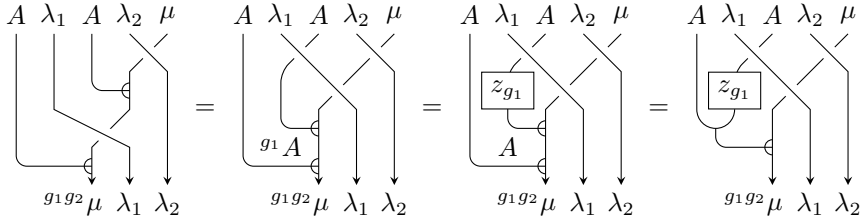

Figure 65: The proof of Figure 64

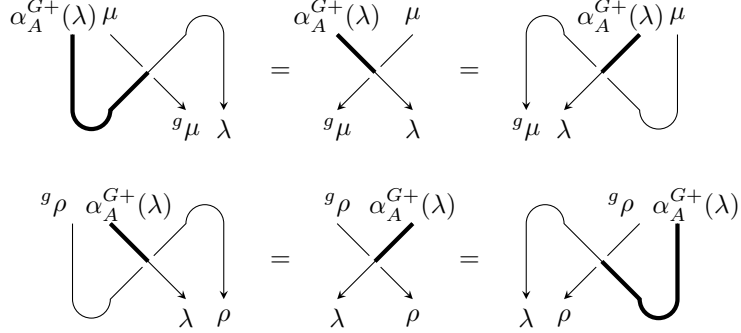

Figure 66: Rotation of thick crossings

*Proof.* The same argument as that in the proof of Lemma 2.13 works by Lemmata 5.14, 5.15 and 5.16.  $\square$

Next, we describe  $\text{Hom}(\alpha_A^{G+}(\lambda), \alpha_A^{G-}(\mu))$  as the  $G$ -equivariant version of the space of local morphisms [BKL15, Definition 4.14].

**Definition 5.18.** Let  $A$  be a neutral symmetric special  $G$ -equivariant Frobenius algebra in a  $G$ -braided multitensor category  $\mathcal{C}$ . For  $\lambda \in \text{Obj}(\mathcal{C})$ , we define a morphism  $\tilde{P}_A^G(\lambda) \in \text{End}(A\lambda)$  to be the morphism in Figure 67, where  $z := z^A$ .

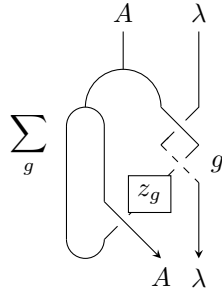

Figure 67:  $\tilde{P}_A^G(\lambda)$

**Lemma 5.19.** Let  $A$  be a neutral symmetric special  $G$ -equivariant Frobenius algebra in a  $G$ -braided multitensor category  $\mathcal{C}$ . Then,  $\tilde{P}_A^G(\lambda)$  is an idempotent for any  $\lambda \in \text{Obj}(\mathcal{C})$ .

*Proof.* The proof is similar to that of [BKLR15, Lemma 4.26]. Indeed, the statement follows from the graphical calculation in Figure 68, where we only gave calculations on equivariant structures.  $\square$

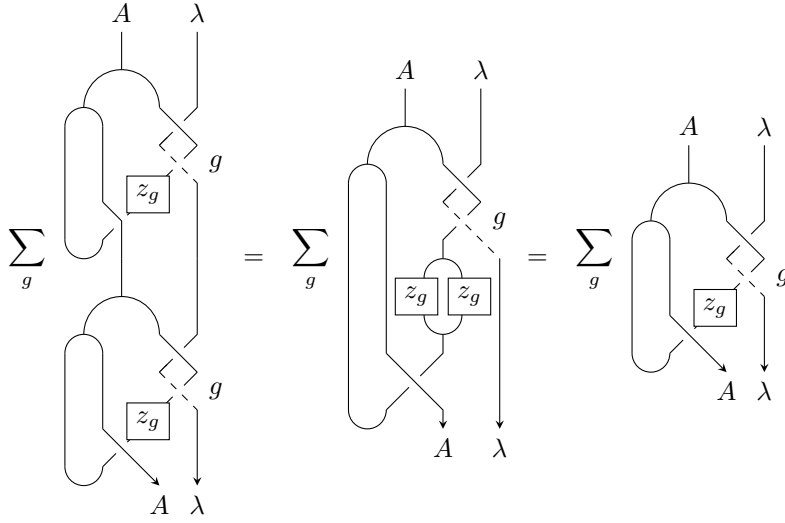

Figure 68:  $\tilde{P}_A^G(\lambda)$  is an idempotent

**Lemma 5.20.** Let  $A$  be a neutral symmetric special  $G$ -equivariant Frobenius algebra in a  $G$ -braided multitensor category  $\mathcal{C}$ . For  $\lambda, \mu \in \text{Obj}(\mathcal{C}_g)$ , define finite dimensional vector spaces

$$\text{Hom}_{\text{loc}}^G(A\lambda, \mu) := \{f \in \text{Hom}(A\lambda, \mu) \mid f \circ \tilde{P}_A^G(\lambda) = f\}$$

$$\text{Hom}_{\text{loc}}^G(\mu, A\lambda) := \{f \in \text{Hom}(\mu, A\lambda) \mid \tilde{P}_A^G(\lambda) \circ f = f\}.$$

Then,  $\text{Hom}_{\text{loc}}^G(\lambda, A\mu) \cong \text{Hom}(\alpha_A^{G+}(\lambda), \alpha_A^{G-}(\mu))$  by the map

$$I_{\lambda, \mu}^A : \text{Hom}_{\text{loc}}^G(\lambda, A\mu) \rightarrow \text{Hom}(\alpha_A^{G+}(\lambda), \alpha_A^{G-}(\mu))$$

defined in Figure 69 for  $f \in \text{Hom}_{\text{loc}}^G(\lambda, A\mu)$ . We similarly have the isomorphism

$$\tilde{I}_{\lambda, \mu}^A : \text{Hom}_{\text{loc}}^G(A\mu, \lambda) \rightarrow \text{Hom}(\alpha_A^{G-}(\mu), \alpha_A^{G+}(\lambda))$$

defined in Figure 71 for  $\tilde{f} \in \text{Hom}_{\text{loc}}^G(A\mu, \lambda)$ .

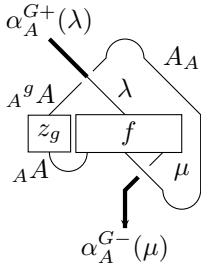

Figure 69:  $I_{\lambda, \mu}^A(f)$

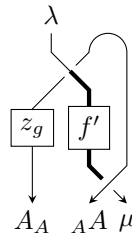

Figure 70:  $I_{\lambda, \mu}^{A-1}(f')$

*Proof.* We only show the statement for  $\text{Hom}_{\text{loc}}^G(\lambda, A\mu)$  because the proof for  $\text{Hom}_{\text{loc}}^G(A\lambda, \mu)$  is easier. We show that  $I_{\lambda, \mu}^{A-1}$  is given by the morphism in Figure 70 for  $f' \in \text{Hom}(\alpha_A^{G+}(\lambda), \alpha_A^{G-}(\mu))$ . By the graphical calculation in Figure 73, we can do a similar graphical calculation to that in the proof of [BKL15, Lemma 4.16] using Lemma 5.14 and Corollary 5.17 and see that  $I_{\lambda, \mu}^{A-1} \circ I_{\lambda, \mu}^A(f)$  is equal to the morphism in Figure 74 by the graphical calculation in Figure 73. Then, from the graphical calculation in Figure 74, where the third equality follows from a similar argument to the proof of [BKLR15, Lemma 4.26], we obtain  $I_{\lambda, \mu}^{A-1} \circ I_{\lambda, \mu}^A(f) = \tilde{P}_A^G(\lambda)f = f$ . We can also check that  $I_{\lambda, \mu}^{A-1}$  is indeed the right inverse as in the proof of [BKL15, Lemma 4.16] using Lemma 5.15 and the graphical calculation in Figure 75.  $\square$

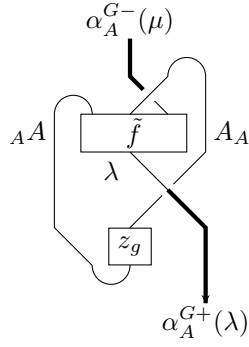

Figure 71:  $\tilde{I}_{\lambda, \mu}^A(f)$

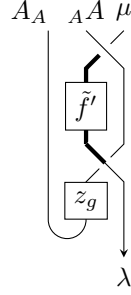

Figure 72:  $\tilde{I}_{\lambda, \mu}^{A^{-1}}(\tilde{f}')$

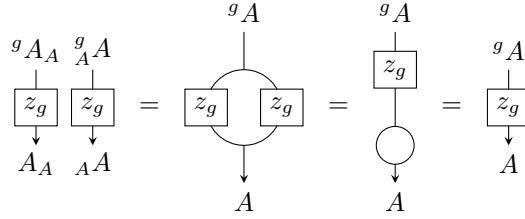

Figure 73:  $z_g \otimes_A z_g = z_g$

**Remark 5.21.** When  $\mathcal{C}$  is a  $G$ -braided  $*$ -multitensor category and  $A$  is a  $G$ -equivariant Q-system, Figure 74 with  $\lambda = A\mu$  and  $f = \text{id}_{A\mu}$  shows that  $\tilde{P}_A^{G^+}(\mu)$  is a projection as in [BKLR15, Lemma 4.26].

**Lemma 5.22.** Let  $A$  be a neutral symmetric special  $G$ -equivariant Frobenius algebra in a  $G$ -braided multitensor category  $\mathcal{C}$  and let  $\lambda, \mu \in \text{Homog}(\mathcal{C})$ . Then,  ${}^g I_{\lambda, \mu}^{A^{-1}}(f') = \tilde{\eta}_\mu^g I_{g\lambda, g\mu}^{A^{-1}}(\tilde{\eta}_\mu^{g-1g} f' \tilde{\eta}_\lambda^g)$  for  $f' \in \text{Hom}(\alpha_A^{G^+}(\lambda), \alpha_A^{G^-}(\mu))$  and  $g \in G$ .

*Proof.* Put  $z := z^A$  and  $\partial\lambda = h$ . By Lemma 5.13,  $\tilde{\eta}_\mu^{g-1g} \tilde{I}_{\lambda, \mu}^{A^{-1}}(f')$  is given by the morphism in Figure 76. Then, the graphical calculation there shows the statement. We used that  $\text{coev}_{A_A} = \eta_A$  by [Yam04, Section 5] at the first equality and  $z_g^g z_h^{ghg^{-1}} z_g^{-1} = z_g^g z_h^{gh} z_{g^{-1}} = z_{ghg^{-1}}$  at the second equality.  $\square$

**Lemma 5.23.** Let  $A$  be a neutral symmetric special  $G$ -equivariant Frobenius algebra in a  $G$ -braided multitensor category  $\mathcal{C}$  and let  $\lambda, \mu \in \text{Homog}(\mathcal{C})$ . Then, the nondegenerate pairing  $\text{Hom}(A\mu, \lambda) \times \text{Hom}(\lambda, A\mu)$  restricts to  $\text{Hom}_{\text{loc}}^G(A\mu, \lambda) \times \text{Hom}_{\text{loc}}^G(\lambda, A\mu)$ . Moreover, the maps  $I_{\lambda, \mu}^A$

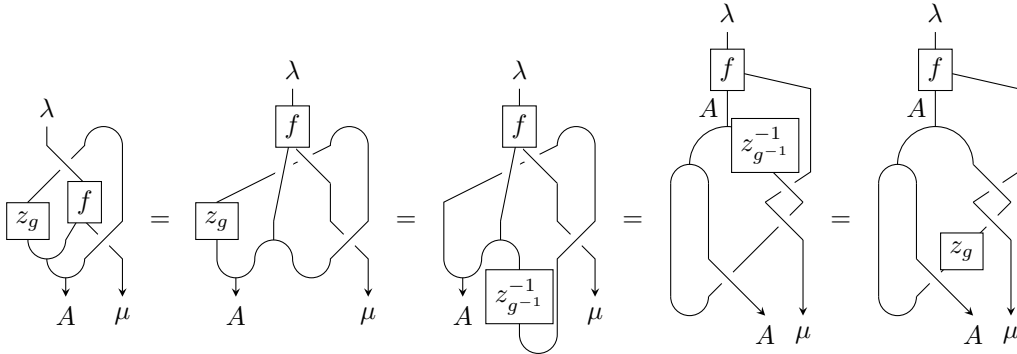

Figure 74:  $I_{\lambda, \mu}^{A^{-1}} \circ I_{\lambda, \mu}^A(f)$

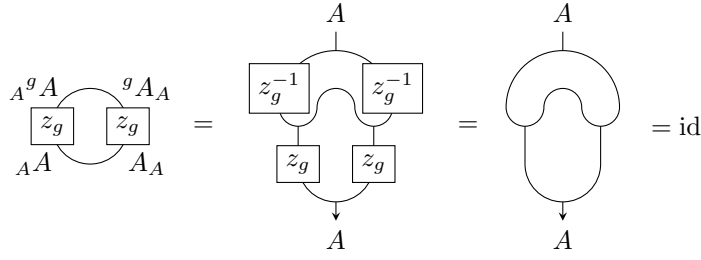

Figure 75:  $z_g \otimes z_g = \text{id}_A$

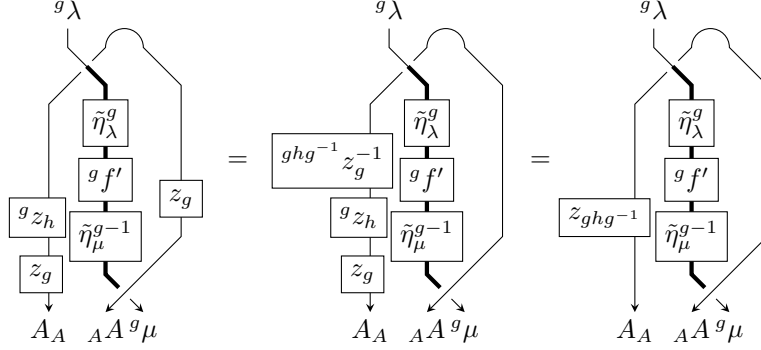

Figure 76: The proof of Lemma 5.22

and  $\tilde{I}_{\lambda, \mu}^A$  defined in Lemma 5.20 are isometric with respect to this pairing. If  $\mathcal{C}$  is a  $G$ -braided  $*$ -multitensor category and  $A$  is a  $G$ -equivariant Q-system, then they are unitary.

*Proof.* The first statement follows from Lemma 5.19. The second statement follows from a similar graphical calculation to that in the proof of [BKL15, Lemma 4.16] by Lemma 5.14. Note that  $\alpha_A^{G+}$  is pivotal and therefore preserves traces. The final statement follows from the unitarity of thick crossings.  $\square$

Finally, we can prove the other main theorem in this article, which is the equivariant generalization of [BKL15, Proposition 4.18].

**Theorem 5.24.** Let  $A$  be a neutral symmetric special simple  $G$ -equivariant Frobenius algebra in a split spherical  $G$ -braided fusion category  $\mathcal{C}$  with  $\dim \mathcal{C} \neq 0$ . Then,  $Z^G(A)_{\dim A} \cong \Theta_\alpha^G(A)$ . If  $\mathcal{C}$  is a  $G$ -braided  $*$ -multitensor category and  $A$  is a  $G$ -equivariant Q-system, then we have an isomorphism between Q-systems.

*Proof.* By Lemmata 5.8 and 5.9, we have  $P_{(A \boxtimes 1) \Theta_{LR}^G}^G = P_{A \boxtimes 1}^G(C^G(\Theta_{LR}^G)) = P_{A \boxtimes 1}^G(\Theta_{LR}^G)$  since  $\Theta_{LR}^G$  is  $G$ -commutative by Proposition 4.18. Hence, by [FFRS06, Lemma 2.4(ii)] and semisimplicity, we have

$$Z^G(A) = \bigoplus_{\lambda_1, \lambda_2 \in \Delta} \langle \lambda_1, A \lambda_2 \rangle_{\text{loc}}^G \lambda_1 \boxtimes \lambda_2^\vee$$

as objects for a complete system  $\Delta$  of representatives of the simple objects of  $\mathcal{C}$ . Hence, by Lemma 5.20,  $Z^G(A) \cong \Theta_\alpha^G(A)$  as objects.

By Lemma 5.23, we can see that for a basis  $\{\varphi_l^L\}_l$  of  $\text{Hom}_{\text{loc}}^G(\lambda_1, A \lambda_2)$  and its dual basis  $\{\tilde{\varphi}_l^L\}_l$  of  $\text{Hom}_{\text{loc}}^G(A \lambda_2, \lambda_1)$ , the morphisms  $s_{Z^G(A)} := \bigoplus_L \varphi_l^L \boxtimes \text{id}_{\lambda_2}$  and  $r_{Z^G(A)} := \bigoplus_L \tilde{\varphi}_l^L \boxtimes \text{id}_{\lambda_2}$ , where  $L := (\lambda_1, \lambda_2, l)$ , split the idempotent  $P_{A \boxtimes 1}^{G+}(\Theta_{LR}^G)$  as in [BKL15, Lemma 4.15]. Then, by a similar argument to that in the proof of [BKL15, Proposition 4.18], we can see that  $Z^G(A)_{\dim A} \cong \Theta_\alpha^G(A)$  as Frobenius algebras. Namely, their units and counits coincide up to an isomorphism by definition. In order to show the coincidence of coproducts, it suffices to calculate the quantity in Figure 77,

which is the coefficient of  $e_i^{\nu_1, \lambda_1 \mu_1} \boxtimes \overline{e_j^{\nu_2, \lambda_2 \mu_2}}$  up to  $d_A d_{\lambda_2} d_{\mu_2} / d_{\nu_2} d_{\nu_1}$ , as in the proof of [BKL15, Proposition 4.18]. Then, by the graphical calculation there, the coproducts coincide. We put  $\phi_l^L := I_{\lambda_1, \lambda_2}^A(\varphi_l^L)$  and used Lemma 5.23 at the first equality. Note that The second equality follows since the quantity is nonzero only if  $\partial \nu_1 = \partial \lambda_1 \partial \mu_1$ . The third equality follows as in the proof of [BKL15, Proposition 4.18]. The proof for products is similar.

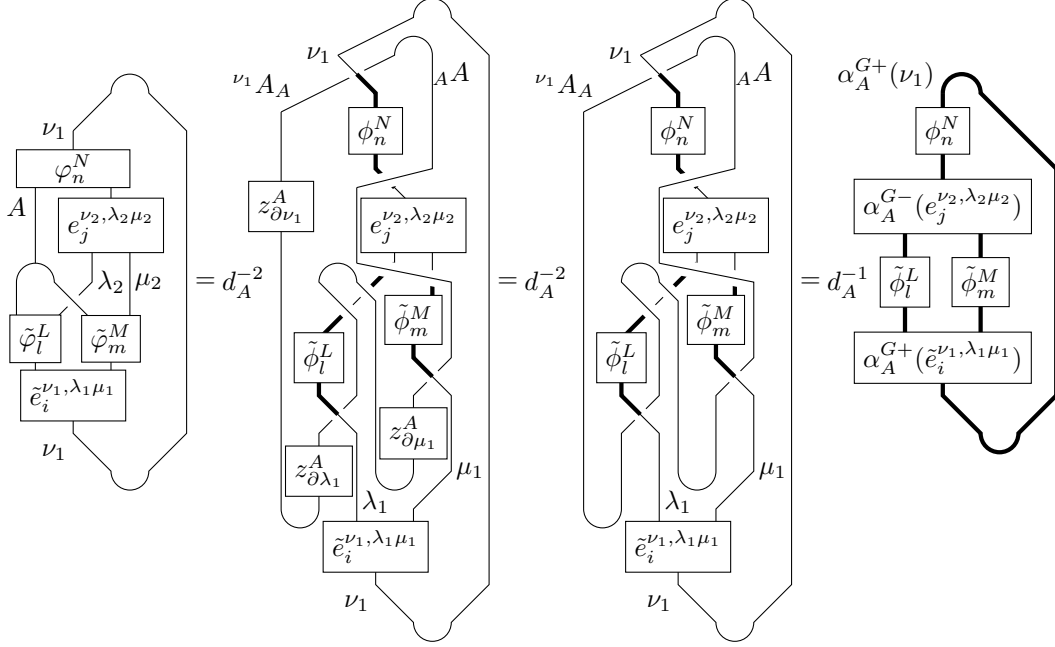

Figure 77: The coincidence of coproducts

We show that they are indeed isomorphic as  $G$ -equivariant Frobenius algebras. Since

$$z_g^{Z^G(A)} = \bigoplus_{L,m} \tilde{\varphi}_m^{L(g)}(z_g \otimes u_g^{\lambda_2})^g \varphi_l^L \boxtimes \overline{\tilde{u}_g^{\lambda_2}} = \bigoplus_{L,m} \frac{1}{d_{\lambda_1}} \text{Tr}(\tilde{u}_g^{\lambda_1} \tilde{\varphi}_m^{L(g)}(z_g \otimes u_g^{\lambda_2})^g \varphi_l^L) u_g^{\lambda_1} \boxtimes \overline{\tilde{u}_g^{\lambda_2}}$$

for  $g \in G$ . Then, the traces in coefficients are represented in Figure 78, which gives the coincidence of the equivariant structures. We used Lemma 5.22 at the first equality and  $\partial^g \lambda_1 = \partial \lambda_1(g)$  at the second equality. The final statement follows since then  $\{\phi_l^L\}_l$  is an orthonormal basis by Lemma 5.23.  $\square$

## Acknowledgements

The author thanks his supervisor Yasuyuki Kawahigashi for his constant support and advice. In particular, he thanks him for suggesting studying equivariant  $\alpha$ -induction. He thanks Roberto Longo for answering his question. He thanks Sebastiano Carpi for comments on 3. of Remark 2.17. He thanks Kan Kitamura for comments on an early draft of this article. This work was supported by RIKEN Junior Research Associate Program. He thanks their financial support.

## References

- [BE98] J. Böckenhauer and D. E. Evans. Modular invariants, graphs and  $\alpha$ -induction for nets of subfactors. I. *Comm. Math. Phys.*, 197(2):361–386, 1998.
- [BE99a] Jens Böckenhauer and David E. Evans. Modular invariants, graphs and  $\alpha$ -induction for nets of subfactors. II. *Comm. Math. Phys.*, 200(1):57–103, 1999.

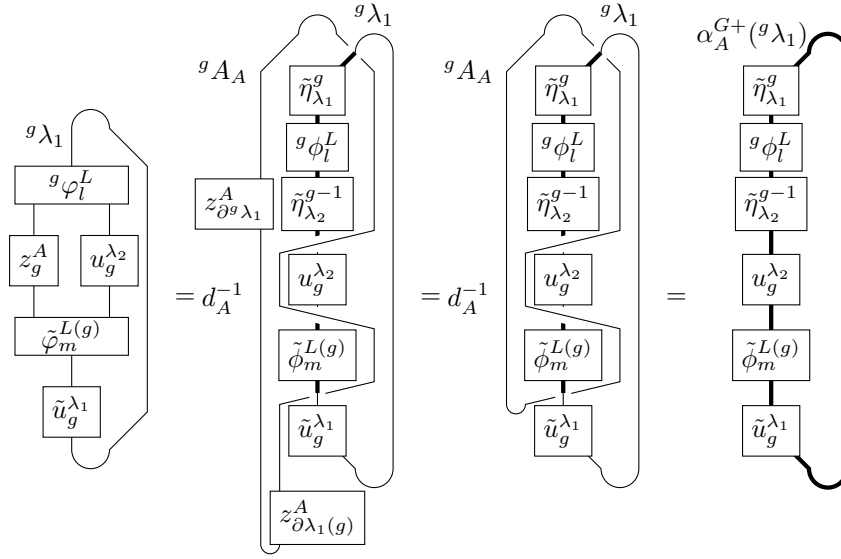

Figure 78: The coincidence of equivariant structures

- [BE99b] Jens Böckenhauer and David E. Evans. Modular invariants, graphs and  $\alpha$ -induction for nets of subfactors. III. *Comm. Math. Phys.*, 205(1):183–228, 1999.
- [BEK99] Jens Böckenhauer, David E. Evans, and Yasuyuki Kawahigashi. On  $\alpha$ -induction, chiral generators and modular invariants for subfactors. *Comm. Math. Phys.*, 208(2):429–487, 1999.
- [BEK00] Jens Böckenhauer, David E. Evans, and Yasuyuki Kawahigashi. Chiral structure of modular invariants for subfactors. *Comm. Math. Phys.*, 210(3):733–784, 2000.
- [BGM19] Eugenia Bernaschini, César Galindo, and Martín Mombelli. Group actions on 2-categories. *Manuscripta Math.*, 159(1-2):81–115, 2019.
- [BJLP19] Marcel Bischoff, Corey Jones, Yuan-Ming Lu, and David Penneys. Spontaneous symmetry breaking from anyon condensation. *J. High Energy Phys.*, 2(62):front matter+41, 2019.
- [BKL15] Marcel Bischoff, Yasuyuki Kawahigashi, and Roberto Longo. Characterization of 2D rational local conformal nets and its boundary conditions: the maximal case. *Doc. Math.*, 20:1137–1184, 2015.
- [BKLR15] Marcel Bischoff, Yasuyuki Kawahigashi, Roberto Longo, and Karl-Henning Rehren. *Tensor categories and endomorphisms of von Neumann algebras—with applications to quantum field theory*, volume 3 of *SpringerBriefs in Mathematical Physics*. Springer, Cham, 2015.
- [CIZ87] A. Cappelli, C. Itzykson, and J.B. Zuber. The A-D-E classification of minimal and  $A_1^{(1)}$  conformal invariant theories. *Comm. Math. Phys.*, 113:1–26, 1987.
- [CP22] Jonathan A Campbell and Kate Ponto. Riemann-Roch theorems in monoidal 2-categories. *arXiv preprint arXiv:2203.04351*, 2022.
- [Del90] P. Deligne. Catégories tannakiennes. In *The Grothendieck Festschrift, Vol. II*, volume 87 of *Progr. Math.*, pages 111–195. Birkhäuser Boston, Boston, MA, 1990.
- [DHR71] Sergio Doplicher, Rudolf Haag, and John E. Roberts. Local observables and particle statistics. I. *Comm. Math. Phys.*, 23:199–230, 1971.

- [DHR74] Sergio Doplicher, Rudolf Haag, and John E. Roberts. Local observables and particle statistics. II. *Comm. Math. Phys.*, 35:49–85, 1974.
- [EGNO15] Pavel Etingof, Shlomo Gelaki, Dmitri Nikshych, and Victor Ostrik. *Tensor categories*, volume 205 of *Mathematical Surveys and Monographs*. American Mathematical Society, Providence, RI, 2015.
- [FFRS06] Jürg Fröhlich, Jürgen Fuchs, Ingo Runkel, and Christoph Schweigert. Correspondences of ribbon categories. *Adv. Math.*, 199(1):192–329, 2006.
- [FFRS08] Jens Fjelstad, Jürgen Fuchs, Ingo Runkel, and Christoph Schweigert. Uniqueness of open/closed rational CFT with given algebra of open states. *Adv. Theor. Math. Phys.*, 12(6):1283–1375, 2008.
- [FRS02] Jürgen Fuchs, Ingo Runkel, and Christoph Schweigert. TFT construction of RCFT correlators. I. Partition functions. *Nuclear Phys. B*, 646(3):353–497, 2002.
- [FS03] Jürgen Fuchs and Christoph Schweigert. Category theory for conformal boundary conditions. In *Vertex operator algebras in mathematics and physics (Toronto, ON, 2000)*, volume 39 of *Fields Inst. Commun.*, pages 25–70. Amer. Math. Soc., Providence, RI, 2003.
- [Gal17] César Galindo. Coherence for monoidal  $G$ -categories and braided  $G$ -crossed categories. *J. Algebra*, 487:118–137, 2017.
- [GPS95] R. Gordon, A. J. Power, and Ross Street. Coherence for tricategories. *Mem. Amer. Math. Soc.*, 117(558):vi+81, 1995.
- [Gur13] Nick Gurski. *Coherence in three-dimensional category theory*, volume 201 of *Cambridge Tracts in Mathematics*. Cambridge University Press, Cambridge, 2013.
- [Kat87] Akishi Kato. Classification of modular invariant partition functions in two dimensions. *Modern Phys. Lett. A*, 2(8):585–600, 1987.
- [Kir04] Alexander Kirillov, Jr. On  $G$ -equivariant modular categories. *arXiv preprint math/0401119*, 2004.
- [KL04] Yasuyuki Kawahigashi and Roberto Longo. Classification of local conformal nets. Case  $c < 1$ . *Ann. of Math. (2)*, 160(2):493–522, 2004.
- [KLM01] Yasuyuki Kawahigashi, Roberto Longo, and Michael Müger. Multi-interval subfactors and modularity of representations in conformal field theory. *Comm. Math. Phys.*, 219(3):631–669, 2001.
- [KR09] Liang Kong and Ingo Runkel. Cardy algebras and sewing constraints. I. *Comm. Math. Phys.*, 292(3):871–912, 2009.
- [Lei04] Tom Leinster. *Higher operads, higher categories*, volume 298 of *London Mathematical Society Lecture Note Series*. Cambridge University Press, Cambridge, 2004.
- [LF13] Ignacio López Franco. Tensor products of finitely cocomplete and abelian categories. *J. Algebra*, 396:207–219, 2013.
- [Lon94] Roberto Longo. A duality for Hopf algebras and for subfactors. I. *Comm. Math. Phys.*, 159(1):133–150, 1994.
- [LR95] R. Longo and K.-H. Rehren. Nets of subfactors. *Rev. Math. Phys.*, 7(4):567–597, 1995. Workshop on Algebraic Quantum Field Theory and Jones Theory (Berlin, 1994).
- [LR97] R. Longo and J. E. Roberts. A theory of dimension. *K-Theory*, 11(2):103–159, 1997.



- [Müg03] Michael Müger. From subfactors to categories and topology. I. Frobenius algebras in and Morita equivalence of tensor categories. *J. Pure Appl. Algebra*, 180(1-2):81–157, 2003.
- [Müg05] Michael Müger. Conformal orbifold theories and braided crossed  $G$ -categories. *Comm. Math. Phys.*, 260(3):727–762, 2005.
- [Noj20] Ryo Nojima. On induction for twisted representations of conformal nets. *Ann. Henri Poincaré*, 21(10):3217–3251, 2020.
- [Ost03] Victor Ostrik. Module categories, weak Hopf algebras and modular invariants. *Transform. Groups*, 8(2):177–206, 2003.
- [Reh00] K.-H. Rehren. Canonical tensor product subfactors. *Comm. Math. Phys.*, 211(2):395–406, 2000.
- [Tur00] Vladimir Turaev. Homotopy field theory in dimension 3 and crossed group-categories. *arXiv preprint math/0005291*, 2000.
- [Tur16] Vladimir G. Turaev. *Quantum invariants of knots and 3-manifolds*, volume 18 of *De Gruyter Studies in Mathematics*. De Gruyter, Berlin, 2016. Third edition.
- [Yam04] Shigeru Yamagami. Frobenius algebras in tensor categories and bimodule extensions. In *Galois theory, Hopf algebras, and semiabelian categories*, volume 43 of *Fields Inst. Commun.*, pages 551–570. Amer. Math. Soc., Providence, RI, 2004.