

COURSE 11

Automata and automatic sequences

J.-P. Allouche ⁽¹⁾ and M. Mendès France ⁽²⁾

⁽¹⁾ *CNRS, LMD, Luminy Case 930,
F-13288 Marseille Cedex 9, France*

⁽²⁾ *Université Bordeaux I, Mathématiques,
351 cours de la Libération,
F-33405 Talence Cedex, France*

In the following pages we discuss infinite sequences defined on a finite alphabet, and more specially those which are generated by finite automata. We have divided our paper into seven parts which are more or less self-contained. Needless to say, we feel that the order we propose is the most natural one. References appear at the end of each one of the parts which implies some redundancy. Extra references are listed at the very end of our paper.

PART I. Introduction. Substitutions and finite automata

1. The Fibonacci sequence
2. The Prouhet-Thue-Morse sequence
3. The paperfolding sequence
4. Automatic sequences: definition; a zoo of examples. A warning
5. Where finite automata enter the picture
6. How random can an automatic sequence be?
7. Miscellanea
8. Appendix: automata generating the five examples of Paragraph 4

References

Part II. Further properties of paperfolding

1. Direct reading and reverse reading
2. Words and diagrams
3. The folding operators
4. The dimension of a curve
5. Paperfolding and continued fractions

References

Part III. Complements

1. Repetitions in infinite sequences
2. Multidimensional morphisms and (finite) automata
3. Links with cellular automata

References

Part IV. Fourier analysis

1. Fourier-Bohr coefficients
2. Bessel's inequality and Parseval's equality
3. The Wiener spectrum and the spectral measure
4. Analyzing the spectral measure
5. Appendix I: the spectral measure of the Thue-Morse sequence
6. Appendix II: the spectral measure of the paperfolding sequence

References

Part V. Complexity of infinite sequences

1. Sturmian sequences and generalizations
2. Complexity of infinite sequences

References

Part VI. Opacity of an automaton

1. Automata revisited
2. Computing the opacity

References

Part VII. The Ising automaton

1. The inhomogeneous Ising chain
2. The induced field
3. The Ising automaton
4. An ergodic property
5. Opacity of the Ising automaton

References

Part VIII. Extra references

PART I

Introduction. Substitutions and finite automata

The discovery of quasicrystals in 1984 by Shechtman et al [34] led to renewed studies of the Penrose tiling with its fivefold symmetry. In a regular Penrose tiling one can observe infinite arrays or *worms* of short and long *ties* distributed according to the Fibonacci sequence. Similar sequences, which are generated by *substitutions* (or *substitution rules*), became very popular among physicists. Instead of substitutions computer scientists rather speak of *morphisms* whereas physicists also use the term *inflation rules*.

1. THE FIBONACCI SEQUENCE

Let us first recall what the Fibonacci morphism is and how it generates the Fibonacci sequence. One starts with the *alphabet* (finite set) $\{0, 1\}$. One then considers the set $\{0, 1\}^*$ of all finite *words* on this alphabet, a finite word being a finite string (for example 0101110) which may be empty. The *concatenation* of words, consists in assembling words together one after the other, thus creating a longer word. For instance $011.1010 = 0111010$. The set $\{0, 1\}^*$ endowed with the operation of concatenation is called the *free monoid* generated by $\{0, 1\}$.

We now define the map σ on $\{0, 1\}$ by:

$$\sigma(0) = 01, \quad \sigma(1) = 0.$$

This map can be extended “morphically” to a map from $\{0, 1\}^*$ to itself, for example:

$$\sigma(0101110) = \sigma(0)\sigma(1)\sigma(0)\sigma(1)\sigma(1)\sigma(1)\sigma(0) = 0100100001.$$

The image of an infinite sequence is defined the same way.

Let us compute now the iterates of the map σ applied to the one-letter word 0:

$$\begin{aligned} \sigma(0) &= 01, \\ \sigma^2(0) &= \sigma(01) = 010, \\ \sigma^3(0) &= \sigma(010) = 01001, \\ &\dots \end{aligned}$$

The reader will have noticed that each new word begins with the previous one, which implies that the sequence of words $\sigma^n(0)$ converges to an infinite word

$$w = 0100101001001 \dots$$

called the Fibonacci sequence. This infinite word is by construction a fixed point of σ : $\sigma(w) = w$.

Note that a rule as the one above is a *growth rule* in the terminology of D. Gratias, and not a *matching rule*. A matching rule is local, but both types of rules are *drawing rules*.

That such a rule gives - or may give - a quasicrystalline structure will be discussed all along this volume. A quasicrystalline structure is defined either via the notion of quasilattices, see the contribution of Y. Meyer [26] in this volume, or via Fourier transforms. It is somewhere between periodicity and chaos (or randomness).

Note also that these morphisms are particular cases of formal grammars which were invented as toy models for the study of languages. Needless to say, computer scientists were among the first to develop the theory.

2. THE PROUHET-THUE-MORSE SEQUENCE

Let us make a (seemingly small) change in the definition of the Fibonacci morphism, and let us consider the morphism defined by:

$$0 \longrightarrow 01, \quad 1 \longrightarrow 10.$$

Iterating this morphism starting from 0 yields:

$$\begin{aligned} &0 \\ &01 \\ &0110 \\ &01101001 \\ &0110100110010110 \\ &\dots, \end{aligned}$$

hence, as previously noticed, we obtain an infinite sequence which is a fixed point of the morphism. This sequence is the celebrated Prouhet-Thue-Morse sequence, (see [29], [36], [37], [27]). The sequence is also known as the Thue-Morse sequence or the Morse sequence. We shall freely use any of these denominations.

What makes this sequence drastically different from the Fibonacci sequence is that the images of 0 and 1 have the same length, namely 2. The importance of this observation will be emphasized in two ways:

- denoting by $(u_n)_{n \in \mathbb{N}}$ the Prouhet-Thue-Morse sequence, it is not difficult to prove that $u_n = 1$ if and only if the number of 1's in the binary expansion of n is odd. Such a simple property is due to the underlying binary expansion in the morphisms of length 2. If one wants a similar arithmetic definition for the Fibonacci sequence, one should introduce the Fibonacci expansion of integers which is not as straightforward;

- write down the Fibonacci sequence in a way which emphasizes the definition as a fixed point of the morphism σ :

$$\begin{array}{cccccccc} 01 & 0 & 01 & 01 & 0 & 01 & 0 & 01 & \dots \\ 0 & 1 & 0 & 0 & 1 & 0 & 1 & 0 & \dots \end{array}$$

where each block 01 or 0 is written above the letter it originates from. This can be seen as a *renormalization* process. The constant length Prouhet-Thue-Morse morphism can be seen as a *constant renormalization* process:

$$\begin{array}{cccccccc} 01 & 10 & 10 & 01 & 10 & 01 & 01 & 10 & \dots \\ 0 & 1 & 1 & 0 & 1 & 0 & 0 & 1 & \dots \end{array}$$

3. THE PAPERFOLDING SEQUENCE

In this section we will discuss a slightly more general way of generating sequences: the morphisms will be followed by a *literal map*.

Let us exemplify this with the paperfolding sequence. This sequence can be generated by regularly folding a piece of paper onto itself and by considering, after unfolding, the sequence of folds (“mountains” and “valleys”) created on its edge (see for instance [18] and [21], see also Part II of this paper). This sequence can also be defined as follows.

Consider the alphabet $A = \{a, b, c, d\}$ and the morphism on A defined by

$$\begin{array}{l} a \longrightarrow ab \\ b \longrightarrow cb \\ c \longrightarrow ad \\ d \longrightarrow cd. \end{array}$$

This morphism admits a fixed point, obtained as usual by computing the iterates of the morphism applied to the letter a :

$$a \ b \ c \ b \ a \ d \ c \ b \ a \ b \ c \ d \ \dots$$

One then applies the *literal map* (which can be also seen as a morphism of length 1 onto a different alphabet) defined by:

$$\begin{array}{l} a \longrightarrow 1 \\ b \longrightarrow 1 \\ c \longrightarrow 0 \\ d \longrightarrow 0 \end{array}$$

thus obtaining the sequence

$$1 \ 1 \ 0 \ 1 \ 1 \ 0 \ 0 \ 1 \ 1 \ 1 \ 0 \ 0 \ \dots$$

which is the paperfolding sequence on the alphabet $\{0, 1\}$. The sequence is obtained as the projection of a fixed point of a morphism of constant length.

4. AUTOMATIC SEQUENCES: DEFINITION; A ZOO OF EXAMPLES. A WARNING

DEFINITION. Let k be an integer greater than or equal to 2. A sequence $u = (u_n)_{n \in \mathbb{N}}$ with values in the alphabet A is said k -automatic if there exists:

- an alphabet B ,
- a uniform morphism of B^* , of length k (i.e. such that the image of each letter in B is a word of length k in B^*),
- an infinite sequence with values in B , say $v = (v_n)_{n \in \mathbb{N}}$, which is a fixed point of this morphism,
- a map φ from B to A such that $\forall n \in \mathbb{N}, \varphi(v_n) = u_n$.

Examples

- 1) The Prouhet-Thue-Morse sequence defined above is a 2-automatic sequence.
- 2) The paperfolding sequence defined above is a 2-automatic sequence.
- 3) The Rudin-Shapiro sequence (see [33], [31]) can be defined as follows. Let $A = \{a, b, c, d\}$. Consider the morphism on A :

$$\begin{aligned} a &\longrightarrow ab \\ b &\longrightarrow ac \\ c &\longrightarrow db \\ d &\longrightarrow dc \end{aligned}$$

Then define $\varphi : A \rightarrow \{-1, +1\}$ by:

$$\begin{aligned} a &\longrightarrow +1 \\ b &\longrightarrow +1 \\ c &\longrightarrow -1 \\ d &\longrightarrow -1 \end{aligned}$$

The image of the fixed point of the above morphism by φ is the Rudin-Shapiro sequence

$$+1 \ +1 \ +1 \ -1 \ +1 \ +1 \ -1 \ +1 \ +1 \ +1 \ +1 \ -1 \ \dots$$

Prove that the Rudin-Shapiro sequence cannot be obtained as the image of the fixed point of a morphism (of length 2) on an alphabet with less than 4 elements.

This sequence is 2-automatic. It has been considered both by Shapiro [33] and Rudin [31] in the hope of mimicking randomness in the following sense. Consider an arbitrary sequence of +1's and -1's, say $a = (a_n)_n$, and put

$$M_N(a) = \sup_{\theta \in [0,1]} \left| \sum_{n=0}^{N-1} a_n e^{2i\pi n\theta} \right| = \left\| \sum_{n=0}^{N-1} a_n e^{2i\pi n\theta} \right\|_{\infty}.$$

Then one has:

$$\sqrt{N} = \left\| \sum_{n=0}^{N-1} a_n e^{2i\pi n\theta} \right\|_2 \leq \left\| \sum_{n=0}^{N-1} a_n e^{2i\pi n\theta} \right\|_\infty = M_N(a) \leq N,$$

where the quadratic norm is defined by:

$$\|f\|_2 = \left(\int_0^1 |f(\theta)|^2 d\theta \right)^{1/2}.$$

It is not hard to show that for a periodic (or even almost-periodic) sequence a the order of magnitude of $M_N(a)$ is actually N (check for instance this claim for the constant sequence $a_n = 1$ for all n). On the other hand it can be shown that for Lebesgue-almost all sequences a one has, when N goes to infinity:

$$M_N(a) \leq \sqrt{N \log N},$$

which can be reinterpreted by saying that, for a “random” sequence, the order of magnitude of $M_N(a)$ is between \sqrt{N} and $\sqrt{N \log N}$.

The Rudin-Shapiro sequence is an example of a clearly deterministic sequence for which one can prove the existence of a positive constant $C \leq 2 + \sqrt{2}$ such that:

$$(*) \quad M_N(a) \leq C\sqrt{N}.$$

This property of the Rudin-Shapiro sequence to simulate randomness will also be seen later on (see the contribution of M. Queffélec [30] in this volume).

Let us see how the proof of (*) works. We first show that the Rudin-Shapiro sequence $(a_n)_n$ satisfies:

$$\forall n \geq 0, a_{2n} = a_n, a_{4n+3} = -a_{2n+1}.$$

If $(u_n)_n$ is the fixed point of the above morphism on the four-letter alphabet $\{a, b, c, d\}$ the very definition of being a fixed point implies that:

$$\forall n \geq 0, u_{2n} = \alpha(u_n), u_{2n+1} = \beta(u_n),$$

where the maps α and β are defined by:

$$\begin{aligned} \alpha(a) &= a, \alpha(b) = a, \alpha(c) = d, \alpha(d) = d, \\ \beta(a) &= b, \beta(b) = c, \beta(c) = b, \beta(d) = c. \end{aligned}$$

One then notices that:

$$\varphi \circ \alpha = \varphi, \varphi \circ \beta^2 = -\varphi \circ \beta, \varphi \circ \beta \circ \alpha = \varphi.$$

Hence, $\forall n \geq 0$:

$$\begin{aligned} a_{2n} &= \varphi(u_{2n}) = \varphi\alpha(u_n) = \varphi(u_n) = a_n, \\ a_{4n+1} &= \varphi(u_{4n+1}) = \varphi\beta\alpha(u_n) = \varphi(u_n) = a_n, \\ a_{4n+3} &= \varphi(u_{4n+3}) = \varphi\beta^2(u_n) = -\varphi\beta(u_n) = -\varphi(u_{2n+1}) = -a_{2n+1}. \end{aligned}$$

For all $n \geq 0$ define the two-dimensional vector $V_n = \begin{pmatrix} a_n \\ a_{2n+1} \end{pmatrix}$. Then:

$$\forall n \geq 0, V_{2n} = M_0 V_n, V_{2n+1} = M_1 V_n,$$

where M_0 and M_1 are the 2×2 -matrices:

$$M_0 = \begin{pmatrix} 1 & 0 \\ 1 & 0 \end{pmatrix}, \quad M_1 = \begin{pmatrix} 0 & 1 \\ 0 & -1 \end{pmatrix}.$$

Now let

$$S(K, \theta) := \sum_{n=0}^{2^K-1} V_n e^{2i\pi n\theta}.$$

One has:

$$\begin{aligned} S(K+1, \theta) &= \sum_{n=0}^{2^{K+1}-1} V_n e^{2i\pi n\theta} \\ &= \sum_{n=0}^{2^K-1} V_{2n} e^{2i\pi(2n)\theta} + \sum_{n=0}^{2^K-1} V_{2n+1} e^{2i\pi(2n+1)\theta} \\ &= M(\theta) \sum_{n=0}^{2^K-1} V_n e^{2i\pi(2n)\theta} \\ &= M(\theta) S(K, 2\theta), \end{aligned}$$

where

$$M(\theta) = \begin{pmatrix} 1 & e^{2i\pi\theta} \\ 1 & -e^{2i\pi\theta} \end{pmatrix}.$$

Therefore:

$$\begin{aligned} S(K, \theta) &= M(\theta) M(2\theta) \cdots M(2^{K-1}\theta) S(0, 2^K\theta) \\ &= M(\theta) M(2\theta) \cdots M(2^{K-1}\theta) \begin{pmatrix} 1 \\ 1 \end{pmatrix}. \end{aligned}$$

Hence, taking the L^2 -norm:

$$\|S(K, \theta)\|_2 \leq \sqrt{2} \prod_{j=0}^{K-1} \|M(2^j\theta)\|_2.$$

But the L^2 -norm of a matrix $M = \begin{pmatrix} 1 & z \\ 1 & -z \end{pmatrix}$, where z is a complex number of modulus 1 is easy to compute: this is the square root of the spectral radius of the matrix $\overline{M}M = \begin{pmatrix} 2 & 0 \\ 0 & 2 \end{pmatrix}$, hence $\|M\|_2 = \sqrt{2}$. Thus for all θ :

$$\left| \sum_{n=0}^{2^K-1} a_n e^{2i\pi n\theta} \right| \leq \|S(K, \theta)\|_2 \leq \sqrt{2} 2^{K/2}.$$

In other words the inequality $M_N(\theta) \leq C\sqrt{N}$ holds if N is a power of 2 with $C = \sqrt{2}$. It is then possible to extend the inequality to arbitrary N provided the value $C = \sqrt{2}$ is replaced by $C = 2 + \sqrt{2}$.

- 4) The period-doubling sequence occurs when iterating a map of the unit interval. Consider a one-parameter family of unimodal maps showing a Feigenbaum cascade. Choose the value of the parameter where the “chaos” begins. Then the kneading sequence of the point where the function has its maximum is universal (even in cases where the Feigenbaum constant is not obtained) and equal to the period-doubling sequence. For a general reference on this subject see [15] and the included bibliography. This sequence can be defined as the fixed point of the morphism

$$\begin{aligned} 0 &\longrightarrow 01 \\ 1 &\longrightarrow 00; \end{aligned}$$

it is therefore a 2-automatic sequence. Note that this sequence is actually connected with the Thue-Morse sequence (see [5], this seems also to be implicit from reading between the lines in [24]).

- 5) The Hanoi sequence underlies the game known as the Towers of Hanoi. In this puzzle there are three pegs and N disks of increasing diameters. At the beginning all the disks are stacked on the first peg in increasing order, the topmost being the one with the smallest diameter. Then, at each step, one may take a disk on the top of a peg and put it on another peg provided that it is never stacked on a smaller disk. The game ends when all the disks are on a new peg (necessarily in increasing order). Denote by a, b, c the moves consisting in taking the topmost disk from peg I, (resp. peg II, III), and putting it on peg II, (resp. III, I), and by $\bar{a}, \bar{b}, \bar{c}$ the inverse moves. It can be shown that there exists an infinite sequence on the six-letter alphabet $A = \{a, b, c, \bar{a}, \bar{b}, \bar{c}\}$ such that its prefixes of length $2^N - 1$ give for each N the minimal strategy to move N disks from peg I to peg II if N is odd and from peg I to peg III if N is even. Furthermore this sequence can be obtained (see [4]) as the fixed point of the

morphism defined on A by:

$$\begin{aligned} a &\longrightarrow a\bar{c} \\ b &\longrightarrow c\bar{b} \\ c &\longrightarrow b\bar{a} \\ \bar{a} &\longrightarrow ac \\ \bar{b} &\longrightarrow cb \\ \bar{c} &\longrightarrow ba. \end{aligned}$$

It is hence also a 2-automatic sequence. For a survey and a “direct” proof of automaticity, see [6]. Another general survey on the towers of Hanoi is [23].

Warning

The definition of the Fibonacci sequence ($0 \longrightarrow 01, 1 \longrightarrow 0$) uses a morphism of non-constant length. Hence the question arises whether this sequence can be generated in another way (constant length morphism followed by a literal map) i.e. whether it is k -automatic for some $k \geq 2$. The answer is **NO**: it can be shown that, for all $k \geq 2$, this sequence is not k -automatic.

In the same vein consider the “cyclic” towers of Hanoi, where the towers are disposed on a circle and where only clockwise moves are permitted (using the above notations this means that one may use only the moves a, b and c). Then there exists, as previously, an infinite sequence which is the limit of the finite sequences of moves for N disks. This sequence is given (see [6]) by the following morphism (of non-constant length) on the alphabet $A = \{f, g, h, u, v, w\}$:

$$\begin{aligned} f &\longrightarrow fvf \\ g &\longrightarrow gwg \\ h &\longrightarrow huh \\ u &\longrightarrow fg \\ v &\longrightarrow gh \\ w &\longrightarrow hf, \end{aligned}$$

followed by the projection:

$$\begin{aligned} f &\longrightarrow a \\ g &\longrightarrow c \\ h &\longrightarrow b \\ u &\longrightarrow c \\ v &\longrightarrow b \\ w &\longrightarrow a. \end{aligned}$$

But it can be shown (see [1]) that, for all $k \geq 2$, this sequence is not k -automatic.

Many other sequences discussed by physicists are not k -automatic: for instance the so-called generalized Fibonacci sequences, generated by $0 \longrightarrow 01^{a+1}$,

$1 \rightarrow 01^a$, are k -automatic for no value of $k \geq 2$. Another example of a sequence which is k -automatic for no value of $k \geq 2$ is the “circle sequence”: this sequence is associated to the substitution $a \rightarrow cac$, $b \rightarrow accac$, $c \rightarrow abcac$; (actually the substitution has no fixed point, but its square has two fixed points).

5. WHERE FINITE AUTOMATA ENTER THE PICTURE

In this section we give the reason why the terminology “automatic” is used. A finite automaton (with output function) - also called “uniform tag system” by Cobham in [14] - consists of states, transition functions and an output function. It reads words written with an input alphabet and computes an output for any given word. More precisely, if $k \geq 2$ is an integer, a k -automaton consists of:

- a finite set S of states; one of the states is distinguished and is called the initial state. S can be thought of as the set of vertices of a graph;
- k (transition-) maps from S to S labelled $0, 1, \dots, k-1$, represented as oriented edges (arrows) of the above graph;
- an output function φ , i.e. a map from the set of states S to some set U .

Such a machine works as follows: the input alphabet is $\{0, 1, \dots, k-1\}$. One chooses to read words on this alphabet either from left to right (direct automaton) or from right to left (reverse automaton). Given an input word one reads it and feeds the automaton with its letters interpreted as transition maps, starting from the initial state and following the arrows in order. Having finished to read the given word, one finds oneself on a state. Take the image of this state by the output function. Hence to each word on $\{0, 1, \dots, k-1\}$ one associates an element of U .

The machine generates an infinite sequence $(u_n)_{n \geq 0}$ as follows: to each input $n \in \mathbb{N}$, or rather to its k -ary expansion, the automaton associates an element $u_n \in U$.

Example

Take $k = 2$, hence the input alphabet is $\{0, 1\}$. Let $S = \{A, B, C\}$ and let A be the initial state. The arrows of the graph below define the transition maps. Put $\varphi(A) = \varphi(B) = 0$, $\varphi(C) = 1$.

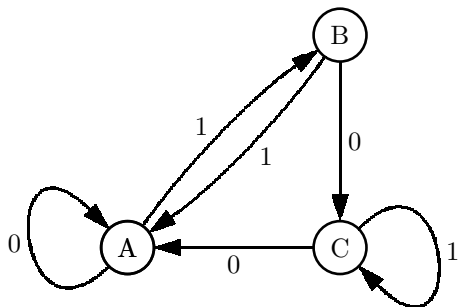

Choose to read words from right to left. The input word 001110 yields:
 $001110.A = 00111.A = 0011.B = 001.A = 00.B = 0.C = A$; and finally
 $\varphi(A) = 0$.

To the sequence of binary integers corresponds the sequence of outputs:

$$\begin{aligned} 0 &\longrightarrow 0 \\ 1 &\longrightarrow 0 \\ 10 &\longrightarrow 0 \\ 11 &\longrightarrow 0 \\ 100 &\longrightarrow 0 \\ 101 &\longrightarrow 1 \\ 110 &\longrightarrow 0 \\ 111 &\longrightarrow 0 \\ 1000 &\longrightarrow 0 \\ 1001 &\longrightarrow 0 \\ 1010 &\longrightarrow 1 \\ 1011 &\longrightarrow 0 \\ &\dots \end{aligned}$$

We shall give in the last paragraph of this chapter more examples of automata which actually generate the five automatic sequences discussed in Paragraph 4.

Finally, and to conclude the section, we mention a theorem of Cobham's [14] which asserts that a sequence is generated by a k -automaton as above if and only if it is the literal image of a fixed point of a morphism of length k . Furthermore *automatic sequences can be generated either by direct or reverse reading automata*.

6. HOW RANDOM CAN AN AUTOMATIC SEQUENCE BE?

The automatic sequences occur in many mathematical fields (number theory, harmonic analysis, fractals ...) but also in theoretical computer science, or even in music (see [7] for example). The "philosophical" reason, if we may say, is that they lie between order (periodicity) and chaos (randomness), but that they are however easy to construct and ... theorems can actually be proved.

Now, what happens if one perturbs an automatic sequence?

Firstly one can change the name of the letters without changing the structure of the sequence: for instance the Rudin-Shapiro sequence above has been defined on the alphabet $\{-1, +1\}$. As far as automaticity is concerned it is perfectly irrelevant to take $\{-1, +1\}$, $\{0, 1\}$ or say $\{a, b\}$.

Secondly the family of k -automatic sequences is closed under simple operations such as shifting, changing finitely many terms, adding two sequences, etc.

How “random” can an automatic sequence be? Of course we should exclude the periodic or ultimately periodic sequences. The remaining automatic sequences:

- have zero entropy (whatever the definition of entropy is, see the contribution of V. Berthé [9] in this volume), hence are deterministic;
- have a low factor complexity (see Part III of this paper), more precisely the number of blocks of length n in an automatic sequence is $O(n)$, whereas for a “random” binary sequence one has 2^n blocks;
- form a countable set, (hence there are very few of them, contrarily to what would be expected from “random” sequences);
- form a set of measure zero, (of course almost all the sequences on a finite alphabet are expected to be “random”);
- BUT they may have an absolutely continuous spectrum, such as the Rudin-Shapiro sequence for which the spectral measure is actually equal to the Lebesgue measure, just as would be expected for a random sequence (see the contribution of M. Queffélec [30] in this volume).

7. MISCELLANEA

- Define a sequence of words on the alphabet $\{0, 1\}$ by $w_0 = 0$, $w_{n+1} = w_n \overline{w_n}$, $\forall n \geq 0$, where \overline{w} is obtained from w by replacing the 0’s by 1’s and vice versa. Hence $w_1 = 01$, $w_2 = 0110$, $w_3 = 01101001$, \dots

Prove that the sequence of words $(w_n)_n$ converges to the Prouhet-Thue-Morse sequence, (all these words are prefixes of our Prouhet-Thue-Morse sequence). For other such examples see [4], and for general results see [32].

- Define a sequence of words on the alphabet $\{0, 1\}$ by $w_0 = 1$, $w_{n+1} = w_n 1 f(w_n)$, $\forall n \geq 0$, where $f(w)$ is obtained from w by reading w backwards then replacing the 0’s by 1’s and vice versa. Prove that the sequence of words one obtains converges to the paperfolding sequence. This construction is known as “perturbed symmetry”, (see [10]).

- A deep theorem of Cobham (see [14], see also [11]) asserts that the only sequences which are both k - and ℓ -automatic for two multiplicatively independent integers k and ℓ (i.e. such that the ratio $\frac{\log k}{\log \ell}$ is irrational) are the ultimately periodic sequences. There is yet no general result for the non-constant length substitutions. Try to guess such a result (there is a conjecture by Hansel [22], and a partial solution has been given quite recently by F. Durand). Before guessing, consider the sequence $u = (u_n)_n$ which is the fixed point of the morphism

$$\begin{aligned} 0 &\longrightarrow 12 \\ 1 &\longrightarrow 102 \\ 2 &\longrightarrow 0. \end{aligned}$$

Now prove that this sequence can be obtained by taking the fixed point beginning by 1 of the following morphism (this result is due to Berstel [8]):

$$\begin{aligned} 0 &\longrightarrow 12 \\ 1 &\longrightarrow 13 \\ 2 &\longrightarrow 20 \\ 3 &\longrightarrow 21 \end{aligned}$$

and projecting it modulo 3

$$0 \longrightarrow 0, \quad 1 \longrightarrow 1, \quad 2 \longrightarrow 2, \quad 3 \longrightarrow 0.$$

The same sequence

$$1 \ 0 \ 2 \ 1 \ 2 \ 0 \ 1 \ 0 \ 2 \ 0 \ \dots$$

has a remarkable property which is worth mentioning: *it has no squares in it (i.e. no two consecutive identical blocks)*, see Part III of this paper. For surveys on similar topics see also [8] and [3].

Here is yet another property of the sequence which links it to the Prouhet-Thue-Morse sequence. Add 1 modulo 3 to each term, obtaining:

$$2 \ 1 \ 0 \ 2 \ 0 \ 1 \ 2 \ 1 \ 0 \ 1 \ \dots$$

This is the sequence of lengths of the strings of 1's between two consecutive 0's in the Morse sequence

$$0 \ 1 \ 1 \ 0 \ 1 \ 0 \ 0 \ 1 \ 1 \ 0 \ 0 \ 1 \ 0 \ 1 \ 1 \ 0 \ 1 \ 0 \ 0 \ 1 \ 0 \ \dots$$

• Let \mathcal{A} be defined as the smallest (for the lexicographical order) subset of \mathbb{N} which contains 1 and such that $n \in \mathcal{A} \implies 2n \notin \mathcal{A}$. Hence the elements of \mathcal{A} in increasing order are:

$$1 \ 3 \ 4 \ 5 \ 7 \ 9 \ 11 \ 12 \ 13 \ 15 \ 16 \ 17 \ 19 \ \dots$$

Now take the first differences to get:

$$2 \ 1 \ 1 \ 2 \ 2 \ 2 \ 1 \ 1 \ 2 \ 1 \ 1 \ 2 \ \dots$$

The reader might now consider again his favourite Prouhet-Thue-Morse sequence:

$$0 \ 1 \ 1 \ 0 \ 1 \ 0 \ 0 \ 1 \ 1 \ 0 \ 0 \ 1 \ 0 \ 1 \ 1 \ 0 \ 1 \ 0 \ 0 \ \dots$$

and write down the lengths of the blocks composed only with 0's or only with 1's. He will obtain:

$$1 \ 2 \ 1 \ 1 \ 2 \ 2 \ 2 \ 1 \ 1 \ 2 \ 1 \ 1 \ 2 \ \dots,$$

which is - up to the first term - the sequence of first differences above. To finish with these two sequences of 1's and 2's, the patient reader can prove that the first one is the fixed point of:

$$\begin{aligned} 2 &\longrightarrow 211 \\ 1 &\longrightarrow 2 \end{aligned}$$

whereas the second one is the fixed point of:

$$\begin{aligned} 1 &\longrightarrow 121 \\ 2 &\longrightarrow 12221. \end{aligned}$$

To read more on these sequences see [2] and [35]. Note that it has been proved independently by Mkaouar and Shallit that both sequences above are not 2-automatic.

• Another intriguing sequence is the self-running Kolakoski sequence. Consider any infinite sequence of 1's and 2's, say for example:

$$u : 2 \ 111 \ 2 \ 1 \ 22 \ 1 \ \dots .$$

Let $K(u)$ be the sequence formed by the lengths of the strings of 1's and the strings of 2's. In our example:

$$K(u) : 1 \ 3 \ 1 \ 1 \ 2 \ \dots .$$

The Kolakoski sequence is the only sequence beginning by 2 which satisfies the remarkable property $K(u) = u$.

$$\begin{array}{l} u : \quad \underbrace{22}_2 \ \underbrace{11}_2 \ \underbrace{2}_1 \ \underbrace{1}_1 \ \underbrace{22}_2 \ 1 \ \dots . \\ K(u) : \end{array}$$

It can be shown that this sequence can be obtained by iterating the following map:

$$\begin{aligned} 11 &\longrightarrow 21 \\ 12 &\longrightarrow 211 \\ 22 &\longrightarrow 2211 \\ 21 &\longrightarrow 221. \end{aligned}$$

Note that this map is not a morphism (there is some kind of “context-dependence”) and that it is not known whether this sequence can be obtained as the projection of the fixed point of a morphism (even with non-constant length). For more properties of this sequence see [25], [19], [20], [38], [16], [17], [12] and [28].

This last example may open the way to new constructions of sequences which are still algorithmically (easy) computable but not “too simple”, hence again between order and chaos. An interesting paper of Wen and Wen [39] discusses

the composite iteration of two different morphisms ruled by a third morphism, (see also [16] and [17]).

8. APPENDIX: AUTOMATA GENERATING THE FIVE EXAMPLES OF SECTION 4

- 1) A reverse automaton generating the Prouhet-Thue-Morse sequence:

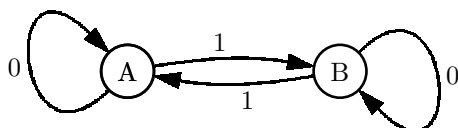

Output function: $\varphi(A) = 0$, $\varphi(B) = 1$.

Can you find what the direct automaton is?

- 2) A reverse automaton generating the paperfolding sequence:

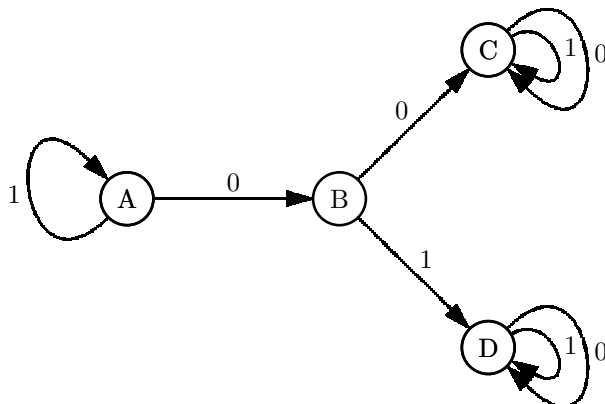

Output function: $\varphi(A) = 1$, $\varphi(B) = 1$, $\varphi(C) = 1$, $\varphi(D) = 0$.

The direct automaton is given in Part II.

- 3) A reverse automaton generating the Rudin-Shapiro sequence:

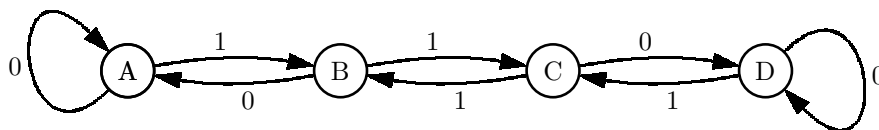

Output function: $\varphi(A) = +1$, $\varphi(B) = +1$, $\varphi(C) = -1$.

The value $\varphi(D)$ is irrelevant. What is the direct automaton?

- 4) A reverse automaton generating the period-doubling sequence:

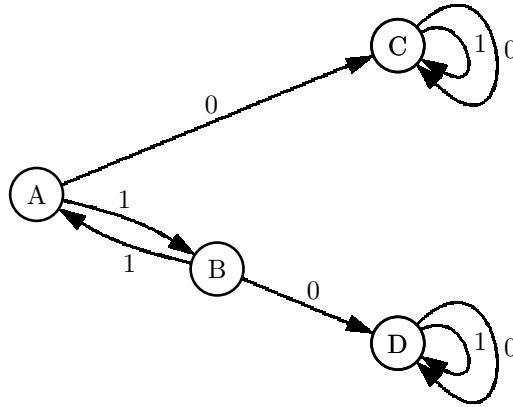

Output function: $\varphi(A) = 0, \varphi(B) = 1, \varphi(C) = 0, \varphi(D) = 1.$

5) A reverse automaton generating the Hanoi sequence:

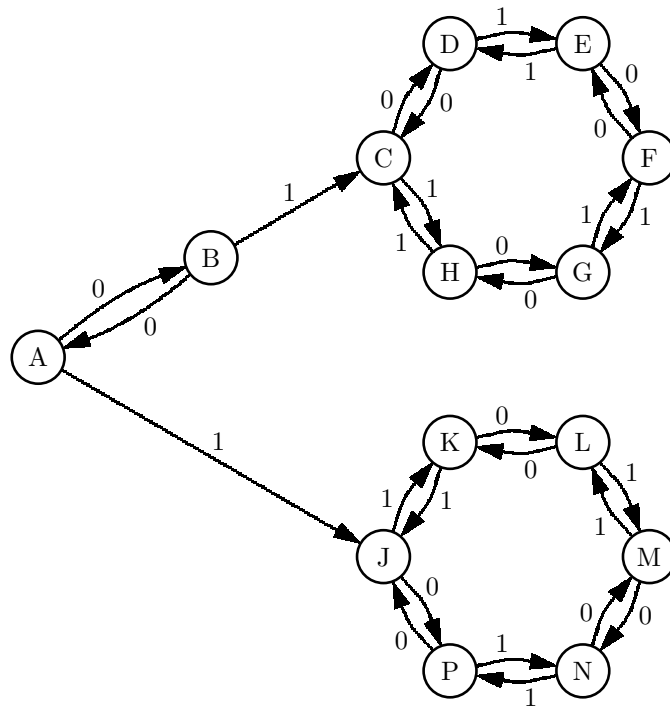

Output function: $\varphi(A) = \text{any value}, \varphi(B) = \text{any value},$
 $\varphi(C) = \bar{c}, \quad \varphi(D) = \bar{c}, \quad \varphi(E) = \bar{a},$
 $\varphi(F) = \bar{a}, \quad \varphi(G) = \bar{b}, \quad \varphi(H) = \bar{b},$
 $\varphi(J) = a, \quad \varphi(K) = b, \quad \varphi(L) = b,$
 $\varphi(M) = c, \quad \varphi(N) = c, \quad \varphi(P) = a.$

References

- [1] Allouche J.-P., Note on the cyclic towers of Hanoi, *Theoret. Comput. Sci.* **123** (1994) 3–7.
- [2] Allouche J.-P., Arnold A., Berstel J., Brlek S., Jockusch W., Plouffe S., Sagan B. E., A relative of the Thue-Morse sequence, *Discrete Math.* (1994) to appear.
- [3] Allouche J.-P., Astoorian D., Randall J., Shallit J., Morphisms, square-free strings and the tower of Hanoi puzzle, *Amer. Math. Monthly* **101** (1994) 651–658.
- [4] Allouche J.-P., Bétréma J., Shallit J., Sur des points fixes de morphismes d'un monoïde libre, *RAIRO, Informatique Théorique et Applications* **23** (1989) 235–249.
- [5] Allouche J.-P., Cosnard M., Itération de fonctions unimodales et suites engendrées par automates, *C. R. Acad. Sci., Paris, Série A* **296** (1983) 159–162.
- [6] Allouche J.-P., Dress F., Tours de Hanoi et automates, *RAIRO, Informatique Théorique et Applications* **24** (1990) 1–15.
- [7] Allouche J.-P., Johnson T., Finite automata and morphisms in assisted musical composition, *J. New Music Research* **24** (1995) to appear.
- [8] Berstel J., Sur la construction de mots sans carré, *Séminaire de Théorie des Nombres de Bordeaux, Exposé 18* (1978–1979) 18-01–18-15.
- [9] Berthé V., *this volume*.
- [10] Blanchard A., Mendès France M., Symétrie et transcendance, *Bull. Sci. Math.* **106** (1982) 325–335.
- [11] Bruyère V., Hansel G., Michaux C., Villemaire R., Logic and p -recognizable sets of integers, *Bull. Belg. Math. Soc.* **1** (1994) 191–238.
- [12] Carpi A., Repetitions in the Kolakoski sequence, *Bull. EATCS* **50** (1993) 194–196.
- [13] Cobham A., On the base-dependence of sets of numbers recognizable by finite automata, *Math. Systems Theory* **3** (1969) 186–192.
- [14] Cobham A., Uniform tag sequences, *Math. Systems Theory* **6** (1972) 164–192.
- [15] Collet P., Eckmann J.-P., Iterated maps on the interval as dynamical systems (Progress in Physics, Birkhäuser, 1980).
- [16] Culik II K., Karhumäki J., Lepistö A., Alternating iteration of morphisms and the Kolakoski sequence, in: Lindenmayer systems: impacts in theoretical computer science, computer graphics and developmental biology, G. Rozenberg and A. Salomaa Eds (Springer Verlag, 1992) p. 93–103.
- [17] Culik II K., Karhumäki J., Iterative devices generating infinite words, in: STACS 1992: 9th Annual Symposium on Theoretical Aspects of Computer Science, A. Finkel and M. Jantzen Eds (Lecture Notes in Computer Science, **577**, 1992) p. 531–543.
- [18] Davis C., Knuth D. E., Number representations and dragon curves, *J. Recr. Math.* **3** (1970) 161–181; 133–149.

- [19] Dekking F. M., Regularity and irregularity of sequences generated by automata, *Séminaire de Théorie des Nombres de Bordeaux, Exposé 9* (1979–1980) 9-01–9-10.
- [20] Dekking F. M., On the structure of self-generating sequences, *Séminaire de Théorie des Nombres de Bordeaux, Exposé 31* (1980–1981) 31-01–31-06.
- [21] Dekking F. M., Mendès France M., van der Poorten A., FOLDS!, *Math. Intell.* **4** (1982) 130–138, 173–181 and 190–195.
- [22] Hansel G., private communication.
- [23] Hinz A. M., The tower of Hanoi, *Enseign. Math.* **35** (1989) 289–321.
- [24] Jonker L., Periodic orbits and kneading invariants, *Proc. London Math. Soc.* **39** (1979) 428–450.
- [25] Kolakoski W., Self-generating runs, Prob. 5304, sol. in *Amer. Math. Monthly* **73** (1966) 681–682.
- [26] Meyer Y., *this volume*.
- [27] Morse M., Recurrent geodesics on a surface of negative curvature, *Trans. Amer. Math. Soc.* **2** (1921) 84–100.
- [28] Păun G., How much Thue is Kolakoski?, *Bull. EATCS* **49** (1993) 183–185.
- [29] Prouhet E., *C. R. Acad. Sci., Paris* **33** (1851) 225.
- [30] Queffélec M., *this volume*.
- [31] Rudin W., Some theorems on Fourier coefficients, *Proc. Amer. Math. Soc.* **10** (1959) 855–859.
- [32] Shallit J., A generalization of automatic sequences, *Theoret. Comput. Sci.* **61** (1988) 1–16.
- [33] Shapiro H. S., Extremal problems for polynomial and power series (Thesis, M.I.T., 1951).
- [34] Shechtman D., Blech I. A., Gratias D., Cahn J. W., Metallic phase with long-range orientational order and no translational symmetry, *Phys. Rev. Letter* **53** (1984) 1951–1953.
- [35] Tamura J., Some problems having their origin in the power series $\sum_{n=1}^{\infty} z^{[an]}$, in: Reports of the meeting on analytic theory of numbers and related topics, (Gakushuin University, 1992), p. 190–212.
- [36] Thue A., Über unendliche Zeichenreihen, *Norske vid. Selsk. Skr. I. Mat. Kl. Christiana* **7** (1906) 1–22.
- [37] Thue A., Lage gleicher Teile gewisse Zeichenreihen, *Norske vid. Selsk. Skr. I. Mat. Kl. Christiana* **1** (1912) 1–67.
- [38] Weakley W. D., On the number of C^{∞} -words of each length, *J. Combin. Theory Ser. A* **51** (1989) 55–62.
- [39] Wen Z.-X., Wen Z.-Y., Remarques sur la suite engendrée par des substitutions composées, *Ann. Fac. Sci. Toulouse Math.* **9** (1988) 55–63.

PART II

Further properties of paperfolding

In this part we shall discuss some unrelated properties of the paperfolding sequence and its generalizations. We shall be concerned among other things with dimensions and continued fractions.

1. DIRECT READING AND REVERSE READING

Consider the two automata \mathcal{A}' and \mathcal{A}'' where A' (resp. A'') is the initial state.

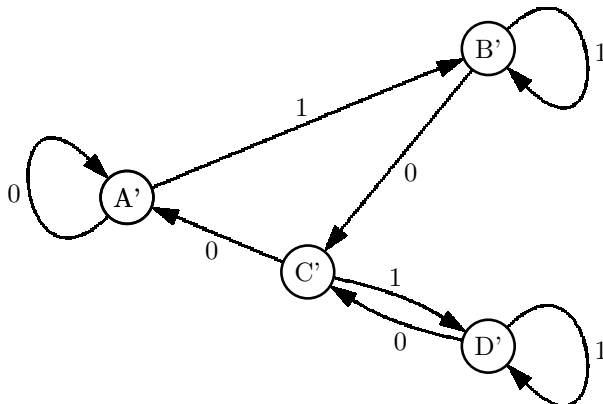

Output function: $\varphi'(A') = \varphi'(B') = a$, $\varphi'(C') = \varphi'(D') = b$.

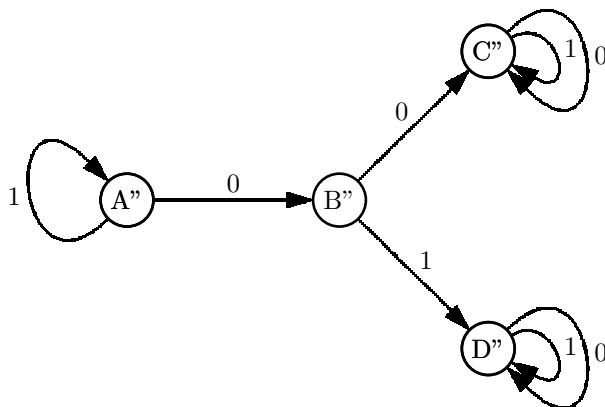

Output function: $\varphi''(A'') = \varphi''(B'') = \varphi''(C'') = a$, $\varphi''(D'') = b$.

The input instructions are to be read from left to right for the automaton \mathcal{A}' (direct reading) whereas for the automaton \mathcal{A}'' we are to read from right to left (reverse reading). For example “nineteen”=10011 puts \mathcal{A}' onto state B'

and \mathcal{A}'' onto state C'' . In both cases the output is $a = \varphi'(B') = \varphi''(C'')$. We leave it as an exercise to verify that for all $n = 0, 1, 2 \dots$

$$\varphi'(A'_n) = \varphi''(A''_n)$$

where A'_n (resp. A''_n) is the state of the automaton \mathcal{A}' (resp. \mathcal{A}'') at step n .

This illustrates a general result that we had already mentioned in Part I: *automatic sequences can be generated either by direct or reverse reading automata.*

2. WORDS AND DIAGRAMS

Let $\{L, R\}^*$ be the set of words on two symbols L (left) and R (right). To each word $w \in \{L, R\}^*$ corresponds a diagram on the lattice \mathbb{Z}^2 in the following way. Starting from the origin follow the horizontal unit interval. At the endpoint turn left or right according to the instruction given by the first letter of the word w . Having then followed the vertical segment (upward or downward) read out the second letter of w which instructs you to turn left or right on a horizontal segment, etc... For example the diagram corresponding to $w = LRLR$ is

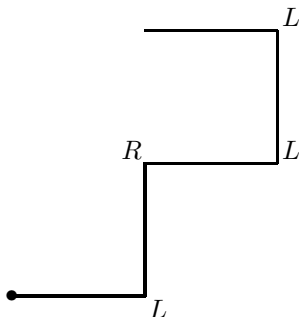

The length of the word is $|w| = 4$ and the length of the diagram is $|w| + 1 = 5$.

Similarly $L^4 = LLLL$ represents

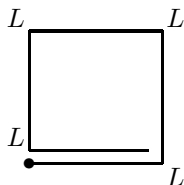

and LRL^3RL represents

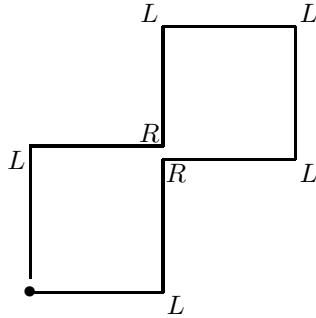

The first and the third examples show *self-avoiding* curves: edges are described only once. The associated words are said to be self-avoiding. The third example illustrates a closed curve or *cyclic* curve: the two ends coincide. We then speak of cyclic words.

Later we shall encounter infinite length diagrams which correspond to infinite sequences of *R*'s and *L*'s.

3. THE FOLDING OPERATORS [10]

Folding a word or its associated diagram is done in three steps.

Step 1. Fold the polygon w onto the unit segment by shrinking all angles to 0. Hence L^3 becomes

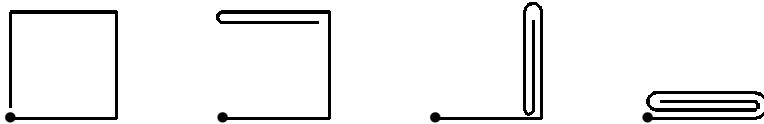

Step 2. Multiply the length of the edges by 2 and fold the collapsed diagram onto itself either in the positive direction (operator F_+) or in the negative direction (F_-)

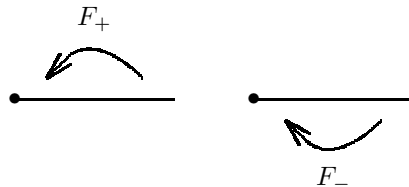

Step 3. Unfold to 90° . We thus obtain a new diagram w' twice as long as the original one which we denote $F_+(w)$ or $F_-(w)$. Clearly $|F_\pm(w)| = 2|w| - 1$.

As an example $F_+(L^3)$ is the diagram

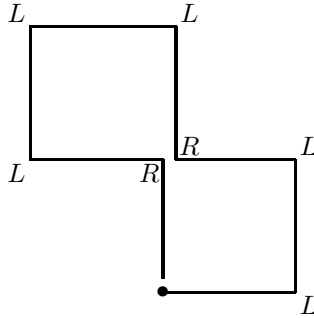

so that

$$F_+(L^3) = L^2 R L^3 R.$$

The following result can easily be established.

THEOREM 1. *Let $w = A_0 A_1 \cdots A_{n-1} \in \{L, R\}^*$. Then*

$$F_+(w) = L A_0 R A_1 L A_2 R \cdots A_{n-1} X$$

where

$$X = \begin{cases} L & \text{if } n \equiv 0 \pmod{2}, \\ R & \text{if } n \equiv 1 \pmod{2}. \end{cases}$$

Similarly

$$F_-(w) = R A_0 L A_1 R A_2 L \cdots A_{n-1} Y$$

where

$$Y = \begin{cases} R & \text{if } n \equiv 0 \pmod{2}, \\ L & \text{if } n \equiv 1 \pmod{2}. \end{cases}$$

The operation which is involved in this theorem is the so-called shuffle product III (Russian letter “Sha”): if $w = A_0 A_1 \cdots A_{n-1} A_n$ and $w' = B_0 B_1 \cdots B_{n-1}$ (it may happen that A_n is the empty letter), then

$$w \text{ III } w' = A_0 B_0 A_1 B_1 A_2 B_2 \cdots A_{n-1} B_{n-1} A_n.$$

The theorem asserts

$$\begin{aligned} F_+(w) &= (LR)^\times \text{ III } w \\ F_-(w) &= (RL)^\times \text{ III } w \end{aligned}$$

where it is to be understood that $(LR)^\times$ (resp. $(RL)^\times$) is the alternating word $LRRLR\dots$ (resp. $RLRLR$) of length $|w| + 1$.

Let S be the set of self-avoiding words and let C be the set of cyclic words.

THEOREM 2. (*Davis and Knuth*).

$$F_{\pm}(S) \subset S, \quad F_{\pm}(C) \subset C.$$

We refer to [3] for the proof.

Suppose we start out with the empty word \emptyset . Then, in accordance with Theorem 1

$$F_+(\emptyset) = L, \quad F_-(\emptyset) = R.$$

As \emptyset is obviously self-avoiding (it is the unit interval!) so is F_{\pm} (L or R) and by induction, given any sequence $\varepsilon_1 \varepsilon_2 \cdots \varepsilon_n$ of (\pm) signs

$$F_{\varepsilon_n \varepsilon_{n-1} \cdots \varepsilon_1}(\emptyset) = F_{\varepsilon_n} F_{\varepsilon_{n-1}} \cdots F_{\varepsilon_1}(\emptyset)$$

is self-avoiding.

To an infinite sequence $\varepsilon = (\varepsilon_1 \varepsilon_2 \cdots)$ of signs correspond an infinite diagram called a *dragon curve* $F_{\varepsilon}(\emptyset)$. The above discussion shows that dragon curves are self-avoiding.

The figures below represent respectively $F_{\varepsilon}(\emptyset)$ where $\varepsilon = (+-)^{\infty}$ and $\varepsilon = (+)^{\infty}$. (There are two dragon curves corresponding to $\varepsilon = (+-)^{\infty}$; we only show one of them.)

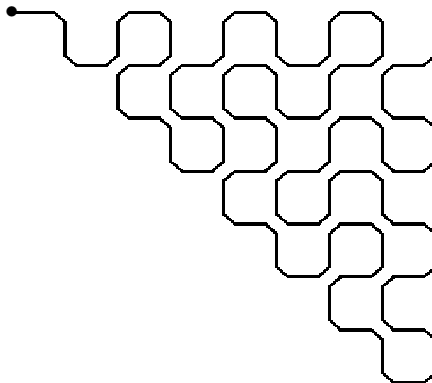

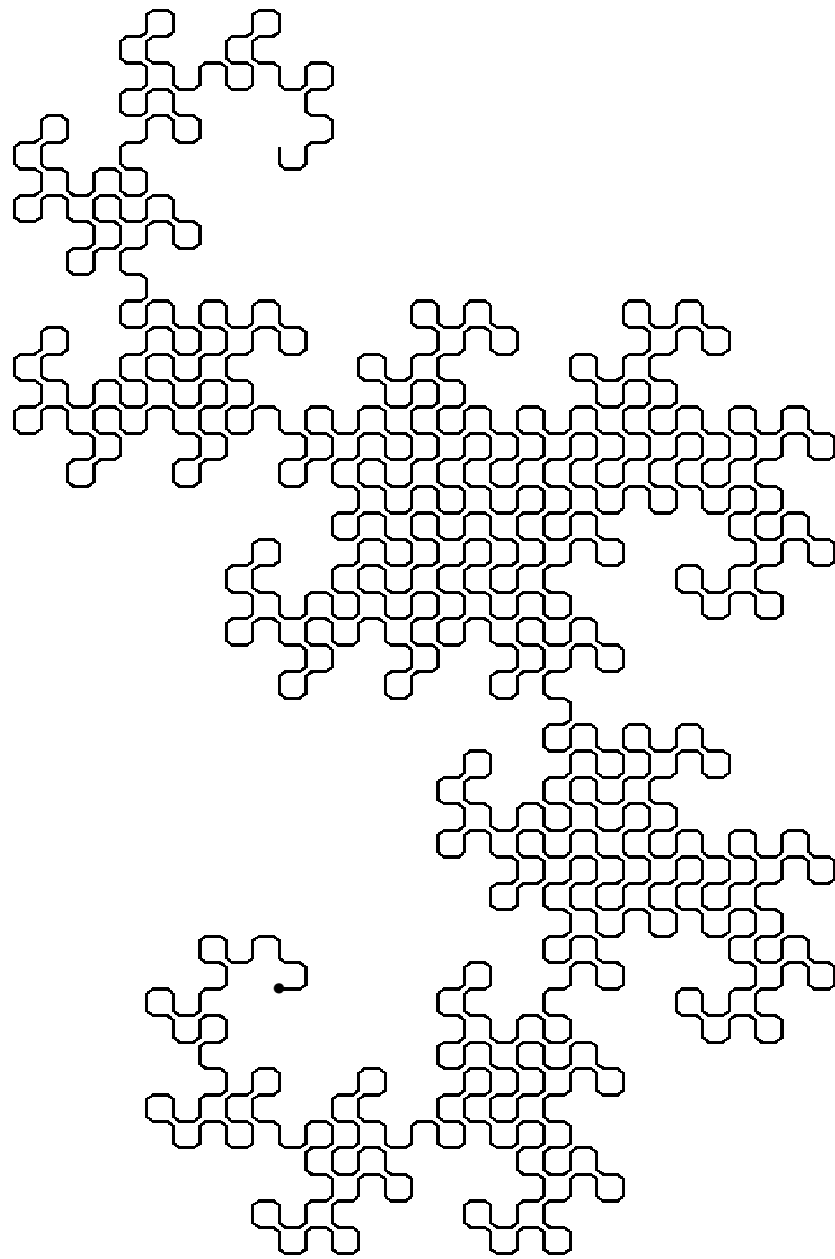

The reader will no doubt have noticed that the infinite sequence $F_{(+)\infty}(\emptyset)$ is the paperfolding sequence discussed earlier in Paragraph 1 and in Part I. If ε is an arbitrary (\pm) sequence, we shall say that $F_\varepsilon(\emptyset)$ is a generalized paperfolding sequence. It is easily seen that if $A_0 A_1 A_2 \cdots$ is the original paperfolding sequence (the regular paperfolding) then

$$\begin{cases} A_{2n} \text{ is the alternating sequence } (LR)^\infty, \\ A_{2n+1} = A_n. \end{cases}$$

More generally if $B_0 B_1 B_2 \cdots$ is any paperfolding sequence then

$$\begin{cases} B_{2n} \text{ is an alternating sequence,} \\ B_{2n+1} \text{ is a paperfolding sequence.} \end{cases}$$

This property characterizes the family of paperfolding sequences.

Exercise. The generalized paperfolding sequence $F_\varepsilon(\emptyset)$ is automatic if and only if ε is ultimately periodic.

By simple inspection one feels that dragon curves are somehow space-filling (space = \mathbb{Z}^2), or that at least they fill portions of \mathbb{Z}^2 . This is indeed the case and we shall show in the next paragraph that all dragon curves are 2-dimensional. First of all we must define the concept of dimension.

4. THE DIMENSION OF A CURVE [4], [11].

Let Γ be a locally rectifiable unbounded curve in the plane. All arcs of Γ have finite length unlike fractal Weierstrass curves, Peano curves or Brownian curves. (See Mandelbrot [8] for the properties of the last mentioned curves.)

Consider a portion Γ_L of Γ of length L . Let $\varepsilon > 0$ and let $\Gamma(L, \varepsilon)$ be the area of the ε -sausage of Γ_L .

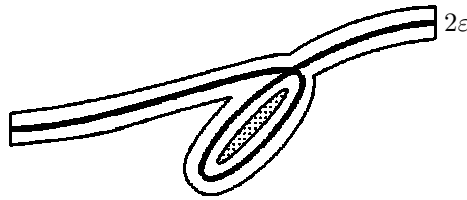

Denote by $D(L)$ the diameter of Γ_L :

$$D(L) = \max\{\text{dist}(M, N) \mid M \in \Gamma_L, N \in \Gamma_L\}.$$

By definition the dimension of Γ is

$$\dim(\Gamma) = \liminf_{L \rightarrow \infty} \frac{\log \Gamma(L, \varepsilon)}{\log D(L)}.$$

It can be shown that $\dim(\Gamma)$ is independent of $\varepsilon > 0$ and that

$$1 \leq \dim(\Gamma) \leq 2.$$

A straight line, an infinite branch of an algebraic curve have dimension 1. The spiral $\rho = \exp \theta$ is also one-dimensional. Let $\alpha > 0$. The spiral $\rho = \theta^\alpha$ has dimension $1 + 1/\alpha$ if $\alpha \geq 1$ and dimension 2 if $\alpha \leq 1$.

THEOREM 3. (*Mendès France and Tenenbaum*).

All dragon curves are two-dimensional.

Let us sketch the proof which seems quite relevant here since it involves sequences related to the Rudin-Shapiro sequence. (For details see [12].)

The N^{th} vertex of a given dragon curve Γ has coordinates

$$x_N = \sum_{k < N/2} s_k, \quad y_N = \sum_{k < N/2} t_k,$$

where s_k and t_k are equal to ± 1 ; x_N is the algebraic sum of the right and left moves whereas y_N is the sum of ups and downs. Both sequences (s_n) and (t_n) are closely linked to the Rudin-Shapiro sequence. In particular for the dragon curve $F_{(+ -)^\infty}(\emptyset) = LRLRLR\cdots$ the sequence (s_n) is exactly the Rudin-Shapiro sequence. The sequence (t_n) is closely related.

It can be shown that for all dragon curves the Rudin-Shapiro property holds, namely

$$\left| \sum_{k < N/2} s_k \right| \leq (2 + \sqrt{2})\sqrt{N/2},$$

$$\left| \sum_{k < N/2} t_k \right| \leq (2 + \sqrt{2})\sqrt{N/2}.$$

Therefore the diameter $D(N)$ satisfies

$$D(N) \leq \max_{n < N} (x_n^2 + y_n^2)^{\frac{1}{2}} \leq a\sqrt{N}$$

for some constant a .

On the other hand, as the dragon curve is self-avoiding,

$$\Gamma(N, \varepsilon) \sim 2\varepsilon N$$

so that

$$\dim(\Gamma) \geq \lim_{N \rightarrow \infty} \frac{\log(2\varepsilon N)}{\log a\sqrt{N}} = 2.$$

But the dimension is at most 2 therefore

$$\dim(\Gamma) = 2, \quad \text{QED.}$$

The entropy of a curve (see V. Berthé [1]) is linked to the dimension. The complete relationship is discussed in Mendès France [11]. The higher the entropy, the higher the dimension, so in some sense the dimension measures the complexity of a curve (this is one of Mandelbrot's principles). In that respect dragon curves are among the most complex self-avoiding curves on \mathbb{Z}^2 .

5. PAPERFOLDING AND CONTINUED FRACTIONS

The continued fraction expansion of a real number x reads

$$x = a_0 + \frac{1}{a_1 + \frac{1}{a_2 + \ddots}} = [a_0, a_1, a_2, \dots]$$

where the so-called partial quotients $a_n \geq 1$ are integers; a_0 may be negative. If x is irrational the expansion is infinite whereas if x is rational the expansion terminates. Due to the trivial equality

$$a = a - 1 + \frac{1}{1}, \quad a \geq 2,$$

rational numbers have two expansions which only differ by the last two partial quotients. The rank n of the last partial quotient a_n is called the depth of x . The above remark allows us to assume with no loss of generality that the depth is always even.

In this paragraph we shall discuss the continued fraction expansion of the number

$$x = \sum_{n \geq 0} g^{-2^n}$$

where $g \geq 2$ is a given integer (the case $g = 2$ is slightly more complicated so we shall suppose $g \geq 3$). The following analysis is essentially due to Kmošek [6] and Shallit [13]. See also the papers of Mendès France [9], Blanchard, Mendès France [2] or Dekking, Mendès France, van der Poorten [5].

Let p/q be a rational number in the interval $(0, 1)$. We assume p and q coprime. It can be shown that if

$$\frac{p}{q} = [0, a_1, a_2, \dots, a_n], \quad (n \text{ even}),$$

then

$$\frac{p}{q} + \frac{1}{q^2} = [0, a_1, a_2, \dots, a_n + 1, a_n - 1, a_{n-1}, \dots, a_1].$$

If $\vec{w} = a_1 a_2 \cdots a_n$ is the word associated to p/q then the word corresponding to $p/q + 1/q^2$ is

$$S_{\vec{p}}(\vec{w}) = \vec{w} \vec{p} \overleftarrow{w}$$

where \overleftarrow{w} is the word \vec{w} reversed and where \vec{p} denotes the “operator” which perturbs the last letter of \vec{w} and the first letter of \overleftarrow{w} . \overleftarrow{p} is the inverse operator: it adds -1 (resp. $+1$) to the last letter of the first word (resp. first letter of the last word).

Consider

$$\begin{aligned} x_2 &= \frac{1}{g} + \frac{1}{g^2} = [0, g - 1, g + 1], \\ x_3 &= \frac{1}{g} + \frac{1}{g^2} + \frac{1}{g^2} = S_{\vec{p}}(g - 1, g + 1) \\ &= [0, g - 1, g + 2, g, g - 1]. \end{aligned}$$

Then

$$\begin{aligned} x_4 &= S_{\vec{p}} [g - 1, g + 2, g, g - 1] \\ &= [0, g - 1, g + 2, g, g, g - 2, g, g + 2, g - 1] \end{aligned}$$

and

$$\begin{aligned} x &= x_\infty = S_{\vec{p}}^\infty(g - 1, g + 1) \\ &= [0, g - 1, g + 2, g, g, g - 2, g, g + 2, g, g - 2, g + 2, g, \dots]. \end{aligned}$$

The partial quotients of x are completely determined by the algorithm. Their values are $g - 2, g - 1, g, g + 2$. Mahler [7] proved that x is transcendental and this is quite an achievement since many of the easier proofs in transcendental number theory are based on the speed with which the partial quotients tend to infinity (think of Liouville numbers).

Let us analyse the structure of the sequence of the partial quotients of x . Put $\vec{w} = g - 1, g + 1$. Then $x = S_{\vec{p}}^\infty(\vec{w})$

$$x = \vec{w} \vec{p} \overleftarrow{w} \vec{p} \overleftarrow{w} \overleftarrow{p} \overleftarrow{w} \overleftarrow{p} \vec{w} \vec{p} \overleftarrow{w} \overleftarrow{p} \vec{w} \dots$$

The sequence of w 's and p 's is obviously periodic but more surprisingly (?) the sequence of arrows is the regular paper-folding sequence. As it is automatic one can correctly guess that the sequence of partial quotients is indeed automatic. We show below the direct reading automaton which generates the sequence of partial quotients.

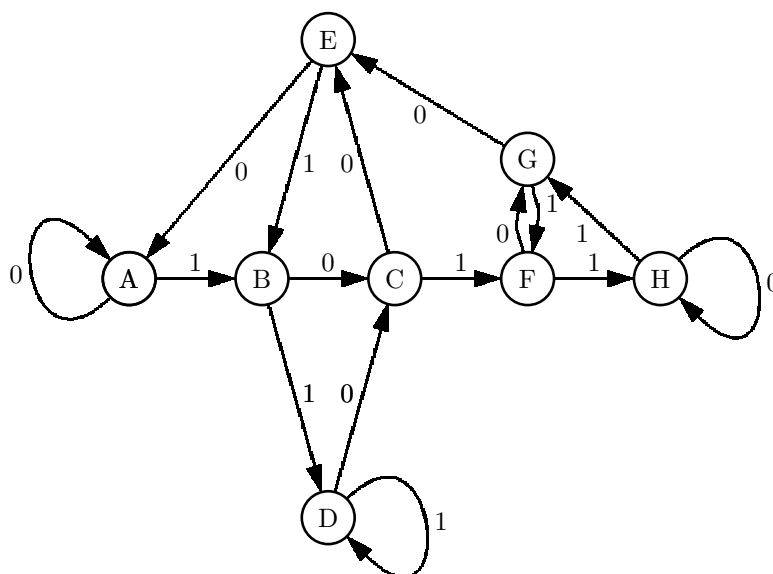

Output function: $\varphi(A) = g + 2, \quad \varphi(E) = g,$
 $\varphi(B) = g, \quad \varphi(F) = g + 2,$
 $\varphi(C) = g, \quad \varphi(G) = g - 2,$
 $\varphi(D) = g - 2, \quad \varphi(H) = g.$

References

- [1] Berthé V., *this volume*.
- [2] Blanchard A., Mendès France M., Symétrie et transcendance, *Bull. Sci. Math.* **106** (1982) 325–335.
- [3] Davis C., Knuth D. E., Number representations and dragon curves, *J. Recr. Math.* **3** (1970) 161–181; 133–149.
- [4] Dekking F. M., Mendès France M., Uniform distribution modulo one: a geometrical viewpoint, *J. reine angew. Math.* **129** (1981) 143–153.
- [5] Dekking F. M., Mendès France M., van der Poorten A., FOLDS!, *Math. Intell.* **4** (1982) 130–138, 173–181 and 190–195.
- [6] Kmošek M., Report by A. Schinzel, Oberwolfach 28 may - 2 june 1979.
- [7] Mahler K., Ein Analog zu einem Schneiderschen Satz, *Proc. Akad. Wetensch. Amsterdam* **39** (1936) 633–640 and 729–737.
- [8] Mandelbrot B., Les objets fractals (Nouvelle Bibliothèque Scient. Flammarion, Paris, 1975).
- [9] Mendès France M., Sur les fractions continues limitées, *Acta Arith.* **2** (1973) 207–215.

- [10] Mendès France M., Paper folding, space-filling curves and Rudin-Shapiro sequences, *Contemporary Mathematics* **9** (1982) 85–95.
- [11] Mendès France M., The Planck constant of a curve, in: *Fractal Geometry and Analysis* J. Belair and S. Dubuc Eds (Kluwer Acad. Publ., 1991) p. 325–366
- [12] Mendès France M., Tenenbaum G., Dimension des courbes planes, papiers pliés et suites de Rudin-Shapiro, *Bull. Soc. math. France* **109** (1981) 207–215.
- [13] Shallit J., Simple continued fractions for some irrational numbers *J. Number Theory* **11** (1979) 209–217.

PART III

Complements

In this chapter we will give some complements on finite automata: a quick survey of the notion of “repetitions” in a finite or infinite word, the multidimensional generalization of morphisms of constant length and of finite automata and finally a short account on differences and similarities between finite automata and cellular automata.

1. REPETITIONS IN INFINITE SEQUENCES

1.1. The beginning of the story

The pioneering work of Thue (see [18] and [19]) stems from the following easy observation:

OBSERVATION. *Every infinite word on a two-letter alphabet contains at least a (non-empty) square, (i.e. a block ww where w is a non empty word).*

Proof

As the proof is very easy we will give it: let $\{a, b\}$ be the two-letter alphabet. Let us try to construct a “long” word with no square in it. With no loss of generality we can suppose that the infinite word begins with an a . The following letter cannot be an a (since aa is a square), hence our word begins with ab . The next letter cannot be a b (since the word would contain the block bb), hence the word begins with aba . Now if we add a letter to aba the new word would necessarily contain a square, as it would be either $abaa$ or $abab$.

Note that the above reasoning shows that every word of length ≥ 4 on a two-letter alphabet contains a square.

A natural question hence arises: is it possible to find an infinite sequence on a three-letter alphabet without squares in it? One can also ask whether there exists an infinite sequence on a two-letter alphabet without cubes, (i.e. without blocks www where w is a non-empty word). The answer to both questions is YES, see [18], [19] and the survey [8] with its bibliography:

THEOREM.

- *The fixed point of the morphism*

$$\begin{aligned} 0 &\longrightarrow 12 \\ 1 &\longrightarrow 102 \\ 2 &\longrightarrow 0 \end{aligned}$$

has no square. This sequence is 2-automatic as mentioned in Part I.

- *The Thue-Morse sequence has no cube. More precisely this sequence has no overlap, i.e. no word wwx , where x is the first letter of the word w . This sequence is linked to the preceding one as we have seen in Part I.*

Remark

Note that the Thue-Morse sequence contains arbitrarily long squares: indeed it is a fixed point of the morphism σ defined on $\{0, 1\}$ by:

$$\sigma(0) = 01, \quad \sigma(1) = 10.$$

This sequence begins by $0110\dots$ hence by $\sigma^k(0)\sigma^k(1)\sigma^k(1)\sigma^k(0)$ for every $k \geq 2$. Hence it contains the square $\sigma^k(1)\sigma^k(1)$.

1.2. Why study repetitions?

When he asked the above questions concerning repetitions in sequences, Thue added that he had no particular applications in mind but that the problem seemed interesting and not trivial; there would certainly be applications in the future.

And indeed this question has been studied very precisely by computer scientists, see for example [11], see also [8]. The notion of morphism was again an essential tool: our leitmotiv is that *sequences generated by morphism are both easy to construct and not necessarily trivial*.

The existence of repetitions is somehow linked to randomness: a random sequence is expected to be *normal*, (i.e. all possible blocks of given length occur with the same frequency), hence a sequence without squares (or cubes or \dots) cannot be random.

We finally mention a paper of Bovier and Ghez [9] on the discrete Schrödinger equation with automatic potential where, curiously enough, one needs the automatic sequence of potentials to begin with a square. For more information on “automatic Schrödinger equations” one can read the contribution of Sütő [17] in this volume, one can also read [6], [7].

1.3. More examples

We quote here two results which are interesting in that they lead to other developments that we will not describe here.

- *The paperfolding sequence has no square ww with $|w| \geq 5$.* This result is announced in [1] and more details can be found in [2]. This implies that this sequence does not contain any 12^{th} power, i.e. that no block has the form w^{12} , but a more precise result is proved in [2]: *the paperfolding sequence has no fourth power*. The result holds for *any* paperfolding sequence. For the Rudin-Shapiro sequence(s) some results of the same kind are also given in [2].

- *The Fibonacci sequence has no fourth power*. It does however contain cubes since it begins by:

$$010010100(10010)(10010)(10010)\dots$$

Considering this sequence one might also define fractional powers: for example 10010010 is a power $2 + \frac{2}{3} = \frac{8}{3}$, as it can be written $(100)(100)(10)$. Considering

the supremum of the fractional powers which occur in an infinite word permits us to define a real maximal (positive) power occurring in a sequence. For the Fibonacci sequence one can prove that this maximal power is equal to $2 + \tau = 3.618\dots$, see [13].

2. MULTIDIMENSIONAL MORPHISMS AND (FINITE) AUTOMATA

Going back to the Penrose tiling, remember that the underlying morphism is the Fibonacci morphism:

$$0 \longrightarrow 01, \quad 1 \longrightarrow 0.$$

This morphism is a one-dimensional morphism and it might seem odd to describe a two-dimensional pattern by means of a one-dimensional tool. Among the possible generalizations of morphisms we will describe the two-dimensional substitutions and the associated two-dimensional finite automata. Although these morphisms are not suitable to describe the Penrose tiling, they are a natural generalization of the uniform morphisms and have many interesting properties.

2.1. An example

Consider the alphabet $\{0, 1\}$ and the following map:

$$0 \longrightarrow \begin{matrix} 0 & 0 & 0 \\ 0 & 0 & 0 \\ 0 & 0 & 0 \end{matrix} \quad 1 \longrightarrow \begin{matrix} 1 & 0 & 1 \\ 0 & 1 & 0 \\ 1 & 0 & 1 \end{matrix}.$$

Starting from the letter 1 and iterating this map by replacing each letter by a 3×3 square gives:

$$1 \longrightarrow \begin{matrix} 1 & 0 & 1 \\ 0 & 1 & 0 \\ 1 & 0 & 1 \end{matrix} \longrightarrow \begin{matrix} 1 & 0 & 1 & 0 & 0 & 0 & 1 & 0 & 1 \\ 0 & 1 & 0 & 0 & 0 & 0 & 0 & 1 & 0 \\ 1 & 0 & 1 & 0 & 0 & 0 & 1 & 0 & 1 \\ 0 & 0 & 0 & 1 & 0 & 1 & 0 & 0 & 0 \\ 0 & 0 & 0 & 0 & 1 & 0 & 0 & 0 & 0 \\ 0 & 0 & 0 & 1 & 0 & 1 & 0 & 0 & 0 \end{matrix} \longrightarrow \dots$$

$$\begin{matrix} 1 & 0 & 1 \\ 0 & 1 & 0 \\ 1 & 0 & 1 \end{matrix}$$

An infinite number of iterations leads to the double infinite sequence:

$$\begin{array}{cccccccccc}
 1 & 0 & 1 & 0 & 0 & 0 & 1 & 0 & 1 & \dots \\
 0 & 1 & 0 & 0 & 0 & 0 & 0 & 1 & 0 & \dots \\
 1 & 0 & 1 & 0 & 0 & 0 & 1 & 0 & 1 & \dots \\
 0 & 0 & 0 & 1 & 0 & 1 & 0 & 0 & 0 & \dots \\
 0 & 0 & 0 & 0 & 1 & 0 & 0 & 0 & 0 & \dots \\
 0 & 0 & 0 & 1 & 0 & 1 & 0 & 0 & 0 & \dots \\
 1 & 0 & 1 & 0 & 0 & 0 & 1 & 0 & 1 & \dots \\
 0 & 1 & 0 & 0 & 0 & 0 & 0 & 1 & 0 & \dots \\
 1 & 0 & 1 & 0 & 0 & 0 & 1 & 0 & 1 & \dots \\
 \vdots & \vdots & \vdots & \vdots & \vdots & \vdots & \vdots & \vdots & \vdots & \vdots
 \end{array}$$

which is by construction a fixed point of this morphism.

2.2. Properties

This construction, which can be extended to any dimension, gives rise to multi-indexed sequences with many arithmetic properties (see [14] and [15]). Note in particular that all lines, columns and diagonals of the above sequence are 3-automatic. Quite obviously the same construction can be done with any integer $d \geq 2$ instead of 3.

These sequences can be used in Physics: an application to the Robinson tiling is given in [5]. One could also imagine a two-dimensional discrete Schrödinger equation with potentials generated this way, thus permitting to study the eigenfrequencies of, say, a two-dimensional quasicrystalline mattress of springs or of a quasicrystalline *tremolino*. To our knowledge this has not yet been studied.

Another application to Physics is the construction of classical *fractal* figures: first note that the *constant renormalization* we alluded to in Part I, paragraph 2, can be interpreted as *self-similarity* for one-dimensional automatic sequences; in the same way double automatic sequences are self-similar. Take the above example, replace the 1's by black squares and the 0's by white squares; after each iteration renormalize the pattern of black and white squares. This gives the well-known Sierpinski triangle. Compare with the classical construction which can be seen as "dual". Many such fractals can be found in the Appendix by Shallit to the paper [14], see also [16].

A last example is given by ... the handkerchief-folding, [14].

3. LINKS WITH CELLULAR AUTOMATA

Cellular automata are often used in Physics. They have been introduced by von Neumann and they are discrete tools to mimick phenomena which can be continuous. From the point of view of their computing power they are equivalent to Turing machines, hence they are strictly more powerful in general than finite automata. Many books on cellular automata have been published. See

for example [10]. For an example of a two-dimensional cellular automaton as a model of a chemical reaction one can read [4], where the Greenberg and Hastings model of the Belousov-Zhabotinski-Zaikin oscillating reaction is discussed in detail.

Let us give a quick definition of cellular automata. A cellular automaton consists of:

- a lattice, \mathbb{Z}^d . Each vertex is called a site or a cell;
- a (usually finite) neighbourhood of sites V_i for each site $i \in \mathbb{Z}^d$, such that $V_i = V_j + i - j$, (translation invariance). The most frequently used neighbourhoods in two dimensions are the von Neumann and the Moore neighbourhood, (see below);
- a set of states Q , (usually finite);
- a map f , called the transition function, from Q^v to Q , where v is the cardinality of each V_i .

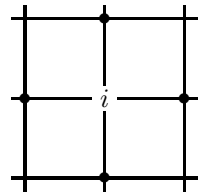

von Neumann's
neighbourhood of
 i in dimension 2

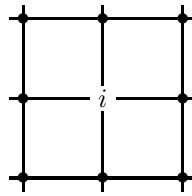

Moore's
neighbourhood of
 i in dimension 2

The evolution of the cellular automaton is the following: one assigns to each site i an element x_i^0 in Q . The set

$$\mathcal{C}_0 = \{x_i^0, i \in \mathbb{Z}^d\}$$

is called the initial configuration. For each i one then defines x_i^1 as the image by f of $(x_j^0)_{j \in V_i}$. Hence the set

$$\mathcal{C}_1 = \{x_i^1, i \in \mathbb{Z}^d\}$$

is constructed by parallel updating. One writes $\mathcal{C}_1 = f(\mathcal{C}_0)$. Similarly $\mathcal{C}_2 = f(\mathcal{C}_1)$, \dots , $\mathcal{C}_{n+1} = f(\mathcal{C}_n)$. The index of iteration n is sometimes called the (discrete) time-scale.

For many results on the dynamical behaviour of cellular automata we refer to [12] and its bibliography.

In the case where the lattice is one-dimensional, one usually draws a two-dimensional pattern each line of which is a configuration \mathcal{C}_i . A simple class in one dimension is the class of linear cellular automata: the values of the sites

are taken in $\mathbb{Z}/d\mathbb{Z}$ the ring of integers modulo d and the transition rules are linear.

For example the cellular automaton given by the Pascal's triangle rule modulo d is linear. The two-dimensional pattern it generates is exactly the double sequence $u = ((u_{m,n})_{m,n})$ where $u_{m,n} = \binom{m}{n} \pmod{d}$, hence the Sierpinski triangle modulo d (up to rotation). It has been proved in [3] that *the sequence u is a double automatic sequence if and only if d is equal to a prime power p^k . The sequence u is then p -automatic.*

References

- [1] Allouche J.-P., Suites infinies à répétitions bornées, *Séminaire de Théorie des Nombres de Bordeaux, Exposé 20* (1983–1984) 20-01–20-11.
- [2] Allouche J.-P., Bousquet-Mélou M., Facteurs des suites de Rudin-Shapiro généralisées, *Bull. Belg. Math. Soc.* **1** (1994) 145–164.
- [3] Allouche J.-P., von Haeseler F., Peitgen H.-O., Skordev G., Linear cellular automata, finite automata and Pascal's triangle, *Discrete Appl. Math.* (1995) to appear.
- [4] Allouche J.-P., Reder C., Oscillations spatio-temporelles engendrées par un automate cellulaire, *Discrete Appl. Math.* **8** (1984) 215–254.
- [5] Allouche J.-P., Salon O., Robinson tilings and 2-dimensional automata, in: *Quasicrystals, Networks and Molecules of Fivefold Symmetry*, I. Hargittai Ed (VCH Publishers Inc., 1990) p. 97–105.
- [6] Axel F., Allouche J.-P., Kléman M., Mendès France M., Peyrière J., Vibrational modes in a one dimensional “quasi-alloy”, the Morse case, *J. Phys. Colloques, 1986, Workshop on aperiodic crystals, Les Houches* (1986) 11–20.
- [7] Axel F., Peyrière J., Spectrum and extended states in a harmonic chain with controlled disorder: effects of the Thue-Morse symmetry, *J. Stat. Phys.* **57** (1989) 1013–1047.
- [8] Berstel J., Sur la construction de mots sans carré, *Séminaire de Théorie des Nombres de Bordeaux, Exposé 18* (1978–1979) 18-01–18-15.
- [9] Bovier A., Ghez J.-M., Spectral properties of one-dimensional Schrödinger operators with potentials generated by substitutions, *Comm. Math. Phys.* **158** (1993) 45–66.
- [10] Burks A. W., *Essays on cellular automata* (University of Illinois Press, 1970).
- [11] Cassaigne J., *Motifs évitables et régularités dans les mots* (Thèse, Université Paris 6/7, 1994).
- [12] Goles E., Martínez S., *Neural and automata networks* (Mathematics and its applications, **58**, 1991).
- [13] Mignosi F., Pirillo G., Repetitions in the Fibonacci infinite word, *RAIRO, Informatique Théorique et Applications* **26** (1992) 199–204.

- [14] Salon O., Suites automatiques à multi-indices, *Séminaire de Théorie des Nombres de Bordeaux, Exposé 4* (1986–1987) 4-01–4-27; followed by an appendix by Shallit J., 4-29A–4-36A.
- [15] Salon O., Suites automatiques à multi-indices et algébricité, *C. R. Acad. Sci. Paris, Série I* **305** (1987) 501–504.
- [16] Shallit J., Stolfi J., Two methods for generating fractals, *Comp. and Graphics* **13** (1989) 185–191.
- [17] Sütő A., *this volume*.
- [18] Thue A., Über unendliche Zeichenreihen, *Norske vid. Selsk. Skr. I. Mat. Kl. Christiana* **7** (1906) 1–22.
- [19] Thue A., Lage gleicher Teile gewisse Zeichenreihen, *Norske vid. Selsk. Skr. I. Mat. Kl. Christiana* **1** (1912) 1–67.

PART IV

Fourier analysis

We present a rather naive point of view on the Fourier analysis of complex valued sequences. For a deeper understanding the reader is referred to Martine Queffélec's contribution to this volume [8].

1. FOURIER-BOHR COEFFICIENTS

Let $f = (f(n))$ be an infinite sequence of complex numbers such that for all $\lambda \in \mathbb{R}$ the limit

$$\widehat{f}(\lambda) = \lim_{N \rightarrow \infty} \frac{1}{N} \sum_{n=0}^{N-1} f(n) \exp(-2i\pi\lambda n)$$

exists. This hypothesis is rather strong and eliminates such sequences as

$$f(n) = \exp(2i\pi \log n), \quad (n \geq 1),$$

for which the limit does not exist for $\lambda = 0$.

Observe that whenever the hypothesis is fulfilled $\widehat{f}(\lambda + 1) = \widehat{f}(\lambda)$ so that it is enough to restrict λ to the interval $[0, 1[$.

From now on we shall always assume the existence of $\widehat{f}(\lambda)$ for all $\lambda \in [0, 1[$. Under this assumption it can be shown that the *spectrum* of f (the Fourier-Bohr spectrum)

$$S(f) = \{\lambda \mid \widehat{f}(\lambda) \neq 0\}$$

is *at most countable*. We use the notation

$$f(n) \sim \sum_{\lambda \in S(f)} \widehat{f}(\lambda) \exp 2i\pi\lambda n.$$

Warning: The series may well diverge. We do not specify in which order the terms are to be written down. Even if the the series converges (whatever we mean by convergence!) its sum may be different from f .

We now present some examples which can be considered as exercises.

Example 1. $f(n) = \exp(2i\pi \log n)$.

As we already mentioned, $\widehat{f}(0)$ does not exist.

Example 2. Let $\alpha \in \mathbb{R}$ and define $f(n) = (-1)^{[\alpha n]}$ where $[\dots]$ denotes the integer part. One can show that the spectrum is

$$S(f) = \left\{ \frac{\alpha}{2} + k\alpha \mid k \in \mathbb{Z} \right\} \pmod{1}.$$

Observe that when $\alpha = p/q$, $(p, q) = 1$, is rational, the spectrum boils down to the finite set

$$\left\{ \frac{\alpha}{2} + \frac{k}{q} \mid k = 0, 1, \dots, q-1 \right\} \pmod{1}.$$

When α is irrational

$$(-1)^{[\alpha n]} \sim \frac{2}{i\pi} \sum_{k \in \mathbb{Z}} \frac{1}{2k+1} \exp 2i\pi \left(k + \frac{1}{2} \right) \alpha n.$$

Exercise: what is the corresponding formula when α is rational?

Example 3. Let $f(n) = (-1)^{s(n)}$ be the \pm Thue-Morse sequence ($s(n)$ is the sum of the binary digits of n). Then $\widehat{f}(\lambda) = 0$ for all λ hence

$$f(n) \sim 0.$$

This result may be seen as a consequence of our Appendix 1. However a direct computation is possible.

Example 4. The Rudin-Shapiro (\pm) sequence has empty spectrum:

$$f(n) \sim 0.$$

Example 5. Let α be irrational. Consider $f(n) = (-1)^{[\alpha n^2]}$. Then as in the preceding cases, the spectrum is empty and therefore

$$f(n) \sim 0.$$

This example is worked out in the paper of J. Bass [1].

Example 6. Let $f(n)$ be the regular paperfolding sequence with values ± 1 . Then

$$\widehat{f}(\lambda) = \begin{cases} \frac{i(-1)^{a-1}}{2^{\nu+1}} & \text{if } \lambda = \frac{2a+1}{2^{\nu+2}}, \nu \geq 0, 0 \leq a < 2^{\nu+1} \\ 0 & \text{if not} \end{cases}$$

and

$$f(n-1) \sim \sum_{\nu=0}^{\infty} \sum_{a=0}^{2^{\nu+1}-1} \frac{i(-1)^{a-1}}{2^{\nu+1}} \exp 2i\pi \frac{2a+1}{2^{\nu+2}} n.$$

Examples 3 and 6 will be worked out explicitly in the appendices (Paragraphs 5 and 6).

2. BESSEL'S INEQUALITY AND PARSEVAL'S EQUALITY

Define the norm of a sequence $f = (f(n))$ by

$$\|f\| = \limsup_{N \rightarrow \infty} \left(\frac{1}{N} \sum_{n=0}^{N-1} |f(n)|^2 \right)^{1/2}.$$

This is really a semi-norm since it may well happen that $\|f\| = 0$ and yet $f \neq (0, 0, 0, \dots)$.

Here are two such examples:

$$f = \left(1, \frac{1}{2}, \frac{1}{3}, \frac{1}{4}, \frac{1}{5}, \dots, \frac{1}{n}, \dots \right)$$

and

$$f = (1, \overbrace{0}^{2^0}, 1, \overbrace{0,0}^{2^1}, 1, \overbrace{0,0,0,0}^{2^2}, 1, \overbrace{0, \dots, 0}^{2^3}, 1, \overbrace{0, \dots}^{2^4})$$

In this last example, the density of 1's vanishes.

From now on we identify two sequences f and g as soon as $\|f - g\| = 0$, so that the two above examples are considered as null sequences.

Bessel's inequality asserts that in all cases

$$\sum_{\lambda \in S(f)} |\hat{f}(\lambda)|^2 \leq \|f\|^2.$$

A series of sequences $u_k(\cdot)$ defined on \mathbb{N} is said to converge to a sequence $s(\cdot)$ with respect to the norm $\|\dots\|$ if

$$\lim_{K \rightarrow \infty} \left\| s(\cdot) - \sum_{k=0}^K u_k(\cdot) \right\| = 0.$$

In other words

$$\lim_{K \rightarrow \infty} \limsup_{N \rightarrow \infty} \left(\frac{1}{N} \sum_{n=0}^{N-1} \left| s(n) - \sum_{k=0}^K u_k(n) \right|^2 \right)^{\frac{1}{2}} = 0.$$

We then write

$$s(n) \cong \sum_{k=0}^{\infty} u_k(n).$$

This must not be confused with a pointwise convergence.

THEOREM 1. (*Parseval [9]*)

$$\sum_{\lambda \in S(f)} \widehat{f}(\lambda) \exp 2i\pi\lambda n \cong f(n)$$

if and only if

$$\sum_{\lambda \in S(f)} |\widehat{f}(\lambda)|^2 = \|f\|^2.$$

In this case we say that f is an almost-periodic sequence in the sense of Besicovitch; f is represented by a sum of exponentials.

We leave it to the reader to verify that $(-1)^{[\alpha n]}$ and that the paperfolding sequence are Besicovitch almost-periodic. Obviously the Thue-Morse sequence, the Rudin-Shapiro sequence and $(-1)^{[\alpha n^2]}$ (α irrational) are not since Parseval's equality does not hold.

3. THE WIENER SPECTRUM AND THE SPECTRAL MEASURE

The correlation function γ^f which we assume to exist for all $h \in \mathbb{Z}$ is defined by

$$\gamma^f(h) = \lim_{N \rightarrow \infty} \frac{1}{N} \sum_{n=0}^{N-1} \overline{f(n)} f(n+h).$$

A deep result of Bochner's and Herglotz's asserts the existence of a bounded increasing function σ^f such that

$$\gamma^f(h) = \int_0^1 \exp 2i\pi hx \, d\sigma^f(x).$$

$d\sigma^f$ is known as the spectral measure of f .

Let E be a measurable subset of the unit interval. Its σ^f measure is denoted

$$\sigma^f\{E\} = \int_E d\sigma^f(x).$$

In particular, let $\lambda \in]0, 1[$. The measure of the set $\{\lambda\}$ is

$$\sigma^f\{\lambda\} = \lim_{\varepsilon \searrow 0} \int_{\lambda-\varepsilon}^{\lambda+\varepsilon} d\sigma^f(x) = \lim_{\varepsilon \searrow 0} (\sigma^f(\lambda + \varepsilon) - \sigma^f(\lambda - \varepsilon)).$$

Similarly

$$\sigma^f\{1\} = \lim_{\varepsilon \searrow 0} \int_{1-\varepsilon}^1 d\sigma^f(x)$$

and

$$\sigma^f\{0\} = \lim_{\varepsilon \searrow 0} \int_0^\varepsilon d\sigma^f(x).$$

One should not confuse the measure $\sigma^f\{\lambda\}$ of the set $\{\lambda\}$ with the value $\sigma^f(\lambda)$ of the function σ^f at λ . There is of course a trivial relationship between both

$$\sigma^f\{\lambda\} = \sigma^f(\lambda + 0) - \sigma^f(\lambda - 0);$$

$\sigma^f\{\lambda\}$ is the length of the discontinuity at λ . In particular if σ^f is continuous at λ then $\sigma^f\{\lambda\} = 0$ and conversely.

The set of λ 's such that $\sigma^f\{\lambda\} \neq 0$ is called the *Wiener spectrum* and we denote it $W(f)$. It is obviously at most countable, (indeed the number of steps is at most countable).

Lebesgue's decomposition theorem asserts that σ^f is the sum of three increasing functions

$$\sigma^f = \sigma_{st}^f + \sigma_{ac}^f + \sigma_{sg}^f$$

or

$$d\sigma^f = d\sigma_{st}^f + d\sigma_{ac}^f + d\sigma_{sg}^f,$$

where σ_{st}^f is a step function, σ_{ac}^f is absolutely continuous (it is the primitive of its derivative) and σ_{sg}^f is continuous singular (its derivative vanishes almost everywhere with respect to the Lebesgue measure).

THEOREM 2. (*Bertrandias [2]*)

$$|\widehat{f}(\lambda)| \leq \sqrt{\sigma^f\{\lambda\}}.$$

This important result shows that the Fourier-Bohr spectrum of f is a subset of the Wiener spectrum: $S(f) \subseteq W(f)$. In particular if σ^f is continuous, then $\widehat{f}(\lambda) = 0$ for all λ , but the converse is not true.

Here are some examples:

$$f(n) = \exp(2i\pi\alpha n^2), \alpha \text{ irrational} \quad : \quad d\sigma^f(x) = dx, \text{ the Lebesgue measure,} \\ \text{(see [1]);}$$

$$f(n) \text{ is the Thue-Morse sequence} \quad : \quad d\sigma^f \text{ is purely singular,} \\ \text{(see Appendix 1);}$$

$$f(n) \text{ is the Rudin-Shapiro sequence} \quad : \quad d\sigma^f(x) = dx, \text{ the Lebesgue measure;}$$

$$f(n) = \exp 2i\pi\alpha n \quad : \quad d\sigma^f(x) = \delta_\alpha, \text{ the Dirac mass at } \alpha;$$

$$f(n) = \exp 2i\pi\sqrt{n} \quad : \quad d\sigma^f(x) = \delta_0.$$

If f is a Besicovitch almost-periodic function

$$f(n) \cong \sum_{\lambda \in S(f)} \widehat{f}(\lambda) \exp 2i\pi\lambda n,$$

then

$$d\sigma^f(x) = \sum_{\lambda \in S(f)} |\widehat{f}(\lambda)|^2 \delta_\lambda.$$

By definition a mean-periodic sequence f is a sequence whose spectral measure is a sum of Dirac masses. A Besicovitch almost-periodic function is therefore mean-periodic. The converse is false as the example $f(n) = \exp 2\pi i \sqrt{n}$ shows.

In 1958 J. Bass [1] defined the family of pseudo-random functions and sequences. His definition, modified by J.-P. Bertrandias [2] is that $f(n)$ is pseudo-random if σ^f is continuous. This is known to be equivalent to the condition

$$\lim_{N \rightarrow \infty} \frac{1}{N} \sum_{k \leq N} |\gamma^f(h)|^2 = 0,$$

i.e. $\gamma^f(h)$ tends in average to 0 as h increases to infinity.

We conclude this paragraph by a diagram which illustrates the relationship between the different classes we discussed.

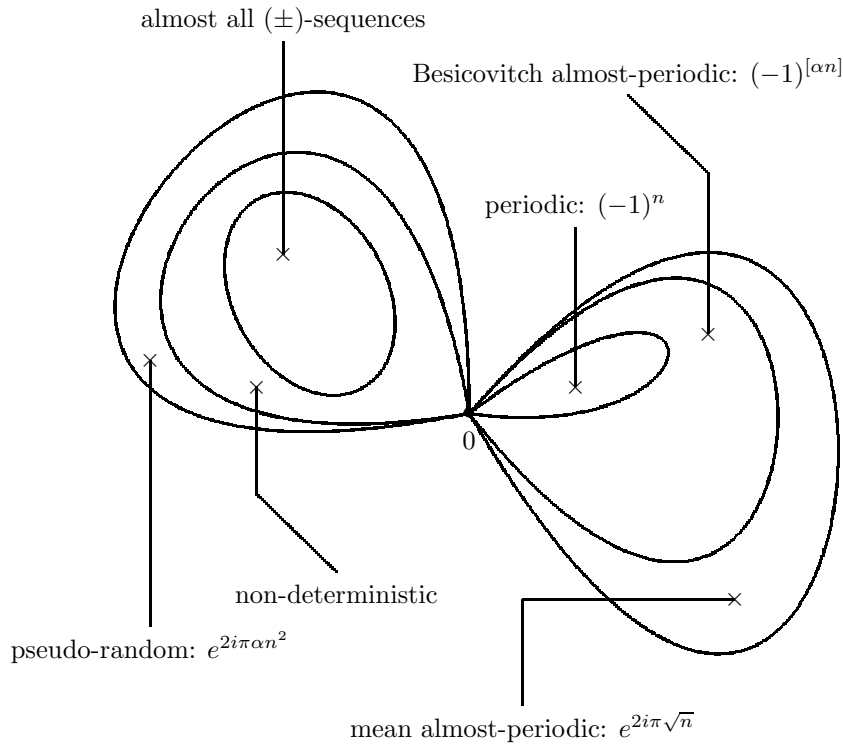

4. ANALYZING THE SPECTRAL MEASURE

We are given the sequence $f = (f(n))$ and we assume that the Fourier-Bohr coefficients and the correlation exist.

Case 1. Parseval's equality holds. Then the spectral measure $d\sigma^f$ is discrete (i.e. a sum of Dirac masses or Bragg peaks, σ^f is a step function):

$$d\sigma^f = \sum_{\lambda \in S(f)} |\widehat{f}(\lambda)|^2 \delta_\lambda.$$

f is Besicovitch almost-periodic.

Case 2. Suppose $S(f) = \emptyset$. A theorem of Wiener's asserts that

$$\lim_{N \rightarrow \infty} \frac{1}{N} \sum_{n < N} |\gamma^f(n)|^2 = \sum_{\lambda \in W(f)} (\sigma^f\{\lambda\})^2,$$

where $\sigma^f\{\lambda\}$ is the mass at λ . Hence we have a first important result which we already mentioned in Paragraph 3:

If

$$\lim_{N \rightarrow \infty} \frac{1}{N} \sum_{n < N} |\gamma^f(n)|^2 = 0,$$

then $d\sigma^f$ is continuous, and conversely.

The question arises to decide whether $d\sigma^f$ is absolutely continuous or purely singular (or sum of both). A well known result of Riemann and Lebesgue shows that if $d\sigma^f$ is absolutely continuous then

$$\gamma^f(n) = \int_0^1 e^{2i\pi nx} d\sigma^f(x)$$

tends to zero as n increases to infinity. Therefore if

$$\limsup_{n \rightarrow \infty} |\gamma^f(n)| > 0,$$

there is a nonzero singular component to $d\sigma^f$.

We shall illustrate these ideas in the following appendices.

5. APPENDIX I: THE SPECTRAL MEASURE OF THE THUE-MORSE SEQUENCE

Let $f = (f(n))$ be the \pm Thue-Morse sequence. We show that its spectral measure is singular continuous.

We first notice that $f(2n) = f(n)$ and $f(2n+1) = -f(n)$, ($f(0) = 1$). We shall compute the correlation function

$$\gamma(h) = \lim_{N \rightarrow \infty} \frac{1}{N} \sum_{n \in N} \bar{f}(n) f(n+h).$$

One of the difficulties is to prove that $\gamma(h)$ actually exists. Obviously $\gamma(0) = 1$.

Define

$$\begin{aligned} S(N, h) &= \sum_{n < N} \bar{f}(n) f(n+h) \\ &= \begin{cases} \sum_{m < \frac{N}{2}} \bar{f}(2m) f(2m+h) \\ + \sum_{m < \frac{N}{2}} \bar{f}(2m+1) f(2m+1+h) + O(1). \end{cases} \\ S(N, 2k+1) &= \begin{cases} \sum_{m < \frac{N}{2}} \bar{f}(2m) f(2m+2k+1) \\ + \sum_{m < \frac{N}{2}} \bar{f}(2m+1) f(2m+2k+2) + O(1) \end{cases} \\ &= - \sum_{m < \frac{N}{2}} \bar{f}(m) f(m+k) - \sum_{m < \frac{N}{2}} \bar{f}(m) f(m+k+1) + O(1). \end{aligned}$$

Hence

$$(1) \quad S(N, 2k+1) = -S\left(\frac{N}{2}, k\right) - S\left(\frac{N}{2}, k+1\right) + O(1).$$

Similarly

$$(2) \quad \begin{aligned} S(N, 2k) &= S\left(\frac{N}{2}, k\right) + S\left(\frac{N}{2}, k\right) + O(1) \\ &= 2S\left(\frac{N}{2}, k\right) + O(1). \end{aligned}$$

In our first recurrence relation choose $k = 0$, divide by N and let N go to infinity. Define

$$\begin{cases} \gamma^*(h) = \limsup_{N \rightarrow \infty} \frac{1}{N} \sum_{n < N} f(n) f(n+h), \\ \gamma_*(h) = \liminf_{N \rightarrow \infty} \frac{1}{N} \sum_{n < N} f(n) f(n+h). \end{cases}$$

Then

$$\begin{cases} \gamma^*(1) = -\frac{1}{2} - \frac{1}{2}\gamma_*(1), \\ \gamma_*(1) = -\frac{1}{2} - \frac{1}{2}\gamma^*(1). \end{cases}$$

These two equations with two unknowns show that

$$\gamma_*(1) = \gamma^*(1) = -\frac{1}{3}.$$

Therefore $\gamma(1)$ exists and its value is $-1/3$.

We now assume $\gamma(k)$ exists for all $k < 2K$. Then equation (2) implies that $\gamma(2K)$ exists and

$$\gamma(2K) = \gamma(K).$$

Now equation (1) shows that $\gamma(2K + 1)$ exists and

$$\gamma(2K + 1) = -\frac{1}{2}(\gamma(K) + \gamma(K + 1)).$$

We know there exists a measure $d\sigma$ such that

$$\gamma(K) = \int_0^1 e^{2i\pi Kx} d\sigma(x).$$

Let us show that $d\sigma$ is a continuous measure. It suffices to show that

$$\lim_{N \rightarrow \infty} \frac{1}{N} \sum_{k < N} |\gamma(k)|^2 = 0.$$

Put

$$\Gamma(h) = \lim_{N \rightarrow \infty} \frac{1}{N} \sum_{n < N} \bar{\gamma}(n)\gamma(n + h)$$

(it can easily be established that the limit exists for all $h \in \mathbb{Z}$). Define

$$\begin{aligned}
 T(N, h) &= \sum_{n < N} \bar{\gamma}(n) \gamma(n+h) \\
 &= \sum_{n < \frac{N}{2}} \bar{\gamma}(2n) \gamma(2n+h) + \sum_{n < \frac{N}{2}} \bar{\gamma}(2n+1) \gamma(2n+1+h) + O(1), \\
 T(N, 2k) &= \sum_{n < \frac{N}{2}} \bar{\gamma}(2n) \gamma(2n+2k) + \sum_{n < \frac{N}{2}} \bar{\gamma}(2n+1) \gamma(2n+1+2k) + O(1) \\
 &= \begin{cases} T\left(\frac{N}{2}, k\right) \\ + \frac{1}{4} \sum_{n < \frac{N}{2}} (\gamma(n) + \gamma(n+1))(\gamma(n+k) + \gamma(n+k+1)) + O(1) \end{cases} \\
 &= \begin{cases} T\left(\frac{N}{2}, k\right) \\ + \frac{1}{4} \left(2T\left(\frac{N}{2}, k\right) + T\left(\frac{N}{2}, k+1\right) + T\left(\frac{N}{2}, k-1\right) \right) + O(1). \end{cases}
 \end{aligned}$$

Therefore

$$\begin{aligned}
 \Gamma(2k) &= \frac{1}{2} \Gamma(k) + \frac{1}{4} \Gamma(k) + \frac{1}{8} \Gamma(k+1) + \frac{1}{8} \Gamma(k-1) \\
 &= \frac{3}{4} \Gamma(k) + \frac{1}{8} \Gamma(k+1) + \frac{1}{8} \Gamma(k-1).
 \end{aligned}$$

For $k = 0$,

$$\Gamma(0) = \frac{3}{4} \Gamma(0) + \frac{1}{8} \Gamma(1) + \frac{1}{8} \Gamma(-1).$$

But γ is real valued, so that Γ is real valued hence $\Gamma(-1) = \Gamma(1)$. Therefore

$$(3) \quad \Gamma(0) = \Gamma(1).$$

On the other hand

$$T(N, 2k+1) = \begin{cases} -\frac{1}{2} T\left(\frac{N}{2}, k\right) - \frac{1}{2} T\left(\frac{N}{2}, k+1\right) \\ -\frac{1}{2} T\left(\frac{N}{2}, k\right) - \frac{1}{2} T\left(\frac{N}{2}, k-1\right) + O(1), \end{cases}$$

hence

$$\Gamma(2k+1) = -\frac{1}{2} \Gamma(k) - \frac{1}{4} \Gamma(k+1) - \frac{1}{4} \Gamma(k-1).$$

For $k = 0$,

$$\Gamma(0) = -3\Gamma(1).$$

This, compared with equality (3), implies that $\Gamma(0) = 0$ and this in turn implies that $d\sigma$ is a continuous measure.

Remember that $|\widehat{f}(\lambda)| \leq \sqrt{\sigma\{\lambda\}} = 0$ so that the Fourier-Bohr spectrum is empty.

So far we have thus established that the spectral measure $d\sigma$ is continuous and that the correlation γ satisfies the equations

$$(4) \quad \begin{cases} \gamma(0) = 1 \\ \gamma(2h) = \gamma(h) \\ \gamma(2h + 1) = -\frac{1}{2}[\gamma(h) + \gamma(h + 1)]. \end{cases}$$

Observe that $\gamma(2^n) = \gamma(2^{n-1}) = \dots = \gamma(1) = -\frac{1}{3}$ hence

$$\limsup_{n \rightarrow \infty} |\gamma(n)| \geq \frac{1}{3}.$$

This shows that $d\sigma$ has a nonzero singular component $d\sigma_{sg}$

$$d\sigma = d\sigma_{ac} + d\sigma_{sg}.$$

We shall now prove that $d\sigma_{ac} = 0$. To simplify notations put

$$\sigma_{ac} = \sigma_1 \quad \text{and} \quad \sigma_{sg} = \sigma_2,$$

and

$$\gamma_1(n) = \int_0^1 e^{2i\pi nx} d\sigma_1(x), \quad \gamma_2(n) = \int_0^1 e^{2i\pi nx} d\sigma_2(x).$$

The following equalities hold

$$\begin{aligned} \gamma(2n) &= \int_0^1 e^{2i\pi 2nx} d\sigma(x) \\ &= \int_0^2 e^{2i\pi nt} d\sigma\left(\frac{t}{2}\right) \\ &= \int_0^1 e^{2i\pi nt} d\sigma\left(\frac{t}{2}\right) + \int_1^2 e^{2i\pi nt} d\sigma\left(\frac{t}{2}\right) \end{aligned}$$

In the last integral put $t = u + 1$

$$\begin{aligned} \gamma(2n) &= \int_0^1 e^{2i\pi nu} d\sigma\left(\frac{t}{2}\right) + \int_0^1 e^{2i\pi nt} d\sigma\left(\frac{u+1}{2}\right) \\ &= \int_0^1 e^{2i\pi nt} d\left[\sigma\left(\frac{t}{2}\right) + \sigma\left(\frac{t+1}{2}\right)\right]. \end{aligned}$$

But $\gamma(2n) = \gamma(n)$, hence

$$d\sigma(t) = d\sigma\left(\frac{t}{2}\right) + d\sigma\left(\frac{t+1}{2}\right),$$

$$d\sigma_1(t) + d\sigma_2(t) = d\sigma_1\left(\frac{t}{2}\right) + d\sigma_2\left(\frac{t}{2}\right) + d\sigma_1\left(\frac{t+1}{2}\right) + d\sigma_2\left(\frac{t+1}{2}\right),$$

$$d\sigma_1(t) - d\sigma_1\left(\frac{t}{2}\right) - d\sigma_1\left(\frac{t+1}{2}\right) = d\sigma_2\left(\frac{t}{2}\right) + d\sigma_2\left(\frac{t+1}{2}\right) - d\sigma_2(t).$$

The left hand side represents an absolutely continuous measure and the right hand side a purely continuous singular measure. Therefore both vanish. In particular

$$d\sigma_1(t) = d\sigma_1\left(\frac{t}{2}\right) + d\sigma_1\left(\frac{t+1}{2}\right).$$

Reading the above calculation backwards, we see that

$$\gamma_1(2n) = \gamma_1(n)$$

and in the same fashion we can prove that

$$(5) \quad \gamma_1(2n+1) = -\frac{1}{2}(\gamma_1(n) + \gamma_1(n+1)).$$

Remember that $d\sigma_1$ is absolutely continuous hence

$$\gamma_1(n) \rightarrow 0 \quad \text{as} \quad n \rightarrow \infty,$$

so that in particular

$$\gamma_1(2^n) \rightarrow 0 \quad \text{as} \quad n \rightarrow \infty.$$

But $\gamma_1(2^n) = \gamma_1(1)$ hence $\gamma_1(1) = 0$. Equation (5) then implies with $n = 0$ that

$$\gamma_1(0) = 0 = \int_0^1 d\sigma_1(x).$$

Therefore $d\sigma_1 = 0$. We conclude that $d\sigma$ is indeed a purely continuous singular measure.

These results were known to Kakutani [4] and Mahler [5]. See also [3].

6. APPENDIX 2: THE SPECTRAL MEASURE OF THE PAPER-FOLDING SEQUENCE

Let $f = (f(n))$ be the (\pm) paperfolding sequence:

$$\begin{cases} f(2n) = (-1)^n \\ f(2n + 1) = f(n). \end{cases}$$

We shall prove that the sequence is Besicovitch almost-periodic.

To do so we compute the Fourier-Bohr coefficients

$$\widehat{f}(\lambda) = \lim_{N \rightarrow \infty} \frac{1}{N} \sum_{n < N} f(n) \exp(-2i\pi n\lambda).$$

Define

$$\begin{aligned} S(N, \lambda) &= \sum_{n < N} f(n) \exp(-2i\pi n\lambda) \\ &= \begin{cases} \sum_{m < N/2} f(2m) \exp(-2i\pi 2m\lambda) \\ + \sum_{m < N/2} f(2m + 1) \exp(-2i\pi(2m + 1)\lambda) \end{cases} \\ &= \begin{cases} \sum_{m < \frac{N}{2}} (-1)^m \exp(-4i\pi m\lambda) \\ + e^{-2i\pi\lambda} \sum_{m < \frac{N}{2}} f(m) \exp(-2i\pi 2m\lambda). \end{cases} \end{aligned}$$

The first sum is easily seen to be equal to

$$\sum_{m < N/2} \exp 2i\pi m \left(\frac{1}{2} - 2\lambda \right) = \frac{N}{2} \mathfrak{X}(\lambda) + O(1),$$

where

$$\mathfrak{X}(\lambda) = \begin{cases} 1 & \text{if } 2\lambda \in \frac{1}{2} + \mathbb{Z}, \\ 0 & \text{if not.} \end{cases}$$

To simplify notations we put $e(x) = \exp 2i\pi x$. The second sum is

$$e(-\lambda) S \left(\frac{N}{2}, 2\lambda \right),$$

so that

$$S(N, \lambda) = e(-\lambda)S\left(\frac{N}{2}, 2\lambda\right) + \frac{N}{2}\mathfrak{X}(\lambda) + O(1).$$

By induction

$$\begin{aligned} S(N, \lambda) &= e(-\lambda - 2\lambda)S\left(\frac{N}{2^2}, 2^2\lambda\right) + \frac{N}{2}\mathfrak{X}(\lambda) + \frac{N}{2^2}\mathfrak{X}(2\lambda)e(-\lambda) + O(1), \\ &= N \sum_{j=0}^{k-1} \frac{1}{2^{j+1}} \mathfrak{X}(2^j\lambda)e((1-2^j)\lambda) + e((1-2^k)\lambda)S\left(\frac{N}{2^k}, 2^k\lambda\right) \\ &\quad + k.O(1). \end{aligned}$$

Choose $k = 1 + \lceil \log N / \log 2 \rceil$. Then the sum $S(N2^{-k}, 2^k\lambda)$ is empty.

$$S(N, \lambda) = N \sum_{j=0}^{k-1} \frac{1}{2^{j+1}} \mathfrak{X}(2^j\lambda)e((1-2^j)\lambda) + O(\log N).$$

Divide by N and let N go to infinity:

$$\widehat{f}(\lambda) = \sum_{j=0}^{\infty} \frac{\mathfrak{X}(2^j\lambda)}{2^{j+1}} e((1-2^j)\lambda).$$

If λ is irrational or rational with denominator other than a power of 2, $\widehat{f}(\lambda) = 0$.

Suppose $\lambda = \frac{2a+1}{2^\ell}$ where a and ℓ are positive integers. Then

$$\mathfrak{X}\left(2^j \frac{2a+1}{2^\ell}\right) = \mathfrak{X}\left(\frac{2a+1}{2^{\ell-j}}\right) = \begin{cases} 1 & \text{if } j = \ell - 2, \\ 0 & \text{if not.} \end{cases}$$

The Fourier-Bohr coefficient boils down to

$$\begin{aligned} \widehat{f}\left(\frac{2a+1}{2^\ell}\right) &= \frac{1}{2^{\ell-1}} e\left((1-2^{\ell-2})\frac{2a+1}{2^\ell}\right), \quad \ell \geq 2 \\ &= i \frac{(-1)^{a-1}}{2^{\ell-1}} \exp\left(2i\pi \frac{2a+1}{2^\ell}\right). \end{aligned}$$

Then

$$\begin{aligned} f(n) &\sim \sum_{\ell=2}^{\infty} \sum_{a=0}^{2^{\ell-1}-1} i \frac{(-1)^{a-1}}{2^{\ell-1}} \exp 2i\pi \frac{2a+1}{2^\ell} \exp 2i\pi \frac{2a+1}{2^\ell} n \\ &\sim \sum_{\ell \geq 2} \sum_{a=0}^{2^{\ell-1}-1} \frac{i(-1)^{a-1}}{2^{\ell-1}} \exp\left(2i\pi \frac{2a+1}{2^\ell} (n+1)\right) \end{aligned}$$

It is now easy to see that Parseval's equality holds. Indeed

$$\begin{aligned} \sum_{\lambda} |\widehat{f}(\lambda)|^2 &= \sum_{\ell \geq 2} \sum_{a=0}^{2^{\ell-1}-1} \frac{1}{2^{2(\ell-1)}} \\ &= \sum_{\ell \geq 2} \frac{2^{\ell-1}}{2^{2(\ell-1)}} = \sum_{\ell \geq 2} \frac{1}{2^{\ell-1}} = 1 = \|f\|^2. \end{aligned}$$

This proves that the regular paperfolding sequence is Besicovitch almost-periodic. Its spectral measure is

$$d\sigma = \sum_{\ell=2}^{\infty} \frac{1}{4^{\ell-1}} \sum_{a=0}^{2^{\ell-1}-1} \delta_{\frac{2a+1}{2^{\ell}}}.$$

This result was first published in [6] where it is proved that all paperfolding sequences have the same spectral measure (but the Fourier-Bohr coefficients differ).

References

- [1] Bass J., Suites uniformément denses, moyennes trigonométriques, fonctions pseudo-aléatoires, *Bull. Soc. math. France* **87** (1959) 1–69.
- [2] Bertrandias J.-P., Espaces de fonctions bornées et continues en moyenne asymptotique d'ordre p , (Thèse), *Bull. Soc. math. France, Mémoire* **5** (1966) 3–106.
- [3] Coquet J., Kamae T., Mendès France M., Sur la mesure spectrale de certaines suites arithmétiques, *Bull. Soc. math. France* **105** (1977) 369–384.
- [4] Kakutani S., Strictly ergodic symbolic dynamical systems, in: Proceedings of the 6th Berkeley symposium on mathematical statistics and probability [1970 Berkeley] vol. 2 (Berkeley, University of California Press, 1972) p. 319–326.
- [5] Mahler K., On the translation properties of a simple class of arithmetical functions, *Jour. Math. and Phys.* **6** (1927) 158–163.
- [6] Mendès France M., van der Poorten A. J., Arithmetic and analytic properties of paperfolding sequences (dedicated to Kurt Mahler), *Bull. Austr. Math. Soc.* **24** (1981) 123–131.
- [7] Meyer Y., Le spectre de Wiener, *Studia Mathematica* **27** (1966) 189–201.
- [8] Queffélec M., *this volume*.
- [9] Wiener N., Generalized harmonic analysis, *Acta Math.* **55** (1930) 117–258.

PART V

Complexity of infinite sequences

Another approach to the order versus chaos paradigm consists of the study of the factor complexity of sequences. A factor of a (finite or infinite) sequence is a finite block of consecutive letters.

DEFINITION. *The complexity function (or for short the complexity) of an infinite sequence u with values in a finite alphabet A is the function $n \rightarrow p_u(n)$, where $p_u(n)$ denotes the number of factors of length n in the sequence u .*

Remarks

- Let u be any infinite sequence on the (finite) alphabet A . Then obviously $\forall n \geq 1, 1 \leq p_u(n) \leq (\#A)^n$. The function p_u is clearly increasing.

- If u is a “random” sequence, one expects it to be *normal*, i.e. every possible block of length n occurs with frequency $1/(\#A)^n$. In particular the complexity of such a sequence is maximal and is equal to $(\#A)^n$. On the other end of the spectrum it is not difficult to check that an ultimately periodic sequence has an ultimately constant complexity, (the converse holds with a weaker hypothesis, see below). Complexity distinguishes between normality and periodicity, and much more.

Note however that there exist algorithmically constructed sequences which are normal: the Champernowne sequence defined, say in base 2, by writing down consecutively the binary expansions of the integers,

0 1 10 11 100 101 110 111 1000 1001 1010 ...

is known to be normal.

- Using the above definition of complexity one defines the *topological entropy of a sequence u* as

$$h(u) = \lim_{n \rightarrow \infty} \frac{\log p_u(n)}{n \log \#A}.$$

The limit always exists. Clearly $0 \leq h(u) \leq 1$. If the structure of the sequence is simple, one expects $h(u) = 0$. On the contrary a complex structured sequence will have maximal entropy $h(u) = 1$. Needless to say for an automatic sequence $h(u) = 0$ and for a normal sequence $h(u) = 1$. For any $\alpha \in [0, 1]$ there exist sequences u for which $h(u) = \alpha$. The notion of entropy will be discussed in more details by V. Berthé in this volume [12].

- Many other notions of complexity exist for a sequence, a very interesting one being the Kolmogorov-Chaitin-Solomonoff complexity which compares a given finite or infinite sequence to the length of the smallest possible “program” which generates it, see [21].

1. STURMIAN SEQUENCES AND GENERALIZATIONS

We begin this paragraph with a theorem which shows that, if the complexity of a sequence is “not too large”, then the sequence is periodic from some point on, and this implies in turn that the complexity is ultimately constant.

THEOREM. [24], [25] and [15]

Let u be a sequence such that $\exists n \geq 1, p_u(n) \leq n$. Then the sequence u is ultimately periodic, (hence p_u is ultimately constant).

In view of this theorem the minimal possible complexity among the sequences which are not ultimately periodic is given by $p(n) = n + 1, \forall n \geq 1$. With $n = 1$ one sees that, if there exist such sequences, the alphabet must have cardinality 2. Such sequences actually exist, as shown by the following result. They are called *Sturmian sequences*.

THEOREM. To each Sturmian sequence $(u_n)_n$ on the alphabet $\{0, 1\}$ corresponds a unique couple $(\alpha, \beta) \in [0, 1]^2, \alpha$ irrational such that

$$\begin{aligned} & \text{- either } \forall n, u_n = \lfloor (n+1)\alpha + \beta \rfloor - \lfloor n\alpha + \beta \rfloor, \\ & \text{- or } \forall n, u_n = \lceil (n+1)\alpha + \beta \rceil - \lceil n\alpha + \beta \rceil, \end{aligned}$$

where $\lfloor x \rfloor$ is the usual integer part and $\lceil x \rceil = -\lfloor -x \rfloor$.

A nice survey on Sturmian sequences is [11].

Remarks

- The above theorem shows that Sturmian sequences can also be constructed by intersecting a two-dimensional lattice by a straight line with irrational slope. This implies that they can also be generated as billiard trajectories. In particular our friend *the Fibonacci sequence is a Sturmian sequence*. One should remark that very few Sturmian sequences can be generated by morphisms: the set of morphic sequences is countable, whereas the set of Sturmian sequences is not, since each of them is determined by a couple (α, β) . To know precisely which Sturmian sequences are fixed point of morphisms, one can read [16].

- One can study billiard trajectories in more than two dimensions. Some results for the complexity are known: for instance the three-dimensional irrational trajectories of billiard balls have complexity $n^2 + n + 1$, see [8] and [9], where interesting conjectures are given.

- One can play billiard in a triangle or in a convex polygon instead of playing in a square. The following has been proved in [19]: consider a polygonal billiard with angles $\frac{a_1}{r}\pi, \frac{a_2}{r}\pi, \dots, \frac{a_d}{r}\pi$, where $\gcd(a_1, a_2, \dots, a_d, r) = 1$, and start with any angle α (with a countable number of exceptions), then the complexity is: $p(n) = nr + (d-1)r$, for $n \geq n_0(\alpha)$. In particular $p(n) = 4n + 8$ for a right-angle triangle with two equal sides and $p(n) = 3n + 6$ for an equilateral triangle.

- Other sequences with geometric properties have been studied: sequences with complexity $2n + 1$, see [29], [10], [18] and [31], sequences with complexity $2n$, see [30] and [1]. Another class is defined as follows. Let Δ be the first difference operator: for a sequence u , the sequence Δu is defined by $(\Delta u)_n = u_{n+1} - u_n$. Now let α be an irrational number. Instead of considering the Sturmian sequence $([(n+1)\alpha] - [n\alpha]) = (\Delta u)_n$, where $u_n = [n\alpha]$, consider $\Delta^2 v$, where $v_n = [n^2\alpha]$. The complexity of this new sequence is given by [7]:

$$p(n) = \frac{(n+1)(n+2)(n+3)}{6}.$$

2. COMPLEXITY OF AUTOMATIC SEQUENCES

2.1. An upper bound

The first result was given by Cobham [14]. It states that the complexity of an automatic sequence is not too large.

THEOREM. [14]

If u is an automatic sequence, there exists a constant depending on u such that:

$$\forall n \geq 1, p_u(n) \leq Cn.$$

We list below some special results.

2.2. Complexity function of some automatic sequences

- If u is the Prouhet-Thue-Morse sequence, its complexity p_u is given by a ... rather complicated expression, see [22], [23] and [13], from which we shall only retain that the sequence $n \rightarrow p_u(n+1) - p_u(n)$ is a 2-automatic sequence. This result will be revisited below.

- If u is the (regular) paperfolding sequence, then its complexity function satisfies $\forall n \geq 7, p_u(n) = 4n$. Actually this result holds for *any* paperfolding sequence [2], and one can also prove that there is a kind of synchronization between the factors of different paperfolding sequences [5]. Note that the paperfolding sequences can be obtained as “Toeplitz sequences”, see [3] for a survey on Toeplitz sequences, and that the complexity of a class of Toeplitz sequences has been studied in [20].

- For the Rudin-Shapiro sequence one has $p(n) = 8n - 8, \forall n \geq 8$. This result can be extended to two generalizations of the Rudin-Shapiro sequence, see [2] and [6], see also [4]: let us just say here that one obtains again ultimately affine complexities.

- We quote finally in this paragraph the paper [26], where it is shown that, if u is an automatic sequence which satisfies some mild conditions, then its complexity function p_u has the property that $(p_u(n+1) - p_u(n))_n$ is also an

automatic sequence. The simple fact that this last sequence takes only finitely many values is by no means trivial.

2.3. The case of non-constant length morphisms

After the Fibonacci sequence which is Sturmian as we saw above, one can ask for the complexity function of the fixed points of non-constant length morphisms. The problem is more difficult, reflecting the fact that these sequences are more “complicated” than the automatic sequences.

It has been shown that the complexity of a sequence u fixed point of a non-constant length morphism satisfies $p(n) = O(n^2)$. In the case where the morphism is “primitive” (i.e. if there exists a power of the morphism such that the image of every single letter contains all the letters), this bound can be lowered to $p(n) = O(n)$. The most precise result can be found in [27] and [28] where it is proven that the complexity of any fixed point of a morphism has one of the following orders of magnitude:

$$\exists A, B > 0, \exists f \in \{1, n, n \log \log n, n \log n, n^2\}, \forall n \geq 1, Af(n) \leq p(n) \leq Bf(n).$$

Kolakoski’s sequence, which has already been discussed in Part I, is probably not generated by a non-constant length morphism. Its complexity is not known. It has been conjectured to be of the order of n^q , where $q = \frac{\log \frac{3}{2}}{\log \frac{3}{2}}$, see [17].

References

- [1] Alessandri P., Codage des rotations, Mémoire de D. E. A. (Université Claude Bernard, Lyon I, 1993).
- [2] Allouche J.-P., The number of factors in a paperfolding sequence, *Bull. Austr. Math. Soc.* **46** (1992) 23–32.
- [3] Allouche J.-P., Bacher R., Toeplitz sequences, paperfolding, Hanoi towers and progression-free sequences of integers, *Enseign. Math.* **38** (1992) 315–327.
- [4] Allouche J.-P., Bousquet-Mélou M., Facteurs des suites de Rudin-Shapiro généralisées, *Bull. Belg. Math. Soc.* **1** (1994) 145–164.
- [5] Allouche J.-P., Bousquet-Mélou M., Canonical positions for the factors in the paperfolding sequences, *Theoret. Comput. Sci.* **129** (1994) 263–278.
- [6] Allouche J.-P., Shallit J., Complexité des suites de Rudin-Shapiro généralisées, *Journal de Théorie des Nombres de Bordeaux* **5** (1993) 283–302.
- [7] Arnoux P., Mauduit C., Meigniez G., Sur la complexité de certaines suites arithmétiques, *in preparation*.
- [8] Arnoux P., Mauduit C., Shiokawa I., Tamura J. I., Complexity of sequences defined by billiards in the cube, *Bull. Soc. math. France* **122** (1994) 1–12.

- [9] Arnoux P., Mauduit C., Shiokawa I., Tamura J. I., Rauzy's conjecture on the cubic billiards, *Tokyo J. Math.* **17** (1994) 211–218.
- [10] Arnoux P., Rauzy G., Représentation géométrique de suites de complexité $2n + 1$, *Bull. Soc. math. France* **119** (1991) 199–215.
- [11] Berstel J., Séébold P., Mots de Sturm - un survol, *Preprint* (1994).
- [12] Berthé V., *this volume*.
- [13] Brlek S., Enumeration of factors in the Thue-Morse word, *Discrete Appl. Math.* **24** (1989) 83–96.
- [14] Cobham A., Uniform tag sequences, *Math. Systems Theory* **6** (1972) 164–192.
- [15] Coven E. M., Hedlund G. A., Sequences with minimal block growth, *Math. Systems Theory* **7** (1973) 138–153.
- [16] Crisp D., Moran W., Pollington A., Shiue P., Substitution invariant cutting sequences, *Journal de Théorie des Nombres de Bordeaux* **5** (1993) 123–137.
- [17] Dekking F. M., On the structure of self-generating sequences, *Séminaire de Théorie des Nombres de Bordeaux, Exposé 31* (1980–1981) 31-01–31-06.
- [18] Ferenczi S., Les transformations de Chacon : combinatoire, structure géométrique, lien avec les systèmes de complexité $2n + 1$, *Bull. Soc. math. France* (1995) to appear.
- [19] Hubert P., Complexité des suites définies par des billards rationnels, *Bull. Soc. math. France* (1995) to appear.
- [20] Koskas M., Complexity functions for some Toeplitz sequences, *Theoret. Comput. Sci.* (1995) to appear.
- [21] Li M., Vitányi P., Kolmogorov complexity and its applications, in: Handbook of Theoretical Computer Science, Volume A: Algorithms and Complexity, J. van Leeuwen Ed (MIT Press, 1990) p. 187–254.
- [22] de Luca A., Varricchio S., On the factors of the Thue-Morse word on three symbols, *Information Processing Letters* **27** (1988) 281–285.
- [23] de Luca A., Varricchio S., Some combinatorial properties of the Thue-Morse sequence, *Theoret. Comput. Sci.* **63** (1989) 333–348.
- [24] Morse M., Hedlund G. A., Symbolic Dynamics, *Amer. J. Math.* **60** (1938) 815–866.
- [25] Morse M., Hedlund G. A., Symbolic Dynamics II. Sturmian trajectories, *Amer. J. Math.* **62** (1940) 1–42.
- [26] Mossé M., Notions de reconnaissabilité pour les substitutions et complexité des suites automatiques, *Prépublication du LMD* **93-21** (1993).
- [27] Pansiot J.-J., Bornes inférieures sur la complexité des facteurs des mots infinis engendrés par morphismes itérés, *Lecture Notes in Computer Science* **166** (1984) 230–240.
- [28] Pansiot J.-J., Complexité des facteurs des mots infinis engendrés par morphismes itérés, *Lecture Notes in Computer Science* **172** (1984) 380–389.

- [29] Rauzy G., Suites à termes dans un alphabet fini, *Séminaire de Théorie des Nombres de Bordeaux, Exposé 25* (1982–1983) 25-01–25-16.
- [30] Rote G., Sequences with subword complexity $2n$, *J. Number Theory* **46** (1994) 196–213.
- [31] Santini M.-L., Échanges de trois intervalles (Thèse, Université Aix-Marseille II, 1994).

PART VI

Opacity of an automaton

1. AUTOMATA REVISITED

In this part all the automata we consider are 2-automata. The arrows are named (+) and (-).

An automaton \mathcal{A} is determined by a finite set S (set of states), an initial state $A \in S$ and a map $\tau : \{-, +\} \times S \rightarrow S$ represented by (\pm) arrows which join two states:

$$\mathcal{A} = (S, A, \tau).$$

Given an infinite sequence $\varepsilon = (\varepsilon_n)$, $\varepsilon_n = \pm 1$, it acts on \mathcal{A} in the following way. ε_0 puts the automaton in state $\varepsilon_0(A)$. Then ε_1 sends $\varepsilon_0(A)$ onto $\varepsilon_1(\varepsilon_0(A))$, etc... The sequence of states

$$A, \varepsilon_0(A), \varepsilon_1(\varepsilon_0(A)), \dots$$

is an infinite sequence on the alphabet S denoted $\mathcal{A}\varepsilon$.

We now define the output function

$$\varphi : S \rightarrow \mathbb{R}$$

which maps $\mathcal{A}\varepsilon$ on $\varphi(\mathcal{A}\varepsilon)$ coordinate-wise.

We propose to measure the discrepancy between the input sequence ε and the output sequence $\varphi(\mathcal{A}\varepsilon)$.

Given two real bounded sequences $\delta' = (\delta'_n)$ and $\delta'' = (\delta''_n)$ we define their distance by

$$\|\delta' - \delta''\| = \limsup_{N \rightarrow \infty} \left(\frac{1}{N} \sum_{n < N} |\delta'_n - \delta''_n|^2 \right)^{1/2}.$$

This norm was already discussed in Part IV.

$\|\varphi(\mathcal{A}\varepsilon) - \varepsilon\|$ is to be thought as the distortion of the sequence ε when mapped through (\mathcal{A}, φ) . We minimize the distortion by choosing φ as “best as we can”:

$$\inf_{\varphi} \|\varphi(\mathcal{A}\varepsilon) - \varepsilon\|.$$

The inf is to be taken over all maps $\varphi : S \rightarrow \mathbb{R}$. The *opacity* of \mathcal{A} is by definition

$$(1) \quad \omega(\mathcal{A}) = \sup_{\varepsilon \in UP} \inf_{\varphi} \|\varphi(\mathcal{A}\varepsilon) - \varepsilon\|$$

where the sup is over the set of all (\pm) sequences ε which are periodic from some point on (*UP* stands for Ultimately Periodic).

The *UP* restriction is a technical requirement which may perhaps not be necessary. At the time of writing, Nathalie Loraud [1] is studying the pertinence of the restriction. She proposes to modify the definition of the opacity:

$$\tilde{\omega}(\mathcal{A}) = \sup_{\varepsilon} \limsup_{N \rightarrow \infty} \left(\frac{1}{N} \inf_{\varphi} \sum_{n < N} |\varphi(\mathcal{A}\varepsilon) - \varepsilon|^2 \right)^{1/2}$$

(notice the permutation of the two operations \limsup and \inf). With this definition she can show that $\sup_{\varepsilon \in UP} \omega$ and $\sup_{\varepsilon} \omega$ coincide. She can also prove that $\omega(\mathcal{A}) = \tilde{\omega}(\mathcal{A})$.

The question remains: is it true that

$$\omega(\mathcal{A}) = \sup_{\varepsilon} \inf_{\varphi} \|\varphi(\mathcal{A}\varepsilon) - \varepsilon\|?$$

We shall not discuss the matter and we maintain our original definition (1).

Let us describe some simple properties of the opacity. Trivially $\omega(\mathcal{A}) \geq 0$. We also remark

$$\inf_{\varphi} \|\varphi(\mathcal{A}\varepsilon) - \varepsilon\| \leq \|\varepsilon\| = 1$$

since one can choose φ to be the constant 0 function. Therefore

$$0 \leq \omega(\mathcal{A}) \leq 1.$$

An automaton \mathcal{A} for which $\omega(\mathcal{A}) = 0$ is said to be transparent. If $\omega(\mathcal{A}) = 1$ then \mathcal{A} is completely opaque.

Example 1. The identity automaton

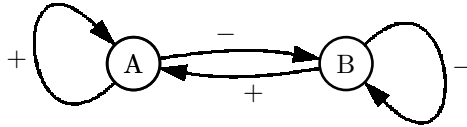

Consider for example the input sequence

$$\varepsilon : + - - + + - \dots$$

The automaton sends it on

$$\mathcal{A}\varepsilon : A B B A A B \dots$$

Apart from the symbols, both sequences are identical. Define

$$\varphi(A) = +1, \varphi(B) = -1.$$

Then for all ε , $\varphi(\mathcal{A}\varepsilon) = \varepsilon$ hence $\omega(\mathcal{A}) = 0$.

Example 2. The constant automaton

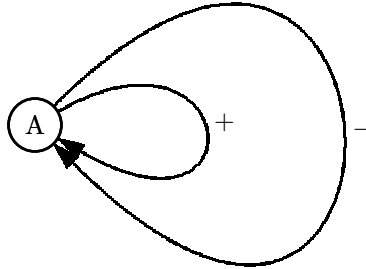

Put $\varphi(A) = a$. Then

$$\omega(\mathcal{A})^2 = \sup_{\varepsilon \in UP} \inf_a \limsup_N \frac{1}{N} \sum_{n < N} |a - \varepsilon_n|^2.$$

In the lim sup choose $\varepsilon_n = (-1)^n$:

$$\begin{aligned} \limsup_N \frac{1}{N} \sum_{n < N} |a - (-1)^n|^2 &= \limsup_N \frac{1}{N} \sum_{n < N} (a^2 + 1 - 2a(-1)^n) \\ &= a^2 + 1. \end{aligned}$$

Trivially

$$\inf_a (a^2 + 1) = 1,$$

hence

$$\omega(\mathcal{A}) \geq 1.$$

But $\omega(\mathcal{A}) \leq 1$ therefore $\omega(\mathcal{A}) = 1$.

The output sequence gives no information on the input sequence, and it is then not surprising to discover that this automaton is completely opaque.

Example 3. The Thue-Morse automaton

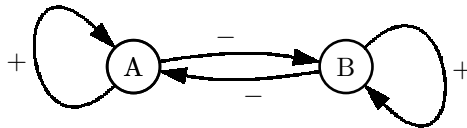

Put $\varphi(A) = a, \varphi(B) = b$. If the input sequence is $\varepsilon = (\varepsilon_n)$ then it can be easily seen that the output sequence is

$$\delta_n = \frac{1}{2}(a + b) + \frac{1}{2}(a - b)\pi_n,$$

where

$$\pi_n = \varepsilon_0\varepsilon_1 \cdots \varepsilon_n.$$

Let us choose as above $\varepsilon_n = (-1)^n$. Then

$$\|\delta - \varepsilon\|^2 = \limsup_N \frac{1}{N} \sum_{n < N} \left(\frac{1}{2}(a + b) + \frac{1}{2}(a - b)\pi_n - \varepsilon_n \right)^2.$$

Observing that

$$\lim \frac{1}{N} \sum \varepsilon_n = \lim \frac{1}{N} \sum \pi_n = \lim \frac{1}{N} \sum \varepsilon_n \pi_n = 0,$$

we easily see that

$$\|\delta - \varepsilon\|^2 = \frac{1}{2}(a^2 + b^2) + 1.$$

Then

$$\omega(\mathcal{A}) \geq \inf_{a,b} \left[\frac{1}{2}(a^2 + b^2) + 1 \right] = 1,$$

hence

$$\omega(\mathcal{A}) = 1.$$

This automaton is also completely opaque though it is possible to reconstruct ε from \mathcal{A}_ε .

We shall see below how to compute $\omega(\mathcal{A})$ in many cases; we leave it to the reader to show that $\omega(\mathcal{A})$ can take all values of the form $\sqrt{\rho}$ where ρ is any rational number in the interval $(0, 1)$.

2. COMPUTING THE OPACITY

An automaton is said to be strongly connected if from any two states, there exists at least one path of arrows joining the first state to the second.

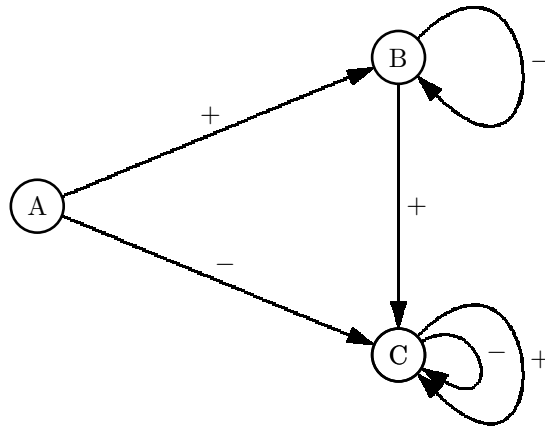

The above automaton is not strongly connected since no arrows go to A .

An automaton is homogeneous if each state has exactly two incident arrows. This is not the case in the preceding automaton. Automata in examples 1, 2, 3 are both strongly connected and homogeneous.

We now define strong states on a path. Let P be a closed path on an automaton. Its length $\ell(P)$ is the number of states it contains, counted with multiplicity.

A state B on the path P is a *strong state* if it is attained twice at least, once through a (+) arrow and once through a (-) arrows on P . $\nu(P)$ counts the number of strong states on P .

THEOREM. *The opacity of a strongly connected homogeneous automaton \mathcal{A} is given by the formula*

$$\omega(\mathcal{A}) = \sup_P \sqrt{\frac{2\nu(P)}{\ell(P)}}.$$

Given any rational number ρ in the interval $(0,1)$ there exist a strongly connected homogeneous automaton \mathcal{A} such that $\omega(\mathcal{A}) = \sqrt{\rho}$.

We shall not give the proof of this result (see [2]). It can be shown that the result extends to a larger class of automata, namely those for which the states are of three kinds:

- a) exactly two incident arrows, one (+) and one (-),
- b) any number of (+) arrows and no (-) arrows,
- c) any number of (-) arrows and no (+) arrows.

Let us illustrate this theorem by computing the opacity of the following automaton

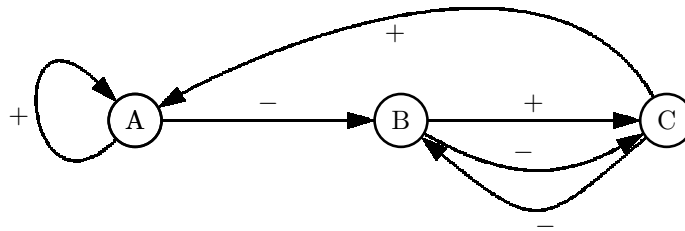

The shortest closed path P which contains both the + and - arrows incident to C is

$$B \xrightarrow{+} C \xrightarrow{-} B \xrightarrow{-} C \xrightarrow{-} B$$

for which $\ell(P) = 4$ and $\nu(P) = 1$ thus

$$\omega(\mathcal{A}) = \sqrt{\frac{2\nu}{\ell}} = \frac{1}{\sqrt{2}}.$$

We shall apply these results to the Ising chain in Part VII.

References

- [1] Loraud N., Contribution à l'étude de l'opacité d'un automate, *Work in progress*.
- [2] Mendès France M., Opacity of an automaton. Application to the inhomogeneous Ising chain, *Comm. Math. Phys.* **139** (1991) 341–352.

PART VII

The Ising automaton

A large part of this chapter (Paragraphs 1 and 2) is due to B. Derrida who introduced us to the idea of induced field and who showed us how to compute it. See [6] and the forthcoming paper [8].

1. THE INHOMOGENEOUS ISING CHAIN

An Ising chain consists of $N + 1$ sites in a row occupied by $N + 1$ particles with spin ± 1 . At site $q \in \{0, 1, \dots, N\}$ the spin is denoted

$$\sigma_q \in \{-1, +1\}.$$

A configuration is a finite sequence of spins

$$\sigma = (\sigma_0, \sigma_1, \dots, \sigma_N).$$

Let

$$\varepsilon = (\varepsilon_0, \varepsilon_1, \dots, \varepsilon_{N-1}) \in \{-1, +1\}^N.$$

be a given sequence which could be thought of as the distribution of two substances in an alloy. The Hamiltonian or energy of a configuration σ is defined by

$$\mathcal{H}_\varepsilon(\sigma) = -J \sum_{q=0}^{N-1} \varepsilon_q \sigma_q \sigma_{q+1} - H \sum_{q=0}^N \sigma_q,$$

where $J > 0$ is a given parameter known as the coupling constant or binding energy and where H is a real parameter called the external field.

One of the main problems is to find the equilibrium state (or fundamental state) of the chain i.e. to discover the configuration σ which minimizes $\mathcal{H}_\varepsilon(\sigma)$.

Let $T > 0$ be the temperature; put $\beta = 1/T$. The fundamental axioms of Statistical Mechanics show that the probability of configuration σ at temperature T is

$$p_T(\sigma) = \frac{1}{Z(\beta, N)} \exp(-\beta \mathcal{H}_\varepsilon(\sigma)),$$

where $Z(\beta, N)$, the partition function, is defined by

$$Z(\beta, N) = \sum_{\sigma' \in \{-1, +1\}^{N+1}} \exp(-\beta \mathcal{H}_\varepsilon(\sigma')).$$

Suppose there exist L fundamental states which minimize $\mathcal{H}_\varepsilon(\sigma)$. Then it is easy to see that as T vanishes,

$$\lim_{T \searrow 0} p_T(\sigma) = \begin{cases} 1/L & \text{if } \sigma \text{ is fundamental,} \\ 0 & \text{if not.} \end{cases}$$

If $L = 1$, then, at vanishing temperature, the chain is at equilibrium with probability 1. Order prevails.

At high temperature, ($T \nearrow +\infty$, $\beta \searrow 0$),

$$\lim_{T \nearrow +\infty} p_T(\sigma) = \frac{1}{2^{N+1}}.$$

All configurations have equal probability: the system is in a state of total disorder.

2. THE INDUCED FIELD

We shall now study the sign of the spin σ_N of the particle at site N (the very last one) at temperature $T = 0$. Our strategy is based on the simple fact

$$\lim_{\beta \rightarrow +\infty} [Z(\beta, N)]^{1/\beta} = \exp(-\mathcal{H}_\varepsilon(\hat{\sigma})),$$

where $\hat{\sigma}$ is one of the equilibrium configurations.

The discussion which we reproduce here in this section is well known to physicists. See for example [6].

Define the two conditional partition functions

$$Z^+(\beta, N) = \sum_{\substack{\sigma \in \{\pm\}^N \\ \sigma_N = +1}} \exp(-\beta \mathcal{H}_\varepsilon(\sigma))$$

$$Z^-(\beta, N) = \sum_{\substack{\sigma \in \{\pm\}^N \\ \sigma_N = -1}} \exp(-\beta \mathcal{H}_\varepsilon(\sigma)).$$

The probability that $\sigma_N = +1$ at temperature T is

$$Z^+(\beta, N)/Z(\beta, N).$$

Similarly

$$Z^-(\beta, N)/Z(\beta, N)$$

is the probability that $\sigma_N = -1$ at T .

If the ratio

$$Z^+(\beta, N)/Z^-(\beta, N)$$

is larger than 1 then the event $\sigma_N = +1$ occurs with probability larger than 1/2; if the ratio is less than 1 then $\sigma_N = -1$ prevails. We are thus led to compute the ratio Z^+/Z^- .

Define the vector

$$V(N) = \begin{pmatrix} Z^+(\beta, N) \\ Z^-(\beta, N) \end{pmatrix}.$$

Then

$$V(N) = M(\varepsilon_{N-1})V(N-1),$$

where the “transfer matrix” is defined by

$$M(\varepsilon_q) = \begin{pmatrix} z^{\varepsilon_q + \frac{1}{2}\alpha} & z^{-\varepsilon_q + \frac{1}{2}\alpha} \\ z^{-\varepsilon_q - \frac{1}{2}\alpha} & z^{\varepsilon_q - \frac{1}{2}\alpha} \end{pmatrix}.$$

To simplify notations we have put $\alpha = \frac{2H}{J}$ and $z = e^{\beta J}$. Notice that $T \searrow 0 \iff z \nearrow +\infty$.

By induction

$$V(N) = M(\varepsilon_{N-1})M(\varepsilon_{N-2}) \cdots M(\varepsilon_0)V(0),$$

where

$$V(0) = \begin{pmatrix} \exp(-H) \\ \exp(+H) \end{pmatrix}.$$

The product of the transfer matrices is a 2×2 matrix the entries of which are “polynomials” in z . As T decreases to 0, z increases to infinity. Only highest degrees are relevant:

$$V(q) \sim \begin{pmatrix} z^{a_q} \\ z^{b_q} \end{pmatrix}.$$

The symbol \sim signifies that the first (resp. second) coordinate has order z^{a_q} (resp. z^{b_q}).

Similarly

$$\begin{aligned} V(q+1) &\sim \begin{pmatrix} z^{a_{q+1}} \\ z^{b_{q+1}} \end{pmatrix} \\ &\sim \begin{pmatrix} z^{\varepsilon_q + \frac{1}{2}\alpha} & z^{-\varepsilon_q + \frac{1}{2}\alpha} \\ z^{-\varepsilon_q - \frac{1}{2}\alpha} & z^{\varepsilon_q - \frac{1}{2}\alpha} \end{pmatrix} \begin{pmatrix} z^{a_q} \\ z^{b_q} \end{pmatrix}, \end{aligned}$$

therefore

$$(1) \quad \begin{cases} a_{q+1} = \frac{1}{2}\alpha + \max\{a_q + \varepsilon_q, b_q - \varepsilon_q\} \\ b_{q+1} = -\frac{1}{2}\alpha + \max\{a_q - \varepsilon_q, b_q + \varepsilon_q\}. \end{cases}$$

On the other hand

$$\frac{Z^+(\beta, q)}{Z^-(\beta, q)} \sim z^{a_q - b_q}$$

tends to $+\infty$ or 0 as z tends to $+\infty$ according to the sign of

$$\delta_q = a_q - b_q.$$

Hence the sign of δ_N (notice the subscript!) imposes the value of the spin σ_N at equilibrium:

$$\sigma_N = \text{sgn}(\delta_N).$$

If $\delta_N = 0$ we agree to say that the spin σ_N is not determined; it can be chosen at will $+1$ or -1 . (This is not entirely correct. If $a_N = b_N$ one should then look at the coefficients of z^{a_N} in both the components of $V(N)$. The larger one should then impose the value of σ_N . This case is so singular that we shall adopt the above “convention”.)

The quantity δ_N is called the induced field at site N .

The two equalities (1) imply

$$\delta_{q+1} = \alpha + \varepsilon_q \text{sgn}(\delta_q) \min\{2, |\delta_q|\}.$$

Changing the sign of $\alpha = 2H/J$ only changes the sign of the sequence (δ_q) so without loss of generality we shall assume from now on that $\alpha \geq 0$, ($H \geq 0$).

The above induction formula has a special feature namely that if $\alpha > 0$, and if $q > 4/\alpha$, then for almost all ε , δ_q is independent of δ_0 . If on the other hand $\alpha = 0$ we loose no information on $\text{sgn } \delta_q$ by fixing δ_0 arbitrarily.

It is convenient to choose $\delta_0 = \alpha + 2$. We are now left to study the sequence (δ_n) defined by

$$(2) \quad \begin{cases} \delta_0 = \alpha + 2 \\ \delta_{n+1} = \alpha + \varepsilon_n \text{sgn}(\delta_n) \min\{2, |\delta_n|\}. \end{cases}$$

As an easy exercise, the reader may verify that for $\alpha = 0$, ($H = 0$), these equations reduce to

$$\delta_{n+1} = 2\varepsilon_0\varepsilon_1 \cdots \varepsilon_{n-1}\varepsilon_n$$

and for $\alpha \geq 4$, ($H \geq 2J$),

$$\delta_{n+1} = \alpha + 2\varepsilon_n.$$

How are we to interpret the sequence $\delta_0, \delta_1, \delta_2, \dots, \delta_n, \dots$? The sign of δ_n is the value of the spin σ_n at equilibrium under the influence of the sites $n - 1, n - 2, \dots$ ignoring sites $n + 1, n + 2, \dots$. In particular $\sigma_N = \text{sgn}(\delta_N)$. But it is not true that $\sigma_{N-1} = \text{sgn}(\delta_{N-1})$ since the site $N - 1$ is influenced by the sites $N - 2, N - 3, \dots$ and *also* by the site N . T. Kamae pointed out that finding the values of σ_n for all $n \leq N$ is now actually possible. The details will appear in a forthcoming paper [8].

3. THE ISING AUTOMATON

The rest of this chapter is devoted to the study of the sequence $\delta = (\delta_n)$ which we denote $\delta^\alpha = (\delta_n^\alpha)$ or $\delta^\alpha(\varepsilon) = (\delta_n^\alpha(\varepsilon))$ if we wish to emphasize the dependence of δ on α or $\varepsilon = (\varepsilon_n)$.

We first observe that for all n

$$\alpha - 2 \leq \delta_n \leq \alpha + 2.$$

More precisely, if $\alpha = 0$ then

$$\delta_n \in \{-2, +2\}$$

and if $\alpha > 0$

$$\delta_n \in \{(i+1)\alpha - 2 \mid i = 0, 1, 2, \dots, [4/\alpha]\} \cup \{2 - (i-1)\alpha \mid i = 0, 1, 2, \dots, [4/\alpha]\}.$$

More is true: α being fixed, the map

$$\varepsilon \mapsto \delta^\alpha(\varepsilon)$$

is described by an automaton \mathcal{A}_α and an output function φ_α which we discuss now. We agree to call the couple $(\mathcal{A}_\alpha, \varphi_\alpha)$ the Ising automaton, so we have a family of Ising automata depending on the external field $\alpha = 2H/J$.

Case 1. $\alpha = 0$. The Ising automaton is the Thue-Morse automaton with output function $\varphi_0(A) = 2$, $\varphi_0(B) = -2$.

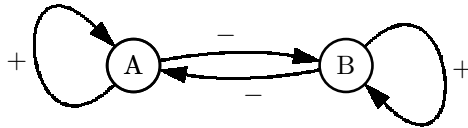

Case 2. $\alpha > 0$. Put $m = [4/\alpha]$. The Ising automaton has $2(m+1)$ states.

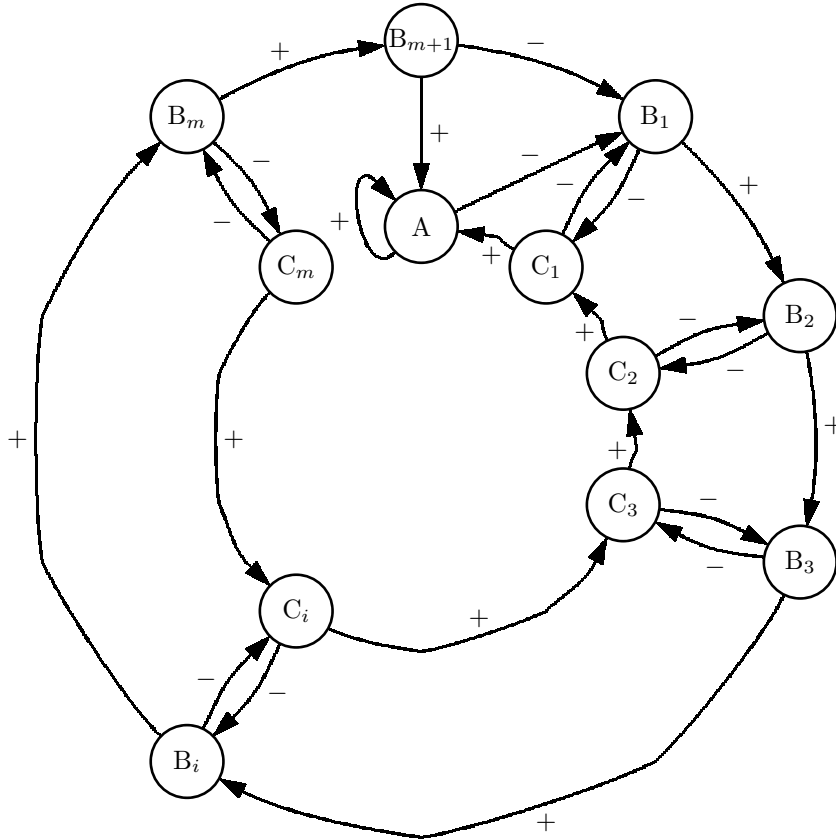

$$\begin{aligned} \varphi_\alpha(A) &= \alpha + 2, \varphi_\alpha(B_i) = i\alpha - 2, i = 1, 2, \dots, m + 1, \\ \varphi_\alpha(C_j) &= 2 - (j - 1)\alpha, j = 1, 2, \dots, m. \end{aligned}$$

Remark

As α tends to 0 the number of states of \mathcal{A}_α goes to infinity. On the other hand, \mathcal{A}_0 has only two states so there seems to be some discontinuity as α vanishes. The “paradox” can be solved in the following way. Let n be somewhere between 0 and $[4/\alpha]$, $0 \ll n \ll [4/\alpha]$. In the vicinity of “ n ” the automaton \mathcal{A}_α looks like

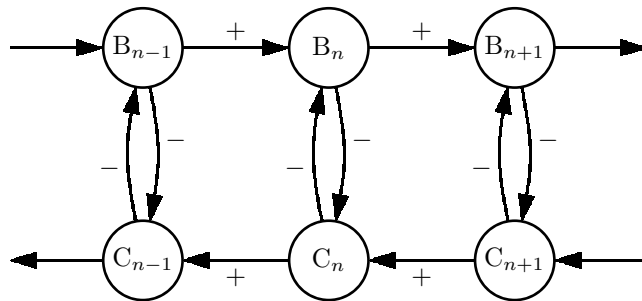

and

$$\begin{cases} \varphi_\alpha(B_n) = -2 + n\alpha \\ \varphi_\alpha(C_n) = 2 - (n - 1)\alpha. \end{cases}$$

When α vanishes, φ_α tends to

$$\begin{cases} \varphi_0(B_n) = -2 \text{ for all } n \\ \varphi_0(C_n) = 2. \end{cases}$$

This automaton which contains infinitely many states collapses and becomes indiscernable from \mathcal{A}_0 !

4. AN ERGODIC PROPERTY

THEOREM 1. *For all α and for almost all sequences ε*

$$\lim_{N \rightarrow \infty} \frac{1}{N} \sum_{n=0}^{N-1} (\mathcal{A}_\alpha \varepsilon)_n = \alpha.$$

The proof we propose here is shorter than in [9]. Let T be the shift operator on $\{-1, +1\}^{\mathbb{N}}$: $T(\varepsilon_n) = (\varepsilon_{n+1})$. Let A be the initial state of the automaton \mathcal{A}_α . Define the operator \tilde{T} on the space $\{-1, +1\}^{\mathbb{N}} \times S$:

$$\tilde{T}((\varepsilon), B) = (T(\varepsilon), \varepsilon_0 B).$$

Here S is the set of states of \mathcal{A}_α . Then

$$\tilde{T}^n(\varepsilon, A) = (T^n \varepsilon, \varepsilon_{n-1} \varepsilon_{n-2} \cdots \varepsilon_0 A).$$

The operator \tilde{T} is ergodic with respect to the canonical measure on the space $\{-1, +1\}^{\mathbb{N}} \times S$. Define

$$\begin{aligned} F : \{-1, +1\}^{\mathbb{N}} \times S &\rightarrow \mathbb{R} \\ (\delta, B) &\mapsto \varphi_\alpha(B). \end{aligned}$$

The ergodic theorem asserts that, for almost all $\varepsilon \in \{-1, +1\}^{\mathbb{N}}$,

$$\lim_{N \rightarrow \infty} \frac{1}{N} \sum_{n < N} F(\tilde{T}^n(\varepsilon, A)) = \int \varphi_\alpha(B) dB = \frac{1}{\#S} \sum_{B \in S} \varphi_\alpha(B).$$

Therefore

$$\lim_{N \rightarrow \infty} \frac{1}{N} \sum_{n < N} \varphi_\alpha(\varepsilon_{n-1} \varepsilon_{n-2} \cdots \varepsilon_0 A) = \alpha, \quad \text{QED.}$$

Remark

At the end of the proof we observed that, for almost all ε ,

$$\lim_{N \rightarrow \infty} \frac{1}{N} \sum_{n=0}^{N-1} (\mathcal{A}_\alpha \varepsilon)_n = \frac{1}{\#S} \sum_{B \in S} \varphi_\alpha(B).$$

The equality shows that the dynamical average coincides with the spatial average.

THEOREM 2. For all $\alpha > 0$ and all sequences ε

$$\liminf_{N \rightarrow \infty} \frac{1}{N} \sum_{n=0}^{N-1} (\mathcal{A}_\alpha \varepsilon)_n \geq \frac{1}{2} \alpha.$$

Proof. Recall

$$(\mathcal{A}_\alpha \varepsilon)_n = \delta_n$$

and

$$\delta_{n+1} = \alpha + \varepsilon_n \operatorname{sgn}(\delta_n) \min\{2, |\delta_n|\}.$$

Hence

$$\begin{aligned} (\delta_{n+1} - \alpha)^2 &= \min\{4, \delta_n^2\}, \\ 2\alpha\delta_{n+1} &= \alpha^2 + \delta_{n+1}^2 - \min\{4, \delta_n^2\} \\ &\geq \alpha^2 + \delta_{n+1}^2 - \delta_n^2, \\ \delta_{n+1} &\geq \frac{\alpha}{2} + \frac{1}{2\alpha}(\delta_{n+1}^2 - \delta_n^2), \\ \frac{1}{N} \sum_{n=0}^{N-1} \delta_{n+1} &\geq \frac{\alpha}{2} + \frac{1}{2\alpha N}(\delta_N^2 - \delta_0^2), \end{aligned} \quad \text{QED.}$$

The following theorem strengthens Theorem 2.

THEOREM 3. Let $\alpha > 0$ be given and let β, β' be two real numbers such that

$$\max\left\{\frac{\alpha}{2}, \alpha - 2\right\} \leq \beta \leq \beta' \leq \alpha + 2.$$

Then there exists a sequence $\varepsilon \in \{-1, +1\}^{\mathbb{N}}$ such that

$$\begin{aligned} \liminf_{N \rightarrow \infty} \frac{1}{N} \sum_{n=0}^{N-1} (\mathcal{A}_\alpha \varepsilon)_n &= \beta, \\ \limsup_{N \rightarrow \infty} \frac{1}{N} \sum_{n=0}^{N-1} (\mathcal{A}_\alpha \varepsilon)_n &= \beta'. \end{aligned}$$

Proof. If $\alpha \geq 4$ then

$$\delta_{n+1} = \alpha + 2\varepsilon_n$$

Then the result is easily established.

Let us suppose $0 < \alpha < 4$. Consider a closed path $P(p, q)$ on the automaton \mathcal{A}_α which loops p times around A , then joins B_1 , loops q times around B_1 and B_2 and finally goes back to A . The average of δ_n on the closed path is

$$\frac{p(\alpha + 2) + q\alpha + O(1)}{p + 2q + O(1)}.$$

Let p_n and q_n be two infinite sequences of integers and define

$$\underline{\lambda} = \liminf_{n \rightarrow \infty} p_n/q_n$$

$$\bar{\lambda} = \limsup_{n \rightarrow \infty} p_n/q_n.$$

Clearly $0 \leq \underline{\lambda} \leq \bar{\lambda} \leq +\infty$.

Consider an infinite path P which consists in the union of $P(p_1, q_1)$, $P(p_2, q_2)$, \dots , $P(p_n, q_n)$, \dots . P determines a sequences ε such that

$$\limsup_{N \rightarrow \infty} \frac{1}{N} \sum_{n=0}^{N-1} \delta_n(\varepsilon) = \frac{(\alpha + 2)\bar{\lambda} + \alpha}{\bar{\lambda} + 2}$$

$$\liminf_{N \rightarrow \infty} \frac{1}{N} \sum_{n=0}^{N-1} \delta_n(\varepsilon) = \frac{(\alpha + 2)\underline{\lambda} + \alpha}{\underline{\lambda} + 2}$$

Choose $\underline{\lambda}$ and $\bar{\lambda}$ such that

$$\frac{(\alpha + 2)\bar{\lambda} + \alpha}{\bar{\lambda} + 2} = \beta'$$

$$\frac{(\alpha + 2)\underline{\lambda} + \alpha}{\underline{\lambda} + 2} = \beta, \quad \text{QED.}$$

Remark

By choosing $\underline{\lambda} = 0$ one obtains a second proof of Theorem 2.

5. OPACITY OF THE ISING AUTOMATON [9]

The Ising automaton is not homogeneous but the theorem of Part VI can be applied, (see comment following the theorem): it is a simple matter to maximize $\sqrt{2\nu(P)/\ell(P)}$.

THEOREM 4. *The opacity of \mathcal{A}_0 is 1. If $\alpha > 0$, the opacity of \mathcal{A}_α is*

$$\sqrt{\frac{m' - 1}{m'}}, \quad \text{where } m' = \max\{1, [4/\alpha]\}.$$

Many of the results in this part have already been published in different journals by several authors. We should point out in particular the papers of Allouche, Mendès France [1], Derrida [6], Mendès France [9]. In [1] we show that if ε is an automatic sequence then the induced field is also automatic. This result has been generalized by Dekking [5] to sequences which are literal images of fixed points of any morphism, (not necessarily of constant length). Theorems 2 and 3 have not appeared in print.

The general theory of the Ising model originates with Ising [7]. The literature concerning the Ising model is so vast that it would be too long to list all the books and articles. We single out the work of Baxter [2], Biggs [3], Cipra [4], Thompson [10].

References

- [1] Allouche J.-P., Mendès France M., Quasicrystal Ising chain and automata theory, *J. Stat. Phys.* **42** (1986) 809–821.
- [2] Baxter R. J., Exactly solved models in statistical mechanics (Academic Press, 1982).
- [3] Biggs N. L., Interaction models, London Mathematical Society (Lecture Note Series, **30**, Cambridge University Press, 1977).
- [4] Cipra B. A., An introduction to the Ising model, *Amer. Math. Monthly* **94** (1987) 937–959.
- [5] Dekking F. M., Iteration of a map by an automaton, *Discrete Math.* **126** (1994) 81–86.
- [6] Derrida B., Products of random matrices and one dimensional disordered systems in: Nonlinear Equations in Field Theory (Lectures Notes in Physics, **226**, Springer-Verlag, 1985).
- [7] Ising E., Beitrag zur Theorie der Ferromagnetismus, *Z. Physik* **31** (1925) 253–258.
- [8] Kamae T., Mendès France M., A continuous family of automata: the Ising automata, *Submitted* (1994).
- [9] Mendès France M., Opacity of an automaton. Application to the inhomogeneous Ising chain, *Comm. Math. Phys.* **139** (1991) 341–352.
- [10] Thompson C. J., Mathematical statistical mechanics (Princeton University Press, 1972).

PART VIII

Extra references

It may be useful to add to the previous references the following articles which are more concerned with physical problems and which of course involve automatic sequences or generalizations. This list is obviously not complete. We beg pardon to all those whom we inadvertently forgot to mention. Needless to say their number is much greater than the number of authors quoted here.

References

- [−] Ali M. K., Gumbs G., Quasiperiodic dynamics for a generalized third order Fibonacci series, *Phys. Rev. B (Brief Reports)* **39** (1988) 7091–7093.
- [−] Allouche J.-P., Finite automata in 1-D and 2-D Physics, in: Number Theory and Physics, Proceedings of the Winter School, Les Houches, France, March 7-16 1989, Luck J.-M., Moussa P., Waldschmidt M. Eds, Springer Proceedings in Physics **47** (Springer Verlag, 1990) p. 177–184.
- [−] Allouche J.-P., Complexity of infinite sequences and the Ising transducer, in: Cellular Automata and Cooperative Systems, Boccara N., Goles E., Martinez S., Picco P. Eds, NATO ASI series, Series C: Mathematical and Physical Sciences, vol. 396 (Kluwer Academic Publishers, Dordrecht, 1993) p. 1–9.
- [−] Allouche J.-P., Mendès France M., Suite de Rudin-Shapiro et modèle d'Ising, *Bull. Soc. math. France* **113** (1985) 273–283.
- [−] Allouche J.-P., Mendès France M., Quasi-crystal Ising chain and automata theory, *J. Stat. Phys.* **42** (1986) 809–821.
- [−] Allouche J.-P., Peyrière J., Sur une formule de récurrence sur les traces de produits de matrices associés à certaines substitutions, *C. R. Acad. Sci. Paris, Série II* **302** (1986) 1135–1136.
- [−] Allouche J.-P., Salon O., Robinson tilings and 2-dimensional automata, in: Quasicrystals, networks and molecules of fivefold symmetry, Hargittai I. Ed (VCH Publishers Inc., 1990) p. 97–105.
- [−] Aubry S., Godrèche C., Incommensurate structure with no average lattice: an example of a one-dimensional quasicrystal, (Gratias D., Michel L. Eds), *J. de Phys. Colloq.* **47 C3** (1986) 187–196.
- [−] Aubry S., Godrèche C., Luck J.-M., A structure intermediate between quasiperiodic and random, *Europhys. Lett.* **4** (1987) 639–.
- [−] Aubry S., Godrèche C., Luck J.-M., Scaling properties of a structure intermediate between quasiperiodic and random, *J. Stat. Phys.* **51** (1988) 1033–1075.

- [−] Aubry S., Godrèche C., Vallet F., Incommensurate structure with no average lattice: an example of a one-dimensional quasicrystal, *J. Phys.* **48** (1987) 327–334.
- [−] Avishai Y., Berend D., Transmission through Fibonacci chain, *Phys. Rev. B* **43** (1991) 6873–6880.
- [−] Avishai Y., Berend D., Transmission through a Thue-Morse chain, *Phys. Rev. B* **45** (1992) 2717–2724.
- [−] Avishai Y., Berend D., Trace maps for arbitrary substitution sequences, *J. Phys. A: Math. Gen.* **26** (1993) 2437–2443.
- [−] Avishai Y., Berend D., Glaubman D., Minimum-dimension trace maps for substitution sequences, *Phys. Rev. Lett.* **72** (1994) 1842–1845.
- [−] Axel F., Allouche J.-P., Kléman M., Mendès France M., Peyrière, J., Vibrational modes in a one-dimensional “quasi alloy”, the Morse case, (Gratias D., Michel L. Eds), *J. de Phys. Colloq.* **47 C3** (1986) 181–187.
- [−] Axel F., Allouche J.-P., Wen Z.-Y., On certain properties of high-resolution X-ray diffraction spectra of finite-size generalized Rudin-Shapiro multilayer heterostructures, *J. Phys.: Condens. Matter* **4** (1992) 8713–8728.
- [−] Axel F., Peyrière J., Spectrum and extended states in a harmonic chain with controlled disorder: effects of the Thue-Morse symmetry, *J. Stat. Phys.* **57** (1989) 1013–1047.
- [−] Axel F., Terauchi H., High-resolution X-ray diffraction spectra of Thue-Morse GaAs-AlAs heterostructures: towards a novel description of disorder, *Phys. Rev. Lett.* **66** (1991) 2223–2226.
- [−] Baake M., Grimm U., Joseph D., Trace maps, invariants, and some of their applications, *Int. J. Mod. Phys. B* **7** (1993) 1527–1550.
- [−] Baake M., Grimm U., Pisani C., Partition function zeros for aperiodic systems, *J. Stat. Phys.* (1995) to appear.
- [−] Baake M., Joseph D., Kramer P., Periodic clustering in the spectrum of quasiperiodic Kronig-Penney models, *Phys. Lett. A* **168** (1992) 199–208.
- [−] Baake M., Roberts J. A. G., Symmetries and reversing symmetries of trace maps, in: Proceedings 3rd International Wigner Symposium, Boyle L. L., Solomon A. I. Eds (Oxford, 1993).
- [−] Bajema K., Merlin R., Raman scattering by acoustic phonons in Fibonacci GaAs-AlAs superlattices, *Phys. Rev. B* **36** (1987) 4555–4557.
- [−] Barache D., Luck J.-M., Electronic spectra of strongly modulated aperiodic sequences, *Phys. Rev. B* **49** (1994) 15004–15016.
- [−] Bellissard J., Spectral properties of Schrödinger’s operator with a Thue-Morse potential, in: Number theory and physics, Luck J.-M., Moussa P., Waldschmidt M. Eds, Springer Proceedings in Physics **47** (Springer, Berlin, Heidelberg, New York, 1990) p. 140–150.
- [−] Bellissard J., Gap labelling theorems for Schrödinger’s operators, in: From number theory to physics, Waldschmidt M., Moussa P., Luck J.-M., Itzykson C. Eds (Springer, Berlin, Heidelberg, New York, 1992) p. 538–630.

- [–] Bellissard J., Bovier A., Ghez J.-M., Spectral properties of a tight binding hamiltonian with period doubling potential, *Comm. Math. Phys.* **135** (1991) 379–399.
- [–] Bellissard J., Bovier A., Ghez J.-M., Gap labelling theorems for one-dimensional discrete Schrödinger operators, *Rev. Math. Phys.* **4** (1992) 1–37.
- [–] Bellissard J., Bovier A., Ghez J.-M., Discrete Schrödinger operators with potentials generated by substitutions, in: Differential equations with applications to mathematical physics, Ames W. F., Harrell E. M., Herod J. V. Eds (Academic Press, Boston, 1993) p. 13–23.
- [–] Bellissard J., Iochum B., Scoppola E., Testard D., Spectral properties of one-dimensional quasi-crystals, *Comm. Math. Phys.* **125** (1989) 527–543.
- [–] Benza V. G., Kolár M., Ali M. K., Phase transition in the generalized Fibonacci quantum Ising models, *Phys. Rev. B (Rapid Comm.)* **41** (1990) 9578–.
- [–] Bovier A., Ghez J.-M., Schrödinger operators with substitution potentials, in: Cellular Automata and Cooperative Systems, Boccara N., Goles E., Martinez S., Picco P. Eds, NATO ASI Series, Series C: Mathematical and Physical Sciences, vol. 396 (Kluwer Academic Publishers, Dordrecht, 1993) p. 67–83.
- [–] Bovier A., Ghez J.-M., Spectral properties of one-dimensional Schrödinger operators with potentials generated by substitutions, *Comm. Math. Phys.* **158** (1993) 45–66 and erratum, *Comm. Math. Phys.* to appear.
- [–] Bovier A., Ghez J.-M., Remarks on the spectral properties of tight binding and Kronig-Penney models with substitution sequences, *J. Phys. A: Math. Gen.* (1995) to appear.
- [–] Casdagli M., Symbolic dynamics for the renormalization map of a quasi-periodic Schrödinger equation, *Comm. Math. Phys.* **107** (1986) 295–318.
- [–] Cheng Z., Savit R., Merlin R., Structure and electronic properties of Thue-Morse lattices, *Phys. Rev. B* **37** (1988) 4375–4382.
- [–] Combescure M., Recurrent versus diffusive dynamics for a kicked quantum system, *J. Stat. Phys.* **62** (1991) 779–791.
- [–] Combescure M., Recurrent versus diffusive dynamics for a kicked quantum oscillator, *Ann. Inst. Henri Poincaré* **57** (1992) 67–87.
- [–] Doria M. M., Nori F., Satija I. I., Thue-Morse quantum Ising model, *Phys. Rev. B* **39** (1989) 6802–6806.
- [–] Dulea M., Physical properties of one-dimensional deterministic aperiodic systems (Thesis, Linköping, 1992).
- [–] Dulea M., Johansson M., Riklund R., Unusual scaling of the spectrum in a deterministic aperiodic tight-binding model, *Phys. Rev. B* **47** (1993) 8547–8551.
- [–] Ghosh P. K., The Kronig-Penney model on a generalized Fibonacci lattice, *Phys. Lett. A* **161** (1991) 153–157.
- [–] Godrèche C., Beyond quasiperiodicity: scaling properties of a Fourier spectrum, in: Universalities in condensed matter, Jullien R. et al. Eds,

- Springer Proceedings in Physics **32** (Springer Verlag, 1988).
- [–] Godrèche C., The sphinx: a limit-periodic tiling of the plane, *J. Phys. A: Math. Gen.* **22** (1989) 1163–1166.
 - [–] Godrèche C., Types of order and diffraction spectra for tilings of the line, in: Number theory and physics, Luck J.-M., Moussa P., Waldschmidt M. Eds, Springer Proceedings in Physics **47** (Springer, Berlin, Heidelberg, New York, 1990) p. 86–99.
 - [–] Godrèche C., Non-Pisot tilings and singular scattering, *Phase Transitions* **32** (1991) 45–.
 - [–] Godrèche C., Lançon F., A simple example of a non-Pisot tiling with fivefold symmetry, *J. Physique* **2** (1992) 207–220.
 - [–] Godrèche C., Luck J.-M., Tilings of the plane and their diffraction spectra, Proceedings of the Anniversary Adriatico Research Conference on Quasicrystals, Trieste, Italy, July 4-7 1989, Jaric M., Lundqvist S. Eds (World Scientific, 1989).
 - [–] Godrèche C., Luck J.-M., Quasiperiodicity and randomness in tilings of the plane, *J. Stat. Phys.* **55** (1989) 1–28.
 - [–] Godrèche C., Luck J.-M., Multifractal analysis in reciprocal space and the nature of the Fourier transform of self-similar structures, *J. Phys. A: Math. Gen.* **23** (1990) 3769–3797.
 - [–] Godrèche C., Luck J.-M., Indexing the diffraction spectrum of a non-Pisot self-similar structure, *Phys. Rev. B* **45** (1992) 176–.
 - [–] Godrèche C., Luck J.-M., Janner A., Janssen T., Fractal atomic surfaces of self-similar quasiperiodic tilings of the plane, *J. Physique* **13** (1993) 1921–.
 - [–] Godrèche C., Luck J.-M., Orland H., Magnetic phase structure on the Penrose lattice, *J. Stat. Phys.* **45** (1986) 777–800.
 - [–] Godrèche C., Luck J.-M., Vallet F., Quasiperiodicity and types of order: a study in one dimension, *J. Phys. A: Math. Gen.* **20** (1987) 4483–4499.
 - [–] Godrèche C., Oguey C., Construction of average lattices for quasiperiodic structure by the section method, *J. Physique* **51** (1990) 21–37.
 - [–] Godrèche C., Orland H., Renormalisation on the Penrose lattice, (Gratias D., Michel L. Eds), *J. de Phys. Colloq.* **47 C3** (1986) 197–203.
 - [–] Grimm U., Baake M., Non-periodic Ising quantum chains and conformal invariance, *J. Stat. Phys.* **74** (1994) 1233–1245.
 - [–] Gumbs G., Ali M. K., Dynamical maps, Cantor spectra and localization for Fibonacci and related quasiperiodic lattices, *Phys. Rev. Lett.* **60** (1988) 1081–1084.
 - [–] Gumbs G., Ali M. K., Scaling and eigenstates for a class of one-dimensional quasiperiodic lattices, *J. Phys. A: Math. Gen.* **21** (1988) 517–521.
 - [–] Gumbs G., Ali M. K., Electronic properties of the tight-binding Fibonacci hamiltonian, *J. Phys. A: Math. Gen.* **22** (1989) 951–970.
 - [–] Hof A., Quasi-crystals, aperiodicity and lattice systems (Thesis, Groningen, 1992).

- [–] Hof A., Knill O., Simon B., Singular continuous spectrum for palindromic Schrödinger operators, *Preprint Caltech* (1994).
- [–] Holzer M., Three classes of one-dimensional, two-tile Penrose tilings and the Fibonacci Kronig-Penney model as a generic case, *Phys. Rev. B* **38** (1988) 1709–1720.
- [–] Hörnquist M., Johansson M., Singular continuous electron spectrum for a class of circle sequences, *Preprint Linköping University* (1994) and *J. Phys. A: Math. Gen.* to appear.
- [–] Hu P., Ting C. S., Electron transmission in a one-dimensional quasicrystal, *Phys. Rev. B* **34** (1986) 8331–8334.
- [–] Iochum B., Raymond L., Testard D., Resistance of one-dimensional quasicrystals, *Physica A* **187** (1992) 353–368.
- [–] Iochum B., Testard D., Power law growth for the resistance in the Fibonacci model, *J. Stat. Phys.* **65** (1991) 715–723.
- [–] Kalugin P. A., Kitaev A. Y., Levitov L. S., Electron spectrum of a one-dimensional quasicrystal, *Sov. Phys. JETP* **64** (1986) 410–416.
- [–] Kim Y.-J., Oh G. Y., Lee M. H., Electronic structure of a one-dimensional quasicrystal, *J. Korean Phys. Soc.* **22** (1989) 136–140.
- [–] Kohmoto M., Kadanoff L. P., Tang C., Localization problem in one dimension: mapping and escape, *Phys. Rev. Lett.* **50** (1983) 1870–1872.
- [–] Kohmoto M., Oono Y., Cantor spectrum for an almost periodic Schrödinger equation and a dynamical map, *Phys. Lett.* **102** A (1984) 145–148.
- [–] Kolár M., Ali M. K., Generalized Fibonacci superlattices dynamical trace maps and magnetic excitations, *Phys. Rev. B* **39** (1989) 426–432.
- [–] Kolár M., Ali M. K., Attractors of some volume non-preserving trace maps, *Phys. Rev. A* **39** (1989) 6538–6543.
- [–] Kolár M., Ali M. K., Attractors in quantum Ising models, *Phys. Rev. B* **40** (1989) 11083–11089.
- [–] Kolár M., Ali M. K., One-dimensional generalized Fibonacci tilings, *Phys. Rev. B* **41** (1990) 7108–.
- [–] Kolár M., Ali M. K., Trace maps associated with general two-letter substitution rules, *Phys. Rev. A* **42** (1990) 7112–7124.
- [–] Kolár M., Ali M. K., Nori F., Generalized Thue-Morse chains and their physical properties, *Phys. Rev. B* **43** (1991) 1034–.
- [–] Kolár M., Iochum B., Raymond L., Structure factor of 1D systems (superlattices) based on two-letter substitution rules. I. δ (Bragg) peaks, *J. Phys. A: Math. Gen.* **26** (1993) 7343–7366.
- [–] Kolár M., Nori F., Trace maps of general substitutional sequences, *Phys. Rev. B* **42** (1990) 1062–1065.
- [–] Kolár M., Sütő A., The Kronig-Penney model on a Fibonacci lattice, *Phys. Lett. A* **117** (1986) 203–209.
- [–] Luck J.-M., Cantor spectra and scaling of gap widths in deterministic aperiodic systems, *Phys. Rev. B* **39** (1989) 5834–5849.
- [–] Luck J.-M., Critical behavior of the aperiodic quantum Ising chain in a transverse magnetic field, *J. Stat. Phys.* **72** (1993) 417–458.

- [–] Luck J.-M., Godrèche C., Janner A., Janssen T., The nature of the atomic surfaces of quasiperiodic self-similar structures, *J. Phys. A: Math. Gen.* **26** (1993) 1951–1999.
- [–] Luck J.-M., Orland H., Smilanski U., On the response of a two-level quantum system to a class of time dependent quasiperiodic perturbations, *J. Stat. Phys.* **53** (1988) 551–564.
- [–] MacDonald A. H., Aers G. C., Continuum-model acoustic and electronic properties for a Fibonacci superlattice, *Phys. Rev. B* **36** (1987) 9142–9145.
- [–] Macia E., Dominguez-Adame F., Exciton optical absorption in self-similar aperiodic lattices, *Preprint Madrid University* (1994).
- [–] Merlin R., Bajema K., Raman scattering by acoustic phonons and structural properties of Fibonacci, Thue-Morse and random superlattices, *J. de Phys. Colloq.* **48 C5** (1987) 503–506.
- [–] Merlin R., Bajema K., Clarke R., Juang F.-Y., Bhattacharya P. K., Quasi-periodic GaAs-AlAs heterostructures, *Phys. Rev. Lett.* **55** (1985) 1768–1770.
- [–] Ostlund S., Pandit R., Rand D., Schellnhuber H. J., Siggia E. D., Schrödinger equation with an almost periodic potential, *Phys. Rev. Lett.* **50** (1983) 1873–1876.
- [–] Peyrière J., On the trace map for products of matrices associated with substitutive sequences, *J. Stat. Phys.* **62** (1991) 411–414.
- [–] Peyrière J., Wen Z.-Y., Wen Z.-X., Polynômes associés aux endomorphismes de groupes libres, *Enseign. Math.* **39** (1993) 153–175.
- [–] Rivier N., A botanical quasicrystal, (Gratias D., Michel L. Eds), *J. de Phys. Colloq.* **47 C3** (1986) 299–309.
- [–] Roberts J. A. G., Baake M., The dynamics of trace maps, in: Hamiltonian mechanics: integrability and chaotic behaviour, Seimenis J. Ed, NATO ASI Series, Series B: Physics (Plenum Press, New York, 1994) p. 275–285.
- [–] Roberts J. A. G., Baake M., Trace maps as 3D reversible dynamical systems with an invariant, *J. Stat. Phys.* **74** (1994) 829–888.
- [–] Shechtman D., Blech I., Gratias D., Cahn J. V., Metallic phase with long-range orientational order and no translational symmetry, *Phys. Rev. Lett.* **53** (1984) 1951–1953.
- [–] Steinhardt P. J., Ostlund S., The physics of quasicrystals (World Scientific, Singapore, Philadelphia, 1987).
- [–] Sutherland B., Kohmoto M., Resistance of a one-dimensional quasicrystal, *Phys. Rev. B* **36** (1987) 5877–5886.
- [–] Sütő A., The spectrum of a quasiperiodic Schrödinger operator, *Comm. Math. Phys.* **111** (1987) 409–415.
- [–] Sütő A., Singular continuous spectrum on a Cantor set of zero Lebesgue measure for the Fibonacci hamiltonian, *J. Stat. Phys.* **56** (1989) 525–531.
- [–] Thomas U., Kramer P., The Fibonacci quasicrystal reconsidered: variety of energy spectra for continuous Schrödinger equations with simple

- potentials, *Int. J. Mod. Phys. B* **3** (1989) 1205–1235.
- [–] Todd J., Merlin R., Clarke R., Mohanty K. M., Axe J. D., Synchrotron X-ray study of a Fibonacci superlattice, *Phys. Rev. Lett.* **57** (1986) 1157–1160.
 - [–] Tracy C. A., Universality classes of some aperiodic Ising models, *J. Phys. A: Math. Gen.* **21** (1988) 603–605.
 - [–] Wen Z.-X., Wen Z.-Y., On the leading term and the degree of the polynomial trace mapping associated with a substitution, *J. Stat. Phys.* **75** (1994) 627–641.
 - [–] Würtz D., Soerensen M. P., Schneider T., Quasiperiodic Kronig-Penney model on a Fibonacci superlattice, *Helv. Phys. Acta* **61** (1988) 345–362.