

# Elliptic Modular Graphs, Eigenvalue Equations and Algebraic Identities

Anirban Basu<sup>1</sup>

Harish–Chandra Research Institute, A CI of Homi Bhabha National Institute,  
Chhatnag Road, Jhusi, Prayagraj 211019, India

## Abstract

We obtain eigenvalue equations satisfied by various elliptic modular graphs with five links where two of the vertices are unintegrated. Solving them leads to several non-trivial algebraic identities between these graphs.

arXiv:2210.00648v2 [hep-th] 19 Oct 2022

---

<sup>1</sup>email address: anirbanbasu@hri.res.in

# 1 Introduction

Modular graph functions [1,2] arise in the analysis of the low momentum expansion of string amplitudes at genus one. The links of these graphs are given by the scalar Green function or their worldsheet derivatives on the toroidal worldsheet  $\Sigma$ , while the vertices are integrated over  $\Sigma$ . In fact, using translational invariance on the torus, one of the vertices can be fixed and hence unintegrated. These graphs are invariant under  $SL(2, \mathbb{Z})$  transformations of the complex structure  $\tau$  of the torus. More generally, one can define modular graph forms that are  $SL(2, \mathbb{Z})$  covariant, but we shall not consider them in this paper.

To begin with, we consider all the graphs that arise in the low momentum expansion of the four graviton amplitude at genus one in type II string theory upto the  $D^{10}\mathcal{R}^4$  interaction [3,4], where schematically  $\mathcal{R}$  represents the Riemann tensor, and  $D$  is a derivative. These graphs have upto five links given by the scalar Green function. While one can analyze various properties of these graphs (see [5–7] for reviews), we shall focus on the eigenvalue equations they satisfy, and the various algebraic relations between themselves<sup>2</sup>. The various graphs that are relevant for our purposes are given in figure 1. While some of them arise in the four graviton amplitude, the rest arise in the relations involving them.

These modular graphs satisfy various eigenvalue equations, as well as several algebraic relations between themselves [1, 4, 10–22] demonstrating that many of them are not independent. Among them, the one loop graph with  $s$  links satisfies the eigenvalue equation ( $s \geq 2$ )

$$\Delta E_s = s(s-1)E_s \tag{1.1}$$

where  $\Delta$  is the Laplacian defined by

$$\Delta = 4\tau_2^2 \frac{\partial^2}{\partial\tau\partial\bar{\tau}} \tag{1.2}$$

and  $E_s$  is the non-holomorphic Eisenstein series. The cases  $2 \leq s \leq 5$  will be relevant for our purposes. We now consider the equations involving the other graphs.

While eigenvalue equations have been obtained for certain families of dihedral graphs defined as  $C_{a,b,c}$  and  $C_{a,b,c,d}$  [1, 19], we shall consider those that have less than or equal to five links, as well as several others that are not included in these families. We now list the eigenvalue equations satisfied by the various graphs (apart from  $E_s$ ) as well as the algebraic relations between them.

With three links, we have the eigenvalue equation

$$\Delta D_3 = 6E_3 \tag{1.3}$$

and the algebraic identity

$$D_3 = E_3 + \zeta(3) \tag{1.4}$$

between the graphs. For this case as well as the others to follow, the algebraic identities can be obtained by solving the eigenvalue equations along with a knowledge of the asymptotic expansion of the graphs around the cusp  $\tau_2 \rightarrow \infty$ .

---

<sup>2</sup>See [8] for reviews and recent discussions of methods different from the ones we use, and [9] for analysis of asymptotic expansions.

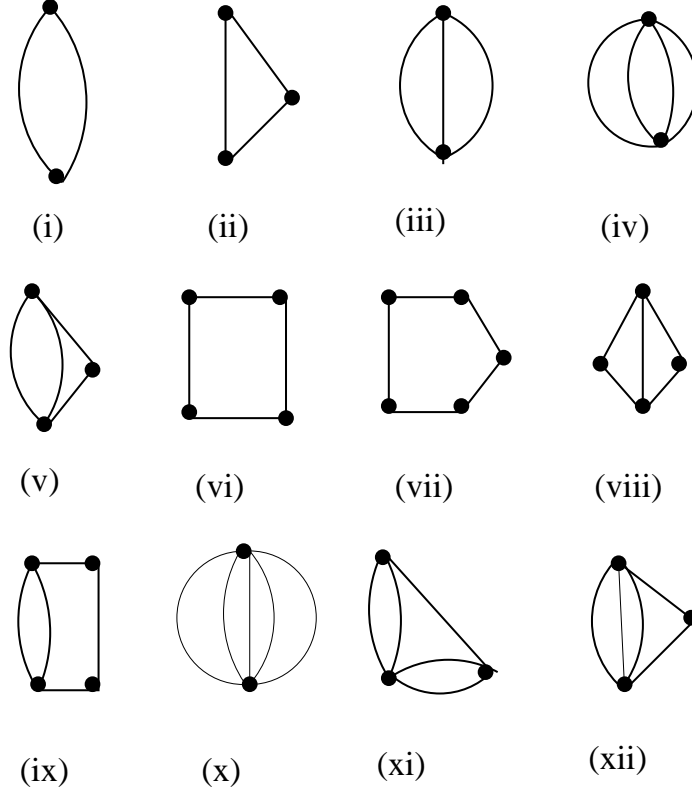

Figure 1: Modular graphs: (i)  $E_2$  (ii)  $E_3$  (iii)  $D_3$  (iv)  $D_4$  (v)  $C_{1,1,2}$  (vi)  $E_4$  (vii)  $E_5$  (viii)  $C_{1,2,2}$  (ix)  $C_{1,1,3}$  (x)  $D_5$  (xi)  $D_{1,2,2}$  (xii)  $D_{1,1,3}$

With four links, the eigenvalue equations and algebraic identities are

$$\begin{aligned} (\Delta - 2)C_{1,1,2} &= 9E_4 - E_2^2, \\ (\Delta - 2)(D_4 - 3E_2^2) &= 36E_4 - 24E_2^2 \end{aligned} \quad (1.5)$$

and

$$D_4 - 3E_2^2 = 24C_{1,1,2} - 18E_4 \quad (1.6)$$

respectively.

Finally with five links, we similarly obtain the eigenvalue equations

$$\begin{aligned} \Delta C_{1,2,2} &= 8E_5, \\ (\Delta - 6)C_{1,1,3} &= \frac{86}{5}E_5 - 4E_2E_3 + \frac{\zeta(5)}{10}, \\ (\Delta - 6)D_{1,2,2} &= \frac{144}{5}E_5 - 8E_2E_3 - \frac{8}{5}\zeta(5), \end{aligned}$$

$$\begin{aligned}
(\Delta - 6) \left( D_{1,1,3} - 3E_2E_3 \right) &= \frac{162}{5}E_5 - 30E_2E_3 - \frac{3}{10}\zeta(5), \\
(\Delta - 6) \left( D_5 - 10E_2D_3 \right) &= 360E_5 - 240E_2E_3 - 90\zeta(5),
\end{aligned} \tag{1.7}$$

as well as the algebraic identities

$$\begin{aligned}
C_{1,2,2} &= \frac{2}{5}E_5 + \frac{\zeta(5)}{30}, \\
10D_{1,2,2} &= 20C_{1,1,3} - 4E_5 + 3\zeta(5), \\
40 \left( D_{1,1,3} - 3E_2E_3 \right) &= 300C_{1,1,3} - 276E_5 + 7\zeta(5), \\
D_5 - 10E_2D_3 &= 60C_{1,1,3} - 48E_5 + 16\zeta(5).
\end{aligned} \tag{1.8}$$

Thus analyzing these graphs leads to a rich structure of eigenvalue equations they satisfy, as well as non-trivial algebraic identities between themselves which demonstrate that these graphs are all not independent.

We next consider elliptic modular graphs [2, 23, 24] which generalize the modular graphs that we have discussed so far. These arise in the asymptotic expansion of genus two graphs around the non-separating node on the moduli space of genus two Riemann surfaces. In an elliptic modular graph, at least two of the vertices are unintegrated over the toroidal worldsheet  $\Sigma$ . In fact, we shall consider the simplest case where only two of the vertices are unintegrated, which we label as 0 and  $v$  on  $\Sigma$ . These graphs are invariant under the  $SL(2, \mathbb{Z})$  transformation

$$\tau \rightarrow \frac{a\tau + b}{c\tau + d}, \quad v \rightarrow \frac{v}{c\tau + d}, \tag{1.9}$$

where  $a, b, c, d \in \mathbb{Z}$  and  $ad - bc = 1$ . Note that on identifying the two unintegrated vertices, the elliptic modular graph reduces to a modular graph. Various properties of elliptic modular graphs have been studied in [25–30].

Thus it is natural to ask how much of the structure of the eigenvalue equations satisfied by the modular graphs as well as the various algebraic identities between themselves, generalize to the case of elliptic modular graphs. The aim of this paper is to analyze this issue in detail. We shall consider elliptic modular graphs that have upto five links which arise very naturally from the modular graphs discussed above by cutting them open such that only two vertices are unintegrated. We shall obtain eigenvalue equations these graphs satisfy, and solve them to get several non-trivial algebraic identities they satisfy as well. Naturally, we expect these techniques to generalize to the cases where graphs have more links.

To start with, we briefly review results we shall need in order to calculate the eigenvalue equations these graphs satisfy. This is followed by describing the various elliptic modular graphs we shall analyze in detail. Next we obtain the eigenvalue equations satisfied by these graphs. Finally, we solve them to derive several algebraic identities they satisfy.

## 2 Green function, Laplacian and elliptic modular graphs

The coordinate on the torus,  $z$ , is defined by

$$-\frac{1}{2} \leq \operatorname{Re}z \leq \frac{1}{2}, \quad 0 \leq \operatorname{Im}z \leq \tau_2. \quad (2.1)$$

The integration measure is given by  $d^2z = d\operatorname{Re}z d\operatorname{Im}z$ , while the Dirac delta function is normalized to satisfy  $\int_{\Sigma} d^2z \delta^2(z) = 1$ .

The links of the graphs we consider in this paper are given by the scalar Green function on the toroidal worldsheet  $\Sigma$ . This is given by [3, 31]

$$G(z) = \frac{1}{\pi} \sum_{(m,n) \neq (0,0)} \frac{\tau_2}{|m\tau + n|^2} e^{\pi[\bar{z}(m\tau+n) - z(m\bar{\tau}+n)]/\tau_2}, \quad (2.2)$$

which is modular invariant and doubly periodic on the torus. It is single valued, and hence we can integrate by parts in the various expressions wherever appropriate, and neglect total derivatives which proves to be very useful in our analysis. In the modular invariant graphs in figure 1 as well as the ones that arise later, the vertices are integrated with the  $SL(2, \mathbb{Z})$  invariant measure  $d^2z/\tau_2$  over  $\Sigma$ .

Now from (2.2) we have that

$$\int_{\Sigma} d^2z G(z, w) = 0 \quad (2.3)$$

and hence we cannot have a graph where a link representing the Green function ends on an integrated vertex.

Also the Green function satisfies the equations

$$\begin{aligned} \bar{\partial}_w \partial_z G(z, w) &= \pi \delta^2(z - w) - \frac{\pi}{\tau_2}, \\ \bar{\partial}_z \partial_z G(z, w) &= -\pi \delta^2(z - w) + \frac{\pi}{\tau_2}. \end{aligned} \quad (2.4)$$

which we shall often use.

To find the eigenvalue equations satisfied by the various graphs, rather than directly acting on them by  $\Delta$  in (1.2) we analyze the variation of the complex structure deformation parametrized by the variation of the Beltrami differential<sup>3</sup>. To do so, we use the variations [1, 32, 33]

$$\partial_{\mu} G(z_1, z_2) = -\frac{1}{\pi} \int_{\Sigma} d^2z \partial_z G(z, z_1) \partial_z G(z, z_2), \quad (2.5)$$

as well as

$$\bar{\partial}_{\mu} \partial_{\mu} G(z_1, z_2) = 0 \quad (2.6)$$

---

<sup>3</sup>This strategy to obtain the eigenvalue equations has been used in [10, 12, 13, 16, 19, 26, 29].

where  $\mu$  is the Beltrami differential<sup>4</sup>.

The Laplacian is expressed in terms of the variations as

$$\Delta = \bar{\partial}_\mu \partial_\mu \quad (2.7)$$

which we shall use in obtaining the eigenvalue equations.

Let us now consider the various elliptic modular graphs we shall use in our analysis. From now onwards, for the sake of brevity, we shall refer to all graphs, elliptic or otherwise, as simply graphs.

To start with, consider the iterated Green function  $G_s(v)$  defined recursively by ( $s \geq 1$ )

$$G_{s+1}(v) = \int_\Sigma \frac{d^2z}{\tau_2} G(v, z) G_s(z) \quad (2.8)$$

where  $G_1(z)$  is the Green function (2.2) (thus  $G_s(0) = E_s$  for  $s \geq 2$ ). They satisfy

$$\Delta G_s(v) = s(s-1)G_s(v) \quad (2.9)$$

which generalizes (1.1). We shall need  $G_s(v)$  for  $s \leq 5$  in our analysis.

Another family of graphs  $D_l^{(k)}(v)$  is defined by ( $l \geq k$ )

$$D_l^{(k)}(v) = \int_\Sigma \frac{d^2z}{\tau_2} G(v, z)^k G(z)^{l-k} = D_l^{(l-k)}(v). \quad (2.10)$$

We shall also consider the family of graphs  $D^{(s_1, s_2, s_3)}(v)$  defined by

$$D^{(s_1, s_2, s_3)}(v) = \int_\Sigma \frac{d^2z}{\tau_2} G_{s_1}(v, z) G_{s_2}(v, z) G_{s_3}(z) = D^{(s_2, s_1, s_3)}(v), \quad (2.11)$$

as well as the family defined by

$$D^{(s_1, s_2, s_3, s_4)}(v) = \int_\Sigma \frac{d^2z}{\tau_2} G_{s_1}(v, z) G_{s_2}(v, z) G_{s_3}(v, z) G_{s_4}(z) \quad (2.12)$$

which is symmetric under the permutations of  $s_1, s_2$  and  $s_3$ .

Let us now mention the graphs having upto five links we shall need in our analysis, apart from  $G_s(v)$ .

With three links we consider  $D_3^{(1)}(v) = D^{(1,1,1)}(v)$  which is obtained from cutting open  $D_3$  and hence  $D_3^{(1)}(0) = D_3$ , as given in figure 2.

With four links, we have  $D_4^{(1)}(v)$  and  $D_4^{(2)}(v)$  which are obtained by cutting open  $D_4$ , and hence  $D_4^{(1)}(0) = D_4^{(2)}(0) = D_4$ . We also have  $D^{(1,2,1)}(v)$  as well as  $D^{(1,1,2)}(v)$  from cutting open  $C_{1,1,2}$ , and hence  $D^{(1,2,1)}(0) = D^{(1,1,2)}(0) = C_{1,1,2}$  as given in figure 3.

We now consider the graphs with five links<sup>5</sup> which forms the central part of the analysis of the paper. While some of them are from the families of graphs mentioned above, the others go beyond. We obtain:

---

<sup>4</sup>While the Beltrami differential is trivial on the torus, its variations are non-trivial.

<sup>5</sup>All the elliptic modular graphs with five links we shall need are given in figure 4.

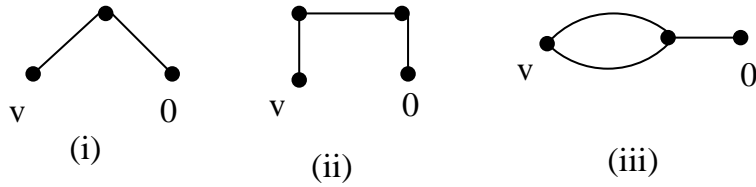

Figure 2: Elliptic modular graphs with two links: (i)  $G_2(v)$ , with three links: (ii)  $G_3(v)$ , (iii)  $D_3^{(1)}(v)$

(i)  $D^{(2,2,1)}(v)$  and  $D^{(1,2,2)}(v)$  from cutting open  $C_{1,2,2}$ , and hence  $D^{(2,2,1)}(0) = D^{(1,2,2)}(0) = C_{1,2,2}$ .

(ii)  $D^{(1,3,1)}(v)$  and  $D^{(1,1,3)}(v)$  from cutting open  $C_{1,1,3}$ , and hence  $D^{(1,3,1)}(0) = D^{(1,1,3)}(0) = C_{1,1,3}$ .

(iii)  $D_5^{(1)}(v)$  and  $D_5^{(2)}(v)$  from cutting open  $D_5$ , and hence  $D_5^{(1)}(0) = D_5^{(2)}(0) = D_5$ ,

(iv)  $D^{(1,1,1,2)}(v)$ ,  $D^{(1,1,2,1)}(v)$  and  $D_5^{(1,2,2)}(v)$  from cutting open  $D_{1,1,3}$ , and hence  $D^{(1,1,1,2)}(0) = D^{(1,1,2,1)}(0) = D_5^{(1,2,2)}(0) = D_{1,1,3}$ ,

(v)  $D_5^{(2;2;1)}(v)$ ,  $D_5^{(1,2,1;1)}(v)$  and  $D_5^{(1;2;2)}(v)$  from cutting open  $D_{1,2,2}$ , and hence  $D^{(2;2;1)}(0) = D^{(1,2,1;1)}(0) = D_5^{(1;2;2)}(0) = D_{1,2,2}$ .

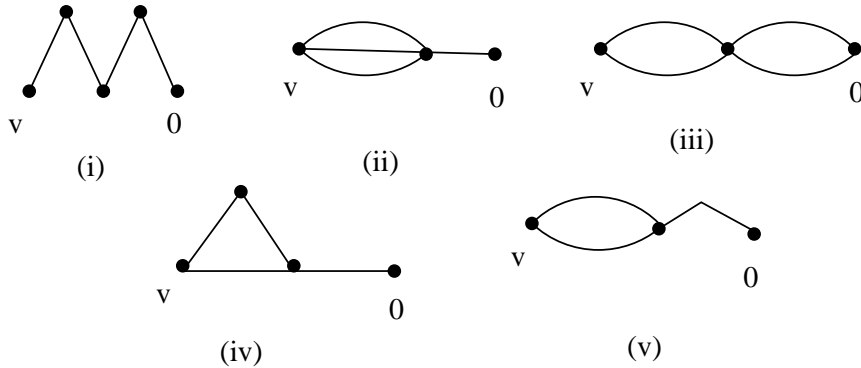

Figure 3: Elliptic modular graphs with four links: (i)  $G_4(v)$ , (ii)  $D_4^{(1)}(v)$ , (iii)  $D_4^{(2)}(v)$ , (iv)  $D^{(1,2,1)}(v)$ , (v)  $D^{(1,1,2)}(v)$

Thus this list includes all graphs that can be obtained from cutting open the graphs listed in figure 1, and hence is the complete list of elliptic modular graphs in which the links are given by the Green function and not its derivatives.

Note that the labels 0 and  $v$  for the unintegrated vertices can be interchanged for each

of these graphs.

### 3 Eigenvalue equations satisfied by the elliptic modular graphs

We now consider the eigenvalue equations satisfied by the various elliptic modular graphs. While  $G_s(v)$  satisfies an elementary equation given by (2.9), the others satisfy equations which reveal a far richer structure, which is one of the central themes of our analysis.

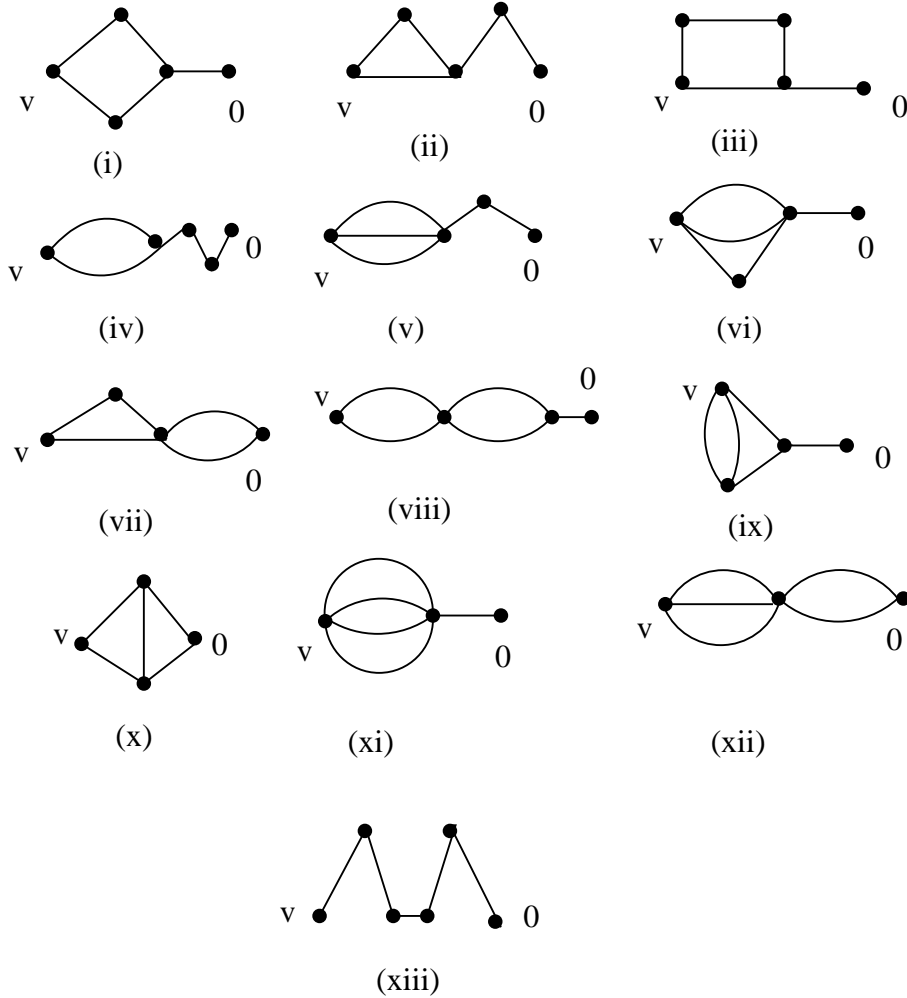

Figure 4: Elliptic modular graphs with five links: (i)  $D^{(2,2,1)}(v)$ , (ii)  $D^{(1,2,2)}(v)$ , (iii)  $D^{(1,3,1)}(v)$ , (iv)  $D^{(1,1,3)}(v)$ , (v)  $D^{(1,1,1,2)}(v)$ , (vi)  $D^{(1,1,2,1)}(v)$ , (vii)  $D_5^{(1,2,2)}(v)$ , (viii)  $D_5^{(2;2;1)}(v)$ , (ix)  $D_5^{(1,2,1;1)}(v)$ , (x)  $D_5^{(1;2;2)}(v)$ , (xi)  $D_5^{(1)}(v)$ , (xii)  $D_5^{(2)}(v)$ , (xiii)  $G_5(v)$

First we consider the graph  $D_3^{(1)}(v)$  with three links. It satisfies the eigenvalue equa-



tion [29]

$$\Delta D_3^{(1)}(v) = 2E_3 + 4G_3(v) - \frac{2\tau_2}{\pi} \partial_v G_2(v) \bar{\partial}_v G_2(v). \quad (3.1)$$

Thus given the eigenvalue equation satisfied by  $G_3(v)$  we see that there is no algebraic relation between them.

We next consider the graphs with four links. The graph  $D^{(1,1,2)}(v)$  satisfies the eigenvalue equation [26]

$$(\Delta - 2)D^{(1,1,2)}(v) = 10G_4(v) - E_2^2 - E_4 + \mathcal{F}_2(v)^2 \quad (3.2)$$

where  $\mathcal{F}_2(v) = E_2 - G_2(v)$ . Proceeding along the same lines, we get that  $D^{(1,2,1)}(v)$  satisfies the eigenvalue equation

$$(\Delta - 2)D^{(1,2,1)}(v) = 5E_4 + 4G_4(v) - G_2(v)^2 - \frac{2\tau_2}{\pi} \left( \partial_v G_2(v) \bar{\partial}_v G_3(v) + c.c. \right). \quad (3.3)$$

While  $D_4^{(1)}(v)$  and  $D_4^{(2)}(v)$  each satisfies an eigenvalue equation involving graphs with links given by derivatives of the Green function that is far more involved than the ones above, all the derivatives cancel in an eigenvalue equation involving the combination<sup>6</sup>

$$\mathcal{F}_4(v) = \frac{D_4}{12} - \frac{D_4^{(1)}(v)}{3} + \frac{D_4^{(2)}(v)}{4}, \quad (3.4)$$

leading to [25, 26, 28]

$$(\Delta - 2) \left( \mathcal{F}_4(v) - \frac{1}{2} \mathcal{F}_2(v)^2 \right) = -2\mathcal{F}_2(v)^2. \quad (3.5)$$

In fact analyzing the eigenvalue equations satisfied by  $D^{(1,1,2)}(v)$ ,  $\mathcal{F}_4(v)$  and  $D_4$ , we obtain a non-trivial algebraic identity between the various graphs given by [26, 30]<sup>7</sup>

$$D_4^{(1,1,2)}(v) - \frac{D_4^{(1)}(v)}{6} + \frac{D_4^{(2)}(v)}{8} - G_4(v) - \frac{G_2(v)^2}{4} + \frac{1}{2} E_2 G_2(v) + \frac{E_4}{4} - \frac{E_2^2}{8} = 0. \quad (3.7)$$

Let us highlight some of the features in the analysis involving graphs with four links. Generic graphs satisfy eigenvalue equations which involve graphs with links given by derivatives of Green functions, and not just Green functions. However, manipulating a subset of these equations judiciously, we obtain equations where terms involving derivatives of Green functions cancel. Solving these equations eventually leads to the algebraic identity between the graphs.

---

<sup>6</sup>In fact the combination  $D_4^{(1)}(v) - 3D_4^{(2)}(v)/4$  is good enough, however,  $\mathcal{F}_4(v)$  yields a compact looking equation.

<sup>7</sup>This follows from the fact that  $\Phi(v)$  satisfies the equation

$$(\Delta - 2)\Phi(v) = 0 \quad (3.6)$$

where  $\Phi(v)$  is the expression on the left hand side of (3.7). The identity (3.7) has been obtained in [30] using different techniques.

It is natural to expect that this phenomenon persists for elliptic modular graphs with arbitrary number of links, given that many modular graphs have been analyzed which satisfy eigenvalue equations involving graphs with links given by Green functions, solving which lead to algebraic identities among themselves. We shall see this expectation is indeed true for the case of elliptic modular graphs with five links, which generalize the structure of (1.7) and (1.8) to graphs with two unintegrated vertices.

Thus, we now systematically obtain the eigenvalue equations satisfied by the various graphs with five links. Very briefly, we shall consider the action of (2.7) on any graph, and manipulate it to get the final expression, on making heavy use of (2.4). Naturally, it will be very useful to denote various expressions graphically. Derivatives of Green functions will be denoted as given in figure 5.

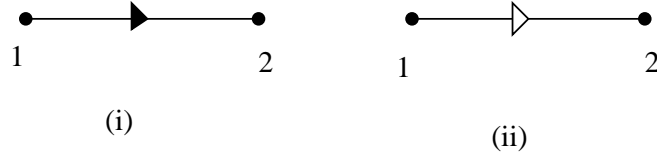

Figure 5: (i)  $\partial_{z_2} G(z_1, z_2) = -\partial_{z_1} G(z_1, z_2)$ , (ii)  $\bar{\partial}_{z_2} G(z_1, z_2) = -\bar{\partial}_{z_1} G(z_1, z_2)$

Also for the sake of brevity, we shall denote the integral over  $z_i$  as  $\int_i$ . The measure ( $d^2 z_i$  or  $d^2 z_i/\tau_2$ ) will be left implicit. At intermediate stages of the analysis, we set  $G(z, z) = 0$  to regularize whenever this expression arises, as such divergences arising from coincident points do not lie on the moduli space of these graphs.

To start with, we obtain the eigenvalue equations for  $D^{(2,2,1)}(v)$  and  $D^{(1,2,2)}(v)$  which we obtain from cutting open  $C_{1,2,2}$ . Note that we have not included the graph on the left hand side of figure 6 in the list because of the equality it satisfies, which follows from figure 7 using elementary integration by parts and (2.4).

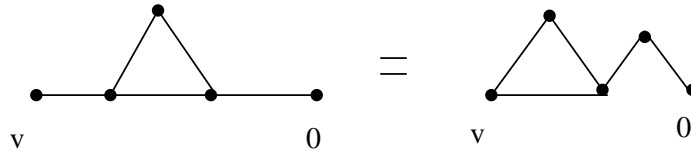

Figure 6: An identity among graphs

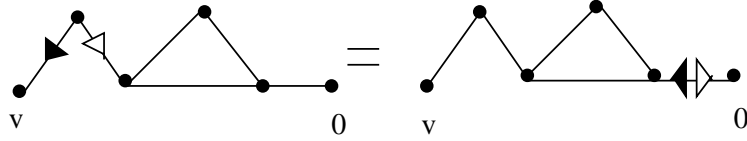

Figure 7: Proof of figure 6

### 3.1 Eigenvalue equation for $D^{(2,2,1)}(v)$

To start with, we consider the graph  $D^{(2,2,1)}(v)$ . We get that

$$\begin{aligned}
 (\Delta - 4)D^{(2,2,1)}(v) &= 8 \int_{z w u} G(v, z)G(v, w)\partial_\mu G(z, u)\bar{\partial}_\mu G(w, u)G(u) \\
 &+ 4 \int_{z w u} \left( G(v, z)G(v, w)\partial_\mu G(z, u)G(w, u)\bar{\partial}_\mu G(u) + c.c. \right) \\
 &= 8E_5 - 4D^{(2,2,1)}(v) + \frac{4}{\pi} \left( F_1(v) - F_2(v) + c.c. \right) - \frac{8\tau_2}{\pi} \partial_v G_3(v)\bar{\partial}_v G_3(v), \quad (3.8)
 \end{aligned}$$

where the graphs  $F_1(v)$  and  $F_2(v)$  are given in figure 8<sup>8</sup>.

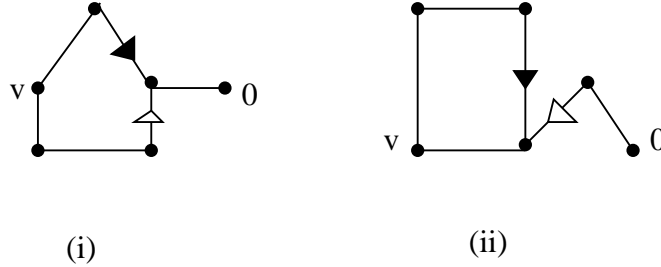

Figure 8: (i)  $F_1(v)$ , (ii)  $F_2(v)$

Using the results in appendix A, this gives us that

$$\begin{aligned}
 (\Delta - 4)D^{(2,2,1)}(v) &= 12E_5 - 4G_5(v) + 4E_3G_2(v) - 4D^{(1,2,2)}(v) \\
 &- 4G_2(v)G_3(v) - \frac{8\tau_2}{\pi} \partial_v G_3(v)\bar{\partial}_v G_3(v). \quad (3.9)
 \end{aligned}$$

<sup>8</sup>For these graphs as well as the ones to be considered later on, the vertices are integrated with the measure  $d^2z/\tau_2$ , while there is an overall factor of  $\tau_2$  for every factor of  $\partial\bar{\partial}$  in the graph. Hence they are modular invariant.

### 3.2 Eigenvalue equation for $D^{(1,2,2)}(v)$

We next consider the graph  $D^{(1,2,2)}(v)$ , which yields

$$\begin{aligned} (\Delta - 4)D^{(1,2,2)}(v) &= 2 \int_{zw} \left( G(v, w) \partial_\mu G(w, z) \bar{\partial}_\mu G(v, z) G_2(z) + c.c. \right) \\ &\quad + 4 \int_{z w u} \left( G(v, w) G(v, z) \partial_\mu G(w, z) G(z, u) \bar{\partial}_\mu G(u) + c.c. \right) \\ &\quad + 2 \int_{zw} \left( G_2(v, z) \partial_\mu G(v, z) G(z, w) \bar{\partial}_\mu G(w) + c.c. \right), \end{aligned} \quad (3.10)$$

leading to

$$\Delta D^{(1,2,2)}(v) = 8E_5 - \frac{2}{\pi} \left( F_1(v) - F_2(v) + c.c. \right). \quad (3.11)$$

This gives us

$$(\Delta - 2)D^{(1,2,2)}(v) = 10G_5(v) + 2G_2(v)G_3(v) - 2E_5 - 2D^{(2,2,1)}(v) - 2E_3G_2(v) \quad (3.12)$$

on using appendix A. This eigenvalue equation does not contain any graph with links given by derivatives of Green functions.

We next consider the graphs  $D^{(1,3,1)}(v)$  and  $D^{(1,1,3)}(v)$  that arise from cutting open  $C_{1,1,3}$ . We do not include the graph on the left hand side of figure 9 in the list because of the equality given in the figure.

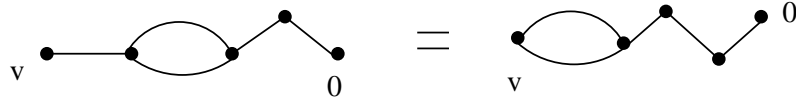

Figure 9: An identity among graphs

### 3.3 Eigenvalue equation for $D^{(1,3,1)}(v)$

Starting with  $D^{(1,3,1)}$ , we have that

$$\begin{aligned} (\Delta - 6)D^{(1,3,1)}(v) &= 3 \int_{zw} \left( G_2(v, z) \partial_\mu G(z, w) \bar{\partial}_\mu G(v, w) G(w) + c.c. \right) \\ &\quad + 3 \int_{zw} \left( G_2(v, z) \partial_\mu G(z, w) G(v, w) \bar{\partial}_\mu G(w) + c.c. \right) \\ &\quad + \int_z \left( G_3(v, z) \partial_\mu G(v, z) \bar{\partial}_\mu G(z) + c.c. \right), \end{aligned} \quad (3.13)$$

leading to

$$\begin{aligned} (\Delta - 2)D^{(1,3,1)}(v) &= 6E_5 - D^{(2,2,1)}(v) + 6G_5(v) \\ &\quad - \frac{3\tau_2}{\pi} \left( \partial_v G_2(v) \bar{\partial}_v G_4(v) + c.c. \right) + \frac{2}{\pi} \left( F_1(v) + F_2(v) + c.c. \right). \end{aligned} \quad (3.14)$$

Again using results in appendix A, we get that

$$\begin{aligned} (\Delta - 6)D^{(1,3,1)}(v) &= 8E_5 + D^{(2,2,1)}(v) + 8G_5 + 2D^{(1,2,2)}(v) - 2E_3 G_2(v) \\ &\quad - 2G_2(v) G_3(v) - \frac{3\tau_2}{\pi} \left( \partial_v G_2(v) \bar{\partial}_v G_4(v) + c.c. \right). \end{aligned} \quad (3.15)$$

### 3.4 Eigenvalue equation for $D^{(1,1,3)}(v)$

For  $D^{(1,1,3)}(v)$ , we get that

$$\begin{aligned} (\Delta - 6)D^{(1,1,3)}(v) &= 2 \int_z \partial_\mu G(v, z) \bar{\partial}_\mu G(v, z) G_3(z) \\ &\quad + 6 \int_{zw} \left( G(v, z) \partial_\mu G(v, z) \bar{\partial}_\mu G(z, w) G_2(w) + c.c. \right), \end{aligned} \quad (3.16)$$

yielding

$$(\Delta - 10)D^{(1,1,3)}(v) = 12G_5(v) - \frac{2}{\pi} F_3(v) - \frac{4}{\pi} \left( F_4(v) + c.c. \right) \quad (3.17)$$

where the graphs  $F_3(v)$  and  $F_4(v)$  are given in figure 10.

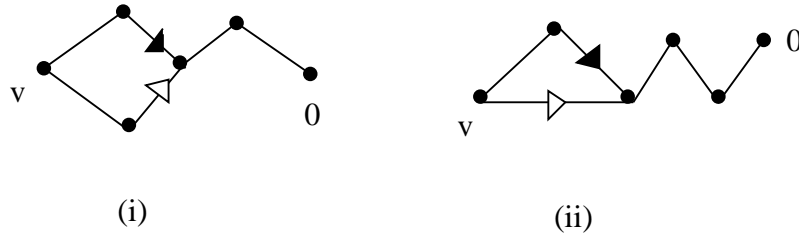

Figure 10: (i)  $F_3(v)$ , (ii)  $F_4(v)$

Using the results in appendix A, this gives us

$$(\Delta - 6)D^{(1,1,3)}(v) = 2D^{(1,2,2)}(v) + D^{(2,2,1)}(v) - 4E_2 G_3(v) + 16G_5(v). \quad (3.18)$$

This is another instance of a graph whose eigenvalue equation does not involve graphs with links given by derivatives of Green functions.

We next consider the graphs  $D^{(1,1,1,2)}(v)$ ,  $D^{(1,1,2,1)}(v)$  and  $D_5^{(1,2,2)}(v)$  that are obtained by cutting open  $D_{1,1,3}$ . We do not consider the graph on the left hand side of figure 11 because of the equality it satisfies.

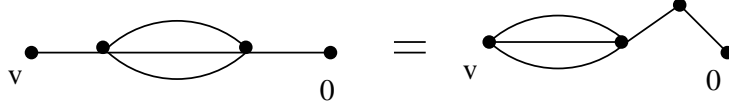

Figure 11: An identity among graphs

### 3.5 Eigenvalue equation for $D^{(1,1,1,2)}(v)$

For  $D^{(1,1,1,2)}(v)$ , we have that

$$\begin{aligned} \frac{1}{6}(\Delta - 2)D^{(1,1,1,2)}(v) &= \int_z G(v, z)\partial_\mu G(v, z)\bar{\partial}_\mu G(v, z)G_2(z) \\ &+ \int_{zw} \left( G^2(v, z)\partial_\mu G(v, z)\bar{\partial}_\mu G(z, w)G(w) + c.c. \right). \end{aligned} \quad (3.19)$$

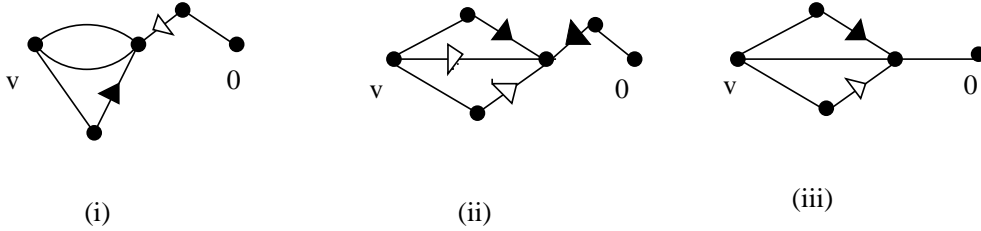

Figure 12: (i)  $F_5(v)$ , (ii)  $F_6(v)$ , (iii)  $F_7(v)$

Now the first term on the right hand side of (3.19) gives

$$\begin{aligned} \int_z G(v, z)\partial_\mu G(v, z)\bar{\partial}_\mu G(v, z)G_2(z) &= D^{(1,2,2)}(v) - \frac{1}{2}D^{(2,2,1)}(v) \\ &- \frac{1}{2\pi}(F_5(v) + c.c.) + \frac{1}{\pi^2}(F_6(v) + c.c.) - \frac{1}{\pi}F_7(v), \end{aligned} \quad (3.20)$$

where the graphs  $F_5(v)$ ,  $F_6(v)$  and  $F_7(v)$  are given in figure 12.

While  $F_5(v)$  and  $F_7(v)$  are graphs with two derivatives,  $F_6(v)$  has four derivatives. We now express  $F_6(v)$  differently which will be very useful for our purposes<sup>9</sup>. To do so, for this case as well as for the several others to follow, we introduce auxiliary graphs. These graphs are related to the original graph using (2.4) very easily. On the other hand, they can be manipulated in a different way by moving the derivatives along the links by integrating by parts, to obtain the desired relation between the original graph and several others. This technique has proved very useful in obtaining the eigenvalue equations in [12, 13, 19, 26].

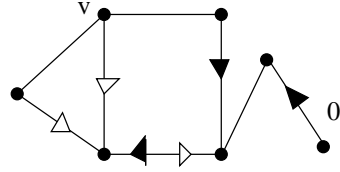

Figure 13: Auxiliary graph  $F_8(v)$

For  $F_6(v)$ , we introduce the auxiliary graph  $F_8(v)$  given in figure 13. Using (2.4) for the link having both the  $\partial$  and  $\bar{\partial}$  derivatives, we see that

$$\frac{1}{\pi} F_8(v) = F_6(v) - P_1(v)P_2^*, \quad (3.21)$$

where the graphs  $P_1(v)$  and  $P_2$  are given in appendix B.

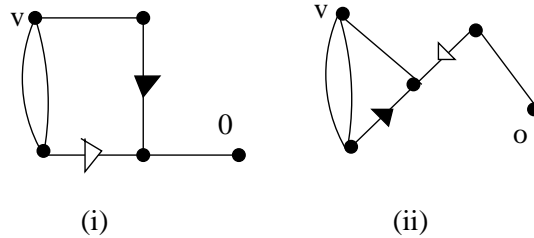

Figure 14: (i)  $F_9(v)$ , (ii)  $F_{10}(v)$

Thus the second term on the right hand side of (3.21) has a special structure and factorizes into two contributions, one of which has two  $\partial$ s while the other has two  $\bar{\partial}$ s.

---

<sup>9</sup>From now onwards, we shall often say that we “simplify” various graphs. This will either mean that we express a graph in terms of graphs with lesser number of derivatives along the links, or express it in terms of graphs with the same number of derivatives along the links. However, in the second case, the resulting graphs will be either from among those that have already appeared in the analysis before, or have a special structure. As we shall see, this “simplification” is crucial to obtain the algebraic identities from solving the eigenvalue equations.

This will be generically true of such manipulations involving auxiliary graphs, and we shall see that these terms play a very important role in obtaining the eigenvalue equations. Alternatively, we can calculate  $F_8(v)$  in another way by moving the derivatives differently around the circuit, leading to the relation

$$\left(F_6(v) + c.c.\right) - \left(P_1(v)P_2^* + c.c.\right) = -\pi\left(F_1(v) + F_2(v) - \frac{F_9(v)}{2} - \frac{F_{10}(v)}{2} + c.c.\right), \quad (3.22)$$

where the graphs  $F_9(v)$  and  $F_{10}(v)$  are given in figure 14, which can be simplified using the results in appendix A.

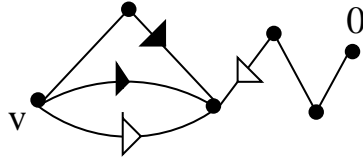

Figure 15:  $F_{11}(v)$

We now consider the second term on the right hand side of (3.19), which gives

$$\begin{aligned} \int_{zw} \left(G^2(v, z)\partial_\mu G(v, z)\bar{\partial}_\mu G(z, w)G(w) + c.c.\right) &= -\frac{4}{3}D^{(1,1,1,2)}(v) \\ +4D^{(1,1,3)}(v) + \frac{1}{\pi}\left(F_5(v) + c.c.\right) - \frac{2}{\pi}\left(F_4(v) - \frac{F_{11}(v)}{\pi} + c.c.\right), \end{aligned} \quad (3.23)$$

where the graph  $F_{11}(v)$  is given in figure 15.

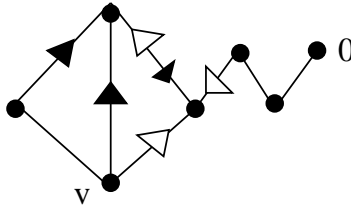

Figure 16: Auxiliary graph  $F_{12}(v)$

To simplify  $F_{11}(v)$  we start with the auxiliary graph  $F_{12}(v)$  given in figure 16, to get

$$\begin{aligned} \left(F_{11}(v) + c.c.\right) - \left(P_1(v)P_2^* + c.c.\right) &= D^{(1,1,1,2)}(v) - 2D^{(1,2,2)}(v) \\ -D^{(1,1,3)}(v) - E_2G_3(v) + 2G_5(v) + \frac{1}{\pi}\left(F_2(v) - \frac{F_{10}(v)}{2} + c.c.\right). \end{aligned} \quad (3.24)$$



Adding the various contributions, we get the eigenvalue equation

$$\begin{aligned}
\frac{1}{6}(\Delta - 6)D^{(1,1,1,2)}(v) &= \frac{3}{\pi^2}(P_1(v)P_2^* + c.c.) + 2D^{(1,1,3)}(v) - 3D^{(1,2,2)}(v) \\
&- \frac{1}{2}D^{(2,2,1)}(v) - 2E_2G_3(v) + 4G_5(v) + \frac{1}{2\pi}(F_5(v) + c.c.) - \frac{1}{\pi}F_7(v) \\
&- \frac{1}{\pi}\left(F_1(v) - F_2(v) + 2F_4(v) - \frac{F_9(v)}{2} + \frac{F_{10}(v)}{2} + c.c.\right). \tag{3.25}
\end{aligned}$$

Now we can simplify the final expression in (3.25) using the identities in appendix A<sup>10</sup>, but we refrain from doing so as it is not particularly illuminating.

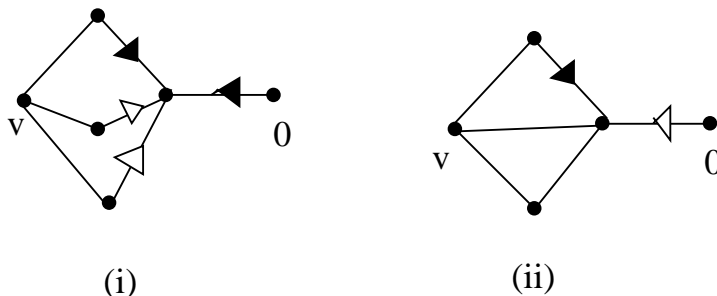

Figure 17: (i)  $F_{13}(v)$ , (ii)  $F_{14}(v)$

This will be the strategy we shall follow for the remaining eigenvalue equations as well. We shall simply collect the various contributions and write down the equation. However, we shall postpone simplifying various contributions we can simplify using the results in the appendices. One of the obvious reasons is that the resulting cumbersome expression is not readily useful. However, the principal reason is that we shall combine the various eigenvalue equations later on to obtain much more tractable equations we shall solve, and further striking simplifications happen during the process of combining the contributions from the various eigenvalue equations. This makes simplifying at this stage unnecessary.

Thus we see that the eigenvalue equation we have obtained for  $D^{(1,1,1,2)}(v)$  is significantly more involved than the ones we have obtained before. This will also be true of the eigenvalue equations we shall obtain for the remaining graphs.

### 3.6 Eigenvalue equation for $D^{(1,1,2,1)}(v)$

We next consider the eigenvalue equation for  $D^{(1,1,2,1)}(v)$ . We get that

---

<sup>10</sup>In fact,  $F_5(v) + c.c.$  can be simplified also, as we show in appendix C.

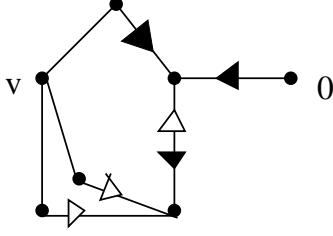

Figure 18: Auxiliary graph  $F_{15}(v)$

$$\begin{aligned}
\frac{1}{2}(\Delta - 2)D^{(1,1,2,1)}(v) &= \int_z G_2(v, z)\partial_\mu G(v, z)\bar{\partial}_\mu G(v, z)G(z) \\
&+ 2 \int_{zw} \left( G(v, z)\partial_\mu G(v, z)G(v, w)\bar{\partial}_\mu G(w, z)G(z) + c.c. \right) \\
&+ \int_z \left( G_2(v, z)G(v, z)\partial_\mu G(v, z)\bar{\partial}_\mu G(z) + c.c. \right) \\
&+ \int_{zw} \left( G^2(v, z)G(v, w)\partial_\mu G(w, z)\bar{\partial}_\mu G(z) + c.c. \right). \quad (3.26)
\end{aligned}$$

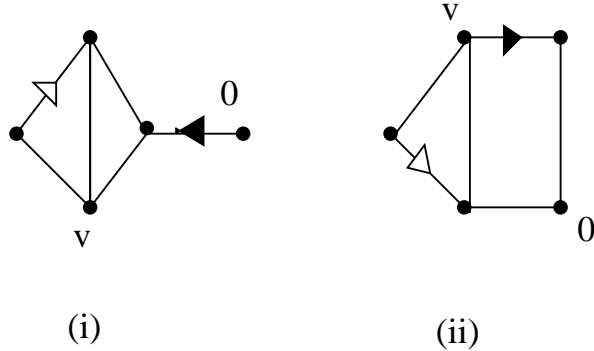

Figure 19: (i)  $F_{16}(v)$ , (ii)  $F_{17}(v)$

The first term on the right hand side of (3.26) gives

$$\begin{aligned}
\int_z G_2(v, z)\partial_\mu G(v, z)\bar{\partial}_\mu G(v, z)G(z) &= D^{(1,1,2,1)}(v) + \frac{1}{2}C_{1,2,2} \\
-\frac{\tau_2}{\pi}G_2(v)\partial_v G_2(v)\bar{\partial}_v G_2(v) - \frac{3}{\pi}F_7(v) + \frac{1}{\pi} \left( \frac{F_{13}(v)}{\pi} - F_{14}(v) + c.c. \right), \quad (3.27)
\end{aligned}$$

where the graphs  $F_{13}(v)$  and  $F_{14}(v)$  are given in figure 17.

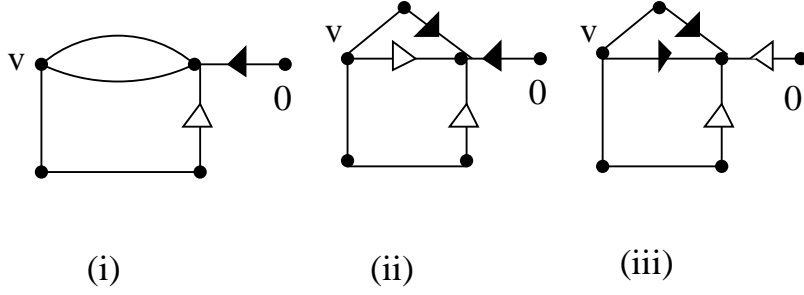

Figure 20: (i)  $F_{18}(v)$ , (ii)  $F_{19}(v)$ , (iii)  $F_{20}(v)$

To simplify  $F_{13}(v)$ , we start with the auxiliary graph  $F_{15}(v)$  given in figure 18, leading to

$$\left(F_{13}(v) + c.c.\right) - \left(P_3(v)P_4^* + c.c.\right) = 2\pi \left(F_{16}(v) + F_{17}(v) - Q_1 + c.c.\right), \quad (3.28)$$

where the graphs  $P_3(v)$ ,  $P_4$  and  $Q_1$  are given in appendix B, and the graphs  $F_{16}(v)$  and  $F_{17}(v)$  are given in figure 19<sup>11</sup>.

The second term on the right hand side of (3.26) gives

$$\begin{aligned} \int_{zw} \left(G(v, z)\partial_\mu G(v, z)G(v, w)\bar{\partial}_\mu G(w, z)G(z) + c.c.\right) &= -D^{(1,1,2,1)}(v) - \frac{1}{2\pi} \left(F_{18}(v) + c.c.\right) \\ + \frac{1}{\pi} \left(Q_1 + c.c.\right) - \frac{1}{\pi} G(v) \left(\partial_v G_2(v)\bar{\partial}_v G_3(v) + c.c.\right) &+ \frac{1}{\pi} \left(F_1(v) + c.c.\right) + \frac{2F_7(v)}{\pi} \\ + \frac{1}{\pi^2} \left(F_{19}(v) + F_{20}(v) + c.c.\right), & \end{aligned} \quad (3.29)$$

where the graphs  $F_{18}(v)$ ,  $F_{19}(v)$  and  $F_{20}(v)$  are given in figure 20.

To simplify  $F_{19}(v)$  and  $F_{20}(v)$ , we introduce the auxiliary graphs  $F_{21}(v)$  and  $F_{22}(v)$  respectively as given in figure 21.

For  $F_{19}(v)$  this gives us

$$\begin{aligned} \left(F_{19}(v) + c.c.\right) - \left(P_3(v)P_4^* + c.c.\right) &= \pi \left(F_{23}(v) - F_{24}(v) + F_{25}(v) + Q_1 + c.c.\right) \\ - \pi\tau_2 \left(\partial_v G_2(v)\bar{\partial}_v G_4(v) + c.c.\right) &+ 2\pi^2 E_5 - 2\pi^2 C_{1,2,2}, \end{aligned} \quad (3.30)$$

where the graphs  $F_{23}(v)$ ,  $F_{24}(v)$  and  $F_{25}(v)$  are given in figure 22.

<sup>11</sup>Note that  $F_{17}(v)$  factorizes into a product of two graphs. This will be true of several graphs that arise in our analysis, which factorize into a product of several graphs.

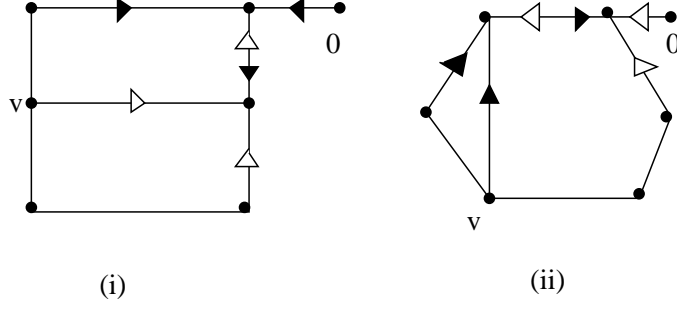

Figure 21: Auxiliary graphs (i)  $F_{21}(v)$ , (ii)  $F_{22}(v)$

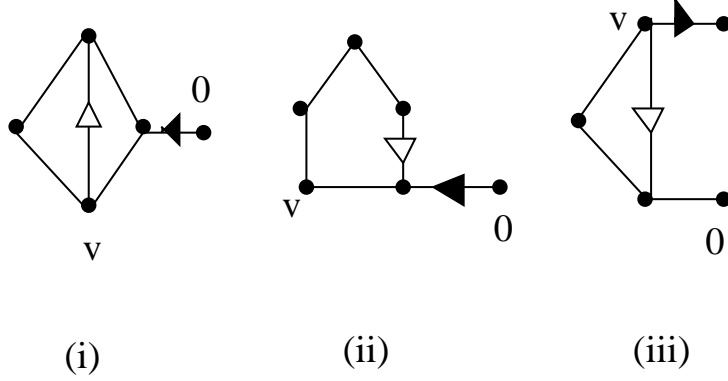

Figure 22: (i)  $F_{23}(v)$ , (ii)  $F_{24}(v)$ , (iii)  $F_{25}(v)$

For  $F_{20}(v)$ , we get

$$\begin{aligned}
& \left( F_{20}(v) + c.c. \right) - \left( P_1(v)P_2^* + c.c. \right) = 2\pi^2 E_5 - \pi^2 C_{1,1,3} + \pi^2 D^{(1,1,2,1)}(v) \\
& - 2\pi^2 D^{(2,2,1)}(v) - \pi^2 E_2 G_3(v) - 2\pi\tau_2 \partial_v G_3(v) \bar{\partial}_v G_3(v) \\
& + \pi \left( F_1(v) - \frac{F_9(v)}{2} + \frac{F_{26}(v)}{2} + c.c. \right), \tag{3.31}
\end{aligned}$$

where the graph  $F_{26}(v)$  is given in figure 23.

Now the third term on the right hand side of (3.26) gives

$$\begin{aligned}
& \int_z \left( G_2(v, z)G(v, z)\partial_\mu G(v, z)\bar{\partial}_\mu G(z) + c.c. \right) = D^{(2,2,1)}(v) - D^{(1,1,2,1)}(v) \\
& + \frac{1}{\pi} \left( F_{14}(v) - \frac{3F_5(v)}{2} + \frac{F_6(v)}{\pi} + \frac{F_{27}(v)}{\pi} + c.c. \right), \tag{3.32}
\end{aligned}$$

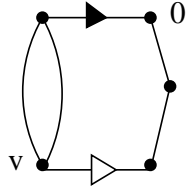

Figure 23:  $F_{26}(v)$

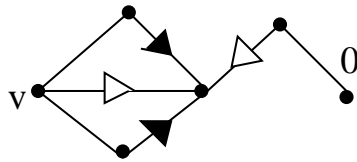

Figure 24:  $F_{27}(v)$

where the graph  $F_{27}(v)$  is given in figure 24.

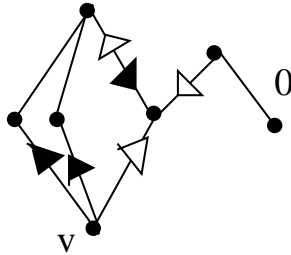

Figure 25: Auxiliary graph  $F_{28}(v)$

To simplify  $F_{27}(v)$ , we consider the auxiliary graph  $F_{28}(v)$  given in figure 25, which leads to

$$\left(F_{27}(v) + c.c.\right) - \left(P_3(v)P_4^* + c.c.\right) = -4\pi^2 D^{(1,1,3)}(v) + 2\pi \left(F_4(v) + F_{29}(v) + c.c.\right), \quad (3.33)$$

where the graph  $F_{29}(v)$  is given in figure 26.

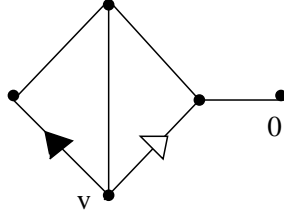

Figure 26:  $F_{29}(v)$

Finally, the fourth term on the right hand side of (3.26) is given by

$$\int_{zw} \left( G^2(v, z)G(v, w)\partial_\mu G(w, z)\bar{\partial}_\mu G(z) + c.c. \right) = -2D^{(1,1,2,1)}(v) + \frac{1}{\pi} \left( 2F_2(v) + F_5(v) + F_{18}(v) + \frac{2F_{30}(v)}{\pi} + c.c. \right), \quad (3.34)$$

where the graph  $F_{30}(v)$  is given in figure 27.

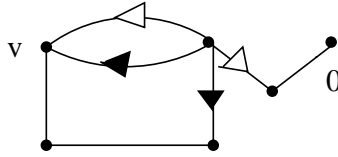

Figure 27:  $F_{30}(v)$

To simplify  $F_{30}(v)$ , we start with the auxiliary graph  $F_{31}(v)$  given in figure 28, to obtain

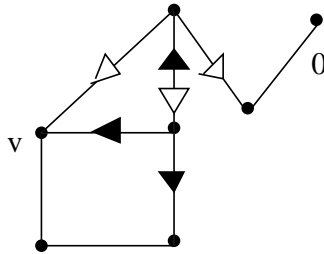

Figure 28: Auxiliary graph  $F_{31}(v)$

$$\begin{aligned} \left( F_{30}(v) + c.c. \right) - \left( P_3(v)P_4^* + c.c. \right) &= 4\pi^2 G_5(v) - 2\pi^2 D^{(1,3,1)}(v) - 2\pi^2 E_2 G_3(v) \\ &+ \pi \left( F_4(v) + F_{24}(v) + F_{32}(v) + c.c. \right), \end{aligned} \quad (3.35)$$

where the graph  $F_{32}(v)$  is given in figure 29.

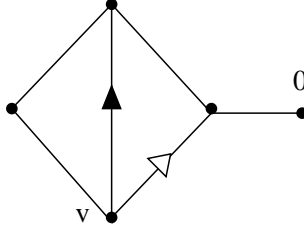

Figure 29:  $F_{32}(v)$

Thus to obtain the final expression for the eigenvalue equation, we add the various contributions, to get that

$$\begin{aligned} \frac{1}{2}(\Delta + 2)D^{(1,1,2,1)}(v) &= \frac{3}{\pi^2} \left( P_1(v)P_2^* + c.c. \right) + \frac{6}{\pi^2} \left( P_3(v)P_4^* + c.c. \right) + \frac{1}{\pi} F_7(v) \\ &+ \frac{1}{\pi} \left( 3F_1(v) + F_2(v) - \frac{F_5(v)}{2} - \frac{F_9(v)}{2} + \frac{F_{10}(v)}{2} + F_{26}(v) + 2F_{33}(v) + 2F_{34}(v) \right. \\ &+ \left. 2F_{35}(v) + c.c. \right) + 10E_5 - 2E_2E_3 + 4G_5(v) - 2E_2G_3(v) - 4D^{(1,2,2)}(v) \\ &- 4D^{(1,3,1)}(v) - 3D^{(2,2,1)}(v) - \frac{3}{2}C_{1,2,2} - \frac{\tau_2}{\pi} G_2(v) \partial_v G_2(v) \bar{\partial}_v G_2(v) \\ &- \frac{2\tau_2}{\pi} G(v) \left( \partial_v G_2(v) \bar{\partial}_v G_3(v) + c.c. \right) - \frac{2\tau_2}{\pi} \left( \partial_v G_2(v) \bar{\partial}_v G_4(v) + c.c. \right) \\ &- \frac{4\tau_2}{\pi} \partial_v G_3(v) \bar{\partial}_v G_3(v), \end{aligned} \quad (3.36)$$

where the graphs  $F_{33}(v)$ ,  $F_{34}(v)$  and  $F_{35}(v)$  are given in figure 30.

In obtaining (3.36), we have performed some simplifications by adding some graphs where the derivatives of the Green functions on the links are arranged appropriately, and we have also used the expression involving  $Q_1$  in appendix B<sup>12</sup>.

### 3.7 Eigenvalue equation for $D_5^{(1,2,2)}(v)$

For  $D_5^{(1,2,2)}(v)$ , we have that

<sup>12</sup>Also note that  $F_{33}(v) + F_{34}(v) = \pi D^{(1,1,2,1)}(v) - \pi E_3 G_2(v)$ .

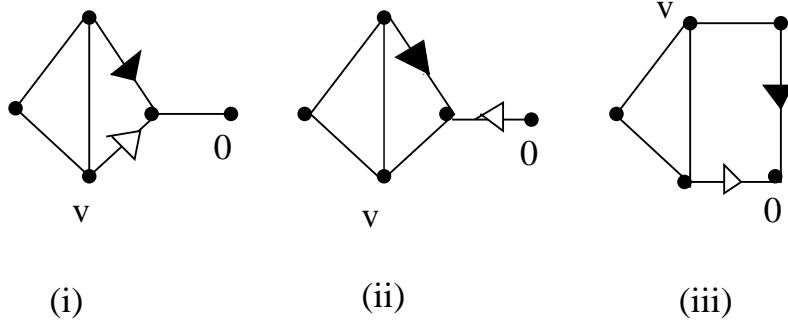

Figure 30: (i)  $F_{33}(v)$ , (ii)  $F_{34}(v)$ , (iii)  $F_{35}(v)$

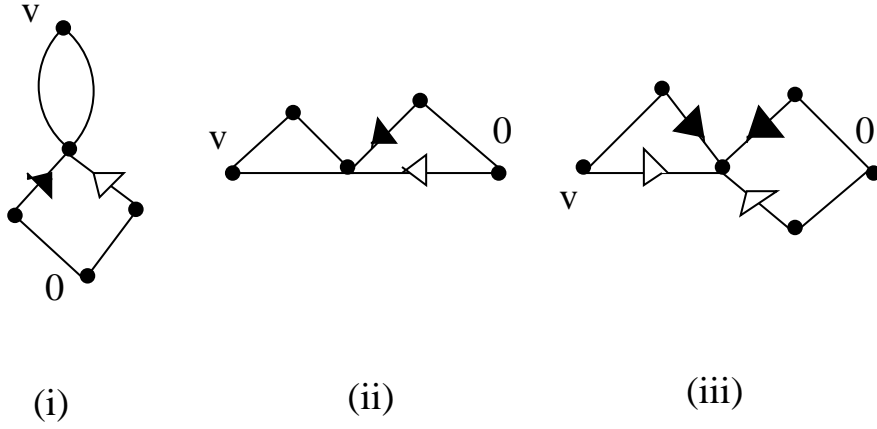

Figure 31: (i)  $F_{36}(v)$ , (ii)  $F_{37}(v)$ , (iii)  $F_{38}(v)$

$$\begin{aligned}
\frac{1}{2}(\Delta - 2)D_5^{(1,2,2)}(v) &= \int_z G_2(v, z)G(v, z)\partial_\mu G(z)\bar{\partial}_\mu G(z) \\
&+ \int_{zw} \left( G(v, z)\partial_\mu G(z, w)\bar{\partial}_\mu G(v, w)G^2(w) + c.c. \right) \\
&+ 2 \int_{zw} \left( G(v, z)G(v, w)\partial_\mu G(z, w)G(w)\bar{\partial}_\mu G(w) + c.c. \right) \\
&+ \int_z \left( G_2(v, z)\partial_\mu G(v, z)G(z)\bar{\partial}_\mu G(z) + c.c. \right). \tag{3.37}
\end{aligned}$$

The first term on the right hand side of (3.37) gives us



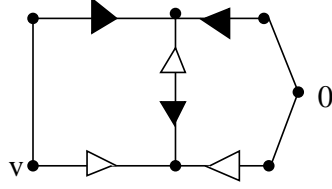

Figure 32: Auxiliary graph  $F_{39}(v)$

$$\int_z G_2(v, z)G(v, z)\partial_\mu G(z)\bar{\partial}_\mu G(z) = -D_5^{(1,2,2)}(v) - \frac{\tau_2}{\pi}E_2\partial_v G_2(v)\bar{\partial}_v G_2(v) + \frac{1}{\pi}\left(F_3(v) - F_{36}(v)\right) + \frac{1}{\pi}\left(F_{37}(v) + \frac{F_{38}(v)}{\pi} + c.c.\right), \quad (3.38)$$

where the graphs  $F_{36}(v)$ ,  $F_{37}(v)$  and  $F_{38}(v)$  are given in figure 31<sup>13</sup>.

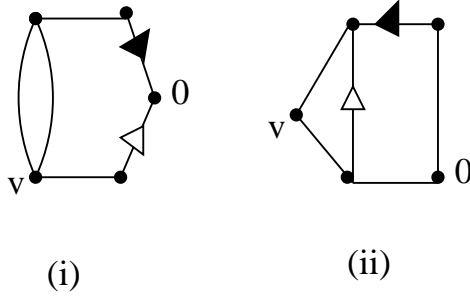

Figure 33: (i)  $F_{40}(v)$ , (ii)  $F_{41}(v)$

To simplify  $F_{38}(v)$ , we start with the auxiliary graph  $F_{39}(v)$  given by figure 32, to get that

$$\left(F_{38}(v) + c.c.\right) - \left(P_1(v)P_3(v)^* + c.c.\right) = -\pi\left(F_1(v) + F_2(v) + F_{17}(v) - F_{40}(v) - F_{41}(v) + c.c.\right), \quad (3.39)$$

where the graphs  $F_{40}(v)$  and  $F_{41}(v)$  are given in figure 33.

The second term on the right hand side of (3.37) gives us

<sup>13</sup> $F_{36}(v)$  has been simplified in appendix D which will be very useful for us later.

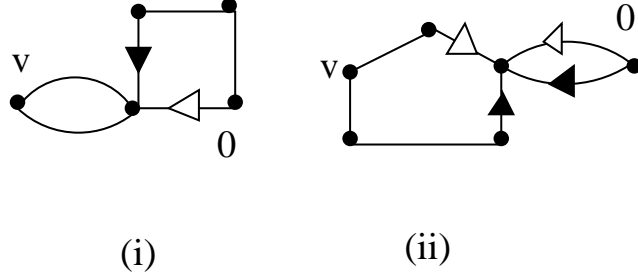

Figure 34: (i)  $F_{42}(v)$ , (ii)  $F_{43}(v)$

$$\begin{aligned}
 \int_{zw} \left( G(v, z) \partial_\mu G(z, w) \bar{\partial}_\mu G(v, w) G^2(w) + c.c. \right) &= -2D_5^{(1,2,2)}(v) + \frac{2}{\pi} F_{36}(v) \\
 + \frac{1}{\pi} \left( 2F_1(v) + F_{42}(v) + \frac{2}{\pi} F_{43}(v) + c.c. \right), & \quad (3.40)
 \end{aligned}$$

where the graphs  $F_{42}(v)$  and  $F_{43}(v)$  are given in figure 34.

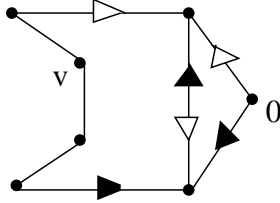

Figure 35: Auxiliary graph  $F_{44}(v)$

To simplify  $F_{43}(v)$ , we start with the auxiliary graph  $F_{44}(v)$  given in figure 35, to get

$$\begin{aligned}
 \left( F_{43}(v) + c.c. \right) - \left( P_1(v) P_3(v)^* + c.c. \right) &= 2\pi^2 E_5 - 2\pi^2 D^{(2,2,1)}(v) \\
 + \pi \left( F_1(v) - F_{24}(v) - \frac{F_{26}(v)}{2} - \frac{F_{40}(v)}{2} + F_{45}(v) + c.c. \right) \\
 - 2\pi\tau_2 \partial_v G_3(v) \bar{\partial}_v G_3(v) - \pi\tau_2 \left( \partial_v G_2(v) \bar{\partial}_v G_4(v) + c.c. \right), & \quad (3.41)
 \end{aligned}$$

where the graph  $F_{45}(v)$  is given in figure 36.

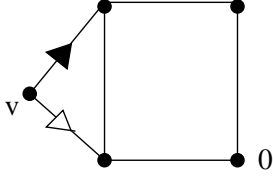

Figure 36:  $F_{45}(v)$

The third term on the right hand side of (3.37) gives us

$$\int_{zw} \left( G(v, z)G(v, w)\partial_\mu G(z, w)G(w)\bar{\partial}_\mu G(w) + c.c. \right) = -D_5^{(1,2,2)}(v) + 2D^{(1,1,3)}(v) + \frac{1}{\pi} \left( F_2(v) - F_4(v) - \frac{F_{42}(v)}{2} + \frac{F_{47}(v)}{\pi} + \frac{F_{48}(v)}{\pi} + c.c. \right) + \frac{2F_{46}(v)}{\pi}, \quad (3.42)$$

where the graphs  $F_{46}(v)$ ,  $F_{47}(v)$  and  $F_{48}(v)$  are given in figure 37.

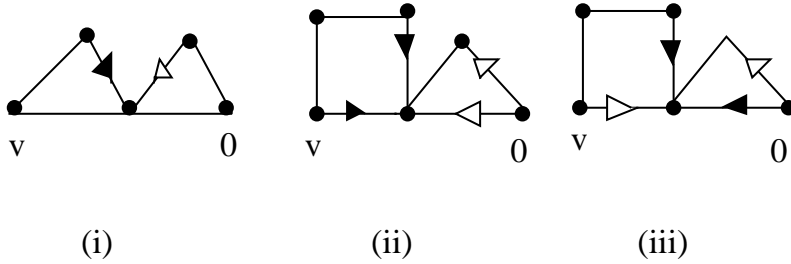

Figure 37: (i)  $F_{46}(v)$ , (ii)  $F_{47}(v)$ , (iii)  $F_{48}(v)$

In order to simplify  $F_{47}(v)$  and  $F_{48}(v)$ , we start with the auxiliary graphs  $F_{49}(v)$  and  $F_{50}(v)$  respectively, as given in figure 38.

For  $F_{47}(v)$ , this leads to

$$\left( F_{47}(v) + c.c. \right) - \left( P_2 P_4^* + c.c. \right) = 4\pi^2 E_5 - 2\pi^2 E_2 G_3(v) - \pi^2 D^{(1,1,3)}(v) + \pi \left( F_4(v) + \frac{F_{51}(v)}{2} + c.c. \right), \quad (3.43)$$

where the graph  $F_{51}(v)$  is given in figure 39.

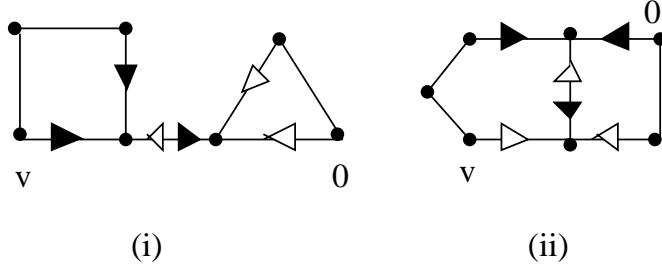

Figure 38: Auxiliary graphs (i)  $F_{49}(v)$ , (ii)  $F_{50}(v)$

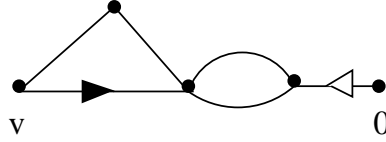

Figure 39:  $F_{51}(v)$

For  $F_{48}(v)$ , we get that

$$\begin{aligned}
 & \left( F_{48}(v) + c.c. \right) - \left( P_1(v)P_3(v)^* + c.c. \right) = 2\pi^2 G_5(v) - 2\pi^2 D^{(1,2,2)}(v) \\
 & - 2\pi^2 D^{(1,3,1)}(v) + \pi \left( F_2(v) + F_{24}(v) + F_{26}(v) + F_{35}(v) + F_{52}(v) + c.c. \right) \\
 & - \tau_2 G(v) \left( \partial_v G_2(v) \bar{\partial}_v G_3(v) + c.c. \right), \tag{3.44}
 \end{aligned}$$

where the graph  $F_{52}(v)$  is given in figure 40.

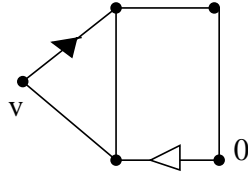

Figure 40:  $F_{52}(v)$

Lastly, the fourth term on the right hand side of (3.37) gives us

$$\int_z \left( G_2(v, z) \partial_\mu G(v, z) G(z) \bar{\partial}_\mu G(z) + c.c. \right) = \pi^2 D^{(2,2,1)}(v) + \pi^2 D_5^{(1,2,2)}(v)$$

$$-\pi\left(\frac{F_{36}(v)}{2} + F_{37}(v) - \frac{F_{38}(v)}{\pi} - \frac{F_{53}(v)}{\pi} + c.c.\right) - 4\pi F_{46}(v), \quad (3.45)$$

where the graph  $F_{53}(v)$  is given in figure 41.

To simplify  $F_{53}(v)$ , we introduce the auxiliary graph  $F_{54}(v)$  in figure 42, which leads to

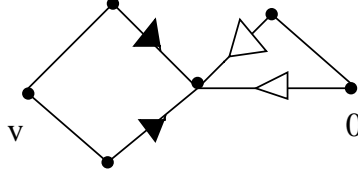

Figure 41:  $F_{53}(v)$

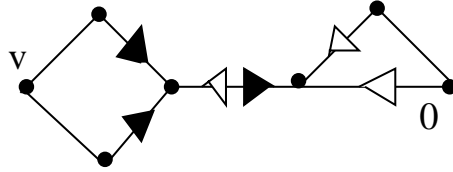

Figure 42: Auxiliary graph  $F_{54}(v)$

$$\begin{aligned} \left(F_{53}(v) + c.c.\right) - \left(P_2 P_4^* + c.c.\right) &= 2\pi^2 D_5^{(1,2,2)}(v) - 4\pi^2 D^{(1,1,3)}(v) \\ &\quad - 2\pi^2 E_2 E_3 + \pi \left(2F_4(v) - F_{51}(v) + c.c.\right). \end{aligned} \quad (3.46)$$

Thus adding the various contributions, we get that

$$\begin{aligned} \frac{1}{2}(\Delta - 6) D_5^{(1,2,2)}(v) &= \frac{6}{\pi^2} \left(P_1(v) P_3(v)^* + c.c.\right) + \frac{3}{\pi^2} \left(P_2 P_4^* + c.c.\right) \\ &\quad - \frac{2\tau_2}{\pi} \left(\partial_v G_2(v) \bar{\partial}_v G_4(v) + c.c.\right) - \frac{2\tau_2}{\pi} G(v) \left(\partial_v G_2(v) \bar{\partial}_v G_3(v) + c.c.\right) \\ &\quad - \frac{4\tau_2}{\pi} \partial_v G_3(v) \bar{\partial}_v G_3(v) - \frac{\tau_2}{\pi} E_2 \partial_v G_2(v) \bar{\partial}_v G_2(v) + \frac{1}{\pi} \left(2F_1(v) + 2F_2(v) \right. \\ &\quad \left. + 2F_4(v) + 2F_{25}(v) + F_{26}(v) + F_{40}(v) + c.c.\right) - 4G_2(v) G_3(v) \\ &\quad - 4E_2 G_3(v) + 12G_5(v) + 4E_5 - 2E_2 E_3 - \frac{7}{2} D^{(2,2,1)}(v) - 4D^{(1,3,1)}(v) \\ &\quad - 3D^{(1,2,2)}(v) - 2D^{(1,1,3)}(v). \end{aligned} \quad (3.47)$$

We next consider the graphs  $D_5^{(2;2;1)}(v)$ ,  $D_5^{(1,2,1;1)}(v)$  and  $D_5^{(1;2,2)}(v)$  that we obtain from cutting open  $D_{1,2,2}$ . We do not consider the graph on the left hand side of figure 43 because of the equality it satisfies.

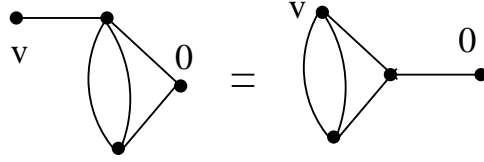

Figure 43: An identity among graphs

### 3.8 Eigenvalue equation for $D_5^{(2;2;1)}(v)$

For  $D_5^{(2;2;1)}(v)$ , we get that<sup>14</sup>

$$\begin{aligned} \frac{1}{4}\Delta D_5^{(2;2;1)}(v) &= \int_{zw} \partial_\mu G(v, z) \bar{\partial}_\mu G(v, z) G(z, w)^2 G(w) \\ &+ 2 \int_{zw} G(v, z) \partial_\mu G(v, z) G(z, w) \bar{\partial}_\mu G(z, w) G(w) \\ &+ \int_{zw} \left( G(v, z)^2 G(z, w) \partial_\mu G(z, w) \bar{\partial}_\mu G(w) + c.c. \right). \end{aligned} \quad (3.48)$$

In obtaining (3.48), we have used the equalities given in figure 44.

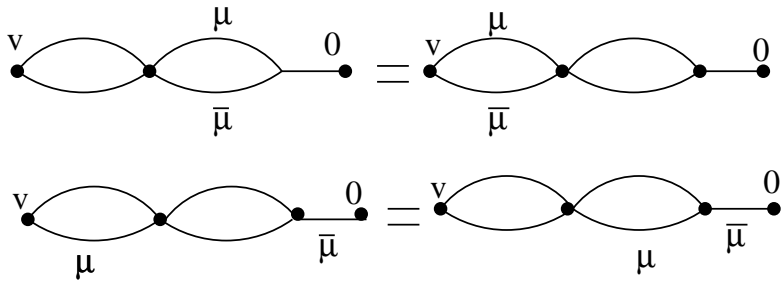

Figure 44: Identities among graphs

In these figures,  $\mu$  ( $\bar{\mu}$ ) along a link of the graph actually stands for  $\partial_\mu G$  ( $\bar{\partial}_\mu G$ ) along that link.

<sup>14</sup>The second term on the right hand side of (3.48) is real.

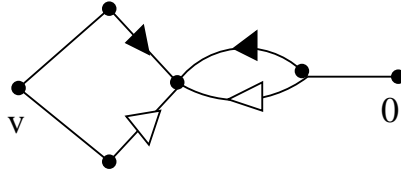

Figure 45:  $F_{55}(v)$

We now consider the first term on the right hand side of (3.48), which gives us

$$\int_{zw} \partial_\mu G(v, z) \bar{\partial}_\mu G(v, z) G(z, w)^2 G(w) = D_5^{(2;2;1)}(v) - 2D_5^{(1;2;2)}(v) + 2E_2 E_3 + \frac{2}{\pi} F_3(v) + \frac{1}{\pi} \left( F_{51}(v) + \frac{2F_{55}(v)}{\pi} + c.c. \right), \quad (3.49)$$

where the graph  $F_{55}(v)$  is given in figure 45.

To simplify  $F_{55}(v)$ , we start with the auxiliary graph  $F_{56}(v)$  given in figure 46, to get

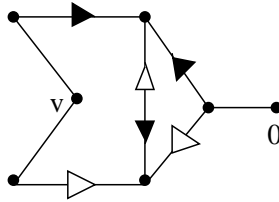

Figure 46: Auxiliary graph  $F_{56}(v)$

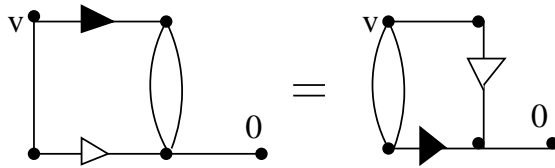

Figure 47: An identity among graphs

$$F_{55}(v) = -\pi^2 D^{(2;2,1)}(v) + \pi^2 E_5 - \pi \tau_2 \partial_v G_3(v) \bar{\partial}_v G_3(v) + \pi F_{57}(v) - \pi \left( F_2(v) + \frac{F_9(v)}{2} + c.c. \right), \quad (3.50)$$

where we have used the identity given in figure 47<sup>15</sup>, and the graph  $F_{57}(v)$  is given in figure 48.

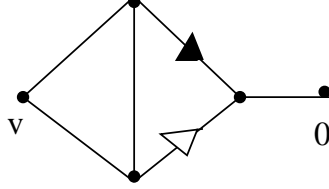

Figure 48:  $F_{57}(v)$

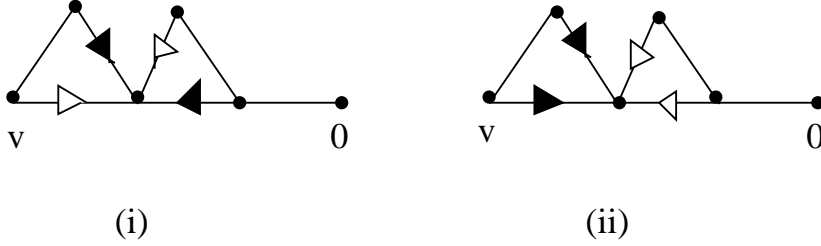

Figure 49: (i)  $F_{58}(v)$ , (ii)  $F_{59}(v)$

The second term on the right hand side of (3.48) gives us

$$\int_{zw} G(v, z) \partial_\mu G(v, z) G(z, w) \bar{\partial}_\mu G(z, w) G(w) = 2D^{(1,1,3)}(v) - D_5^{(2;2;1)}(v) + D_5^{(1,2,2)}(v) - E_2 E_3 - \frac{1}{\pi} \left( F_4(v) + \frac{F_{51}(v)}{2} + c.c. \right) + \frac{1}{\pi^2} \left( F_{58}(v) + F_{59}(v) \right), \quad (3.51)$$

where the graphs  $F_{58}(v)$  and  $F_{59}(v)$  are given in figure 49. Note that both of them are real.

To simplify  $F_{58}(v)$ , we consider the auxiliary graph  $F_{60}(v)$  in figure 50, which leads to

$$F_{58}(v) = \pi^2 G_5(v) + \pi^2 E_5 - 2\pi^2 D^{(1,2,2)}(v) - \pi^2 D^{(2,2,1)}(v) - \pi F_7(v) + \pi \left( F_1(v) + F_2(v) + F_9(v) + c.c. \right) + \pi F_{61}(v) - \pi \tau_2 \partial_v G_3(v) \bar{\partial}_v G_3(v), \quad (3.52)$$

where the graph  $F_{61}(v)$  is given in figure 51.

Also to simplify  $F_{59}(v)$ , we consider the auxiliary graph  $F_{62}(v)$  in figure 52, which leads to

---

<sup>15</sup>Similar elementary identities have been used elsewhere in the calculation as well.



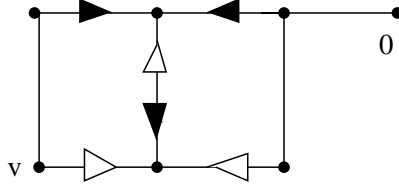

Figure 50: Auxiliary graph  $F_{60}(v)$

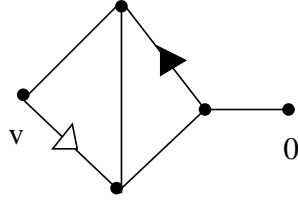

Figure 51:  $F_{61}(v)$

$$F_{59}(v) = \pi^2 G_5(v) + \frac{\pi^2}{4} D_5^{(2;2;1)}(v) - \pi^2 D^{(1,1,3)}(v). \quad (3.53)$$

Finally, the third term on the right hand side of (3.48) gives

$$\begin{aligned} \int_{zw} \left( G(v, z)^2 G(z, w) \partial_\mu G(z, w) \bar{\partial}_\mu G(w) + c.c. \right) &= -D_5^{(2;2;1)}(v) + 2D^{(1,1,3)}(v) \\ + 2D_5^{(1,2,2)}(v) - 2E_2 E_3 - \frac{1}{\pi} \left( F_{51}(v) + c.c. \right). \end{aligned} \quad (3.54)$$

Thus adding the various contributions, we get that

$$\begin{aligned} \frac{1}{4} \left( \Delta - 2 \right) D_5^{(2;2;1)}(v) &= 4G_5(v) + 4D^{(1,1,3)}(v) - 4D^{(1,2,2)}(v) - 4D^{(2,2,1)}(v) \\ + 4E_5 + \frac{2F_3(v)}{\pi} - \frac{2F_7(v)}{\pi} - \frac{4\tau_2}{\pi} \partial_v G_3(v) \bar{\partial}_v G_3(v) &+ \frac{1}{\pi} \left( 2F_1(v) - 2F_4(v) \right. \\ \left. + F_9(v) + F_{63}(v) - F_{64}(v) + c.c. \right), \end{aligned} \quad (3.55)$$

where the graphs  $F_{63}(v)$  and  $F_{64}(v)$  are given in figure 53<sup>16</sup>.

<sup>16</sup>Note that  $F_{64}(v) = -F_{51}(v)^* + \pi E_2 D_3^{(1)}(v) - \pi D^{(1,1,3)}(v)$ .

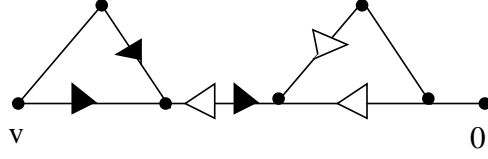

Figure 52: Auxiliary graph  $F_{62}(v)$

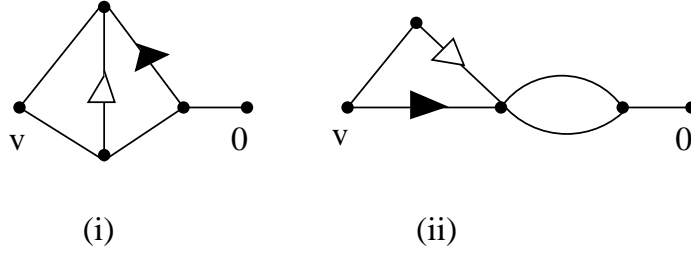

Figure 53: (i)  $F_{63}(v)$ , (ii)  $F_{64}(v)$

### 3.9 Eigenvalue equation for $D_5^{(1,2,1;1)}(v)$

For  $D_5^{(1,2,1;1)}(v)$ , we get

$$\begin{aligned}
\Delta D_5^{(1,2,1;1)}(v) &= 2 \int_{zw} \partial_\mu G(v, z) \bar{\partial}_\mu G(v, z) G(v, w) G(z, w) G(w) \\
&+ 2 \int_{zw} \left( G(v, z) \partial_\mu G(v, z) G(z, w) \bar{\partial}_\mu G(v, w) G(w) + c.c. \right) \\
&+ \int_{zw} \left( G(v, z)^2 \partial_\mu G(v, w) \bar{\partial}_\mu G(z, w) G(w) + c.c. \right) \\
&+ 2 \int_{zw} \left( G(v, z) \partial_\mu G(v, z) G(v, w) \bar{\partial}_\mu G(z, w) G(w) + c.c. \right) \\
&+ 2 \int_{zw} \left( G(v, z) \partial_\mu G(v, z) G(z, w) G(v, w) \bar{\partial}_\mu G(w) + c.c. \right) \\
&+ \int_{zw} \left( G(v, z)^2 G(z, w) \partial_\mu G(v, w) \bar{\partial}_\mu G(w) + c.c. \right) \\
&+ \int_{zw} \left( G(v, z)^2 G(v, w) \partial_\mu G(z, w) \bar{\partial}_\mu G(w) + c.c. \right). \tag{3.56}
\end{aligned}$$

We now write down the contributions from the seven terms on the right hand side of (3.56).

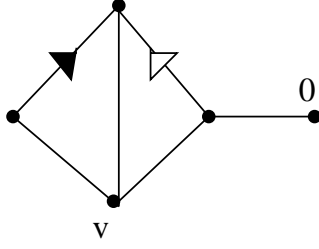

Figure 54:  $F_{65}(v)$

The first term gives

$$\int_{zw} \partial_\mu G(v, z) \bar{\partial}_\mu G(v, z) G(v, w) G(z, w) G(w) = D_5^{(1,2,1;1)}(v) + E_3 G_2(v) - \frac{F_7(v)}{\pi} - \frac{1}{\pi} (F_{65}(v) + c.c.), \quad (3.57)$$

where the graph  $F_{65}(v)$  is given in figure 54<sup>17</sup>.

In calculating the second term, we encounter the graph  $F_{66}(v)$  which we simplify using the auxiliary graph  $F_{67}(v)$ , both of which are given in figure 55. This gives

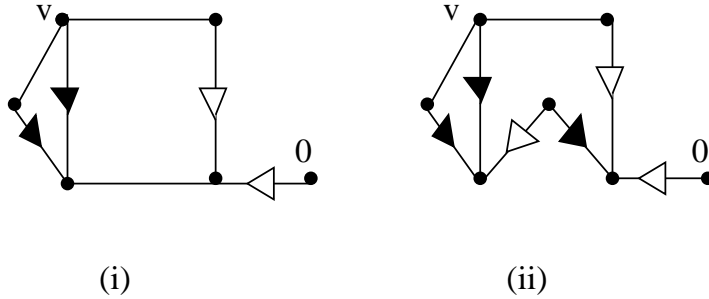

Figure 55: (i)  $F_{66}(v)$  and (ii) auxiliary graph  $F_{67}(v)$

$$\begin{aligned} \int_{zw} \left( G(v, z) \partial_\mu G(v, z) G(z, w) \bar{\partial}_\mu G(v, w) G(w) + c.c. \right) &= 2E_5 - C_{1,1,3} + \frac{2F_7(v)}{\pi} \\ + \frac{1}{\pi} \left( Q_1 + F_1(v) - \frac{F_9(v)}{2} - F_{16}(v) - F_{17}(v) - F_{24}(v) + \frac{F_{40}(v)}{2} + \frac{F_{68}(v)}{2} + c.c. \right) \\ - \frac{T_2}{\pi} \left( \partial_v G_2(v) \bar{\partial}_v G_4(v) + c.c. \right), \end{aligned} \quad (3.58)$$

where the graph  $F_{68}(v)$  is given in figure 56.

<sup>17</sup>Note that  $F_{65}(v) = F_{16}(v)^* + F_{29}(v)$ .

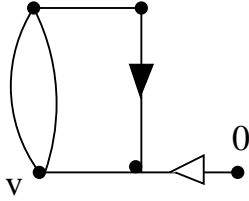

Figure 56:  $F_{68}(v)$

The third term gives

$$\begin{aligned} & \int_{zw} \left( G(v, z)^2 \partial_\mu G(v, w) \bar{\partial}_\mu G(z, w) G(w) + c.c. \right) \\ &= 2C_{1,1,3} + \frac{1}{\pi} \left( F_9(v) - F_{40}(v) - F_{68}(v) + c.c. \right), \end{aligned} \quad (3.59)$$

while the fourth term gives us

$$\begin{aligned} & \int_{zw} \left( G(v, z) \partial_\mu G(v, z) G(v, w) \bar{\partial}_\mu G(z, w) G(w) + c.c. \right) \\ &= 2D^{(1,3,1)}(v) - D_5^{(1,2,1;1)}(v) + \frac{1}{\pi} \left( F_{65}(v) + c.c. \right). \end{aligned} \quad (3.60)$$

To calculate the fifth term, we encounter the graph  $F_{69}(v)$  which we simplify using the auxiliary graph  $F_{70}(v)$ , both of which are given in figure 57.

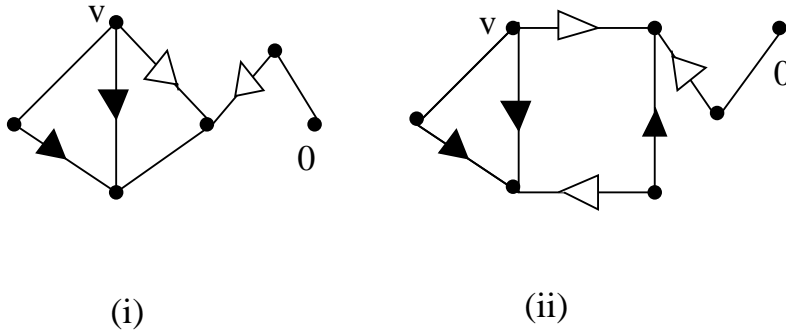

Figure 57: (i)  $F_{69}(v)$  and (ii) auxiliary graph  $F_{70}(v)$

This leads to

$$\begin{aligned}
& \int_{zw} \left( G(v, z) \partial_\mu G(v, z) G(z, w) G(v, w) \bar{\partial}_\mu G(w) + c.c. \right) = D^{(1,1,3)}(v) + 2G_5(v) \\
& - 2D^{(1,3,1)}(v) + D_5^{(1,2,1;1)}(v) + \frac{1}{\pi} \left( F_2(v) - F_4(v) + F_5(v) - \frac{F_{10}(v)}{2} + F_{24}(v) \right. \\
& \left. - F_{29}(v) - \frac{F_{68}(v)}{2} + c.c. \right). \tag{3.61}
\end{aligned}$$

Next, the sixth term yields

$$\begin{aligned}
& \int_{zw} \left( G(v, z)^2 G(z, w) \partial_\mu G(v, w) \bar{\partial}_\mu G(w) + c.c. \right) = 2D_5^{(1,2,1;1)}(v) + 2E_2 G_3(v) \\
& - \frac{1}{\pi} \left( F_5(v) + F_9(v) + F_{10}(v) + c.c. \right). \tag{3.62}
\end{aligned}$$

Finally, the seventh term gives us

$$\begin{aligned}
& \int_{zw} \left( G(v, z)^2 G(v, w) \partial_\mu G(z, w) \bar{\partial}_\mu G(w) + c.c. \right) = 2D^{(1,1,3)}(v) - 2D_5^{(1,2,1;1)}(v) \\
& + \frac{1}{\pi} \left( F_{10}(v) + F_{68}(v) + c.c. \right). \tag{3.63}
\end{aligned}$$

Thus adding the several contributions, we get that

$$\begin{aligned}
& (\Delta - 2) D_5^{(1,2,1;1)}(v) = 4D^{(1,1,3)}(v) + 4E_5 + 4G_5(v) + 2E_3 G_2(v) + 2E_2 G_3(v) \\
& + \frac{1}{\pi} \left( 2Q_1 + 2F_1(v) + 2F_2(v) - 2F_4(v) + F_5(v) - F_9(v) - F_{10}(v) - 2F_{17}(v) \right. \\
& \left. - 2F_{65}(v) + c.c. \right) + \frac{2F_7(v)}{\pi} - \frac{2\tau_2}{\pi} \left( \partial_v G_2(v) \bar{\partial}_v G_4(v) + c.c. \right). \tag{3.64}
\end{aligned}$$

### 3.10 Eigenvalue equation for $D_5^{(1;2;2)}(v)$

For  $D_5^{(1;2;2)}(v)$ , we have that

$$\begin{aligned}
\frac{1}{4} \Delta D_5^{(1;2;2)}(v) &= \int_{zw} \partial_\mu G(v, z) \bar{\partial}_\mu G(v, w) G(z, w) G(z) G(w) \\
&+ \int_{zw} G(v, w) \partial_\mu G(v, z) G(z, w) G(w) \bar{\partial}_\mu G(z) \\
&+ \int_{zw} G(v, w) \partial_\mu G(v, z) G(z, w) G(z) \bar{\partial}_\mu G(w) \\
&+ \int_{zw} \left( G(v, w) \partial_\mu G(v, z) \bar{\partial}_\mu G(z, w) G(w) G(z) + c.c. \right). \tag{3.65}
\end{aligned}$$

We now consider the contributions from the four terms on the right hand side of (3.65).

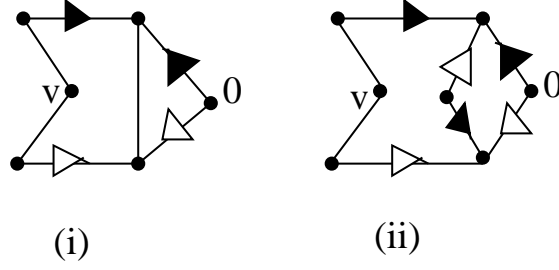

Figure 58: (i)  $F_{71}(v)$  and (ii) auxiliary graph  $F_{72}(v)$

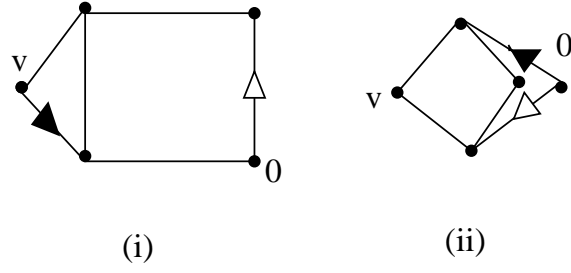

Figure 59: (i)  $F_{73}(v)$ , (ii)  $F_{74}(v)$

To calculate the first term, we encounter the graph  $F_{71}(v)$  which we simplify using the auxiliary graph  $F_{72}(v)$ , both of which are given in figure 58, to get

$$\begin{aligned}
\int_{zw} \partial_\mu G(v, z) \bar{\partial}_\mu G(v, w) G(z, w) G(z) G(w) &= E_5 + \frac{F_{36}(v)}{\pi} + \frac{F_{74}(v)}{\pi} \\
&+ \frac{1}{\pi} \left( F_1(v) - F_{24}(v) - F_{25}(v) - F_{40}(v) - F_{73}(v) + c.c. \right) \\
&+ \frac{\tau_2}{\pi} E_2 \partial_v G_2(v) \bar{\partial}_v G_2(v) - \frac{\tau_2}{\pi} \partial_v G_3(v) \bar{\partial}_v G_3(v) - \frac{\tau_2}{\pi} \left( \partial_v G_2(v) \bar{\partial}_v G_4(v) + c.c. \right), \quad (3.66)
\end{aligned}$$

where the graphs  $F_{73}(v)$  and  $F_{74}(v)$  are given in figure 59.

The second term gives

$$\begin{aligned}
\int_{zw} G(v, w) \partial_\mu G(v, z) G(z, w) G(w) \bar{\partial}_\mu G(z) &= G_2(v) G_3(v) - D_5^{(1;2;2)}(v) \\
&- \frac{F_{46}(v)}{\pi} + \frac{1}{\pi} \left( F_{75}(v) + c.c. \right), \quad (3.67)
\end{aligned}$$

where the graph  $F_{75}(v)$  is given in figure 60.

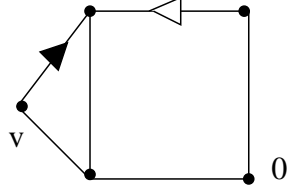

Figure 60:  $F_{75}(v)$

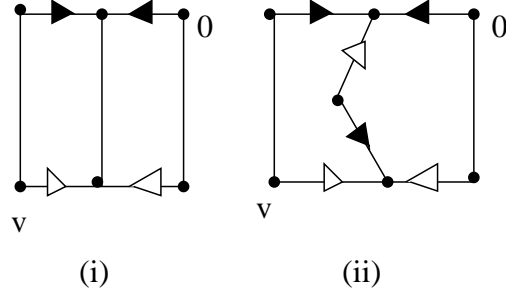

Figure 61: (i)  $F_{76}(v)$  and (ii) auxiliary graph  $F_{77}(v)$

To evaluate the third term, we encounter the graph  $F_{76}(v)$  which we simplify using the auxiliary graph  $F_{77}(v)$ , both of which are given in figure 61, to get

$$\begin{aligned}
& \int_{zw} G(v, w) \partial_\mu G(v, z) G(z, w) G(z) \bar{\partial}_\mu G(w) = G_5(v) - 2D^{(1,3,1)}(v) + \frac{F_{46}(v)}{\pi} \\
& + \frac{F_{78}(v)}{\pi} + \frac{1}{\pi} \left( F_2(v) + F_{17}(v) + F_{24}(v) + F_{35}(v) - F_{41}(v) + F_{73}(v) + c.c. \right) \\
& + \frac{\tau_2}{\pi} \partial_v G_3(v) \bar{\partial}_v G_3(v) - \frac{\tau_2}{\pi} G_2(v) \partial_v G_2(v) \bar{\partial}_v G_2(v), \tag{3.68}
\end{aligned}$$

where the graph  $F_{78}(v)$  is given in figure 62.

Finally, the fourth term yields

$$\begin{aligned}
& \int_{zw} \left( G(v, w) \partial_\mu G(v, z) \bar{\partial}_\mu G(z, w) G(w) G(z) + c.c. \right) = 2D^{(1,3,1)}(v) \\
& + \frac{1}{\pi} \left( F_{25}(v) - F_{35}(v) + F_{41}(v) + c.c. \right) - \frac{2F_{79}(v)}{\pi}, \tag{3.69}
\end{aligned}$$

where the graph  $F_{79}(v)$  is given in figure 63.

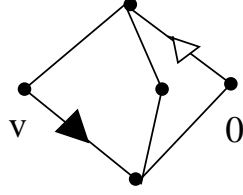

Figure 62:  $F_{78}(v)$

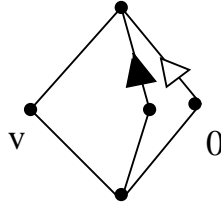

Figure 63:  $F_{79}(v)$

Thus adding the various contributions, we get that

$$\begin{aligned}
\frac{1}{4}(\Delta - 2)D_5^{(1;2;2)}(v) &= E_5 + G_5(v) + G_2(v)G_3(v) + \frac{\tau_2}{\pi}E_2\partial_v G_2(v)\bar{\partial}_v G_2(v) \\
&- \frac{\tau_2}{\pi}G_2(v)\partial_v G_2(v)\bar{\partial}_v G_2(v) + \frac{F_{36}(v)}{\pi} + \frac{1}{\pi}(F_1(v) + F_2(v) + F_{17}(v) - F_{40}(v) \\
&- F_{41}(v) + c.c.) - \frac{\tau_2}{\pi}(\partial_v G_2(v)\bar{\partial}_v G_4(v) + c.c.). \tag{3.70}
\end{aligned}$$

We now consider the eigenvalue equations for  $D_5^{(1)}(v)$  and  $D_5^{(2)}(v)$  which are obtained by cutting open  $D_5$ .

### 3.11 Eigenvalue equation for $D_5^{(1)}(v)$

For  $D_5^{(1)}(v)$ , we have that

$$\begin{aligned}
\frac{1}{4}\Delta D_5^{(1)}(v) &= 3 \int_z G(v, z)^2 \partial_\mu G(v, z) \bar{\partial}_\mu G(v, z) G(z) \\
&+ \int_z (G(v, z)^3 \partial_\mu G(v, z) \bar{\partial}_\mu G(z) + c.c.). \tag{3.71}
\end{aligned}$$



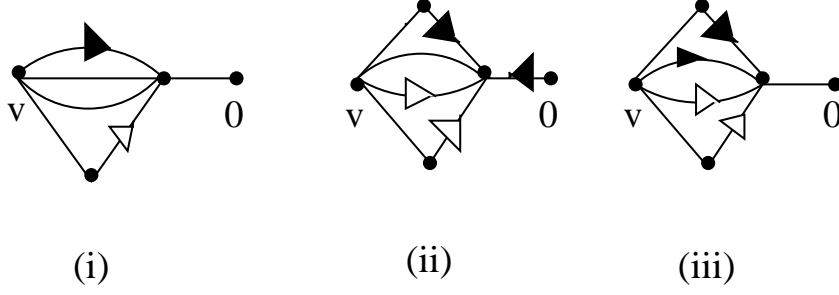

Figure 64: (i)  $F_{80}(v)$ , (ii)  $F_{81}(v)$ , (iii)  $F_{82}(v)$

The first term on the right hand side gives

$$\int_z G(v, z)^2 \partial_\mu G(v, z) \bar{\partial}_\mu G(v, z) G(z) = -D_5^{(1)}(v) + \frac{Q_3}{\pi} - \frac{\tau_2}{\pi} G(v)^2 \partial_v G_2(v) \bar{\partial}_v G_2(v) + \frac{2F_7(v)}{\pi} + \frac{1}{\pi} \left( F_{80}(v) + \frac{2}{\pi} F_{81}(v) + c.c. \right) + \frac{2}{\pi^2} F_{82}(v), \quad (3.72)$$

where  $Q_3$  is given in appendix B, and the graphs  $F_{80}(v)$ ,  $F_{81}(v)$  and  $F_{82}(v)$  are given in figure 64.

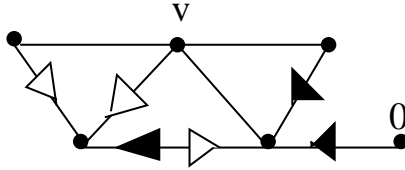

Figure 65: Auxiliary graph  $F_{83}(v)$

Now to simplify  $F_{81}(v)$ , we start with the auxiliary graph  $F_{83}(v)$  in figure 65, leading to

$$\left( F_{81}(v) + c.c. \right) - \left( P_2 P_5(v)^* + c.c. \right) = -\pi \tau_2 G(v) \left( \partial_v G_2(v) \bar{\partial}_v G_3(v) + c.c. \right) + \pi \left( Q_1 - \frac{Q_2}{2} - F_{18}(v) + \frac{F_{84}(v)}{2} + \frac{F_{85}(v)}{2} + c.c. \right) + \left( F_{19}(v) - \frac{F_{86}(v)}{2} + c.c. \right), \quad (3.73)$$

where  $P_5(v)$  is given in appendix B, and the graphs  $F_{84}(v)$ ,  $F_{85}(v)$  and  $F_{86}(v)$  are given in figure 66.

To simplify  $F_{86}(v)$ , we start with the auxiliary graph  $F_{87}(v)$  in figure 67, leading to

$$\left( F_{86}(v) + c.c. \right) - \left( P_3(v) P_6^* + c.c. \right) = -\pi \left( F_{40}(v) + F_{68}(v) - \frac{F_{88}(v)}{3} - \frac{F_{89}(v)}{3} + E_2 F_{90}(v) + c.c. \right) + 2\pi^2 C_{1,1,3} - \frac{2\pi^2}{3} D_{1,1,3} + 2\pi^2 E_2 E_3 - 2\pi \tau_2 E_2 \partial_v G_2(v) \bar{\partial}_v G_2(v), \quad (3.74)$$

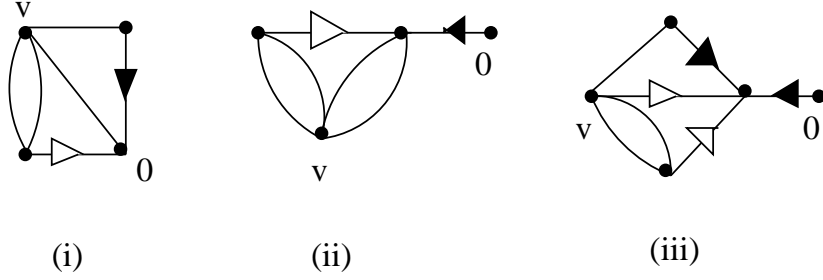

Figure 66: (i)  $F_{84}(v)$ , (ii)  $F_{85}(v)$ , (iii)  $F_{86}(v)$

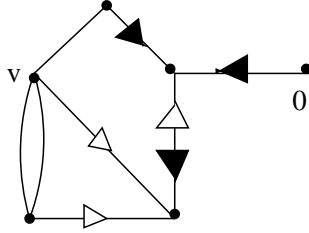

Figure 67: Auxiliary graph  $F_{87}(v)$

where  $P_6$  is given in appendix B, and the graphs  $F_{88}(v)$ ,  $F_{89}(v)$  and  $F_{90}(v)$  are given in figure 68.

Next to simplify  $F_{82}(v)$ , we start with the auxiliary graph  $F_{91}(v)$  given in figure 69, which leads to

$$\begin{aligned}
 F_{82}(v) - \frac{1}{2} \left( P_2 P_7(v)^* + c.c. \right) &= \frac{\pi^2}{4} D_5^{(1)}(v) - \frac{\pi^2}{4} E_2 D_3^{(1)}(v) - \frac{\pi^2}{2} D^{(1,1,2,1)}(v) \\
 + \frac{\pi}{2} \left( F_1(v) - \frac{F_9(v)}{2} + \frac{F_{18}(v)}{2} - \frac{F_{85}(v)}{4} + c.c. \right) &+ \frac{1}{2} \left( F_{20}(v) - \frac{F_{92}(v)}{2} + c.c. \right), \quad (3.75)
 \end{aligned}$$

where  $P_7(v)$  is given in appendix B, and the graph  $F_{92}(v)$  is given in figure 70.

To simplify  $F_{92}(v)$ , we start with the auxiliary graph  $F_{93}(v)$  in figure 71, leading to

$$\begin{aligned}
 \left( F_{92}(v) + c.c. \right) - \left( P_2 P_8(v)^* + c.c. \right) &= 2\pi^2 C_{1,1,3} - \pi^2 D_{1,2,2} + 2\pi^2 E_2 G_3(v) \\
 - \pi^2 E_2 D_3^{(1)}(v) - \pi \left( F_{18}(v) + F_{26}(v) - \frac{F_{85}(v)}{2} + c.c. \right) &+ \pi F_{94}(v), \quad (3.76)
 \end{aligned}$$

where  $P_8(v)$  is given in appendix B, and the graph  $F_{94}(v)$  is given in figure 72.

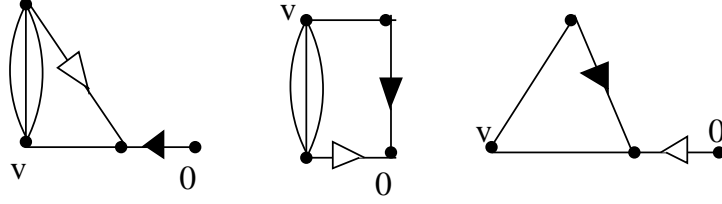

Figure 68: (i)  $F_{88}(v)$ , (ii)  $F_{89}(v)$ , (iii)  $F_{90}(v)$

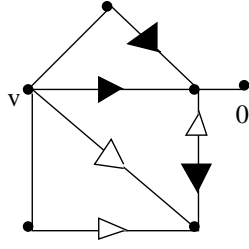

Figure 69:  $F_{91}(v)$

Next the second term on the right hand side of (3.71) gives us

$$\begin{aligned} \int_z \left( G(v, z)^3 \partial_\mu G(v, z) \bar{\partial}_\mu G(z) + c.c. \right) &= \frac{1}{2} D_5^{(1)}(v) \\ + \frac{3}{\pi} \left( F_5(v) - F_{80}(v) + \frac{2}{\pi} F_{95}(v) + c.c. \right), \end{aligned} \quad (3.77)$$

where the graph  $F_{95}(v)$  is given in figure 73.

To simplify  $F_{95}(v)$ , we use the auxiliary graph  $F_{96}(v)$  in figure 74 to get

$$\begin{aligned} \left( F_{95}(v) + c.c. \right) - \frac{1}{2} \left( P_2 P_8(v)^* + c.c. \right) &= \frac{\pi^2}{2} D_5^{(1)}(v) - \frac{\pi^2}{2} E_2 D_3^{(1)}(v) - \pi^2 D^{(1,1,2,1)}(v) \\ + \pi \left( F_2(v) - \frac{F_{10}(v)}{2} + \frac{F_{18}(v)}{2} + \frac{F_{30}(v)}{\pi} - \frac{F_{85}(v)}{4} - \frac{F_{97}(v)}{2\pi} + c.c. \right), \end{aligned} \quad (3.78)$$

where the graph  $F_{97}(v)$  is given in figure 75. To simplify it, we start with the auxiliary graph  $F_{98}(v)$  in figure 76 to get

$$\begin{aligned} \left( F_{97}(v) + c.c. \right) - \left( P_3(v) P_6^* + c.c. \right) &= \frac{2\pi^2}{3} D_5^{(1)}(v) - \frac{2\pi^2}{3} D^{(1,1,1,2)} + 2\pi^2 D^{(1,1,3)}(v) \\ - 2\pi^2 D_5^{(1,2,1;1)}(v) - \frac{2\pi^2}{3} D_3 G_2(v) - 2\pi^2 E_2 D_3^{(1)}(v) + 2\pi^2 E_2 G_3(v) \\ + \pi \left( F_{68}(v) - \frac{F_{88}(v)}{3} + E_2 F_{90}(v) + c.c. \right). \end{aligned} \quad (3.79)$$

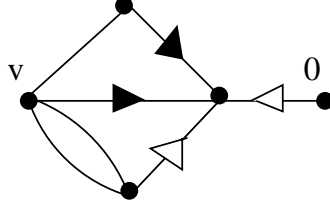

Figure 70:  $F_{92}(v)$

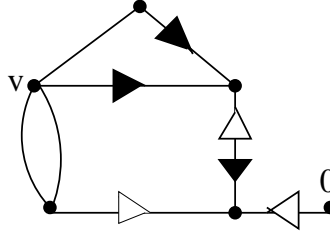

Figure 71: Auxiliary graph  $F_{93}(v)$

Thus adding the various contributions, we get that

$$\begin{aligned}
\frac{1}{4}\Delta D_5^{(1)}(v) &= \frac{1}{\pi^2} \left( 3P_1(v)P_2^* + 6P_2P_5(v)^* + 3P_2P_7(v)^* + \frac{3}{2}P_2P_8(v)^* \right. \\
&+ 12P_3(v)P_4^* - 6P_3(v)P_6^* + c.c. \left. \right) - 6D^{(1,1,2,1)}(v) + 2D^{(1,1,1,2)}(v) \\
&- 12D^{(1,3,1)}(v) + 6D_5^{(1,2,1;1)}(v) - 6D^{(2,2,1)}(v) - 6D^{(1,1,3)}(v) + 3E_2D_3^{(1)}(v) \\
&+ 2D_3G_2(v) - 24E_2G_3(v) + 24G_5(v) - 12C_{122} - 12C_{1,1,3} + 2D_{1,1,3} \\
&+ \frac{3}{2}D_{1,2,2} + 18E_5 - 6E_2E_3 + \frac{1}{\pi} \left( 12Q_1 - 3Q_2 + 6F_1(v) + 6F_2(v) \right. \\
&+ 6F_4(v) + 3F_5(v) - 3F_9(v) - 3F_{10}(v) + 6F_{23}(v) + 6F_{25}(v) + 3F_{26}(v) \\
&+ 6F_{32}(v) + 3F_{40}(v) + 3F_{84}(v) - F_{89}(v) + c.c. \left. \right) + \frac{3}{\pi}Q_3 + \frac{6}{\pi}F_7(v) \\
&- \frac{3}{2\pi}F_{94}(v) - \frac{3\tau_2}{\pi}G(v)^2\partial_v G_2(v)\bar{\partial}_v G_2(v) + \frac{6\tau_2}{\pi}E_2\partial_v G_2(v)\bar{\partial}_v G_2(v) \\
&- \frac{6\tau_2}{\pi}\partial_v G_3(v)\bar{\partial}_v G_3(v) - \frac{6\tau_2}{\pi} \left( \partial_v G_2(v)\bar{\partial}_v G_4(v) + c.c. \right) \\
&- \frac{6\tau_2}{\pi}G(v) \left( \partial_v G_2(v)\bar{\partial}_v G_3(v) + c.c. \right). \tag{3.80}
\end{aligned}$$

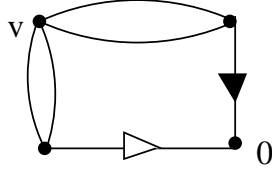

Figure 72:  $F_{94}(v)$

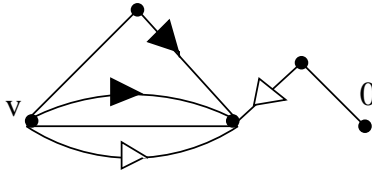

Figure 73:  $F_{95}(v)$

### 3.12 Eigenvalue equation for $D_5^{(2)}(v)$

We have that

$$\begin{aligned} \frac{1}{2}\Delta D_5^{(2)}(v) &= 3 \int_z G(v, z) \partial_\mu G(v, z) \bar{\partial}_\mu G(v, z) G(z)^2 + \int_z G(v, z)^3 \partial_\mu G(z) \bar{\partial}_\mu G(z) \\ &\quad + 3 \int_z \left( G(v, z)^2 \partial_\mu G(v, z) G(z) \bar{\partial}_\mu G(z) + c.c. \right). \end{aligned} \quad (3.81)$$

Since the analysis of this graph is somewhat more involved, we describe the intermediate steps in some detail.

Consider the first term on the right hand side of (3.81). We have that

$$\begin{aligned} \int_z G(v, z) \partial_\mu G(v, z) \bar{\partial}_\mu G(v, z) G(z)^2 &= -D_5^{(2)}(v) + \frac{1}{\pi} \left( 2F_7(v) + F_{36}(v) \right) \\ &\quad + \frac{1}{\pi} \left( F_{99}(v) + \frac{2}{\pi} F_{100}(v) + c.c. \right) + \frac{2}{\pi^2} F_{101}(v), \end{aligned} \quad (3.82)$$

where the graphs  $F_{99}(v)$ ,  $F_{100}(v)$  and  $F_{101}(v)$  are given in figure 77.

To simplify  $F_{100}(v)$  and  $F_{101}(v)$ , we start with the auxiliary graphs  $F_{102}(v)$  and  $F_{103}(v)$  respectively, given in figure 78. For  $F_{100}(v)$ , we get that

$$\begin{aligned} \left( F_{100}(v) + c.c. \right) - \frac{1}{2} \left( P_2 P_8(v)^* + c.c. \right) &= -\pi^2 D_5^{(1,2,2)}(v) \\ + \pi \left( F_1(v) - \frac{F_9(v)}{2} + \frac{F_{42}(v)}{2} + \frac{F_{104}(v)}{2} + \frac{F_{43}(v)}{\pi} - \frac{F_{105}(v)}{2\pi} + c.c. \right), \end{aligned} \quad (3.83)$$

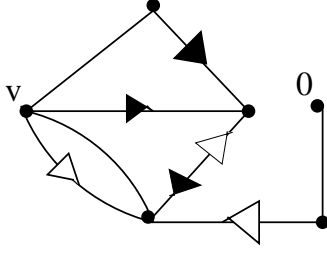

Figure 74: Auxiliary graph  $F_{96}(v)$

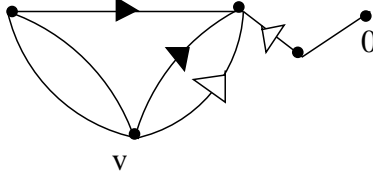

Figure 75:  $F_{97}(v)$

where the graphs  $F_{104}(v)$  and  $F_{105}(v)$  are given in figure 79.

To simplify  $F_{105}(v)$ , we start with the auxiliary graph  $F_{106}(v)$  in figure 80 to obtain

$$\begin{aligned}
& \left( F_{105}(v) + c.c. \right) - \left( P_3(v)P_8(v)^* + c.c. \right) = 2\pi^2 C_{1,1,3} + 2\pi^2 E_2 G_3(v) \\
& - 2\pi^2 E_2 D_3^{(1)}(v) - \pi \left( F_{18}(v) + F_{26}(v) + F_{40}(v) + F_{68}(v) \right) \\
& - E_2 F_{90}(v) + F_{108}(v) - F_{109}(v) + c.c. - \pi F_{107}(v), \tag{3.84}
\end{aligned}$$

where the graphs  $F_{107}(v)$ ,  $F_{108}(v)$  and  $F_{109}(v)$  are given in figure 81.

For  $F_{101}(v)$ , we get

$$\begin{aligned}
& F_{101}(v) - \frac{1}{2} \left( P_3(v)P_5(v)^* + c.c. \right) = -\frac{\pi\tau_2}{2} G(v) \left( \partial_v G_2(v) \bar{\partial}_v G_3(v) + c.c. \right) \\
& + \frac{1}{2} \left( \pi Q_1 - \pi F_{17}(v) - \pi F_{18}(v) + F_{19}(v) - \pi F_{108}(v) + F_{110}(v) + F_{111}(v) + c.c. \right), \tag{3.85}
\end{aligned}$$

where the graphs  $F_{110}(v)$  and  $F_{111}(v)$  are given in figure 82. The simplification of the graph  $F_{111}(v)$  has been analyzed in appendix E, while we consider  $F_{110}(v)$  later.

The second term on the right hand side of (3.81) gives

$$\int_z G(v, z)^3 \partial_\mu G(z) \bar{\partial}_\mu G(z) = -D_5^{(2)}(v) + \frac{3}{\pi} F_{36}(v) + \frac{1}{\pi} \left( F_{112}(v) + c.c. \right) + \frac{6}{\pi^2} F_{113}(v), \tag{3.86}$$

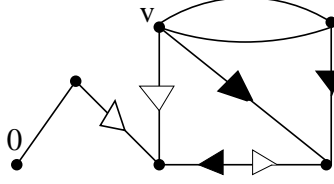

Figure 76: Auxiliary graph  $F_{98}(v)$

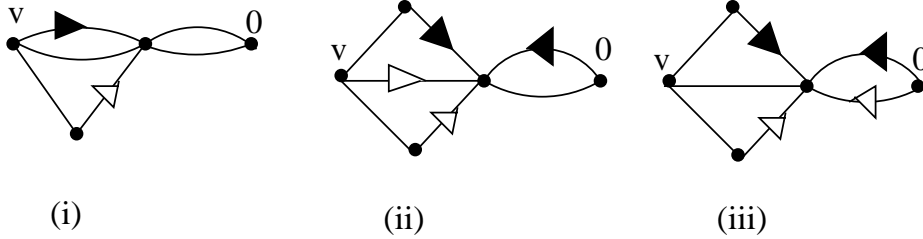

Figure 77: (i)  $F_{99}(v)$ , (ii)  $F_{100}(v)$ , (iii)  $F_{101}(v)$

where the graphs  $F_{112}(v)$  and  $F_{113}(v)$  are given in figure 83. To simplify  $F_{113}(v)$ , we start with the auxiliary graph  $F_{114}(v)$  given in figure 84 giving us

$$\begin{aligned}
 F_{113}(v) - \frac{1}{4} \left( P_3(v) P_8(v)^* + c.c. \right) &= -\frac{\pi^2}{2} D_5^{(1,2,2)}(v) \\
 + \frac{\pi}{2} \left( F_1(v) - \frac{F_{40}(v)}{2} + \frac{F_{42}(v)}{2} + \frac{F_{43}(v)}{\pi} - \frac{F_{89}(v)}{6} + \frac{F_{115}(v)}{\pi} + c.c. \right), & \quad (3.87)
 \end{aligned}$$

where  $F_{115}(v)$  is given in figure 85.

Now the graphs  $F_{110}(v)$  and  $F_{115}(v)$  are not easy to analyze and simplify directly. This follows from trying to move the derivatives along the circuit on integrating by parts. Hence we shall not analyze them directly. However, we shall see that there are contributions from the remaining terms that will prove very useful in enabling us to evaluate the total sum.

Thus proceeding, the third term on the right hand side of (3.81) yields

$$\begin{aligned}
 \int_z \left( G(v, z)^2 \partial_\mu G(v, z) G(z) \bar{\partial}_\mu G(z) + c.c. \right) &= -\frac{1}{3} D_5^{(2)}(v) \\
 + \frac{1}{\pi} \left( F_5(v) - F_{99}(v) - \frac{F_{112}(v)}{3} + c.c. \right) + \frac{4}{\pi} F_{46}(v) \\
 + \frac{2}{\pi^2} \left( F_{116}(v) + F_{117}(v) + F_{118}(v) + c.c. \right), & \quad (3.88)
 \end{aligned}$$

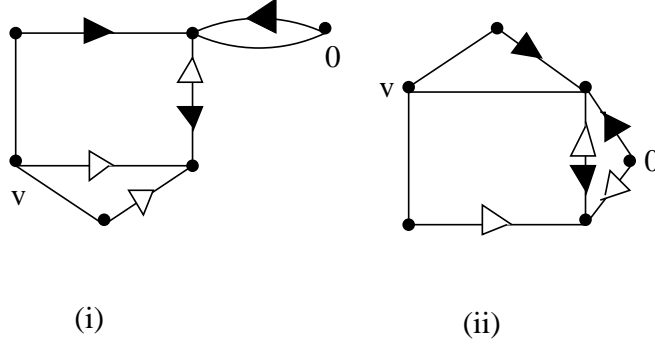

Figure 78: Auxiliary graphs (i)  $F_{102}(v)$ , (ii)  $F_{103}(v)$

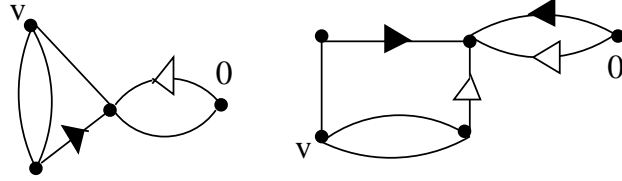

Figure 79: (i)  $F_{104}(v)$ , (ii)  $F_{105}(v)$

where the graphs  $F_{116}(v)$ ,  $F_{117}(v)$  and  $F_{118}(v)$  are given in figure 86.

To simplify  $F_{116}(v)$  and  $F_{117}(v)$ , we use the auxiliary graphs  $F_{119}(v)$  and  $F_{120}(v)$  respectively, given in figure 87.

For  $F_{116}(v)$ , we get that

$$\begin{aligned}
& \left( F_{116}(v) + c.c. \right) - \left( P_2 P_5(v)^* + c.c. \right) = \pi^2 D_5^{(2)}(v) - \pi^2 E_2 D_3^{(1)}(v) \\
& + \pi^2 E_2 E_3 - \pi^2 D_5^{(1,2,2)}(v) + 2\pi^2 D^{(1,1,3)}(v) - \pi \left( F_4(v) + F_{42}(v) \right. \\
& \left. - \frac{F_{48}(v)}{\pi} - \frac{F_{51}(v)}{2} + F_{104}(v) + \frac{F_{121}(v)}{2\pi} + c.c. \right), \tag{3.89}
\end{aligned}$$

where the graph  $F_{121}(v)$  is given in figure 88. To simplify it, we start with the auxiliary graph  $F_{122}(v)$  given in figure 89 to get

$$\begin{aligned}
& \left( F_{121}(v) + c.c. \right) - \left( P_3(v) P_8(v)^* + c.c. \right) = 2\pi^2 D^{(1,1,3)}(v) - 2\pi^2 D_5^{(1,2,1;1)}(v) \\
& + 2\pi^2 E_2 E_3 + 2\pi F_{107}(v) - \pi \left( F_{42}(v) - F_{68}(v) + F_{84}(v) - F_{89}(v) \right. \\
& \left. + E_2 F_{90}(v) + F_{123}(v) + c.c. \right) - 2\tau_2 \pi E_2 \partial_v G_2(v) \bar{\partial}_v G_2(v), \tag{3.90}
\end{aligned}$$



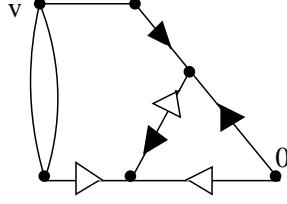

Figure 80:  $F_{106}(v)$

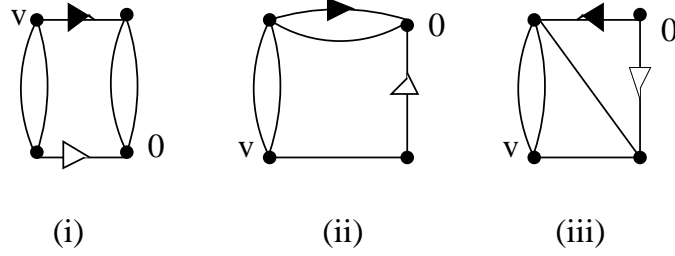

Figure 81: (i)  $F_{107}(v)$ , (ii)  $F_{108}(v)$ , (iii)  $F_{109}(v)$

where the graph  $F_{123}(v)$  is given in figure 90.

Next for  $F_{117}(v)$ , we get that

$$\begin{aligned}
& \left( F_{117}(v) + c.c. \right) - \frac{1}{2} \left( P_2 P_6^* + c.c. \right) = \frac{\pi^2}{3} D_5^{(2)}(v) - \frac{\pi^2}{3} E_2 D_3 \\
& - \frac{2\pi^2}{3} D^{(1,1,1,2)}(v) - \pi^2 D_5^{(1,2,2)}(v) + \pi^2 E_2 E_3 + 2\pi^2 D^{(1,1,3)}(v) \\
& - \pi \left( F_4(v) - \frac{F_{51}(v)}{2} - \frac{F_{11}(v)}{\pi} + \frac{F_{124}(v)}{2\pi} + c.c. \right), \tag{3.91}
\end{aligned}$$

where the graph  $F_{124}(v)$  is given in figure 91. To simplify it, we start with the auxiliary graph  $F_{125}(v)$  given in figure 92 to get

$$\begin{aligned}
& \left( F_{124}(v) + c.c. \right) - \left( P_2 P_8(v)^* + c.c. \right) = \pi^2 D_5^{(2)}(v) - \pi^2 E_2 D_3^{(1)}(v) - \pi^2 E_2 D_3 \\
& - \pi^2 D_5^{(2;2;1)}(v) + 2\pi^2 E_2 E_3 + 2\pi^2 D^{(1,1,3)}(v) - \pi \left( F_{42}(v) + F_{104}(v) + c.c. \right). \tag{3.92}
\end{aligned}$$

We next simplify  $F_{118}(v)$ . It will prove very useful for our purposes to simply write

$$F_{118}(v) = \frac{F_{118}(v)}{2} + \frac{F_{118}(v)}{2}, \tag{3.93}$$

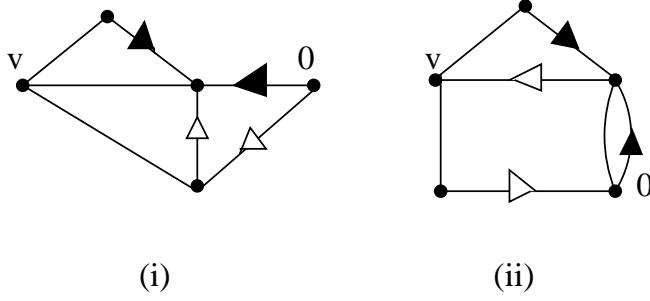

Figure 82: (i)  $F_{110}(v)$ , (ii)  $F_{111}(v)$

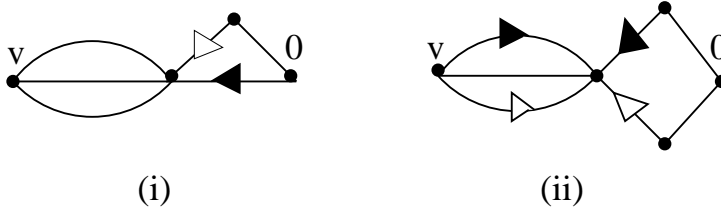

Figure 83: (i)  $F_{112}(v)$ , (ii)  $F_{113}(v)$

and evaluate the two equal contributions separately, by starting with the distinct auxiliary graphs  $F_{126}(v)$  and  $F_{127}(v)$  in figure 93.

Now  $F_{126}(v)$  gives us

$$\begin{aligned} & \left( F_{118}(v) + c.c. \right) - \left( P_3(v)P_5(v)^* + c.c. \right) = 2\pi^2 D^{(1,1,3)}(v) - \pi \left( F_4(v) + F_{42}(v) \right. \\ & \left. - \frac{F_{89}(v)}{2} - \frac{F_{48}(v)}{\pi} - \frac{F_{128}(v)}{\pi} + c.c. \right) - \pi\tau_2 G(v)^2 \partial_v G_2(v) \bar{\partial}_v G_2(v), \end{aligned} \quad (3.94)$$

where the graph  $F_{128}(v)$  is given in figure 94.

Also  $F_{127}(v)$  yields

$$\begin{aligned} & \left( F_{118}(v) + c.c. \right) - \frac{1}{2} \left( P_3(v)P_8(v)^* + c.c. \right) = -\pi^2 D^{(1,1,2,1)}(v) \\ & + \pi \left( F_2(v) + \frac{F_{18}(v)}{2} + \frac{F_{30}(v)}{\pi} + \frac{F_{111}(v)}{\pi} + \frac{F_{129}(v)}{\pi} + c.c. \right), \end{aligned} \quad (3.95)$$

where the graph  $F_{129}(v)$  is given in figure 95.

Importantly, the contributions of  $F_{110}(v)$ ,  $F_{115}(v)$ ,  $F_{128}(v)$  and  $F_{129}(v)$  to the right hand

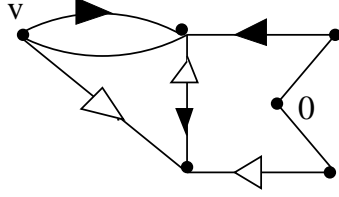

Figure 84: Auxiliary graph  $F_{114}(v)$

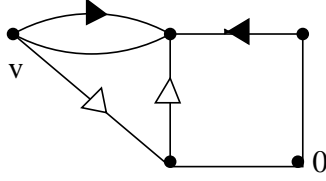

Figure 85:  $F_{115}(v)$

side of (3.81) is equal to

$$\frac{3}{\pi^2} \left( F_{110}(v) + F_{128}(v) + c.c. \right) + \frac{3}{\pi^2} \left( F_{115}(v) + F_{129}(v) + c.c. \right). \quad (3.96)$$

The combination  $F_{110}(v) + F_{128}(v) + c.c.$  gives us

$$\begin{aligned} F_{110}(v) + F_{128}(v) + c.c. &= -\pi \left( F_{65}(v) - \frac{F_{84}(v)}{2} \right. \\ &\quad \left. - F_{109}(v) + F_{123}(v) + \frac{F_{130}(v)}{\pi} + c.c. \right), \end{aligned} \quad (3.97)$$

while the combination  $F_{115}(v) + F_{129}(v) + c.c.$  gives us

$$\begin{aligned} F_{115}(v) + F_{129}(v) + c.c. &= \pi^2 D_5^{(2)}(v) - \pi^2 G_2(v) D_3^{(1)}(v) \\ &\quad - \pi \left( F_{41}(v) + \frac{F_{109}(v)}{2} - \frac{F_{123}(v)}{2} + \frac{F_{131}(v)}{\pi} + c.c. \right), \end{aligned} \quad (3.98)$$

where the graphs  $F_{130}(v)$  and  $F_{131}(v)$  are given in figure 96. To simplify them, we introduce the auxiliary graphs  $F_{132}(v)$  and  $F_{133}(v)$  respectively, given in figure 97.

For  $F_{130}(v) + c.c.$ , we get that

$$\begin{aligned} &\left( F_{130}(v) + c.c. \right) - \left( P_3(v) \left[ P_5(v) + P_7(v) \right]^* + c.c. \right) = -\pi^2 D_5^{(1;2;2)}(v) + 2\pi^2 D^{(1,3,1)}(v) \\ &\quad - \pi^2 D^{(1,1,2,1)}(v) + 2\pi^2 E_3 G_2(v) + \pi F_{94}(v) - 2\pi \tau_2 G_2(v) \partial_v G_2(v) \bar{\partial}_v G_2(v) - \pi \left( F_{17}(v) \right. \\ &\quad \left. - \frac{F_{18}(v)}{2} + \frac{F_{84}(v)}{2} + G_2(v) F_{90}(v) - F_{108}(v) + \frac{F_{109}(v)}{2} - \frac{F_{134}(v)}{2} + c.c. \right), \end{aligned} \quad (3.99)$$

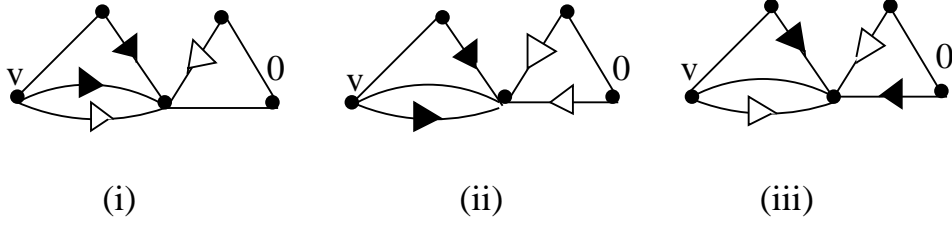

Figure 86: (i)  $F_{116}(v)$ , (ii)  $F_{117}(v)$ , (iii)  $F_{118}(v)$

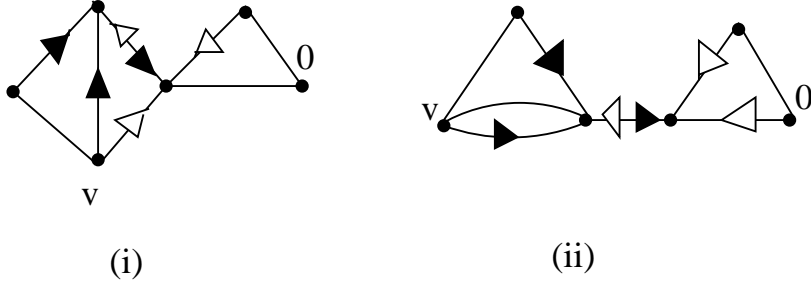

Figure 87: Auxiliary graphs (i)  $F_{119}(v)$ , (ii)  $F_{120}(v)$

where the graph  $F_{134}(v)$  is given in figure 98.

For  $F_{131}(v) + c.c.$ , we get that

$$\begin{aligned}
& \left( F_{131}(v) + c.c. \right) - \left( P_3(v) \left[ P_5(v) + P_7(v) \right]^* + c.c. \right) = 2\pi^2 D^{(1,3,1)}(v) \\
& + 2\pi^2 G_2(v) G_3(v) - \pi^2 D_5^{(1;2;2)}(v) - \pi^2 D_5^{(1,2,2)}(v) + \pi^2 D_5^{(2)}(v) - 3\pi^2 G_2(v) D_3^{(1)}(v) \\
& - \frac{\pi}{2} F_{94}(v) - \pi \left( F_{17}(v) + \frac{F_{26}(v)}{2} - \frac{F_{42}(v)}{2} - G_2(v) F_{90}(v) + \frac{F_{89}(v)}{3} \right. \\
& \left. - \frac{F_{123}(v)}{2} + \frac{F_{134}(v)}{2} + c.c. \right). \tag{3.100}
\end{aligned}$$

We could now simply add all the contributions and write down the eigenvalue equation. However this would not be quite useful for our purposes. This is because for this graph (as well as for most of the others) the eigenvalue equation involves several contributions whose links are given by derivatives of Green functions (this is even after simplifying using the several relations in appendices A and B). Our aim is to find suitable linear combinations of these graphs such that the eigenvalue equations contain only graphs whose links are given by Green functions, and not their derivatives. Eventually we would like to solve these equations and find algebraic relations between the graphs<sup>18</sup>.

<sup>18</sup>This is what happened for the analysis involving the graphs with four links

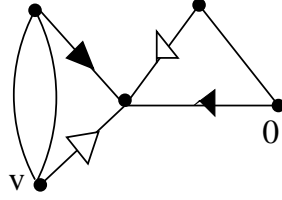

Figure 88:  $F_{121}(v)$

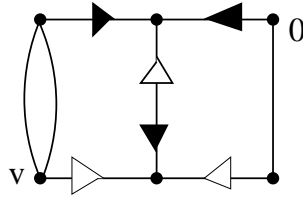

Figure 89: Auxiliary graph  $F_{122}(v)$

However for  $D_5^{(2)}$  the eigenvalue equation involves some graphs which do not arise elsewhere. Hence to reach our final goal, we should be able to express them in terms of already existing graphs. This indeed is the case, and the analysis is given in appendix F.

Thus, using the relation (B.2) as well the results in appendices E and F, we get the eigenvalue equation

$$\begin{aligned}
\frac{1}{6}\Delta D_5^{(2)}(v) &= \frac{1}{\pi^2} \left[ P_2^* \left( 2P_1(v) + P_6 + 2P_5(v) \right) + 2P_3(v)^* \left( 2P_5(v) + 2P_7(v) + P_8(v) \right) \right. \\
&+ c.c. \left. \right] + 4D_5^{(1,2,2)}(v) + 2D^{(1,1,2,1)}(v) + 4D_5^{(1,2,1;1)}(v) + 10D^{(1,1,3)}(v) \\
&- 20D^{(1,2,2)}(v) - 6D^{(2,2,1)}(v) - 12D^{(1,3,1)}(v) + \frac{2}{3}D^{(1,1,1,2)}(v) + D_5^{(2;2;1)}(v) \\
&+ 2D_5^{(1;2;2)}(v) + 2C_{1,1,3} + 10E_5 + 16G_5(v) - 6E_2G_3(v) - 4E_2E_3 - 3E_2D_3^{(1)}(v) \\
&+ \frac{1}{3}E_2D_3 - 2E_3G_2(v) - 8G_2(v)G_3(v) - \frac{2\tau_2}{\pi}G_2(v)\partial_v G_2(v)\bar{\partial}_v G_2(v) \\
&+ \frac{8\tau_2}{\pi}E_2\partial_v G_2(v)\bar{\partial}_v G_2(v) - \frac{6\tau_2}{\pi}\partial_v G_3(v)\bar{\partial}_v G_3(v) - \frac{10\tau_2}{\pi} \left( \partial_v G_2(v)\bar{\partial}_v G_4(v) + c.c. \right) \\
&- \frac{6\tau_2}{\pi}G(v) \left( \partial_v G_2(v)\bar{\partial}_v G_3(v) + c.c. \right) - \frac{3\tau_2}{\pi}G(v)^2\partial_v G_2(v)\bar{\partial}_v G_2(v) + \frac{1}{\pi} \left( 10F_1(v) \right. \\
&+ 14F_2(v) - 6F_4(v) + F_5(v) + 3F_9(v) - F_{10}(v) + 2F_{17}(v) + F_{23}(v) + 3F_{26}(v) \\
&+ F_{32}(v) + 6F_{35}(v) + 3F_{40}(v) - 4F_{41}(v) + 2F_{51}(v) - F_{65}(v) + 3F_{84}(v)
\end{aligned}$$

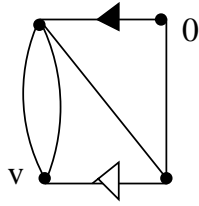

Figure 90:  $F_{123}(v)$

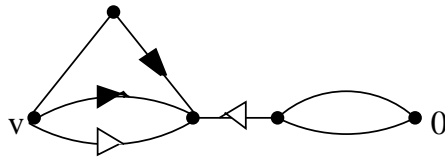

Figure 91:  $F_{124}(v)$

$$-F_{89}(v) + c.c.) - \frac{4}{\pi}F_3(v) - \frac{2}{\pi}F_7(v) - \frac{4}{\pi}F_{57}(v) + \frac{4}{\pi}F_{61}(v) - \frac{3}{2\pi}F_{94}(v). \quad (3.101)$$

Based on the discussion above, we now analyze the various eigenvalue equations aiming to simplify them significantly beyond what we have done so far.

## 4 Eigenvalue equations and algebraic identities for elliptic modular graphs

Let us briefly summarize an important feature of the eigenvalue equations that we have derived for the various modular graphs. The equations for the graphs  $D^{(1,2,2)}(v)$  and  $D^{(1,1,3)}(v)$  given by (3.12) and (3.18) respectively, are simple in the sense that they do not contain graphs whose links are given by derivatives of Green functions. No other eigenvalue equation for graphs with five links has this property. On the other hand, the equation for  $D^{(2,2,1)}(v)$  in (3.9) shows us that  $\tau_2 \partial_v G_3(v) \bar{\partial}_v G_3(v)$  can be traded off for an expression involving no graphs with links given by derivatives of Green functions. Similar is the case for  $\tau_2 \partial_v G_2(v) \bar{\partial}_v G_4(v) + c.c.$  using the equation for  $D^{(1,3,1)}(v)$  in (3.15). Thus any simplification involving the other graphs which satisfy far more involved eigenvalue equations must involve several additional cancellations among each other. We do not have an algorithm to readily determine which linear combinations of graphs lead to such cancellations if any, so we shall proceed by guessing such combinations based on the eigenvalue equations.

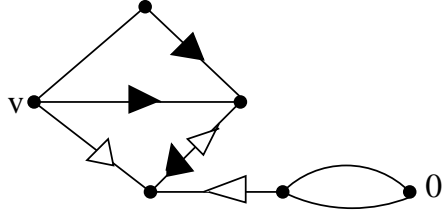

Figure 92: Auxiliary graph  $F_{125}(v)$

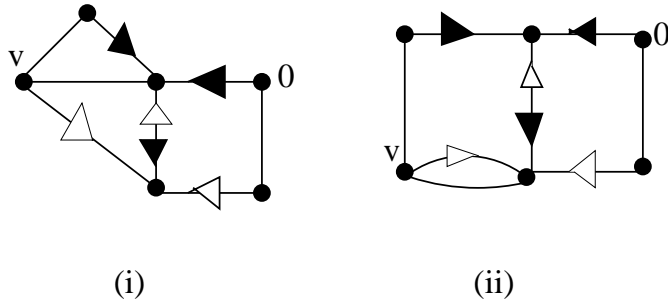

Figure 93: Auxiliary graphs (i)  $F_{126}(v)$ , (ii)  $F_{127}(v)$

#### 4.1 Involving $D^{(1,1,1,2)}(v)$ and $D_5^{(2,2;1)}(v)$ among others

Let us consider the eigenvalue equation for  $D^{(1,1,1,2)}(v)$  given by (3.25). We show in appendix C that the contribution involving  $F_5(v) + c.c.$  can be expressed in terms of graphs without any derivatives on the links. Thus apart from the terms involving  $F_7(v)$  and  $P_1(v)P_2^* + c.c.$  on the right hand side of (3.25), all the other terms can be expressed as graphs with no derivatives on the links.

Next we consider the eigenvalue equation for  $D_5^{(2,2;1)}$  in (3.55). Apart from the terms involving  $\tau_2 \partial_v G_3(v) \bar{\partial}_v G_3(v)$  and  $F_7(v)$ , all the others can be expressed in terms of graphs without derivatives on the links.

Thus it is natural to consider the combination

$$-\frac{1}{3}(\Delta - 6)D^{(1,1,1,2)}(v) + \frac{1}{4}(\Delta - 2)D_5^{(2,2;1)}(v) \quad (4.1)$$

in which the contribution involving  $F_7(v)$  cancels. Using the identities in appendices A and B, we observe that there is a striking simplification leading to

$$\begin{aligned} & (\Delta - 6) \left( -\frac{1}{3}D^{(1,1,1,2)}(v) + \frac{1}{4}D_5^{(2,2;1)}(v) + E_2 G_3(v) \right) \\ &= -\frac{4\tau_2}{\pi} \partial_v G_3(v) \bar{\partial}_v G_3(v) - 6D^{(1,2,2)}(v) - 3D^{(2,2,1)}(v) \end{aligned}$$

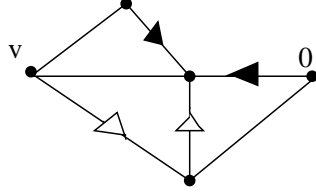

Figure 94:  $F_{128}(v)$

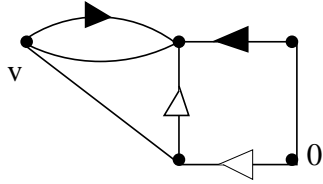

Figure 95:  $F_{129}(v)$

$$+8E_2G_3(v) - 6G_5(v) + 6E_5 - 2G_2(v)G_3(v) + 2E_3G_2(v). \quad (4.2)$$

Using the eigenvalue equations for  $D^{(2,2,1)}(v)$  and  $D^{(1,1,3)}(v)$ , this yields the eigenvalue equation

$$\begin{aligned} & \left( \Delta - 6 \right) \left( -\frac{1}{3}D^{(1,1,1,2)}(v) + \frac{1}{4}D_5^{(2;2;1)}(v) - \frac{1}{2}D^{(2,2,1)}(v) + 2D^{(1,1,3)}(v) + E_2G_3(v) \right) \\ & = 28G_5(v) \end{aligned} \quad (4.3)$$

which does not have any graph with derivatives of the Green function as links. This immediately leads to

$$\begin{aligned} & \left( \Delta - 6 \right) \left( -\frac{1}{3}D^{(1,1,1,2)}(v) + \frac{1}{4}D_5^{(2;2;1)}(v) - \frac{1}{2}D^{(2,2,1)}(v) \right. \\ & \left. + 2D^{(1,1,3)}(v) + E_2G_3(v) - 2G_5(v) \right) = 0 \end{aligned} \quad (4.4)$$

on using (2.9). This equation is of the form

$$\left( \Delta - s(s-1) \right) \Phi_s(v) = 0 \quad (4.5)$$

where  $s = 3$ . We assume based on  $SL(2, \mathbb{Z})$  invariance and the asymptotic properties for large  $\tau_2$  that the solution is<sup>19</sup>

$$\Phi_s(v) = \alpha_s E_s + \beta_s G_s(v) \quad (4.6)$$

<sup>19</sup>In the remaining two subsections, we encounter (4.5) for  $s = 2$  and  $s = 0$ . For  $s = 0$ , we assume the answer is  $\Phi_0(v) = \text{constant}$ .



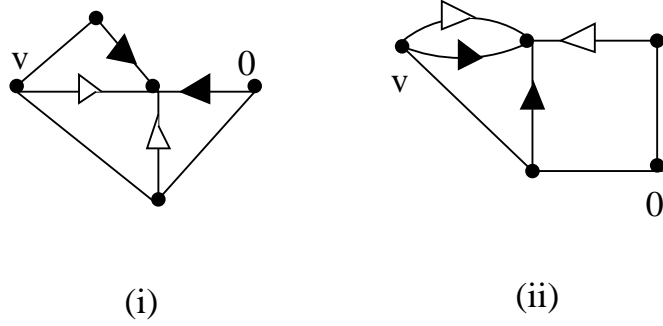

Figure 96: (i)  $F_{130}(v)$  (ii)  $F_{131}(v)$

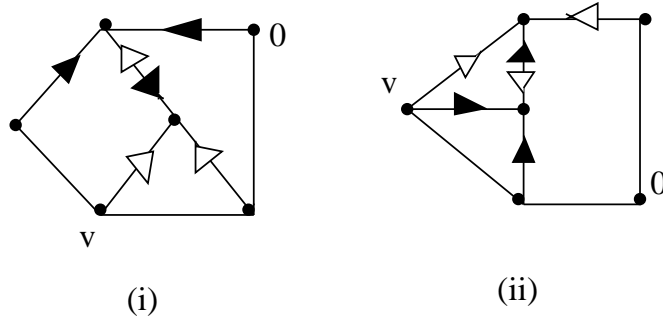

Figure 97: Auxiliary graphs (i)  $F_{132}(v)$  (ii)  $F_{133}(v)$

where  $\alpha_s$  and  $\beta_s$  are constants. Hence (4.4) yields the algebraic identity

$$\begin{aligned}
 & -\frac{1}{3}D^{(1,1,1,2)}(v) + \frac{1}{4}D_5^{(2,2;1)}(v) - \frac{1}{2}D^{(2,2,1)}(v) + 2D^{(1,1,3)}(v) + E_2G_3(v) - 2G_5(v) \\
 & = \alpha E_3 + \beta G_3(v)
 \end{aligned} \tag{4.7}$$

between the various graphs. We now solve for  $\alpha$  and  $\beta$ .

On integrating over an unintegrated vertex, the left hand side vanishes, and we get  $0 = \alpha E_3$ , hence  $\alpha = 0$ . On identifying  $0$  and  $v$ , we get that

$$\beta E_3 = -\frac{1}{3}\left(D_{1,1,3} - 3E_2E_3\right) + \frac{D_{1,2,2}}{4} - \frac{C_{1,2,2}}{2} + 2C_{1,1,3} - 2E_5. \tag{4.8}$$

Using the identities (1.8), the right hand side vanishes and hence  $\beta = 0$ . This algebraic identity is given in figure 99.

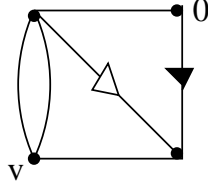

Figure 98:  $F_{134}(v)$

$$\begin{aligned}
 & -\frac{1}{3} \text{graph} + \frac{1}{4} \text{graph} - \frac{1}{2} \text{graph} \\
 & + 2 \text{graph} + \text{graph} - 2 \text{graph} = 0
 \end{aligned}$$

Figure 99: Algebraic identity (4.7)

## 4.2 Involving $D^{(1,1,2,1)}(v)$ and $D_5^{(1,2,2)}(v)$ among others

We next start with the combination

$$\frac{1}{2}(\Delta - 2) \left( D^{(1,1,2,1)}(v) - D_5^{(1,2,2)}(v) \right) \tag{4.9}$$

where several terms involving graphs with derivatives as their links cancel. Among other terms, (4.9) has the terms

$$\frac{\tau_2}{\pi} E_2 \partial_v G_2(v) \bar{\partial}_v G_2(v) - \frac{\tau_2}{\pi} G_2(v) \partial_v G_2(v) \bar{\partial}_v G_2(v) = \frac{\tau_2}{\pi} \mathcal{F}_2(v) \partial_v G_2(v) \bar{\partial}_v G_2(v) \tag{4.10}$$

left in it, which can be cancelled by adding

$$-\frac{1}{4}(\Delta - 2) D_5^{(1,2,2)}(v) \tag{4.11}$$

to (4.9). The remaining terms include

$$\frac{1}{\pi} \left( F_{17}(v) + c.c. \right) \tag{4.12}$$

among others, which can be cancelled by further adding

$$\frac{1}{2}(\Delta - 2) D_5^{(1,2,1,1)}(v) \tag{4.13}$$

to (4.9) and (4.11). Among several other terms,

$$\frac{2}{\pi}F_7(v) \quad (4.14)$$

remains, which can be cancelled by adding

$$\frac{1}{3}(\Delta - 6)D^{(1,1,1,2)} \quad (4.15)$$

to (4.9), (4.11) and (4.13) as well.

The remaining expression can be simplified using appendices A, B, C and D. We also use the algebraic identity (4.7) for  $D_5^{(2;2;1)}(v)$  in the process. In fact, an intermediate step in the analysis yields

$$\begin{aligned} & \frac{1}{2}(\Delta - 2) \left( D^{(1,1,2,1)}(v) - D_5^{(1,2,2)}(v) - \frac{1}{2}D_5^{(1;2;2)}(v) + D_5^{(1,2,1;1)}(v) + \frac{2}{3}D^{(1,1,1,2)}(v) \right) \\ & - \frac{1}{\pi^2} \left( 9P_1(v)P_2^* - 6P_1(v)P_3(v)^* - 3P_2P_4^* + 6P_3(v)P_4^* + c.c. \right) \\ & = 5D^{(1,2,2)}(v) + 12D^{(1,1,3)}(v) - \frac{9}{2}D^{(2,2,1)}(v) + \frac{1}{2}C_{1,2,2} + 11E_5 - 3G_5(v) \\ & - 3E_2G_3(v) + G_2(v)G_3(v) - E_3G_2(v) - 3E_2E_3 - \frac{2\tau_2}{\pi}\partial_v G_3(v)\bar{\partial}_v G_3(v). \end{aligned} \quad (4.16)$$

Finally, we use the eigenvalue equations for  $D^{(2,2,1)}(v)$ ,  $D^{(1,1,3)}(v)$  and  $D^{(1,2,2)}(v)$ . The resulting eigenvalue equation simplifies considerably and is given by

$$\begin{aligned} & (\Delta - 2) \left( \frac{1}{2}D^{(1,1,2,1)}(v) - \frac{1}{2}D_5^{(1,2,2)}(v) - \frac{1}{4}D_5^{(1;2;2)}(v) + \frac{1}{2}D_5^{(1,2,1;1)}(v) \right. \\ & + \frac{1}{3}D^{(1,1,1,2)}(v) - \frac{1}{4}D^{(2,2,1)}(v) - 3D^{(1,1,3)}(v) - 4D^{(1,2,2)}(v) + \frac{1}{2}E_2E_3 \\ & \left. - \frac{3}{2}E_2G_3(v) - G_2(v)E_3 + G_2(v)G_3(v) \right) = 16E_5 - 90G_5(v) + \frac{1}{2}C_{1,2,2}. \end{aligned} \quad (4.17)$$

Thus easily leads to

$$\begin{aligned} & (\Delta - 2) \left( \frac{1}{2}D^{(1,1,2,1)}(v) - \frac{1}{2}D_5^{(1,2,2)}(v) - \frac{1}{4}D_5^{(1;2;2)}(v) + \frac{1}{2}D_5^{(1,2,1;1)}(v) \right. \\ & + \frac{1}{3}D^{(1,1,1,2)}(v) - \frac{1}{4}D^{(2,2,1)}(v) - 3D^{(1,1,3)}(v) - 4D^{(1,2,2)}(v) + \frac{1}{2}E_2E_3 \\ & \left. - \frac{3}{2}E_2G_3(v) - G_2(v)E_3 + G_2(v)G_3(v) + 5G_5(v) - \frac{9}{10}E_5 + \frac{\zeta(5)}{120} \right) = 0, \end{aligned} \quad (4.18)$$

where we have used the expression for  $C_{1,2,2}$  in (1.8) as well as (1.1) and (2.9). Hence based on (4.5) and (4.6), we obtain the non-trivial algebraic identity

$$\begin{aligned} & \frac{1}{2}D^{(1,1,2,1)}(v) - \frac{1}{2}D_5^{(1,2,2)}(v) - \frac{1}{4}D_5^{(1;2;2)}(v) + \frac{1}{2}D_5^{(1,2,1;1)}(v) + \frac{1}{3}D^{(1,1,1,2)}(v) \\ & - \frac{1}{4}D^{(2,2,1)}(v) - 3D^{(1,1,3)}(v) - 4D^{(1,2,2)}(v) + \frac{1}{2}E_2E_3 - \frac{3}{2}E_2G_3(v) \\ & - G_2(v)E_3 + G_2(v)G_3(v) + 5G_5(v) - \frac{9}{10}E_5 + \frac{\zeta(5)}{120} = \alpha E_2 + \beta G_2(v) \end{aligned} \quad (4.19)$$

where we now determine  $\alpha$  and  $\beta$ .

To determine  $\alpha$ , on integrating over the unintegrated vertex, we get that

$$-4\alpha E_2 = C_{1,2,2} - \frac{2}{5}E_5 - \frac{\zeta(5)}{30}, \quad (4.20)$$

and hence  $\alpha = 0$  using (1.8). To determine  $\beta$ , we identify the vertices 0 and  $v$ , leading to

$$\beta E_2 = \frac{1}{3}(D_{1,1,3} - 3E_2E_3) + \frac{1}{4}D_{1,2,2} - 3C_{1,1,3} - \frac{17}{4}C_{1,2,2} + \frac{41}{10}E_5 + \frac{\zeta(5)}{120}. \quad (4.21)$$

Now the right hand side vanishes using the identities in (1.8), and hence  $\beta = 0$ . The identity (4.19) is given in figure 100.

Figure 100: Algebraic identity (4.19)

### 4.3 Involving $D_5^{(1)}(v)$ and $D_5^{(2)}(v)$ among others

Finally, we consider the eigenvalue equation

$$\Delta\left(D_5^{(2)}(v) - \frac{3}{2}D_5^{(1)}(v)\right). \quad (4.22)$$

Among other contributions, it contains

$$-\frac{48}{\pi}F_7(v) + \frac{48}{\pi}\left(F_{17}(v) + c.c.\right), \quad (4.23)$$

which can be cancelled by adding

$$24\Delta D_5^{(1,2,1;1)}(v) \quad (4.24)$$

to (4.22).

Using the results in appendices A, B, C and D, as well as the identities (4.7) and (4.19), we get that

$$\begin{aligned} \Delta\left(D_5^{(2)}(v) - \frac{3}{2}D_5^{(1)}(v) + 24D_5^{(1,2,1;1)}(v)\right) &= \frac{6}{\pi^2}\left(P_2P_6^* - 6P_3(v)P_6^* + c.c.\right) \\ &- \frac{12}{\pi^2}\left[\left(P_2 - P_3(v)\right)\left(2P_5(v)^* + 2P_7(v)^* + P_8(v)^*\right) + c.c.\right] \\ &- \frac{72\tau_2}{\pi}\left(\partial_v G_2(v)\bar{\partial}_v G_4(v) + c.c.\right) + \frac{12\tau_2}{\pi}\left(E_2 - G_2(v)\right)\partial_v G_2(v)\bar{\partial}_v G_2(v) \\ &+ 72D^{(2,2,1)}(v) + 144D^{(1,3,1)}(v) + 36C_{1,1,3} - 48C_{1,2,2} - 12D_{1,1,3} + 9D_{1,2,2} \\ &+ \frac{384}{5}E_5 + 432G_5(v) - 24E_3G_2(v) - 24E_2G_3(v) - 12D_3G_2(v) \\ &- 72G_2(v)G_3(v) - 12\left(E_2 - G_2(v)\right)D_3^{(1)}(v) + 54E_2E_3 + 2E_2D_3 + \frac{2}{5}\zeta(5). \end{aligned} \quad (4.25)$$

On further using the relations in (B.3), we see that (4.25) gives us

$$\begin{aligned} \Delta\left(D_5^{(2)}(v) - \frac{3}{2}D_5^{(1)}(v) + 24D_5^{(1,2,1;1)}(v) - E_2D_3 + 6D_3G_2(v) - 6G_2(v)D_3^{(1)}(v) \right. \\ \left. + 6E_2D_3^{(1)}(v)\right) &= 72D^{(2,2,1)}(v) + 144D^{(1,3,1)}(v) + 36C_{1,1,3} - 48C_{1,2,2} - 12D_{1,1,3} \\ &+ 9D_{1,2,2} + 432G_5(v) + \frac{384}{5}E_5 - 96G_2(v)G_3(v) + 60E_2E_3 + \frac{2}{5}\zeta(5) \\ &- \frac{72\tau_2}{\pi}\left(\partial_v G_2(v)\bar{\partial}_v G_4(v) + c.c.\right). \end{aligned} \quad (4.26)$$

Finally, on using the eigenvalue equations for the graphs  $D^{(1,2,2)}(v)$  and  $D^{(1,3,1)}(v)$  in (3.12) and (3.15) respectively, as well the relations (1.7) and (1.8), we get the eigenvalue equation

$$\begin{aligned} \Delta\left(D_5^{(2)}(v) - \frac{3}{2}D_5^{(1)}(v) + 24D_5^{(1,2,1;1)}(v) - 24D^{(1,3,1)}(v) + 24D^{(1,2,2)}(v) \right. \\ \left. - \frac{3}{2}D_{1,2,2} - 6C_{1,1,3} + 2D_{1,1,3} - E_2D_3 - 6E_2E_3 + 6D_3G_2(v) \right. \\ \left. - 6G_2(v)D_3^{(1)}(v) + 6E_2D_3^{(1)}(v)\right) &= 480G_5(v) - 264E_5 \end{aligned} \quad (4.27)$$

which has simplified enormously. Now using (1.1) and (2.9), this easily yields

$$\begin{aligned} & \Delta \left( D_5^{(2)}(v) - \frac{3}{2}D_5^{(1)}(v) + 24D_5^{(1,2,1;1)}(v) - 24D^{(1,3,1)}(v) + 24D^{(1,2,2)}(v) \right. \\ & - 24G_5(v) - \frac{3}{2}D_{1,2,2} - 6C_{1,1,3} + 2D_{1,1,3} + \frac{66}{5}E_5 - E_2D_3 - 6E_2E_3 \\ & \left. + 6D_3G_2(v) - 6G_2(v)D_3^{(1)}(v) + 6E_2D_3^{(1)}(v) \right) = 0. \end{aligned} \quad (4.28)$$

From (4.5) and (4.6), we see that (4.28) immediately gives us the algebraic identity

$$\begin{aligned} & D_5^{(2)}(v) - \frac{3}{2}D_5^{(1)}(v) + 24D_5^{(1,2,1;1)}(v) - 24D^{(1,3,1)}(v) + 24D^{(1,2,2)}(v) \\ & - 24G_5(v) - \frac{3}{2}D_{1,2,2} - 6C_{1,1,3} + 2D_{1,1,3} + \frac{66}{5}E_5 - E_2D_3 - 6E_2E_3 \\ & + 6D_3G_2(v) - 6G_2(v)D_3^{(1)}(v) + 6E_2D_3^{(1)}(v) = c, \end{aligned} \quad (4.29)$$

where  $c$  is a constant. To determine  $c$ , we integrate over an unintegrated vertex to get that

$$2D_{1,1,3} - \frac{3}{2}D_{1,2,2} - 12C_{1,1,3} + \frac{66}{5}E_5 - 6E_2E_3 = c, \quad (4.30)$$

which using the relations in (1.8), yields

$$c = -\frac{\zeta(5)}{10}. \quad (4.31)$$

As a non-trivial consistency check, on identifying the vertices  $v$  and 0, (4.29) gives us

$$-\frac{1}{2} \left( D_5 - 10E_2D_3 \right) + 2 \left( D_{1,1,3} - 3E_2E_3 \right) + \frac{45}{2}D_{1,2,2} - 30C_{1,1,3} + 24C_{1,2,2} - \frac{54}{5}E_5 = c. \quad (4.32)$$

Again on using (1.8), this precisely reproduces (4.31). The identity (4.29) is given in figure 101.

Thus we have obtained the eigenvalue equations (3.12), (3.18), (4.4), (4.18) and (4.28) involving elliptic modular graphs with five links. These equations involve graphs whose links are given by the Green functions. We have also obtained the algebraic identities (4.7), (4.19) and (4.29) between the graphs. There is a notion of transcendentality which is preserved for these equations, where we assign transcendentality 1 for each link of the graph, and  $s$  to  $\zeta(s)$ .

## A Various identities

In this appendix, we list various identities involving the graphs  $F_i(v)$  that are used to simplify various expressions in the main text. We list only those identities that are relevant in obtaining the final eigenvalue equations having graphs with links given only by the Green

$$\begin{aligned}
& \text{Graph 1} - \frac{3}{2} \text{Graph 2} + 24 \text{Graph 3} \\
& - 24 \text{Graph 4} + 24 \text{Graph 5} - 24 \text{Graph 6} \\
& - \frac{3}{2} \text{Graph 7} - 6 \text{Graph 8} + 2 \text{Graph 9} + \frac{66}{5} \text{Graph 10} \\
& - 6 \text{Graph 11} - 6 \text{Graph 12} + 6 \text{Graph 13} \\
& - 6 \text{Graph 14} + 6 \text{Graph 15} + 6 \text{Graph 16} + \frac{\zeta(5)}{10} = 0
\end{aligned}$$

Figure 101: Algebraic identity (4.29)

functions, and not their derivatives. Thus several identities involving  $F_i(v)$  which arise in the eigenvalue equation for each modular graph are irrelevant in the final sum, and so we do not list them. However, they can also be easily obtained like the ones listed below.

Now there are several graphs  $F_i(v)$  that do not admit any simplification, while others can be simplified only with some effort, as discussed in the main text and the later appendices. However, many can be simplified easily, and are the ones given below. These are graphs which have one  $\partial G$  and one  $\bar{\partial} G$  along the links, which meet at a cubic vertex in the graph as given in figure 102(i)<sup>20</sup>. To express this in terms of graphs with all derivatives removed along the links, we start with the graph in figure 102(ii) where the two derivatives along the same link can be removed using (2.4). Alternatively this can be evaluated on integrating by parts, which reproduces the graph in figure 102(i) (plus complex conjugate if it is not real), as well as other two other graphs without any derivatives along the links, again on using (2.4). We now give the relations for the relevant graphs<sup>21</sup>.

<sup>20</sup>To this we add the complex conjugate if the graph is not real.

<sup>21</sup>The analysis for  $F_{51}(v) + c.c.$  also proceeds as above, by moving the link on the right to the center, along the lines of what has been done for several graphs in the main text.

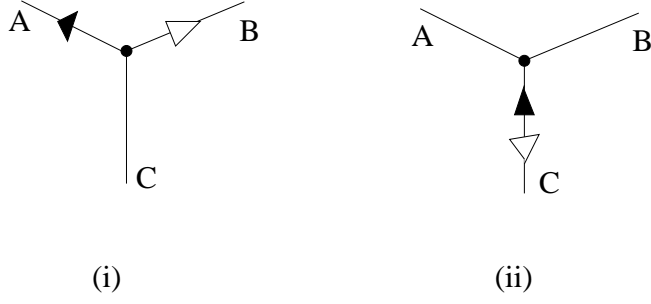

Figure 102: The simplification

$$\begin{aligned}
\frac{1}{\pi} \left( F_1(v) + c.c. \right) &= D^{(1,3,1)}(v) + D^{(2,2,1)}(v) + E_5 - G_2(v)G_3(v), \\
\frac{1}{\pi} \left( F_2(v) + c.c. \right) &= D^{(1,3,1)}(v) + D^{(1,2,2)}(v) + G_5(v) - E_3G_2(v), \\
\frac{F_3(v)}{\pi} &= D^{(1,2,2)}(v) - \frac{1}{2}D^{(2,2,1)}(v), \\
\frac{1}{\pi} \left( F_4(v) + c.c. \right) &= D^{(1,1,3)}(v) - D^{(1,2,2)}(v) - G_5(v) + E_2G_3(v), \\
\frac{1}{\pi} \left( F_9(v) + c.c. \right) &= D_5^{(1,2,1;1)}(v) + D^{(1,1,2,1)}(v) - E_2G_3(v) + C_{1,1,3} - G_2(v)D_3^{(1)}(v), \\
\frac{1}{\pi} \left( F_{10}(v) + c.c. \right) &= D_5^{(1,2,1;1)}(v) + D^{(1,1,1,2)}(v) + D^{(1,1,3)}(v) - E_2G_3(v) - D_3G_2(v), \\
\frac{1}{\pi} \left( F_{41}(v) + c.c. \right) &= D_5^{(1;2;2)}(v) + D_5^{(1,2,2)}(v) + D^{(1,3,1)}(v) - G_2(v)G_3(v) - G_2(v)D_3^{(1)}(v), \\
\frac{1}{\pi} \left( F_{51}(v) + c.c. \right) &= D_5^{(1,2,2)}(v) - D_5^{(2;2;1)}(v) - D^{(1,1,3)}(v) - E_2E_3 + E_2D_3^{(1)}(v), \\
\frac{F_{57}(v)}{\pi} &= D_5^{(1,2,1;1)}(v) - D^{(1,2,2)}(v) - \frac{1}{2}D_5^{(1;2;2)}(v) + \frac{1}{2}C_{1,2,2}, \\
\frac{1}{\pi} \left( F_{63}(v) + c.c. \right) &= D_5^{(2;2;1)}(v) - D^{(2,2,1)}(v), \\
\frac{1}{\pi} \left( F_{65}(v) + c.c. \right) &= D^{(1,3,1)}(v) + D^{(1,1,2,1)}(v) + D_5^{(1,2,1;1)}(v) - E_3G_2(v) - E_2D_3^{(1)}(v), \\
\frac{F_{79}(v)}{\pi} &= \frac{1}{2}D_5^{(1;2;2)}(v). \tag{A.1}
\end{aligned}$$

## B More graphs and some identities

The graphs  $Q_1$ ,  $Q_2$  and  $Q_3$  in the main text, are given in figure 103.



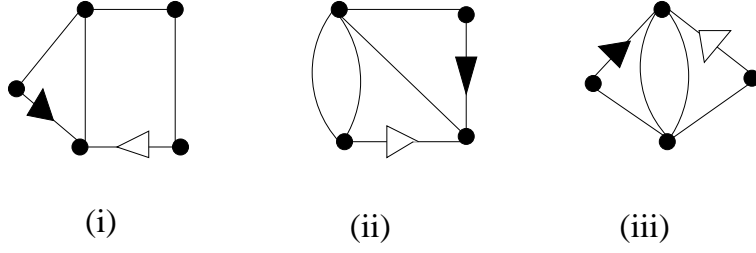

Figure 103: (i)  $Q_1$ , (ii)  $Q_2$ , (iii)  $Q_3$

They satisfy the equations [14]

$$\begin{aligned}
 \frac{1}{\pi} \left( Q_1 + c.c. \right) &= C_{1,1,3} + C_{1,2,2} + E_5 - E_2 E_3, \\
 \frac{1}{\pi} \left( Q_2 + c.c. \right) &= D_{1,1,3} + D_{1,2,2} + C_{1,1,3} - E_2 E_3 - E_2 D_3, \\
 \frac{Q_3}{\pi} &= 4C_{1,2,2} + 3C_{1,1,3} + D_{1,1,3} - 2E_2 E_3 - E_2 D_3.
 \end{aligned} \tag{B.1}$$

Also the graphs  $P_1(v), \dots, P_8(v)$  in the main text are given in figure 104.

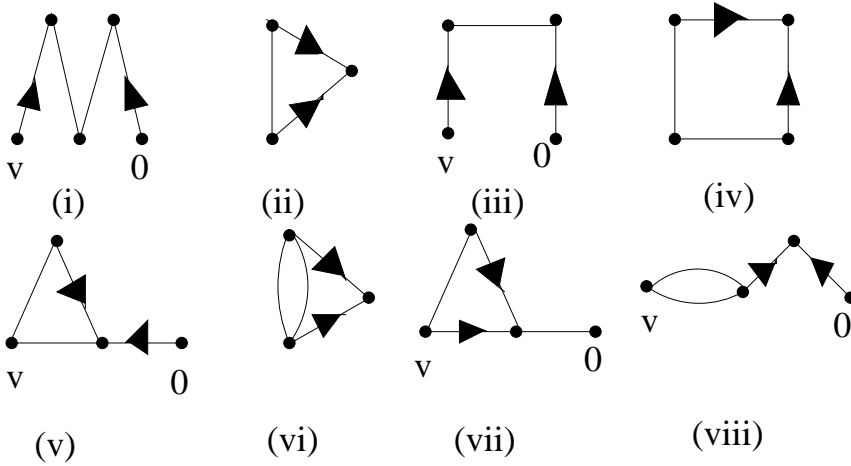

Figure 104: (i)  $P_1(v)$ , (ii)  $P_2$ , (iii)  $P_3(v)$ , (iv)  $P_4$ , (v)  $P_5(v)$ , (vi)  $P_6$ , (vii)  $P_7(v)$ , (viii)  $P_8(v)$

We have that  $P_4 = P_6$  starting from  $D_3 = E_3 + \zeta(3)$  and acting with  $\partial_\mu$ . Also we find the identity

$$2P_1(v) - 2P_7(v) - P_8(v) = 0 \tag{B.2}$$

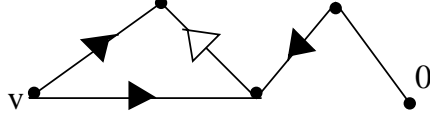

Figure 105: Auxiliary graph  $P(v)$

to be very useful, which follows starting from the auxiliary graph  $P(v)$  in figure 105.

Finally, we list the eigenvalue equations satisfied by several products of two graphs.

$$\begin{aligned}
(\Delta - 8)E_2E_3 &= \frac{6}{\pi^2}(P_2P_4^* + c.c.), \\
(\Delta - 8)E_2G_3(v) &= \frac{6}{\pi^2}(P_1(v)P_2^* + c.c.), \\
(\Delta - 8)G_2(v)E_3 &= \frac{6}{\pi^2}(P_3(v)P_4^* + c.c.), \\
(\Delta - 8)G_2(v)G_3(v) &= \frac{6}{\pi^2}(P_1(v)P_3(v)^* + c.c.), \\
(\Delta - 2)E_2D_3 &= 6E_2E_3 + \frac{6}{\pi^2}(P_2P_6^* + c.c.), \\
(\Delta - 2)G_2(v)D_3 &= 6G_2(v)E_3 + \frac{6}{\pi^2}(P_3(v)P_6^* + c.c.), \\
(\Delta - 2)(G_2(v) - E_2)D_3^{(1)}(v) &= 2\left(E_3 + 2G_3(v) - \frac{\tau_2}{\pi}\partial_v G_2(v)\bar{\partial}_v G_2(v)\right) \\
&\times \left(G_2(v) - E_2\right) - \frac{2}{\pi^2}\left[\left(P_2 - P_3(v)\right)\left(2P_5(v)^* + 2P_7(v)^* + P_8(v)^*\right) + c.c.\right], \quad (\text{B.3})
\end{aligned}$$

where we have used (1.1), (1.3), (2.9) and (3.1). Thus they are helpful in expressing a product of two graphs, one of which has two factors of  $\partial G$  and the other has two factors of  $\bar{\partial}G$  along their links, in terms of the action of the Laplacian on graphs which do not have derivatives of Green functions as their links.

## C Simplifying $F_5(v) + c.c.$

To simplify the expression involving  $F_5(v) + c.c.$ , we consider the auxiliary graph  $A_1(v)$  given in figure 106, which leads to<sup>22</sup>

$$F_5(v) = \pi E_2 G_3(v) - \pi D^{(2,2,1)}(v) - \frac{2}{\pi} A_2(v). \quad (\text{C.1})$$

Now the graph  $A_2(v)$  is given in figure 107 which we simplify using the auxiliary graph  $A_3(v)$  given in the same figure, to obtain

<sup>22</sup>This analysis is similar to the one in [19].

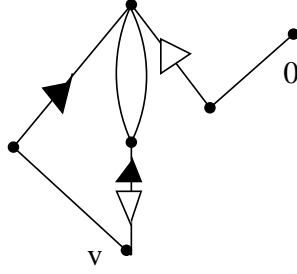

Figure 106: Auxiliary graph  $A_1(v)$

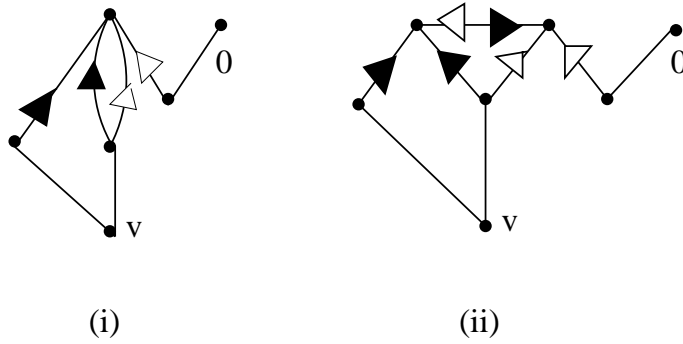

Figure 107: (i)  $A_2(v)$  and (ii) auxiliary graph  $A_3(v)$

$$\begin{aligned}
F_5(v) + c.c. &= -2D^{(2,2,1)}(v) - 8G_5(v) + 5E_2G_3(v) + 9D^{(1,1,3)}(v) - 2E_2E_3 \\
&+ D_5^{(1,2,1;1)}(v) - D_3G_2(v) + D^{(1,1,1,2)}(v) + 2D_5^{(1,2,2)}(v) \\
&+ \frac{1}{\pi} \left( 2F_1(v) - 6F_4(v) - F_{51}(v) - 2F_{63}(v) + c.c. \right). \tag{C.2}
\end{aligned}$$

In an intermediate stage of the analysis, we need to calculate  $A_4(v) + c.c.$ , which we perform using

$$2 \left( A_4(v) + c.c. \right) = \left( A_5(v) + c.c. \right) - 2\pi D^{(1,1,1,2)}(v) + 2\pi E_2G_3(v), \tag{C.3}$$

where the graphs  $A_4(v)$  and  $A_5(v)$  are given in figure 108.

To analyze  $A_5(v) + c.c.$ , we consider the action of  $\tau_2 \partial_v \bar{\partial}_v$  on the graph  $A_6(v)$  in figure 109. While on interchanging the labels in  $A_6(v)$  this leads to  $-\pi D_5^{(1,2,1;1)}(v)$ , we can evaluate it differently keeping the labels as they are and moving  $\partial_v$  and  $\bar{\partial}_v$  through the graph. Equating the two expressions gives us

$$A_5(v) + c.c. = -\pi D_5^{(1,2,1;1)}(v) + \pi D_3G_2(v) - \pi D^{(1,1,3)}(v) + \pi D^{(1,1,1,2)}(v) - \pi E_2G_3(v). \tag{C.4}$$

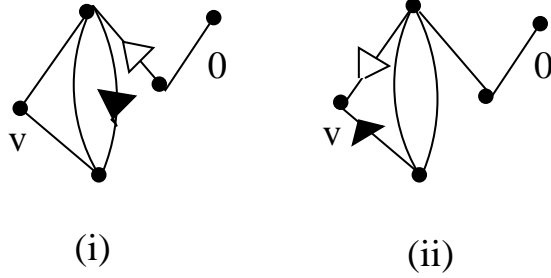

Figure 108: (i)  $A_4(v)$ , (ii)  $A_5(v)$

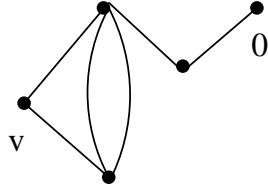

Figure 109:  $A_6(v)$

## D Simplifying $F_{36}(v)$

We have that

$$F_{36}(v) = \pi E_2 E_3 - 2F_3(v) - \frac{2}{\pi} F_{55}(v). \quad (\text{D.1})$$

Now using (3.50) and appendix A, we get that

$$\begin{aligned} \frac{F_{36}(v)}{\pi} &= \frac{2}{\pi} \partial_v G_3(v) \bar{\partial}_v G_3(v) + 2D^{(1,3,1)}(v) + 2D^{(1,2,2)}(v) + 3D^{(2,2,1)}(v) \\ &\quad - D_5^{(1,2,1;1)}(v) + D^{(1,1,2,1)}(v) + D_5^{(1;2;2)}(v) + 2G_5(v) - C_{1,2,2} \\ &\quad + C_{1,1,3} - 2E_5 + E_2 E_3 - E_2 G_3(v) - 2E_3 G_2(v) - G_2(v) D_3^{(1)}(v). \end{aligned} \quad (\text{D.2})$$

## E Simplifying $F_{111}(v) + c.c.$

To simplify  $F_{111}(v)$ , we start with the auxiliary graph  $B_1(v)$  in figure 110, to get

$$F_{111}(v) + c.c. = \pi \left( \frac{B_2(v)}{\pi^2} + F_{17}(v) - F_{40}(v) + c.c. \right), \quad (\text{E.1})$$

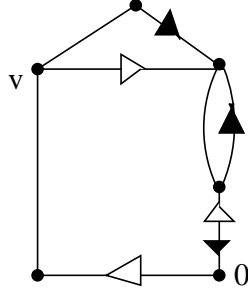

Figure 110: Auxiliary graph  $B_1(v)$

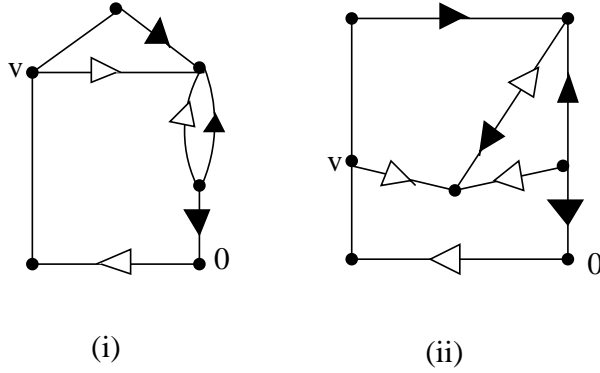

Figure 111: (i)  $B_2(v)$  and (ii) auxiliary graph  $B_3(v)$

where the graph  $B_2(v)$  is in figure 111. To simplify it, we start with the auxiliary graph  $B_3(v)$  in the same figure. This gives us

$$\begin{aligned}
& F_{111}(v) + \tau_2 P_3(v) \left( \bar{\partial}_v G_2(v) \right)^2 + c.c. = \pi \tau_2 E_2 \partial_v G_2(v) \bar{\partial}_v G_2(v) \\
& - \pi \tau_2 G(v)^2 \partial_v G_2(v) \bar{\partial}_v G_2(v) - \pi \tau_2 \left( \partial_v G_2(v) \bar{\partial}_v G_4(v) + c.c. \right) \\
& - \pi \tau_2 G(v) \left( \partial_v G_2(v) \bar{\partial}_v G_3(v) + c.c. \right) - \pi \left( F_{25}(v) - 2F_{35}(v) - \frac{F_{84}(v)}{2} + c.c. \right). \quad (E.2)
\end{aligned}$$

In an intermediate step, we have used the relation

$$\frac{B_4(v)}{\pi} = \frac{\tau_2}{2} E_2 \partial_v G_2(v) \bar{\partial}_v G_2(v) - F_{35}(v)^* - \frac{F_{89}(v)^*}{2}, \quad (E.3)$$

where the graph  $B_4(v)$  is given in figure 112.

Now the second term on the left hand side of (E.2) is a graph which does not arise in the analysis elsewhere in the main text, and hence needs to be expressed in terms of the

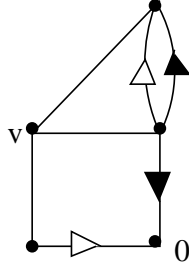

Figure 112:  $B_4(v)$

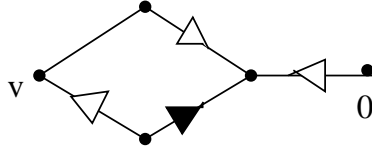

Figure 113:  $B_5(v)$

other graphs to see cancellations. To simplify this, we start with the graph  $B_5(v)$  in figure 113 to get

$$\tau_2 \left( \bar{\partial}_v G_2(v) \right)^2 = P_4(v)^* - 2P_5(v)^*, \quad (\text{E.4})$$

leading to

$$\tau_2 P_3(v) \left( \bar{\partial}_v G_2(v) \right)^2 + c.c = P_3(v) P_4(v)^* - 2P_3(v) P_5(v)^* + c.c.. \quad (\text{E.5})$$

## F Simplifying graphs that arise in analyzing $D_5^{(2)}(v)$

### F.1 Relating $F_{94}(v)$ and $F_{107}(v)$

We see that

$$F_{94}(v) = F_{107}(v), \quad (\text{F.1})$$

which follows from manipulating the graph  $C_1(v)$  in figure 114.

### F.2 Simplifying $F_{108}(v)$

Now

$$F_{108}(v) = -\tau_2 \bar{\partial}_v G_2(v) C_2(v), \quad (\text{F.2})$$

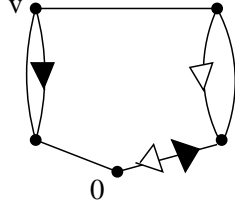

Figure 114:  $C_1(v)$

where the graph  $C_2(v)$  is given in figure 115.

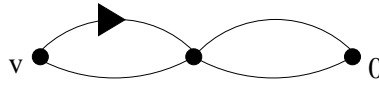

Figure 115:  $C_2(v)$

We have that

$$C_2(v) = \frac{2}{\pi} C_3(v), \quad (\text{F.3})$$

where the graph  $C_3(v)$  is given in figure 116 which we simplify using the auxiliary graph  $C_4(v)$  in the same figure.

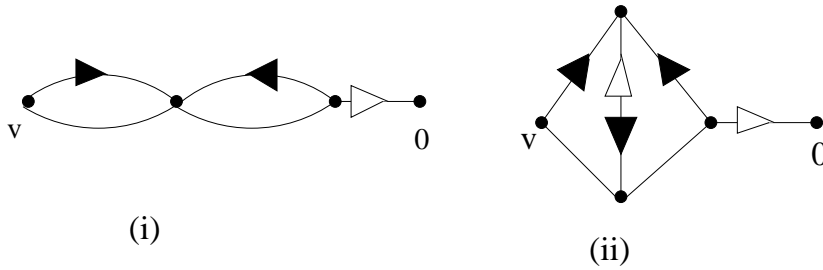

Figure 116: (i)  $C_3(v)$  and auxiliary graph (ii)  $C_4(v)$

This leads to the relation

$$F_{108}(v) = 2\tau_2 G_2(v) \partial_v G_2(v) \bar{\partial}_v G_2(v) + 4\tau_2 \partial_v G_4(v) \bar{\partial}_v G_2(v) - 4F_{40}(v) + \frac{2}{3} F_{89}(v)^* - 2\tau_2 E_2 \partial_v G_2(v) \bar{\partial}_v G_2(v). \quad (\text{F.4})$$

### F.3 Simplifying $F_{46}(v)$

Starting from

$$F_{46}(v) = C_5(v) \tag{F.5}$$

where the graph  $C_5(v)$  is given in figure 117, we get that

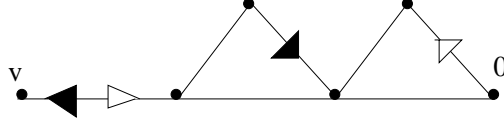

Figure 117:  $C_5(v)$

$$F_{46}(v) = D_5^{(1,2,2)}(v) + D^{(1,1,3)}(v) - E_2 E_3 - E_2 D_3^{(1)}(v) + F_{58}(v), \tag{F.6}$$

which can be simplified using  $F_{60}(v)$  to give us

$$\begin{aligned} F_{46}(v) = & D_5^{(1,2,2)}(v) + D^{(1,1,3)}(v) - D^{(2,2,1)}(v) - 2D^{(1,2,2)}(v) - E_2 E_3 \\ & - E_2 D_3^{(1)}(v) + E_5 + G_5(v) + \frac{1}{\pi} \left( F_1(v) + F_2(v) + F_9(v) + c.c. \right) \\ & - \frac{F_7(v)}{\pi} + \frac{F_{61}(v)}{\pi} - \frac{\tau_2}{\pi} \partial_v G_3(v) \bar{\partial}_v G_3(v). \end{aligned} \tag{F.7}$$

## References

- [1] E. D’Hoker, M. B. Green, and P. Vanhove, “On the modular structure of the genus-one Type II superstring low energy expansion,” *JHEP* **08** (2015) 041, 1502.06698.
- [2] E. D’Hoker, M. B. Green, O. Gurdogan, and P. Vanhove, “Modular Graph Functions,” *Commun. Num. Theor. Phys.* **11** (2017) 165–218, 1512.06779.
- [3] M. B. Green and P. Vanhove, “The Low-energy expansion of the one loop type II superstring amplitude,” *Phys.Rev.* **D61** (2000) 104011, hep-th/9910056.
- [4] M. B. Green, J. G. Russo, and P. Vanhove, “Low energy expansion of the four-particle genus-one amplitude in type II superstring theory,” *JHEP* **0802** (2008) 020, 0801.0322.
- [5] N. Berkovits, E. D’Hoker, M. B. Green, H. Johansson, and O. Schlotterer, “Snowmass White Paper: String Perturbation Theory,” in *2022 Snowmass Summer Study*. 3, 2022. 2203.09099.



- [6] D. Dorigoni, M. B. Green, and C. Wen, “The SAGEX Review on Scattering Amplitudes, Chapter 10: Modular covariance of type IIB string amplitudes and their  $\mathcal{N} = 4$  supersymmetric Yang-Mills duals,” 2203.13021.
- [7] E. D’Hoker and J. Kaidi, “Lectures on modular forms and strings,” 2208.07242.
- [8] D. Dorigoni, M. Doroudiani, J. Drewitt, M. Hidding, A. Kleinschmidt, N. Matthes, O. Schlotterer, and B. Verbeek, “Modular graph forms from equivariant iterated Eisenstein integrals,” 2209.06772.
- [9] D. Dorigoni, A. Kleinschmidt, and R. Treillis, “To the cusp and back: Resurgent analysis for modular graph functions,” 2208.14087.
- [10] A. Basu, “Poisson equation for the Mercedes diagram in string theory at genus one,” *Class. Quant. Grav.* **33** (2016), no. 5, 055005, 1511.07455.
- [11] E. D’Hoker and M. B. Green, “Identities between Modular Graph Forms,” *J. Number Theor.* **189** (2018) 25–88, 1603.00839.
- [12] A. Basu, “Poisson equation for the three loop ladder diagram in string theory at genus one,” *Int. J. Mod. Phys. A* **31** (2016), no. 32, 1650169, 1606.02203.
- [13] A. Basu, “Proving relations between modular graph functions,” *Class. Quant. Grav.* **33** (2016), no. 23, 235011, 1606.07084.
- [14] A. Basu, “Simplifying the one loop five graviton amplitude in type IIB string theory,” *Int. J. Mod. Phys. A* **32** (2017), no. 14, 1750074, 1608.02056.
- [15] E. D’Hoker and J. Kaidi, “Hierarchy of Modular Graph Identities,” *JHEP* **11** (2016) 051, 1608.04393.
- [16] A. Kleinschmidt and V. Verschinin, “Tetrahedral modular graph functions,” *JHEP* **09** (2017) 155, 1706.01889.
- [17] J. Broedel, O. Schlotterer, and F. Zerbini, “From elliptic multiple zeta values to modular graph functions: open and closed strings at one loop,” *JHEP* **01** (2019) 155, 1803.00527.
- [18] E. D’Hoker and M. B. Green, “Exploring transcendentality in superstring amplitudes,” *JHEP* **07** (2019) 149, 1906.01652.
- [19] A. Basu, “Eigenvalue equation for the modular graph  $C_{a,b,c,d}$ ,” *JHEP* **07** (2019) 126, 1906.02674.
- [20] J. E. Gerken, A. Kleinschmidt, and O. Schlotterer, “All-order differential equations for one-loop closed-string integrals and modular graph forms,” *JHEP* **01** (2020) 064, 1911.03476.

- [21] J. E. Gerken, A. Kleinschmidt, and O. Schlotterer, “Generating series of all modular graph forms from iterated Eisenstein integrals,” *JHEP* **07** (2020), no. 07, 190, 2004.05156.
- [22] J. E. Gerken, “Basis Decompositions and a Mathematica Package for Modular Graph Forms,” *J. Phys. A* **54** (2021), no. 19, 195401, 2007.05476.
- [23] E. D’Hoker, M. B. Green, and B. Pioline, “Higher genus modular graph functions, string invariants, and their exact asymptotics,” *Commun. Math. Phys.* **366** (2019), no. 3, 927–979, 1712.06135.
- [24] E. D’Hoker, M. B. Green, and B. Pioline, “Asymptotics of the  $D^8\mathcal{R}^4$  genus-two string invariant,” *Commun. Num. Theor. Phys.* **13** (2019) 351–462, 1806.02691.
- [25] E. D’Hoker, C. R. Mafra, B. Pioline, and O. Schlotterer, “Two-loop superstring five-point amplitudes. Part II. Low energy expansion and S-duality,” *JHEP* **02** (2021) 139, 2008.08687.
- [26] A. Basu, “Poisson equations for elliptic modular graph functions,” *Phys. Lett. B* **814** (2021) 136086, 2009.02221.
- [27] A. Basu, “Relations between elliptic modular graphs,” *JHEP* **12** (2020) 195, 2010.08331.
- [28] E. D’Hoker, A. Kleinschmidt, and O. Schlotterer, “Elliptic modular graph forms. Part I. Identities and generating series,” *JHEP* **03** (2021) 151, 2012.09198.
- [29] A. Basu, “Poisson equation for genus two string invariants: a conjecture,” *JHEP* **04** (2021) 050, 2101.04597.
- [30] M. Hidding, O. Schlotterer, and B. Verbeek, “Elliptic modular graph forms II: Iterated integrals,” 2208.11116.
- [31] W. Lerche, B. E. W. Nilsson, A. N. Schellekens, and N. P. Warner, “Anomaly Cancelling Terms From the Elliptic Genus,” *Nucl. Phys.* **B299** (1988) 91–116.
- [32] E. P. Verlinde and H. L. Verlinde, “Chiral Bosonization, Determinants and the String Partition Function,” *Nucl. Phys.* **B288** (1987) 357.
- [33] E. D’Hoker and D. H. Phong, “The Geometry of String Perturbation Theory,” *Rev. Mod. Phys.* **60** (1988) 917.

