

# Public Signals in Network Congestion Games

Svenja M. Griesbach<sup>1</sup>, Martin Hoefer<sup>2</sup>, Max Klimm<sup>1</sup>,  
Tim Koglin<sup>2</sup>

<sup>1</sup>Technische Universität Berlin, Germany

{griesbac,klimm}@math.tu-berlin.de

<sup>2</sup>Goethe-Universität Frankfurt, Germany

{mhoefer,koglin}@em.uni-frankfurt.de

## Abstract

We consider a largely untapped potential for the improvement of traffic networks that is rooted in the inherent uncertainty of travel times. Travel times are subject to stochastic uncertainty resulting from various parameters such as weather condition, occurrences of road works, or traffic accidents. Large mobility services have an informational advantage over single network users as they are able to learn traffic conditions from data. A benevolent mobility service may use this informational advantage in order to steer the traffic equilibrium into a favorable direction. The resulting optimization problem is a task commonly referred to as *signaling* or *Bayesian persuasion*. Previous work has shown that the underlying signaling problem can be NP-hard to approximate within any non-trivial bounds, even for affine cost functions with stochastic offsets. In contrast, we show that in this case, the signaling problem is easy for many networks. We tightly characterize the class of single-commodity networks, in which *full information revelation* is always an optimal signaling strategy. Moreover, we construct a reduction from optimal signaling to computing an optimal collection of support vectors for the Wardrop equilibrium. For two states, this insight can be used to compute an optimal signaling scheme. The algorithm runs in polynomial time whenever the number of different supports resulting from any signal distribution is bounded to a polynomial in the input size. Using a cell decomposition technique, we extend the approach to a polynomial-time algorithm for multi-commodity parallel link networks with a constant number of commodities, even when we have a constant number of different states of nature.

## 1 Introduction

It is a well-known fact that selfish behavior degrades the performance of traffic networks. The theory of congestion games provides a rich set of tools to study this effect qualitatively and quantitatively. The study of congestion games has a long history at the intersection of computer science, economics, and operations research. Most notably, the rich set of results includes characterizations and quantitative bounds on the (economic) inefficiency of equilibria. Inefficiency leads to higher overall travel times than in an optimal allocation of traffic flow in the network. Moreover, it can result in paradoxical effects of equilibrium behavior when changing the travel times or the demand in the network [9, 29, 42, 46, 51]. To measure this inefficiency, various (worst-case) quantitative bounds on the prices of anarchy and stability have been shown for various versions of the model (e.g., non-atomic [19, 45, 48, 47] or atomic [1, 4, 13, 14]). Many of these bounds depend heavily on the growth rate of the cost functions that measure delays along connections in the networks. In contrast, the structure of networks resulting in worst-case inefficiency is often rather generic. Also, recent interest has observed that inefficiencies persist even when demands are subject to change [16, 18] or users are not risk-neutral [41].

As a remedy for the inefficiency of equilibrium flow, various measures have been discussed in the literature, most prominently road tolls (see, e.g., [17, 27, 39, 36, 34, 44, 15, 37]) and, to a lesser extent, network design techniques [30, 46]. While in principle, some of these measures seem very attractive, in

---

**Funding:** This work was supported by Deutsche Forschungsgemeinschaft EXC-2046/1, Project ID: 390685689. The authors thank the organizers and participants of Dagstuhl Seminar 18102 “Dynamic Models in Transportation Science”.

many countries the political climate labels it rather unlikely (and/or undesirable) that measures like tolls or benevolent network manipulation get implemented to a substantial extent.

In this paper, we consider a largely untapped potential of network improvement that is rooted in the inherent uncertainty of travel times. In many real-world networks, it is realistic to assume that the travel times of a network edge  $e$  are not deterministic. Rather, travel times subject to stochastic uncertainty resulting from various parameters such as weather condition, occurrences of road works, or traffic accidents. In these scenarios, mobility services like TomTom, Waze, or Google Maps have an informational advantage over a single network user as they learn traffic conditions from data. A benevolent mobility service may use this informational advantage in order to steer the traffic equilibrium into a favorable direction. The resulting optimization problem for the mobility service is a task commonly referred to as *signaling* or *Bayesian persuasion*.

More concretely, in this problem there is a set of different *scenarios* or *states of nature*, along with a prior distribution over these states. The state determines the exact delay or cost functions for every connection in the network. A benevolent *principal* can see the exact realization of the state of nature, while the *agents* or *users* only get to see the prior. This knowledge creates an informational advantage for the principal. To exploit this advantage, the principal commits upfront to a *signaling scheme*, i.e., a distribution over (abstract) signals for each possible state of nature. Signals can be interpreted as, e.g., route recommendations, traffic reports, weather updates, etc. The users know the prior and get to see the signaling scheme (but not the realization of the state). Upon learning the realization of the state, the principal sends a (public) signal chosen according to the scheme to all users. With a Bayesian update, users determine the conditional distribution over states underlying the received signal. They then choose routes based on the signal and their induced (partial) knowledge about the delays in the network. The goal of the principal is to choose the signaling scheme in order to optimize the expected cost of the emerging traffic equilibrium. For a more formal description of the model, we refer to Section 1.1.

In general, it is known that the signaling problem sketched above is intrinsically difficult. In a seminal work, Bhaskar et al. [8] show that the problem of computing the optimal scheme cannot be approximated in polynomial time by a factor of  $(4/3 - \varepsilon)$  for every  $\varepsilon > 0$  unless  $\mathbf{P} = \mathbf{NP}$ . The hardness result applies when edge costs are affine linear in the amount of traffic. In particular, costs are *affine with state-based offsets*, i.e., the state of nature will affect only the constant offset in the delays. Moreover, the reduction applies even for a single commodity when all users want to travel from the same source to the same target. Note that a  $4/3$ -approximation is a trivial consequence on the well-known bound of  $4/3$  on the price of anarchy for affine costs [48].

While this result limits what can be expected from signaling, the reduction relies on a number of (arguably) strong assumptions. For example, the network is assumed to have arbitrary (worst-case) structure. Moreover, the reduction requires a very large number of states that is linear in the number of connections in the network. Arguably, real-world networks rarely have worst-case structure. Moreover, the number of states of nature that result in substantially different road conditions is usually limited and intuitively seems much lower than the number of edges in a large-scale traffic network. In this paper, our interest is to understand the consequences of network structure and bounded number of states of nature on the structure and computational complexity of computing optimal signaling schemes. Before stating our results, we proceed with a formal description of the model and the signaling problem.

## 1.1 Model and Preliminaries

**Signaling.** We consider a signaling problem in the context of congestion games. There is a finite set  $\Theta$  of *states of nature*, along with a prior distribution  $\mu^*$ , where  $\mu_\theta^* \geq 0$  is the probability that state  $\theta \in \Theta$  is realized. We denote by  $\Delta(\Theta)$  the space of all distributions over  $\Theta$ .

There is a sufficiently large, finite set of (public) *signals*  $\Sigma$  which can be used by a benevolent principal to influence the information of all players in a congestion game. We study the problem of computing a good signaling scheme, given by a distribution over  $\Sigma$  for each state  $\theta \in \Theta$ . More formally, a *signaling scheme* is a vector  $\varphi = (\varphi_{\theta,\sigma})_{\theta \in \Theta, \sigma \in \Sigma}$  such that  $\varphi_{\theta,\sigma} \geq 0$  for all  $\theta \in \Theta, \sigma \in \Sigma$ , and  $\sum_{\sigma \in \Sigma} \varphi_{\theta,\sigma} = \mu_\theta^*$  for each  $\theta \in \Theta$ . The value of  $\varphi_{\theta,\sigma}$  is the combined probability that state  $\theta$  is realized and the sender sends signal  $\sigma$ . We define  $\varphi_\sigma = \sum_{\theta \in \Theta} \varphi_{\theta,\sigma}$  as the total probability that signal  $\sigma$  gets sent. A signal  $\sigma \in \Sigma$  *gets issued* by scheme  $\varphi$  if  $\varphi_\sigma > 0$ .

The scenario proceeds as follows. First, the principal commits to a signaling scheme  $\varphi$  and communicates this to all players. Hence, the prior  $\mu^*$  and the signaling scheme  $\varphi$  are public knowledge. Then the state of nature is realized. The principal sees the realized state  $\theta$  and sends a public signal  $\sigma$  chosen according to  $\varphi$ . All agents receive the signal, update their beliefs about the state of nature  $\theta$  and the

resulting costs in the congestion game, and then choose equilibrium strategies as a result of (unilaterally) minimizing their individual expected cost. The goal of the principal is to choose  $\varphi$  to minimize the total expected cost of the resulting equilibrium.

**Congestion Games.** Let us now describe the (non-atomic) congestion game, the (individual) expected cost of the agents, and the total expected cost in more detail. There is a set  $E = \{e_1, \dots, e_m\}$  of *resources* or *elements*. For every element  $e \in E$  and every state  $\theta \in \Theta$ , there is a *cost function*  $c_e^\theta : \mathbb{R}_{\geq 0} \rightarrow \mathbb{R}_{\geq 0}$  that is convex and non-decreasing. In this paper, we focus on *affine costs with state-based offsets*, i.e., all functions  $c_e^\theta$  are of the form

$$c_e^\theta(x) = a_e \cdot x + b_e^\theta$$

where  $a_e \in \mathbb{R}_{>0}$  and  $b_e^\theta \in \mathbb{R}_{\geq 0}$  for every  $e \in E$  and  $\theta \in \Theta$ .

There is a set  $R = \{1, \dots, r\}$  of player populations or commodities. For each  $i \in R$ , population  $i$  consists of a continuum of infinitesimally small players of total volume  $d_i > 0$ , and is associated with the interval  $[0, d_i]$ . Every population  $i$  has a set of feasible strategies  $\mathcal{S}_i \subseteq 2^E$  so that every strategy  $S \in \mathcal{S}_i$  is a non-empty subset of elements.

A strategy distribution is a distribution of the players of each population  $i \in R$  on the strategies  $S \in \mathcal{S}_i$ . Such a strategy distribution is represented by a vector  $x = (x_{i,S})_{i \in R, S \in \mathcal{S}_i}$  satisfying the three properties (1)  $\sum_{S \in \mathcal{S}_i} x_{i,S} = d_i$ , (2)  $x_{i,S} \geq 0$  for all  $i \in R, S \in \mathcal{S}_i$ , and (3)  $x_{i,S} = 0$  for all  $i \in R, S \notin \mathcal{S}_i$ . Let  $\mathcal{X}$  denote the set of those vectors. Every strategy distribution  $x \in \mathcal{X}$  induces a *load* on every element  $e \in E$  given by

$$x_e = \sum_{i \in R} \sum_{S \in \mathcal{S}_i: e \in S} x_{i,S}.$$

Upon receiving the public signal  $\sigma$  (and knowing  $\varphi$ ), all players perform a Bayes update of  $\mu^*$  to a conditional distribution  $\mu_\sigma \in \Delta(\Theta)$ . The conditional probability of  $\theta \in \Theta$  when receiving signal  $\sigma$  is given by

$$\mu_{\theta,\sigma} = \frac{\varphi_{\theta,\sigma}}{\varphi_\sigma}.$$

Indeed, every signaling scheme  $\varphi$  can be seen as a convex decomposition of  $\mu^*$  into distributions  $\mu_\sigma$ , i.e., for every  $\theta \in \Theta$

$$\mu_\theta^* = \sum_{\sigma} \varphi_{\theta,\sigma} = \sum_{\sigma} \varphi_\sigma \cdot \mu_{\theta,\sigma}.$$

After this update, the player populations choose a strategy distribution  $x \in \mathcal{X}$ . The next definitions apply for every distribution  $\mu \in \Delta(\Theta)$ . Given  $\mu$ , the *expected cost of an element*  $e \in E$  is

$$c_e(x_e | \mu) = \sum_{\theta \in \Theta} \mu_\theta \cdot c_e^\theta(x_e).$$

The (*individual*) *expected cost of a player* of population  $i \in R$  choosing strategy  $S \in \mathcal{S}_i$  is given by

$$\pi_{i,S}(x | \mu) = \sum_{e \in S} c_e(x_e | \mu).$$

A strategy distribution  $x \in \mathcal{X}$  is a *Wardrop equilibrium* if no player has an incentive to change its chosen strategy. Formally, given  $\mu$ , no player shall improve its expected cost by deviating to another strategy, i.e.,

$$\pi_{i,S}(x | \mu) \leq \pi_{i,T}(x | \mu) \quad \text{for all } i \in R, \text{ all } S, T \in \mathcal{S}_i \text{ with } x_{i,S} > 0.$$

The next result for non-atomic games with a single state (cf. [6]) straightforwardly carries over to the setting considered in this paper in the following sense.

**Proposition 1.** *Given any distribution  $\mu \in \Delta(\Theta)$ , a strategy distribution  $x \in \mathcal{X}$  is a Wardrop equilibrium if and only if*

$$x \in \arg \min \left\{ \sum_{e \in E} \int_0^{y_e} c_e(t | \mu) dt : y \in \mathcal{X} \right\}.$$

Since all cost functions  $c_e^\theta$  are convex, so are their convex combinations  $c_e(x | \mu)$ . Hence, the optimization problem in Proposition 1 is strictly convex and has a unique solution, i.e., the Wardrop equilibrium

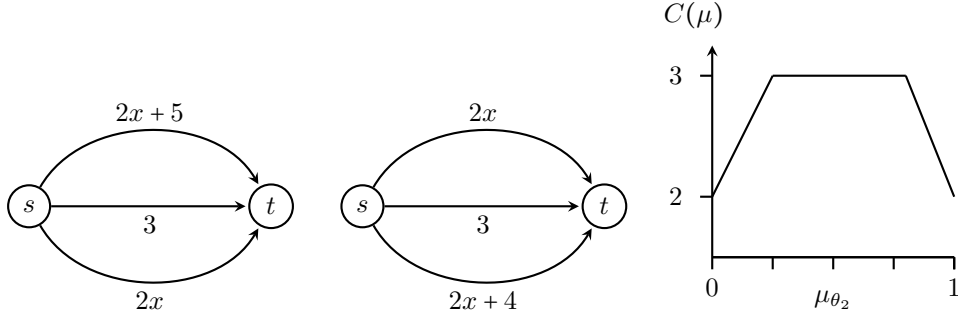

Figure 1: Cost functions in states  $\theta_1$  (left) and  $\theta_2$  (middle) in Example 1. Right: Cost  $C(\mu)$  of the Wardrop equilibrium as a function of the distribution, described by parameter  $\mu_{\theta_2} = 1 - \mu_{\theta_1} \in [0, 1]$ .

is unique. In the following, we denote by  $x^*(\mu)$  the unique Wardrop equilibrium for a distribution  $\mu \in \Delta(\Theta)$ . Let further

$$C(x | \mu) = \sum_{e \in E} x_e c_e(x_e | \mu)$$

denote the total cost of a strategy distribution  $x$  for  $\mu \in \Delta(\Theta)$ . For the Wardrop equilibrium for  $\mu \in \Delta(\Theta)$ , we use the short notation  $C(\mu) = C(x^*(\mu) | \mu)$ .

The goal of the principal is to choose  $\varphi$  in order to minimize the total expected cost of the Wardrop equilibrium among the player populations for the conditional distributions  $\mu_\sigma$  resulting from all signals  $\sigma$ , i.e.,

$$C(\varphi) = \sum_{\sigma \in \Sigma} \varphi_\sigma \cdot C(\mu_\sigma).$$

**Network Congestion Games.** In *network* congestion games, the resources in  $E$  are edges in a directed graph  $G = (V, E)$ . The strategy space  $\mathcal{S}_i$  for each population  $i \in R$  is given by all directed paths in  $G$  between a source vertex  $s_i \in V$  and a target vertex  $t_i \in V$ . Note that sources and targets of different populations do not have to be distinct vertices. Additionally every population  $i \in R$  is associated with some demand  $d_i \geq 0$  which represents the size of population  $i$ . A network congestion game is represented compactly by the graph  $G$ , vertex labels for all sources and targets of all  $i \in R$ , demands  $d_i \geq 0$  for all  $i \in R$ , and parameters of the cost functions  $c_e^\theta$ , for each  $e \in E$  and  $\theta \in \Theta$ , along with the probabilities  $\mu_\theta^*$  for each  $\theta \in \Theta$ . This input avoids an explicit description of all  $s_i$ - $t_i$ -paths in  $\mathcal{S}_i$ , for each  $i \in R$ .

## 1.2 Contribution

Let us first illustrate the concepts and the problem in the following simple example.

*Example 1.* Consider a single-commodity network with two vertices  $V = \{s, t\}$  and three parallel links  $E = \{e_1, e_2, e_3\}$ . There are two states  $\theta_1$  and  $\theta_2$ . The volume of the population is  $d_1 = 1$ . The cost functions  $c_{e_i}^{\theta_1}$  and  $c_{e_i}^{\theta_2}$  are given in Fig. 1.

We analyze the Wardrop equilibrium for all distributions  $\mu \in \Delta(\Theta)$ , where  $\Delta(\Theta)$  is interpreted as the unit interval for  $\mu_{\theta_2} = 1 - \mu_{\theta_1} \in [0, 1]$ . For  $\mu_{\theta_2} \in [0, 1/4]$ , the equilibrium only uses the lowest link, since the total cost for a volume of 1 is at most 3, whereas both other links have an offset of at least 3. For  $\mu_{\theta_2} \in [1/4, 2/5]$ , the equilibrium uses only the two lower links, since the upper link has an offset of at least 3. For  $\mu_{\theta_2} \in [2/5, 3/4]$  the equilibrium uses all three links. Then, for  $\mu_{\theta_2} \in [3/4, 4/5]$ , the equilibrium uses only the two upper links, since the offset of the lowest link is too high. Finally, for  $\mu_{\theta_2} \in [4/5, 1]$ , only the upper link is used. Fig. 1 shows the cost  $C(\mu)$  of the resulting Wardrop equilibrium for all  $\mu \in \Delta(\Theta)$ . Clearly, we see that  $C(\mu)$  is piecewise linear and concave over  $\Delta(\Theta)$ .

A signaling scheme  $\varphi$  is a convex decomposition of  $\mu^*$  into distributions  $\mu_\sigma \in \Delta(\Theta)$ , and  $C(\varphi)$  is a convex combination of  $C(\mu_\sigma)$ . Since the cost is concave over  $\Delta(\Theta)$ , we know that

$$C(\mu_{\theta_2}) \geq \mu_{\theta_2} \cdot C(1) + (1 - \mu_{\theta_2}) \cdot C(0), \quad \text{for all } \mu_{\theta_2} \in [0, 1].$$

This shows that, instead of mixing states into a signal with some interior distribution  $\mu \in (0, 1)$ , we rather want to send signals with  $\mu \in \{0, 1\}$  that *fully reveal the information* about the state of nature.

This can only improve the overall cost of  $C(\varphi)$ . Therefore, there is an optimal signaling scheme in which the principal sends an exclusive signal  $\sigma_i$  for each  $\theta_i$ , with  $i = 1, 2$ . ■

We say a signaling scheme  $\varphi$  has *full information revelation* if there is a signal for every state that is sent if and only if the state occurs, i.e.,  $|\Sigma| = |\Theta|$  and  $\varphi(\theta_j, \sigma_k) = \mu_{\theta_j}^*$ , if  $j = k$  and  $\varphi(\theta_j, \sigma_k) = 0$ , otherwise. Our main result (Section 2) is a characterization of the network structures, which guarantee optimal signaling schemes with full information revelation for single-commodity games. In particular, for every game with affine costs and unknown offsets, we show that the cost of the Wardrop equilibrium is a piecewise linear function of the distribution  $\mu$ . For series-parallel graphs, we show that it is also concave. Hence, there is always an optimal signaling scheme with full information revelation. This characterization is tight – we show that for every single-commodity network that is not series-parallel, we can construct an instance of signaling with affine costs and unknown offsets, in which a fully informative signaling scheme is truly suboptimal.

The characterization does not extend to multi-commodity networks – not even for parallel links. Consider the following example for two commodities and two parallel links.

*Example 2.* There are two vertices  $V = \{s, t\}$ , two parallel links  $E = \{e_1, e_2\}$  and  $r = 2$  populations. Each population has volume  $d_1 = d_2 = 1/2$ . Population 1 is restricted to  $\mathcal{S}_1 = \{e_1\}$ . Population 2 can route on both  $\mathcal{S}_2 = \{e_1, e_2\}$ . There are two states  $\theta_1$  and  $\theta_2$ . The cost functions are  $c_{e_1}^{\theta_1}(x) = x$  and  $c_{e_2}^{\theta_1}(x) = 1$ , as well as  $c_{e_1}^{\theta_2}(x) = x + 1$  and  $c_{e_2}^{\theta_2}(x) = 1/2$ . The prior is  $\mu_{\theta_1}^* = \mu_{\theta_2}^* = 1/2$ .

First consider  $\varphi$  with full information revelation. For state  $\theta_1$ , both populations choose link  $e_1$  entirely, with a total cost of 1. For state  $\theta_2$ , population  $i$  routes entirely on link  $e_i$ , for  $i = 1, 2$ , and the total cost is also 1. The overall cost is  $C(\varphi) = 1$ .

Now consider a “no signal” scheme  $\varphi_n$  that always issues the same signal  $\sigma$  with  $\mu_\sigma = \mu^*$ . The links have cost  $c_{e_1}(x | \mu^*) = x + 1/2$  and  $c_{e_2}(x | \mu^*) = 3/4$ . Hence, population  $i$  fully routes on link  $e_i$ , for  $i = 1, 2$ , and the total expected cost is  $C(\varphi_n) = (1 + 3/4)/2 < 1$ . ■

The next example shows that the characterization also does not apply to general stochastic affine functions.

*Example 3.* There are two vertices  $V = \{s, t\}$ , two parallel links  $E = \{e_1, e_2\}$ , and two states  $\theta_1$  and  $\theta_2$  which each appears with prior probability  $\mu_{\theta_1}^* = \mu_{\theta_2}^* = 1/2$ . The cost functions are  $c_{e_1}^{\theta_1}(x) = 1$  and  $c_{e_2}^{\theta_1}(x) = x$ , as well as  $c_{e_1}^{\theta_2}(x) = x$  and  $c_{e_2}^{\theta_2}(x) = 2$ . The optimal public signal is to always signal  $\theta_1$  in the first state, but to signal  $\theta_2$  with probability  $3/4$  and  $\theta_1$  with probability  $1/4$  in the second state. In particular, full information revelation is not optimal. ■

Finally, the characterization also does not extend to monomials with stochastic delays.

*Example 4.* There are two vertices  $V = \{s, t\}$ , two parallel links  $E = \{e_1, e_2\}$ , and two states  $\theta_1$  and  $\theta_2$  which each appears with prior probability  $\mu_{\theta_1}^* = \mu_{\theta_2}^* = 1/2$ . The cost functions are  $c_{e_1}^{\theta_1}(x) = x^2$  and  $c_{e_2}^{\theta_1}(x) = x^2 + 1$ , as well as  $c_{e_1}^{\theta_2}(x) = x^2 + 1$  and  $c_{e_2}^{\theta_2}(x) = x^2$ . Full information revelation yields a cost of 1 for each state. However, a “no signal” scheme splits the Wardrop flow equally and, hence, obtains costs of  $3/4$  for both edges. Thus, full information revelation is not optimal. ■

In Section 3.1 we consider the general problem of computing optimal signaling schemes in multi-commodity games. We carefully design a linear program that implies a reduction: An optimal scheme  $\varphi$  can be obtained from a polynomial-sized (super-)set of the *support sets* (i.e., the sets of links with  $x_{e,i} > 0$ ) for the Wardrop equilibria of every signal in  $\varphi$ . Hence, the hardness of finding good signaling schemes [8] is caused by the difficulty of good *support selection* for the emerging Wardrop equilibria. While we show in Appendix B that there are instances with an exponential number of supports that appear in the Wardrop equilibrium, we also provide in Appendix C experimental evidence from a stylized version of the road network of Sioux Falls that suggests that the number of different supports of the Wardrop equilibrium is relatively small (i.e., a low two-digit number), making this approach to compute optimal signals viable for real-world networks.

In Section 3.2 we then present a support enumeration approach to obtain equilibrium supports for all  $\mu \in \Delta(\Theta)$ . For games with two states, we show that all supports of Wardrop equilibria can be enumerated in output-polynomial time. Unfortunately, we show that even for games with two states, there can be exponentially many supports that arise in a Wardrop equilibrium for some  $\mu \in \Delta(\Theta)$ . For parallel links, we exploit the ordinal structure of support sets and apply a cell decomposition technique to bound (and compute) the set of supports for all  $\mu \in \Delta(\Theta)$ . Our approach results in a polynomial-time algorithm to enumerate all supports whenever we have a constant number of populations and a constant number of states. Hence, under these conditions, we can even compute an optimal signaling scheme in polynomial time.

### 1.3 Related Work

The idea of signaling or *Bayesian persuasion* goes back to early work of Aumann and Maschler [3], the area started to receive substantial interest after the seminal work of Kamenica and Gentzkow [38]. Characterizing and computing good signaling schemes has been of interest recently for a number of applications (such as, e.g., [25, 5, 26]), involving diverse aspects such as, e.g., limited signals [24, 31], multiple receivers and private signals [49, 2, 53], online optimization [33, 32], learning [10, 12, 55] and others.

In contrast, results on signaling for congested networks are rather scarce and anecdotal. As discussed above, Bhaskar et al. [8] show that it is NP-hard to compute a signaling policy that approximates the total expected travel time better than a factor of  $(4/3 - \varepsilon)$  for any  $\varepsilon > 0$ . Das et al. [20] examine two concrete networks, one reminiscent of a Pigou network and one reminiscent of a Braess network and compute the optimal signaling policy for the non-atomic game. Vasserman et al. [52] define the mediation ratio as the expected cost of the best mediated equilibrium and the expected cost of the (realization-wise) optimal flow. They provide several upper bounds on the mediation ratio for networks of parallel links and additional assumptions on the dependence of  $c_e^\theta$  on  $\theta$ . Castiglioni et al. [11] study a related model for atomic congestion games, where the players have to commit to follow the mediator's recommendation before receiving the signal. Their positive results are contrasted by recent work of Zhou et al. [54] for singleton games in the standard signaling model.

## 2 Full Information Revelation

In this section, we show that for a single-commodity network congestion game it is always optimal to fully reveal the state of nature to the players of the population if and only if the underlying network is a series-parallel graph. For the positive part of this characterization, we show that for series-parallel graphs, the cost of the unique Wardrop equilibrium as a function of the distribution  $\mu \in \Delta(\Theta)$  is concave in  $\mu$ .

We first prove that for general single-commodity network congestion games, the cost of the unique Wardrop equilibrium with respect to  $c_e(\cdot | \mu)$  is piecewise linear in  $\mu \in \Delta(\Theta)$ . Let  $x$  be a flow. For  $v \in V$ , let  $\psi_v$  be the length of a shortest path with respect to  $c_e(x_e | \mu)$  from  $s$  to  $v$ . We call an edge  $e = (v, w)$  *active* in  $x$  if  $\psi_w - \psi_v = c_e(x_e | \mu)$ . Clearly, for every flow  $x$ , the set of active edges is connected and such every vertex  $v$  is reached by a path of active edges from  $s$ . Let

$$\mathcal{A} = \{A \subseteq E \mid G = (V, A) \text{ is connected}\}.$$

be the edges with that property, and let  $A(x)$  be the set of active edges for a flow  $x$ . In the following, we call—somewhat misleadingly—a set  $A \in \mathcal{A}$  a *support*.

**Lemma 1.** *For a single-commodity network congestion game, the unique Wardrop equilibrium flow and the cost of the unique Wardrop equilibrium are piecewise linear in  $\mu$ . In particular, for every  $A \in \mathcal{A}$ , there is a possibly empty polytope  $P_A \subseteq \Delta(\Theta)$  such that  $P_A = \{\mu \in \Delta(\Theta) \mid A(x^*(\mu)) = A\}$  and  $x^*$  and  $C$  are affine on  $P_A$ .*

*Proof.* Define the balance vector  $\beta = (\beta_v)_{v \in V}$  as

$$\beta_v = \begin{cases} d & \text{if } v = s \\ -d & \text{if } v = t \\ 0 & \text{otherwise} \end{cases} \quad \text{for all } v \in V.$$

By Proposition 1, the Wardrop equilibrium  $x^*$  is the optimal solution to the optimization problem

$$\begin{aligned} \text{Min.} \quad & \sum_{e \in E} \int_0^{x_e} c_e(z | \mu) dz \\ \text{s.t.} \quad & \sum_{e \in \delta^+(v)} x_e - \sum_{e \in \delta^-(v)} x_e = \beta_v && \text{for all } v \in V, \\ & x_e \geq 0 && \text{for all } e \in E. \end{aligned}$$

By the Karush-Kuhn-Tucker optimality conditions (see Theorem 6 in Appendix A for a reference), a flow  $x = (x_e)_{e \in E}$  is optimal if and only if it is feasible and there is a dual vector  $\pi = (\pi_v)_{v \in V}$  such that

$$c_e(x_e | \mu) = \pi_w - \pi_v \quad \text{for all } e = (v, w) \in E \text{ with } x_e \neq 0,$$

$$c_e(x_e \mid \mu) \geq \pi_w - \pi_v \quad \text{for all } e = (v, w) \in E \text{ with } x_e = 0.$$

The dual variables are clearly invariant under additive shifts. Thus it is without loss of generality to assume that  $\pi_s = 0$ . Using that  $c_e(x_e \mid \mu) = a_e x_e + \sum_{\theta \in \Theta} \mu_\theta b_e^\theta$ , we conclude that a Wardrop equilibrium with a fixed support  $A \subseteq \mathcal{A}$  satisfies the following equations

$$\pi_v + a_e x_e + \sum_{\theta \in \Theta} \mu_\theta b_e^\theta = \pi_w \quad \text{for all } e \in A, \quad (1a)$$

$$\sum_{e \in \delta^+(v)} x_e - \sum_{e \in \delta^-(v)} x_e = \beta_v \quad \text{for all } v \in V, \quad (1b)$$

$$\pi_s = 0. \quad (1c)$$

as well as the inequalities

$$\pi_v + a_e x_e + \sum_{\theta \in \Theta} \mu_\theta b_e^\theta \geq \pi_w \quad \text{for all } e \in E \setminus A, \quad (2a)$$

$$x_e \geq 0 \quad \text{for all } e \in E. \quad (2b)$$

We claim that for all  $A \in \mathcal{A}$ , the linear system (1) has full rank. To see this, let  $\Gamma \in \mathbb{R}^{V \times E}$  be the incidence matrix of the subgraph  $G_A$ , i.e.,  $\Gamma = (\gamma)_{v \in V_A, e \in A}$  defined as  $\gamma_{v,e} = 1$ , if  $e \in \delta^-(v)$ ,  $\gamma_{v,e} = -1$  if  $e \in \delta^+(v)$ , and  $\gamma_{v,e} = 0$ , otherwise. Let  $D \in \mathbb{R}^{E \times E} = \text{diag}(a_1, \dots, a_k)$  with  $k = |A|$  be the diagonal matrix with the slopes of the cost function of the edges on the diagonal. Eliminating  $\pi_s = 0$ , the system (1) can be written as

$$\begin{bmatrix} D & \hat{\Gamma}^\top \\ \hat{\Gamma} & \mathbf{0} \end{bmatrix} \begin{bmatrix} \hat{\pi} \\ x \end{bmatrix} = \begin{bmatrix} -\sum_{\theta \in \Theta} \mu_\theta b^\theta \\ \hat{\beta} \end{bmatrix}, \quad (3)$$

where  $\hat{\pi}$  is the vector of vertex potentials with the entry for  $s$  removed,  $\hat{\Gamma}$  is the incidence matrix with the row for  $s$  removed, and  $\hat{\beta}$  is the vector  $\beta$  with the entry for  $s$  removed. Using Schur complements, we obtain the matrix on the left hand side of (3) is invertable if and only if  $\hat{L} := \hat{\Gamma}^\top D \hat{\Gamma}$  is invertible; see, e.g., the textbook by Harville [35, Theorem 8.5.11]. The matrix  $\hat{L}$  is a weighted Laplacian matrix of a connected graph (with the entry for  $s$  removed) which is known to have full rank. This implies that for fixed  $\mu$ , there is a unique solution  $x$  satisfying (1) and a unique value for  $\pi_t$ .

The equations (1) together with the inequalities (2) together with  $\sum_{\theta \in \Theta} \mu_\theta = 1$  and  $\mu \geq 0$  define a polytope of all vectors  $(\mu, x, \pi) \in \mathbb{R}^{\Theta \times E \times V}$  such that  $\mu \in \Delta(\Theta)$  is a distribution,  $x$  is a corresponding Wardrop equilibrium with support  $A$ , and  $\pi$  is a corresponding vector of vertex potentials. Since the projection of a polytope is a polytope again the set  $P_A$  is a polytope as well.

Observe that (1) gives a system of linear equations which, for fixed  $\mu$ , have a unique solution in  $x$ . Thus, the Wardrop equilibrium  $x^*(\mu)$  is an affine function in  $\mu$  on  $P_A$ . To see that also the cost of the Wardrop equilibrium is affine on  $P_A$  note that the cost of the Wardrop equilibrium is given by  $d\pi_t$  and, hence, the result follows.  $\square$

We obtain from Lemma 1, that the cost of the Wardrop equilibrium  $C$  is a piecewise linear function on  $\Delta(\Theta)$ . In the following, we will work towards showing that for a series-parallel network, the cost is concave in  $\Delta(\Theta)$ .

Formally, a graph  $G = (V, E)$  with two designated vertices  $s, t \in V$  is a series-parallel graph if it either consists only of a single edge  $E = \{(s, t)\}$ , or it is obtained by a parallel or series composition of two series-parallel graphs. For two series-parallel graphs  $G_1 = (V_1, E_1)$  and  $G_2 = (V_2, E_2)$  with designated vertices  $s_1, t_1 \in V_1$  and  $s_2, t_2 \in V_2$  the *parallel composition* is the graph  $G = (V, E)$  created from the disjoint union of graphs  $G_1$  and  $G_2$  by merging the vertices  $s_1$  and  $s_2$  into a new vertex  $s$ , and merging the vertices  $t_1$  and  $t_2$  into a new vertex  $t$ . The *series composition* of  $G_1$  and  $G_2$  is the graph created from the disjoint union of graphs  $G_1$  and  $G_2$  by merging vertices  $t_1$  and  $s_2$ , and renaming  $s_1$  into  $s$  and  $t_2$  into  $t$ . In the following, we treat series-parallel graphs as directed graphs by directing every edge in the orientation as it appears in any path from  $s$  to  $t$ . This is well-defined since in a series-parallel graph, there is a global order on the vertices such that every path only visits vertices in increasing order.

The general idea of the proof of the concavity of  $C$  on  $\Delta(\Theta)$  is as follows. In Lemma 1, we have shown that  $C$  is affine on  $P_A$  for all  $A \in \mathcal{A}$ , i.e., there are affine functions  $C_A : \Delta(\Theta) \rightarrow \mathbb{R}_{\geq 0}$  such that  $C_A(\mu) = C(\mu)$  for all  $\mu \in P_A$ . Intuitively, for  $\mu \in P_A$ ,  $C_A(\mu)$  is the unique solution  $\pi_t$  for the system of equations (1). Let furthermore  $x_A^* : \Delta(\Theta) \rightarrow \mathbb{R}^E$  be an affine function such that  $x^*(\mu) = x_A^*(\mu)$  for all  $\mu \in P_A$ . Again for  $\mu \in P_A$ ,  $x_A^*$  is the unique solution  $x$  for the system of equations (1). It is important

to note that while  $x^*(\mu) = x_A^*(\mu)$  for all  $\mu \in P_A$ , the vector  $x_A^*(\mu)$  will not be a Wardrop equilibrium or even not be a feasible flow at all when  $\mu \in \Delta(\Theta) \setminus P_A$ . The reason for this is that for  $\mu \in \Delta(\Theta) \setminus P_A$  one of the inequalities in (2) is violated. If an inequality of type (2a) is violated (but none of the other inequalities), the flow is feasible, but not a Wardrop equilibrium since there is an edge outside of the support that would decrease the cost. On the other hand, if an inequality of type (2b) is violated, then the flow is not feasible.

In the following, we show that the pointwise minimum  $\min_{A \in \mathcal{A}} C_A(\mu)$  of all Wardrop equilibria costs always corresponds to a support that is feasible. More specifically, we show that when for some  $\mu \in \Delta(\Theta)$ , there is a support  $A \in \mathcal{A}$  with  $\mu \notin P_A$ , then there is another support  $A' \in \mathcal{A}$  with  $C_{A'}(\mu) < C_A(\mu)$ .

**Lemma 2.** *For a series-parallel graph, let  $A \in \mathcal{A}$  and  $\mu \in \Delta(\Theta) \setminus P_A$ . Then, there is another support  $A' \in \mathcal{A}$  with  $C_{A'}(\mu) < C_A(\mu)$  or  $C_{A'}(\mu) = C_A^*(\mu)$  and  $|A'| < |A|$ .*

*Proof.* We prove the statement by induction over  $|E|$ .

For  $|E| = 1$  the graph has only a single edge  $e = \{s, t\}$ . The only support  $A \in \mathcal{A}$  is  $A = E$ . Clearly,  $P_E = \Delta(\Theta)$  and the statement holds trivially since there is no  $\mu \in \Delta(\Theta) \setminus P_E$ .

Fix  $k \in \mathbb{N}$  and suppose that the statement of the lemma holds for all series-parallel graphs with up to  $k$  edges. Consider a series-parallel graph  $G = (V, E)$  with  $k + 1$  edges. Since  $G$  is series-parallel, there is a series of serial and parallel compositions of smaller series-parallel graphs that ends in  $G$ . In particular,  $G$  is constructed either by a final serial decomposition of two smaller series-parallel graphs  $G_1 = (V_1, E_1)$  and  $G_2 = (V_2, E_2)$ , or by a final parallel composition of  $G_1$  and  $G_2$ . We proceed to distinguish these two cases.

**First case: Final composition is serial.** Let  $A \in \mathcal{A}$  with  $\mu \in \Delta(\Theta) \setminus P_A$  be given. This implies that either an inequality of type (2a) or an inequality of type (2b) is violated, i.e., either there is an edge  $e \in E$  with  $(x_A^*)_e < 0$  or there is an edge  $e = \{v, w\} \in E$  with  $c_e((x_A^*)_e) < \pi_w - \pi_v$ .

It is without loss of generality to assume that  $e \in E_1$ . Let  $A_1 = A \cap E_1$  and  $A_2 = A \cap E_2$ . For  $j \in \{1, 2\}$ , we denote by  $\mathcal{A}_j$  the set of supports for  $G_j$  such that the corresponding subgraph is connected. We have  $A_j \in \mathcal{A}_j$  for all  $j \in \{1, 2\}$ .

The graph  $G_1 = (V_1, E_1)$  has at most  $k$  edges, so we can apply the induction hypothesis on  $G_1$  and obtain another support  $A'_1 \in \mathcal{A}_1$  such that  $C_{A'_1}^{*,1}(\mu) < C_{A_1}^{*,1}(\mu)$  where for a support  $T \in \mathcal{A}_j$  the function  $C_T^{*,j}(\cdot)$  refers to the cost of the solution of the linear system (1) with support  $T$  for  $G_j$ . Since  $G_1$  and  $G_2$  were composed in series we have for any support  $T \in \mathcal{A}$  that

$$C_T^*(\mu) = C_{T \cap E_1}^{*,1}(\mu) + C_{T \cap E_2}^{*,2}(\mu).$$

So, defining  $A' = A'_1 \cup A_2 \in \mathcal{A}$  we obtain

$$C_{A'}(\mu) = C_{A'_1}^{*,1}(\mu) + C_{A_2}^{*,2}(\mu) < C_{A_1}^{*,1}(\mu) + C_{A_2}^{*,2}(\mu) = C_A^*(\mu),$$

as required.

**Second case: Final composition is parallel.** Let again  $A \in \mathcal{A}$  with  $\mu \in \Delta(\Theta) \setminus P_A$  be given. Again, this implies that either there is an edge  $e \in E$  with  $(x_A^*)_e < 0$  or there is an edge  $e = \{v, w\} \in E$  with  $c_e((x_A^*)_e) < \pi_w - \pi_v$ . It is without loss of generality to assume that  $e \in E_1$ .

For  $j \in \{1, 2\}$ , let  $\lambda_j = \sum_{e \in \delta^+(s) \cap E_j} (x_A^*)_e - \sum_{e \in \delta^-(s) \cap E_j} (x_A^*)_e$  be the total flow in  $G$  send over the parallel component  $G_j$ . We have  $\lambda_1 + \lambda_2 = d$ .

Let us first assume that  $\lambda_1 < 0$ . This implies  $A_1 \in \mathcal{A}_1$ , since there is a non-zero flow in that component, and, thus,  $t$  can be reached from  $s$ . Let  $A'_1 = A_1 \setminus (\delta^+(t) \cap E_1)$ . Since  $\lambda_1 < 0$ , we have  $\lambda_2 > 1$  and, thus, there is a path from  $s$  to  $t$  in  $A_2$  and, in particular  $A' = A'_1 \cup A_2 \in \mathcal{A}$ .

In the following we write  $\lambda'_j$  and  $\pi'_v$  for the values of  $\lambda_j$  and  $\pi_v$  for the new support  $S'$ . Then, we have  $\lambda'_1 = 0$  and, hence  $\lambda'_2 = 1$ . As shown by Klimm and Warode [40, Corollary 4], the per-unit cost  $\pi_t$  of an equilibrium flow (i.e., a flow that satisfies the linear system (1) for a fixed support) is strictly increasing in  $\lambda$ . (This follows from the fact that the inverse of a Laplace matrix is positive.) Hence  $\pi'_t < \pi_t$ . Since  $C_S(\mu) = \pi_t d$ , the result follows.

Next, let us assume that  $\lambda_1 = 0$ . In that case, a potential issue is that  $A_1$  may not be contained in  $\mathcal{A}_1$  since there may not be a path from  $s$  to  $t$  in  $A_1$ . As a consequence, we may not be able to apply the induction hypothesis on  $G_1$ .



If the edge  $e$  violates the inequality  $c_e((x_A^*)_e) \geq \pi_w - \pi_v$ , we let  $A'_1 = A_1 \cup \{e\}$  and  $A' = A'_1 \cup A_2$ . Now,  $G_1$  contains a path from  $s$  to  $t$  with length with respect to  $(x_A^*)_e$  that is strictly less than  $\pi_t$ . Since  $\pi_t$  is continuous and increasing in the flow, for the equilibrium flow for  $A'$ , we have  $\lambda'_1 > 0$  and  $\lambda'_2 < 1$ . Hence,  $\pi'_t < \pi_t$  and the results follows.

If the edge  $e$  violates the inequality  $(x_A^*)_e \geq 0$ , we let  $A'_1 = A_1 \setminus \{e\}$  and  $A = A_1 \cup A_2$ . Since there was no flow in  $G_1$  anyway this has no impact on the cost of the flow which is equal to  $\pi_t d$ , and we have constructed a support  $A'$  with  $C_{A'}(\mu) = C_A(\mu)$  and  $|A'| < |A|$ .

Finally, let us assume that  $\lambda_1 > 0$ . Then  $A_1 \in \mathcal{A}_1$  and we can apply the induction hypothesis on  $G_1$  and obtain a support  $A'_1$  for  $G_1$  such that either  $C_{A'_1}(\mu) < C_{A_1}(\mu)$  or  $C_{A'_1}(\mu) = C_{A_1}(\mu)$  and  $|A'_1| < |A_1|$ . We let  $A' = A'_1 \cup A_2$ . In the latter case, we have  $|A'| < |A|$  and  $C_{A'}(\mu) = C_A(\mu)$  and we are done. The result then follows from the monotonicity of the flows since we have  $\lambda'_1 > \lambda_1$  and, hence  $\lambda'_2 < \lambda_2$  and, thus, the per unit cost in  $G_2$  decreased.  $\square$

As a consequence of this lemma, we obtain that the flows  $x^*$  that correspond to the pointwise minimum  $\min_{S \in \mathcal{A}} C_S(\mu)$  where ties in the cost are broken in favor of smaller supports is a Wardrop equilibrium.

**Lemma 3.** *We have  $C(\mu) = \min_{A \in \mathcal{A}} C_A^*(\mu)$  for all  $\mu \in \Delta(\Theta)$ .*

*Proof.* Let  $\mu \in \Delta(\Theta)$  be arbitrary and let  $A \in \mathcal{A}$  be such that  $C_A(\mu) \leq C_{A'}(\mu)$  for all  $A' \in \mathcal{A}$  and  $|A| < |A'|$  for all  $A' \in \mathcal{A}$  with  $C_A(\mu) = C_{A'}(\mu)$ . As shown in Lemma 2, if  $x_A^*$  violates one of the inequalities in (2), then there is a support  $A'' \in \mathcal{A}$  with  $C_{A''}(\mu) < C_A(\mu)$  or  $C_{A''}(\mu) = C_A(\mu)$  and  $|A''| < |A|$ . This contradicts the choice of  $A$ .  $\square$

We obtain the main result of this section.

**Theorem 1.** *Full information revelation is an optimal signaling scheme for single-commodity games with series-parallel graphs and affine costs with unknown offsets.*

*Proof.* A signaling scheme  $\varphi$  is a convex decomposition of  $\mu^*$  into distributions  $\mu_\sigma \in \Delta(\Theta)$ , and  $C(\varphi)$  is a convex combination of  $C(\mu_\sigma)$ , i.e.,

$$C(\varphi) = \sum_{\sigma \in \Sigma} \varphi_\sigma \cdot C(\mu_\sigma).$$

Since  $C(\mu)$  is concave in  $\mu$  the best convex decomposition of the prior occurs when  $\mu_{\sigma_j} = \chi_{\theta_j}$  for all  $j \in [|\Theta|]$ , where  $\chi_{\theta_j}$  is the indicator vector for state  $\theta_j$ .  $\square$

In order to prove that full information revelation is optimal if and only if the graph is series-parallel we first give an example for which it is not an optimal scheme.

*Example 5.* Consider the graph shown in Figure 2a with cost functions

$$c_e^{\theta_j}(x) = \begin{cases} x & e \in \{e_1, e_4\}, j = 1, 2 \\ 1 & e \in \{e_2, e_3\}, j = 1, 2 \\ 0 & e = e_5, j = 1 \\ 1 & e = e_5, j = 2 \end{cases}$$

Note that only the cost of edge  $e_5$  changes in the different states.

We claim that full information revelation is suboptimal in this example. Consider the two different supports  $A_1 = \{e_1, e_2, e_3, e_4\}$  and  $A_2 = \{e_1, e_2, e_3, e_4, e_5\}$ . For support  $A_1$  we obtain the Wardrop equilibrium  $x_{e_1} = x_{e_2} = x_{e_3} = x_{e_4} = 1/2$  for all  $\mu \in \Delta(\Theta)$  and for support  $A_2$  we obtain the flow  $x_{e_1} = x_{e_4} = 1 - \mu_{\theta_2}$ , and  $x_{e_2} = x_{e_3} = \mu_{\theta_2}$ , and  $x_{e_5} = 1 - 2\mu_{\theta_2}$ , for all  $\mu \in \Delta(\Theta)$ . This yields the following cost for the supports:

$$C_{A_1}(\mu) = 2 \cdot \frac{1}{2} \cdot \frac{1}{2} + 2 \cdot \frac{1}{2} = \frac{3}{2},$$

$$C_{A_2}(\mu) = 2 \cdot (1 - \mu_{\theta_2}) \cdot (1 - \mu_{\theta_2}) + 2 \cdot \mu_{\theta_2} + (1 - 2\mu_{\theta_2}) \cdot \mu_{\theta_2} = 2 - \mu_{\theta_2}.$$

However, for any  $\mu_{\theta_2} < 1/2$  the flow defined by support  $A_1$  is not a Wardrop equilibrium for the whole graph, since edge  $e_5$  violates an inequality of type (2a). Furthermore, for any  $\mu_{\theta_2} > 1/2$  the flow defined by support  $A_2$  is not a Wardrop equilibrium for the whole graph since the edge  $e_5$  violates an inequality of type (2b). Hence, the pointwise minimum is not a concave function as illustrated in Figure 2b. For

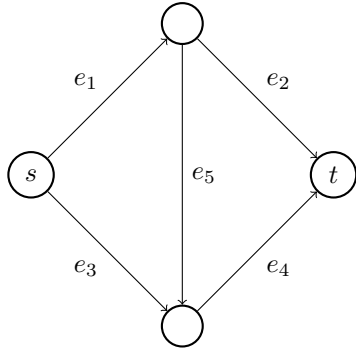

(a) The Braess graph

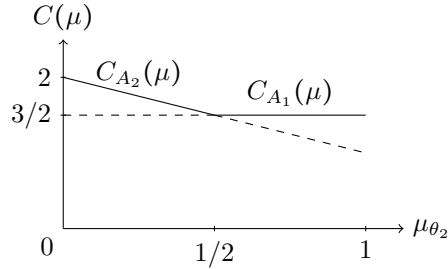

(b) The total cost of supports  $A_1$  and  $A_2$ . The functions are dashed if the supports are infeasible for the given  $\mu$ .

Figure 2: Braess network and cost of a Wardrop equilibrium as a function of  $\mu$ .

a priori of  $\mu^* = (1/2, 1/2)$ , full information revelation would yield a cost of  $1/2 \cdot 2 + 1/2 \cdot 3/2 = 7/4$ . In contrast, sending a single signal in all states does not reveal any information about the state, so that the Wardrop equilibrium  $x^*(\mu^*)$  emerges which has a cost of  $3/2$ . Hence, full information revelation is not optimal.

**Theorem 2.** *For a single-commodity network  $G$ , full information revelation is always an optimal signaling scheme if and only if  $G$  is series-parallel.*

*Proof.* The if-part follows from Theorem 1. To prove the only-if part it suffices to show that for a non-series-parallel graph there exist cost functions  $c^\theta : E \rightarrow \mathbb{R}$ ,  $\theta \in \Theta$  such that full signaling is not optimal. We call a graph with two designated vertices  $s, t \in V$  a two-terminal graph. In the following we make use of some definitions by Duffin [22]. We call two edges  $e, e' \in E$  *confluent* if there are no two (undirected) simple cycles  $C_1$  and  $C_2$  both containing  $e$  and  $e'$  such that the two edges have the same orientation in  $C_1$  and a different orientation in  $C_2$ . Further, an edge is *s-t-confluent* if it is confluent with the (virtually added) edge  $(t, s)$ . As shown by Duffin, a two-terminal graph  $G$  is series-parallel if and only if all edges are s-t-confluent. Let  $G = (V, E)$  be a two-terminal graph with source  $s \in V$  and sink  $t \in V$  such that  $G$  is not series-parallel, i.e.  $G$  is not s-t-confluent. Hence, there exist two cycles  $C_1$  and  $C_2$  which share the (virtually added) edge  $a := (t, s)$  and another edge  $b \in E$  such that  $a$  is used in the same direction in both cycles but the direction of  $b$  changes. For an illustration see cycle  $C_1 = (s, v_h, v_i, v_j, v_{j+1}, v_k, v_l, t, s)$  and  $C_2 = (s, v_h, v_k, v_{j+1}, v_j, v_i, v_l, t, s)$  in Figure 3a. Note that on the paths represented by a dotted line, there might be an arbitrary number of edges, and there may not be a single edge, but in this case the corresponding vertices are actually the same. However, on any dashed path there exists at least one edge. Next we choose an arbitrary edge on each dashed path and label it  $e_{hi}, e_{hk}, e_{il}$  and  $e_{jl}$ , respectively. We now define the cost function as follows:

$$c_e(x | \theta_1) = \begin{cases} x & \text{if } e \in \{e_{hi}, e_{kl}\}, \\ 1 & \text{if } e \in \{e_{hk}, e_{il}\}, \\ \infty & \text{if } e \in E \setminus (E[C_1] \cup E[C_2]), \\ 0 & \text{else,} \end{cases} \quad c_e(x | \theta_2) = \begin{cases} 1 & \text{if } e = b, \\ c_e(x | \theta_1) & \text{else.} \end{cases}$$

Note that only the cost of edge  $b$  depends on the state. Ignoring all edges that have cost either 0 or  $\infty$  in both states we obtain the embedded graph shown in Figure 3b. With the cost function defined above we obtain the example illustrated in Figure 2a for which we showed that full information revelation is not an optimal solution.  $\square$

### 3 Computing Optimal Signaling Schemes

In this section, we consider general multi-commodity network congestion games and affine costs with state-based offsets, and show how optimal signals for these networks can be computed with LP techniques. To this end, we first need to investigate the unique Wardrop equilibria for a fixed set of active edges for each population.

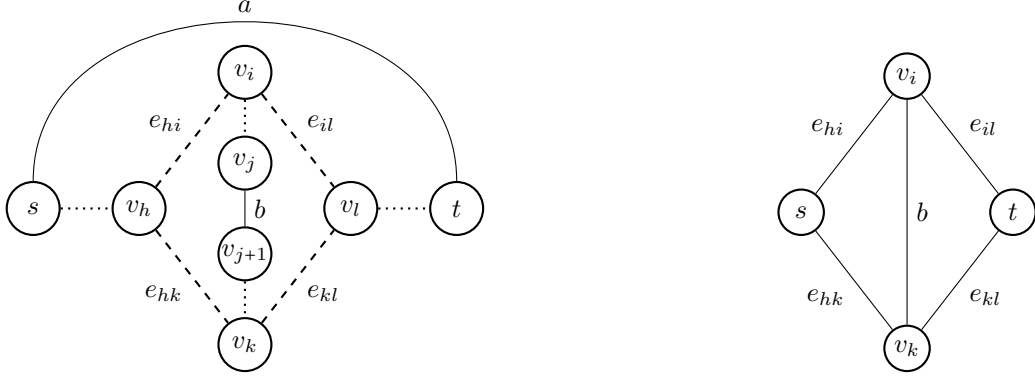

(a) The cycles  $C_1$  and  $C_2$ . Edges are bold, paths are dashed.

(b) The embedded Braess graph with  $s = v_h$  and  $t = v_k$ .

Figure 3: Illustrations for the proof of Theorem 2

### 3.1 Optimal Signaling via Optimal Support Selection

Consider a signaling scheme  $\varphi$  that issues a signal  $\sigma$ , for which the conditional distribution  $\mu_\sigma$  results in a Wardrop equilibrium  $x^* = x^*(\mu_\sigma)$  such that the set of active edges for population  $i \in R$  is  $A_i \subseteq E$ . In a Wardrop equilibrium, every population  $i$  uses only cost-optimal  $s_i$ - $t_i$ -paths. As a consequence, we can rely on the description of Wardrop flows with vertex potentials and flow-conservation constraints developed in Lemma 1. The proof of the following result is a direct adaption of Lemma 1 to the multi-commodity case and, thus, omitted.

**Lemma 4.** *For a multi-commodity network congestion game, the unique Wardrop equilibrium flow and the cost of the unique Wardrop equilibrium are piecewise linear in  $\mu$ . In particular, for every  $A = (A_1, \dots, A_r) \in \mathcal{A}^r$ , there is a possibly empty polytope  $P_A \subseteq \Delta(\Theta)$  such that  $P_A = \{\mu \in \Delta(\Theta) \mid A(x^*(\mu)) = A\}$  such that  $x^*$  and  $C$  are affine on  $P_A$ .*

Analogously to the proof of Lemma 1, we obtain that the polytope  $P_A$  is described by the following set of equations and inequalities:

$$\begin{aligned}
\pi_{u,i} + a_e x_e + \sum_{\theta} \mu_{\theta} b_e^{\theta} &= \pi_{v,i} && \text{for all } e \in A_i, i \in R, \\
\pi_{u,i} + a_e x_e + \sum_{\theta} \mu_{\theta} b_e^{\theta} &\geq \pi_{v,i} && \text{for all } e \in E \setminus A_i, i \in R, \\
x_e &= \sum_{i \in R} x_{e,i} && \text{for all } e \in E, \\
\sum_{e=(u,v) \in E} x_{e,i} - \sum_{e=(v,w) \in E} x_{e,i} &= 0 && \text{for all } v \in V \setminus \{s_i, t_i\}, i \in R, \\
\sum_{e=(s_i, u) \in A_i} x_{e,i} &= d_i && \text{for all } i \in R, \\
\sum_{\theta \in \Theta} \mu_{\theta} &= 1, \\
\mu_{\theta} &\geq 0 && \text{for all } \theta \in \Theta, \\
\pi_{s_i, i} &= 0 && \text{for all } i \in R, \\
x_{e,i} &\geq 0 && \text{for all } e \in A_i, i \in R, \\
x_{e,i} &= 0 && \text{for all } e \in E \setminus A_i, i \in R.
\end{aligned} \tag{4}$$

Turning to signaling schemes, a scheme  $\varphi$  that issues a signal  $\sigma$  with conditional distribution  $\mu_\sigma$  must satisfy the inequalities

$$\begin{aligned}
\varphi_{\theta, \sigma} &\leq \mu_{\theta}^* && \text{for all } \theta \in \Theta, \\
\varphi_{\theta, \sigma} &\geq 0 && \text{for all } \theta \in \Theta, \\
\varphi_{\theta, \sigma} &= \varphi_{\sigma} \cdot \mu_{\theta, \sigma} && \text{for all } \theta \in \Theta, \\
\varphi_{\sigma} &= \sum_{\theta \in \Theta} \varphi_{\theta, \sigma}.
\end{aligned} \tag{5}$$

If signal  $\sigma$  does not get issued, then  $\varphi_{\sigma} = 0$ , so all  $\varphi_{\theta, \sigma} = 0$ , and the conditions of (5) (and (4)) are not meaningful. Thus, we can restrict attention to signals  $\sigma$  that get issued and use  $\mu_{\theta} = \mu_{\theta, \sigma}$  in (4).

Moreover, we extend the notation of the variables  $x_e$  and  $x_{e,i}$  by  $\sigma$  and multiply all (in-)equalities of (4) by  $\varphi_\sigma > 0$ . Using  $y_{e,i,\sigma} = x_{e,i,\sigma} \cdot \varphi_\sigma$ , we obtain the polytope

$$\begin{aligned}
\pi_{u,i,\sigma} + a_e y_{e,\sigma} + \sum_{\theta} \varphi_{\theta,\sigma} b_e^\theta &= \pi_{v,i,\sigma} && \text{for all } e \in A_i, i \in R \\
\pi_{u,i,\sigma} + a_e y_{e,\sigma} + \sum_{\theta} \varphi_{\theta,\sigma} b_e^\theta &\geq \pi_{v,i,\sigma} && \text{for all } e \in E \setminus A_i, i \in R \\
y_{e,\sigma} &= \sum_{i \in R} y_{e,i,\sigma} && \text{for all } e \in E, \sigma \in [k] \\
\sum_{e=(u,v) \in E} y_{e,i,\sigma} - \sum_{e=(v,w) \in E} y_{e,i,\sigma} &= 0 && \text{for all } v \in V \setminus \{s_i, t_i\}, i \in R \\
\sum_{e=(s_i,u) \in A_i} y_{e,i,\sigma} &= d_i \cdot \sum_{\theta \in \Theta} \varphi_{\theta,\sigma} && \text{for all } i \in R \\
\pi_{s_i,i,\sigma} &= 0 && \text{for all } i \in R \\
y_{e,i,\sigma} &\geq 0 && \text{for all } e \in A_i, i \in R \\
y_{e,i,\sigma} &= 0 && \text{for all } e \in E \setminus A_i, i \in R \\
\varphi_{\theta,\sigma} &\leq \mu_\theta^* && \text{for all } \theta \in \Theta \\
\varphi_{\theta,\sigma} &\geq 0 && \text{for all } \theta \in \Theta
\end{aligned} \tag{6}$$

Clearly, this polytope always has a trivial all-zero solution. Every non-zero solution corresponds to a (partial) signaling scheme  $\varphi$  with a signal  $\sigma$  resulting in a Wardrop equilibrium with supports  $A_i$ . In particular, all signaling schemes  $\varphi$  that include such a signal form a convex polytope in the space of signaling schemes.

Now suppose we are given a set of  $k$  supports for each population  $i \in R$ , which we denote by  $A_{i,1}, \dots, A_{i,k}$ . Consider all signaling schemes  $\varphi$  that send  $k$  signals, where for simplicity we assume  $\sigma \in [k] = \{1, \dots, k\}$ . In  $\varphi$ , signal  $\sigma$  shall result in a Wardrop equilibrium  $x_\sigma$  with support  $A_{i,\sigma}$  for each population  $i \in R$ . We can describe the polytope of these schemes  $\varphi$  by combining all inequalities for individual signals in (6). In addition, we would like to find a scheme with smallest total expected cost  $C(\varphi)$ , which can be expressed as

$$\begin{aligned}
C(\varphi) &= \sum_{\theta' \in \Theta} \sum_{\sigma \in [k]} \varphi_{\theta',\sigma} \cdot C(\mu_\sigma) \\
&= \sum_{\sigma \in [k]} \sum_{\theta' \in \Theta} \varphi_{\theta',\sigma} \cdot \left( \sum_{e \in E} x_{e,\sigma} a_e x_{e,\sigma} + \sum_{\theta \in \Theta} \mu_{\theta,\sigma} x_{e,\sigma} b_e^\theta \right) \\
&= \sum_{\sigma \in [k]} \sum_{\theta' \in \Theta} \varphi_{\theta',\sigma} \cdot \left( \sum_{e \in E} \sum_{i \in R} x_{e,i,\sigma} a_e x_{e,\sigma} + \sum_{\theta \in \Theta} \mu_{\theta,\sigma} x_{e,i,\sigma} b_e^\theta \right) \\
&= \sum_{\sigma \in [k]} \sum_{\theta' \in \Theta} \varphi_{\theta',\sigma} \cdot \sum_{i \in R} d_i \cdot \left( \sum_{e \in S_{i,\sigma}} a_e x_{e,\sigma} + \sum_{\theta \in \Theta} \mu_{\theta,\sigma} b_e^\theta \right)
\end{aligned}$$

where  $S_{i,\sigma}$  is an arbitrary  $s_i$ - $t_i$ -path contained in support  $A_i$ . We then obtain

$$\begin{aligned}
C(\varphi) &= \sum_{\sigma \in [k]} \sum_{i \in R} d_i \cdot \left( \sum_{e \in S_{i,\sigma}} a_e y_{e,\sigma} + \sum_{\theta \in \Theta} \varphi_{\theta,\sigma} b_e^\theta \right) \\
&= \sum_{\sigma \in [k]} \sum_{i \in R} d_i \cdot \pi_{t_i,i,\sigma},
\end{aligned}$$

i.e., the total cost of a signaling scheme is equal to the sum of the corresponding potentials  $\pi_{t_i,i,\sigma}$  at the destination  $t_i$  for all signals  $\sigma \in \Sigma$  multiplied with the population size  $d_i$ . We here again defined  $y_{e,\sigma} = x_{e,\sigma} \cdot \sum_{\theta' \in \Theta} \varphi_{\theta',\sigma}$  similarly as above. Overall, finding an optimal signaling scheme for a given set of signal supports can be formulated as the following linear program.

$$\begin{aligned}
\text{Min.} \quad & \sum_{\sigma \in [k]} \sum_{i \in R} d_i \cdot \pi_{t_i, i, \sigma} \\
\text{s.t.} \quad & \pi_{u, i, \sigma} + a_e y_{e, \sigma} + \sum_{\theta} \varphi_{\theta, \sigma} b_e^\theta = \pi_{v, i, \sigma} && \text{for all } e \in A_i, i \in R, \sigma \in [k] \\
& \pi_{u, i, \sigma} + a_e y_{e, \sigma} + \sum_{\theta} \varphi_{\theta, \sigma} b_e^\theta \geq \pi_{v, i, \sigma} && \text{for all } e \in E \setminus A_i, i \in R, \sigma \in [k] \\
& y_{e, \sigma} = \sum_{i \in R} y_{e, i, \sigma} && \text{for all } e \in E, \sigma \in [k] \\
& \sum_{e=(u,v) \in E} y_{e, i, \sigma} - \sum_{e=(v,w) \in E} y_{e, i, \sigma} = 0 && \text{for all } v \in V \setminus \{s_i, t_i\}, i \in R, \sigma \in [k] \\
& \sum_{e=(s_i, u) \in A_i} y_{e, i, \sigma} = d_i \cdot \sum_{\theta \in \Theta} \varphi_{\theta, \sigma} && \text{for all } i \in R, \sigma \in [k] \\
& \pi_{s_i, i, \sigma} = 0 && \text{for all } i \in R, \sigma \in [k] \\
& y_{e, i, \sigma} \geq 0 && \text{for all } e \in A_i, i \in R, \sigma \in [k] \\
& y_{e, i, \sigma} = 0 && \text{for all } e \in E \setminus A_i, i \in R, \sigma \in [k] \\
& \sum_{\sigma \in [k]} \varphi_{\theta, \sigma} = \mu_\theta^* && \text{for all } \theta \in \Theta \\
& \varphi_{\theta, \sigma} \leq \mu_\theta^* && \text{for all } \theta \in \Theta, \sigma \in [k] \\
& \varphi_{\theta, \sigma} \geq 0 && \text{for all } \theta \in \Theta, \sigma \in [k]
\end{aligned} \tag{7}$$

This reduces optimizing the signaling scheme to an optimal choice of support sets. Suppose for some optimal signaling scheme  $\varphi^*$  we know (a superset of) the set of supports  $A_{i, \sigma}$  of the Wardrop equilibrium for each population  $i \in R$  resulting from each signal  $\sigma \in \Sigma$  that gets issued in  $\varphi^*$ . Then we can recover  $\varphi^*$  by solving the LP above. Let us examine the LP a bit more closely.

**Proposition 2.** *There is an optimal signaling scheme  $\varphi^*$  such that*

1. *at most  $|\Theta|$  signals get issued in  $\varphi^*$ , and,*
2. *there is no pair of signals  $\sigma \neq \sigma'$  that both get issued in  $\varphi^*$  and  $A_{i, \sigma} \subseteq A_{i, \sigma'}$  for each population  $i \in R$ . In particular, every signal  $\sigma$  that gets issued in  $\varphi^*$  has a distinct support vector  $(A_{i, \sigma})_{i \in R}$ .*

*Proof.* The first property is a direct consequence of Caratheodory's theorem applied in the context of signaling (c.f. Dughmi [23]). For the second property, consider an optimal scheme  $\varphi^*$  resulting from an optimal solution of LP (7). Suppose  $\varphi^*$  issues two signals  $\sigma, \sigma'$  with the subset property for all supports. Then we can “drop” signal  $\sigma$ , i.e., in a new scheme  $\varphi'$  issue  $\sigma'$  whenever we send  $\sigma$  or  $\sigma'$  in  $\varphi$ . Then  $\varphi'_{\theta \sigma} = 0$  and  $\varphi'_{\theta, \sigma'} = \varphi_{\theta, \sigma} + \varphi_{\theta, \sigma'}$  for each  $\theta \in \Theta$ . Using a similar adjustment of simply summing the entries of  $y_{e, i, \sigma}$  to those of  $y_{e, i, \sigma'}$ , we obtain a feasible solution of LP (7) with the same objective function value, i.e.,  $\varphi'$  is also an optimal scheme.  $\square$

The main insight in this section is the following.

**Theorem 3.** *Suppose we are given  $k \leq |\Theta|$  distinct support vectors  $(A_{i, \sigma})_{i \in R, \sigma \in [k]}$ . By solving LP (7) in time polynomial in  $|\Theta|$ ,  $|E|$  and  $r$ , we can compute the best signaling scheme that induces Wardrop equilibria with supports from  $(A_{i, \sigma})_{i \in R, \sigma \in [k]}$ .*

### 3.2 Support Enumeration

The result in Theorem 3 shows that the main difficulty in finding an optimal signaling scheme is to determine an optimal collection of *supports* used by the Wardrop equilibrium for the conditional distributions of signals in an optimal signaling scheme. If we have a polynomial-sized superset of the supports used by the optimal scheme, the scheme can be computed by solving LP (7).

Even in a (symmetric) game with a single population, each support is a subset of  $E$ . Hence, up to  $\binom{2^{|E|}}{|\Theta|}$  many different collections of subsets for the supports of (at most)  $|\Theta|$  signals can exist. This upper bound can grow by another exponential factor in the number  $r$  of populations.

For the remainder of the section, we concentrate on the case of two states  $\Theta = \{\theta_1, \theta_2\}$ . Instead of considering all subsets of edges, we systematically search through the supports resulting from all possible distributions  $\mu \in \Delta(\Theta)$ . Every distribution  $\mu \in \Delta(\Theta)$  one-to-one corresponds to a number  $\alpha = \mu_{\theta_1} = 1 - \mu_{\theta_2} \in [0, 1]$ . The cost function for a resource  $e \in E$  is given by  $c_e(x | \alpha) = a_e \cdot x + b_e(\alpha)$  with offsets  $b_e(\alpha) = \alpha \cdot b_e^{\theta_1} + (1 - \alpha) \cdot b_e^{\theta_2}$ .

**Proposition 3.** *The set of all supports of Wardrop equilibria for all  $\mu \in \Theta(\Delta)$  in games with two states can be computed in output-polynomial time.*

*Proof.* Consider the Wardrop equilibrium for a given distribution  $\alpha \in [0, 1]$  in polynomial time. To avoid degeneracy, we draw  $\alpha \sim U(0, 1)$  uniformly at random from (the interior of) the interval. Now using standard techniques, we can compute the support  $(A_i)_{i \in R}$  for the chosen  $\alpha$  in polynomial time. For this support, we solve LP (4) twice – once with the objective of maximizing  $\mu_{\theta_1}$  and once with the objective of minimizing  $\mu_{\theta_1}$ . By non-degeneracy (with probability 1), we obtain values  $\alpha_1 > \alpha_2$ , such that supports  $A_i$  are used by the Wardrop equilibrium for all distributions  $\alpha \in [\alpha_1, \alpha_2]$ . This splits the problem into two subproblems – find all supports for distributions on the subintervals  $[0, \alpha_1]$  and  $[\alpha_2, 1]$ . We apply our approach recursively.

Since all distributions with the same support form the convex set described by (4), we encounter at most one consecutive subinterval of  $[0, 1]$  for each support. As such, in our algorithm we return a different support for each subproblem generated in the recursion.  $\square$

The proposition shows that for every game, in which the distributions in  $\Delta(\Theta)$  generate at most a polynomial number of different supports in the resulting Wardrop equilibrium, we can compute these supports and, hence, an optimal signaling scheme in polynomial time. However, this property is not always fulfilled. In particular, even in a symmetric game with a single population  $R = \{1\}$  and two states that differ only in the offset of a single edge, one might encounter a number of supports exponential in  $|\mathcal{S}|$ .

**Theorem 4.** *For every number  $n \in \mathbb{N}$ , there is a symmetric network congestion game with  $|\Theta| = 2$  states,  $O(n)$  vertices,  $O(n)$  edges, and  $O(n)$  source-target paths, in which  $2^{\Theta(n)}$  different supports arise in the Wardrop equilibria for all  $\mu \in \Delta(\Theta)$ .*

For the class of games, we adjust the family of nested Braess graphs proposed and studied in [40, 18] (see Appendix B). In contrast, we show that for network congestion games on  $m$  parallel links a polynomial number of supports arise. We first show the result for *symmetric* games with a single population and then extend the result to a constant number of populations below.

**Proposition 4.** *For a symmetric network congestion game with  $m$  parallel links and two states, there are at most  $O(m^3)$  different supports of Wardrop equilibria for all  $\mu \in \Delta(\Theta)$ .*

*Proof.* For a given  $\alpha \in [0, 1]$ , consider all links  $E = \{e_1, \dots, e_m\}$  ordered in non-decreasing order of their offset, i.e.,  $b_{e_i}(\alpha) \leq b_{e_{i+1}}(\alpha)$ , for all  $1 \leq i \leq m - 1$ . In the resulting Wardrop equilibrium,  $x_{e_i} > 0$  for all links  $\{e_1, \dots, e_k\}$  earliest in the offset ordering, for some integer  $k = k(\alpha)$  with  $1 \leq k \leq m$ . In fact, for all conditional distributions  $\alpha$  that result in the same offset ordering, there are at most  $m$  possible supports, given by the  $m$  values of  $k(\alpha)$ .

Let us now bound the number of possible offset orderings. Each offset  $b_e(\alpha)$  is a linear function over the interval  $[0, 1]$ . Hence, either two offsets are identical (in which case we can assume they always are placed next to each other in every ordering) or they intersect in at most one point. Clearly, the offset ordering can change only at these intersections, i.e., at most  $\binom{m}{2}$  times. In total, over the interval  $[0, 1]$  there are at most  $\binom{m}{2} + 1$  different offset orderings.  $\square$

*Remark 1.* A superset of the  $O(m^3)$  relevant supports can be enumerated quickly in a direct way, without recursive maxi- and minimization over (4): Determine all points  $\beta \in [0, 1]$  where a pair of non-identical offset functions  $b_e(\beta) = b_{e'}(\beta)$  intersects. These points split the interval  $[0, 1]$  into at most  $\binom{m}{2} + 1$  subintervals, each with a unique offset ordering. We pick a point from each subinterval, determine the offset ordering, and record the  $m$  potential supports for each offset ordering.  $\triangle$

Being a neat structural observation, for symmetric games with one population we proved above that on parallel links the simple solution of honest signals is an optimal signaling scheme. In contrast, we saw in the introduction that even for instances with *two* populations and two parallel links, an optimal signaling scheme is not necessarily honest. We extend our support enumeration approach to compute optimal signaling schemes on parallel links for any number of  $r > 1$  populations. For constant  $r$  we obtain a polynomial-time algorithm.

**Proposition 5.** *For a network congestion game with  $m$  parallel links, two states, and  $r$  populations, there are at most  $O(m^2 \cdot m^{2^r - 1} \cdot (2^{r-1} - 1)^r)$  different supports of Wardrop equilibria for all  $\mu \in \Delta(\Theta)$ .*

*Proof.* We borrow the construction from Proposition 4 and consider all  $\alpha$  for which we generate the same offset ordering. We classify each link  $e \in E$  based on the subset of populations  $\{i \in R \mid e \in \mathcal{S}_i\}$  that have access to  $e$ . This yields  $2^r - 1$  classes of links, since w.l.o.g. every link can be accessed by at least one population. Consider the links  $E_C = \{e_1, e_2, \dots\}$  in a given class  $C \subseteq R$ . Clearly, a Wardrop equilibrium has  $x_{e_i} > 0$  only for the links with smallest offset from the class. Hence, within each class, there are at most  $m$  possible supports. Overall, there are at most  $m^{2^r-1}$  different combinations of supports over all classes.

Given some joint support for all classes, we still have to specify which subset of links is used by population  $i$ , for every  $i = 1, \dots, r$ . Since we fix the support in a class  $C$ , all links in the support of  $C$  must have the same cost in the Wardrop equilibrium. Hence, for each population that uses a link from class  $C$  in its individual support, we can assume that it uses all links of class  $C$  in its individual support. Hence, for each population  $i$  we only have to specify, which *classes* of links are used by this population. There are at most  $2^{r-1} - 1$  possibilities for each population, i.e., a total of  $(2^{r-1} - 1)^r$  possibilities in total.

Overall, for given offset ordering, we enumerate the possible support combinations in all of the  $2^r - 1$  classes of links. For each combination of supports in the classes, we enumerate the  $2^{r-1} - 1$  potential classes of links that are in the support of population  $i$ , for each  $i \in R$ . This yields a total of  $O(m^{2^r-1} \cdot (2^{r-1} - 1)^r)$  different combinations. Along with the bound of  $O(m^2)$  on the possible offset orderings shown above, the upper bound in the proposition follows.  $\square$

Finally, we observe that the computational approach for parallel links by enumerating offset orderings can be extended even further to a constant number of states. For the final result of this section, we define the offset  $b_e(\mu) = \sum_{\theta \in \Theta} \mu_\theta b_e^\theta$  for every  $\mu \in \Delta(\Theta)$  and every  $e \in E$ . We assume that the instance is *non-degenerate*, i.e., for every distribution  $\mu \in \Delta(\Theta)$  there are at most two distinct edges  $e_1, e_2$  with  $b_{e_1}(\mu) = b_{e_2}(\mu)$ .

**Theorem 5.** *For a non-degenerate network congestion game with  $m$  parallel links,  $d$  states, and  $r$  populations, there are at most  $O(m^{2d} \cdot m^{2^{r-1}} \cdot (2^{r-1} - 1)^r)$  different supports of Wardrop equilibria for all  $\mu \in \Delta(\Theta)$ . The supports can be computed in polynomial time if  $d$  and  $r$  are constants.*

*Proof.* Note that the approach in Proposition 5 continues to apply once we have a set of all possible offset orderings that can emerge. As such, it remains to compute the offset orderings that can result from  $\mu \in \Delta(\Theta)$ . Towards this end, we apply a cell decomposition technique.

Consider the simplex of  $\Delta(\Theta)$ , i.e., the space of all distributions over  $\Theta$  as a subset of  $\mathbb{R}^d$ . For the offset orderings, we consider the hyperplanes introduced by all pairs of edges, i.e.,  $b_e(\mu) = b_{e'}(\mu)$ , for all  $e, e' \in E$ ,  $e \neq e'$ . These pairwise equalities generate  $O(m^2)$  hyperplanes in  $\mathbb{R}^d$ . A well-known result (see, e.g. [21]) states that  $k$  hyperplanes split  $\mathbb{R}^d$  into at most  $O(k^d)$  many *cells*. A *cell* is a convex region of  $\Delta(\Theta)$  characterized by a unique collection of signs  $\square_{e,e'} \in \{>, <, =\}$ , one for each pair  $\{e, e'\} \subseteq E$ , such that  $b_e(\mu) \square_{e,e'} b_{e'}(\mu)$ . Clearly, each cell gives rise to an offset ordering that is consistent with all these pairwise inequalities. As such, we only need to enumerate  $O(m^{2d})$  offset orderings.

To efficiently enumerate the orderings, we rely on non-degeneracy. For any two neighboring cells, non-degeneracy and continuity imply that the resulting orderings differ by at most one pair of edges that exchange their (neighboring) positions. Moreover, for every cell there can at most one pair of edges with  $\square_{e,e'} = "="$ , so the resulting ordering in every cell is unique up to the position of a single pair of neighboring edges. This allows a simple depth-first-search (DFS) over cells to enumerate all offset orderings. We start with a single ordering, e.g., the one resulting from  $\mu_{\theta_1} = 1$ . Then we recursively examine all orderings that emerge by a flip of two neighboring edges. We maintain the set of all orderings that we have examined before. If we find an ordering that was examined before, we stop the recursion and backtrack. If the ordering is new, we check if the resulting system of pairwise inequalities allows at least one feasible  $\mu \in \Delta(\Theta)$ . If so, we continue the recursion with this ordering; else, we stop the recursion and backtrack.

This implements a DFS over the cells, since by examining all pairwise flips of neighboring edges, we are guaranteed to examine all orderings of neighboring cells. By the arguments above, we are guaranteed to find at most  $O(m^{2d})$  many orderings that allow a feasible  $\mu \in \Delta(\Theta)$ . For each ordering, we examine up to  $m - 1$  neighboring ones. In total, the DFS inspects  $O(m^{2d+1})$  offset orderings.  $\square$

## References

- [1] Sebastian Aland, Dominic Dumrauf, Martin Gairing, Burkhard Monien, and Florian Schoppmann. 2011. Exact Price of Anarchy for Polynomial Congestion Games. *SIAM J. Comput.* 40, 5 (2011), 1211–1233.
- [2] Itai Arieli and Yakov Babichenko. 2019. Private Bayesian persuasion. *J. Econ. Theory* 182 (2019), 185–217.
- [3] Robert Aumann and Michael Maschler. 1966. Game theoretic aspects of gradual disarmament. *Report of the US Arms Control and Disarmament Agency* 80 (1966), 1–55.
- [4] Baruch Awerbuch, Yossi Azar, and Amir Epstein. 2013. The Price of Routing Unsplittable Flow. *SIAM J. Comput.* 42, 1 (2013), 160–177.
- [5] Ashwinkumar Badanidiyuru, Kshipra Bhawalkar, and Haifeng Xu. 2018. Targeting and Signaling in Ad Auctions. In *Proc. 29th Symp. Discret. Algorithms (SODA)*. 2545–2563.
- [6] Martin Beckmann, Bartlett McGuire, and Christopher Winsten. 1956. *Studies in the Economies of Transportation*. Yale University Press.
- [7] Matteo Bettini. 2021. Static Traffic Assignment using User Equilibrium and System Optimum - Python Code and Network Data. <https://doi.org/MatteoBettini/Traffic-Assignment-Frank-Wolfe-2021>
- [8] Umang Bhaskar, Yu Cheng, Young Kun Ko, and Chaitanya Swamy. 2016. Hardness Results for Signaling in Bayesian Zero-Sum and Network Routing Games. In *Proc. 17th Conf. Econ. Comput. (EC)*. 479–496.
- [9] Dietrich Braess. 1968. Über ein Paradoxon aus der Verkehrsplanung. *Unternehmensforschung* 12 (1968), 258–268.
- [10] Matteo Castiglioni, Andrea Celli, Alberto Marchesi, and Nicola Gatti. 2020. Online Bayesian Persuasion. In *Proc. 33rd Conf. Adv. Neural Inf. Processing Syst. (NeurIPS)*.
- [11] Matteo Castiglioni, Andrea Celli, Alberto Marchesi, and Nicola Gatti. 2021. Signaling in Bayesian Network Congestion Games: the Subtle Power of Symmetry. In *Proc. 35th Conf. Artif. Intell. (AAAI)*. 5252–5259.
- [12] Matteo Castiglioni, Alberto Marchesi, Andrea Celli, and Nicola Gatti. 2021. Multi-Receiver Online Bayesian Persuasion. In *Proc. 38th Int. Conf. Machine Learning (ICML)*. 1314–1323.
- [13] George Christodoulou, Martin Gairing, Yiannis Giannakopoulos, and Paul Spirakis. 2019. The Price of Stability of Weighted Congestion Games. *SIAM J. Comput.* 48, 5 (2019), 1544–1582.
- [14] George Christodoulou and Elias Koutsoupias. 2005. The price of anarchy in finite congestion games. In *Proc. 37th Symp. Theory Comput. (STOC)*. 67–73.
- [15] Richard Cole, Yevgeniy Dodis, and Tim Roughgarden. 2006. How much can taxes help selfish routing? *J. Comput. Syst. Sci.* 72, 3 (2006), 444–467.
- [16] Riccardo Colini-Baldeschi, Roberto Cominetti, Panayotis Mertikopoulos, and Marco Scarsini. 2020. When Is Selfish Routing Bad? The Price of Anarchy in Light and Heavy Traffic. *Oper. Res.* 68, 2 (2020), 411–434.
- [17] Riccardo Colini-Baldeschi, Max Klimm, and Marco Scarsini. 2018. Demand-Independent Optimal Tolls. In *Proc. 45th Int. Colloq. Autom. Lang. Programming (ICALP)*. 151:1–151:14.
- [18] Roberto Cominetti, Valerio Dose, and Marco Scarsini. 2019. The Price of Anarchy in Routing Games as a Function of the Demand. In *Proc. 15th Conf. Web and Internet Econ. (WINE)*. Springer, 337.
- [19] José R. Correa, Andreas Schulz, and Nicolás Stier Moses. 2008. A geometric approach to the price of anarchy in nonatomic congestion games. *Games Econ. Behav.* 64, 2 (2008), 457–469.



- [20] Sanmay Das, Emir Kamenica, and R. Mirka. 2017. Reducing congestion through information design. In *Proc. 55th Annual Allerton Conference on Communication, Control, and Computing*.
- [21] Nikhil Devanur and Ravi Kannan. 2008. Market Equilibria in Polynomial Time for Fixed Number of Goods or Agents. In *Proc. 49th Symp. Found. Comput. Sci. (FOCS)*. 45–53.
- [22] Richard J Duffin. 1965. Topology of series-parallel networks. *J. Math. Anal. Appl.* 10, 2 (1965), 303–318.
- [23] Shaddin Dughmi. 2019. On the hardness of designing public signals. *Games Econ. Behav.* 118 (2019), 609–625.
- [24] Shaddin Dughmi, David Kempe, and Ruixin Qiang. 2016. Persuasion with Limited Communication. In *Proc. 17th Conf. Econ. Comput. (EC)*. 663–680.
- [25] Shaddin Dughmi and Haifeng Xu. 2021. Algorithmic Bayesian Persuasion. *SIAM J. Comput.* 50, 3 (2021).
- [26] Yuval Emek, Michal Feldman, Iftah Gamzu, Renato Paes Leme, and Moshe Tennenholtz. 2014. Signaling schemes for revenue maximization. *ACM Trans. Econ. Comput.* 2, 2 (2014), 5:1–5:19.
- [27] Lisa Fleischer, Kamal Jain, and Mohammad Mahdian. 2004. Tolls for Heterogeneous Selfish Users in Multicommodity Networks and Generalized Congestion Games. In *Proc. 45th Symp. Found. Comput. Sci. (FOCS)*. 277–285.
- [28] Marguerite Frank and Philip Wolfe. 1956. An algorithm for quadratic programming. *Naval Research Logistics Quarterly* 3, 1-2 (1956), 95–110.
- [29] Satoru Fujishige, Michel Goemans, Tobias Harks, Britta Peis, and Rico Zenklusen. 2017. Matroids Are Immune to Braess’ Paradox. *Math. Oper. Res.* 42, 3 (2017), 745–761.
- [30] Martin Gairing, Tobias Harks, and Max Klimm. 2017. Complexity and Approximation of the Continuous Network Design Problem. *SIAM J. Optim.* 27, 3 (2017), 1554–1582.
- [31] Ronen Gradwohl, Niklas Hahn, Martin Hoefer, and Rann Smorodinsky. 2021. Algorithms for Persuasion with Limited Communication. In *Proc. 31st Symp. Discret. Algorithms (SODA)*. 637–652.
- [32] Niklas Hahn, Martin Hoefer, and Rann Smorodinsky. 2020. Prophet Inequalities for Bayesian Persuasion. In *Proc. 29th Int. Joint Conf. Artif. Intell. (IJCAI)*. 175–181.
- [33] Niklas Hahn, Martin Hoefer, and Rann Smorodinsky. 2020. The Secretary Recommendation Problem. In *Proc. 21st Conf. Econ. Comput. (EC)*. 189.
- [34] Tobias Harks, Ingo Kleinert, Max Klimm, and Rolf H. Möhring. 2015. Computing network tolls with support constraints. *Networks* 65, 3 (2015), 262–285.
- [35] David A. Harville. 1997. *Matrix algebra from a statistician’s perspective*. Springer, New York, NY.
- [36] Martin Hoefer, Lars Olbrich, and Alexander Skopalik. 2008. Taxing Subnetworks. In *Proc. 4th Workshop Internet & Network Econ. (WINE)*. 286–294.
- [37] Tomas Jelinek, Marcus Klaas, and Guido Schäfer. 2014. Computing Optimal Tolls with Arc Restrictions and Heterogeneous Players. In *Proc. 31st Symp. Theoret. Aspects Comput. Sci. (STACS)*. 433–444.
- [38] Emir Kamenica and Matthew Gentzkow. 2011. Bayesian Persuasion. *Amer. Econ. Rev.* 101, 6 (2011), 2590–2615.
- [39] Geroge Karakostas and Stavros Kolliopoulos. 2004. Edge pricing of multicommodity networks for heterogeneous users. In *Proc. 45th Symp. Found. Comput. Sci. (FOCS)*. 268–276.
- [40] Max Klimm and Philipp Warode. 2021. Parametric Computation of Minimum-Cost Flows with Piecewise Quadratic Costs. *Mathematics of Operations Research* (2021). To appear.
- [41] Thanasis Lianas, Evdokia Nikolova, and Nicolás E. Stier Moses. 2019. Risk-Averse Selfish Routing. *Math. Oper. Res.* 44, 1 (2019), 38–57.

- [42] Igal Milchtaich. 2006. Network topology and the efficiency of equilibrium. *Games Econ. Behav.* 57, 2 (2006), 321–346.
- [43] Bureau of Public Roads. 1964. *Traffic Assignment Manual*. U.S. Dept. of Commerce, Urban Planning Division, Washington DC, USA.
- [44] Dario Paccagnan, Rahul Chandan, Bryce Ferguson, and Jason Marden. 2021. Optimal Taxes in Atomic Congestion Games. *ACM Trans. Econ. Comput.* 9, 3 (2021), 19:1–19:33.
- [45] Tim Roughgarden. 2003. The price of anarchy is independent of the network topology. *J. Comput. Syst. Sci.* 67, 2 (2003), 341–364.
- [46] Tim Roughgarden. 2006. On the severity of Braess’s Paradox: Designing networks for selfish users is hard. *J. Comput. Syst. Sci.* 72, 5 (2006), 922–953.
- [47] Tim Roughgarden. 2012. Intrinsic robustness of the price of anarchy. *Comm. ACM* 55, 7 (2012), 116–123.
- [48] Tim Roughgarden and Éva Tardos. 2002. How bad is selfish routing? *J. ACM* 49, 2 (2002), 236–259.
- [49] Aviad Rubinfeld. 2017. Honest Signaling in Zero-Sum Games Is Hard, and Lying Is Even Harder. In *Proc. 44th Int. Colloq. Autom. Lang. Programming (ICALP)*. 77:1–77:13.
- [50] A. Ruszczyński. 2006. *Nonlinear Optimization*. Princeton University Press, Princeton, New Jersey.
- [51] Gregory Valiant and Tim Roughgarden. 2010. Braess’s Paradox in large random graphs. *Random Struct. Algorithms* 37, 4 (2010), 495–515.
- [52] S. Vasserman, M. Feldman, and A. Hassidim. 2015. Implementing the wisdom of Waze. In *Proc. 24th International Joint Conference on Artificial Intelligence (IJCAI)*. 660–660.
- [53] Haifeng Xu. 2020. On the tractability of public persuasion with no externalities. In *Proc. 30th Symp. Discret. Algorithms (SODA)*. 2708–2727.
- [54] Chenghan Zhou, Thanh H. Nguyen, and Haifeng Xu. 2021. Algorithmic Information Design in Multi-Player Games: Possibility and Limits in Singleton Congestion. *CoRR* abs/2109.12445 (2021).
- [55] You Zu, Krishnamurthy Iyer, and Haifeng Xu. 2021. Learning to Persuade on the Fly: Robustness Against Ignorance. In *Proc. 22nd Conf. Econ. Comput. (EC)*. 927–928.

# Appendix

## A Karush-Kuhn-Tucker Conditions

For the following Karush-Kuhn-Tucker conditions, see, e.g., Ruszczyski [50, Theorems 3.25 and 3.27] for a reference.

**Theorem 6** (KKT conditions). *Consider the minimization problem*

$$\begin{aligned} \min \quad & f(y) \\ \text{s.t.} \quad & g_i(y) \geq 0 \quad \text{for all } i \in \{1, \dots, p\} \\ & h_i(y) = 0 \quad \text{for all } i \in \{1, \dots, q\} \\ & y \in \mathbb{R}^n, \end{aligned} \tag{8}$$

where  $f : \mathbb{R}^n \rightarrow \mathbb{R}$  is continuously differentiable and convex, and the functions  $g_i : \mathbb{R}^n \rightarrow \mathbb{R}, i \in \{1, \dots, p\}$  and  $h_i : \mathbb{R}^n \rightarrow \mathbb{R}, i \in \{1, \dots, q\}$  are affine. Then  $x \in \mathbb{R}^n$  is a global minimum of the minimization problem (8) if and only if there exist vectors  $\lambda \in \mathbb{R}_{\geq 0}^p$  and  $\eta \in \mathbb{R}^q$  such that

$$0 = \nabla f(x) - \sum_{i=1}^p \lambda_i \nabla g_i(x) - \sum_{i=1}^q \eta_i \nabla h_i(x) \quad \text{and} \quad \lambda_i g_i(x) = 0 \quad \text{for all } i \in \{1, \dots, p\}.$$

## B Nested Braess Graphs and Exponential Number of Supports

Our class of games is a slight variation of the family of nested Braess graphs  $G_j^B = (V_j, E_j), j \in \mathbb{N}$ , as defined in [40]: The set of vertices is  $V_j := \{s = v_0, v_1, v_2, \dots, v_{2j}, t = v_{2j+1}\}$  and the set of edges is  $E_j := E_j^1 \cup E_j^2 \cup E_j^3 \cup \{(v_j, v_{j+1})\}$ , where  $E_j^1 := \{(v_i, v_{i+1}) \mid i \in \{0, \dots, 2j\}, i \neq j\}$ ,  $E_j^2 := \{(v_i, v_{2j-i}) \mid i \in \{0, \dots, j-1\}$ , and  $E_j^3 := \{(v_{i+1}, v_{2j+1-i}) \mid i \in \{0, \dots, j-1\}\}$ . For  $\theta \in \{\theta_1, \theta_2\}$ , each edge  $e \in E_j$  is equipped with a cost function  $c_e^{\theta, j}(x_e) = a_e^j x_e + b_e^j$  with coefficients given by

$$a_e^j = \begin{cases} 1 & \text{if } e \in E_j^1 \setminus \{(v_j, v_{j+1})\}, \\ \varepsilon & \text{if } e = (v_j, v_{j+1}), \\ 0 & \text{otherwise} \end{cases},$$

$$b_e^j = \begin{cases} 10^{j-1-i} & \text{if } e = (v_i, v_{2j-i}), i = 0, \dots, j-1, \\ & \text{or if } e = (v_{i+1}, v_{2j+1-i}), i = 0, \dots, j-1, \\ 0 & \text{otherwise.} \end{cases}$$

Note that all these cost functions are *independent* of the state  $\theta \in \Theta$ . It is straightforward to verify that  $G_j^B$  contains  $2j+2$  vertices,  $4j+1$  edges, and  $2j+1$  paths from  $s$  to  $t$ .

Our graphs are almost identical to the class considered in [40] with the only difference that edge  $e = (v_j, v_{j+1})$  at the center of  $G_j^B$  has cost  $c_e^{\theta, j}(x_e) = \varepsilon \cdot x_e$  (instead of 0), for some small  $\varepsilon > 0$ . Let  $d \geq 0$  be the portion of the population (i.e., the demand) to be routed through  $G_j^B$  from source  $s$  to target  $t$ . Furthermore, let  $x(d)$  be the Wardrop equilibrium induced along all edges  $e \in E_j$  for demand  $d$ . With the above adjustment, the costs  $C^j(x(d))$  of the Wardrop equilibrium become strictly increasing in  $d$ , as shown in the next lemma.

**Lemma 5.** *The cost  $C^j(x(d))$  of the Wardrop equilibrium in  $G_j^B$  is strictly increasing in  $d$ .*

*Proof.* We show the lemma by induction on  $j \in \mathbb{N}$ . From [40, Claim 4], we see<sup>1</sup> that, for any  $j$ ,

- (i) If  $d \geq 2 \cdot 10^{j-1}$ , then  $x_e(d) = 0$  for all  $e \notin E_j^O$  and  $C^j(x(d)) = 10^{j-1} + \frac{d}{2}$ .
- (ii) If  $d \leq 3 \cdot 10^{j-2}$ , then  $x_e(d) = 0$  for  $e = (s, v_{2j})$  and  $e = (v_1, t)$ .

For  $j = 1$ , we find the following support sets  $A^i$ , associated demand intervals  $I^i$ :

$$\begin{aligned} A^1 &= \emptyset & \text{for } d = I^1 = 0, \\ A^2 &= \{(v_0, v_1), (v_1, v_2), (v_2, v_3)\} & \text{for } d \in I^2 = \left(0, \frac{1}{1+\varepsilon}\right], \end{aligned}$$

<sup>1</sup>Without proof,  $\varepsilon$  can always be chosen sufficiently small so that its contribution is negligible.

$$\begin{aligned}
A^3 &= E_1 & \text{for } d \in I^3 &= \left( \frac{1}{1+\varepsilon}, 2 \right), \\
A^4 &= E_1 \setminus \{(v_1, v_2)\} & \text{for } d \in I^4 &= [2, \infty).
\end{aligned}$$

It is straightforward to check that  $C^1(x(0)) = 0$ ,  $C^1(x(d)) = d(2 + \varepsilon)$  for  $d \in I^2$ ,  $C^1(x(d)) = \frac{2+\varepsilon(d+2)}{1+2\varepsilon}$  for  $d \in I^3$ , and  $C^1(x(d)) = 1 + \frac{d}{2}$  for  $d \in I^4$ , respectively.  $C^1$  is strictly increasing for all  $d \geq 0$ .

Now assume that  $C^j$  is strictly increasing in  $d$ , for some  $j \geq 2$ . For the inductive step  $j \rightarrow j+1$ , the inner subgraph  $G_{j+1}^B[V_{j+1}^j]$  (induced by the subset of vertices  $V_{j+1}^j := V_j \setminus \{s, t\}$ ) can be viewed as a hypothetical edge  $e' = (v_1, v_{2j})$  with cost function  $c_{e'}^{j+1}(x_{e'})$  whose value is identical to  $C^j(x(x_{e'}))$ . By (i) and (ii), it directly follows that  $C^{j+1}$  is strictly increasing for any demand  $d \leq 6 \cdot 10^{j-1}$  and any  $d \geq 2 \cdot 10^j$  since  $C^{j+1}(x(d)) = 2d + c_{e'}^{j+1}(d)$  and  $C^{j+1}(d) = 10^j + \frac{d}{2}$ , respectively. For the analysis of the interval  $d \in (6 \cdot 10^{j-1}, 2 \cdot 10^j)$ , let  $e = (s, v_1)$ . From the equality condition  $3x_e(d) + c_{e'}^{j+1}(x_{e'}(d)) = 10^j$  and conservation of flow,  $x_e(d) = (d - x_{e'}(d)) + x_{e'}(d)$ , we obtain that  $\frac{d}{2} + \frac{x_{e'}(d)}{2} + c_{e'}^{j+1}(x_{e'}(d))$  is constant. Since  $d$  is strictly increasing, this implies that  $x_{e'}(d)$  and, thus,  $c_{e'}^{j+1}(x_{e'}(d))$  must be strictly decreasing. Calculating the flow  $x_e(d)$ , we see  $C^{j+1}(x(d)) = x_e(d) + 10^j = 2 \cdot 10^j - c_{e'}^{j+1}(x_{e'}(d))$ , which is strictly increasing.  $C^{j+1}(x(d))$  is strictly increasing over the whole interval  $d \geq 0$ .  $\square$

In the next step, we use the result of the lemma to construct an instance that has an exponential number of support sets for the distributions over two states.

Consider  $G_j^B$  for some  $j \in \mathbb{N}$ . By [40, Theorem 10], there are  $2^{j+1}$  different demands  $d_1, \dots, d_{2^{j+1}} \in [0, 3 \cdot 10^{j-1}]$  such that all corresponding support sets  $A^1, \dots, A^{2^{j+1}}$  of the Wardrop equilibrium are different.

First, we scale the cost functions as follows:  $\tilde{c}_e^j = \frac{10^{1-j}}{3} \cdot c_e^j$  if  $e = (v_i, v_{2j-i})$  or if  $e = (v_{i+1}, v_{2j+1-i})$ ,  $i = 0, \dots, j-1$ , and  $\tilde{c}_e^j = c_e^j$  else. We also rescale  $\varepsilon$  by  $\tilde{\varepsilon} = \frac{10^{1-j}}{3} \cdot \varepsilon$  to ensure that it stays sufficiently small. By this, demands  $\tilde{d}_1, \dots, \tilde{d}_{2^{j+1}} \in [0, 1]$  are sufficient to generate the  $2^{j+1}$  different support sets.

Second, we add a single edge  $e^* = (s, t)$  with cost function  $\tilde{c}_{e^*}^j(x_{e^*}) = b_{e^*}^\theta$  to  $E_j$ . This is the only edge in the whole network with unknown offset, and the offsets are  $b_{e^*}^{\theta_1} = 0$  and  $b_{e^*}^{\theta_2} = 1$ . A sketch of the resulting graph is provided in Figure 4. Note that there are basically two alternatives to reach  $t$  from  $s$ : via  $e^*$  or through the nested Braess instance.

For a given distribution  $\alpha$  over the two states, the expected cost of  $e^*$  becomes  $b_{e^*}(\alpha) = \alpha$ . Hence, all other paths chosen in a Wardrop equilibrium must have delay of at most  $\alpha$ . Let  $d(\alpha) \in [0, 1]$  denote the fraction of the player population that routes through the Braess instance (which implies a fraction of  $1 - d(\alpha)$  chooses  $e^*$ ).

Clearly, for  $\alpha = 0$ ,  $\tilde{c}_{e^*}^j = 0$  and hence  $d(\alpha) = 0$ . Suppose we increase  $\alpha$  starting from 0. Then the expected cost of  $e^*$  increases strictly, which increases the incentives for the player population to switch to an  $s$ - $t$ -path from the nested Braess instance. Since all cost functions in the Braess graph are continuous and strictly increasing,  $d(\alpha)$  strictly increases with  $\alpha$ . In particular, it follows that there exist distinct parameter values  $\alpha_1, \dots, \alpha_{2^{j+1}} \in [0, 1]$  that induce demands  $d(\alpha_i) = \tilde{d}_i$  routed through the Braess graph. Thus,  $2^{j+1}$  different support sets can be generated for  $\alpha \in [0, 1]$ .

## C Experimental Study: Support Enumeration on SiouxFalls Network

We performed a computational study in order to suggest that the superset  $A$  of supports used by the optimal scheme is not exponential in size for network congestion games on more realistic graph structures. For this, we considered a (symmetric) network congestion game with a single population and two states  $\Theta = \{\theta_1, \theta_2\}$  on the SiouxFalls network, which is composed of  $|V| = 24$  nodes and  $|E| = 76$  links, as depicted in Figure 5. This network is a frequently considered scenario in the context of the analysis of transportation networks and the traffic assignment problem. The respective network data was obtained from [7], including information on the free flow travel time  $t_e$  (per unit of time) and the capacity  $C_e$  (per unit of time) of each link  $e \in E$ . We set our link costs  $c_e^\theta(x) = a_e \cdot x + b_e^\theta$  by defining the coefficients as

$$a_e^\theta = \gamma \cdot \frac{t_e}{C_e}, \quad b_e^{\theta_1} = t_e, \quad b_e^{\theta_2} \sim U(1, 15), \quad (9)$$

for each  $e \in E$  and  $\theta \in \Theta$ , where  $\gamma \geq 0$  is a dimensionless parameter. By this, we obtain slopes  $a_e \propto 10^{-5}$  and offsets  $b_e \propto 10^0$ . Note that the definition in (9) corresponds to a linear variant of the BPR link

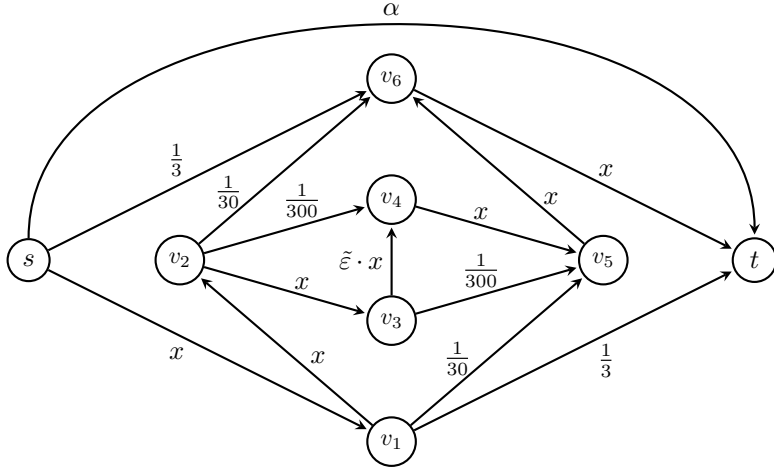

Figure 4: Sketch for  $j = 3$  of the constructed nested Braess graph showing an exponential number of supports. The graph is basically composed of the two components  $e^* = (s, t)$  and the renormalized nested Braess structure  $G_j^B$ . Annotated next to the edges are the expected edge costs  $c_e(x | \alpha) = a_e \cdot x + b_e(\alpha)$  with offsets  $b_e(\alpha) = \alpha \cdot b_e^{\theta_1} + (1 - \alpha)b_e^{\theta_2}$ .

congestion function [43] for calculating the average travel time  $S_e$  for an agent on link  $e$  with total load  $x \geq 0$ ,

$$S_e(x) = t_e \cdot \left( 1 + \gamma \cdot \left( \frac{x}{C_e} \right)^\beta \right),$$

by choosing  $\beta = 1$  in the exponent (classically,  $\beta = 4$ ). By convention, we used  $\gamma = 0.15$ . Moreover, we introduced a simulation parameter  $\tau \in [0, 1]$  to control the fraction of edges for which  $b_e^{\theta_2}$  is indeed chosen randomly as in (9). For the remaining fraction  $1 - \tau$ , we kept  $b_e^{\theta_2} = b_e^{\theta_1}$ .

In Figure 6, we present a histogram of the cardinality of the number of supports for various  $\tau$ , namely  $\tau \in \{0.05, 0.2, 0.5, 1.0\}$ . For each  $\tau$ , we consider 50 distinct instances where demand  $d = 10^5$  is sent from node 1 in the network to node 19. The supports were determined by a Python implementation of the recursive approach described in the proof of Proposition 3. We used an implementation of the Frank-Wolfe algorithm [28, 7] to compute the flow assignment in Wardrop equilibrium and, hence, determine the edges in the support. Clearly, the number of different supports tends to increase as  $\tau$  increases. This effect is caused by a higher possibility that edges are added or removed from the support, since there is larger variety in the offsets  $b_e(\alpha)$  as  $\alpha = \mu_{\theta_1} = 1 - \mu_{\theta_2} \in [0, 1]$  is increased. However, even for  $\tau = 1$ , the number of supports that arise in Wardrop equilibria is small compared to  $|E|$ . This implies that computing the optimal signaling scheme in the SiouxFalls network can be done efficiently by solving LP (7).

Looking at  $C(\mu)$ , Figure 7 indicates that the cost of the Wardrop equilibrium as a function of  $\mu$  is concave. For our single-commodity variant of the SiouxFalls network, as a prototype of realistic networks, full information revelation is an optimal signaling scheme. Since the network is not a series-parallel graph, Theorem 2 implies that there must exist parameter choices for the cost functions such that full information revelation is suboptimal. We observed this behavior, see Figure 8, after performing a slight modification with respect to the way of choosing the coefficients  $b_e^\theta$  and by using a higher demand  $d = 2 \cdot 10^5$ . More specifically, for every link  $e \in E$ , the offsets are determined independently according to either  $b_e^{\theta_1} = t_e$  and  $b_e^{\theta_2} \sim U(0, 15)$ , or  $b_e^{\theta_1} \sim U(0, 15)$  and  $b_e^{\theta_2} = t_e$ , with equal probability. The demand is sent from node 10 in the network to node 20.

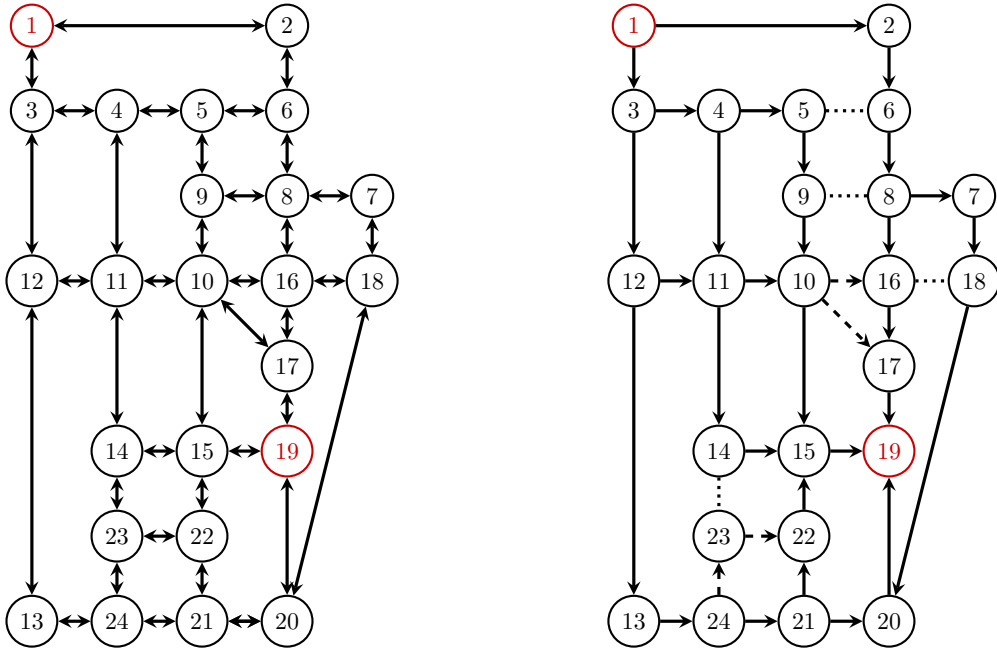

Figure 5: *Left*: Sketch of the SiouxFalls network. Vertices 1 and 19 were used as the source and target vertices in our computational study, respectively. Double-headed arrows represent two distinct edges, one for each direction. *Right*: Visualization of the supports  $A_0$  (for  $\alpha = 0$ ) and  $A_1$  (for  $\alpha = 1$ ) related to Figure 7. The directed solid lines indicate  $e \in A_0 \cap A_1$ , dashed lines  $e \in A_1 \setminus A_0$ , and undirected dotted lines  $e \notin A_0 \cup A_1$ . Note that there are no  $e \in A_0 \setminus A_1$ .

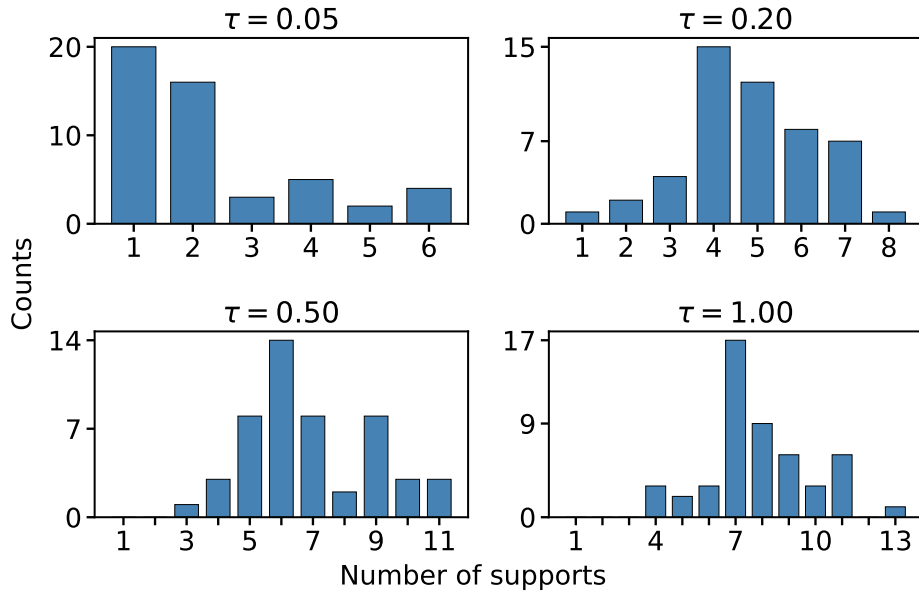

Figure 6: Histogram of number of supports in SiouxFalls network for demand  $d = 10^5$  between nodes 1 and 19 and varying fraction  $\tau$  of edges with  $b_e^{\theta_2}$  as in (9) taken over 50 runs each.

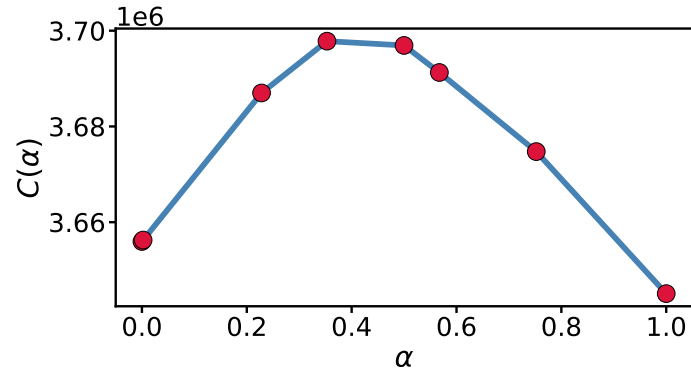

Figure 7: Cost  $C(\alpha)$  of the Wardrop equilibrium described by parameter  $\alpha := \mu_{\theta_1} = 1 - \mu_{\theta_2} \in [0, 1]$  for  $\tau = 0.8$  and  $d = 10^5$ . The red circles indicate the begin/end of the supports of the adjacent  $\alpha$ -intervals.

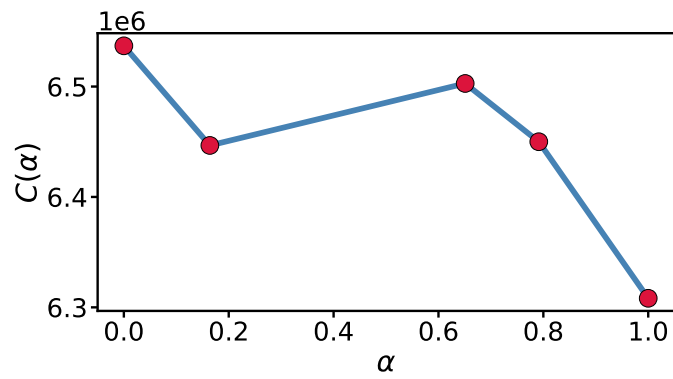

Figure 8: Cost  $C(\alpha)$  of the Wardrop equilibrium described by parameter  $\alpha := \mu_{\theta_1} = 1 - \mu_{\theta_2} \in [0, 1]$  for  $\tau = 1.0$  and  $d = 2 \cdot 10^5$ . The red circles indicate the begin/end of the supports of the adjacent  $\alpha$ -intervals. In this instance, full information revelation is not optimal since the pointwise minimum of  $C(\alpha)$  is not concave, so that sending a single signal in both states has less cost for prior  $\mu^* = (0.167, 0.833)$ .