

11/4-colorability of subcubic triangle-free graphs*

Zdeněk Dvořák[†] Bernard Lidický[‡] Luke Postle[§]

Abstract

We prove that up to two exceptions, every connected subcubic triangle-free graph has fractional chromatic number at most $11/4$. This is tight unless further exceptional graphs are excluded, and improves the known bound on the fractional chromatic number of subcubic triangle-free planar graphs.

1 Introduction

Fractional coloring was introduced in 1973 [9] as an approach for either disproving, or giving more evidence for the Four Color Theorem. While this largely failed, the topic of fractional coloring turned out to be interesting on its own, in part due to applications in the study of the independence number. For a real number k , a graph G is *fractionally k -colorable* if any of the following equivalent [12] conditions holds:

- There exists an assignment φ of sets of measure 1 to vertices of G such that $\varphi(u) \cap \varphi(v) = \emptyset$ for every edge $uv \in E(G)$, and the measure of $\bigcup_{v \in V(G)} \varphi(v)$ is at most k .
- For some positive integers a and b such that $a/b \leq k$, there exists an assignment φ of subsets of $\{1, \dots, a\}$ of size b to vertices of G such that $\varphi(u) \cap \varphi(v) = \emptyset$ for every edge $uv \in E(G)$.
- For every assignment of non-negative weights to vertices of G , there is an independent set in G that contains at least $(1/k)$ -fraction of the total weight.

*In memory of Robin Thomas, who inspired much more than just this paper.

[†]Computer Science Institute of Charles University, Prague, Czech Republic. E-mail: rakdver@iuuk.mff.cuni.cz. This article is part of a project that has received funding from the European Research Council (ERC) under the European Union's Horizon 2020 research and innovation programme (grant agreement No 810115).

[‡]Department of Mathematics, Iowa State University. Ames, IA, USA. E-mail: lidicky@iastate.edu. Supported in part by NSF grant DMS-1855653 and Scott Hanna fellowship.

[§]Department of Combinatorics and Optimization, University of Waterloo, Waterloo, Ontario, Canada. E-mail: lpostle@uwaterloo.ca. Canada Research Chair in Graph Theory. Partially supported by NSERC under Discovery Grant No. 2019-04304, the Ontario Early Researcher Awards program and the Canada Research Chairs program.

Note that either of the first two conditions directly implies that for an integer k , a properly k -colorable graph is also fractionally k -colorable. The *fractional chromatic number* of G is defined as the infimum of the values k such that G is fractionally k -colorable (actually, this infimum is achieved, and thus we could write “minimum” in this definition [12]). By considering the uniform weight assignment, the last of the equivalent conditions shows that every fractionally k -colorable graph on n vertices contains an independent set of size at least n/k . Conversely, in case graphs from a certain class contain large independent sets, it is natural to ask whether they have bounded fractional chromatic number.

The independence number of triangle-free graphs is of particular interest as one of the most basic instances of the Ramsey theory—the fact that the Ramsey number $R(3, t)$ is $\Theta(t^2/\log t)$ [1, 11] is equivalent to saying that the minimum possible independence number of a triangle-free graph on n vertices is $\Theta(\sqrt{n \log n})$. In terms of the maximum degree, it is known [1] that an n -vertex triangle-free graph of maximum degree at most Δ has an independent set of size $\Omega(n \log \Delta/\Delta)$. Actually, they also have the chromatic number $O(\Delta/\log \Delta)$, but the proof of this fact is substantially more involved [10].

The bounds mentioned in the previous paragraph are asymptotic and do not give any information for small values of Δ . In this paper, we are interested in the case of the maximum degree $\Delta \leq 3$, i.e., *subcubic* triangle-free graphs. Culminating a series of previous results, Staton [13] proved that every n -vertex subcubic triangle-free graph has an independent set of size $5n/14$; this bound is optimal, since the generalized Petersen graph $P(7, 2)$ has 14 vertices and no independent set of size greater than 5, as observed by Fajtlowicz [5]. In fact, $P(7, 2)$ and another 14-vertex graph (see Figure 2) are the only connected graphs for which this bound is tight. Fraughnaugh and Locke [6] proved that a connected n -vertex subcubic triangle-free graph has an independent set of size at least $(11n - 4)/30$, improving upon the Staton’s bound for $n > 14$. Based on earlier experimental evidence of Bajnok and Brinkmann [3], Fraughnaugh and Locke [6] also conjectured an improvement of this bound: An n -vertex subcubic triangle-free graph avoiding graphs $F_{14}^{(1)}$, $F_{14}^{(2)}$, F_{11} , F_{22} , $F_{19}^{(1)}$, and $F_{19}^{(2)}$ as subgraphs has an independent set of size at least $3n/8$. Here $F_{14}^{(1)}$ and $F_{14}^{(2)}$ are the two graphs depicted in Figure 2, and F_{11} , F_{22} , $F_{19}^{(1)}$ and $F_{19}^{(2)}$ are the graphs depicted in Figure 3 which also have independence number smaller than $3/8$ times their number of vertices. This conjecture was recently confirmed by Cames van Batenburg et al. [14]. Let us remark that this result is tight, as there exist infinitely many 3-connected subcubic triangle-free graphs G of girth five with independence number $3|V(G)|/8$.

The study of these questions from the perspective of the fractional chromatic number was first proposed by Heckman and Thomas. In the paper where they gave a new proof of Staton’s result, they suggest the following natural strengthening.

Conjecture 1.1 (Heckman and Thomas [7]). *Every subcubic triangle-free graph is fractionally $14/5$ -colorable.*

Furthermore, in [8] they proved that every n -vertex planar subcubic triangle-free graph has an independent set of size at least $3n/8$ (since the graphs $F_{14}^{(1)}$, \dots , $F_{19}^{(2)}$ are non-planar,

this is a special case of the result of Cames van Batenburg et al. [14]), and gave the corresponding fractional chromatic number conjecture.

Conjecture 1.2 (Heckman and Thomas [8]). *Every subcubic triangle-free planar graph is fractionally $8/3$ -colorable.*

Conjecture 1.1 was proved by Dvořák et al. [4]. Cames van Batenburg et al. [14] proposed the natural strengthening, which would imply Conjecture 1.2.

Conjecture 1.3 (Cames van Batenburg et al. [14]). *Every subcubic triangle-free graph avoiding $F_{14}^{(1)}$, $F_{14}^{(2)}$, F_{11} , F_{22} , $F_{19}^{(1)}$, and $F_{19}^{(2)}$ as subgraphs is fractionally $8/3$ -colorable.*

In this paper, we present the first step towards this conjecture.

Theorem 1.4. *Let G be a subcubic triangle-free graph. If no component of G is isomorphic to the graphs $F_{14}^{(1)}$ and $F_{14}^{(2)}$ depicted in Figure 2, then G has fractional chromatic number at most $11/4$.*

Note that the bound $11/4$ is the best possible if only the two subgraphs $F_{14}^{(1)}$ and $F_{14}^{(2)}$ are forbidden, as the graphs F_{11} and F_{22} have fractional chromatic number $11/4$. Conversely, let us remark that $F_{14}^{(1)}$ and $F_{14}^{(2)}$ both have fractional chromatic number $14/5 > 11/4$, and thus we cannot avoid forbidding them. Since $F_{14}^{(1)}$ and $F_{14}^{(2)}$ are both non-planar, we obtain the following partial result towards Conjecture 1.2.

Corollary 1.5. *Every subcubic triangle-free planar graph is fractionally $11/4$ -colorable.*

Let us end the introduction by proposing the following conjecture, intermediate between Theorem 1.4 and Conjecture 1.3.

Conjecture 1.6. *Every subcubic triangle-free graph avoiding $F_{14}^{(1)}$, $F_{14}^{(2)}$, F_{11} , and F_{22} as subgraphs is fractionally $19/7$ -colorable.*

In the following section, we present a strengthening of Theorem 1.4 that enables us to carry out an inductive argument; this strengthening is motivated by the proof method of Heckman and Thomas [7] and Dvořák et al [4]. In the following sections, we consider the properties of a hypothetical minimal counterexample to this strengthening, gradually obtaining more information on its structure. Finally, in Section 10, we show no such counterexample exists, finishing the argument.

Programs

Many of the arguments in this paper are computer-assisted; the programs we used to verify the claims can be found at <https://iuk.mff.cuni.cz/~rakdver/elevenfour/>. To decrease the chance of errors, two of the authors wrote independent programs using different frameworks:

- The program by Zdeněk Dvořák is written in C++, using the Parma Polyhedra Library to enumerate vertices of polyhedrons and Gurobi to solve linear programs. While the Parma Polyhedra Library operates in exact arithmetics, Gurobi uses floating-point arithmetics. However, to eliminate the issue of rounding errors, we convert the obtained solutions (of primal or dual programs, depending on the outcome) to rational numbers and verify their validity in exact arithmetics.
- The program by Bernard Lidický is written in SageMath. It can use variety of solvers shipped with SageMath, including Gurobi and/or Parma Polyhedral Library.

2 Preliminaries

Following the ideas of [4, 7], we are going to prove a strengthening of Theorem 1.4 where we put additional constraints on the coloring of vertices of degree less than three. When coloring the given graph G , we generally choose an induced subgraph H of G , find its coloring inductively, then extend the coloring to G , taking advantage of these additional constraints on the coloring of H . However, occasionally it is necessary not to enforce these constraints at some of the vertices of H , and to treat the vertices according to their original degree in G rather than their current degree in H . To deal with this issue, we introduce the following definition.

A *graph with external degrees* (an *e-graph* for short) is a graph G (the *underlying graph* of the e-graph) together with a function $d_G : V(G) \rightarrow \mathbb{Z}_0^+$ such that $d_G(v) \geq \deg v$ for every $v \in V(G)$. We say $\deg v$ is the *degree* and $d_G(v)$ is the *external degree* of the vertex v of the e-graph. A vertex $v \in V(G)$ is *nailed* if $d_G(v) > \deg v$. We say an e-graph G is *subcubic* if $d_G(v) \leq 3$ for every $v \in V(G)$, and *cubic* if $d_G(v) = 3$ for every $v \in V(G)$; let us remark the underlying graph of a cubic e-graph may contain vertices of degree less than three. In contrast, we say an e-graph G is *3-regular* if all its vertices have degree three. Note that if G is subcubic and has minimum degree at least two, then the function d_G is uniquely determined by the set of nailed vertices of G (each nailed vertex v has degree two and $d_G(v) = 3$, while all other vertices u satisfy $d_G(u) = \deg u$); in figures, nailed vertices are drawn in black and all other vertices in white. We say that G is *valid* if G is subcubic, triangle-free, and $d_G(v) \geq 2$ for every $v \in V(G)$. For $Y \subseteq G$, let $G[Y]$ denote the e-graph consisting of the subgraph of G induced by Y and the restriction of d_G to Y ; we say that $G[Y]$ is an *induced sub-e-graph* of G . If $Y \neq V(G)$, we say $G[Y]$ is a *proper induced sub-e-graph*. Note that an induced sub-e-graph of a valid e-graph is itself valid.

For a measurable set S of real numbers, let $|S|$ denote the measure of S . For a real number $r > 0$, by a *set r -coloring* of an e-graph G , we mean a function φ assigning a measurable subset of the interval $[0, r)$ to every vertex v of G such that $\varphi(u) \cap \varphi(v) = \emptyset$ for every $uv \in E(G)$. Let us now introduce a key definition.

Definition 2.1. *Let φ be a set 11-coloring of a subcubic e-graph G . We say φ is an 11/4-coloring of G if $|\varphi(v)| = 7 - d_G(v)$ for every $v \in V(G)$. A subcubic e-graph G is 11/4-colorable if G has an 11/4-coloring.*

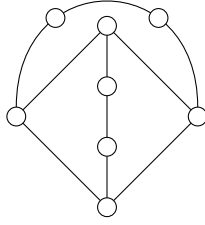

Figure 1: The graph K_4^+ .

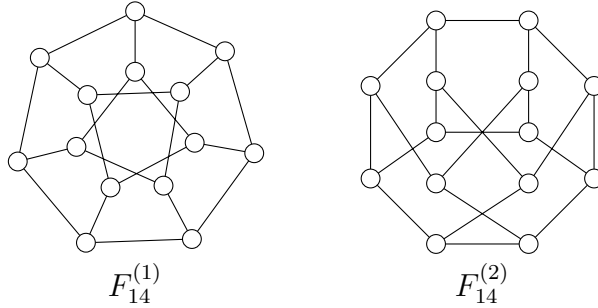

Figure 2: Valid critical cubic e-graphs $F_{14}^{(1)}$ and $F_{14}^{(2)}$.

That is, each vertex receives a color set of measure at least four, and we require sets of larger measure to be assigned to vertices with $d_G(v) < 3$. In particular

$$|\varphi(v)| = \begin{cases} 4 & \text{if } d_G(v) = 3, \\ 5 & \text{if } d_G(v) = 2. \end{cases}$$

Observe that if the e-graph G is cubic, then it has an $11/4$ -coloring if and only if the underlying graph of G is fractionally $11/4$ -colorable. A subcubic e-graph G is *critical* if G does not have an $11/4$ -coloring, but every proper induced sub-e-graph of G has an $11/4$ -coloring. Critical e-graphs characterize $11/4$ -colorability in the following sense.

Observation 2.2. *A subcubic e-graph G is $11/4$ -colorable if and only if G does not contain a critical induced sub-e-graph.*

Let K_4^+ be the graph obtained from the clique K_4 by subdividing twice the edges of a perfect matching; see Figure 1. Let \mathcal{C} denote the set of all pairwise non-isomorphic valid critical e-graphs. Let us now state the strengthening of Theorem 1.4 that we are about to prove in the rest of the paper.

Theorem 2.3. *The set \mathcal{C} contains exactly 176 e-graphs. Out of these, only the two 14-vertex e-graphs depicted in Figure 2 are cubic. Furthermore:*

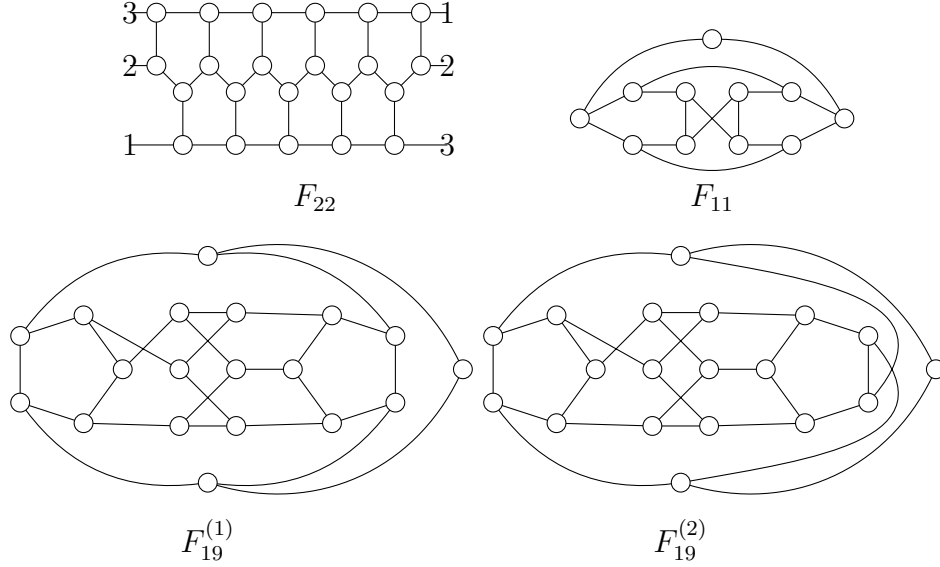

Figure 3: Subcubic graphs F_{22} and F_{11} with fractional chromatic number $\frac{11}{4}$ and $F_{19}^{(1)}$ and $F_{19}^{(2)}$ with fractional chromatic number $\frac{19}{7}$.

- (a) Each e-graph in \mathcal{C} has at most two nailed vertices, and if it has two, then its underlying graph is either C_5 or K_4^+ .
- (b) If $G \in \mathcal{C}$ has exactly one nailed vertex, then G contains at least three non-nailed vertices of degree two.
- (c) No graph in \mathcal{C} has exactly three vertices of degree two.

This implies our main result.

Proof of Theorem 1.4. We can assume G is connected, as otherwise we can color each component separately. Let us extend G to a valid cubic e-graph by defining $d_G(v) = 3$ for every $v \in V(G)$. By the assumptions, G is not isomorphic to either of the e-graphs depicted in Figure 2. Moreover, the e-graphs depicted in Figure 2 are 3-regular, and since G is connected and has maximum degree at most three, it does not contain either of them as a proper induced sub-e-graph. Since G is cubic, all its induced sub-e-graphs are cubic, and thus Theorem 2.3 implies that G does not contain a critical induced sub-e-graph. By Observation 2.2, G has an $11/4$ -coloring, and thus the underlying graph of G has fractional chromatic number at most $11/4$. \square

Let \mathcal{C}_0 be the set of e-graphs listed in the Appendix (which we obtained by a computer-assisted enumeration). Using computer, we also verified that all e-graphs in \mathcal{C}_0 are valid, subcubic, critical (so $\mathcal{C}_0 \subseteq \mathcal{C}$), and pairwise non-isomorphic, $|\mathcal{C}_0| = 176$, the only cubic e-graphs in \mathcal{C}_0 are the two drawn in Figure 2, and the following conditions analogous to those from Theorem 2.3 hold:

- (a0) Each e-graph in \mathcal{C}_0 has at most two nailed vertices, and if it has two, then its underlying graph is either C_5 or K_4^+ .
- (b0) If $G \in \mathcal{C}_0$ has exactly one nailed vertex, then G contains at least three non-nailed vertices of degree two.
- (c0) No graph in \mathcal{C}_0 has exactly three vertices of degree two.

Therefore, Theorem 2.3 is implied by the following lemma.

Lemma 2.4. *Every e-graph $G \in \mathcal{C}$ belongs to \mathcal{C}_0 .*

The rest of the paper is devoted to the proof of Lemma 2.4. We proceed by contradiction; we say a graph G is a *minimum counterexample* if G is an e-graph in $\mathcal{C} \setminus \mathcal{C}_0$ with the smallest number of vertices and subject to that the smallest number of nailed vertices. Thus, G is valid and critical, and in particular, G does not have an 11/4-coloring.

Note that the subcubic e-graphs with at most two nailed vertices and underlying graphs C_5 or K_4^+ are not 11/4-colorable, and they all belong to \mathcal{C}_0 . Since a minimum counterexample is critical, we obtain the following useful observation.

Observation 2.5. *If G is a minimum counterexample, then every induced sub-e-graph of G whose underlying graph is C_5 or K_4^+ has at least three nailed vertices. In particular, if G has no nailed vertices, then every 5-cycle in G contains at least three vertices of degree three.*

Let us also note the following simple but useful observation.

Observation 2.6. *Let G be an e-graph and let H be an induced sub-e-graph of G . Every vertex $v \in V(H)$ incident with an edge $e \in E(G) \setminus E(H)$ is nailed in H .*

2.1 Coloring and reducibility

The initial part of the proof of Lemma 2.4 consists of a series of reducible configuration arguments. In the ordinary proper coloring setting, such an argument proceeds along the following lines. Suppose $G = G_1 \cup G_2$, where G_1 and G_2 are proper induced subgraphs of G , and let $S = G_1 \cap G_2$. Suppose moreover that G_1 is a quite small graph, and thus we can directly verify that it satisfies the following condition: Every proper coloring of S (by the given number of colors) extends to a proper coloring of G_1 . This implies that G has a proper coloring by the given number of colors if and only if G_2 has one, and thus the argument can be finished by applying induction.

In the fractional coloring setting, the argument is slightly more involved, since S typically has infinitely many fractional colorings by the given measure of colors. However, through the standard linear programming reformulation of fractional coloring, it can be seen that the fractional colorings of S (up to measure-preserving transformations) form a polytope, and to verify that all of them extend to fractional colorings of G_1 , it suffices to verify this is the case for the colorings that form the vertices of this polytope. In this section, we describe this idea in more detail.

Let $r > 0$ be a real number. The set r -colorings of an e-graph G can be convexly combined, in the following sense. Let $\varphi_1, \dots, \varphi_n$ be set r -colorings of G , and let $\lambda_1, \dots, \lambda_n \geq 0$ be real numbers summing to 1. For $i = 1, \dots, n$, choose arbitrarily a linear bijection f_i from $[0, r)$ to a sub-interval of $[0, r)$ of length $\lambda_i r$, so that the intervals $f_1([0, r)), \dots, f_n([0, r))$ are pairwise disjoint. Let $\sum_{i=1}^n \lambda_i \varphi_i$ denote the function φ defined by $\varphi(v) = \bigcup_{i=1}^n f_i(\varphi_i(v))$ for every $v \in V(G)$.

Observation 2.7. *Let G be an e-graph and let $r > 0$ be a real number. Let $\varphi_1, \dots, \varphi_n$ be set r -colorings of G , and let $\lambda_1, \dots, \lambda_n \geq 0$ be real numbers summing to 1. Let $\varphi = \sum_{i=1}^n \lambda_i \varphi_i$. Then φ is a set r -coloring of G and $|\varphi(v)| = \sum_{i=1}^n \lambda_i |\varphi_i(v)|$ for every $v \in V(G)$.*

Let G be a subcubic e-graph and let $\mathcal{I}(G)$ denote the set of all independent sets of G . Note that G has an 11/4-coloring if and only if we can assign a non-negative real number $x(I)$ to every set $I \in \mathcal{I}(G)$ so that

- for every $v \in V(G)$, we have $\sum_{I \ni v} x(I) = 7 - d_G(v)$, and
- $\sum_{I \in \mathcal{I}(G)} x(I) = 11$.

Indeed, if φ is an 11/4-coloring, for a color $c \in [0, 11)$ let $\varphi^{-1}(c) = \{v \in V(G) : c \in \varphi(v)\}$ be the (independent) set of vertices on which c appears, and for each independent set I , set $x(I)$ to be the measure of the set $\{c : \varphi^{-1}(c) = I\}$. The converse is similarly easy. We say that this function $x : \mathcal{I}(G) \rightarrow \mathbb{R}_0^+$ is the *LP representation* of the coloring φ (as the constraints on x form a linear program). Note that two 11/4-colorings have the same LP representation exactly if they differ only by a measure-preserving transformation.

The functions $x \in \mathbb{R}^{\mathcal{I}(G)}$ satisfying the above constraints form a polytope, which we denote by $\mathcal{P}(G)$, i.e.,

$$\mathcal{P}(G) = \left\{ x \in \mathbb{R}^{\mathcal{I}(G)} : \begin{array}{l} x(I) \geq 0 \text{ for all } I \in \mathcal{I}(G), \\ \sum_{I \in \mathcal{I}(G)} x(I) = 11, \\ \sum_{I \ni v} x(I) = 7 - d_G(v) \text{ for all } v \in V(G) \end{array} \right\}$$

For a set $S \subseteq V(G)$, the *restriction* of x to S is the function $y : \mathcal{I}(G[S]) \rightarrow \mathbb{R}_0^+$ defined by

$$y(J) = \sum_{I \in \mathcal{I}(G), I \cap S = J} x(I) \tag{1}$$

for $J \in \mathcal{I}(G[S])$. Note that if x is the LP representation of an 11/4-coloring φ , then y is the LP representation of the restriction of φ to $G[S]$. If y is a restriction of the LP-representation of some 11/4-coloring of G , we say y *extends* to G . Observe that y extends to G if and only if there exists $x \in \mathcal{P}(G)$ satisfying the linear equations (1), and thus extendability of y can be tested algorithmically via linear programming.

We often deal with various conditions on 11/4-colorings φ of $G[S]$, of form $|\varphi(u) \cap \varphi(v)| \leq \alpha$ or $|\varphi(u) \cup \varphi(v)| \leq \alpha$, for vertices $u, v \in S$ and a non-negative real number α . In the LP representation y of φ , these correspond to the linear constraints $\sum_{J \supseteq \{u, v\}} y(J) \leq \alpha$ or $\sum_{J \cap \{u, v\} \neq \emptyset} y(J) \leq \alpha$. In greater generality, the LP representation y of φ may be known to belong to a certain polytope $P \subseteq \mathcal{P}(G[S])$.

Definition 2.8. Let G be a subcubic e -graph, let S be a subset of its vertices, and let P be a subpolytope of $\mathcal{P}(G[S])$. The e -graph G is a reducible configuration subject to P if every vertex of the polytope P extends to G .

This implies that every 11/4-coloring of $G[S]$ satisfying the constraints expressed by P extends to an 11/4-coloring of G . To simplify the statements, we will usually specify P only by listing the conditions on the 11/4-colorings φ of $G[S]$ it represents; e.g., by “ G is a reducible configuration subject to $|\varphi(u) \cap \varphi(v)| \leq 1$ ”, we mean “ G is a reducible configuration subject to the polytope P defined as the intersection of $\mathcal{P}(G[S])$ with the half-space $\sum_{J \supseteq \{u,v\}} y(J) \leq 1$ ”, and so on. Let us now state the key property of reducible configurations.

Lemma 2.9. Let $G = G_1 \cup G_2$, where G_2 is an induced subgraph of G , and let $S = V(G_1) \cap V(G_2)$. Let $P \subseteq \mathcal{P}(G_1[S])$ be a polytope and suppose that G_1 is a reducible configuration subject to P . Let x_0 be the LP representation of an 11/4-coloring of G_2 , and let $y \in \mathcal{P}(G[S])$ be the restriction of x_0 to S . Let $y' \in \mathcal{P}(G_1[S])$ be obtained from y by setting $y'(J) = 0$ for every $J \in \mathcal{I}(G_1[S]) \setminus \mathcal{I}(G[S])$. If $y' \in P$, then G has an 11/4-coloring.

Proof. Let y_1, \dots, y_m be the vertices of P . Note that $y' \in P$ is a convex combination of the vertices, and thus there exist $\alpha_1, \dots, \alpha_m \geq 0$ such that $\sum_{i=1}^m \alpha_i = 1$ and $\sum_{i=1}^m \alpha_i y_i = y'$. For $i = 1, \dots, m$, since G_1 is a reducible configuration subject to P , there exists an 11/4-coloring of G_1 with the LP representation x_i whose restriction to S is equal to y_i . Then $x' = \sum_{i=1}^m \alpha_i x_i$ is the LP representation of an 11/4-coloring of G_1 with restriction y' . Let $x : \mathcal{I}(G) \rightarrow \mathbb{R}_0^+$ be defined by setting

$$x(I) = \frac{x'(I \cap V(G_1))x_0(I \cap V(G_2))}{y(I \cap S)}$$

for every $I \in \mathcal{I}(G)$ such that $y(I \cap S) \neq 0$, and $x(I) = 0$ for $I \in \mathcal{I}(G)$ such that $y(I \cap S) = 0$ (let us remark that in the latter case we also have $x_0(I \cap V(G_2)) = x'(I \cap V(G_1)) = 0$). It is easy to verify that x is the LP representation of an 11/4-coloring of G . \square

Observe that the reducibility of a configuration can be tested algorithmically, since the (finitely many) vertices of P can be enumerated and their extendability can be verified via linear programming as noted above. Throughout the paper, whenever we claim a configuration is reducible, we perform such a verification in our programs, and we will not mention this explicitly.

When arguing reducibility, we occasionally do not know whether all vertices in S are pairwise distinct, or whether they have external degree two or three. For example, we consider a configuration consisting of a 4-cycle K of vertices of degree three. The e -graph G_1 consists of K , the set S of the neighbors of the vertices of K outside of K , and the edges between K and S ; in this situation, we do not know anything about the degrees of vertices of S , or even whether S consists of two, three, or four vertices. So, it would seem we need to go over all these cases and separately test their reducibility. However, typically it suffices to prove the reducibility in the most restrictive case that the vertices in S are pairwise distinct

and those that can have external degree two do: We are arguing that a precoloring φ of S subject to certain constraints extends to S . If two vertices of S are identified we can instead consider the situation where they are distinct but receive the same color set. If a vertex has external degree three, it is typically possible to add colors of measure one to its color set so that the constraints under which we prove the reducibility are satisfied, obtaining a valid precoloring for the configuration where the vertex has external degree two.

To apply Lemma 2.9, we need to ensure that the 11/4-coloring of G_2 (which exists if G is critical and $G_2 \neq G$) satisfies the restrictions expressed by P . To do so, we often find an 11/4-coloring of a super-e-graph G'_2 of G_2 , rather than just of G_2 itself (a more involved argument is then needed to show that G' has an 11/4-coloring, the criticality of G is no longer sufficient). The e-graph G'_2 is obtained from G by replacing the known configuration G_1 by a smaller set configuration. More precisely, the replacement operation is defined as follows. Let F and R be e-graphs sharing a subset $B = V(F) \cap V(R)$ of their (boundary) vertices, where $R[B] \subseteq F[B]$; these e-graphs specify the original configuration F and its replacement R . Let $G = G_1 \cup G_2$ and $G'_2 = G'_1 \cup G_2$ be e-graphs such that G_2 is an induced sub-e-graph of G'_2 and $V(G_1) \cap V(G_2) = V(G'_1) \cap V(G_2)$; let $S = V(G_1) \cap V(G_2)$. If there exist isomorphisms f_F of F to G_1 and f_R of R to G'_1 such that $f_F(B) = S$ and $f_F \upharpoonright B = f_R \upharpoonright B$, then we say that G'_2 is obtained from G by *replacing a sub-e-graph matching F by R* ¹.

2.2 Common arguments

We now introduce a shorthand for a line of reasoning we frequently use throughout the proof of Lemma 2.4. The setting is as follows.

- G is a minimum counterexample,
- G_1 is a sub-e-graph of G and S is a set of vertices of G_1 such that no edge of $E(G) \setminus E(G_1)$ has an end in $V(G_1) \setminus S$,
- P is (a list of conditions determining) a subpolytope of $\mathcal{P}(G_1[S])$ as described in the previous section, and
- H is an e-graph with $V(H) \cap V(G) = S$, $H[S] \supseteq G_1[S]$, and $d_H(v) = d_G(v)$ for all $v \in S$.

Note there exists a unique induced sub-e-graph G_2 of G such that $G = G_1 \cup G_2$ and $S = V(G_1) \cap V(G_2)$. Let G' be the e-graph $G_2 \cup H$. Suppose we verify that the following conditions are satisfied.

¹A careful reader might wonder whether the inequality $R[B] \subseteq F[B]$ is in the right direction; when replacing the reducible configuration by a smaller one, it may be useful to add new edges between the boundary vertices, but it is rarely possible to drop them. Indeed, we generally use the replacement operation in the opposite direction, where F is a smaller graph we used to replace the reducible configuration R , and we need to work out what graphs may arise from those in \mathcal{C}_0 by the inverse to such a replacement. See the following section for more details.

- (i) The e-graph G' is valid and $|V(G')| < |V(G)|$.
- (ii) The e-graph G_1 is a reducible configuration subject to P .
- (iii) Every 11/4-coloring of H satisfies the conditions P .
- (iv) For every e-graph in \mathcal{C}_0 , replacing any sub-e-graph matching H by G_1 results in an e-graph that either is not critical or belongs to \mathcal{C}_0 .

Since G does not have an 11/4-coloring, the condition (ii) and Lemma 2.9 imply that no 11/4-coloring of G_2 satisfies P . By (iii), it follows that no 11/4-coloring of G_2 extends to G' , and thus G' does not have an 11/4-coloring. Hence, G' contains a critical induced sub-e-graph F . By (i), F is valid and $|V(F)| < |V(G)|$, and thus the minimality of G implies $F \in \mathcal{C}_0$. We claim that F is actually a proper induced sub-e-graph of G' , that is, $F \neq G'$. Indeed, note that G is obtained from G' by replacing a subgraph matching H by G_1 . If $G' = F$, then since $F \in \mathcal{C}_0$, (iv) would imply that G either is not critical or belongs to \mathcal{C}_0 , a contradiction to the assumption that G is a minimum counterexample.

In the proof of Lemma 2.4, we repeatedly use this line of reasoning, followed by a further analysis of the e-graph F . We use the statement “*The standard argument for the configuration G_1 attaching at S and the replacement graph H enforcing P gives an e-graph G' and its proper induced sub-e-graph $F \in \mathcal{C}_0$.*” as a shorthand for the argument described above, including the claim that we verified the conditions (i)–(iv). The condition (i) is usually straightforward to verify (it suffices to check we do not increase the degrees of vertices and do not create triangles by the replacement). The condition (ii) is verified by computer (or by hand for very simple e-graphs G_1) using the procedure we described after Lemma 2.9. The condition (iv) is also generally verified by a computer-assisted enumeration, or by hand in simple cases when H contains at least two nailed vertices, so that (a0) applies to e-graphs containing H . The condition (iii) generally directly follows from the following easy observation.

Observation 2.10. *Let H be an e-graph and let S be a subset of vertices of H . Let φ be an 11/4-coloring of H . For any $A \subseteq S$, if all vertices in A are adjacent to a vertex $z \in V(H) \setminus S$, then*

$$\left| \bigcup_{v \in A} \varphi(v) \right| \leq d_H(z) + 4.$$

Let B and C be non-empty subsets of S . If all vertices in B are adjacent to a vertex $z_1 \in V(H) \setminus S$, all vertices in C are adjacent to a vertex $z_2 \in V(H) \setminus S$, and $z_1 z_2 \in E(H)$, then

$$\left| \left(\bigcup_{v \in B} \varphi(v) \right) \cap \left(\bigcup_{v \in C} \varphi(v) \right) \right| \leq d_H(z_1) + d_H(z_2) - 3.$$

Proof. In the former case, $\bigcup_{v \in A} \varphi(v) \subseteq [0, 11] \setminus \varphi(z)$ and $|[0, 11] \setminus \varphi(z)| = d_H(z) + 4$. In the latter case, $\left(\bigcup_{v \in B} \varphi(v) \right) \cap \left(\bigcup_{v \in C} \varphi(v) \right) \subseteq [0, 11] \setminus (\varphi(z_1) \cup \varphi(z_2))$ and $|[0, 11] \setminus (\varphi(z_1) \cup \varphi(z_2))| = 11 - |\varphi(z_1)| - |\varphi(z_2)| = d_H(z_1) + d_H(z_2) - 3$. \square

We call all inequalities among the color sets of vertices of S implied by this observation the *trivial constraints* of H , and we say that a vertex $z \in V(H) \setminus S$ *participates in trivial constraints* if z is contained in a path in H of length at most three with both ends in S .

Let us now introduce another shorthand, applied in the following setting.

- G is a valid critical e-graph,
- G_1 is a sub-e-graph of G and S is a set of vertices of G_1 such that no edge of $E(G) \setminus E(G_1)$ has an end in $V(G_1) \setminus S$, and
- some vertex $z \in V(G_1) \setminus S$ does not participate in the trivial constraints of G_1 .

Suppose we verify (using computer or by hand for very simple e-graphs G_1) that

- (r) the e-graph G_1 is a reducible configuration subject to its trivial constraints.

Note there exists a unique proper induced sub-e-graph G_2 of G such that $G = G_1 \cup G_2$ and $S = V(G_1) \cap V(G_2)$. Since G is critical, the graph $G - z$ has an 11/4-coloring φ , and since z does not participate in the trivial constraints of G_1 , the restriction of φ to $V(G_2)$ satisfies the trivial constraints of G_1 . By the condition (r) and Lemma 2.9, it follows that G has an 11/4-coloring. This is a contradiction, since G is critical. This shows that the configuration G_1 cannot appear in G ; we use the statement “*The configuration G_1 attaching at S is excluded by reducibility.*” as a shorthand for this argument.

3 Connectivity and nailed vertices

We now start our work on restricting the structure of minimum counterexamples. Since a minimum counterexample is critical, it is connected. In fact, it is straightforward to argue it is 2-connected, as we see next.

Lemma 3.1. *Let G be a critical e-graph. For every clique K in G (of size one or two) in G , the graph $G - K$ is connected. Consequently, G is 2-connected and if $|V(G)| > 2$, then it has minimum degree at least two.*

Proof. If $G - K$ is not connected, then let G_1 and G_2 be proper induced sub-e-graphs of G intersecting in K . By the criticality of G , both G_1 and G_2 have an 11/4-coloring, and by applying a suitable measure-preserving bijection on the 11/4-coloring of G_2 , we can assume that the two 11/4-colorings assign the same color sets to vertices of K . This gives an 11/4-coloring of G , which is a contradiction. \square

We need the following observation on the coloring of paths.

Observation 3.2. *Let P be a subcubic e-graph whose underlying graph is a path $v_0 \dots v_k$ of length $k \geq 1$. An 11/4-coloring φ of v_0 and v_k extends to an 11/4-coloring of P if and only if*

- k is odd and

$$|\varphi(v_0) \cap \varphi(v_k)| \leq \left(\sum_{i=1}^{k-1} d_P(v_i) \right) - 3(k-1)/2, \text{ or}$$

- k is even and

$$|\varphi(v_0) \cup \varphi(v_k)| \leq \left(\sum_{i=1}^{k-1} d_P(v_i) \right) - (3k-14)/2.$$

In particular, if P is valid and either $k \geq 3$ is odd and $|\varphi(v_0) \cap \varphi(v_k)| \leq 1$, or $k \geq 2$ is even and $|\varphi(v_0) \cup \varphi(v_k)| \leq 6$, then φ extends to an 11/4-coloring of P .

Proof. By induction on k . In the basic case $k = 1$, the assumption gives $|\varphi(v_0) \cap \varphi(v_1)| = 0$, as needed for the set coloring of the path. Hence, assume that $k \geq 2$. If k is even, choose $\varphi(v_{k-1}) \subseteq [0, 11] \setminus \varphi(v_k)$ of measure $7 - d_P(v_{k-1})$ with $|\varphi(v_0) \cap \varphi(v_{k-1})|$ minimum. By the induction hypothesis, we see that φ extends to P if and only if it extends to $P - v_k$ with this choice of $\varphi(v_{k-1})$. We have $|\varphi(v_0) \cap \varphi(v_{k-1})| = \max(0, (7 - d_P(v_{k-1})) - (11 - |\varphi(v_0) \cup \varphi(v_k)|))$, which is smaller or equal to $(\sum_{i=1}^{k-2} d_P(v_i)) - 3(k-2)/2$ if and only if $|\varphi(v_0) \cup \varphi(v_k)| \leq (\sum_{i=1}^{k-1} d_P(v_i)) - (3k-14)/2$.

The case $k > 1$ is odd is dealt with analogously, choosing $\varphi(v_{k-1})$ with $|\varphi(v_0) \cup \varphi(v_{k-1})|$ minimum, so that $|\varphi(v_0) \cup \varphi(v_{k-1})| = (7 - d(v_{k-1})) + |\varphi(v_0) \cap \varphi(v_k)|$. The final claim follows from the fact that if P is valid (so that $d_P(v_i) \geq 2 > 3/2$ for $1 \leq i \leq k-1$), the right-hand sides of the conditions from the statement of this observation are greater or equal to 1 if $k \geq 3$ is odd and to 6 if $k \geq 2$ is even. \square

By Lemma 3.1, minimum counterexamples are 2-edge-connected. We now further restrict 2-edge-cuts.

Lemma 3.3. *Let G be a minimum counterexample, and let $\{A_1, A_2\}$ be a partition of $V(G)$ to non-empty parts. If G contains exactly two edges between A_1 and A_2 , then there exists $i \in \{1, 2\}$ such that all vertices in A_i have degree two.*

Proof. Suppose for a contradiction that each of A_1 and A_2 contains a vertex of degree three. Then there exist $A'_1 \subseteq A_1$, $A'_2 \subseteq A_2$, and disjoint induced paths P_1 and P_2 in G such that for $i \in \{1, 2\}$ the path P_i has ends $x_i \in A'_1$ and $y_i \in A'_2$ of degree three and is otherwise disjoint from $A'_1 \cup A'_2$, and $G = G[A'_1] \cup G[A'_2] \cup P_1 \cup P_2$. Let us remark that $x_1 \neq x_2$ and $y_1 \neq y_2$, as otherwise the edge incident with x_1 or y_1 not contained in $P_1 \cup P_2$ would form a bridge in G .

Let G_1 be the e-graph obtained from $G[A'_1]$ by adding a path $x_1 a b x_2$, with $d_{G_1}(a) = d_{G_1}(b) = 3$, and let G_2 be defined analogously. Suppose first both G_1 and G_2 are 11/4-colorable, and let φ_1 and φ_2 be the restriction of their 11/4-colorings to A'_1 and A'_2 , respectively. By Observation 2.10 (or Observation 3.2), we have $|\varphi_1(x_1) \cap \varphi_1(x_2)| \leq 3$ and $|\varphi_2(y_1) \cap \varphi_2(y_2)| \leq 3$.

Observe that by applying a measure-preserving bijection to φ_2 , we can without loss of generality assume any one of the following three conditions holds, as needed:

- (i) $|\varphi_1(x_1) \cup \varphi_2(y_1)| \leq 6$ and $|\varphi_1(x_2) \cup \varphi_2(y_2)| \leq 6$;

(ii) $|\varphi_1(x_1) \cap \varphi_2(y_1)| = 0$ and $|\varphi_1(x_2) \cup \varphi_2(y_2)| \leq 6$;

(iii) $|\varphi_1(x_1) \cap \varphi_2(y_1)| = 0$ and $|\varphi_1(x_2) \cap \varphi_2(y_2)| = 0$.

Subproof. We show how to enforce the condition (ii); the conditions (i) and (iii) are dealt with similarly. For $r \in \{0, 3\}$, let $\psi_{1,r}$ be the set 11-coloring of $\{x_1, x_2\}$ defined by $\psi_{1,r}(x_1) = [0, 4)$ and $\psi_{1,r}(x_2) = [4-r, 8-r)$, so that $|\psi_{1,r}(x_1) \cap \psi_{1,r}(x_2)| = r$. Letting $\lambda_1 = |\varphi_1(x_1) \cap \varphi_1(x_2)|/3$, we can without loss of generality assume $\lambda_1\psi_{1,3} + (1-\lambda_1)\psi_{1,0}$ is the restriction of φ_1 to $\{x_1, x_2\}$. Define $\psi_{2,0}$, $\psi_{2,3}$ and λ_2 analogously so that $\lambda_2\psi_{2,3} + (1-\lambda_2)\psi_{2,0}$ is the restriction of φ_2 to $\{y_1, y_2\}$.

Observe that for $r_1, r_2 \in \{0, 3\}$, there exists a set 11-coloring $\psi_{2,r_2,(ii),r_1}$ of $\{y_1, y_2\}$ obtained by applying a measure-preserving bijection to ψ_{2,r_2} and such that $|\psi_{1,r_1}(x_1) \cap \psi_{2,r_2,(ii),r_1}(y_1)| = 0$ and $|\psi_{1,r_1}(x_2) \cup \psi_{2,r_2,(ii),r_1}(y_2)| \leq 6$. Indeed, we can let

- $\psi_{2,0,(ii),0}(y_1) = [7, 11)$ and $\psi_{2,0,(ii),0}(y_2) = [3, 7)$,
- $\psi_{2,3,(ii),0}(y_1) = [5, 9)$ and $\psi_{2,3,(ii),0}(y_2) = [4, 8)$,
- $\psi_{2,0,(ii),3}(y_1) = [7, 11)$ and $\psi_{2,0,(ii),3}(y_2) = [1, 5)$,
- $\psi_{2,3,(ii),3}(y_1) = [4, 8)$ and $\psi_{2,3,(ii),3}(y_2) = [3, 7)$.

Now let $\alpha_{0,0} = (1-\lambda_1)(1-\lambda_2)$, $\alpha_{0,3} = (1-\lambda_1)\lambda_2$, $\alpha_{3,0} = \lambda_1(1-\lambda_2)$ and $\alpha_{3,3} = \lambda_1\lambda_2$. Then

$$\psi_1 = \sum_{r_1, r_2 \in \{0,3\}} \alpha_{r_1, r_2} \psi_{1, r_1} = \lambda_1 \psi_{1,3} + (1-\lambda_1) \psi_{1,0}$$

is the restriction of φ_1 to $\{x_1, x_2\}$, and

$$\psi_2 = \sum_{r_1, r_2 \in \{0,3\}} \alpha_{r_1, r_2} \psi_{2, r_2, (ii), r_1}$$

is obtained by applying a measure-preserving bijection θ to

$$\sum_{r_1, r_2 \in \{0,3\}} \alpha_{r_1, r_2} \psi_{2, r_2} = \lambda_2 \psi_{2,3} + (1-\lambda_2) \psi_{2,0},$$

which is the restriction of φ_2 to $\{y_1, y_2\}$. Moreover, by linearity, we have

$$\begin{aligned} |\varphi_1(x_1) \cap \theta^{-1}(\varphi_2(y_1))| &= |\psi_1(x_1) \cap \psi_2(y_1)| \\ &= \sum_{r_1, r_2 \in \{0,3\}} \alpha_{r_1, r_2} |\psi_{1, r_1}(x_1) \cap \psi_{2, r_2, (ii), r_1}(y_1)| = 0 \\ |\varphi_1(x_2) \cup \theta^{-1}(\varphi_2(y_2))| &= |\psi_1(x_2) \cup \psi_2(y_2)| \\ &= \sum_{r_1, r_2 \in \{0,3\}} \alpha_{r_1, r_2} |\psi_{1, r_1}(x_2) \cup \psi_{2, r_2, (ii), r_1}(y_2)| \leq 6. \end{aligned}$$

Hence, (ii) holds after applying the measure-preserving bijection θ^{-1} to φ_2 . ■

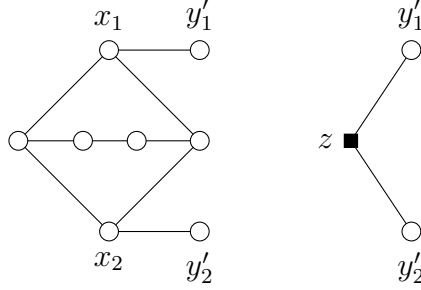

Figure 4: The reducible configuration G_3 and the replacement graph H_3 .

We can by symmetry assume that if P_1 has even length, then so does P_2 . By applying a measure-preserving bijection if necessary, we can without loss of generality assume that if P_1 and P_2 both have even length, then (i) holds, if P_1 has odd length and P_2 has even length then (ii) holds, and if P_1 and P_2 both have odd length, then (iii) holds. But then for $i \in \{1, 2\}$, Observation 3.2 implies that $\varphi_1 \cup \varphi_2$ extends to an $11/4$ -coloring of P_i , thus giving an $11/4$ -coloring of G . This is a contradiction.

Hence, we can by symmetry assume G_1 does not have an $11/4$ -coloring, and thus G_1 contains a critical induced sub-e-graph F_1 . Recall that since G is 2-connected, we have $x_1 \neq x_2$, and thus G_1 (and consequently also F_1) is triangle-free. Note that since $\deg y_1 = 3$ and $\deg y_2 = 3$, we have $|A'_2| > 2$, and thus $|V(F_1)| \leq |V(G_1)| < |V(G)|$. Since G is a minimum counterexample, it follows that $F_1 \in \mathcal{C}_0$. Since G is critical, F_1 is not an induced sub-e-graph of G , and thus $a, b \in V(F_1)$. Hence F_1 contains two nailed vertices a and b , and by (a0) no other vertex of F_1 is nailed and the underlying graph of F_1 is either C_5 or K_4^+ . Since no vertex of F_1 other than a or b is nailed and G is connected, we conclude using Observation 2.6 that $G_1 = F_1$. Furthermore, since $\deg x_1 = 3$, G_1 cannot be a 5-cycle, and thus the underlying graph of G_1 is K_4^+ .

For $i \in \{1, 2\}$, let y'_i be the neighbor of x_i in P_i . Let G_3 be the e-graph obtained from $G[A'_1]$ by adding the edges $x_1y'_1$ and $x_2y'_2$. Since G_1 is K_4^+ with only a and b nailed, G_3 is the e-graph depicted in Figure 4. Let $S_3 = \{y'_1, y'_2\}$ and let H_3 be the e-graph with the vertex set $S_3 \cup \{z\}$, edges y'_1z and y'_2z , and $d_{H_3}(z) = 3$. The standard argument for the configuration G_3 attaching at S_3 and the replacement graph H_3 enforcing $|\varphi(y'_1) \cup \varphi(y'_2)| \leq 7$ gives an e-graph G' and its proper induced sub-e-graph $F_3 \in \mathcal{C}_0$ (note that by Lemma 3.1, we have $y'_1y'_2 \notin E(G)$, and thus G' is triangle-free). Since G is critical, F_3 is not an induced sub-e-graph of G , and thus $z \in V(F_3)$. However, Lemma 3.1 implies that G' is 2-connected, and since $F_3 \neq G'$, it follows by Observation 2.6 that F_3 contains at least two nailed vertices (those with a neighbor in $V(G') \setminus V(F_3)$) in addition to z , which contradicts (a0). \square

Let us now derive two simple consequences of Lemma 3.3.

Lemma 3.4. *A minimum counterexample has no nailed vertices.*

Proof. Suppose for a contradiction that v is a nailed vertex of a minimum counterexample G , and thus $\deg v = 2$ and $d_G(v) = 3$. Let G' be the e-graph obtained from G by setting

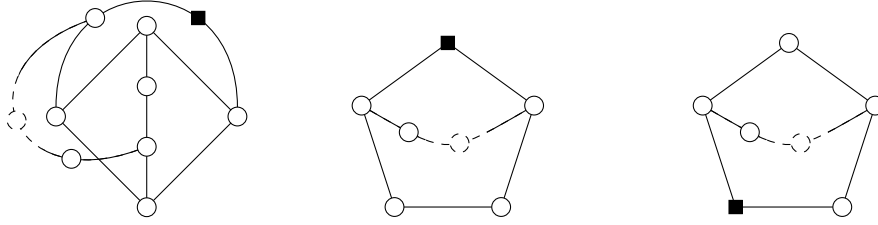

Figure 5: The graphs arising in the final case analysis in Lemma 3.4.

$d_{G'}(v) = 2$. Since G is not $11/4$ -colorable, G' is not $11/4$ -colorable, and thus it contains a critical induced sub-e-graph F . Note that $|V(F)| \leq |V(G)|$ and F has fewer nailed vertices than G , and thus the minimality of G implies $F \in \mathcal{C}_0$. By a computer-assisted enumeration, we verified that for every e-graph in \mathcal{C}_0 , nailing a vertex results in an e-graph that either is not critical or belongs to \mathcal{C}_0 . Since $G \notin \mathcal{C}_0$ is critical, it is not obtained by nailing a vertex of $F \in \mathcal{C}_0$, and thus $F \neq G'$. Since G is 2-edge-connected by Lemma 3.1, at least two vertices of F have a neighbor in $V(G) \setminus V(F)$, and thus at least two vertices of F are nailed. By (a0), exactly two vertices v_1 and v_2 of F are nailed and the underlying graph of F is C_5 or K_4^+ . By Lemma 3.1, we have $v_1v_2 \notin E(G)$. By Lemma 3.3, G is obtained from F by adding a path P of vertices of degree two between v_1 and v_2 and nailing v . However, a straightforward case analysis shows that all valid e-graphs arising from C_5 or K_4^+ in this way and satisfying the conclusion of Observation 2.5 (depicted in Figure 5) are $11/4$ -colorable, which is a contradiction. Let us remark that although the added path P may have arbitrary length and its vertices can be nailed arbitrarily, Observation 3.2 implies that to verify the $11/4$ -colorability of the e-graphs depicted in Figure 5, it suffices to consider the case that P has length two or three and its vertices are not nailed. \square

Lemma 3.5. *Let G be a minimum counterexample and let $uv \in E(G)$. If $\deg u = \deg v = 2$, then u and v are contained in a 5-cycle. Consequently, G does not contain a path of three vertices of degree two.*

Proof. Suppose for a contradiction that uv is not an edge of a 5-cycle in G . Let $u', v' \notin \{u, v\}$ be the other neighbors of u and v , respectively. Then the e-graph $G' = G - \{u, v\} + u'v'$ is triangle-free. Every $11/4$ -coloring φ of G' would satisfy $\varphi(u') \cap \varphi(v') = \emptyset$, and thus by Observation 3.2, it would extend to an $11/4$ -coloring of G . Therefore, G' is not $11/4$ -colorable, and thus G' contains a critical induced sub-e-graph F . Since G is critical, F cannot be an induced sub-e-graph of G , and thus $u'v' \in E(F)$.

The minimality of G implies $F \in \mathcal{C}_0$. By a computer-assisted enumeration, we verified that for every e-graph in \mathcal{C}_0 , replacing an edge by a path of two vertices of degree two results in an e-graph that either is not critical or belongs to \mathcal{C}_0 . Since $G \notin \mathcal{C}_0$ is critical, we have $F \neq G'$. By Observation 2.6 and Lemma 3.1, F contains at least two nailed vertices. By (a0), it follows that F contains exactly two nailed vertices x and y and the underlying graph

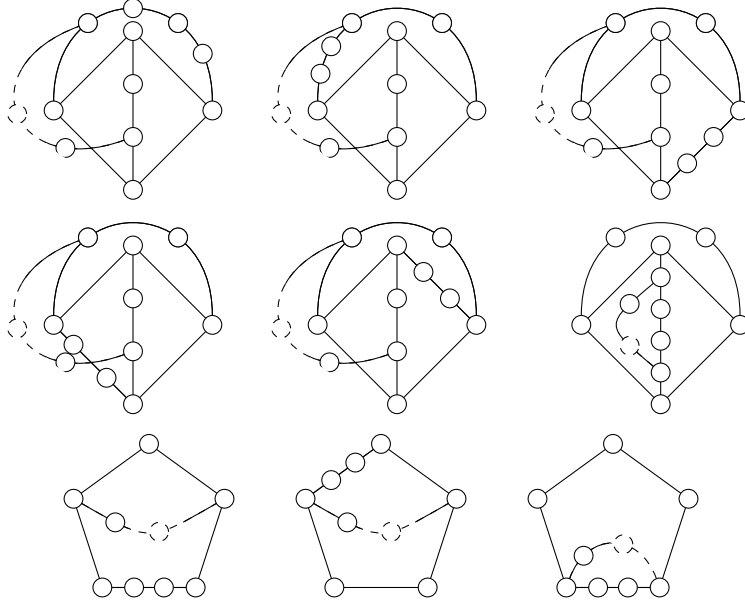

Figure 6: The graphs arising in the final case analysis in Lemma 3.5.

of F is C_5 or K_4^+ . By Lemma 3.3, G is obtained from F by replacing an edge by a path of two vertices of degree two and adding a path of vertices of degree two between x and y . By Lemma 3.1, we have $xy \notin E(G)$. A straightforward case analysis shows that none of such e-graphs (depicted in Figure 6) is critical, which is a contradiction.

If G contained a path of three vertices of degree two, then these vertices would be contained in a 5-cycle K , and by Lemma 3.1, we would have $G = K$. However, all critical e-graphs whose underlying graph is a 5-cycle belong to \mathcal{C}_0 . \square

Combining Lemmas 3.3 and 3.5, we obtain the following.

Corollary 3.6. *Let G be a minimum counterexample, and let $\{A_1, A_2\}$ be a partition of $V(G)$ to non-empty parts. If G contains exactly two edges between A_1 and A_2 , then there exists $i \in \{1, 2\}$ such that all vertices in A_i have degree two and $|A_i| \leq 2$.*

4 Two neighbors of degree two

Next, we want to show that every vertex has at most one neighbor of degree two. Let us start by excluding the special case of a vertex with two neighbors of degree two contained in a common 5-cycle (together with some related configurations).

Lemma 4.1. *Let G be a minimum counterexample and let C be a 5-cycle in G with exactly three vertices of degree three. Then the vertices of degree two in C are adjacent and every vertex $v \in V(G) \setminus V(C)$ with a neighbor in C has degree three.*

Proof. Firstly, we claim that every vertex $v \in V(G) \setminus V(C)$ of degree two with a neighbor v_1 in C has exactly one neighbor in C and both neighbors of v have degree three.

Subproof. Indeed, let v' be the neighbor of v distinct from v_1 . By Lemma 3.1, $v' \notin V(C)$, since if v' belonged to C , then the degree three vertex of C distinct from v_1 and v' would be incident with a bridge. Suppose for a contradiction that $\deg v' = 2$. Then v' does not have a neighbor in C , since G is 2-connected and exactly three vertices of C have degree three. By Lemma 3.5, v' has a neighbor x of degree three, and x and v_1 have a common neighbor v_2 belonging to C . Let w be the degree three vertex of C distinct from v_1 and v_2 . By Corollary 3.6, x and w are joined by an edge or by a path of at most two vertices of degree two. This leaves only finitely many choices for the e-graph G . As we verified using computer, among these e-graphs, all critical ones are contained in \mathcal{C}_0 . This is a contradiction, implying that $\deg v' = 3$. \blacksquare

Let $C = v_1v_2v_3v_4v_5$, where $\deg v_1 = \deg v_2 = 3$. For each vertex v_i of C of degree three, let v'_i denote the neighbor of v_i outside of C , and if $\deg v'_i = 2$, then let v''_i be the neighbor of v'_i distinct from v_i . Let Q consist of $V(C)$ and all vertices of degree two with a neighbor in $V(C)$. Let G_1 be the sub-e-graph of G consisting of all edges incident with Q and all vertices incident with these edges, and let $S = V(G_1) \setminus Q$.

If $\deg v_4 = 3$ and $\deg v'_1 = 2$ or $\deg v'_2 = 2$, then the configuration G_1 attaching at S is excluded by reducibility. If $\deg v_4 = \deg v'_1 = \deg v'_2 = 3$, then let H_1 be the e-graph with the vertex set $S \cup \{z_1, z_2\}$, edges v'_1z_1 , z_1z_2 , and $z_2v'_2$, and $d_{H_1}(z_1) = 2$ and $d_{H_1}(z_2) = 3$. The standard argument for the configuration G_1 attaching at S and the replacement graph H_1 enforcing $|\varphi(v'_1) \cap \varphi(v'_2)| \leq 2$ gives an e-graph G' and its proper induced sub-e-graph $F_1 \in \mathcal{C}_0$. Since G is critical, F_1 is not an induced sub-e-graph of G , and thus $z_1, z_2 \in V(F_1)$. Furthermore, Corollary 3.6 implies that G' is 2-connected, and since $F_1 \neq G'$, Observation 2.6 implies that F_1 has at least two nailed vertices in addition to z_2 , which contradicts (a0).

Hence, we can assume $\deg v_4 = 2$ and by symmetry $\deg v_3 = 3$. Suppose now for a contradiction that at least one of the vertices v'_1 , v'_2 , and v'_3 has degree two. For $i \in \{1, 2, 3\}$, let $w_i = v'_i$ if $\deg v'_i = 3$ and $w_i = v''_i$ otherwise, so that $S = \{w_1, w_2, w_3\}$. If $w_1 = w_2$, then by Corollary 3.6 applied to the cut formed by the edge incident with w_1 not belonging to G_1 and the edge $v_3v'_3$, we also have $w_2 = w_3$ and G consists of a 5-cycle and three paths of length at most two to w_1 ; but a straightforward case analysis shows that all such critical e-graphs belong to \mathcal{C}_0 . Hence, we can by symmetry assume w_1, w_2 , and w_3 are pairwise distinct. Furthermore, we can by symmetry assume $\deg v'_1 \geq \deg v'_3$. Let H_2 be the e-graph with the vertex set $S \cup \{z_1, z_2\}$, edges w_1z_1 , z_1z_2 , and z_2w_i , where $i = 3$ if $\deg v'_2 = 2$ and $i = 2$ otherwise, and $d_{H_2}(z_1) = 2$ and $d_{H_2}(z_2) = 3$. The standard argument for the configuration G_1 attaching at S and the replacement graph H_2 enforcing $|\varphi(w_1) \cap \varphi(w_i)| \leq 2$ gives an e-graph G'' and its proper induced sub-e-graph $F_2 \in \mathcal{C}_0$. Clearly $z_1, z_2 \in V(F_2)$. Observe that Corollary 3.6 implies that G'' is 2-connected. Since $F_2 \neq G''$, Observation 2.6 implies that F_2 has at least two nailed vertices in addition to z_2 , which contradicts (a0). \square

We now proceed to excluding a vertex with two neighbors of degree two in general.

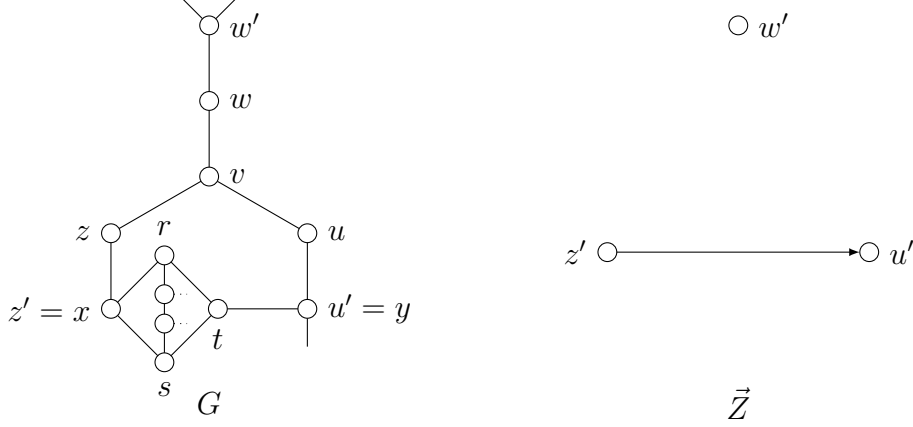

Figure 7: An edge of the auxiliary graph \vec{Z} .

Lemma 4.2. *No vertex in a minimum counterexample has two neighbors of degree two.*

Proof. Let G be a minimum counterexample and let uvw be a path in G , and suppose for a contradiction that $\deg u = \deg w = 2$. Let u' and w' be the neighbors of u and w distinct from v . By Lemma 3.5, we have $\deg v = 3$; let z be the neighbor of v distinct from u and w . Note that $u' \neq w'$, as otherwise u and w would have the same neighborhood, contradicting the criticality of G . Moreover, $u'w' \notin E(G)$ by Lemma 4.1. We claim that $\deg z = 3$.

Subproof. Suppose for a contradiction that $\deg z = 2$, and let z' be the neighbor of z distinct from v . The argument from the previous paragraph implies that $u' \neq z' \neq w'$ and $\{u', w', z'\}$ is an independent set. Note that $\deg u' = \deg w' = \deg z' = 3$ by Lemma 3.5 and Observation 2.5. Let \vec{Z} be the auxiliary directed graph with the vertex set $\{u', w', z'\}$, where for distinct vertices $x, y \in V(\vec{Z})$, we have $(x, y) \in E(\vec{Z})$ if and only if x is contained in a unique 4-cycle $xrts \subseteq G - \{u, w, z, v\}$, r and s are joined by a path of length three, $\{r, s, t\} \cap \{u', w', z'\} = \emptyset$, and $ty \in E(G)$; see Figure 7 for an illustration. Note that for a fixed vertex x , such a vertex y is uniquely determined by these conditions, and thus \vec{Z} has maximum outdegree at most one. Furthermore, observe that \vec{Z} contains at most one of the edges (u', w') and (z', u') . Therefore, we can by symmetry assume $(u', w'), (w', u') \notin E(\vec{Z})$.

Let $S_0 = \{u', w', z'\}$ and let G_0 be the sub-e-graph of G with the vertex set $S_0 \cup \{u, v, w, z\}$ and all edges incident with u, v, w, z . Let H_0 be the e-graph with the vertex set $S_0 \cup \{c\}$, with c adjacent to u' and w' and with $d_{H_0}(c) = 2$. The standard argument for the configuration G_0 attaching at S_0 and the replacement graph H_0 enforcing $|\varphi(u') \cup \varphi(w')| \leq 6$ gives an e-graph G'' and its proper induced sub-e-graph $F_0 \in \mathcal{C}_0$. Note that since G is critical, F_0 is not a proper induced sub-e-graph of G , and consequently $c \in V(F_0)$. Note that Lemma 3.1 implies G'' is 2-connected, and thus F_0 contains at least two nailed vertices by Observation 2.6. By (a0), it follows that the underlying graph of F_0 is either C_5 or K_4^+ .

- In the former case, $F_0 = u'cw'xy$ for some vertices x and y , u' and w' are nailed in F_0 since they have degree three in G , and $\deg_G x = \deg_G y = 2$. By Lemma 3.5, the

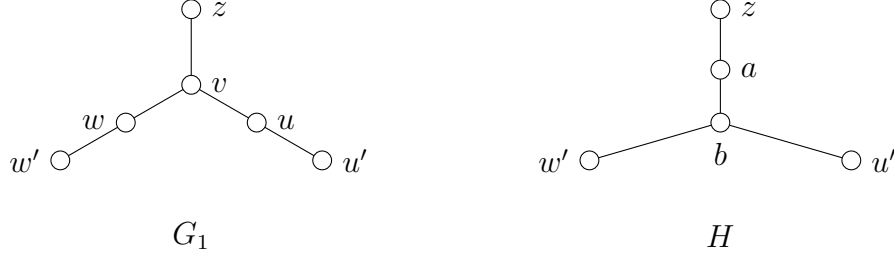

Figure 8: The e-graph G_1 and the replacement e-graph H .

path $u'xyw'$ is contained in a 5-cycle in G , and since $\deg u = 2$, this 5-cycle contradicts Lemma 4.1.

- In the latter case, since the underlying graph of F_0 is K_4^+ and $\deg_{F_0} c = 2$, we can by symmetry assume $\deg_{F_0} w' = 2$ (and thus w' is nailed in F_0) and $\deg_{F_0} u' = 3$. Then u' is contained in a 4-cycle of non-nailed vertices of F_0 , necessarily distinct from the vertex z' which is nailed in G_0 . This 4-cycle together with the rest of $F_0 - c$ provides the structure implying that $(u', w') \in E(\vec{Z})$, which is a contradiction. ■

Therefore, we have $\deg z = 3$. Suppose now that $\deg u' = 2$. By Lemma 3.5, uu' is contained in a 5-cycle C ; since $u'w' \notin E(G)$, C contains the path $u'uvz$. By Observation 2.5, C contains exactly three vertices of degree three. However, $v \in V(C)$ is adjacent to a vertex $w \notin V(C)$ of degree two, contradicting Lemma 4.1. Therefore $\deg u' = 3$, and symmetrically $\deg w' = 3$.

Let $S = \{u', w', z\}$ and let G_1 be the sub-e-graph of G induced by $S \cup \{u, v, w\}$. Let H be the e-graph with the vertex set $S \cup \{a, b\}$, with edges bu', bw', ab , and az , and with $d_H(a) = 2$ and $d_H(b) = 3$, see Figure 8. The standard argument for the configuration G_1 attaching at S and the replacement graph H enforcing $|\varphi(u') \cup \varphi(w')| \leq 7$ and $|(\varphi(u') \cup \varphi(w')) \cap \varphi(z)| \leq 2$ gives an e-graph G' and its proper induced sub-e-graph $F \in \mathcal{C}_0$. Since G is critical, F is not a proper induced sub-e-graph of G . Moreover, F has minimum degree at least two, and thus $V(F) \setminus V(G) \neq \{a\}$. Therefore, $b \in V(F)$. Since G is 2-edge-connected, so is G' , and thus Observation 2.6 implies that F has at least two nailed vertices. By (a0), it follows that the underlying graph of F is either C_5 or K_4^+ . In the former case, since $\deg_{G'} u' = \deg_{G'} w' = \deg_{G'} z = \deg_{G'} b = 3$, F would contain at least three nailed vertices (b and two of the vertices u', w' , and z), contradicting (a0). Therefore, the underlying graph of F is K_4^+ .

If $|V(F) \cap \{u', w'\}| = 1$, say $V(F) \cap \{u', w'\} = \{u'\}$, then G contains an induced sub-e-graph F' with underlying graph K_4^+ obtained from F by replacing the path $u'baz$ by the path $u'uvz$. By Observation 2.5, at least three vertices of F' are nailed, implying that at least three vertices of F are nailed (the nailed vertex v of F' corresponds to the nailed vertex b of F). This contradicts (a0). Hence, we have $u', w' \in V(F)$.

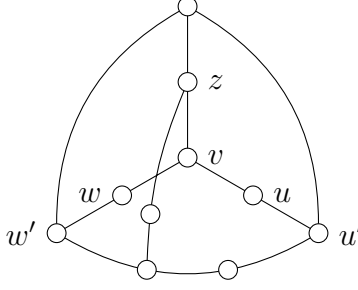

Figure 9: The graph arising in the final case analysis in Lemma 4.2.

Since $\deg_G u' = \deg_G w' = \deg_G z = 3$, Corollary 3.6 implies that $G - \{u, v, w\}$ is 2-edge-connected. If $a \notin V(F)$, then b is a nailed vertex of F , and since F contains at most one more nailed vertex, Observation 2.6 implies that $F = G' - a$. This is not possible, since the underlying graph of F is K_4^+ , but b would have degree two in F and both its neighbors in F would have degree three. Therefore, $a, z \in V(F)$; note that $\deg_F z = 2$, since $\deg_F a = 2$ and $\deg_F b = 3$ and the underlying graph of F is K_4^+ . By Corollary 3.6 and Lemma 3.5, we conclude that G is obtained from F (a copy of K_4^+ with two nailed vertices, one of which is z) by deleting a and b , adding G_1 , and adding a vertex of degree two adjacent to z and to another vertex of F of degree two (there is only one choice by symmetry). However, this graph (depicted in Figure 9) is 11/4-colorable, which is a contradiction. \square

5 Subdivided K_4

In this section, we aim to show that the minimum counterexample does not contain K_4^+ as an induced subgraph. Before that, let us get rid of another simple configuration.

Lemma 5.1. *Let G be a minimum counterexample. If $C = u_1 u_2 u_3 u_4$ is a 4-cycle in G , then $\deg_G u_i = 3$ for $i \in \{1, 2, 3, 4\}$.*

Proof. Suppose for a contradiction that $\deg u_1 = 2$. Lemmas 3.5 and 4.2 imply that $\deg u_i = 3$ for $i \in \{2, 3, 4\}$; let v_i denote the neighbor of u_i not in C . These neighbors are pairwise distinct, since G is triangle-free, and if $v_2 = v_4$, then u_2 and u_4 would have the same neighborhood, which is not possible in a critical graph. Lemma 4.2 implies $\deg v_2 = \deg v_4 = 3$; note that $\deg v_3 = 2$ is possible. Let $S = \{v_2, v_3, v_4\}$ and let G_1 be the sub-e-graph of G with the vertex set $V(C) \cup S$ and with the edge set consisting of the edges incident with $V(C)$. The configuration G_1 attaching at S is excluded by reducibility. \square

Next, let us exclude K_4^+ with three nailed vertices.

Lemma 5.2. *Let G be a minimum counterexample. If H is an induced sub-e-graph of G and the underlying graph of H is K_4^+ , then all vertices of H have degree three in G .*

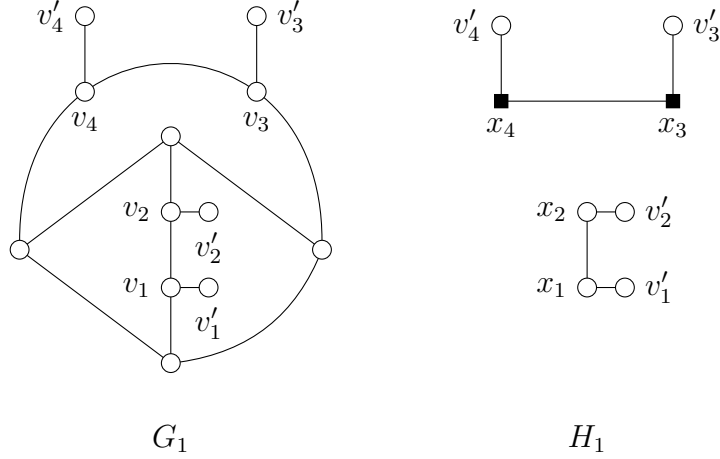

Figure 10: The e-graph G_1 and the replacement e-graph H_1 .

Proof. By Observation 2.5, at most one vertex of H has degree two in G . Suppose H contains a vertex whose degree is two in G . Let u, v , and w be the vertices of H that have degree two in H and degree three in G , where $vw \in E(H)$. Let u' be the neighbor of u not in H , and note that $\deg u' = 3$ by Lemma 4.2. Let $S = \{u', v, w\}$ and let G_1 be the sub-e-graph of G consisting of H and the edge $u'u$. The configuration G_1 attaching at S is excluded by reducibility. \square

Let us now proceed with the main result of this section.

Lemma 5.3. *If G is a minimum counterexample, then G does not contain any induced sub-e-graph with the underlying graph K_4^+ .*

Proof. Let H be an induced sub-e-graph of G with the underlying graph K_4^+ , and let $v_1v_2, v_3v_4 \in E(H)$ be the edges joining vertices whose degree in H is two. Lemma 5.2 implies that for $i \in \{1, \dots, 4\}$, v_i has a neighbor v'_i outside of H . Let us remark that v'_i might have degree two, and $\{v'_1, v'_2\} \cap \{v'_3, v'_4\} \neq \emptyset$ is possible. Let $S = \{v'_1, v'_2, v'_3, v'_4\}$, let G_1 be the sub-e-graph of G with the vertex set $V(H) \cup S$ and containing all edges of G incident with $V(H)$, and let H_1 be the e-graph with the vertex set $S \cup \{x_1, x_2, x_3, x_4\}$, edges v'_ix_i for $i \in \{1, \dots, 4\}$, x_1x_2 , and x_3x_4 , and with $d_{H_1}(x_1) = d_{H_1}(x_2) = 2$ and $d_{H_1}(x_3) = d_{H_1}(x_4) = 3$, see Figure 10. The standard argument for the configuration G_1 attaching at S and the replacement graph H_1 enforcing $|\varphi(v'_1) \cap \varphi(v'_2)| \leq 1$ and $|\varphi(v'_3) \cap \varphi(v'_4)| \leq 3$ gives an e-graph G' and its proper induced sub-e-graph $F \in \mathcal{C}_0$. Note that G' is connected, since otherwise either we would obtain a contradiction with Lemma 3.1, or the edges of H from $\{v_1, v_2\}$ to $V(H) \setminus \{v_1, v_2\}$ would form a 2-edge-cut contradicting Corollary 3.6. Since $F \neq G'$, if $x_3, x_4 \in V(F)$, then F would contain at least three nailed vertices (x_3, x_4 , and at least one more by Observation 2.6), contradicting (a0). Consequently $x_3, x_4 \notin V(F)$. Furthermore, F is not an induced sub-e-graph of G , and thus $x_1, x_2 \in V(F)$.

By Observation 2.6, F has at least one nailed vertex. Suppose first that F has exactly one nailed vertex z ; in G , z has a neighbor $z' \in V(G) \setminus V(F)$. Note that $z' \notin V(H)$, since if say $z' = v_3$, then v_4v_4' would be a bridge in G , contradicting Lemma 3.1. Let $S_2 = \{v_3, v_4, z'\}$ and let G_2 be the sub-e-graph of G consisting of H , $F - \{x_1, x_2\}$, the edges v_1v_1' and v_2v_2' , and the edge zz' , see Figure 11. Note that $\deg z' = 2$ is possible. Since $F \in \mathcal{C}_0$, all possible e-graphs G_2 can be enumerated, and the configuration G_2 attaching at S_2 is excluded by reducibility.

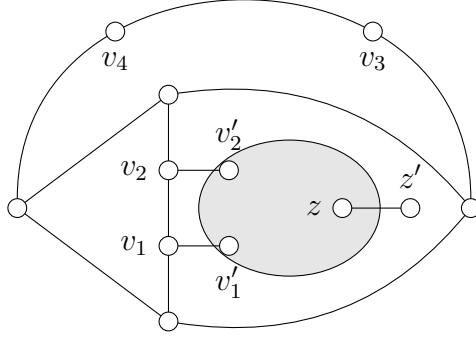

Figure 11: The e-graph G_2 .

By (a0), it follows that F contains two nailed vertices and the underlying graph of F is either C_5 or K_4^+ . Let z_1 and z_2 be the nailed vertices of F . Suppose that $z_1z_2 \in E(F)$. Let $S_3 = \{z_1, z_2, v_3, v_4\}$ and let G_3 be the sub-e-graph of G consisting of H , $F - \{x_1, x_2\}$, and the edges v_1v_1' and v_2v_2' . Then the configuration G_3 attaching at S_3 is excluded by reducibility.

Therefore $z_1z_2 \notin E(F)$. Since F contains adjacent non-nailed vertices x_1 and x_2 of degree two, the underlying graph F is either C_5 or K_4^+ , and $\deg_F z_1 = \deg_F z_2 = 2$, it follows that F is a 5-cycle, $z_1 = v_1'$ and $z_2 = v_2'$. Let z_1' and z_2' be the neighbors of z_1 and z_2 outside of $V(F)$ in G . Let z be the common neighbor of z_1 and z_2 in F ; since F has only two nailed vertices, we have $\deg_G z = 2$. By Lemma 4.2, we have $\deg z_1' = \deg z_2' = 3$. If $\{z_1', z_2'\} \cap \{v_3, v_4\} \neq \emptyset$, then Corollary 3.6 implies $\{z_1', z_2'\} = \{v_3, v_4\}$, and thus G is the e-graph depicted in Figure 12. However, this e-graph belongs to \mathcal{C}_0 , which is a contradiction. Therefore, $z_1', z_2' \notin V(H)$. Furthermore, $z_1' \neq z_2'$ by Lemma 5.1, since z_1 and z_2 have a common neighbor z of degree two. We claim that $z_1'z_2' \in E(G)$.

Subproof. Suppose for a contradiction that $z_1'z_2' \notin E(G)$. Let $S_4 = \{z_1', z_2', v_3, v_4\}$ and let G_4 be the sub-e-graph of G consisting of H , $F - \{x_1, x_2\}$ and the edges v_1v_1' , v_2v_2' , z_1z_1' and z_2z_2' . Let H_4 be the e-graph with the vertex set $S \cup \{a\}$ and edges v_3v_4 , az_1' , and az_2' , with $d_{H_4}(a) = 3$, see Figure 13. The standard argument for the configuration G_4 attaching at S_4 and the replacement graph H_4 enforcing $|\varphi(z_1') \cup \varphi(z_2')| \leq 7$ gives an e-graph G'' and its proper induced sub-e-graph $F_4 \in \mathcal{C}_0$ (note that $F_4 \neq G''$ follows from (a0) and the fact that G'' has three nailed vertices a , v_3 , and v_4). Since G is critical, F_4 is not an induced sub-e-graph of G , and thus $a \in V(F_4)$. By Lemma 3.1, G'' is connected (as otherwise $\{v_3, v_4\}$

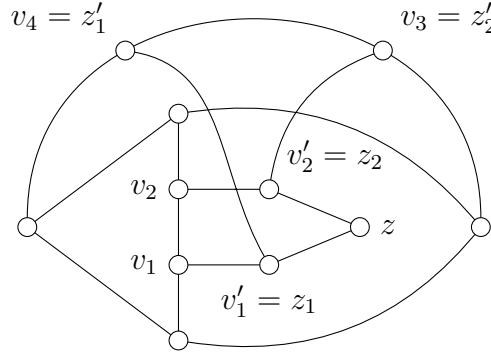

Figure 12: The critical e-graph arising in Lemma 5.3.

would be a cut in G), and thus Observation 2.6 implies that F_4 contains a nailed vertex different from a . By (a0), F_4 contains exactly one nailed vertex different from a and the underlying graph of F_4 is C_5 or K_4^+ .

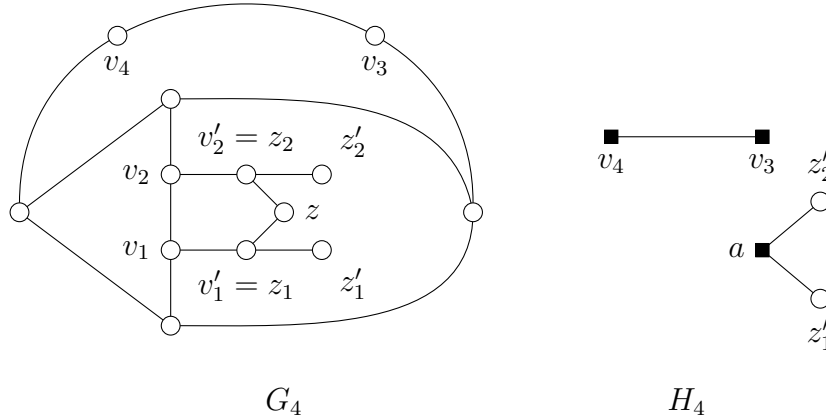

Figure 13: The e-graph G_4 and the replacement e-graph H_4 .

Since $\deg a = 2$ and $\deg_G z'_1 = \deg_G z'_2 = 3$, observe that F_4 cannot be a 5-cycle. Hence, the underlying graph of F_4 is K_4^+ and by symmetry, we can assume z'_2 is a nailed vertex in F_4 . Let z''_2 be the neighbor of z'_2 not belonging to $V(F_4)$ and distinct from z_2 . Note that $z''_2 \notin \{v_3, v_4\}$ by Lemma 3.1. Let $S_5 = \{v_3, v_4, z''_2\}$ and let G_5 be the e-graph consisting of G_4 , $F_4 - a$ and the edges $z_1 z'_1$, $z_2 z'_2$, and $z'_2 z''_2$, see Figure 14. Then the configuration G_5 attaching at S_5 is excluded by reducibility. ■

Therefore, we have $z'_1 z'_2 \in E(G)$; let us remark that the reduction from the case $z'_1 z'_2 \notin E(G)$ does not apply, as it would create a triangle. For $i \in \{1, 2\}$, let w_i be the neighbor

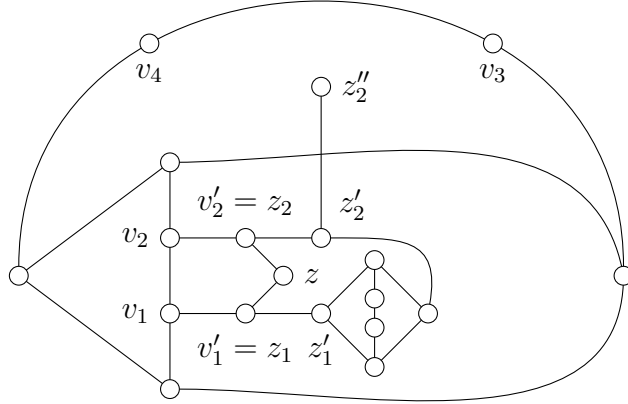

Figure 14: The e-graph G_5 .

of z'_i distinct from z_i and z'_{3-i} . If $\{w_1, w_2\} \cap \{v_3, v_4\} \neq \emptyset$, say $w_1 = v_3$ by symmetry, then Corollary 3.6 and Lemma 3.5 imply either $w_2 = v_4$, or $\deg w_2 = 2$ and $w_2v_4 \in E(G)$; but both such graphs G are 11/4-colorable. Hence, $\{w_1, w_2\} \cap \{v_3, v_4\} = \emptyset$.

Let $S_6 = \{w_1, w_2, v_3, v_4\}$ and let G_6 be the sub-e-graph of G consisting of G_4 and the path $w_1z'_1z'_2w_2$. Let H_6 be the e-graph with the vertex set $S \cup \{b, c\}$ and edges v_3v_4 , w_1b , bc , and cw_2 , with $d_{H_6}(b) = 3$ and $d_{H_6}(c) = 2$; see Figure 15. The standard argument for the configuration G_6 attaching at S_6 and the replacement graph H_6 enforcing $|\varphi(w_1) \cap \varphi(w_2)| \leq 2$ gives an e-graph G''' and its proper induced sub-e-graph $F_6 \in \mathcal{C}_0$ (note that $F_6 \neq G'''$ follows from (a0) and the fact that G''' has three nailed vertices b , v_3 , and v_4). Clearly $b, c \in V(F_6)$, since F_6 is not an induced sub-e-graph of the critical graph G . By Lemma 3.1, G''' is connected, and thus by Observation 2.6, F_6 contains a nailed vertex y distinct from b . By (a0), the underlying graph of F_6 is C_5 or K_4^+ . If the underlying graph of F_6 were K_4^+ , then replacing the path w_1bcw_2 of F_6 by the path $w_1z'_1z'_2w_2$ would yield an induced sub-e-graph of G with underlying graph K_4^+ containing a vertex (a neighbor of y) whose degree in G is two, contradicting Lemma 5.2.

Hence, F_6 is a 5-cycle, and by Lemma 4.2 and symmetry, we can assume $y = w_1$, $\deg_G w_2 = 2$, and y and w_2 have a common neighbor y' of degree two in G . Let y'' be the neighbor of y distinct from z'_1 and y' ; we have $y'' \notin \{v_3, v_4\}$ by Lemma 3.1 and $\deg y'' = 3$ by Lemma 4.2. Let $S_7 = \{y'', v_3, v_4\}$ and let G_7 be the sub-e-graph of G obtained from G_6 by adding the path $yy'w_2$ and the edge yy'' , see Figure 16. Then the configuration G_7 attaching at S_7 is excluded by reducibility. \square

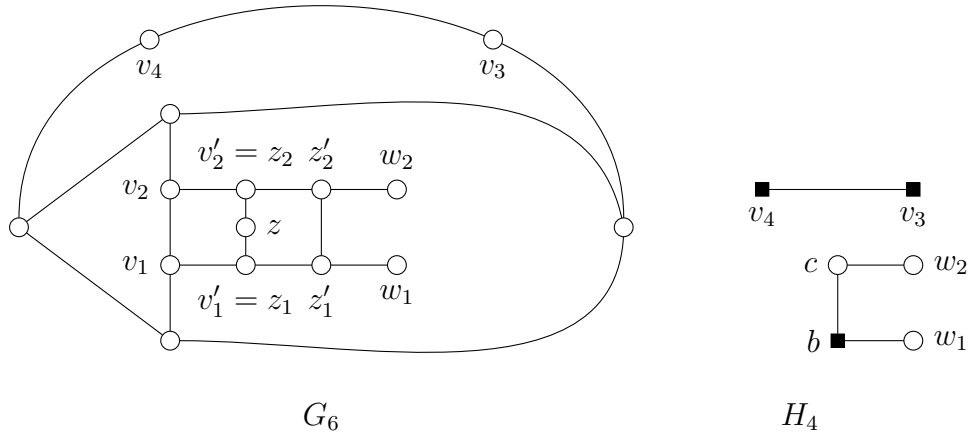

Figure 15: The e-graph G_6 and the replacement e-graph H_6 .

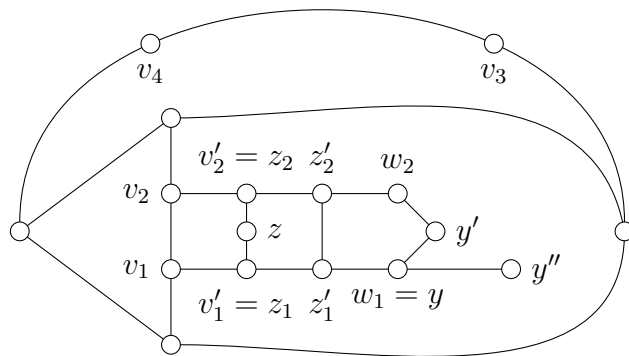

Figure 16: The e-graph G_7 .

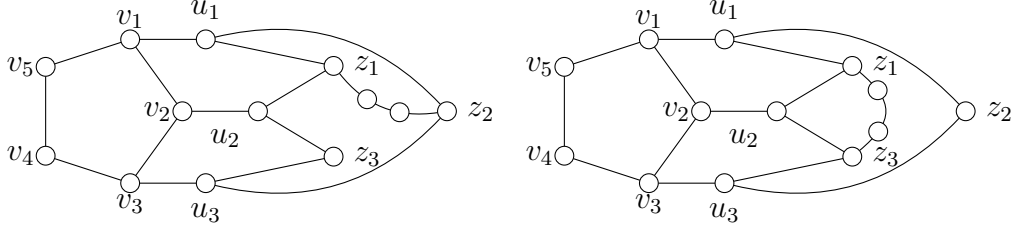

Figure 17: The critical e-graphs arising in Lemma 6.2.

6 Adjacent vertices of degree two

Let $C = v_1v_2v_3v_4v_5$ be a 5-cycle in a minimum counterexample G , where $\deg_G v_4 = \deg_G v_5 = 2$. For $i \in \{1, 2, 3\}$, let u_i be the neighbor of v_i not in C . By Lemma 4.1, we have $\deg_G u_1 = \deg_G u_2 = \deg_G u_3 = 3$. Furthermore, the vertices u_1, u_2 , and u_3 are pairwise distinct: Since G is triangle-free, we have $u_1 \neq u_2 \neq u_3$, and if $u_1 = u_3$, then the 2-edge-cut consisting of v_2u_2 and an edge incident with u_1 would contradict Corollary 3.6. In this section, we exclude this configuration completely.

Our plan is to reduce this configuration by deleting $V(C)$ and adding an edge between two of the vertices u_1, u_2 , and u_3 . This course fails if the addition of any such edge creates a triangle, i.e., if each pair of these vertices has a common neighbor. Hence, we first need to deal with this situation, starting with the special case that all three vertices have a common neighbor.

Lemma 6.1. *Let $C = v_1v_2v_3v_4v_5$ be a 5-cycle in a minimum counterexample G , where $\deg_G v_4 = \deg_G v_5 = 2$. For $i \in \{1, 2, 3\}$, let u_i be the neighbor of v_i not in C . Then the vertices u_1, u_2 , and u_3 do not have a common neighbor.*

Proof. Suppose u_1, u_2 , and u_3 have a common neighbor z . Let w_i be the neighbor of u_i distinct from v_i and z . Let $S = \{w_1, w_2, w_3\}$ and let G_1 be the subgraph of G consisting of the cycle C and the paths $v_iu_i z$ and edges u_iw_i for $i \in \{1, 2, 3\}$. The configuration G_1 attaching at S_1 is excluded by reducibility. \square

Next, we deal with the more complicated case that each pair of the vertices u_1, u_2 , and u_3 has a distinct common neighbor.

Lemma 6.2. *Let $C = v_1v_2v_3v_4v_5$ be a 5-cycle in a minimum counterexample G , where $\deg_G v_4 = \deg_G v_5 = 2$. For $i \in \{1, 2, 3\}$, let u_i be the neighbor of v_i not in C . Then there exist distinct $i, j \in \{1, 2, 3\}$ such that the vertices u_i and u_j do not have a common neighbor.*

Proof. Suppose for a contradiction that for all distinct $i, j \in \{1, 2, 3\}$, u_i and u_j have a common neighbor z_{i+j-2} . By Lemma 6.1, the vertices z_1, z_2 , and z_3 are pairwise distinct.

Suppose one of the vertices z_1, z_2 , and z_3 has degree two. By Lemma 4.2, the other two have degree three, and by Corollary 3.6 and Lemma 5.1, they are joined by a path of two vertices of degree two. However, the resulting e-graphs, depicted in Figure 17, belong to \mathcal{C}_0 .

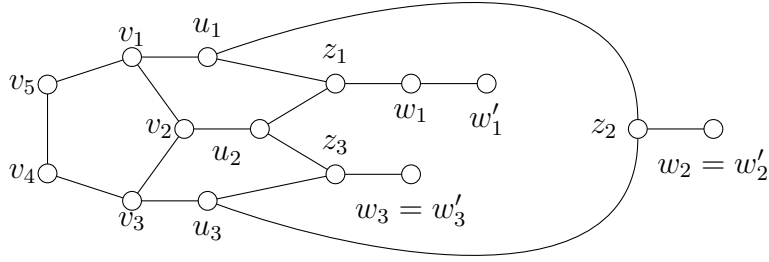

Figure 18: The e-graph G_1 in the case $\deg w_1 = 2$.

Hence, we have $\deg z_1 = \deg z_2 = \deg z_3 = 3$. For $i \in \{1, 2, 3\}$, let w_i be the neighbor of z_i not in $\{u_1, u_2, u_3\}$. If $w_1 = w_2$, then by Corollary 3.6 and Lemma 3.5, either $w_3 = w_1$ or $\deg w_3 = 2$ and $w_3 w_1 \in E(G)$. The case $w_2 = w_3$ is symmetric. If $w_1 = w_3 \neq w_2$, then by Corollary 3.6 and Lemma 3.5 we have $\deg w_2 = 2$ and $w_2 w_1 \in E(G)$. However, all these graphs are 11/4-colorable. It follows that w_1, w_2 , and w_3 are pairwise distinct.

By Lemma 3.1, if for some distinct $i, j \in \{1, 2, 3\}$ the vertices w_i and w_j have degree two, then $w_i w_j \notin E(G)$. For $i = 1, 2, 3$, let $w'_i = w_i$ if $\deg w_i = 3$ and let w'_i be the neighbor of w_i distinct from z_i otherwise. Let $S_1 = \{w'_1, w'_2, w'_3\}$ and let G_1 be the sub-e-graph of G consisting of $G[V(C) \cup \{u_1, u_2, u_3, z_1, z_2, z_3\}]$, the edges $z_i w_i$ for $i \in \{1, 2, 3\}$, and the edges $w_i w'_i$ for each $i \in \{1, 2, 3\}$ such that $\deg w_i = 2$; see Figure 18. If at least one of w_1, w_2 , and w_3 has degree two, then the configuration G_1 attaching at S_1 is excluded by reducibility.

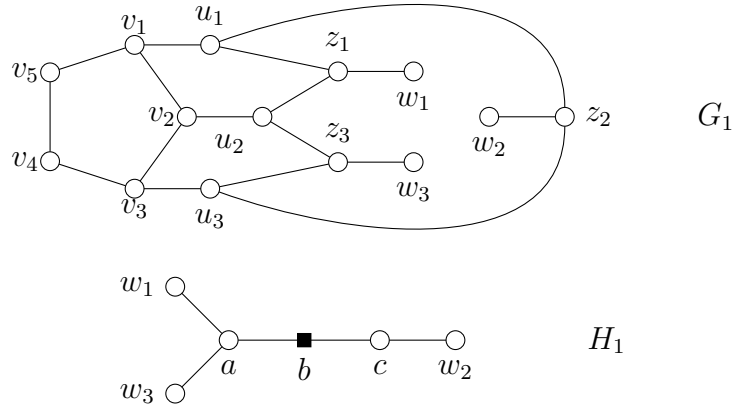

Figure 19: The e-graph G_1 and the replacement e-graph H_1 , the case $\{i, j\} = \{1, 3\}$.

Therefore, we have $\deg w_1 = \deg w_2 = \deg w_3 = 3$. Since G is triangle-free, there exist distinct $i, j \in \{1, 2, 3\}$ such that $w_i w_j \notin E(G)$. Let H_1 be the e-graph with the vertex set $S_1 \cup \{a, b, c\}$, edges $w_i a, w_j a, ab, bc$, and $c w_{6-i-j}$, and with $d_{H_1}(b) = 3$ and

$d_{H_1}(c) = 2$; see Figure 19. The standard argument for the configuration G_1 attaching at S_1 and the replacement graph H_1 enforcing $|\varphi(w_1) \cup \varphi(w_2) \cup \varphi(w_3)| \leq 9$ (as seen by Observation 3.2 with $k = 4$ applied to the path arising from H_1 by identifying w_i and w_j to a single vertex) gives an e-graph G' and its proper induced sub-e-graph $F_1 \in \mathcal{C}_0$. Corollary 3.6 implies G' is 2-edge-connected, and thus if $b \in V(F_1)$, then F_1 would contain at least three nailed vertices by Observation 2.6, contradicting (a0). Consequently $b, c \notin V(F_1)$. Since G is critical, F_1 is not an induced sub-e-graph of G , and thus $a \in V(F_1)$ and a is nailed in F_1 . Since G' is 2-edge-connected and F_1 contains at most two nailed vertices by (a0), Observation 2.6 implies F_1 contains exactly one nailed vertex z distinct from a . If $z \neq w_{6-i-j}$, then the 2-edge-cut in G formed by the edge $z_{6-i-j}w_{6-i-j}$ and the edge incident with z not belonging to F_1 would contradict Corollary 3.6. Hence, $z = w_{6-i-j}$, and thus $F_1 = G' - \{b, c\}$. By (a0), the underlying graph of F_1 is C_5 or K_4^+ . However, this is not possible, since $\deg_{F_1} w_i = \deg_{F_1} w_j = 3$ and $\deg_{F_1} a = 2$. \square

Let us now investigate how the reduction we proposed at the beginning of this section can result in a non-11/4-colorable e-graph.

Lemma 6.3. *Let $C = v_1v_2v_3v_4v_5$ be a 5-cycle in a minimum counterexample G , where $\deg v_4 = \deg v_5 = 2$. For $i \in \{1, 2, 3\}$, let u_i be the neighbor of v_i not in C . Let $j \in \{2, 3\}$ be an index such that u_1 and u_j do not have a common neighbor. Let G' be the e-graph obtained from $G - V(C)$ by adding the edge u_1u_j and setting $d_{G'}(u_{5-j}) = 2$. If F is a critical induced sub-e-graph of G' , then $u_1u_j \notin E(F)$, $u_{5-j} \in V(F)$, and F is a 5-cycle with two nailed vertices.*

Proof. Note that $\deg_{G'} u_1 = \deg_{G'} u_j = 3$ and $\deg_{G'}(u_{5-j}) = 2$, and G' is 2-edge-connected by Corollary 3.6. By the minimality of G , we have $F \in \mathcal{C}_0$, and in particular F has at most two nailed vertices by (a0).

Let us first consider the case that $u_1u_j \notin E(F)$, and thus $F \neq G'$. Since G' is 2-edge-connected, Observation 2.6 implies F has two nailed vertices, and by (a0), the underlying graph of F is C_5 or K_4^+ . By Lemma 5.3, it cannot be K_4^+ , and thus F is a 5-cycle with two nailed vertices. Moreover, since G is critical, F is not an induced sub-e-graph of G , and thus $u_{5-j} \in V(F)$, as required.

Suppose now for a contradiction that $u_1u_j \in E(F)$. If $u_{5-j} \in V(F)$, then since at most two vertices of F are nailed, Observation 2.6 and Corollary 3.6 imply that either $F = G'$ or G' is obtained from F by adding a path of at most two vertices of degree two between the nailed vertices of F . By a computer-assisted enumeration, we verified that for every e-graph in \mathcal{C}_0 , performing this transformation to obtain G' , deleting the edge u_1u_j and adding C to obtain G results in an e-graph that either is not critical or belongs to \mathcal{C}_0 . Since $G \notin \mathcal{C}_0$ is critical, it follows that $u_{5-j} \notin V(F)$.

In particular, $F \neq G'$. Since G' is 2-edge-connected, Observation 2.6 implies F contains two nailed vertices, and by (a0), the underlying graph of F is C_5 or K_4^+ . If u_1 and u_j were the nailed vertices of F , then the partition $\{V(F) \setminus \{u_1, u_j\}, (V(G) \setminus V(F)) \cup \{u_1, u_j\}\}$ of $V(G)$ would contradict Corollary 3.6. Consequently, $\max(\deg_F(u_1), \deg_F(u_j)) = 3$, and in particular the underlying graph of F is K_4^+ .

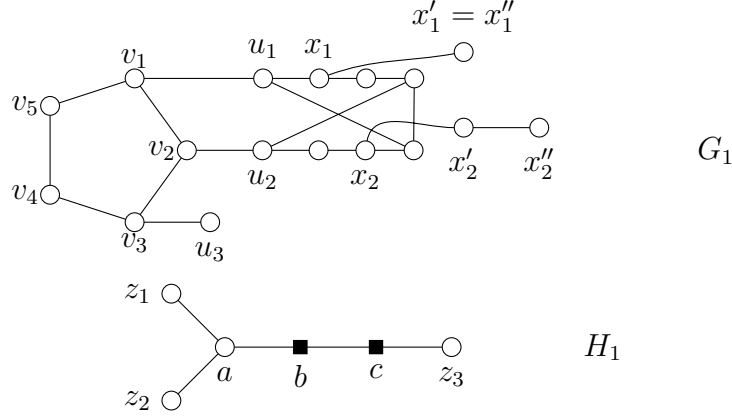

Figure 20: The e-graph G_1 and the replacement e-graph H_1 in case $j = 2$ and $\deg(x'_2) = 2$. In this case $S_1 = \{x''_1, x''_2, u_3\} = \{z_1, z_2, z_3\}$ such that z_1z_2 is not an edge.

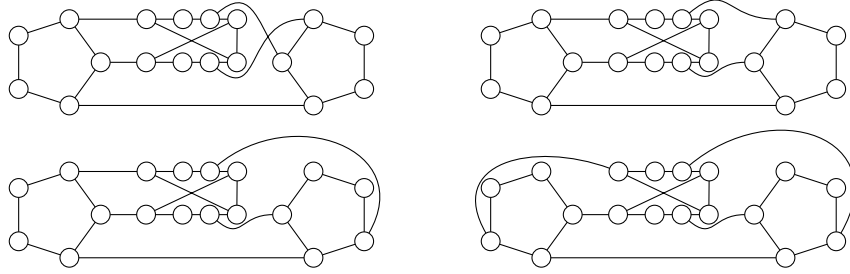

Figure 21: Critical e-graphs arising in Lemma 6.3.

Let x_1 and x_2 be the nailed vertices of F and let x'_1 and x'_2 be their neighbors in $G' - V(F)$. For $i \in \{1, 2\}$, if $\deg_G(x'_i) = 2$, then let x''_i be the neighbor of x'_i distinct from x_i , otherwise let $x''_i = x'_i$. Let us remark that if $\deg_G(x'_1) = \deg_G(x'_2) = 2$, then $x'_1 \neq x'_2$ and $x'_1x'_2 \notin E(G)$, as otherwise $v_{5-j}u_{5-j}$ would be a bridge in G , contradicting Lemma 3.1. Let $S_1 = \{x''_1, x''_2, u_{5-j}\}$ and let G_1 be the sub-e-graph of G consisting of C , $F - u_1u_j$, the edges u_iv_i for $i \in \{1, 2, 3\}$, the edges $x_1x'_1$ and $x_2x'_2$, and the edges $x'_ix''_i$ for each $i \in \{1, 2\}$ such that $\deg x'_i = 2$; see Figure 20 illustrating one of the possible sub-e-graphs G_1 . If x'_1 or x'_2 has degree two, or if x'_1, x'_2 , and u_{5-j} are not pairwise distinct, or if u_1 or u_j has degree two in F , then the configuration G_1 attaching at S_1 is excluded by reducibility. Hence, we can assume the vertices x'_1, x'_2 , and u_{5-j} are pairwise distinct and have degree three in G , and the vertices u_1 and u_j have degree three in F .

Since G is triangle-free, there exist distinct non-adjacent vertices $z_1, z_2 \in S_1$; we let H_1 be the e-graph with the vertex set $S_1 \cup \{a, b, c\}$, edges z_1a, z_2a, ab, bc , and an edge from c to the vertex $z_3 \in S_1 \setminus \{z_1, z_2\}$, and with $d_{H_1}(b) = d_{H_1}(c) = 3$, see Figure 20. The standard argument for the configuration G_1 attaching at S_1 and the replacement graph H_1 enforcing

$|\varphi(x'_1) \cup \varphi(x'_2) \cup \varphi(u_{5-j})| \leq 10$ (as seen by Observation 3.2 with $k = 4$ applied to the path arising from H_1 by identifying z_1 and z_2 to a single vertex) gives an e-graph G'' and its proper induced sub-e-graph $F_1 \in \mathcal{C}_0$. Let us remark that since b and c are nailed in G'' and $\deg_{G''}(a) = 3$, to exclude the case $F_1 = G''$ by (a0) we only need to consider the possibility that the underlying graph of G'' is K_4^+ —that is, G consists of two disjoint 5-cycles C and $G'' - \{a, b, c\}$, each containing three vertices of degree three, an edge between the two cycles, and of $F - u_1 u_j$ (K_4^+ without an edge) joined by four edges to $C \cup G'' - \{a, b, c\}$. Figure 21 shows the elements of \mathcal{C}_0 arising in this way, while the rest of such e-graphs were shown to be 11/4-colorable by computer-assisted enumeration.

Note that G'' is 2-edge-connected by Lemma 3.1. Since $F_1 \neq G''$ and F_1 contains at most two nailed vertices, we conclude by Observation 2.6 that $b, c \notin V(F_1)$. Since G is critical, F_1 is not an induced sub-e-graph of G , and thus $a \in V(F_1)$. Since G'' is 2-edge-connected, F_1 contains at least two nailed vertices by Observation 2.6. By (a0), it follows that the underlying graph of F_1 is C_5 or K_4^+ and F_1 contains exactly two nailed vertices, one of which is a . Since $\deg_G z_3 = 3$, Corollary 3.6 implies z_3 is the other nailed vertex of F_1 and $F_1 = G'' - \{b, c\}$. However, this implies $\deg_{F_1}(z_1) = \deg_{F_1}(z_2) = 3$, which is not possible since the underlying graph of F_1 is C_5 or K_4^+ and $\deg_{F_1}(a) = 2$. \square

The coloring properties of a 5-cycle with three vertices of degree three are described in the next lemma, which follows from the measure version of Hall's theorem.

Lemma 6.4. *Let $C = v_1 v_2 v_3 v_4 v_5$ be a 5-cycle with vertices v_1, v_2 , and v_3 nailed. For $i \in \{1, 2, 3\}$, let a set $S(v_i) \subseteq [0, 11)$ have measure at least 7. There exists an 11/4-coloring φ of C such that $\varphi(v_i) \subseteq S(v_i)$ for $i \in \{1, 2, 3\}$ if and only if $|S(v_1) \cup S(v_2)| \geq 8$, $|S(v_2) \cup S(v_3)| \geq 8$, and $|S(v_1) \cup S(v_2) \cup S(v_3)| = 11$.*

Proof. The conditions $|S(v_i) \cup S(v_2)| \geq 8$ for $i \in \{1, 3\}$ are necessary, since $\varphi(v_2)$ and $\varphi(v_i)$ are disjoint sets of measure four. Furthermore, by Observation 2.10 with $A = \{v_1, v_3\}$, $z = v_2$, $B = \{v_1\}$, $C = \{v_3\}$, $z_1 = v_5$, and $z_2 = v_4$, we have $|\varphi(v_1) \cap \varphi(v_3)| = 1$. Consequently, $|\varphi(v_1) \cup \varphi(v_3)| = 7$, and since $\varphi(v_2)$ is disjoint from $\varphi(v_1) \cup \varphi(v_3)$, this implies $|\varphi(v_1) \cup \varphi(v_2) \cup \varphi(v_3)| = 11$, showing the necessity of the last condition.

Conversely, let $X_1 = S(v_1)$, $X_2 = S(v_1) \cap S(v_3)$, $X_3 = S(v_3)$, and $X_4 = S(v_2)$, and suppose there exist pairwise disjoint sets $L_1 \subseteq X_1$ and $L_3 \subseteq X_3$ of measure $a_1 = a_3 = 3$, $L_2 \subseteq X_2$ of measure $a_2 = 1$, and $L_4 \subseteq X_4$ of measure $a_4 = 4$. Then we can let $\varphi(v_1) = L_1 \cup L_2$, $\varphi(v_2) = L_4$, and $\varphi(v_3) = L_2 \cup L_3$; this 11/4-coloring extends to v_4 and v_5 by Observation 3.2 with $k = 3$, since $|\varphi(v_1) \cap \varphi(v_3)| = 1$. By Hall's theorem, such sets L_1, \dots, L_4 exist if the inequality

$$\left| \bigcup_{i \in I} X_i \right| \geq \sum_{i \in I} a_i$$

holds for every $I \subseteq \{1, 2, 3, 4\}$. Since $|S(v_i)| \geq 7$ for $i \in \{1, 2, 3\}$ (and thus $|X_2| \geq |S(v_1)| + |S(v_3)| - 11 \geq 3$), $X_2 \subseteq X_1$, and $X_2 \subseteq X_3$, all these inequalities are trivial or implied by the others, except for $|X_1 \cup X_2 \cup X_4| \geq 8$ (equivalent to $|S(v_1) \cup S(v_2)| \geq 8$), $|X_2 \cup X_3 \cup X_4| \geq 8$ (equivalent to $|S(v_2) \cup S(v_3)| \geq 8$), and $|X_1 \cup X_2 \cup X_3 \cup X_4| \geq 11$ (equivalent to $|S(v_1) \cup S(v_2) \cup S(v_3)| = 11$). \square

Corollary 6.5. *Let $C = v_1v_2v_3v_4v_5$ be a 5-cycle with vertices $v_1, v_2,$ and v_3 nailed. Let $f : \{1, 2, 3\} \rightarrow \{0, 1\}$ be a function such that $f(1) + f(2) + f(3) = 1$. For $i \in \{1, 2, 3\}$, let a set $S(v_i) \subseteq [0, 11)$ have measure at least $7 - f(i)$. If $|S(v_1) \cup S(v_2)| \geq 8 - f(1) - f(2)$, $|S(v_2) \cup S(v_3)| \geq 8 - f(2) - f(3)$, and $|S(v_1) \cup S(v_2) \cup S(v_3)| = 11$, then there exists an 11/4-coloring φ of C such that $|\varphi(v_i) \setminus S(v_i)| \leq f(i)$ holds for $i \in \{1, 2, 3\}$.*

Proof. We prove the claim in case $f(2) = 1$; the cases $f(1) = 1$ or $f(3) = 1$ are handled similarly. Let $A_1 = S(v_1) \setminus (S(v_2) \cup S(v_3))$, $A_2 = [0, 11) \setminus (S(v_1) \cup S(v_2) \cup S(v_3))$, $A_3 = S(v_3) \setminus (S(v_1) \cup S(v_2))$, and $A_4 = (S(v_1) \cap S(v_3)) \setminus S(v_2)$; note that the sets A_1, \dots, A_4 form a partition of $[0, 11) \setminus S(v_2)$. For $i = 1, \dots, 4$, let $a_i = |A_i|$. By the assumptions, we have (\star)

$$\begin{aligned} a_1, a_2, a_3, a_4 &\geq 0 \\ a_1 + \dots + a_4 &\leq 5 && \text{since } |S(v_2)| \geq 6 \\ a_2 + a_3 &\leq 4 && \text{since } |S(v_1) \cup S(v_2)| \geq 7 \\ a_1 + a_2 &\leq 4 && \text{since } |S(v_2) \cup S(v_3)| \geq 7 \end{aligned}$$

We claim there exist real numbers m_1, \dots, m_4 such that $0 \leq m_i \leq a_i$ for $i \in \{1, \dots, 4\}$, and

$$\begin{aligned} m_1 + \dots + m_4 &\leq 1 \\ (a_1 - m_1) + \dots + (a_4 - m_4) &\leq 4 \\ (a_2 - m_2) + (a_3 - m_3) &\leq 3 \\ (a_1 - m_1) + (a_2 - m_2) &\leq 3 \end{aligned}$$

It suffices to verify this is the case for the vertices of the polytope defined by (\star) . By symmetry between v_1 and v_3 , we only need to consider the vertices satisfying $a_1 \leq a_3$. These vertices and the corresponding values of m_1, \dots, m_4 are:

a_1	a_2	a_3	a_4	m_1	m_2	m_3	m_4
0	0	0	0	0	0	0	0
0	0	0	5	0	0	0	1
0	0	4	0	0	0	1	0
0	4	0	0	0	1	0	0
0	0	4	1	0	0	1	0
0	4	0	1	0	1	0	0
1	0	4	0	0	0	1	0
1	3	1	0	0	1	0	0

For $i \in \{1, \dots, 4\}$, choose a set $M_i \subseteq A_i$ of measure m_i arbitrarily, and let $M = M_1 \cup \dots \cup M_4$. Then

$$\begin{aligned} |S(v_2) \cup M| &= 11 - ((a_1 - m_1) + \dots + (a_4 - m_4)) \geq 7 \\ |S(v_1) \cup (S(v_2) \cup M)| &= 11 - ((a_2 - m_2) + (a_3 - m_3)) \geq 8, \text{ and} \\ |S(v_3) \cup (S(v_2) \cup M)| &= 11 - ((a_1 - m_1) + (a_2 - m_2)) \geq 8. \end{aligned}$$

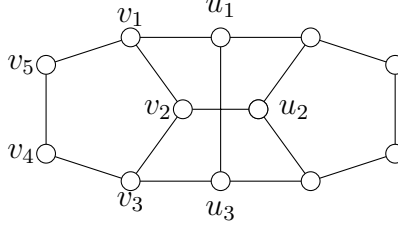

Figure 22: The e-graph from the case $j = 3$.

By Lemma 6.4, since $|S(v_1)|, |S(v_3)| \geq 7$ and $|S(v_1) \cup S(v_2) \cup S(v_3)| = 11$, there exists an 11/4-coloring φ of C such that $\varphi(v_1) \subset S(v_1)$, $\varphi(v_2) \subset S(v_2) \cup M$, and $\varphi(v_3) \subset S(v_3)$. Since $|M| = m_1 + \dots + m_4 \leq 1$, we have $|\varphi(v_2) \setminus S(v_2)| \leq 1$, as required. \square

Finally, we are ready to restrict the distance between vertices of degree two in a minimum counterexample.

Lemma 6.6. *If G is a minimum counterexample, then the distance between any two vertices of G of degree two is at least three.*

Proof. Let v_4 and v_5 be distinct vertices of G of degree two. By Lemma 4.2, the distance between v_4 and v_5 is not exactly two. Suppose for a contradiction that $v_4v_5 \in E(G)$.

By Lemma 3.5, G contains a 5-cycle $C = v_1v_2v_3v_4v_5$. For $i \in \{1, 2, 3\}$, let u_i be the neighbor of v_i not in C ; as we argued at the beginning of this section, the vertices u_1 , u_2 , and u_3 have degree three and are pairwise distinct. By Lemma 6.2 and symmetry, we can assume there exists $j \in \{2, 3\}$ such that u_1 and u_j do not have a common neighbor; moreover, the labels can be chosen so that either $j = 2$ or u_2 has a common neighbor with both u_1 and u_3 .

Let G' be the e-graph obtained from $G - V(C)$ by adding the edge u_1u_j and setting $d_{G'}(u_{5-j}) = 2$. Suppose first that G' has an 11/4-coloring φ . Let $f(1) = f(j) = 0$ and $f(5-j) = 1$. For $i \in \{1, 2, 3\}$, let $S(v_i) = [0, 11] \setminus \varphi(u_i)$; then $|S(v_i)| = 7 - f(i)$. Furthermore, the edge u_1u_j ensures that $\varphi(u_1)$ is disjoint from $\varphi(u_j)$, and thus $|S(v_1) \cup S(v_j)| = 11$. This implies $|S(v_1) \cup S(v_2)| \geq 8 - f(1) - f(2)$, $|S(v_2) \cup S(v_3)| \geq 8 - f(2) - f(3)$, and $|S(v_1) \cup S(v_2) \cup S(v_3)| = 11$. By Corollary 6.5, there exists an 11/4-coloring ψ of C such that $|\psi(v_i) \setminus S(v_i)| \leq f(i)$ holds for $i \in \{1, 2, 3\}$. Let $\psi(x) = \varphi(x)$ for every $x \in V(G) \setminus (V(C) \cup \{u_{5-j}\})$ and let $\psi(u_{5-j}) = \varphi(u_{5-j}) \setminus \psi(v_{5-j})$; note that $|\psi(u_{5-j})| \geq |\varphi(u_{5-j})| - f(5-j) = 4$. Then ψ is an 11/4-coloring of G , which is a contradiction.

Therefore, G' is not 11/4-colorable, and thus it contains a critical induced sub-e-graph F . By Lemma 6.3, $u_1u_j \notin E(F)$, $u_{5-j} \in V(F)$, and F is a 5-cycle with two nailed vertices. Since F is an induced sub-e-graph of G' and $u_1u_j \notin E(F)$, we have $\{u_1, u_j\} \not\subseteq V(F)$. If $|\{u_1, u_j\} \cap V(F)| = 1$, then the vertex of $\{u_1, u_j\} \cap V(F)$ is nailed in F , and the partition $\{V(C) \cup V(F), V(G) \setminus (V(C) \cup V(F))\}$ of $V(G)$ contradicts Corollary 3.6. Therefore, $\{u_1, u_j\} \cap V(F) = \emptyset$.

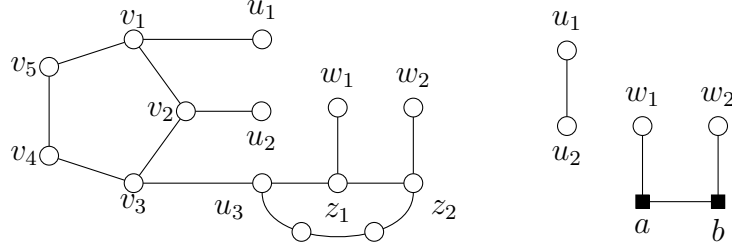

Figure 23: The e-graph G_1 and the replacement e-graph H_1 .

Suppose $j = 3$, and thus u_2 has a common neighbor in G with both u_1 and u_3 by the choice of the labels at the beginning of the proof; these common neighbors must be the nailed vertices of F . Since u_1 and u_3 do not have a common neighbor in G , Corollary 3.6 and Lemma 3.5 imply $u_1u_3 \in E(G)$. However, the corresponding graph G (depicted in Figure 22) is $11/4$ -colorable, which is a contradiction. Hence, we have $j = 2$.

Let w_1 and w_2 be the vertices of $G - V(F)$ with neighbors in $V(F)$ distinct from v_3 . Applying the observations from the beginning of the section to the 5-cycle in G corresponding to F , we conclude $w_1 \neq w_2$ and $\deg w_1 = \deg w_2 = 3$. Let z_1 and z_2 be the neighbors of w_1 and w_2 in $V(F)$, respectively; note that $\{z_1, z_2, u_3\}$ induces a subpath of F . Let $S_1 = \{u_1, u_2, w_1, w_2\}$ and let G_1 be the sub-e-graph of G consisting of $G[V(C) \cup V(F)]$ and the edges u_1v_1, u_2v_2, w_1z_1 and w_2z_2 . Let H_1 be the graph with the vertex set $S_1 \cup \{a, b\}$ and edges u_1u_2, w_1a, ab , and bw_2 , such that $d_{H_1}(a) = d_{H_1}(b) = 3$, see Figure 23 (showing the case that $u_3z_1z_2$ is a path in F ; another non-symmetric possibility is that $z_1u_3z_2$ is a path in F). The standard argument for the configuration G_1 attaching at S_1 and the replacement graph H_1 enforcing $\varphi(u_1) \cap \varphi(u_2) = \emptyset$ and $|\varphi(w_1) \cap \varphi(w_2)| \leq 3$ gives an e-graph G'' and its proper induced sub-e-graph $F_1 \in \mathcal{C}_0$. Let us remark that since a and b are nailed, to see that $F_1 \neq G''$ it suffices by (a0) to consider the cases that the underlying graph of G'' is C_5 or K_4^+ . However, G'' is not a 5-cycle since $\deg_{G''} u_1 = 3$. If the underlying graph of G'' is K_4^+ , then $\{u_1, u_2\} \cap \{w_1, w_2\}$ consists of a single vertex y and G is obtained from the 5-cycles C, F , and $G'' - \{a, b, y\}$ by adding an edge between each of the cycles and an edge from y to each of the cycles; by a computer-assisted enumeration, we verified that all such graphs are $11/4$ -colorable.

By Lemma 3.1, the graph G'' is connected, and since $F_1 \neq G''$, Observation 2.6 implies F_1 contains a nailed vertex distinct from a and b . Since F_1 contains at most two nailed vertices by (a0), we conclude $a, b \notin V(F_1)$. However, this means that F_1 is an induced sub-e-graph of G' not containing u_3 , which contradicts Lemma 6.3. \square

Since the distance between any two vertices of a 5-cycle is at most two, Lemma 6.6 has the following useful consequence.

Corollary 6.7. *Every 5-cycle in a minimum counterexample contains at least four vertices of degree three.*

Moreover, using Lemma 6.6 we can exclude one of the outcomes in Corollary 3.6, strengthening it as follows.

Corollary 6.8. *Every 2-edge-cut in a minimum counterexample is formed by the edges incident with a single vertex of degree two.*

7 4-cycle with adjacent 2-vertex

In this section, we show that vertices with a neighbor in a 4-cycle have degree three. Recall that vertices inside a 4-cycle have degree three by Lemma 5.1. As usual, we start the argument by discussing some degenerate cases.

Lemma 7.1. *Let $C = v_1v_2v_3v_4$ be a 4-cycle in a minimum counterexample G , and for $i \in \{1, 2, 3, 4\}$, let u_i be the neighbor of v_i not in C . Then the vertices u_1, \dots, u_4 are pairwise distinct, and for $i \in \{1, 2\}$, at most one of the vertices u_i and u_{i+2} has degree two.*

Proof. Since G is triangle-free, we have $u_1 \neq u_2$. If $u_1 = u_3$, then v_1 and v_3 would have the same neighbors, contradicting the criticality of G . Symmetric arguments show that the vertices u_1, \dots, u_4 are pairwise distinct. For $i \in \{1, 2, 3, 4\}$, let u'_i be the neighbor of u_i distinct from v_i if $\deg u_i = 2$ and let $u'_i = u_i$ otherwise. Let $S = \{u'_1, \dots, u'_4\}$ and let G_1 be the sub-e-graph of G consisting of C , the edges u_iv_i for $i \in \{1, 2, 3, 4\}$, and the edges $u_iu'_i$ for those i such that $\deg u_i = 2$. If $\deg u_1 = \deg u_3 = 2$ or $\deg u_2 = \deg u_4 = 2$, then the configuration G_1 attaching at S_1 is excluded by reducibility. \square

A bit surprisingly, the case there are two consecutive neighbors of degree two is substantially more complicated.

Lemma 7.2. *Let $C = v_1v_2v_3v_4$ be a 4-cycle in a minimum counterexample G , and for $i \in \{1, 2, 3, 4\}$, let u_i be the neighbor of v_i not in C . Then at most one of the vertices u_1, \dots, u_4 has degree two.*

Proof. Otherwise, we can by Lemma 7.1 and symmetry assume $\deg u_1 = \deg u_2 = 2$ and $\deg u_3 = \deg u_4 = 3$. For $i \in \{1, 2\}$, let u'_i be the neighbor of u_i distinct from v_i ; by Lemma 6.6, we have $\deg u'_i = 3$ and $u'_1 \neq u'_2$.

We claim that $u'_1 \neq u_3$.

Subproof. Suppose for a contradiction that $u'_1 = u_3$. If $u'_2 = u_4$, then since G does not contain K_4^+ as an induced subgraph by Lemma 5.3, we have $u_3u_4 \in E(G)$; but the resulting e-graph, depicted in Figure 24, belongs to \mathcal{C}_0 . Hence, we can assume $u'_2 \neq u_4$.

Let u'_3 be the neighbor of u_3 distinct from v_3 and u_1 . Let $S_1 = \{u'_2, u'_3, u_4\}$, let G_1 be the sub-e-graph of G consisting of C , the paths $v_1u_1u_3v_3$ and $v_2u_2u'_2$, and the edges v_4u_4 and $u_3u'_3$, and let H_1 be the e-graph with the vertex set $S_1 \cup \{a, b\}$, edges u_4a , ab , and bu'_2 , and $d_{H_1}(a) = d_{H_1}(b) = 3$, see Figure 25. The standard argument for the configuration G_1 attaching at S_1 and the replacement graph H_1 enforcing $|\varphi(u'_2) \cap \varphi(u_4)| \leq 3$ gives an e-graph G' and its proper induced sub-e-graph $F_1 \in \mathcal{C}_0$ (note that G' is triangle-free since

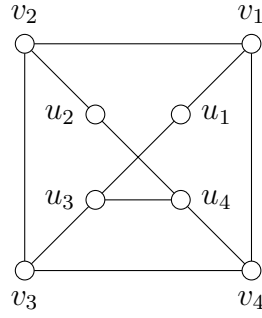

Figure 24: The critical e-graph arising in Lemma 7.2.

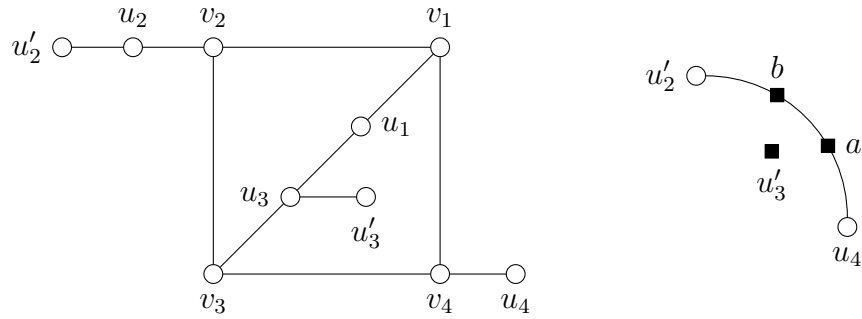

Figure 25: The e-graph G_1 and the replacement e-graph H_1 .

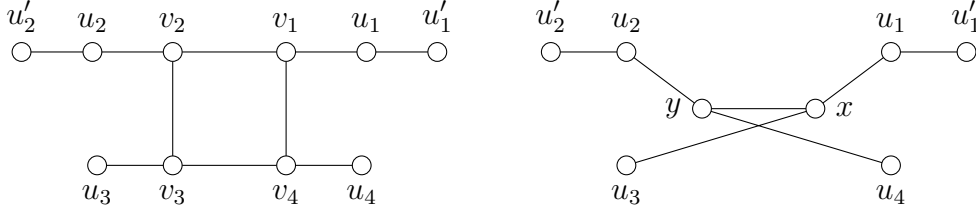

Figure 26: The part of G modified to create the e-graph G'' .

$u'_2 \neq u_4$, and $F_1 \neq G'$ by (a0) since a , b , and u'_3 are nailed in G' . Since G is critical, F_1 is not an induced sub-e-graph of G , and thus $a, b \in V(F_1)$. But G' is connected by Lemma 3.1, and thus by Observation 2.6, $F_1 \neq G''$ contains a nailed vertex distinct from a and b . This contradicts (a0). ■

Therefore, we have $u'_1 \neq u_3$, and symmetrically $u'_2 \neq u_4$. Let G'' be the graph obtained from G by identifying v_1 with v_3 to a new vertex x and v_2 with v_4 to a new vertex y , see Figure 26. Then G'' is triangle-free. Furthermore, G'' is not $11/4$ -colorable, since giving v_1 and v_3 the color set of x and v_2 and v_4 the color set of y would result in an $11/4$ -coloring of G . Hence, G'' contains a critical induced sub-e-graph F_2 , which by the minimality of G belongs to \mathcal{C}_0 . If $F_2 = G''$, then G is obtained from $F_2 \in \mathcal{C}_0$ by uncontracting the edge xy back to a 4-cycle; however, by a computer-assisted enumeration, we verified that all such graphs either belong to \mathcal{C}_0 or are not critical, which is a contradiction. Therefore, $F_2 \neq G''$. The graph G'' is 2-edge-connected by Corollary 6.8, and thus by Observation 2.6, F_2 has at least two nailed vertices. By (a0), F_2 has exactly two nailed vertices and the underlying graph of F_2 is C_5 or K_4^+ .

Since G is critical, it does not contain an e-graph isomorphic to F_2 as an induced sub-e-graph, and thus $\{u_1, u_2\} \cap V(F_2) \neq \emptyset$. By symmetry, we can assume $u_1 \in V(F_2)$, and thus also $u'_1, x \in V(F_2)$. Consequently, F_2 contains at least three distinct vertices whose degree in G'' is three, namely u'_1 , x , and either y or u_3 . Since F_2 has only two nailed vertices, the underlying graph of F_2 cannot be C_5 , and thus it is K_4^+ .

If $\deg_{F_2} x = 3$, then since $\deg_{F_2} u_1 = 2$ and no vertex of K_4^+ has two neighbors of degree two, it follows that $\deg_{F_2} y = 3$. Since K_4^+ contains two edges joining vertices of degree two, we have $\deg_{F_2} u'_1 = \deg_{F_2} u'_2 = 2$, and consequently u'_1 and u'_2 are the two nailed vertices of F_2 . Hence, precisely two edges of G are leaving $(V(F_2) \setminus \{x, y\}) \cup V(C)$, and these edges are incident with u'_1 and u'_2 . By Corollary 6.8, u'_1 and u'_2 have a common neighbor z of degree two in G . However, then u'_1 has two neighbors of degree two in G , namely u_1 and z , contradicting Lemma 4.2.

Therefore, $\deg_{F_2} x = 2$. If $y \in V(F_2)$, then since both x and u_1 have degree two, y would have to have degree three, and y would be adjacent to two vertices x and u_2 of degree two in F_2 . This does not happen in K_4^+ . Consequently $y \notin V(F_2)$, and thus also $u_2 \notin V(F_2)$ and $u_3 \in V(F_2)$. Let c be the nailed vertex of F_2 distinct from x and using Lemma 3.1, observe that $u'_2 \neq c \neq u'_4$. Let c' be the neighbor of c in G not belonging to $V(F_2)$. Since the underlying graph of F_2 is K_4^+ , c has a non-nailed neighbor c'' of degree two in F_2 . Note

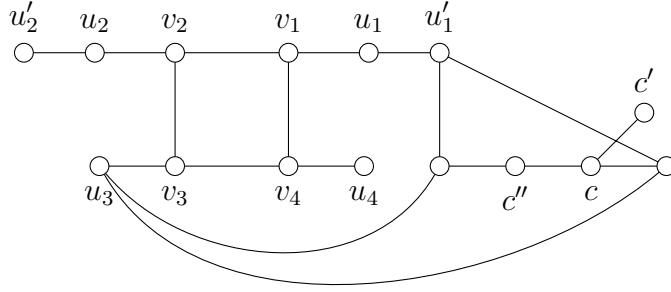

Figure 27: The e-graph G_2 .

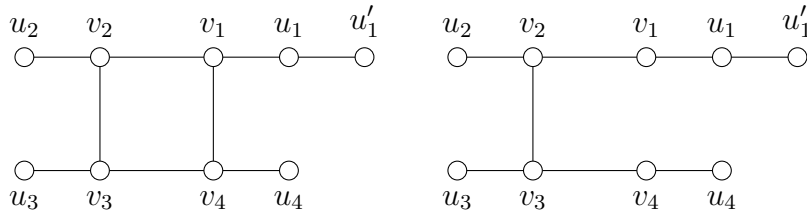

Figure 28: The e-graph G_1 and the replacement e-graph H .

that $\deg_G c'' = 2$, and thus $\deg_G c' = 3$ by Lemma 4.2. Let $S_2 = \{u'_2, u_4, c'\}$ and let G_2 be the subgraph of G consisting of $G[V(F - x) \cup V(C) \cup \{u_2\}]$ and the edges $u_2 u'_2$, $v_4 u_4$, and $c c'$, see Figure 27. The configuration G_2 attaching at S_2 is excluded by reducibility, which is a contradiction. \square

Finally, let us deal with the case there is exactly one neighbor of degree two.

Lemma 7.3. *Let G be a minimum counterexample and suppose that a vertex $v \in V(G)$ has a neighbor in a 4-cycle. Then $\deg v = 3$.*

Proof. Let $C = v_1 v_2 v_3 v_4$ be a 4-cycle in G , and for $i \in \{1, 2, 3, 4\}$, let u_i be the neighbor of v_i not in C . Suppose for a contradiction that $\deg u_1 = 2$. By Lemma 7.1, the vertices u_1, \dots, u_4 are pairwise distinct, and by Lemma 7.2, the vertices u_2, u_3 , and u_4 have degree three. Let u'_1 be the neighbor of u_1 distinct from v_1 ; we have $\deg u'_1 = 3$ by Lemma 6.6.

Let $S = \{u'_1, u_2, u_3, u_4\}$, let G_1 be the sub-e-graph of G consisting of C , the path $v_1 u_1 u'_1$, and the edges $v_i u_i$ for $i \in \{2, 3, 4\}$, and let H be obtained from G_1 by deleting the edge $v_1 v_4$ and setting $d_H(v_1) = d_H(v_4) = 2$, see Figure 28. Note that in any $11/4$ -coloring φ of H , Observation 2.10 implies $|\varphi(v_2) \cap \varphi(u_4)| \leq 2$, $|\varphi(v_2) \cap \varphi(u'_1)| \leq 1$, and $|\varphi(v_2) \cap \varphi(u_2)| = 0$, and thus $|\varphi(v_2) \setminus (\varphi(u'_1) \cup \varphi(u_2) \cup \varphi(u_4))| \geq 1$. This implies $|\varphi(u'_1) \cup \varphi(u_2) \cup \varphi(u_4)| \leq 10$. The standard argument for the configuration G_1 attaching at S and the replacement graph H enforcing $|\varphi(u_3) \cap \varphi(u_4)| \leq 2$, $|\varphi(u_2) \cap \varphi(u_3)| \leq 3$, and $|\varphi(u'_1) \cup \varphi(u_2) \cup \varphi(u_4)| \leq 10$ gives an e-graph G' and its proper induced sub-e-graph $F \in \mathcal{C}_0$.

Note that G' is 2-edge-connected by Corollary 6.8, and since $F \neq G'$, at least two vertices of F are nailed by Observation 2.6. By (a0), exactly two vertices of F are nailed and the underlying graph of F is C_5 or K_4^+ . Since G is critical, F is not an induced sub-e-graph of G , and thus $\{v_1, v_4\} \cap V(F) \neq \emptyset$. If F is a 5-cycle, then F contains exactly one of v_1 and v_4 , since G is triangle-free; but then the corresponding 5-cycle in G has only three nailed vertices (the two nailed vertices of F and the vertex of $\{v_1, v_4\} \cap V(F)$), contradicting Corollary 6.7. If the underlying graph of F is K_4^+ , then $v_1, v_4 \in V(F)$ by Lemma 5.3, implying that v_1, u_1 , and v_4 are vertices of F of degree two. This is a contradiction, since none of them is nailed in F , F has two nailed vertices, and K_4^+ has only four vertices of degree two. \square

8 Vertices of degree two

We now aim to get rid of vertices of degree two completely. We need the following observation.

Lemma 8.1. *Let A_1, A_2, B , and C be measurable subsets of $[0, 11)$ such that $|A_1| = |A_2| = 4$, $|B| = 5$ and $|C| = 1$, and B is disjoint from $A_1 \cup A_2 \cup C$. Then there exists a set $X \subset [0, 11) \setminus (B \cup C)$ of measure 2 such that $|A_1 \cap X| \leq 1$ and $|A_2 \cap X| \leq 1$.*

Proof. Without loss of generality, we can assume $B = [6, 11)$ and $C = [5, 6)$. Furthermore, we can assume that $A_1, A_2 \subset [0, 5)$, since replacing A_i by a subset of $[0, 5)$ of measure 4 containing $A_i \cap [0, 5)$ only makes it harder to select X . Let $t = |[0, 5) \setminus (A_1 \cup A_2)|$; then $|A_1 \setminus A_2| = |A_2 \setminus A_1| = 1 - t$. Hence, we can let X consist of $X_1 = [0, 5) \setminus (A_1 \cap A_2)$ (a set of measure $2 - t$) together with a subset X_2 of $A_1 \cap A_2$ of measure t . For $i \in \{1, 2\}$, the set X intersects A_i in $(A_i \setminus A_{3-i}) \cup X_2$, which has measure $(1 - t) + t = 1$. \square

Let us constrain the neighborhoods of vertices of degree two. To this end, we exploit the stronger statement we are proving (obtaining larger color sets on vertices of degree two in the reduced graphs) as well as the possibility to convexly combine colorings arising from several different reductions.

Lemma 8.2. *Let G be a minimum counterexample, let $v \in V(G)$ have degree two, and let v_1 and v_2 be the neighbors of v . Then $G - \{v, v_1, v_2\}$ contains a 5-cycle K such that each of v_1 and v_2 has exactly one neighbor in K and a vertex of K has degree two in G .*

Proof. We have $\deg v_1 = \deg v_2 = 3$ by Lemma 6.6. For $i \in \{1, 2\}$, let $u_{i,1}$ and $u_{i,2}$ be the neighbors of v_i distinct from v . By Lemmas 5.1 and 6.6, the vertices $u_{i,j}$ for $i, j \in \{1, 2\}$ are pairwise distinct and have degree three.

Firstly, we claim that G has a set 11-coloring φ_1 such that $|\varphi_1(v)| = 1$, for $i \in \{1, 2\}$ we have $|\varphi_1(v_i)| = 7$, and for $j \in \{1, 2\}$, we have $|\varphi_1(u_{i,j})| = 3$. Note that φ_1 is not an 11/4-coloring: The measures of $\varphi_1(v)$ and $\varphi_1(u_{i,j})$ are smaller than needed, while the measures of $\varphi_1(v_1)$ and $\varphi_1(v_2)$ are larger.

Subproof. Let G' be the e-graph obtained from $G - v$ by setting $d_{G'}(v_1) = d_{G'}(v_2) = 2$. Suppose that G' has a critical induced sub-e-graph F_1 , by the minimality of G belonging

to \mathcal{C}_0 . By a computer-assisted enumeration, we verified that adding a common neighbor to a pair of non-nailed vertices in an e-graph from \mathcal{C}_0 results either in an e-graph from \mathcal{C}_0 or in a non-critical e-graph. Since G is obtained from G' in this way, we have $G' \notin \mathcal{C}_0$, and thus $F_1 \neq G'$. By Corollary 6.8, G' is 2-edge-connected, and thus F_1 contains at least two nailed vertices by Observation 2.6. By (a0), F_1 contains exactly two nailed vertices and the underlying graph of F_1 is C_5 or K_4^+ . By Lemma 5.3, F_1 is a 5-cycle. By Corollary 6.7, at least four vertices of F_1 have degree three in G , and since only two vertices of F_1 are nailed, it follows that $v_1, v_2 \in F_1$. Since G is triangle-free, this implies v_1 and v_2 have a common neighbor distinct from v . However, this contradicts Lemma 5.1.

Therefore, G' does not contain a critical induced sub-e-graph, and thus G' has an 11/4-coloring φ'_1 . Note that $|\varphi'_1(v_i)| = 5$ for $i \in \{1, 2\}$. Let us now define the set 11-coloring φ_1 of G as follows. Let $\varphi_1(v)$ be an arbitrary subset of $[0, 11) \setminus (\varphi'_1(v_1) \cup \varphi'_1(v_2))$ of measure 1. For every vertex x at distance at least three from v , let $\varphi_1(x) = \varphi'_1(x)$. For $i \in \{1, 2\}$, let X_i be the set obtained using Lemma 8.1 with $C = \varphi_1(v)$, $B = \varphi'_1(v_i)$, $A_1 = \varphi'_1(u_{i,1})$, and $A_2 = \varphi'_1(u_{i,2})$. Let $\varphi_1(v_i) = \varphi'_1(v_i) \cup X_i$ and for $j \in \{1, 2\}$, let $\varphi_1(u_{i,j})$ be a subset of $\varphi'_1(u_{i,j}) \setminus X_i$ of measure 3. Let us remark that $|\varphi_1(v_i)| = |\varphi'_1(v_i)| + |X_i| = 7$. ■

Let G'' be the e-graph obtained from $G - \{v_1, v, v_2\}$ by setting $d_{G''}(u_{i,j}) = 2$ for $i, j \in \{1, 2\}$. We claim G'' does not have any 11/4-coloring.

Subproof. Suppose for a contradiction G'' has an 11/4-coloring φ_2 . Note that $|\varphi_2(u_{i,j})| = 5$ for $i, j \in \{1, 2\}$. For $i \in \{1, 2\}$, choose $\varphi_2(v_i)$ as a subset of $[0, 11) \setminus (\varphi_2(u_{i,1}) \cup \varphi_2(u_{i,2}))$ of measure 1, and let $\varphi_2(v)$ be a subset of $[0, 11) \setminus (\varphi_2(v_1) \cup \varphi_2(v_2))$ of measure 9; again, this extension of φ_2 to G is a set 11-coloring but not an 11/4-coloring. However, consider the set 11-coloring $\varphi = \frac{1}{2}\varphi_1 + \frac{1}{2}\varphi_2$. We now apply Observation 2.7. For a vertex x at distance at least three from v , we have $|\varphi(x)| = |\varphi_1(x)| = |\varphi_2(x)| = 7 - d_G(x)$. For $i \in \{1, 2\}$, we have $|\varphi(v_i)| = \frac{1}{2}(|\varphi_1(v_i)| + |\varphi_2(v_i)|) = \frac{1}{2}(7 + 1) = 4 = 7 - d_G(v_i)$, and for $j \in \{1, 2\}$, we have $|\varphi(u_{i,j})| = \frac{1}{2}(|\varphi_1(u_{i,j})| + |\varphi_2(u_{i,j})|) = \frac{1}{2}(3 + 5) = 4 = 7 - d_G(u_{i,j})$. Finally, $|\varphi(v)| = \frac{1}{2}(|\varphi_1(v)| + |\varphi_2(v)|) = \frac{1}{2}(1 + 9) = 5 = 7 - d_G(v)$. Therefore, φ is an 11/4-coloring of G , which is a contradiction. ■

Since G'' does not have an 11/4-coloring, it contains a critical induced sub-e-graph F_2 , which by the minimality of G belongs to \mathcal{C}_0 . By a computer-assisted enumeration, we verified that for any 4-tuple (a_1, a_2, a_3, a_4) of distinct non-nailed vertices of degree two in an e-graph from \mathcal{C}_0 in which neither a_1a_2 nor a_3a_4 is an edge, adding a vertex b_1 adjacent to a_1 and a_2 , a vertex b_2 adjacent to a_3 and a_4 , and a common neighbor of b_1 and b_2 results either in an e-graph from \mathcal{C}_0 or in a non-critical e-graph. Since G arises from G'' in this way, we have $G'' \notin \mathcal{C}_0$, and thus $F_2 \neq G''$. By Lemma 5.3, the underlying graph of F_2 is not K_4^+ .

If F_2 is a 5-cycle, then at least four vertices of F_2 have degree three in G by Corollary 6.7. Since F_2 has at most two nailed vertices by (a0), it follows that F_2 contains at least two of the vertices $\{u_{i,j} : i, j \in \{1, 2\}\}$. Since $\deg_G v = 2$, Lemma 7.3 and the assumption that G is triangle-free imply that the distance between $u_{1,1}$ and $u_{1,2}$ and the distance between $u_{2,1}$ and $u_{2,2}$ in G'' is at least three. Consequently $|V(F_2) \cap \{u_{i,1}, u_{i,2}\}| = 1$ for $i \in \{1, 2\}$, exactly

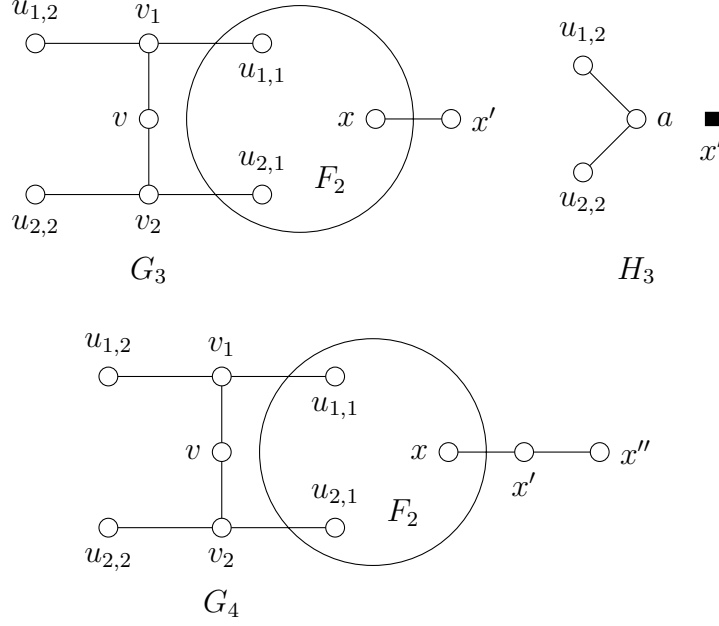

Figure 29: The e-graphs G_3 and G_4 and the replacement e-graph H_3 .

four vertices of F_2 are nailed, and exactly one vertex of F_2 has degree two in G . Hence, the conclusion of this lemma holds with $K = F_2$.

Therefore, we can assume the underlying graph of F_2 is neither C_5 nor K_4^+ , and by (a0), F_2 has at most one nailed vertex. By Corollary 6.8, the graph G'' is connected. Since $F_2 \neq G''$, Observation 2.6 implies F_2 has exactly one nailed vertex x . Let x' be the neighbor of x in $V(G'') \setminus V(F_2)$; note that xx' is the only edge of G'' between $V(F_2)$ and $V(G'') \setminus V(F_2)$. Since G is critical, F_2 is not an induced sub-e-graph of G , and thus we can by symmetry assume $u_{1,1} \in V(F_2)$. If $\{u_{2,1}, u_{2,2}\} \cap V(F_2) = \emptyset$, then we obtain a contradiction with Corollary 6.8 by considering the two edges leaving either $V(F_2)$ (if $u_{1,2} \notin V(F_2)$) or $V(F_2) \cup \{v_1\}$ (if $u_{1,2} \in V(F_2)$) in G . Therefore, by symmetry we can assume $u_{2,1} \in V(F_2)$. Similarly, if $\{u_{1,2}, u_{2,2}\} \cap V(F_2) \neq \emptyset$, then at most two edges leave $V(F_2) \cup \{v_1, v, v_2\}$ in G , and we obtain a contradiction with Corollary 6.8. Therefore, $u_{1,2}, u_{2,2} \notin V(F_2)$.

Let $S_3 = \{u_{1,2}, u_{2,2}, x'\}$ and let G_3 be the sub-e-graph of G consisting of $G[V(F_2)]$, the path $u_{1,1}v_1vv_2u_{2,1}$, and the edges $u_{1,2}v_1$, $u_{2,2}v_2$, and xx' . In case $\deg x' = 2$, let x'' be the neighbor of x' distinct from x ; we have $\deg x'' = 3$ by Lemma 6.6. Let $S_4 = \{u_{1,2}, u_{2,2}, x''\}$ and let G_4 be obtained from G_3 by adding the edge $x'x''$, see Figure 29. Since $F_2 \in \mathcal{C}_0$, there are only finitely many choices for G_3 and G_4 . The configuration G_4 attaching at S_4 is excluded by reducibility, and thus $\deg x' = 3$. We claim that $u_{1,2}u_{2,2} \in E(G)$.

Subproof. Suppose for a contradiction that $u_{1,2}u_{2,2} \notin E(G)$, and let H_3 be the e-graph with the vertex set $S_3 \cup \{a\}$, edges $u_{1,2}a$ and $u_{2,2}a$, and $d_{H_3}(a) = 2$, see Figure 29. The standard argument for the configuration G_3 attaching at S_3 and the replacement graph H_3 enforcing $|\varphi(u_{1,2}) \cup \varphi(u_{2,2})| \leq 6$ gives an e-graph G''' and its proper induced sub-e-graph $F_3 \in \mathcal{C}_0$; to

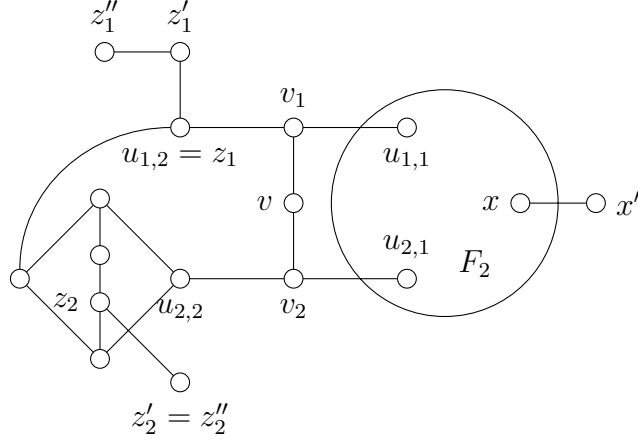

Figure 30: The e-graph G_5 .

verify that $F_3 \neq G'''$, we consider all possible combinations of an e-graph from \mathcal{C}_0 with one nailed vertex (corresponding to x') minus a vertex of degree two to represent $F_3 - a$, another e-graph from \mathcal{C}_0 with one nailed vertex (and with the underlying graph distinct from C_5 and K_4^+) to represent F_2 , and the neighborhood of a vertex of degree two (corresponding to the path v_1vv_2), and conclude by a computer-assisted enumeration that all graphs arising in this way either belong to \mathcal{C}_0 or are not critical.

By Corollary 6.8, the graph G''' is 2-edge-connected. Since $F_3 \neq G'''$, Observation 2.6 implies F_3 has at least two nailed vertices distinct from x' . By (a0), F_3 has exactly two nailed vertices and $x' \notin V(F_3)$, and the underlying graph of F_3 is either C_5 or K_4^+ . Furthermore, since G is critical, F_3 is not an induced sub-e-graph of G , and thus $a \in V(F_3)$. If F_3 were a 5-cycle, then $u_{1,2}$ and $u_{2,2}$ would have to be its nailed vertices, since they have degree three in G ; however, then F_3 would contain two adjacent vertices whose degree in G is two, contradicting Lemma 6.6.

Hence, the underlying graph of F_3 is K_4^+ . Let z_1 and z_2 be the nailed vertices of F_3 , and let z_1' and z_2' be their neighbors in G not belonging to F_3 . For $i \in \{1, 2\}$, if $\deg z_i' = 2$, then let z_i'' be the neighbor of z_i' distinct from z_i , otherwise let $z_i'' = z_i'$. Let $S_5 = \{z_1'', z_2'', x'\}$ and let G_5 be the sub-e-graph of G consisting of G_3 , $G[V(F_3 - a)]$, the edges z_1z_1' and z_2z_2' , and the edges $z_i'z_i''$ for $i \in \{1, 2\}$ such that $\deg z_i' = 2$, see Figure 30. The configuration G_5 attaching at S_5 is excluded by reducibility. \blacksquare

Therefore, we have $u_{1,2}u_{2,2} \in E(G)$. For $i \in \{1, 2\}$, let w_i be the neighbor of $u_{i,2}$ distinct from v_i and $u_{3-i,2}$. If $\deg w_i = 2$, then let w_i' be the neighbor of w_i distinct from $u_{i,2}$, otherwise let $w_i' = w_i$. Let $S_6 = \{w_1', w_2', x'\}$ and let G_6 be the sub-e-graph of G obtained from G_3 by adding the path $w_1u_{1,2}u_{2,2}w_2$, and for $i \in \{1, 2\}$ such that $\deg w_i = 2$, the edge w_iw_i' , see Figure 31. If $\deg w_1 = 2$ or $\deg w_2 = 2$, then the configuration G_6 attaching at S_6 is excluded by reducibility. Therefore, $\deg w_1 = \deg w_2 = 3$.

Let H_6 be the e-graph with the vertex set $S_6 \cup \{b, c\}$, edges w_1b , bc , and cw_2 , and

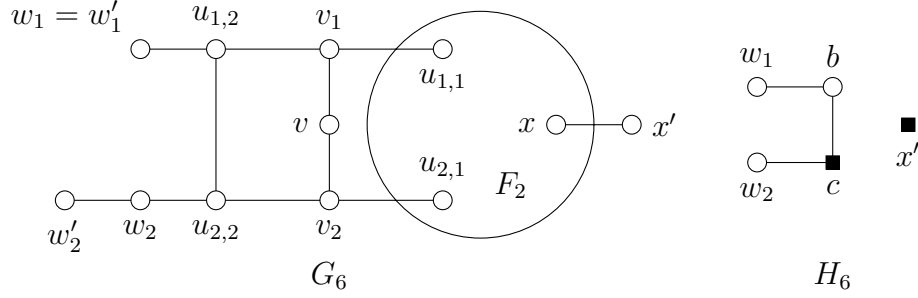

Figure 31: The e-graph G_6 and the replacement e-graph H_6 .

$d_{H_6}(b) = 2$ and $d_{H_6}(c) = 3$, see Figure 31. The standard argument for the configuration G_6 attaching at S_6 and the replacement graph H_6 enforcing $|\varphi(w_1) \cap \varphi(w_2)| \leq 2$ gives an e-graph G^* and its proper induced sub-e-graph $F_6 \in \mathcal{C}_0$; the case $F_6 = G^*$ is excluded as follows: Note that G^* contains two nailed vertices x' and c , and thus by (a0), we would have that the underlying graph of G^* is C_5 or K_4^+ . Replacing the path w_1bcw_2 in G^* by the path $w_1u_{1,2}u_{2,2}w_2$, we obtain an induced sub-e-graph G_1^* in G with the same underlying graph, which by Lemma 5.3 cannot be K_4^+ . Moreover, only three vertices $x', u_{1,2}$, and $u_{2,2}$ of G_1^* would be nailed, contradicting Corollary 6.7 when G_1^* is a 5-cycle.

Since G is critical, F_6 is not an induced sub-e-graph of G , and thus $b, c \in V(F_6)$, and c is a nailed vertex of F_6 . However, G^* is 2-edge-connected by Corollary 6.8, implying by Observation 2.6 that $F_6 \neq G^*$ has at least two nailed vertices distinct from c ; this contradicts (a0). \square

Lemma 8.2 shows that near to each vertex v of degree two, there must be a 5-cycle containing another vertex v' of degree two. We plan to apply Lemma 8.2 to v' , obtaining another 5-cycle containing a vertex of degree two. Let us now exclude two special combinations of 5-cycles that can arise in this way.

Lemma 8.3. *Let G be a smallest counterexample and let $C_1 = v_1v_2v_3v_4v_5$ and $C_2 = v_1v_2w_3w_4w_5$ be 5-cycles in G intersecting in the edge v_1v_2 . If $\deg v_4 = 2$, then $\deg w_4 = 3$.*

Proof. Suppose for a contradiction that $\deg w_4 = 2$. Note that $v_3w_5, w_3v_5 \notin E(G)$ by Lemma 7.3. Since G is triangle-free, we conclude that $C_1 \cup C_2$ is an induced sub-e-graph of G . Let z_1, z_2, z_3 , and z_4 be the neighbors of v_3, v_5, w_3 , and w_5 , respectively, not belonging to $C_1 \cup C_2$. By Lemma 6.6, the vertices z_1, \dots, z_4 have degree three. Observe there exists a permutation π of $\{1, 2, 3, 4\}$ such that $z_{\pi(1)}z_{\pi(2)}, z_{\pi(3)}z_{\pi(4)} \notin E(G)$: Otherwise, since G is triangle-free, we could by symmetry assume $z_1z_2, z_1z_3, z_1z_4 \in E(G)$, and since $\deg z_1 = 3$ and $z_1v_3 \in E(G)$, we would have $z_i = z_j$ for distinct $i, j \in \{2, 3, 4\}$. We have $z_2 \neq z_4 \neq z_3$ by Lemmas 5.1 and 7.3, and thus $z_2 = z_3$. However, then z_4 would be incident with a bridge, contradicting Lemma 3.1.

Let $S = \{z_1, z_2, z_3, z_4\}$ and let G_1 be the sub-e-graph of G consisting of $C_1 \cup C_2$ and the edges v_3z_1, v_5z_2, w_3z_3 , and w_5z_4 . Let H be the e-graph with the vertex set $S \cup \{a, b, c\}$, edges

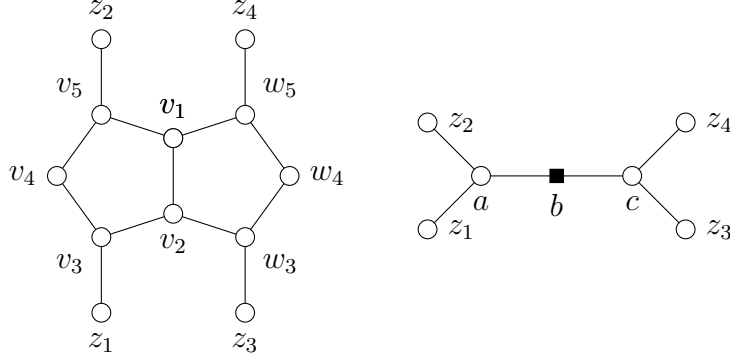

Figure 32: The e-graph G_1 and the replacement e-graph H if π is the identity.

$z_{\pi(1)}a$, $z_{\pi(2)}a$, ab , bc , $cz_{\pi(3)}$, and $cz_{\pi(4)}$, and with $d_H(a) = d_H(b) = d_H(c) = 3$, see Figure 32. Note that for any 11/4-coloring φ of H , Observation 2.10 implies $|(\varphi(z_{\pi(1)}) \cup \varphi(z_{\pi(2)})) \cap \varphi(c)| \leq 3$ and $|(\varphi(z_{\pi(3)}) \cup \varphi(z_{\pi(4)})) \cap \varphi(c)| = 0$, and thus $|\varphi(c) \setminus (\bigcup_{i=1}^4 \varphi(z_i))| \geq 1$, and $|\bigcup_{i=1}^4 \varphi(z_i)| \leq 10$. The standard argument for the configuration G_1 attaching at S and the replacement graph H enforcing $|\bigcup_{i=1}^4 \varphi(z_i)| \leq 10$ gives an e-graph G' and its proper induced sub-e-graph $F \in \mathcal{C}_0$ (note that in the computer-assisted argument to exclude $F = G'$, we can assume that $z_{\pi(1)} \neq z_{\pi(2)}$ and $z_{\pi(3)} \neq z_{\pi(4)}$, since otherwise H would contain two nailed vertices and by (a0), F would be C_5 or K_4^+ ; and since the nailed vertices of F would be adjacent, F would also contain two adjacent non-nailed vertices of degree two, implying that G contains two adjacent vertices of degree two in contradiction to Lemma 6.6).

By Corollary 6.8, the graph G' is 2-edge-connected, implying by Observation 2.6 that F contains at least two nailed vertices distinct from the nailed vertex b of G'' . By (a0), it follows that $b \notin V(F)$ and the underlying graph of F is C_5 or K_4^+ . Since G is critical, F is not an induced sub-e-graph of G , and thus we can assume $a \in V(F)$, a is a nailed vertex of F , and $z_{\pi(1)} \neq z_{\pi(2)}$. Since both $z_{\pi(1)}$ and $z_{\pi(2)}$ have degree three in G'' and F has only one nailed vertex other than a , F is not a 5-cycle. If the underlying graph of F is K_4^+ , then $z_{\pi(1)}$ or $z_{\pi(2)}$ is the other nailed vertex of F and F contains two adjacent non-nailed vertices of degree two. These vertices have degree two in G as well, contradicting Lemma 6.6. \square

Lemma 8.4. *Suppose $C_1 = v_1v_2v_3v_4v_5$ and $C_2 = w_1w_2w_3w_4w_5$ are disjoint cycles in a smallest counterexample G and $v_1w_1, v_3w_3 \in E(G)$. If $\deg v_2 = 2$, then $\deg w_2 = 3$.*

Proof. Suppose for a contradiction that $\deg w_2 = 2$. Note that $v_4w_4, w_5v_5 \notin E(G)$ by Lemma 7.3. If $v_4w_5 \in E(G)$, then Corollary 6.8 implies that either $v_5w_4 \in E(G)$, or v_5 and w_4 have a common neighbor of degree two; however, both such graphs are 11/4-colorable. Therefore $v_5w_4 \notin E(G)$, and symmetrically $v_4w_5 \notin E(G)$. Let z_1, z_2, z_3 , and z_4 be the neighbors of v_4, v_5, w_4 , and w_5 , respectively, not belonging to $C_1 \cup C_2$.

Suppose $i, j \in \{1, 2, 3, 4\}$ are distinct, $z_i = z_j$, and $\deg z_i = 2$. Letting $\{k, l\} = \{1, 2, 3, 4\} \setminus \{i, j\}$, Corollary 6.8 implies that $z_k = z_l$ also has degree two; but then G is 11/4-colorable (or contains a triangle), which is a contradiction. Hence, if $\deg z_i = 2$, then

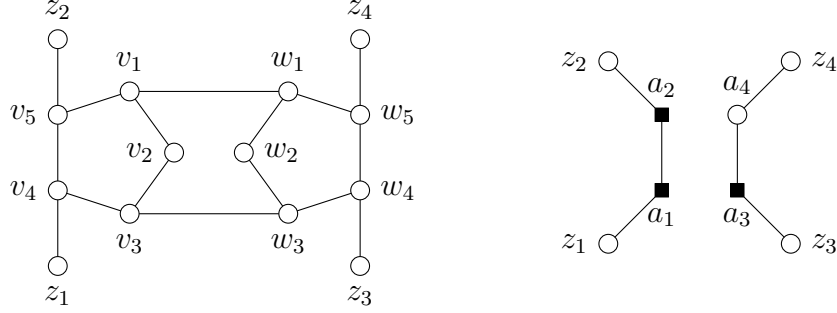

Figure 33: The e-graph G_1 and the replacement e-graph H .

z_i is distinct from all vertices z_j for $j \in \{1, 2, 3, 4\} \setminus \{i\}$; we let z'_i be the neighbor of z_i not in $C_1 \cup C_2$. If $\deg z_i = 3$, we let $z'_i = z_i$.

Let $S = \{z'_1, \dots, z'_4\}$ and let G_1 be the sub-e-graph of G consisting of $G[V(C_1) \cup V(C_2)]$, the edges $v_4z_1, v_5z_2, w_4z_3, w_5z_4$, and the edges $z_i z'_i$ for $i \in \{1, 2, 3, 4\}$ such that $\deg z_i = 2$, see Figure 33. If at least one of the vertices z_1, \dots, z_4 has degree two, then the configuration G_1 attaching at S is excluded by reducibility. Hence, suppose that all vertices z_1, \dots, z_4 have degree three. Let H be the e-graph with the vertex set $S \cup \{a_1, a_2, a_3, a_4\}$, edges of the paths $z_1 a_1 a_2 z_2$ and $z_3 a_3 a_4 z_4$, and with $d_H(a_i) = 3$ for $i \in \{1, 2, 3\}$ and $d_H(a_4) = 2$, see Figure 33. The standard argument for the configuration G_1 attaching at S and the replacement graph H enforcing $|\varphi(z_1) \cap \varphi(z_2)| \leq 3$ and $|\varphi(z_3) \cap \varphi(z_4)| \leq 2$ gives an e-graph G' and its proper induced sub-e-graph $F \in \mathcal{C}_0$ (we have $F \neq G'$ by (a0), since G' has three nailed vertices).

Since G is critical, F is not an induced sub-e-graph of G (even after possibly replacing the path $z_1 a_1 a_2 z_2$ by the path $z_1 v_4 v_5 z_2$) and thus $a_3, a_4 \in V(F)$. Corollary 6.8 implies G' is connected, and thus by Observation 2.6, $F \neq G'$ contains another nailed vertex in addition to a_3 . Hence, by (a0) F contains two nailed vertices and the underlying graph of F is either C_5 or K_4^+ . However, if F were a 5-cycle, then the corresponding 5-cycle in G (obtained by replacing the path $z_3 a_3 a_4 z_4$ by $z_3 w_4 w_5 z_4$) would only contain three vertices of degree three, contradicting Corollary 6.7, and the case that the underlying graph of F is K_4^+ is excluded by Lemma 5.3. \square

We are now ready to prove the main result of this section.

Lemma 8.5. *Every minimum counterexample is 3-regular.*

Proof. Suppose for a contradiction that a minimum counterexample G contains a vertex v of degree two. By Lemma 8.2 (considering the vertex of degree two contained in K instead of v if necessary), we can without loss of generality assume that v is contained in a 5-cycle $C_1 = u_{1,1} v_1 v v_2 u_{2,1}$. By Corollary 6.7, all vertices of C_1 except for v have degree three. Let $u_{1,2}$ and $u_{2,2}$ be the neighbors of v_1 and v_2 not in C_1 , respectively; we have $u_{1,2} \neq u_{2,2}$ and $\deg u_{1,2} = \deg u_{2,2} = 3$ by Lemmas 5.1 and Lemma 6.6. By Lemma 8.2, there exists a 5-cycle $C_2 \subset G - \{v_1, v_2, v\}$ containing another vertex of degree two such that each of v_1 and v_2 has exactly one neighbor in C_2 . We claim that these neighbors of v_1 and v_2 are non-adjacent.

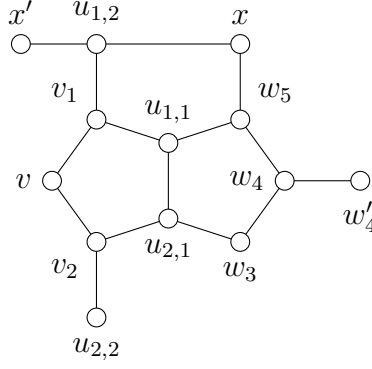

Figure 34: The e-graph G_1 .

Subproof. Suppose for a contradiction that the neighbors of v_1 and v_2 in C_2 are adjacent, and thus we can (by relabelling the vertices if necessary) assume these neighbors are $u_{1,1}$ and $u_{2,1}$; let $C_2 = u_{1,1}u_{2,1}w_3w_4w_5$. By Lemma 8.3, we have $\deg w_4 = 3$, and thus by symmetry and Corollary 6.7, we can assume $\deg w_3 = 2$ and $\deg w_5 = 3$.

We claim that $u_{1,2}$ and w_5 do not have a common neighbor x of degree 2; indeed, if they did, let x' be the neighbor of $u_{1,2}$ distinct from v_1 and x , let w'_4 be the neighbor of w_4 not in C_2 , let $S_1 = \{x', w'_4, u_{2,2}\}$, and let G_1 be the sub-e-graph of G consisting of $G[V(C_1) \cup V(C_2)]$, the path $u_{1,2}xw_5$, and the edges $x'u_{1,2}$, w'_4w_4 , and $u_{2,2}v_2$, see Figure 34. The configuration G_1 attaching at S_1 is excluded by reducibility.

Let us now apply Lemma 8.2 again, with w_3 playing the role of v , giving a 5-cycle $K \subset G - \{u_{2,1}, w_3, w_4\}$ containing a vertex of degree two and a neighbor of $u_{2,1}$ and of w_4 . If $u_{1,1} \in V(K)$, then $v_2 \notin V(K)$ since $u_{2,1}$ has only one neighbor in K , and thus K contains the path $u_{1,2}v_1u_{1,1}w_5$; however, then w_5 and $u_{1,2}$ would have a common neighbor of degree two, which is a contradiction.

Therefore $u_{1,1} \notin V(K)$, $v_2 \in V(K)$, and $K = u_{1,2}v_1v_2u_{2,2}$. The vertex w_4 has a neighbor in K . If $w_4u_{2,2} \in E(G)$, then Corollary 6.8 implies that either $u_{1,2}w_5$ have a common neighbor of degree two (which we already excluded), or $u_{1,2}w_5 \in E(G)$, which contradicts Lemma 7.3. It follows that $w_4u_{1,2} \in E(G)$.

Lemma 7.3 then implies $w_5u_{2,2} \notin E(G)$, as otherwise the vertex w_3 of degree two would have a neighbor in the 4-cycle $w_4w_5u_{2,2}u_{1,2}$. By Corollary 6.8, it follows that w_5 and $u_{2,2}$ have a common neighbor of degree two. However, the corresponding graph G is 11/4-colorable, which is a contradiction. ■

Since the neighbors of v_1 and v_2 in C_2 are non-adjacent, we cannot have $u_{1,1} \in V(C_2)$; otherwise, as $\deg_{G-\{v_1, v_2\}} u_{1,1} = 2$, we would also have $u_{2,1} \in V(C_2)$. Symmetrically, $u_{2,1} \notin V(C_2)$. Therefore, $u_{1,2}, u_{2,2} \in V(C_2)$. Let $C_2 = u_{1,2}w_1u_{2,2}w_2w_3$. By Lemma 8.4, we have $\deg w_1 = 3$, and thus by symmetry and Corollary 6.7, we can assume $\deg w_2 = 2$ and $\deg w_3 = 3$.

We claim that $u_{1,1}$ and w_1 do not have a common neighbor y of degree 2: Otherwise

Corollary 6.8 and Lemma 6.6 would imply $u_{2,1}w_3 \in E(G)$; however, the corresponding graph G is 11/4-colorable.

Let us now again apply Lemma 8.2, with w_2 playing the role of v , giving a 5-cycle $K' \subset G - \{u_{2,2}, w_2, w_3\}$ containing a vertex of degree two and a neighbor of $u_{2,2}$ and of w_3 . If $w_1 \in V(K')$, then $v_2 \notin V(K')$, and thus K' contains the path $w_1u_{1,2}v_1u_{1,1}$; however, then w_1 and $u_{1,1}$ would have a common neighbor of degree two, which is a contradiction.

Therefore, $w_1 \notin V(K')$ and $v_2 \in V(K')$, which implies $K' = C_1$. The vertex w_3 has a neighbor in K' , and w_3 is not adjacent to $u_{1,1}$ by Lemma 7.3; hence, $w_3u_{2,1} \in E(G)$. However, then Corollary 6.8 and Lemma 7.3 imply w_1 and $u_{1,1}$ have a common neighbor of degree two, which is a contradiction. \square

Consequently, we can strengthen Corollary 6.8.

Corollary 8.6. *Every minimum counterexample is 3-edge-connected.*

9 4-cycles

We now show that a minimum counterexample cannot contain a cycle of length four.

Lemma 9.1. *Every minimum counterexample has girth at least five.*

Proof. Suppose for a contradiction $C = v_1v_2v_3v_4$ is a 4-cycle in a minimum counterexample G . Note that C is an induced cycle, since G is triangle-free. For $i \in \{1, \dots, 4\}$, let u_i be the neighbor of v_i outside of C . Note that the vertices u_1, \dots, u_4 are pairwise distinct: otherwise, since G is triangle-free, we could assume $u_1 = u_3$; but then v_2 and v_4 would have the same neighborhood, contradicting the criticality of G . By Lemma 7.3, the vertices u_1, \dots, u_4 have degree three.

Let G' be the e-graph obtained from $G - V(C)$ by setting $d_{G'}(u_i) = 2$ for $i \in \{1, \dots, 4\}$. Suppose that G' has an 11/4-coloring φ' . For $i \in \{1, \dots, 4\}$, let L_i be a subset of $[0, 11) \setminus \varphi'(u_i)$ of measure 6. Since the fractional choosability is equal to the fractional chromatic number [2] and C has (fractional) chromatic number 2, there exist sets $A_i \subset L_i$ for $i \in \{1, \dots, 4\}$ such that $|A_i| = 3$ and $(A_1 \cup A_3) \cap (A_2 \cup A_4) = \emptyset$. For $i \in \{1, \dots, 4\}$, let M_i be a subset of $[0, 11) \setminus (A_{i-1} \cup A_i \cup A_{i+1})$ of measure 2, where $A_0 = A_4$ and $A_5 = A_1$. Using the fractional choosability of C again, for $i \in \{1, \dots, 4\}$, there exist sets $B_i \subset M_i$ of measure 1 such that $(B_1 \cup B_3) \cap (B_2 \cup B_4) = \emptyset$. Let $\varphi(x) = \varphi'(x)$ for any vertex x at distance at least two from C , and for $i \in \{1, \dots, 4\}$, let $\varphi(v_i) = A_i \cup B_i$ and let $\varphi(u_i)$ be a subset of $\varphi'(u_i) \setminus B_i$ of measure 4. Then φ is an 11/4-coloring of G , which is a contradiction.

Hence, G' does not have an 11/4-coloring and contains a critical induced sub-e-graph F , belonging to \mathcal{C}_0 by the minimality of G . By a computer-assisted enumeration, we verified that for every graph in \mathcal{C}_0 with no nailed vertices and with exactly four vertices of degree two, attaching a 4-cycle adjacent to these vertices results in an e-graph that either belongs to \mathcal{C}_0 or is not critical. Since G arises from G' in this way, we have $G' \notin \mathcal{C}_0$, and thus $F \neq G'$.

By Corollary 8.6, the graph G' is connected, and thus F contains at least one nailed vertex by Observation 2.6. If F contains exactly one nailed vertex, then (b0) implies F contains at

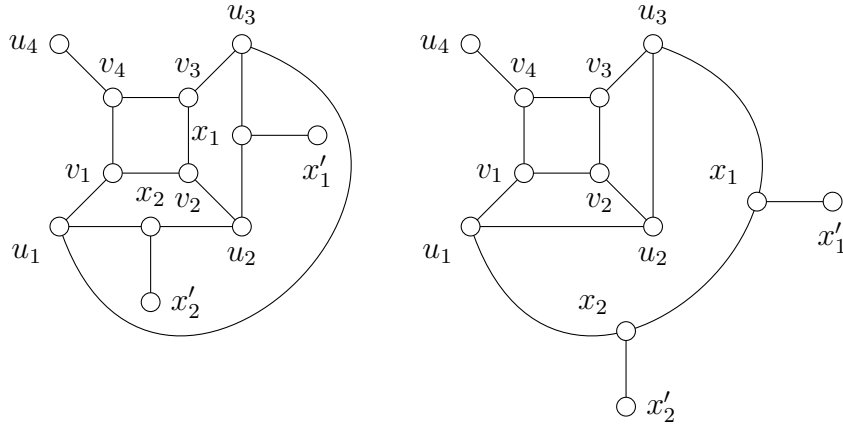

Figure 35: Some of the possibilities for the e-graph G_1 .

least three non-nailed vertices of degree two, and thus $|V(F) \cap \{u_1, \dots, u_4\}| \geq 3$. However, then G contains at most two edges with exactly one end in $V(F) \cup V(C)$, contradicting Corollary 8.6.

Therefore, F contains at least two nailed vertices, and by (a0) and Lemma 5.3, F is a 5-cycle with exactly two nailed vertices. Consequently, we can by symmetry assume $u_1, u_2, u_3 \in V(F)$ and $u_4 \notin V(F)$. Let x_1 and x_2 be the nailed vertices of F and let x'_1 and x'_2 be their neighbors not in F . Let $S = \{x'_1, x'_2, u_4\}$ and let G_1 be the sub-e-graph of G consisting of $G[V(C) \cup V(F)]$ together with the edges $x_1x'_1$, $x_2x'_2$, and v_4u_4 , see Figure 35. The configuration G_1 attaching at S is excluded by reducibility. \square

10 3-regular graphs

We now come to the core of the argument, very similar to the one used in [4]. For each vertex v of a minimum counterexample, we delete v and the neighbors of v and find an 11/4-coloring of the resulting e-graph. We then convexly combine these colorings to obtain an 11/4-coloring of the whole graph, which gives a contradiction. Of course, an issue is that we need to argue that no critical subgraph is created in this way, which is generally straightforward with the exception of 5-cycles with two nailed vertices. To deal with these 5-cycles, we exploit the fact that we can afford to keep a few of the vertices at distance two from v nailed. The following definition is used to determine which vertices to nail.

Let G be a minimum counterexample. The *difficult 5-cycle graph* of G is defined as the directed graph \vec{Z} with the vertex set $V(G)$, where $(v, u) \in \vec{Z}$ if and only if G contains a 5-cycle $K = uu_1u_2u_3u_4$, $v \notin V(K)$, and G contains three paths P_1 , P_2 , and P_3 from v to K of length two, disjoint except for v and intersecting K only in their last vertices, such that the last vertices of P_1 , P_2 , and P_3 are either $\{u, u_1, u_4\}$ or $\{u, u_2, u_3\}$, see Figure 36. Let $W(v, K)$ denote the set of last vertices of P_1 , P_2 , and P_3 (this set is uniquely defined without the need to specify P_1 , P_2 , and P_3 , since G has girth at least five, and thus each neighbor of

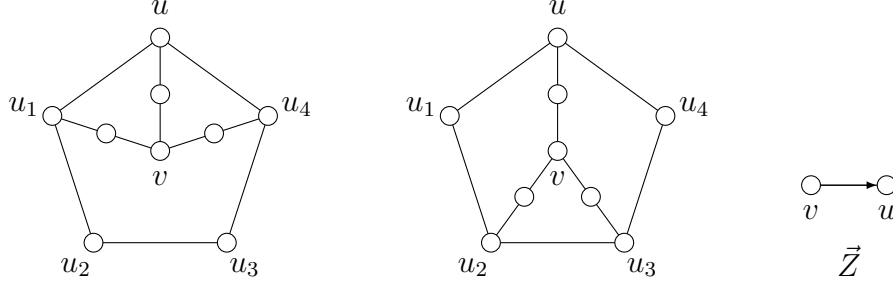

Figure 36: The edges of the difficult 5-cycle graph.

v can have only one neighbor in K), and let $u(v, K)$ denote the vertex u (again, u is uniquely determined by v and K).

The motivation for the definition of the difficult 5-cycle graph comes from the following Lemma.

Lemma 10.1. *Let v be a vertex of a minimum counterexample G and let D be the set of outneighbors of v in the difficult 5-cycle graph \vec{Z} of G . Let $v_1, v_2,$ and v_3 be the neighbors of v in G , and let N be the set of their neighbors distinct from v . Let G_v be the e-graph obtained from $G - \{v, v_1, v_2, v_3\}$ by setting $d_{G_v}(x) = 2$ for $x \in N \setminus D$ and $d_{G_v}(x) = 3$ for $x \in D$. Then G_v is 11/4-colorable.*

Proof. Suppose for a contradiction that G_v does not have an 11/4-coloring, and thus it contains a critical induced sub-e-graph F , belonging to \mathcal{C}_0 by the minimality of G . Note that $|N| = 6$ by Lemma 9.1. By a computer-assisted enumeration, we verified that for every graph in \mathcal{C}_0 with exactly six vertices of degree two, adding a copy of $K_{1,3}$ and connecting them to form a 3-regular graph of girth six results either in an e-graph from \mathcal{C}_0 or in a non-critical e-graph. Therefore, $F \neq G_v$.

If G_v is disconnected and F is a connected component of G_v , then by Corollary 8.6, we have $|V(F) \cap N| \geq 3$ and $|(V(G_v) \setminus V(F)) \cap N| \geq 3$. Since $|N| = 6$, we have $|V(F) \cap N| = 3$, and thus F has exactly three vertices of degree two. However, this contradicts (c0). Therefore, F is not a connected component of G_v , and thus by Observation 2.6, F contains a nailed vertex not belonging to D .

Suppose first that F contains at least two nailed vertices; by (a0) and Lemma 5.3, F is a 5-cycle with exactly two nailed vertices. The three non-nailed vertices of F necessarily belong to $N \setminus D$. Since G has girth at least five, each of the vertices $v_1, v_2,$ and v_3 has at most one neighbor in F , and thus $|V(F) \cap N| \leq 3$. It follows that $|V(F) \cap N| = 3$. However, this implies that $(v, u) \in E(\vec{Z})$ for some $u \in V(F) \cap N$, and thus $V(F) \cap D \neq \emptyset$ and $|V(F) \cap (N \setminus D)| < 3$, which is a contradiction.

Therefore, F has exactly one nailed vertex x , and this vertex does not belong to D ; let x' be the neighbor of x not in F . If both v_1 and v_2 had two neighbors in F , then at most two edges of G have exactly one end in either $V(F) \cup \{v_1, v_2, v\}$ (if v_3 has no neighbor in F) or $V(F) \cup \{v_1, v_2, v_3, v\}$ (if v_3 has a neighbor in F), contradicting Corollary 8.6. By symmetry,

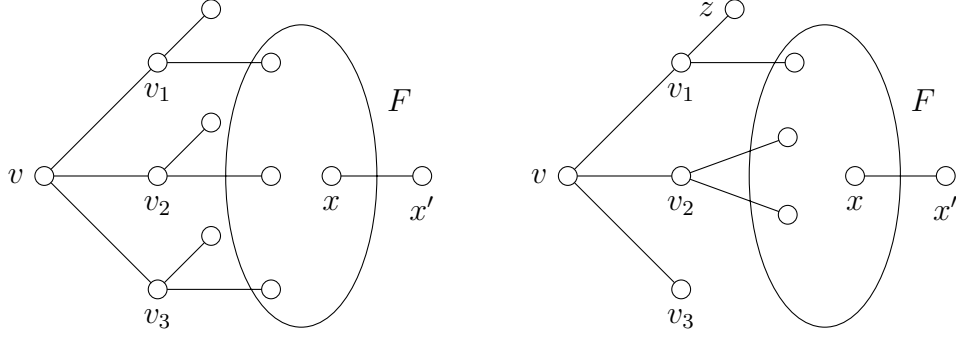

Figure 37: The e-graph G_1 .

we conclude that at most one of the vertices v_1 , v_2 , and v_3 has two neighbors in F , and in particular $|V(F) \cap N| \leq 4$.

On the other hand, F contains at least three non-nailed vertices of degree two by (b0), and thus $|V(F) \cap N| \geq 3$. If each of the vertices v_1 , v_2 , and v_3 has at least one neighbor in F , then let $S = (N \setminus V(F)) \cup \{x'\}$ and let G_1 be the sub-e-graph of G consisting of $G[V(F) \cup \{v_1, v_2, v_3, v\}]$ and the edges from S to $V(F) \cup \{v_1, v_2, v_3, v\}$. If one of them (say v_3) does not have any neighbor in F , then let z be the unique neighbor of v_1 or v_2 distinct from v and not belonging to F , let $S = \{v_3, z, x'\}$ and let G_1 be the sub-e-graph of G consisting of $G[V(F) \cup \{v_1, v_2, v\}]$ and the edges from S to $V(F) \cup \{v_1, v_2, v\}$, see Figure 37. The configuration G_1 attaching at S is excluded by reducibility. \square

Next, we constrain the difficult 5-cycle graph, ensuring that not too many vertices get nailed in the reductions according to the previous Lemma.

Lemma 10.2. *Let G be a minimum counterexample and let \vec{Z} be its difficult 5-cycle graph. Then \vec{Z} has maximum indegree at most one.*

Proof. Suppose for a contradiction that $(v, u), (v', u) \in E(\vec{Z})$ for two distinct vertices $v, v' \in V(G)$. Let v_1, v_2 , and v_3 be the neighbors of v , where $uv_2 \in E(G)$. Let $K = uv_1v_2v_3u_4$ be a 5-cycle such that $u(v, K) = u$, and for $i \in \{1, 2, 3\}$, let z_i be the neighbor of v_i distinct from v and not belonging to K . Let K' be a 5-cycle such that $u(v', K') = u$. Let G_0 be the sub-e-graph of G consisting of K, K' , and all paths of length two from v to K and from v' to K' . If G_0 is an induced sub-e-graph, then let S_1 be the set of vertices in $V(G) \setminus V(G_0)$ with a neighbor in G_0 and let G_1 be the sub-e-graph of G consisting of G_0 and the edges between S_1 and G_0 .

Suppose first that $K[W(v, K)]$ is connected, and thus we can assume $v_1u_1, v_3u_4 \in E(G)$, see Figure 38. The vertex $v' \neq v$ is at distance two from u , and thus by symmetry we can assume $v' \in \{v_3, u_3, z_2\}$. Let us discuss the three cases separately.

- Suppose $v' = v_3$. Then u_4 and v are vertices with neighbors in K' and K' contains the path u_1vv_2 . Then $u, v_2 \in W(v', K')$ and $u(v', K') = u$, and thus $u_1 \in W(v', K')$. But $z_3u_1 \notin E(G)$ since G has girth at least five, which is a contradiction.

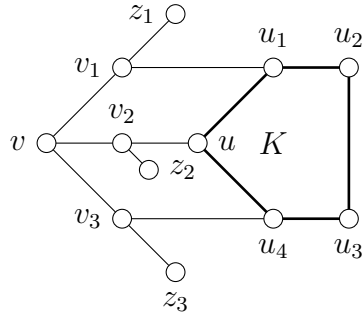

Figure 38: The case $K[W(v, K)]$ is connected.

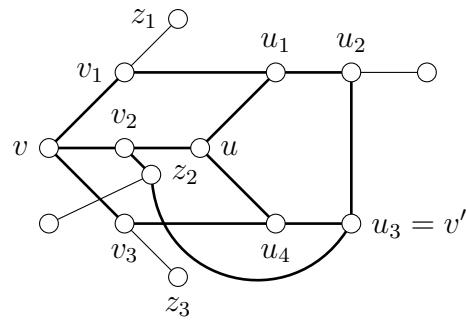

Figure 39: The e-graph G_1 in the case $K[W(v, K)]$ is connected and $v' = u_3$. Thick lines show the e-graph G_0 .

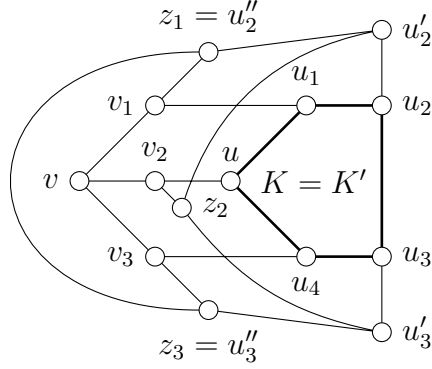

Figure 40: The critical e-graph arising in the case $K[W(v, K)]$ is connected and $v' = z_2$.

- Suppose $v' = u_3$. Then u_2 and u_4 have neighbors in K' , and thus $K' = uv_2vv_1u_1$. Since $u, u_1 \in W(v', K')$ and $u(v', K') = u$, we have $v_2 \in W(v', K')$, and thus $u_3z_2 \in E(G)$. Note that since G has girth at least five, G_0 is an induced sub-e-graph of G . The e-graph G_1 in this situation is depicted in Figure 39. But the configuration G_1 attaching at S_1 is excluded by reducibility.
- Suppose $v' = z_2$. By Lemma 9.1, z_2v_2u is the only path of length two from z_2 to u , and thus $u_1uu_4 \subset K'$. Using the fact that G has girth at least five, observe that K is the only 5-cycle containing this path; hence, we have $K = K'$. Moreover, $z_2v_1, z_2v_3 \notin E(G)$, and thus $W(v', K) = \{u, u_2, u_3\}$. For $i \in \{2, 3\}$, let u'_i be the common neighbor of z_2 and u_i .

Since G has girth at least five, $z_3 \neq u'_3$ and $z_1 \neq u'_2$. If $z_3 = u'_2$, then Corollary 8.6 implies $z_1 = u'_3$; however, the resulting e-graph is 11/4-colorable. Hence $z_3 \neq u'_2$ and symmetrically $z_1 \neq u'_3$. Consequently, G_0 is an induced sub-e-graph of G . For $i \in \{2, 3\}$, let u''_i be the neighbor of u'_i distinct from u_i and z_2 . If $u''_2 = z_1$ and $u''_3 = z_3$, then $z_1z_3 \in E(G)$ by Corollary 8.6 and the resulting e-graph depicted in Figure 40 belongs to \mathcal{C}_0 . Hence, we can by symmetry assume $u''_2 \neq z_1$.

Let H_2 be the e-graph with the vertex set $S_1 \cup \{a, b\}$, the edges z_1a, ab , and bu''_2 , and $d_{H_2}(a) = d_{H_2}(b) = 3$, see Figure 41. The standard argument for the configuration G_1 attaching at S_1 and the replacement graph H_2 enforcing $|\varphi(z_1) \cap \varphi(u''_2)| \leq 3$ gives an e-graph G' and its proper induced sub-e-graph $F_2 \in \mathcal{C}_0$; note that $F_2 \neq G'$ by (a0), since G' has at least three nailed vertices.

Note that G' is connected by Corollary 8.6, and that $a, b \in V(F_2)$ since F_2 is not an induced sub-e-graph of the critical e-graph G . By Observation 2.6, F_2 contains a nailed vertex distinct from the nailed vertices a and b , contradicting (a0).

Therefore, $K[W(v, K)]$ is not connected, and symmetrically, $K'[W(v', K')]$ is not connected. By symmetry, we can assume $v_1u_2, v_3u_3 \in E(G)$. For $i \in \{1, 4\}$, let u'_i and u''_i be

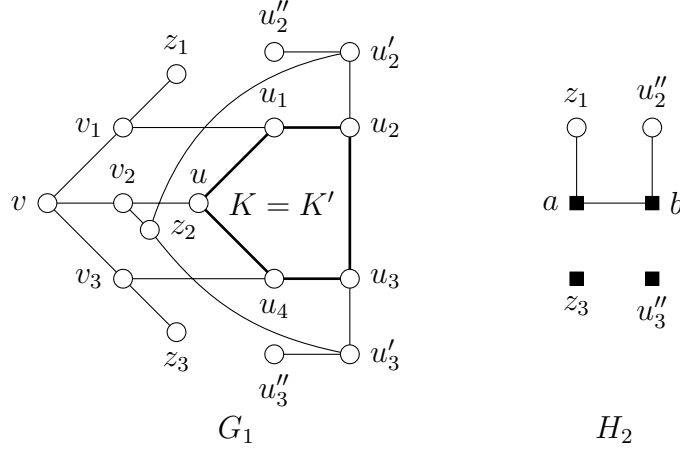

Figure 41: The e-graph G_1 in the case $K[W(v, K)]$ is connected and $v' = z_2$, and the replacement e-graph H_2 .

the neighbors of u_1 and u_4 distinct from u , u_2 , and u_3 , see Figure 42. The vertex $v' \neq v$ is at distance two from u , and thus by symmetry we can assume $v' \in \{u_3, z_2, u'_4\}$. Let us discuss the three cases separately.

- Suppose $v' = u_3$. Then $u, u_1 \in W(v', K')$, and since $u = u(v', K')$ and u_3 and u_1 have a common neighbor, it follows that $K'[W(v', K')]$ is connected, which is a contradiction.
- Suppose $v' = z_2$. Then $u_1 u u_4 \subset K'$. Since G has girth at least five, observe that z_2 is not at distance two from u_2 or u_3 , and since $K'[W(v', K')]$ is not connected, we have $K' \neq K$. Consequently, $u'_1 u'_4 \in E(G)$, $K' = u'_1 u_1 u u_4 u'_4$, and $W(v', K') = \{u'_1, u, u'_4\}$. Hence, for $i \in \{1, 4\}$, z_2 and u'_i has a common neighbor w_i .

By Corollary 8.6, $\{v_1, v_3, w_1, w_4\}$ is either an independent set in G or contains two edges with pairwise distinct endpoints. In the latter case, one of the graphs arising in this way is 11/4-colorable and the other one (depicted in Figure 43) belongs to \mathcal{C}_0 . Therefore, we can assume G_0 is an induced sub-e-graph of G . The e-graph G_1 in this case is depicted in Figure 44. However, the configuration G_1 attaching at S_1 is excluded by reducibility.

- Suppose $v' = u'_4$. Then $u_1 u v_2 \subset K'$. The vertices v_2 and u_2 do not have a common neighbor, and the vertices u_1 and v do not have a common neighbor, and thus $z_2 u'_1 \in E(G)$ and $K' = z_2 u'_1 u_1 u v_2$. Since $K'[W(v', K')]$ is not connected, u'_4 has a common neighbor y_1 with u'_1 and a common neighbor y_2 with z_2 .

By Corollary 8.6, $\{v_1, v_3, y_1, y_2\}$ is either an independent set in G or contains two edges with pairwise distinct endpoints. In the latter case, one of the graphs arising in this way is 11/4-colorable and the other one (depicted in Figure 45) belongs to \mathcal{C}_0 . Therefore, we can assume G_0 is an induced sub-e-graph of G . The e-graph G_1 in this case is

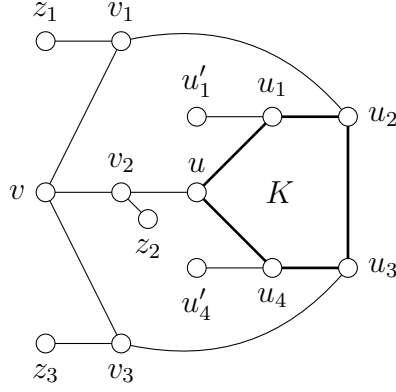

Figure 42: The case $K[W(v, K)]$ is not connected.

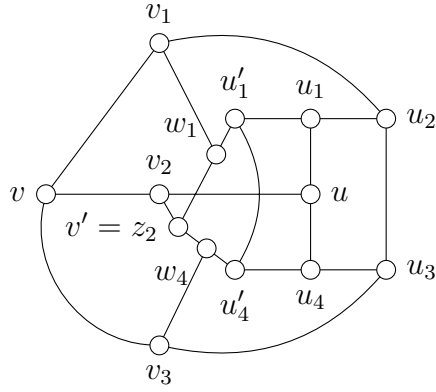

Figure 43: The critical e-graph arising in the case $K[W(v, K)]$ is not connected and $v' = z_2$. It is isomorphic to $F_{14}^{(2)}$.

depicted in Figure 46. However, the configuration G_1 attaching at S_1 is excluded by reducibility.

□

We are now ready to prove our main result.

Proof of Lemma 2.4. Suppose for a contradiction that there exists an e-graph $G \in \mathcal{C}$ not belonging to \mathcal{C}_0 ; we can assume G is a minimum counterexample. Consequently, G is 3-regular by Lemma 8.5 and has girth at least five by Lemma 9.1. Let \vec{Z} be the difficult 5-cycle graph of G ; by Lemma 10.2, \vec{Z} has maximum indegree at most one.

For each vertex $v \in V(G)$, let the e-graph G_v be defined as in the statement of Lemma 10.1 and let φ_v be an 11/4-coloring of G_v . Let $v_1, v_2,$ and v_3 be the neighbors of v in G , and let us extend φ_v to a set 11-coloring of G as follows. For $i \in \{1, 2, 3\}$, denoting by $u_{i,1}$ and $u_{i,2}$

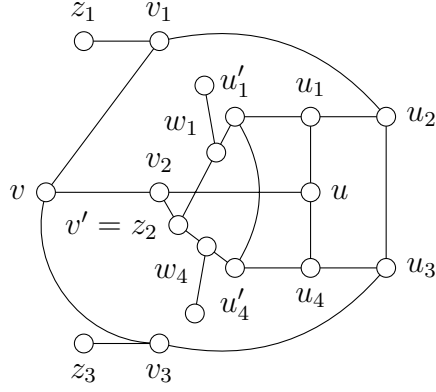

Figure 44: The e-graph G_1 in the case $K[W(v, K)]$ is not connected and $v' = z_2$.

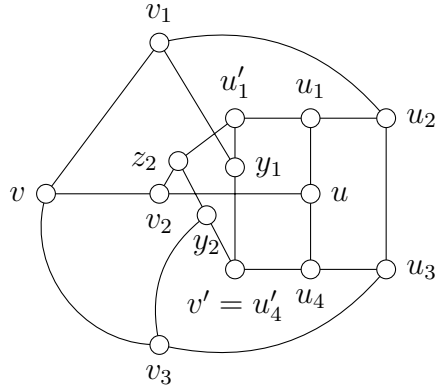

Figure 45: The critical e-graph arising in the case $K[W(v, K)]$ is not connected and $v' = u_4$. It is isomorphic to $F_{14}^{(1)}$.

the neighbors of v_i distinct from v , choose $\varphi_v(v_i)$ as a subset of $[0, 11) \setminus (\varphi_v(u_{i,1}) \cup \varphi_v(u_{i,2}))$ of measure 1. Then, select $\varphi_v(v)$ as a subset of $[0, 11) \setminus (\varphi_v(v_1) \cup \varphi_v(v_2) \cup \varphi_v(v_3))$ of measure 8.

Let $n = |V(G)|$ and let $\varphi = \sum_{v \in V(G)} \frac{1}{n} \varphi_v$. Consider a vertex $v \in V(G)$ whose indegree in \vec{Z} is $d \leq 1$. We have $|\varphi_v(v)| = 8$ and for each neighbor x of v , we have $|\varphi_x(v)| = 1$. For each vertex u at distance two from v , we have $|\varphi_u(v)| = 4$ if $(u, v) \in E(\vec{Z})$ and $|\varphi_u(v)| = 5$ if $(u, v) \notin E(\vec{Z})$. Finally, for each vertex y at distance greater than two from v , we have $|\varphi_y(v)| = 4$. Since G has girth five, exactly 6 vertices of G are at distance exactly two from

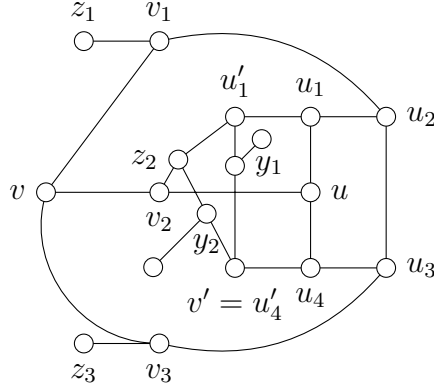

Figure 46: The e-graph G_1 in the case $K[W(v, K)]$ is not connected and $v' = u'_4$.

v . By Observation 2.7, we have

$$|\varphi(v)| = \frac{(n-10) \times 4 + 8 + 3 \times 1 + (6-d) \times 5 + d \times 4}{n}$$

$$= 4 + \frac{4 - 3 \times 3 + (6-d)}{n} \geq 4.$$

Consequently, an $11/4$ -coloring φ' of G can be obtained from φ by choosing $\varphi'(v) \subseteq \varphi(v)$ of measure 4 for every $v \in V(G)$. This is a contradiction. \square

References

- [1] AJTAI, M., KOMLÓS, J., AND SZEMERÉDI, E. A note on Ramsey numbers. *Journal of Combinatorial Theory, Series A* 29, 3 (1980), 354–360.
- [2] ALON, N., TUZA, Z., AND VOIGT, M. Choosability and fractional chromatic numbers. *Discrete Mathematics* 165–166 (1997), 31 – 38. Graphs and Combinatorics.
- [3] BAJNOK, B., AND BRINKMANN, G. On the independence number of triangle free graphs with maximum degree three. *Journal of Combinatorial Mathematics and Combinatorial Computing* 26 (1998), 237–254.
- [4] DVOŘÁK, Z., SERENI, J.-S., AND VOLEC, J. Subcubic triangle-free graphs have fractional chromatic number at most $14/5$. *Journal of the London Mathematical Society* 89 (2014), 641–662.
- [5] FAJTLOWICZ, S. On the size of independent sets in graphs. *Congr. Numer* 21 (1978), 269–274.
- [6] FRAUGHNAUGH, K., AND LOCKE, S. C. $11/30$ (finding large independent sets in connected triangle-free 3-regular graphs). *J. Comb. Theory, Ser. B* 65 (1995), 51–72.

- [7] HECKMAN, C., AND THOMAS, R. A new proof of the independence ratio of triangle-free cubic graphs. *Discrete Math.* 233 (2001), 233–237.
- [8] HECKMAN, C., AND THOMAS, R. Independent sets in triangle-free cubic planar graphs. *J. Combin. Theory Ser. B* 96 (2006), 253–275.
- [9] HILTON, A., RADO, R., AND SCOTT, S. A (< 5)-colour theorem for planar graphs. *Bull. London Math. Soc.* 5 (1973), 302–306.
- [10] JOHANSSON, A. Asymptotic choice number for triangle free graphs. *DIMACS Technical Report 91-4*, 1196 (1996).
- [11] KIM, J. H. The Ramsey number $R(3, t)$ has order of magnitude $t^2/\log t$. *Random Structures & Algorithms* 7, 3 (1995), 173–207.
- [12] SCHEINERMAN, E. R., AND ULLMAN, D. H. *Fractional graph theory*. Dover Publications Inc., Mineola, NY, 2011.
- [13] STATON, W. Some Ramsey-type numbers and the independence ratio. *Trans. Amer. Math. Soc.* 256 (1979), 353–370.
- [14] VAN BATENBURG, W. C., GOEDGEBEUR, J., AND JORET, G. Large independent sets in triangle-free cubic graphs: beyond planarity. *Advances in Combinatorics* (2020), 13667.

Appendix

Here we list all elements of the set \mathcal{C} . The format is as follows. The description of a graph is a sequence of parts of form “ $a : xyz$,” meaning that the edges ax , ay , and az should be added to the graph. The final part of the sequence is of form “ $x1y1$ ”, meaning that $d_G(x) = \deg x + 1$ and $d_G(y) = \deg y + 1$; all other vertices are non-nailed.

```

5 vertices 0 nails a:bd;b:c;c:e;d:e;
5 vertices 1 nails a:bd;b:c;c:e;d:e;d1
10 vertices 0 nails a:ei;b:cg;c:d;d:j;e:gh;f:ghi;h:j;
10 vertices 1 nails a:de;b:fj;c:dh;e:i;f:hi;g:hij;e1
15 vertices 0 nails a:en;b:go;c:di;d:m;e:ik;f:ikn;g:jl;h:jlo;j:m;k:l;
18 vertices 0 nails a:bg;b:h;c:di;d:j;e:fk;f:l;g:im;h:in;j:oq;k:pr;l:qr;m:pq;n:op;o:r;
18 vertices 0 nails a:fr;b:ch;c:k;d:ei;e:j;f:hl;g:hmr;i:np;j:op;k:no;l:nq;m:oq;p;q;
10 vertices 1 nails a:be;b:f;c:gj;d:ei;f:gh;g:i;h:ij;e1
15 vertices 0 nails a:en;b:go;c:im;d:kl;e:ik;f:ikn;g:jl;h:jlo;j:m;
10 vertices 1 nails a:bf;b:c;c:j;d:eh;e:i;f:hi;g:hij;e1
15 vertices 0 nails a:fn;b:ch;c:d;d:o;e:jk;f:jl;g:jln;h:km;i:kmo;l:m;
18 vertices 0 nails a:bg;b:h;c:ei;d:fj;e:f;g:ko;h:mo;i:lp;j:np;k:nq;l:mr;m:n;o:r;p;q;q:r;
18 vertices 0 nails a:fr;b:dh;c:ei;d:e;f:jn;g:knr;h:lo;i:mo;j:lp;k:mp;l:q;m:q;n:q;o:p;
12 vertices 0 nails a:gk;b:ci;c:e;d:fl;e:f;g:ij;h:ijk;j:l;
12 vertices 0 nails a:bi;b:l;c:dk;d:l;e:gj;f:hk;g:h;i:jk;j:l;
12 vertices 0 nails a:cg;b:ei;c:d;d:l;e:f;f:k;g:ij;h:ijl;j:k;
15 vertices 0 nails a:bh;b:i;c:dj;d:m;e:gk;f:gl;h:kn;i:ln;j:lo;k:o;m:no;
15 vertices 0 nails a:bg;b:i;c:jo;d:fk;e:fl;g:hm;h:no;i:km;j:kn;l:mn;
15 vertices 0 nails a:bg;b:i;c:jo;d:fk;e:fl;g:hm;h:no;i:km;j:ln;k:n;l:m;

```

15 vertices 0 nails a:ch;b:di;c:k;d:l;e:fj;f:n;g:mn;h:jo;i:mo;j:k;k:m;l:no;
 15 vertices 0 nails a:bh;b:i;c:dj;d:k;e:fl;f:n;g:mn;h:jo;i:mo;j:l;k:lm;n:o;
 15 vertices 0 nails a:dh;b:ci;c:j;d:l;e:fk;f:n;g:mn;h:io;i:k;j:km;l:no;m:o;
 15 vertices 0 nails a:bh;b:i;c:ej;d:fk;e:f;g:lm;h:jn;i:ln;j:o;k:mo;l:o;m:n;
 15 vertices 0 nails a:bh;b:i;c:ej;d:fk;e:f;g:lm;h:jn;i:ln;j:o;k:lo;m:no;
 15 vertices 0 nails a:bh;b:i;c:ej;d:fk;e:f;g:lm;h:lo;i:mo;j:mn;k:no;l:n;
 DANGEROUS! 5 vertices 2 nails a:bc;b:e;c:d;d:e;cid1
 DANGEROUS! 5 vertices 2 nails a:ce;b:cd;d:e;cid1
 7 vertices 1 nails a:bf;b:d;c:eg;d:e;f:g;f1
 7 vertices 0 nails a:bf;b:d;c:eg;d:e;f:g;
 9 vertices 0 nails a:bh;b:d;c:ei;d:f;e:g;f:g;h:i;
 8 vertices 0 nails a:bh;b:ce;c:fg;d:egh;e:f;f:h;
 8 vertices 0 nails a:ch;b:eg;c:ef;d:efh;f:g;
 8 vertices 1 nails a:dh;b:cf;c:g;d:fg;e:fg;h:c1
 13 vertices 0 nails a:dl;b:fm;c:hk;d:hi;e:hil;f:jk;g:jkm;i:j;
 13 vertices 1 nails a:dl;b:fm;c:hk;d:hi;e:hil;f:jk;g:jkm;i:j;c1
 18 vertices 0 nails a:dq;b:fr;c:ho;d:km;e:kmq;f:ln;g:lnr;h:jp;i:jop;j:k;l:p;m:n;
 18 vertices 0 nails a:er;b:cg;c:h;d:ij;e:im;f:jmr;g:kn;h:ln;i:o;j:p;k:ok;l:pq;m:n;o:p;
 18 vertices 0 nails a:be;b:g;c:hr;d:ij;e:im;f:jnr;g:km;h:ln;i:o;j:p;k:pq;l:ok;m:n;o:p;
 18 vertices 0 nails a:be;b:g;c:hr;d:ij;e:im;f:jnr;g:km;h:ln;i:o;j:p;k:ok;l:pq;m:n;o:p;
 13 vertices 1 nails a:em;b:dg;c:hi;d:j;e:il;f:ilm;g:hk;h:j;j:k;k:l;d1
 18 vertices 0 nails a:dq;b:fr;c:hj;d:jn;e:jnq;f:ko;g:kor;h:il;i:mp;k:p;l:mo;m:n;
 21 vertices 0 nails a:eu;b:cg;c:h;d:ij;e:io;f:iou;g:kp;h:lp;j:mn;k:mr;l:ms;n:qs;o:q;p:t;q:r;r:t;s;t;
 21 vertices 0 nails a:eu;b:cg;c:h;d:ij;e:io;f:iou;g:kp;h:lp;j:mn;k:ms;l:st;m:q;n:rt;o:r;p:q;q:t;r:s;
 21 vertices 0 nails a:eu;b:cg;c:h;d:ij;e:io;f:iou;g:kp;h:lp;j:mn;k:mt;l:st;m:q;n:rt;o:r;p:q;q:s;r:s;
 15 vertices 0 nails a:ho;b:dg;c:ej;d:m;e:m;f:kl;g:jn;h:ln;i:lno;j:k;k:m;
 15 vertices 0 nails a:go;b:ci;c:l;d:ek;e:l;f:jk;g:jn;h:jno;i:km;l:m;m:n;
 18 vertices 0 nails a:bf;b:h;c:dg;d:i;e:jr;f:lq;g:mq;h:ok;i:mo;j:np;k:npr;l:mn;o:p;
 18 vertices 0 nails a:be;b:g;c:hq;d:ir;e:fk;f:lq;g:km;h:lm;i:mo;j:nor;k:p;l:p;m:n;o:p;
 18 vertices 0 nails a:be;b:g;c:hq;d:ir;e:fm;f:nq;g:km;h:ln;i:op;j:opr;k:no;l:mp;
 18 vertices 0 nails a:gr;b:cf;c:i;d:km;e:jl;f:jq;g:mo;h:mor;i:nq;j:p;k:lp;l:q;n:op;
 18 vertices 0 nails a:fr;b:ch;c:i;d:jl;e:km;f:lo;g:lor;h:kq;i:nq;j:kp;m:pq;n:op;
 18 vertices 0 nails a:bf;b:g;c:hr;d:jl;e:km;f:jn;g:ln;h:mo;i:mor;j:p;k:lp;n:q;o:q;p:q;
 18 vertices 0 nails a:bf;b:g;c:hr;d:jk;e:lm;f:jq;g:kq;h:lo;i:lor;j:n;k:p;m:pq;n:op;
 18 vertices 0 nails a:bf;b:g;c:hr;d:kl;e:jm;f:jq;g:kq;h:lo;i:lor;j:n;k:p;m:pq;n:op;
 18 vertices 0 nails a:bf;b:g;c:hr;d:jl;e:km;f:jq;g:kq;h:lo;i:lor;j:p;k:p;m:nq;n:op;
 DANGEROUS! 8 vertices 2 nails a:cg;b:eh;c:ef;d:efg;f:h;bh1
 DANGEROUS! 8 vertices 2 nails a:bd;b:f;c:gh;d:eg;e:fh;f:g;bh1
 16 vertices 1 nails a:be;b:f;c:dg;d:h;e:jm;f:km;g:il;h:in;i:o;j:ln;k:no;l:p;m:p;o:p;d1
 24 vertices 0 nails a:de;b:cf;c:g;d:h;e:im;f:jn;g:kn;h:lm;i:ot;j:ps;k:qs;l:rt;m:u;n:v;o:su;p:vw;q:vx;r:ux;t:w;w;x;
 24 vertices 0 nails a:dx;b:cf;c:g;d:hl;e:ilx;f:jw;g:kw;h:mq;i:nq;j:or;k:pr;l:s;m:su;n:sv;o:tu;p:tv;q:r;t:w;u:v;
 16 vertices 1 nails a:be;b:f;c:dg;d:h;e:jm;f:km;g:il;h:in;i:o;j:ln;k:lo;m:p;n:p;o:p;d1
 24 vertices 0 nails a:bd;b:f;c:gx;d:hl;e:imx;f:jl;g:km;h:nr;i:os;j:pr;k:qs;l:t;m:u;n:ot;o:u;p:tw;q:uv;r:v;s:w;v:w;
 24 vertices 0 nails a:bd;b:f;c:gx;d:hl;e:imx;f:jl;g:km;h:nr;i:os;j:pr;k:qs;l:t;m:u;n:ot;o:u;p:tv;q:uv;r:w;s:w;v:w;
 16 vertices 1 nails a:be;b:f;c:dg;d:h;e:jm;f:km;g:il;h:in;i:o;j:lo;k:no;l:p;m:p;n:p;d1
 10 vertices 1 nails a:cg;b:dh;c:j;d:j;e:fi;f:g;g:h;h:i;i:j;f1
 18 vertices 0 nails a:bh;b:i;c:eg;d:ff;e:k;f:k;g:lm;h:np;i:op;j:no;k:l;l:q;m:nr;o:q;p:r;q:r;
 18 vertices 0 nails a:bh;b:j;c:eg;d:fi;e:k;f:k;g:lm;h:nq;i:op;j:pq;k:l;l:r;m:np;n:r;o:qr;
 18 vertices 0 nails a:bh;b:j;c:eg;d:fi;e:k;f:k;g:lo;h:np;i:mq;j:pq;k:l;l:r;m:op;n:or;q:r;
 FULL! 14 vertices 0 nails a:dfn;b:ehn;c:gin;d:gj;e:fk;f:l;g:m;h:im;i:l;j:kl;k:m;
 FULL! 14 vertices 0 nails a:cgm;b:efm;c:ei;d:fjn;e:l;f:k;g:jk;h:iln;i:j;k:l;m:n;
 10 vertices 1 nails a:bg;b:i;c:dh;d:i;e:fh;f:j;g:hj;i:j;f1
 18 vertices 0 nails a:bi;b:j;c:eg;d:fh;e:k;f:k;g:hl;h:m;i:np;j:op;k:q;l:or;m:no;n:q;p:r;q:r;
 18 vertices 0 nails a:hr;b:df;c:eg;d:j;e:j;f:gk;g:l;h:mo;i:nor;j:p;k:mq;l:nq;m:p;n:p;o:q;
 16 vertices 0 nails a:bd;b:f;c:gp;d:hl;e:imp;f:jl;g:km;h:kn;i:jo;j:k;l:o:m:n;n:o;
 18 vertices 0 nails a:fr;b:dh;c:ei;d:k;e:j;f:hl;g:imr;h:n;i:o;j:lo;k:mn;l:p;m:q;n:p;o:q;p:q;
 18 vertices 0 nails a:bg;b:i;c:ej;d:fh;e:k;f:l;g:hm;h:q;i:jp;j:o;k:no;l:pq;m:or;n:pr;q:r;
 18 vertices 0 nails a:cg;b:dh;c:i;d:j;e:fk;f:l;g:hp;h:q;i:mp;j:nr;k:or;l:qr;m:og;n:op;
 18 vertices 0 nails a:bf;b:h;c:ir;d:ej;e:k;f:lp;g:mqr;h:np;i:og;j:op;k:nq;l:mo;m:n;
 21 vertices 0 nails a:bf;b:i;c:dg;d:h;e:jk;f:jr;g:lq;h:mq;i:nr;j:o;k:pr;l:ns;m:nt;o:ps;p:t;q:u;s;u;t;u;
 21 vertices 0 nails a:eu;b:cg;c:h;d:ij;e:io;f:jou;g:kp;h:lp;i:m;j:n;k:qr;l:qs;m:nr;n:s;o:q;p:t;r:t;s;t;
 21 vertices 0 nails a:bf;b:g;c:dh;d:i;e:jk;f:jp;g:kp;h:lq;i:mq;j:n;k:o;l:nu;m:tu;n:r;o:su;p:s;q:r;r:t;s;t;
 21 vertices 0 nails a:bf;b:i;c:dg;d:h;e:jk;f:jr;g:lq;h:nq;i:mr;j:o;k:pr;l:ou;m:pt;n:tu;o:s;p:u;q:s;s;t;
 21 vertices 0 nails a:bf;b:i;c:dg;d:h;e:jk;f:jr;g:lq;h:nq;i:mr;j:o;k:pr;l:pu;m:ot;n:tu;o:u;p:s;q:s;s;t;
 21 vertices 0 nails a:bf;b:g;c:dh;d:i;e:jk;f:jp;g:kp;h:lq;i:mq;j:n;k:o;l:rt;m:st;n:os;o:t;p:r;q:u;r;u;s;u;

21 vertices 0 nails a:bf;b:i;c:dg;d:h;e:jk;f:jr;g:lq;h:nq;i:mr;j:o;k:pr;l:mu;m:s;n:tu;o:pt;p:u;q:s;s:t;
 21 vertices 0 nails a:bf;b:i;c:dg;d:h;e:jk;f:jr;g:lq;h:nq;i:mr;j:o;k:pr;l:mu;m:s;n:tu;o:pu;p:t;q:s;s:t;
 21 vertices 0 nails a:bf;b:i;c:dg;d:h;e:jk;f:jr;g:lq;h:nq;i:mr;j:o;k:pr;l:ps;m:pt;n:ot;o:s;q:u;s:u;t:u;
 21 vertices 0 nails a:bf;b:i;c:dg;d:h;e:jk;f:jr;g:lq;h:nq;i:mr;j:o;k:pr;l:os;m:ot;n:pt;p:s;q:u;s:u;t:u;
 21 vertices 0 nails a:bf;b:g;c:dh;d:i;e:jk;f:jp;g:kp;h:lq;i:mq;j:n;k:o;l:ns;m:nt;o:rt;p:r;q:u;r:s;s:u;t:u;
 16 vertices 0 nails a:dp;b:cf;c:g;d:hl;e:ilp;f:jo;g:ko;h:jn;i:kn;j:m;k:m;l:m;n:o;
 18 vertices 0 nails a:fr;b:dh;c:ei;d;j;e:k;f:hl;g:imr;h:p;i;q;j:np;k:oq;l:nq;m:op;n:o;
 18 vertices 0 nails a:cg;b:dh;c:k;d:l;e:fi;f:j;g:hn;h:o;i:mq;j:nq;k:pq;l:op;m:pr;n:r;o:r;
 21 vertices 0 nails a:bf;b:g;c:dh;d:i;e:jk;f:jp;g:kp;h:lq;i:mq;j:n;k:o;l:nt;m:tu;n:r;o:su;p:s;q:r;r:u;s:t;
 21 vertices 0 nails a:bf;b:i;c:dg;d:h;e:jk;f:jr;g:lq;h:nq;i:mr;j:o;k:pr;l:ou;m:pu;n:tu;o:s;p:t;q:s;s:t;
 21 vertices 0 nails a:bf;b:i;c:dg;d:h;e:jk;f:jr;g:lq;h:nq;i:mr;j:o;k:pr;l:pu;m:ou;n:tu;o:t;p:s;q:s;s:t;
 13 vertices 1 nails a:bf;b:h;c:dg;d:i;e:jk;f:jm;g:kl;h:km;i:lm;j:l;e1
 18 vertices 0 nails a:bh;b:i;c:dg;d:j;e:kn;f:lm;g:mq;h:kr;i:lr;j:qr;k:p;l:o;m:p;n:og;o:p;
 18 vertices 0 nails a:bh;b:i;c:dg;d:j;e:kn;f:lm;g:kq;h:lr;i:mr;j:qr;k:p;l:o;m:p;n:og;o:p;
 18 vertices 0 nails a:bh;b:i;c:dg;d:j;e:kn;f:lm;g:lq;h:kr;i:mr;j:qr;k:p;l:o;m:p;n:og;o:p;
 13 vertices 1 nails a:be;b:g;c:hm;d:ij;e:fk;f:lm;g:ik;h:il;j:kl;d1
 18 vertices 0 nails a:bf;b:h;c:ir;d:jk;e:lm;f:gp;g:qr;h:jp;i:kq;j:n;k:o;l:op;m:nq;n:o;
 18 vertices 0 nails a:bf;b:h;c:ir;d:jl;e:km;f:gp;g:qr;h:jp;i:kq;j:n;k:o;l:op;m:nq;n:o;
 18 vertices 0 nails a:bf;b:h;c:ir;d:jk;e:lm;f:gp;g:qr;h:jp;i:kq;j:n;k:o;l:np;m:og;n:o;
 18 vertices 0 nails a:bf;b:h;c:ir;d:jm;e:kl;f:gp;g:qr;h:jp;i:kq;j:n;k:o;l:np;m:og;n:o;
 18 vertices 0 nails a:bf;b:h;c:ir;d:jl;e:km;f:gp;g:qr;h:jp;i:kq;j:n;k:n;l:op;m:og;n:o;
 18 vertices 0 nails a:bf;b:h;c:ir;d:jm;e:kl;f:gp;g:qr;h:jp;i:kq;j:n;k:n;l:op;m:og;n:o;
 13 vertices 1 nails a:be;b:g;c:hm;d:ij;e:fk;f:lm;g:ik;h:jl;i:l;j:k;d1
 13 vertices 1 nails a:bf;b:g;c:eh;d:ij;e:k;f:im;g:km;h:jl;i:l;j:m;k:l;e1
 13 vertices 1 nails a:bf;b:g;c:eh;d:ij;e:k;f:im;g:km;h:il;j:lm;k:l;e1
 13 vertices 1 nails a:bf;b:g;c:eh;d:ij;e:k;f:il;g:jl;h:jm;i:m;k:lm;e1
 13 vertices 1 nails a:bf;b:g;c:eh;d:ij;e:k;f:im;g:jm;h:lm;i:k;j:l;k:l;e1
 13 vertices 1 nails a:bf;b:g;c:eh;d:ij;e:k;f:hm;g:im;h:l;i:k;j:lm;k:l;e1
 13 vertices 1 nails a:bf;b:g;c:eh;d:ij;e:k;f:hm;g:im;h:l;i:l;j:km;k:l;e1
 10 vertices 0 nails a:bf;b:h;c:ij;d:eh;e:i;f:gi;g:hj;
 10 vertices 1 nails a:bg;b:i;c:dh;d:j;e:fj;f:g;g:h;h:i;i;j;f1
 15 vertices 0 nails a:bg;b:h;c:io;d:ek;e:m;f:lm;g:km;h:kn;i:ln;j:lno;
 12 vertices 0 nails a:eh;b:il;c:fi;d:gj;e:k;f:k;g:k;h:ij;j:l;
 12 vertices 0 nails a:bh;b:j;c:kl;d:fj;e:kg;f:g;h:ik;i:jl;
 12 vertices 0 nails a:bh;b:j;c:jl;d:fh;e:gi;f:k;g:k;h:i;l;j:k;
 15 vertices 0 nails a:bh;b:i;c:dj;d:m;e:fl;f:m;g:kl;h:ko;i:lo;j:no;k:n;m:n;
 15 vertices 0 nails a:bi;b:j;c:dh;d:m;e:fl;f:m;g:kl;h:in;i:o;j:lo;k:no;m:n;
 15 vertices 0 nails a:bh;b:j;c:di;d:m;e:fl;f:m;g:kl;h:io;i:n;j:ko;k:n;l:o;m:n;
 15 vertices 0 nails a:bh;b:k;c:ei;d:fj;e:n;f:n;g:lm;h:mo;i:jl;j:m;k:no;l:o;
 15 vertices 0 nails a:go;b:di;c:ej;d:m;e:m;f:kl;g:kn;h:lno;i:jk;j:l;m:n;
 15 vertices 0 nails a:bi;b:j;c:eh;d:fk;e:n;f:n;g:lm;h:ko;i:lo;j:mo;k:m;l:n;
 15 vertices 0 nails a:bh;b:i;c:ej;d:fk;e:n;f:n;g:lm;h:jo;i:lo;j:k;k:m;l:n;m:o;
 15 vertices 0 nails a:bh;b:i;c:ej;d:fk;e:n;f:n;g:lm;h:jo;i:lo;j:k;k:l;m:no;
 9 vertices 0 nails a:fi;b:eh;c:fh;d:gh;e:fg;g:i;
 10 vertices 0 nails a:fj;b:df;c:eg;d:i;e:i;f:h;g:hj;h:i;
 10 vertices 1 nails a:bg;b:i;c:dh;d:i;e:fh;f:g;g;j;h:j;i;j;f1
 15 vertices 0 nails a:go;b:ci;c:l;d:ek;e:l;f:jk;g:jn;h:jno;i:mn;k:m;l:m;
 12 vertices 0 nails a:bh;b:j;c:jl;d:fh;e:gi;f:g;h:k;i:kl;j:k;
 15 vertices 0 nails a:bi;b:j;c:dh;d:m;e:fl;f:m;g:kl;h:kn;i:ko;j:lo;m:n;n:o;
 15 vertices 0 nails a:bi;b:j;c:dh;d:m;e:fl;f:m;g:kl;h:kn;i:lo;j:no;k:o;m:n;
 15 vertices 0 nails a:bh;b:j;c:di;d:m;e:fl;f:m;g:kl;h:kn;i:ko;j:no;l:n;m:o;
 13 vertices 0 nails a:bf;b:h;c:dg;d:i;e:jk;f:jm;g:kl;h:km;i:lm;j:l;
 13 vertices 1 nails a:bf;b:g;c:eh;d:ij;e:k;f:im;g:lm;h:jl;i:k;j:m;k:l;e1
 18 vertices 0 nails a:gr;b:cf;c:i;d:km;e:jl;f:jq;g:mo;h:mor;i:pq;j:n;k:lp;l:q;n:op;
 13 vertices 1 nails a:bf;b:g;c:eh;d:ij;e:k;f:im;g:lm;h:il;j:km;k:l;e1
 18 vertices 0 nails a:fr;b:ch;c:i;d:jl;e:km;f:lo;g:lor;h:kq;i:pq;j:kp;m:nq;n:op;
 15 vertices 0 nails a:bi;b:j;c:eh;d:fk;e:n;f:n;g:lm;h:mo;i:kl;j:km;l:o;n:o;
 15 vertices 0 nails a:bh;b:k;c:ei;d:fj;e:f;g:lm;h:mn;i:lo;j:mo;k:no;l:n;
 18 vertices 0 nails a:cg;b:dh;c:i;d;j;e:lm;f:kn;g:lp;h:kr;i:mp;j:mr;k:o;l:q;n:qr;o:pq;
 18 vertices 0 nails a:cg;b:dh;c:i;d;j;e:km;f:ln;g:kp;h:lr;i:mp;j:mr;k:q;l:q;n:or;o:pq;
 18 vertices 0 nails a:bg;b:h;c:di;d;j;e:km;f:ln;g:lp;h:np;i:kr;j:mr;k:o;l:q:m;q:n:r;o:pq;
 18 vertices 0 nails a:bg;b:i;c:dh;d:j;e:km;f:ln;g:kr;h:lq;i:lr;j:og;k:p;m:or;n:pq;o:p;
 18 vertices 0 nails a:bg;b:i;c:dh;d:j;e:km;f:ln;g:kr;h:lq;i:lr;j:og;k:o;m:pr;n:pq;o:p;
 18 vertices 0 nails a:bg;b:h;c:di;d;j;e:mn;f:kl;g:kr;h:lr;i:mq;j:og;k:o;l:p;m:r;n:pq;o:p;
 18 vertices 0 nails a:bh;b:i;c:dg;d:j;e:kn;f:lm;g:kq;h:lr;i:mr;j:og;k:p;l:o;m:p;n:qr;o:p;

18 vertices 0 nails a:bg;b:i;c:dh;d:j;e:ln;f:km;g:lp;h:kr;i:np;j:qr;k:o;l:q;m:nr;o:pq;
 18 vertices 0 nails a:bg;b:h;c:di;d:j;e:kl;f:mn;g:kp;h:lp;i:mr;j:qr;k:q;l:m;n:or;o:pq;
 18 vertices 0 nails a:bf;b:h;c:ir;d:jl;e:km;f:jp;g:kqr;h:lp;i:mq;j:n;k:o;l:m;n:or;o:p;
 18 vertices 0 nails a:bh;b:i;c:dg;d:j;e:kn;f:lm;g:lq;h:kr;i:mr;j:oq;k:p;l:p;m:q;n:or;o:p;
 18 vertices 0 nails a:bg;b:h;c:di;d:j;e:kl;f:mn;g:kp;h:lp;i:mr;j:or;k:q;l:m;n:qr;o:pq;
 18 vertices 0 nails a:bf;b:h;c:ir;d:jl;e:km;f:jp;g:kqr;h:np;i:nq;j:k;l:op;m:or;n:o;
 18 vertices 0 nails a:cg;b:dh;c:i;d:j;e:kl;f:mn;g:kq;h:mr;i:oq;j:or;k:p;l:mq;n:pr;o:p;
 18 vertices 0 nails a:bf;b:h;c:ir;d:jl;e:km;f:jp;g:kqr;h:np;i:nq;j:o;k:o;l:mp;m:q;n:o;
 18 vertices 0 nails a:bg;b:i;c:dh;d:j;e:kn;f:lm;g:kp;h:lr;i:np;j:or;k:q;l:q;m:nr;o:pq;
 13 vertices 0 nails a:be;b:g;c:hm;d:ij;e:fk;f:lm;g:ik;h:il;j:kl;
 15 vertices 0 nails a:bg;b:k;c:lo;d:ek;e:l;f:ij;g:im;h:ino;j:mn;k:m;l:n;
 18 vertices 0 nails a:cg;b:dh;c:j;d:i;e:kl;f:mn;g:kq;h:mr;i:or;j:pq;k:o;l:mq;n:pr;o:p;
 18 vertices 0 nails a:bf;b:h;c:ir;d:jl;e:km;f:jp;g:kqr;h:np;i:oq;j:k;l:op;m:nq;n:o;
 13 vertices 0 nails a:be;b:g;c:hm;d:ij;e:fk;f:lm;g:ik;h:jl;i:l;j:k;
 15 vertices 0 nails a:bg;b:k;c:lo;d:ek;e:l;f:ij;g:im;h:jno;i:n;j:m;k:m;l:n;
 18 vertices 0 nails a:bf;b:h;c:ir;d:jl;e:km;f:jp;g:kqr;h:np;i:oq;j:o;k:n;l:mp;m:q;n:o;
 11 vertices 0 nails a:bj;b:ck;c:df;d:hj;e:ijk;f:gi;g:hk;h:i;
 13 vertices 0 nails a:be;b:g;c:hm;d:il;e:ij;f:ikm;g:jl;h:kl;j:k;
 13 vertices 1 nails a:be;b:g;c:hm;d:il;e:ij;f:ikm;g:jl;h:kl;j:k;d1
 18 vertices 0 nails a:be;b:g;c:hr;d:ip;e:ln;f:lor;g:mn;h:mo;i:kq;j:kpq;k:l;m:q;n:o;
 13 vertices 1 nails a:bf;b:g;c:eh;d:ij;e:k;f:im;g:jm;h:jl;i:k;k:l;l:m;e1
 18 vertices 0 nails a:bf;b:g;c:hr;d:jl;e:km;f:jp;g:lp;h:mq;i:mqr;j:n;k:lo;n:or;o:p;
 15 vertices 0 nails a:bf;b:h;c:io;d:ej;e:n;f:jl;g:jmo;h:kl;i:km;k:n;l:m;
 15 vertices 0 nails a:go;b:di;c:ej;d:e;f:kl;g:km;h:lmo;i:kn;j:ln;m:n;
 15 vertices 0 nails a:fo;b:ch;c:i;d:jn;e:lm;f:jl;g:jmo;h:kl;i:km;k:n;
 18 vertices 0 nails a:bf;b:h;c:ir;d:jl;e:km;f:jn;g:kor;h:ln;i:mo;j:p;k:p;l:m;n:q;o:q;p;q;