

LATTICE PATHS AND NEGATIVELY INDEXED WEIGHT-DEPENDENT BINOMIAL COEFFICIENTS

JOSEF KÜSTNER*, MICHAEL J. SCHLOSSER*, AND MEESUE YOO**

ABSTRACT. In 1992, Loeb [6] considered a natural extension of the binomial coefficients to negative entries and gave a combinatorial interpretation in terms of hybrid sets. He showed that many of the fundamental properties of binomial coefficients continue to hold in this extended setting. Recently, Formichella and Straub [2] showed that these results can be extended to the q -binomial coefficients with arbitrary integer values and extended the work of Loeb further by examining arithmetic properties of the q -binomial coefficients. In this paper, we give an alternative combinatorial interpretation in terms of lattice paths and consider an extension of the more general weight-dependent binomial coefficients, first defined by the second author [14], to arbitrary integer values. Remarkably, many of the results of Loeb, Formichella and Straub continue to hold in the general weighted setting. We also examine important special cases of the weight-dependent binomial coefficients, including ordinary, q - and elliptic binomial coefficients as well as elementary and complete homogeneous symmetric functions.

1. INTRODUCTION

Loeb [6] studied a generalization of the binomial coefficients $\binom{n}{k} = \frac{n!}{k!(n-k)!}$, where n and k are allowed to be negative integers. He defined them for integers n and k in terms of

$$\binom{n}{k} := \lim_{\epsilon \rightarrow 0} \frac{\Gamma(n+1+\epsilon)}{\Gamma(k+1+\epsilon)\Gamma(n-k+1+\epsilon)}.$$

From this definition it follows that the binomial coefficients with integer values satisfy the recursion

$$\binom{n}{0} = \binom{n}{n} = 1 \quad \text{for } n \in \mathbb{Z}, \quad (1.1a)$$

and for $n, k \in \mathbb{Z}$, provided that $(n+1, k) \neq (0, 0)$,

$$\binom{n+1}{k} = \binom{n}{k} + \binom{n}{k-1}, \quad (1.1b)$$

2010 *Mathematics Subject Classification.* Primary 05E16; Secondary 05E05, 11B65, 11B73, 33E05.

Key words and phrases. Binomial coefficients, commutation relations, symmetric functions, Stirling numbers, q -commuting variables, elliptic-commuting variables, elliptic binomial coefficient, elliptic hypergeometric series.

* Partially supported by FWF Austrian Science Fund grant P32305.

** Partially supported by the National Research Foundation of Korea (NRF) grant funded by the Korea government No. 2020R1F1A1A01064138.

and they can be fully characterized by this recursion. The binomial coefficients with integer values appear in the power series expansion of $(x + y)^n$ (n being an arbitrary integer) in two ways. Suppose $f_n(x, y)$ is a function with power series expansions

$$f_n(x, y) = \sum_{k \geq 0} a_k x^k y^{n-k} \quad \text{in } \mathbb{C}[[x, y, y^{-1}]] \quad (1.2a)$$

or

$$f_n(x, y) = \sum_{k \leq n} b_k x^k y^{n-k} \quad \text{in } \mathbb{C}[[x, x^{-1}, y]], \quad (1.2b)$$

then we extract coefficients of the expansions by writing $[x^k y^{n-k}]f_n(x, y) = a_k$ for $k \geq 0$ and $[x^k y^{n-k}]f_n(x, y) = b_k$ for $k < 0$ (see [2]). We have the following extension of the binomial theorem.

Theorem 1.1 ([2, 6]). *For $n, k \in \mathbb{Z}$,*

$$[x^k y^{n-k}](x + y)^n = \binom{n}{k}.$$

This theorem essentially means that we have the two expansions

$$(x + y)^n = \sum_{k \geq 0} \binom{n}{k} x^k y^{n-k}$$

and

$$(x + y)^n = \sum_{k \leq n} \binom{n}{k} x^k y^{n-k}.$$

If $n \geq 0$, the expansions coincide, but if $n < 0$, they are different. For $n < 0$ the first expansion is an expansion in x and y^{-1} , while the second is an expansion in x^{-1} and y .

Recently, Formichella and Straub [2] extended this theorem to a q -binomial expansion. They considered an extension of the q -binomial coefficients to arbitrary integer values which can be characterized by the recursive definition

$$\begin{bmatrix} n \\ 0 \end{bmatrix}_q = \begin{bmatrix} n \\ n \end{bmatrix}_q = 1 \quad \text{for } n \in \mathbb{Z}, \quad (1.3a)$$

and for $n, k \in \mathbb{Z}$, provided that $(n + 1, k) \neq (0, 0)$,

$$\begin{bmatrix} n + 1 \\ k \end{bmatrix}_q = \begin{bmatrix} n \\ k \end{bmatrix}_q + \begin{bmatrix} n \\ k - 1 \end{bmatrix}_q q^{n+1-k}. \quad (1.3b)$$

They proved the following generalization of Theorem 1.1.

Theorem 1.2. *Suppose we have $yx = qxy$ for invertible variables x and y , and an invertible indeterminate q . Then, for $n, k \in \mathbb{Z}$,*

$$[x^k y^{n-k}](x + y)^n = \begin{bmatrix} n \\ k \end{bmatrix}_q. \quad (1.4)$$

In their paper they gave a combinatorial interpretation of the q -binomial coefficients (1.3) in terms of hybrid sets. This interpretation is a q -analogue of a model by Loeb for (ordinary) binomial coefficients.

Theorem 1.2 also extends the noncommutative q -binomial theorem for nonnegative integers n and k : Let $\mathbb{C}_q[x, y]$ be the associative unital algebra over \mathbb{C} generated by noncommutative variables x and y , satisfying the relation

$$yx = qxy, \tag{1.5}$$

for an indeterminate q . Then, the noncommutative q -binomial theorem says that we have, as an identity in $\mathbb{C}_q[x, y]$,

$$(x + y)^n = \sum_{k=0}^n \begin{bmatrix} n \\ k \end{bmatrix}_q x^k y^{n-k}, \tag{1.6}$$

which is the $n, k \geq 0$ case of Theorem 1.2. In [14], the second author generalized the noncommutative q -binomial theorem (1.6) to a weight-dependent binomial theorem for *weight-dependent binomial coefficients* (see Theorem 2.6 below) and gave a combinatorial interpretation of these coefficients in terms of lattice paths. Specializing the general weights of the weight-dependent binomial coefficients, one obtains some interesting special cases, such as elliptic binomial coefficients and symmetric functions as well as the q - and ordinary binomial coefficients. In the conclusion of their paper [2], Formichella and Straub ask whether these elliptic binomial coefficients also permit a natural extension to negative numbers. We will show that such an extension is possible even for the more general weight-dependent binomial coefficients.

In this paper, we extend the weight-dependent binomial coefficients to negative integer values, analogous to the work of Loeb [6] and Formichella and Straub [2]. Remarkably, many of their results continue to hold in the general weighted setting. We study reflection formulae inspired by an involution which recently appeared in [15]. We give a combinatorial interpretation of the weight-dependent binomial coefficients in terms of lattice paths and prove a weight-dependent generalization of Theorem 1.2. As a corollary of the binomial theorem, we obtain convolution formulae analogous to the Chu–Vandermonde convolution formula, which we also are able to interpret combinatorially. Our combinatorial interpretation of the weight-dependent binomial coefficients in terms of lattice paths translates, via a one-to-one correspondence, to a combinatorial interpretation in terms of hybrid sets (as studied by Loeb [6] in the classical case and by Formichella and Straub [2] in the q -case) which we make explicit. Finally, we study some important special cases of the weight-dependent binomial coefficients, such as elementary and complete homogeneous symmetric functions (with application of these cases to Stirling numbers), and elliptic binomial coefficients.

2. WEIGHT-DEPENDENT COMMUTATION RELATIONS

2.1. A noncommutative algebra. Let $(w(s, t))_{s, t \in \mathbb{Z}}$ be a sequence of invertible variables. We start by extending the algebra $\mathbb{C}_q[x, y]$ to the weight-dependent setting with invertible variables x and y .

Definition 2.1. For a doubly-indexed sequence of invertible variables $(w(s, t))_{s, t \in \mathbb{Z}}$, let $\mathbb{C}_w[x, x^{-1}, y, y^{-1}]$ be the associative unital algebra over \mathbb{C} generated by x, x^{-1}, y and y^{-1} and the sequence of invertible variables $(w(s, t)^{\pm 1})_{s, t \in \mathbb{Z}}$ satisfying the following relations:

$$x^{-1}x = xx^{-1} = 1 \quad (2.1a)$$

$$y^{-1}y = yy^{-1} = 1 \quad (2.1b)$$

$$yx = w(1, 1)xy, \quad (2.1c)$$

$$xw(s, t) = w(s + 1, t)x, \quad (2.1d)$$

$$yw(s, t) = w(s, t + 1)y, \quad (2.1e)$$

for all $s, t \in \mathbb{Z}$.

Note that from the above relations also the following relations can be obtained:

$$x^{-1}y = w(0, 1)yx^{-1}, \quad (2.1f)$$

$$xy^{-1} = w(1, 0)y^{-1}x, \quad (2.1g)$$

$$y^{-1}x^{-1} = w(0, 0)x^{-1}y^{-1}, \quad (2.1h)$$

$$x^{-1}w(s, t) = w(s - 1, t)x^{-1}, \quad (2.1i)$$

$$y^{-1}w(s, t) = w(s, t - 1)y^{-1}. \quad (2.1j)$$

In this paper, we will frequently restrict the just defined algebra $\mathbb{C}_w[x, x^{-1}, y, y^{-1}]$ to $\mathbb{C}_w[x, y, y^{-1}]$ (where we allow no negative powers of x and omit the relation (2.1a)) or to $\mathbb{C}_w[x, x^{-1}, y]$ (where we allow no negative powers of y and omit the relation (2.1b)), respectively. In addition we find it convenient to work in the extensions of these algebras to the algebras of formal power series $\mathbb{C}_w[[x, x^{-1}, y, y^{-1}]]$, $\mathbb{C}_w[[x, y, y^{-1}]]$ and $\mathbb{C}_w[[x, x^{-1}, y]]$ (keeping the same relations). Note that expressions of the form $(x + y)^n$ with $n < 0$ do not have a unique power series expansion in $\mathbb{C}_w[[x, x^{-1}, y, y^{-1}]]$. For $n < 0$ we have to decide how to expand $(x + y)^n$, say as $(x + y)^n = ((1 + xy^{-1})y)^n$ as an element in $\mathbb{C}_w[[x, y, y^{-1}]]$, or rather as $(x + y)^n = (x(1 + x^{-1}y))^n$ as an element in $\mathbb{C}_w[[x, x^{-1}, y]]$, respectively. By default, we shall always choose the algebra of formal power series $\mathbb{C}_w[[x, y, y^{-1}]]$ (allowing no negative powers of x) and only resort to $\mathbb{C}_w[[x, x^{-1}, y]]$ (allowing no negative powers of y) if we explicitly mention that.

For $l, m \in \mathbb{Z} \cup \{\pm\infty\}$ we define products of (possibly noncommutative) invertible variables A_j as follows:

$$\prod_{j=l}^m A_j = \begin{cases} A_l A_{l+1} \dots A_m & m > l - 1 \\ 1 & m = l - 1 \\ A_{l-1}^{-1} A_{l-2}^{-1} \dots A_{m+1}^{-1} & m < l - 1 \end{cases}. \quad (2.3)$$

Note that

$$\prod_{j=l}^m A_j = \prod_{j=m+1}^{l-1} A_{m+l-j}^{-1}, \quad (2.4)$$

for all $l, m \in \mathbb{Z} \cup \{\pm\infty\}$.

Especially for the reflection formulae it will be necessary to define $\text{sgn}(n)$ for $n \in \mathbb{Z}$, following [2, 16], as

$$\text{sgn}(n) = \begin{cases} 1 & n \geq 0 \\ -1 & n < 0. \end{cases} \quad (2.5)$$

For $s, t \in \mathbb{Z}$ and the sequence of invertible weights $(w(s, t))_{s, t \in \mathbb{Z}}$ we define

$$W(s, t) := \prod_{j=1}^t w(s, j). \quad (2.6)$$

Note that for $s, t \in \mathbb{Z}$, we have $w(s, t) = W(s, t)/W(s, t-1)$. We refer to the $w(s, t)$ as *small weights*, whereas to the $W(s, t)$ as *big weights*.

Lemma 2.2. *Let $(w(s, t))_{s, t \in \mathbb{Z}}$ be a doubly-indexed sequence of invertible variables, and x and y two additional invertible variables, together forming the associative algebra $A_{x, y} = \mathbb{C}_{w_{x, y}}[x, x^{-1}, y, y^{-1}]$ where $w_{x, y}(s, t) = w(s, t)$. Then the following six homomorphisms are involutive algebra isomorphisms.*

$$\phi_{y, x} : A_{x, y} \rightarrow A_{y, x} \quad \text{with} \quad w_{y, x}(s, t) = w(t, s)^{-1}, \quad (2.7a)$$

$$\phi_{x^{-1}, y} : A_{x, y} \rightarrow A_{x^{-1}, y} \quad \text{with} \quad w_{x^{-1}, y}(s, t) = w(1-s, t)^{-1}, \quad (2.7b)$$

$$\phi_{x^{-1}, x^{-1}y} : A_{x, y} \rightarrow A_{x^{-1}, x^{-1}y} \quad \text{with} \quad w_{x^{-1}, x^{-1}y}(s, t) = w(1-s-t, t)^{-1}, \quad (2.7c)$$

$$\phi_{x, y^{-1}} : A_{x, y} \rightarrow A_{x, y^{-1}} \quad \text{with} \quad w_{x, y^{-1}}(s, t) = w(s, 1-t)^{-1}, \quad (2.7d)$$

$$\phi_{x^{-1}, y^{-1}} : A_{x, y} \rightarrow A_{x^{-1}, y^{-1}} \quad \text{with} \quad w_{x^{-1}, y^{-1}}(s, t) = w(1-s, 1-t), \quad (2.7e)$$

$$\phi_{y^{-1}x, y^{-1}} : A_{x, y} \rightarrow A_{y^{-1}x, y^{-1}} \quad \text{with} \quad w_{y^{-1}x, y^{-1}}(s, t) = w(s, 1-s-t)^{-1}. \quad (2.7f)$$

It is straightforward to check that the simultaneous replacement of $w_{x, y}(s, t)$ ($s, t \in \mathbb{Z}$), x and y in (2.7a)–(2.7f) by $w_{x', y'}(s, t)$, x' and y' , respectively, again satisfies the conditions in (2.1). Note that the involutions (2.7d)–(2.7f) can be realized as compositions of (2.7a)–(2.7c). For example, $\phi_{y^{-1}x, y^{-1}} = \phi_{y, x} \circ \phi_{x^{-1}, x^{-1}y} \circ \phi_{y, x}$. Further note that Lemma 2.2 also holds for the algebras $\mathbb{C}_w[x, x^{-1}, y]$ and $\mathbb{C}_w[x, y, y^{-1}]$ (when the respective homomorphisms can be defined) as well as for their respective formal power series extensions.

Lemma 2.2 is an extension of [15, Lemma 2]. There, the involution $\phi_{x^{-1}, x^{-1}y}$ with corresponding weight function $\tilde{w}(s, t) := w_{x^{-1}, x^{-1}y}(s, t) = w(1-s-t, t)^{-1}$ was used in the algebra $\mathbb{C}_w[x, x^{-1}, y]$ to construct weight-dependent Fibonacci polynomials satisfying a noncommutative weight-dependent Euler–Cassini identity.

It is clear that, given an identity in the variables $w(s, t)$ ($s, t \in \mathbb{Z}$), x and y , subject to the commutation relations (2.1), a new valid identity can be obtained by applying the isomorphism ϕ to each side of the identity where the variables still satisfy the commutation relations (2.1). We will apply such isomorphisms in the proofs of Lemma 2.4 and Theorem 2.15.

Remark 2.3. While the six isomorphisms in Lemma 2.2 are involutions, i.e., are of order 2, it is also possible to specify isomorphisms of order 3. In particular, for the homomorphisms

$$\phi_{y^{-1}, xy^{-1}} : A_{x, y} \rightarrow A_{y^{-1}, xy^{-1}} \quad \text{with} \quad w_{y^{-1}, xy^{-1}}(s, t) = w(t, 2-s-t), \quad (2.8a)$$

$$\phi_{yx^{-1},x^{-1}} : A_{x,y} \rightarrow A_{yx^{-1},x^{-1}} \quad \text{with} \quad w_{yx^{-1},x^{-1}}(s,t) = w(2-s-t,s), \quad (2.8b)$$

$$\phi_{y,x^{-1}y^{-1}} : A_{x,y} \rightarrow A_{y,x^{-1}y^{-1}} \quad \text{with} \quad w_{y,x^{-1}y^{-1}}(s,t) = w(1-t,1+s-t), \quad (2.8c)$$

$$\phi_{x^{-1}y^{-1},x} : A_{x,y} \rightarrow A_{x^{-1}y^{-1},x} \quad \text{with} \quad w_{x^{-1}y^{-1},x}(s,t) = w(t-s,1-s), \quad (2.8d)$$

we have $\phi_{y^{-1},xy^{-1}}^3 = \phi_{yx^{-1},x^{-1}}^3 = \phi_{y,x^{-1}y^{-1}}^3 = \phi_{x^{-1}y^{-1},x}^3 = id_{A_{x,y}}$, moreover, $\phi_{y^{-1},xy^{-1}}^{-1} = \phi_{yx^{-1},x^{-1}}^{-1}$ and $\phi_{y,x^{-1}y^{-1}}^{-1} = \phi_{x^{-1}y^{-1},x}$. We will not make use of these isomorphisms of order 3 in this paper (nor do we provide combinatorial interpretations in terms of lattice paths or hybrid sets here).

The following rule for interchanging powers of x and y is an extension to integer values of a corresponding lemma in [14, Lemma 1]:

Lemma 2.4. *For all $k, \ell \in \mathbb{Z}$ we have*

$$y^k x^\ell = \left(\prod_{i=1}^{\ell} \prod_{j=1}^k w(i,j) \right) x^\ell y^k = \left(\prod_{i=1}^{\ell} W(i,k) \right) x^\ell y^k.$$

Proof. The case $k, \ell \geq 0$ is already given in [14] and is easy to prove by induction; we therefore omit the proof. For $k \geq 0$ and $\ell < 0$ we combine the involution (2.7b) with the $k, \ell \geq 0$ case and use identity (2.4) to obtain:

$$y^k x^\ell = y^k (x^{-1})^{-\ell} = \left(\prod_{i=1}^{-\ell} \prod_{j=1}^k w(1-i,j)^{-1} \right) (x^{-1})^{-\ell} y^k = \left(\prod_{i=1}^{\ell} \prod_{j=1}^k w(i,j) \right) x^\ell y^k.$$

The remaining cases can be proved in the same manner by applying the involutions (2.7d) and (2.7e) to the $k, \ell \geq 0$ case. \square

2.2. Weight-dependent binomial coefficients with integer values. Now we are ready to define weight-dependent binomial coefficients for all integer values. Let the *weight-dependent binomial coefficients* or *w-binomial coefficients* be defined by

$${}_w \begin{bmatrix} n \\ 0 \end{bmatrix} = {}_w \begin{bmatrix} n \\ n \end{bmatrix} = 1 \quad \text{for } n \in \mathbb{Z}, \quad (2.9a)$$

and for $n, k \in \mathbb{Z}$, provided that $(n+1, k) \neq (0, 0)$,

$${}_w \begin{bmatrix} n+1 \\ k \end{bmatrix} = {}_w \begin{bmatrix} n \\ k \end{bmatrix} + {}_w \begin{bmatrix} n \\ k-1 \end{bmatrix} W(k, n+1-k). \quad (2.9b)$$

Example 2.5 ($n = -1$). Using induction separately for $k \geq 0$ and for $k < 0$ we obtain that the weight-dependent binomial coefficient for $n = -1$ evaluates to

$${}_w \begin{bmatrix} -1 \\ k \end{bmatrix} = (-1)^k \operatorname{sgn}(k) \prod_{j=1}^k W(j, -j),$$

where $\operatorname{sgn}(k)$ is defined in (2.5).

For $n, k \geq 0$ in (2.9), the w -binomial coefficients coincide with the weight-dependent binomial coefficients in [14], which have a combinatorial interpretation in terms of *weighted lattice paths* (see also [13] for the elliptic case). Here, for $n, m \geq 0$, a lattice path is a sequence of north and east steps in the first quadrant of the xy -plane, starting at the origin $(0, 0)$ and ending at (n, m) . We give weights to such paths by assigning the big weight $W(s, t)$ to each east step $(s-1, t) \rightarrow (s, t)$ and 1 to each north step. Then define the weight of a path P , $w(P)$, to be the product of the weights of all its steps. An example is given in Figure 2.

Given two points $A, B \in \mathbb{N}_0^2$, let $\mathcal{P}(A \rightarrow B)$ be the set of all lattice paths from A to B , and define

$$w(\mathcal{P}(A \rightarrow B)) := \sum_{P \in \mathcal{P}(A \rightarrow B)} w(P).$$

Then we have

$$w(\mathcal{P}((0, 0) \rightarrow (k, n-k))) = {}_w \begin{bmatrix} n \\ k \end{bmatrix} \quad (2.10)$$

as both sides of the equation satisfy the same recursion and initial conditions.

Interpreting the x -variable as an east step and the y -variable as a north step, we get the following weight-dependent binomial theorem.

Theorem 2.6 ([14]). *Let $n \in \mathbb{N}_0$. Then, as an identity in $\mathbb{C}_w[x, y]$,*

$$(x + y)^n = \sum_{k=0}^n {}_w \begin{bmatrix} n \\ k \end{bmatrix} x^k y^{n-k}. \quad (2.11)$$

Our goal is to extend this weight-dependent binomial theorem to arbitrary integer exponents and therefore generalize Theorems 1.1 and 1.2.

Before stating the general binomial theorem, let us extend the lattice path model of [13] to all $n, k \in \mathbb{Z}$. Let a *weighted hybrid lattice path* be a sequence of steps in the xy -plane starting at the origin $(0, 0)$ and ending at (n, m) with $n, m \in \mathbb{Z}$ using the following steps:

- (1) If $n, m \geq 0$, we use north and east steps (\uparrow, \rightarrow),
- (2) if $n \geq 0$ and $m < 0$, we use south steps and east-south step combinations (\downarrow, \searrow) and every path starts with a south step,
- (3) if $n < 0$ and $m \geq 0$, we use north-west step combinations and west steps (\nwarrow, \leftarrow) and every path starts with a west step,
- (4) if $n, m < 0$, there are no allowed steps.

Figure 1 shows the possible steps of a hybrid lattice path. The arrows indicate the direction of the steps. Note that in the region $m < 0 \leq n$ every east step has to be followed by a south step and in the region $n < 0 \leq m$ every north step has to be followed by a west step (which is not evident in the figure but follows from the step combinations in the definition). The figure also shows that some points are not reachable using these steps. This corresponds to the fact that the w -binomial coefficient with integer values is 0 in some regions which we will specify in Equation (2.13).

We give weights to such paths by assigning the weights

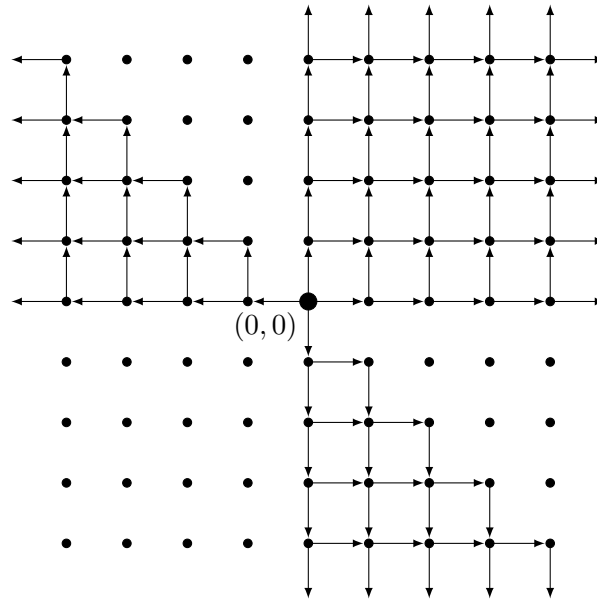
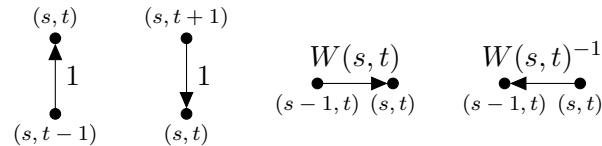

FIGURE 1. The possible steps of a hybrid lattice path.

- 1 to each regular north step and south step,
- (-1) to each north and south step in a north-west or an east-south step combination,
- $W(s, t)$ to each east step $(s-1, t) \rightarrow (s, t)$, and
- $W(s, t)^{-1}$ to each west step $(s, t) \leftarrow (s+1, t)$.

To illustrate it graphically, we assign the weights



and, if we highlight the step combinations by rounded corners,

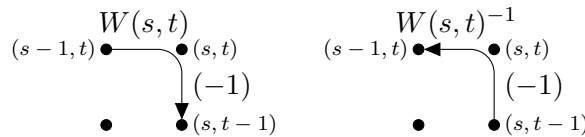

The weight of a path P , $w(P)$, is again defined as the product of the weights of all its steps.

Example 2.7. Figure 2 shows a hybrid lattice path in the area $n, m \geq 0$ with weight $W(1, 0) \cdot 1 \cdot W(2, 1) \cdot 1 \cdot W(3, 2) \cdot W(4, 2) = w(2, 1)w(3, 1)w(3, 2)w(4, 1)w(4, 2)$. Paths in this area correspond to (ordinary) weighted lattice paths. The left side of Figure 3 shows a hybrid lattice path in the area $m < 0 \leq n$ with weight $1 \cdot W(1, -1) \cdot (-1) \cdot 1 \cdot W(2, -3) \cdot (-1) = (-1)^2 w(1, 0)^{-1} w(2, 0)^{-1} w(2, -1)^{-1} w(2, -2)^{-1}$. The right side of Figure 3 shows

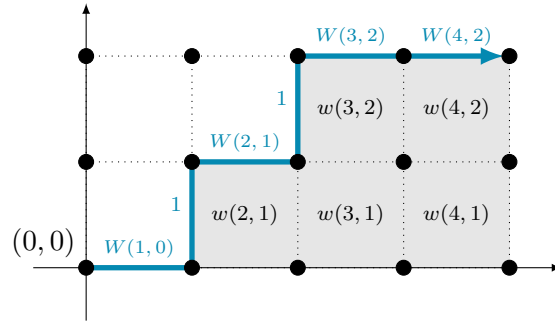
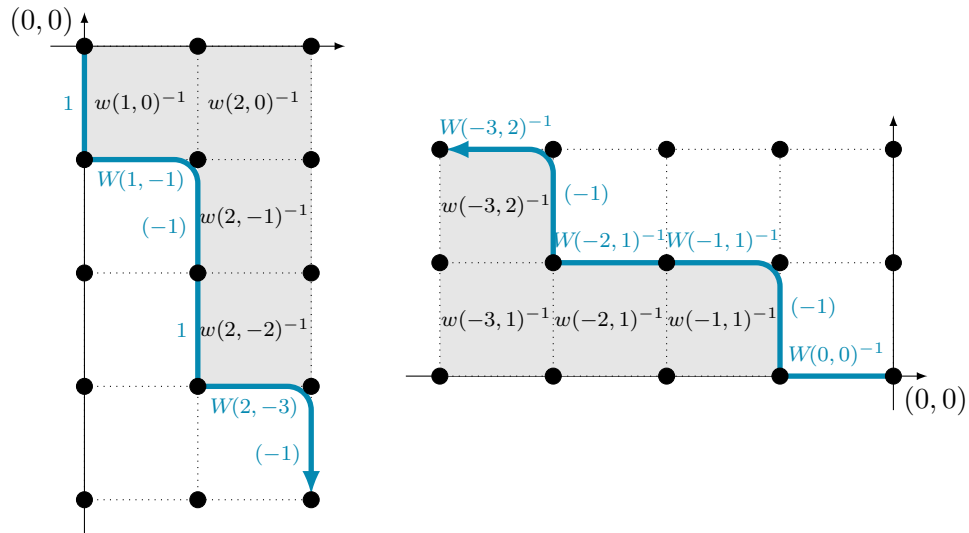
 FIGURE 2. A hybrid lattice path in the area $n, m \geq 0$.

 FIGURE 3. A hybrid lattice path in the area $m < 0 \leq n$ (left) and a path in the area $n < 0 \leq m$ (right). The (diagonal) step combinations are indicated by rounded corners. The negative inner corners (see Remark 2.9) are marked with red diagonal lines.

a hybrid lattice path in the area $n < 0 \leq m$ with weight $W(0,0)^{-1} \cdot (-1) \cdot W(-1,1)^{-1} \cdot W(-2,1)^{-1} \cdot (-1) \cdot W(-3,2)^{-1} = (-1)^2 w(-1,1)^{-1} w(-2,1)^{-1} w(-3,1)^{-1} w(-3,2)^{-1}$.

Given two points $A, B \in \mathbb{Z}^2$, let $\mathcal{P}_{\mathbb{Z}}(A \rightarrow B)$ be the set of all hybrid lattice paths from A to B , and define

$$w(\mathcal{P}_{\mathbb{Z}}(A \rightarrow B)) := \sum_{P \in \mathcal{P}_{\mathbb{Z}}(A \rightarrow B)} w(P).$$

Theorem 2.8. *Let $n, k \in \mathbb{Z}$. Then,*

$$w(\mathcal{P}_{\mathbb{Z}}((0,0) \rightarrow (k, n-k))) = \begin{bmatrix} n \\ k \end{bmatrix}_w. \quad (2.12)$$

Proof. If $0 \leq k \leq n$ we are left with Equation (2.10). Let $0 \leq n < k$, $k < 0 \leq n$ or $n < k < 0$, then there are no possible hybrid lattice paths and indeed, it is not hard to use induction to prove that

$$\begin{bmatrix} n \\ k \end{bmatrix}_w = 0 \quad \text{for } 0 \leq n < k, k < 0 \leq n \text{ or } n < k < 0. \quad (2.13)$$

The remaining cases $n < 0 \leq k$ and $k \leq n < 0$ can be proved using induction.

For $n < 0 \leq k$ we are dealing with the set of lattice paths from $(0,0)$ to $(k, n-k)$ using south steps and east-south step combinations. We begin with the initial conditions

$$\begin{bmatrix} n \\ 0 \end{bmatrix}_w = 1 \quad \text{and} \quad \begin{bmatrix} -1 \\ k \end{bmatrix}_w = (-1)^k \prod_{j=1}^k W(j, -j)$$

for $n < 0$ and $k \geq 0$ and indeed, there is only one path from $(0,0)$ to $(0, n)$ consisting only of south steps with weight 1 and one path from $(0,0)$ to $(k, -1-k)$ consisting only of east-south step combinations with weight $(-1)^k \prod_{j=1}^k W(j, -j)$.

Now assume the result holds when $n+1 \leq -1$ or $k-1 \geq 0$. The last step of the hybrid lattice path ending at $(k, n-k)$ is either a south step starting at $(k, n-k+1)$ or an east-south step combination starting at $(k-1, n-k+1)$. We obtain from (2.9b) that

$$\begin{bmatrix} n \\ k \end{bmatrix}_w = \begin{bmatrix} n+1 \\ k \end{bmatrix}_w - \begin{bmatrix} n \\ k-1 \end{bmatrix}_w W(k, n+1-k). \quad (2.14)$$

By induction, the first term of the right hand side is the weighted counting of hybrid lattice paths ending at $(k, n-k+1)$ combined with a south step with weight 1. The second term is the weighted counting of paths ending at $(k-1, n-k+1)$ combined with an east-south step combination with weight $(-1) \cdot W(k, n-k+1)$. This completes the proof for the case $n < 0 \leq k$.

The case $k \leq n < 0$ can be proved analogously using the following third form of the recurrence relation (2.9b):

$$\begin{bmatrix} n \\ k \end{bmatrix}_w = \begin{bmatrix} n+1 \\ k+1 \end{bmatrix}_w W(k+1, n-k)^{-1} - \begin{bmatrix} n \\ k+1 \end{bmatrix}_w W(k+1, n-k)^{-1}, \quad (2.15)$$

where the first term of the sum corresponds to the weighted counting of hybrid lattice paths ending at $(k+1, n-k)$ combined with a west step with weight $W(k+1, n-k)^{-1}$ and the second term to the weighted counting of paths ending at $(k+1, n-k-1)$ combined with a north-west step combination with weight $(-1) \cdot W(k+1, n-k)^{-1}$. \square

Remark 2.9. As the Figures 2 and 3 show, we can interpret the weight of the path as a weight function corresponding to the area between the path and the x -axis. For $s, t \in \mathbb{Z}$, let the cell (s, t) be the unit square with north-east corner at $x = s$ and $y = t$. For a hybrid lattice path P we define the set $\mathcal{C}(P)$ as the collection of cells (s, t) between the path and the x -axis. Further, we say that (s, t) is an *inner corner* of $\mathcal{C}(P)$, if the path touches the cell from two sides (the path in Figure 2 has the two inner corners

(2, 1) and (3, 2)) and it is a *negative inner corner* if $s \leq 0$ or $t \leq 0$ (in Figure 3 there are the negative inner corners (1, 0) and (2, -2) in the left path and (-1, 1) and (-3, 2) in the right path). For a cell (s, t) we define $N(s, t)$ to be 1 if it is a negative inner corner and 0 otherwise. Then, the definition of the weight of a path is equivalent to

$$w(P) = \prod_{(i,j) \in \mathcal{C}(P)} (-1)^{N(i,j)} w(i, j)^{\text{sgn}((i,j))} \quad (2.16)$$

where $\text{sgn}((i, j)) := \text{sgn}(i - 1)\text{sgn}(j - 1)$. Therefore, $w(\mathcal{P}_{\mathbb{Z}}((0, 0) \rightarrow (k, n - k)))$ can be seen as an area generating function. If a hybrid lattice path ends at $(k, n - k)$, the exponents of the small weights in (2.16) are always 1 if $0 \leq k \leq n$ and -1 otherwise. Moreover, the product over all $(-1)^{N(i,j)}$ is $(-1)^k$ if $n < 0 \leq k$, it is $(-1)^{n-k}$ if $k \leq n < 0$, and 1 otherwise.

Remark 2.10. A recent preprint by O’Sullivan [8, Figure 1] contains a figure similar to our Figure 1, showing the values of the *harmonic multiset numbers* $\| \binom{n}{k} \|$ (that extend the Stirling numbers) for integers n and k .

Example 2.11. By setting $w(s, t) = 1$ for all $s, t \in \mathbb{Z}$, the generating function of hybrid lattice paths is given by the binomial coefficients with integer values defined by (1.1). By setting $w(s, t) = q$ for all $s, t \in \mathbb{Z}$, we obtain a q -weighting of hybrid lattice paths with the generating function given by the q -binomial coefficients with integer values defined by (1.3).

2.3. Reflection formulae. As pointed out in [14], the weight-dependent binomial coefficients do not satisfy the symmetry ${}_w \binom{n}{k} = {}_w \binom{n}{n-k}$. Nevertheless, we can prove the following reflection formula using the weight

$$\widehat{w}(s, t) := w_{y,x}(s, t) = w(t, s)^{-1} \quad (2.17)$$

from the involution (2.7a) and

$$\widehat{W}(s, t) := \prod_{j=1}^t \widehat{w}(s, j). \quad (2.18)$$

Theorem 2.12. *Let $n, k \in \mathbb{Z}$ and $\widehat{w}(s, t) = w(t, s)^{-1}$. Then,*

$${}_w \binom{n}{k} = \widehat{w} \binom{n}{n-k} \prod_{j=1}^k W(j, n-k).$$

Proof. We proceed by showing that both sides of the equation satisfy the same recursion and initial conditions.

For $k = 0$ and $n = k$ we obtain from (2.9a) and the definition for products (2.3) that

$$\begin{aligned} \widehat{w} \binom{n}{n} \prod_{j=1}^0 W(j, n) &= 1 = {}_w \binom{n}{0}, \\ \widehat{w} \binom{n}{0} \prod_{j=1}^n W(j, 0) &= 1 = {}_w \binom{n}{n}. \end{aligned}$$

For $(n+1, k) \neq (0, 0)$, note that

$$\widehat{W}(n+1-k, k) = \prod_{j=1}^k \widehat{w}(n+1-k, j) = \prod_{j=1}^k w(j, n+1-k)^{-1}$$

to deduce the recurrence relation

$$\begin{aligned} A_{n+1, k} &:= \begin{bmatrix} n+1 \\ n+1-k \end{bmatrix}_{\widehat{w}} \prod_{j=1}^k W(j, n+1-k) \\ &= \left(\begin{bmatrix} n \\ n+1-k \end{bmatrix}_{\widehat{w}} + \begin{bmatrix} n \\ n-k \end{bmatrix}_{\widehat{w}} \widehat{W}(n+1-k, k) \right) \prod_{j=1}^k W(j, n+1-k) \\ &= \begin{bmatrix} n \\ n-(k-1) \end{bmatrix}_{\widehat{w}} \left(\prod_{j=1}^{k-1} W(j, n-(k-1)) \right) W(k, n+1-k) + \begin{bmatrix} n \\ n-k \end{bmatrix}_{\widehat{w}} \prod_{j=1}^k W(j, n-k) \\ &= A_{n, k-1} W(k, n+1-k) + A_{n, k}, \end{aligned}$$

which is equal to the recurrence relation (2.9b) for $\begin{bmatrix} n \\ k \end{bmatrix}_w$. \square

Theorem 2.12 also has a combinatorial interpretation in terms of hybrid lattice paths weighted by area (2.16). The w -binomial coefficient on the right side of the equation corresponds to lattice paths from $(0, 0)$ to $(n-k, k)$, where the weights are inverted and reflected by the line $y = x$, see the leftmost path in Figure 4 and 5. If we reflect such a path with its weights by the line $y = x$, we obtain a lattice path to $(k, n-k)$, where the weight of the path corresponds to the unit squares between the path and the y -axis and all weights are still inverted compared to the usual weighting, see the middle path in Figure 4 and 5. By multiplying with the weights $\prod_{j=1}^k W(j, n-k)$, which are the corresponding weights to the rectangle with vertices $(0, 0)$, $(k, 0)$, $(k, n-k)$ and $(0, n-k)$, the weights between the y -axis and the path cancel and we are left with the (non-inverted) weights between the path and the x -axis, see the rightmost path in Figure 4 and 5. So we are left with a path from $(0, 0)$ to $(k, n-k)$ which is weighted as in (2.16), since the signs do not change.

In the case of $w(s, t) = q$, Theorem 2.12 reduces to the well-known formula

$$\begin{bmatrix} n \\ k \end{bmatrix}_q = \begin{bmatrix} n \\ n-k \end{bmatrix}_{q^{-1}} q^{k(n-k)}.$$

In the following theorem we give two reflection formulae from which we can deduce the behaviour of w -binomial coefficients with negative values (see Proposition 2.14). Recall the involutions (2.7c) and (2.7f) to define the dual weight functions

$$\widetilde{w}(s, t) := w_{x^{-1}, x^{-1}y}(s, t) = w(1-s-t, t)^{-1}, \quad (2.19)$$

$$\check{w}(s, t) := w_{y^{-1}x, y^{-1}}(s, t) = w(s, 1-s-t)^{-1}. \quad (2.20)$$

The proof of both equations can be done analogously to the proof of Theorem 2.12; we therefore omit the proof.

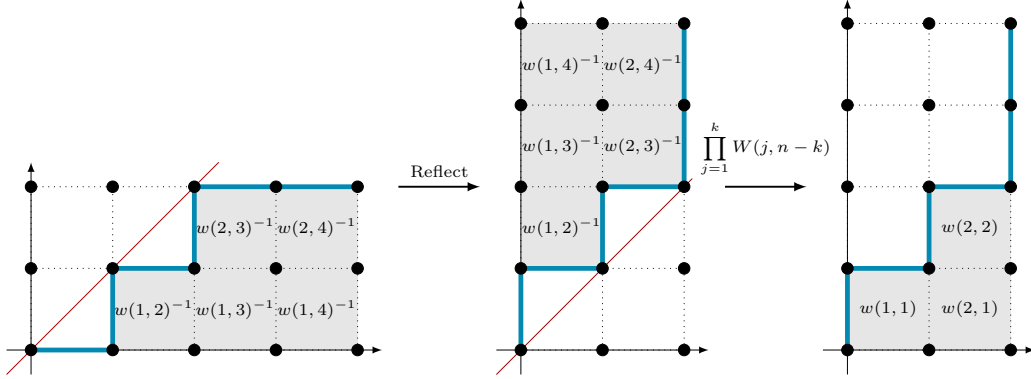

FIGURE 4. An illustration of the combinatorial interpretation of Theorem 2.12 for $0 \leq k \leq n$.

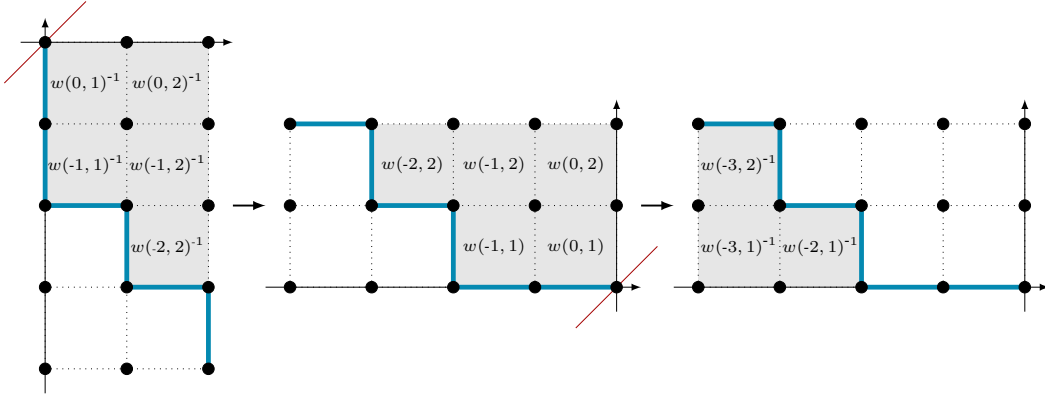

FIGURE 5. An illustration of the combinatorial interpretation of Theorem 2.12 for $k \leq n < 0$.

Theorem 2.13. *Let $n, k \in \mathbb{Z}$. Then,*

$$w \begin{bmatrix} n \\ k \end{bmatrix} = (-1)^{n-k} \operatorname{sgn}(n-k) \begin{bmatrix} -k-1 \\ -n-1 \end{bmatrix}_{\tilde{w}}^{n-k} \prod_{j=1}^{n-k} W(n+1-j, j)^{-1} \quad (2.21)$$

$$= (-1)^k \operatorname{sgn}(k) \begin{bmatrix} k-n-1 \\ k \end{bmatrix}_{\check{w}}^k \prod_{j=1}^k W(j, -j) \quad (2.22)$$

where $\tilde{w}(s, t) = w(1-s-t, t)^{-1}$, $\check{w}(s, t) = w(s, 1-s-t)^{-1}$ and $\operatorname{sgn}(k)$ is defined by (2.5).

By a careful case-by-case analysis one can also find combinatorial interpretations of the formulas in Theorem 2.13 similar to the interpretation of Theorem 2.12 above. We leave the details to the reader.

Given these reflection formulae, we can give a weight-dependent generalization of a Proposition by Loeb [6, Proposition 4.1].

Proposition 2.14 (The six regions). *Let $n, k \in \mathbb{Z}$, $\widehat{w}(s, t) = w(t, s)^{-1}$, $\widetilde{w}(s, t) = w(1 - s - t, t)^{-1}$ and $\check{w}(s, t) = w(s, 1 - s - t)^{-1}$. Depending on the signs of n and k , the following formulae apply:*

- (1) *If $0 \leq k \leq n$, then ${}_w \begin{bmatrix} n \\ k \end{bmatrix} = {}_w \begin{bmatrix} n \\ k \end{bmatrix}$.*
- (2) *If $n < 0 \leq k$, then ${}_w \begin{bmatrix} n \\ k \end{bmatrix} = (-1)^k {}_{\check{w}} \begin{bmatrix} k-n-1 \\ k \end{bmatrix} \prod_{j=1}^k W(j, -j)$.*
- (3) *If $k \leq n < 0$, then ${}_w \begin{bmatrix} n \\ k \end{bmatrix} = (-1)^{n-k} {}_{\widetilde{w}} \begin{bmatrix} -k-1 \\ -n-1 \end{bmatrix} \prod_{j=1}^{n-k} W(n+1-j, j)^{-1}$.*
- (4) *If $0 \leq n < k$, then ${}_w \begin{bmatrix} n \\ k \end{bmatrix} = 0$.*
- (5) *If $n < k < 0$, then ${}_w \begin{bmatrix} n \\ k \end{bmatrix} = 0$.*
- (6) *If $k < 0 \leq n$, then ${}_w \begin{bmatrix} n \\ k \end{bmatrix} = 0$.*

Case (1) corresponds to ordinary weighted lattice paths. The cases (2) and (3) show that weighted hybrid lattice paths from $(0, 0)$ to (n, m) , where n or m is negative, can be realized as ordinary weighted lattice paths where the weights $w(s, t)$ are replaced by $w(s, 1 - s - t)^{-1}$ or $w(1 - s - t, t)^{-1}$ and additionally, the weight of the path is multiplied by some weight given in the above equations. Cases (4) – (6) are already discussed in the proof of Theorem 2.8.

2.4. An extension of the noncommutative binomial theorem. For the purpose of the following theorem, we consider the algebras of formal power series $\mathbb{C}_w[[x, x^{-1}, y]]$ and $\mathbb{C}_w[[x, y, y^{-1}]]$ of formal power series. Suppose $f_n(x, y)$ is a function with power series expansions

$$f_n(x, y) = \sum_{k \geq 0} a_k x^k y^{n-k} \quad \text{in } \mathbb{C}_w[[x, y, y^{-1}]] \quad (2.23a)$$

or

$$f_n(x, y) = \sum_{k \leq n} b_k x^k y^{n-k} \quad \text{in } \mathbb{C}_w[[x, x^{-1}, y]]. \quad (2.23b)$$

Following [2], we extract coefficients of the expansions by writing $[x^k y^{n-k}]f_n(x, y) = a_k$ for $k \geq 0$ and $[x^k y^{n-k}]f_n(x, y) = b_k$ for $k < 0$. Now we can state the weight-dependent noncommutative binomial theorem for integer values which generalizes the results of [2], [6] and [14].

Theorem 2.15. *Let $n, k \in \mathbb{Z}$ and x, y be invertible variables satisfying the commutation relations (2.1), then we have*

$$[x^k y^{n-k}](x + y)^n = {}_w \begin{bmatrix} n \\ k \end{bmatrix}. \quad (2.24)$$

Proof. We will prove the theorem by showing that for $n \in \mathbb{Z}$,

$$(x + y)^n = \sum_{k \geq 0} {}_w \begin{bmatrix} n \\ k \end{bmatrix} x^k y^{n-k} \quad \text{in } \mathbb{C}_w[[x, y, y^{-1}]] \quad (2.25)$$

or

$$(x + y)^n = \sum_{k \leq n} {}_w \begin{bmatrix} n \\ k \end{bmatrix} x^k y^{n-k} \quad \text{in } \mathbb{C}_w[[x, x^{-1}, y]]. \quad (2.26)$$

We begin with (2.25). The case $n \geq 0$ is just Theorem 2.6 combined with the fact that ${}_w \begin{bmatrix} n \\ k \end{bmatrix} = 0$ if $0 \leq n < k$. We prove the case $n < 0$ by induction.

For $n = -1$, we use the geometric series and apply the relations (2.1) to obtain

$$\begin{aligned} (x + y)^{-1} &= y^{-1}(xy^{-1} + 1)^{-1} = y^{-1} \sum_{k \geq 0} (-1)^k (xy^{-1})^k \\ &= \sum_{k \geq 0} (-1)^k \left(\prod_{j=1}^k W(j, -j) \right) x^k y^{-k-1}. \end{aligned}$$

From Example 2.5 we know that for $k \geq 0$

$$(-1)^k \prod_{j=1}^k W(j, -j) = {}_w \begin{bmatrix} -1 \\ k \end{bmatrix}.$$

Suppose (2.25) holds for some $n + 1 \leq -1$. Then

$$\begin{aligned} (x + y)^{n+1} &= \sum_{k \geq 0} {}_w \begin{bmatrix} n+1 \\ k \end{bmatrix} x^k y^{n+1-k} \\ &= \sum_{k \geq 0} {}_w \begin{bmatrix} n \\ k \end{bmatrix} x^k y^{n+1-k} + \sum_{k \geq 0} {}_w \begin{bmatrix} n \\ k-1 \end{bmatrix} W(k, n+1-k) x^k y^{n+1-k} \\ &= \sum_{k \geq 0} {}_w \begin{bmatrix} n \\ k \end{bmatrix} x^k y^{n+1-k} + \sum_{k \geq 0} {}_w \begin{bmatrix} n \\ k \end{bmatrix} W(k+1, n-k) x^{k+1} y^{n-k} \\ &= \left(\sum_{k \geq 0} {}_w \begin{bmatrix} n \\ k \end{bmatrix} x^k y^{n-k} \right) (x + y) \end{aligned}$$

Hence, (2.25) is true for n as well and therefore, it is true for all $n \in \mathbb{Z}$. Since we pulled out y^{-1} in the initial step, the expansion is true in $\mathbb{C}_w[[x, y, y^{-1}]]$.

In order to prove the second expansion (2.26) we apply the involution (2.7a) to (2.25) to obtain

$$(y + x)^n = \sum_{k \geq 0} \widehat{w} \begin{bmatrix} n \\ k \end{bmatrix} y^k x^{n-k},$$

where $\widehat{w}(s, t) = w(t, s)^{-1}$. We use the reflection formula of Theorem 2.12 to obtain

$$\begin{aligned} (x + y)^n &= (y + x)^n = \sum_{k \geq 0} \widehat{w} \begin{bmatrix} n \\ k \end{bmatrix} y^k x^{n-k} = \sum_{k \geq 0} \widehat{w} \begin{bmatrix} n \\ k \end{bmatrix} \left(\prod_{i=1}^{n-k} W(i, k) \right) x^{n-k} y^k \\ &= \sum_{k \geq 0} {}_w \begin{bmatrix} n \\ n-k \end{bmatrix} x^{n-k} y^k = \sum_{k \leq n} {}_w \begin{bmatrix} n \\ k \end{bmatrix} x^k y^{n-k} \end{aligned}$$

in $\mathbb{C}_w[[x, x^{-1}, y]]$, as claimed. \square

Recall the interpretation of expansion (2.25) in the case $n \geq 0$ in terms of weighted lattice paths in the paragraph before Theorem 2.6. It turns out that this interpretation is also valid for the case $n < 0$ and for expansion (2.26). In the following we will extend the details of this interpretation.

In Theorem 2.8 we interpreted the w -binomial coefficients as the weighted sum over hybrid lattice paths. Identify expressions (or words) in $\mathbb{C}_w[x, x^{-1}, y, y^{-1}]$ with hybrid lattice paths locally (variable by variable, or step by step) as follows:

$$\begin{aligned} x &\leftrightarrow \text{east step} \\ x^{-1} &\leftrightarrow \text{west step} \\ y &\leftrightarrow \text{north step} \\ y^{-1} &\leftrightarrow \text{south step} \end{aligned}$$

This means, reading from left to right, that xy^{-1} corresponds to a path where an east step is followed by a south step and $y^{-1}x$ corresponds to a path where the south step is followed by an east step. The relations of the algebra $\mathbb{C}_w[x, x^{-1}, y, y^{-1}]$ take into account the changes of the respective weights when two consecutive steps are being interchanged. For instance, the lattice path P_0 from the left side of Figure 3 corresponds to the following expression:

$$\begin{aligned} y^{-1}xy^{-1}y^{-1}xy^{-1} &= w(1, 0)^{-1}xy^{-2}w(1, 0)^{-1}xy^{-2} \\ &= w(1, 0)^{-1}w(2, -2)^{-1}w(2, -1)^{-1}w(2, 0)^{-1}x^2y^{-4} = (-1)^2w(P_0)x^2y^{-4} \end{aligned}$$

where $w(P_0)$ is the weight of the path P_0 assigned to hybrid lattice paths in Theorem 2.8.

In summary, the expression $(x + y)^n$ translates into the sum over all expressions in $\mathbb{C}_w[x, x^{-1}, y, y^{-1}]$ corresponding to a hybrid lattice path from $(0, 0)$ to $(k, n - k)$, where k can be any nonnegative integer (in (2.25)) or any integer $\leq n$ (in (2.26)), and the expression is multiplied by $\epsilon = \text{sgn}(n)^k \text{sgn}(k)^n$.

2.5. Convolution formulae. In [14], the second author derived a weight-dependent generalization of the Chu–Vandermonde convolution formula

$$\binom{n+m}{k} = \sum_{j=0}^k \binom{n}{j} \binom{m}{k-j}$$

by expanding $(x + y)^{n+m}$ on the one hand and $(x + y)^n(x + y)^m$ on the other hand using Theorem 2.6 and comparing the coefficients of $x^k y^{n+m-k}$ for $n, m, k \geq 0$. Given Theorem 2.15, we can expand $(x + y)^{n+m}$ and $(x + y)^n(x + y)^m$ using (2.25) for all $n, m \in \mathbb{Z}$ to obtain the following weight-dependent convolution formula by again comparing the coefficients of $x^k y^{n+m-k}$ for $k \geq 0$. The proof is similar to the proof of [14, Corollary 1] and therefore we omit the details.

Corollary 2.16. *Let $n, m \in \mathbb{Z}$ and $k \geq 0$. For the w -binomial coefficients in (2.9), defined by the doubly-indexed sequence of invertible variables $(w(s, t))_{s, t \in \mathbb{Z}}$, we have the following formal identity in $\mathbb{C}[(w(s, t))_{s, t \in \mathbb{Z}}]$:*

$$w \binom{n+m}{k} = \sum_{j=0}^k w \binom{n}{j} \left(x^j y^{n-j} w \binom{m}{k-j} y^{j-n} x^{-j} \right) \prod_{i=1}^{k-j} W(i+j, n-j). \quad (2.27)$$

Compared to the corresponding identity in [14, Corollary 1], the sum in the above identity is bounded by k instead of $\min(k, n)$. But since $w \binom{n}{j}$ is zero if $j > n \geq 0$, this

makes no difference in the case $n \geq 0$. The above identity is formal because it contains noncommuting variables x and y defined by (2.1), which can be understood to be shift operators shifting the weight-dependent binomial coefficient in the expression

$$x^j y^{n-j} \left[\begin{matrix} m \\ k-j \end{matrix} \right]_w y^{j-n} x^{-j}.$$

Evaluating this expression will shift all weights in $\left[\begin{matrix} m \\ k-j \end{matrix} \right]_w$ and afterwards $x^j y^{n-j}$ will cancel with $y^{j-n} x^{-j}$ so we obtain an identity in $\mathbb{C}[(w(s,t))_{s,t \in \mathbb{Z}}]$ since all x and y vanish.

By expanding $(x+y)^{n+m}$ and $(x+y)^n (x+y)^m$ using (2.26) and comparing coefficients as before, we obtain a second w -Chu–Vandermonde convolution formula.

Corollary 2.17. *Let $n, m \in \mathbb{Z}$ and $k \leq n+m$. For the w -binomial coefficients in (2.9), defined by the doubly-indexed sequence of invertible variables $(w(s,t))_{s,t \in \mathbb{Z}}$, we have the following formal identity in $\mathbb{C}[(w(s,t))_{s,t \in \mathbb{Z}}]$:*

$$w \left[\begin{matrix} n+m \\ k \end{matrix} \right] = \sum_{j=k-m}^n w \left[\begin{matrix} n \\ j \end{matrix} \right] \left(x^j y^{n-j} \left[\begin{matrix} m \\ k-j \end{matrix} \right]_w y^{j-n} x^{-j} \right) \prod_{i=1}^{k-j} W(i+j, n-j). \quad (2.28)$$

If $n+m < k < 0$, both sides of the equation vanish, therefore (2.28) is true for all $k < 0$. This equation generalizes an identity in [2, Lemma 4.9]. There the corresponding identity is limited to the case $n, m, k < 0$ whereas Corollary 2.17 is even true if n, m are positive or have mixed signs.

In fact, Corollary 2.16 and 2.17 are equivalent. To see the correspondence, let $k \leq n+m$ and apply Corollary 2.16 to $w \left[\begin{matrix} n+m \\ n+m-k \end{matrix} \right]$. Additionally, we apply the involution from (2.7a) with $\widehat{w}(s,t) = w(t,s)^{-1}$ to obtain

$$\begin{aligned} & \widehat{w} \left[\begin{matrix} n+m \\ n+m-k \end{matrix} \right] \\ &= \sum_{j=0}^{n+m-k} \widehat{w} \left[\begin{matrix} n \\ j \end{matrix} \right] \left(y^j x^{n-j} \left[\begin{matrix} m \\ n+m-k-j \end{matrix} \right]_{\widehat{w}} x^{j-n} y^{-j} \right) \prod_{i=1}^{n+m-k-j} \widehat{W}(i+j, n-j) \\ &= \sum_{j=0}^{n+m-k} \widehat{w} \left[\begin{matrix} n \\ n+m-k-j \end{matrix} \right] \left(x^{-m+k+j} y^{n+m-k-j} \left[\begin{matrix} m \\ j \end{matrix} \right]_{\widehat{w}} y^{-n-m+k+j} x^{m-k-j} \right) \\ & \quad \times \prod_{i=1}^j \widehat{W}(i+n+m-k-j, -m+k+j) \\ &= \sum_{j=k-m}^n \widehat{w} \left[\begin{matrix} n \\ n-j \end{matrix} \right] \left(x^j y^{n-j} \left[\begin{matrix} m \\ m-k+j \end{matrix} \right]_{\widehat{w}} y^{j-n} x^{-j} \right) \prod_{i=1}^{m-k+j} \widehat{W}(i+n-j, j). \end{aligned}$$

Then we apply the reflection formula from Theorem 2.12 on both sides to obtain

$$w \left[\begin{matrix} n+m \\ k \end{matrix} \right] \left(\prod_{i=1}^k W(i, n+m-k)^{-1} \right) = \sum_{j=k-m}^n w \left[\begin{matrix} n \\ j \end{matrix} \right] \left(\prod_{i=1}^j W(i, n-j)^{-1} \right)$$

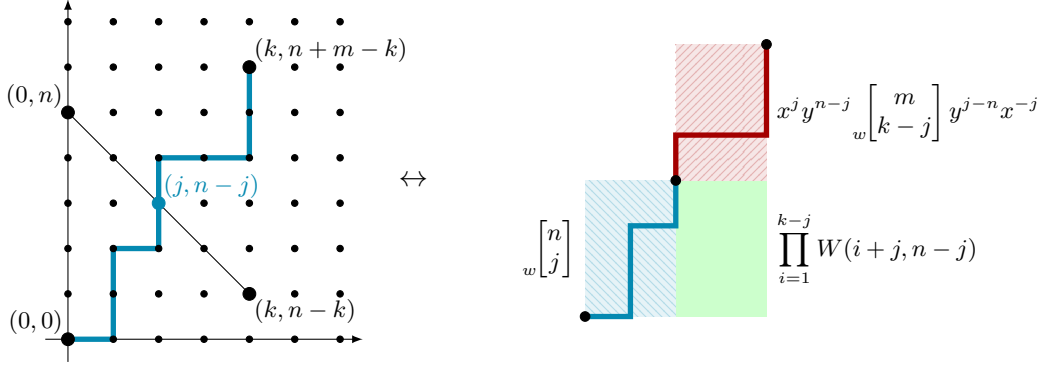

FIGURE 6. For $n, m \geq 0$, Corollary 2.16 translates into a convolution of paths.

$$\times \left(x^j y^{n-j} w \left[\begin{matrix} m \\ k-j \end{matrix} \right] \left(\prod_{i=1}^{m-k+j} W(i, m-k+j)^{-1} \right) y^{j-n} x^{-j} \right) \prod_{i=1}^{m-k+j} \widehat{W}(i+n-j, j)$$

It is a straightforward calculation to see that this expression is equivalent to Corollary 2.17.

We can apply the same method to the second and third weight-dependent binomial convolution formula in [14] to see that these two identities (extended to integers) are also equivalent to Corollary 2.16. There we can use the reflection formulae from Theorem 2.13 and the involutions from (2.7c) and (2.7f). The equivalence of the three convolution formulae in [14] also explains why the elliptic case of all three formulae are variants of the same elliptic hypergeometric summation formula, namely Frankel and Turaev's ${}_{10}V_9$ summation.

2.6. Combinatorial interpretation. In Theorem 2.8 we interpret w -binomial coefficients in terms of lattice paths. If the signs of n and m are identical, Corollaries 2.16 and 2.17 translate into convolutions of paths. If $n, m \geq 0$, both identities translate to convolutions corresponding to a diagonal in the first quadrant (see Figure 6). A weighted path counted by $w \left[\begin{matrix} n+m \\ k \end{matrix} \right]$, which crosses the point $(j, n-j)$ for some $0 \leq j \leq k$, can be decomposed into three parts: A weighted path from $(0, 0)$ to $(j, n-j)$ (counted by $w \left[\begin{matrix} n \\ j \end{matrix} \right]$), a weighted path from $(j, n-j)$ to $(k, n+m-k)$ (counted by $x^j y^{n-j} w \left[\begin{matrix} m \\ k-j \end{matrix} \right] y^{j-n} x^{-j}$) and the weights corresponding to the rectangle between the x -axis and the second path (which contributes $\prod_{i=1}^{k-j} W(i+j, n-j)$). By summing over all $0 \leq j \leq k$ we obtain the convolution.

If $n, m < 0$, Corollary 2.16 translates to a convolution corresponding to a diagonal in the fourth quadrant and Corollary 2.17 to a diagonal in the second quadrant (see Figure 7). The decomposition is similar to the $n, m \geq 0$ case.

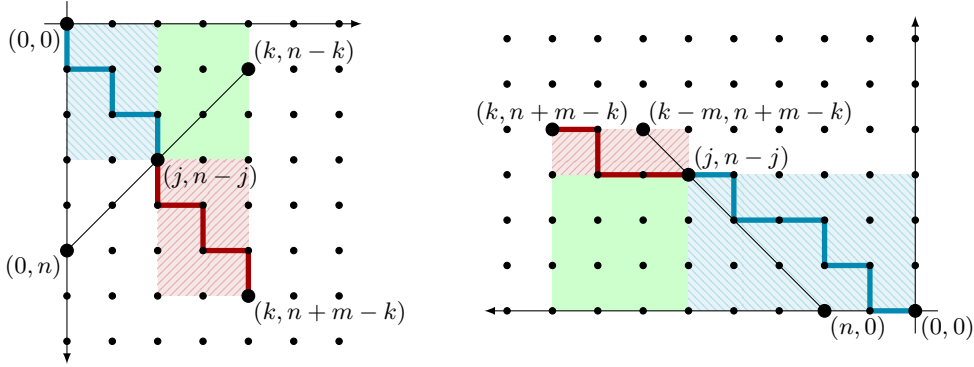

FIGURE 7. For $n, m < 0$, Corollary 2.16 (left) and Corollary 2.17 (right) translate into convolutions of paths.

If n and m have mixed signs, the combinatorial interpretation is less obvious, but we can give a combinatorial proof of the Corollaries by defining a sign-reversing involution. Since both Corollaries are equivalent, we will only give a combinatorial proof of Corollary 2.16. Note that constructing an involution to prove Corollary 2.17 works very similar.

Let $k \geq 0$, $n, m \in \mathbb{Z}$, $\text{sgn}(n) \neq \text{sgn}(m)$. Then we define $P(n, m, k)$ to be the set of tuples of weighted hybrid lattice paths (P_1, P_2) , where the first path, P_1 , goes from $(0, 0)$ to $(j, n - j)$ for some $0 \leq j \leq k$ and the second path, P_2 , goes from $(j, n - j)$ to $(k, n + m - k)$. (For the second path it is assumed that the origin is shifted to $(j, n - j)$, such that the path is not restricted to the same step set as P_1 .) Recall the weight-assignment to hybrid lattice paths (2.16) from Remark 2.9. Let $\mathcal{C}(P)$ be the collection of cells between the x -axis and the two paths. We define the weight of an element $(P_1, P_2) \in P(n, m, k)$ as

$$w((P_1, P_2)) = (-1)^{S(P_1, P_2)} \prod_{(i,j) \in \mathcal{C}(P)} w(i, j)^{\text{sgn}((i,j))}$$

where $\text{sgn}((i, j)) = \text{sgn}(i - 1)\text{sgn}(j - 1)$ and $S(P_1, P_2)$ is the number of east-south step combinations in either P_1 or P_2 . See Figures 8 and 9 for examples, where the cells in $\mathcal{C}(P)$ are shaded. By construction, the sum over all weights of tuples in $P(n, m, k)$ is given by the right hand side of Corollary 2.16. Let $Q(n, m, k)$ be the subset of $P(n, m, k)$ where, after deleting all intersecting north and south steps of P_1 and P_2 , one of the paths is completely deleted and we are left with a valid hybrid lattice path from $(0, 0)$ to $(k, n + m - k)$ and an empty path. See Figure 8 for three examples. The sum over all weights of tuples in $Q(n, m, k)$ is given by the left hand side of Corollary 2.16, since in this case the weighting corresponds to the weighting of hybrid lattice paths (2.16). In order to give a combinatorial interpretation of the Corollary, we will define a sign-reversing involution ι on $P(n, m, k)$ whose fixed-point set is $Q(n, m, k)$.

Consider the case $m < 0 \leq n$. Given an element (P_1, P_2) of $P(n, m, k)$, P_1 ending at $(j, n - j)$, we look at the last east step, e_1 , of P_1 and the first east step, e_2 , of P_2 . If

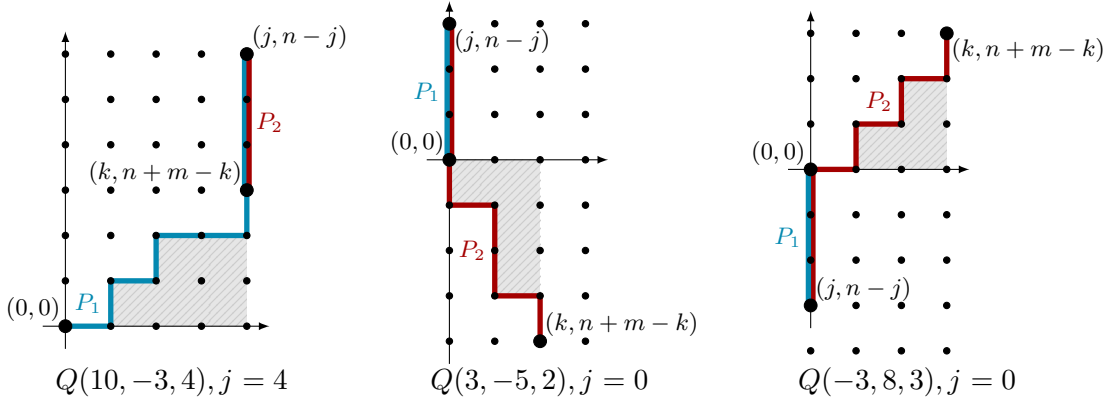
FIGURE 8. Three pairs of paths (P_1, P_2) in the fixed-point set.

both paths have an east step, we construct a new pair of paths (P'_1, P'_2) as follows. If e_1 is at the same height or below e_2 (see the right side of Figure 9 for an example), then P'_1 starts by following P_1 until e_1 . P'_1 is following e_1 and afterwards it's going north until it reaches e_2 . P'_1 ends by following e_2 and by adding north steps until the path reaches $(j+1, n-j-1)$. The path P'_2 begins at $(j+1, n-j-1)$ with south steps until it reaches P_2 and then follows all remaining steps of P_2 . If e_1 lies above e_2 (see the left side of Figure 9 for an example), then P'_1 is the path that follows P_1 until the starting point of e_1 . Instead of following e_1 , P'_1 is going north until it reaches $(j-1, n-j+1)$. P'_2 then starts at $(j-1, n-j+1)$ with south steps until it reaches e_1 . P'_2 follows e_1 and afterwards it follows all remaining steps of P_2 until it reaches $(k, n+m-k)$. If P_1 does not have an east step and e_2 is at height 0 or higher, we construct P'_1 and P'_2 as in the case when e_1 is weakly below e_2 (so e_2 will be part of P'_1). If P_2 does not have an east step and e_1 is at height $n+m-k+1$ or higher, we construct P'_1 and P'_2 as in the case when e_1 is above e_2 (so e_1 will be part of P'_2). In all other cases, $(P_1, P_2) \in Q(n, m, k)$ and we set $(P'_1, P'_2) = (P_1, P_2)$. Let ι be the map that maps (P_1, P_2) to (P'_1, P'_2) . By construction, (P'_1, P'_2) is an element of $P(n, m, k)$. Also by construction, $\iota^2 = id$, so ι is an involution. It is not hard to check that ι is weight-preserving, while P'_2 has one more or one less east-south step combination than P_2 (see Figure 9 for an example), except if (P_1, P_2) is in $Q(n, m, k)$. This makes ι sign-reversing outside of the fixed-point set $Q(n, m, k)$. We therefore are finished with the case $m < 0 \leq n$.

The case $n < 0 \leq m$ works very similar and is therefore left to the reader.

2.7. Hybrid Sets. While it is classical that binomial coefficients count the number of lattice paths, it is also classical that binomial coefficients $\binom{n}{k}$ with nonnegative integer values count the number of subsets with k elements of a set with n elements. In [6], Loeb showed that this interpretation can be extended to all integers n, k by a generalization of the definition of sets. Formichella and Straub [2] introduced a q -weighting of these sets. After briefly introducing the notation of Loeb (see [2, 6] for more details and

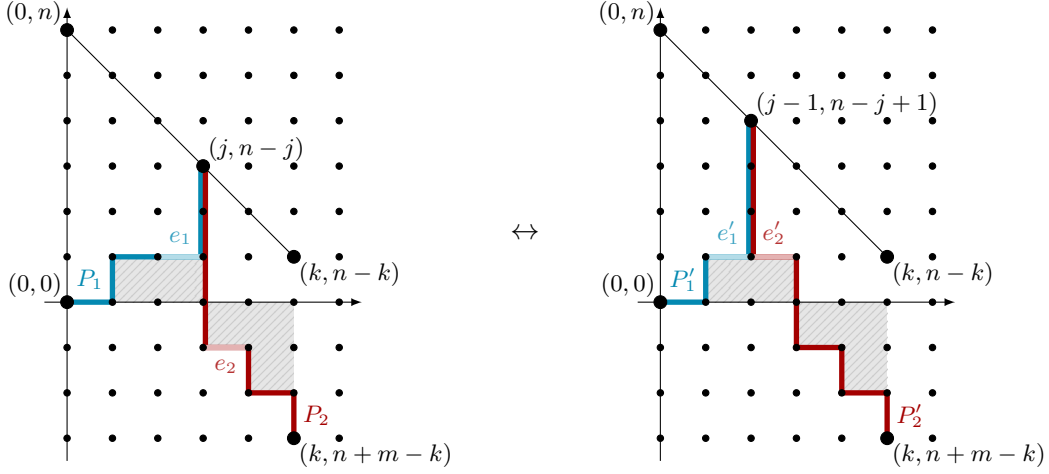

FIGURE 9. Visualization of the involution on a tuple of paths $(P_1, P_2) \in P(6, -4, 5)$ and $j = 3$. Both tuples of paths have the same weight (marked with gray diagonal lines), while P'_2 has one more east south step combination than P_2 , so the sign is reversed.

examples), we will show that there is a simple bijection between hybrid lattice paths and subsets of hybrid new sets that preserves the q -weighting.

Let U be a collection of elements, then any map $X : U \mapsto \mathbb{Z}$ is called a *hybrid set*. The value of $X(a)$ is called the *multiplicity* of a in X . Hybrid sets are usually denoted in the form $\{\cdots | \cdots\}$, where elements $a \in U$ with positive multiplicity are listed $X(a)$ times before the bar and elements with negative multiplicity are listed $-X(a)$ times after the bar. The *cardinality* of a hybrid set, $|\{\cdots | \cdots\}|$, is the sum of all multiplicities of the set.

For example, given $U = \{1, 2, 3, 4, 5, 6\}$, the hybrid set $\{1, 1, 1, 3, 3 | 2, 5, 5\}$ contains the elements 1, 2, 3, 5 with multiplicity 3, -1 , 2, -2 , respectively, while the elements 4, 6 have multiplicity 0. The cardinality of the set is $|\{1, 1, 1, 3, 3 | 2, 5, 5\}| = 3 - 1 + 2 - 2 = 2$.

A hybrid *new set* is a hybrid set where all multiplicities are either in $\{0, 1\}$ or in $\{0, -1\}$. We define the new set $\{a_l \cdots a_m\}$ by

$$\{a_l \cdots a_m\} = \begin{cases} \{a_l, a_{l+1}, \dots, a_m\} & m > l - 1 \\ \emptyset & m = l - 1 \\ \{a_{l-1}, a_{l-2}, \dots, a_{m+1}\} & m < l - 1 \end{cases} . \quad (2.29)$$

A hybrid set Y is a *subset* of a hybrid set X , if one can repeatedly decrease the multiplicity of elements in X with nonzero multiplicity to obtain Y or if one has removed Y .

Example 2.18. From the hybrid new set $\{a_1 \cdots a_2\} = \{a_1, a_2\}$ one can remove the subsets \emptyset , $\{a_1\}$, $\{a_2\}$ and $\{a_1, a_2\}$ to obtain the subsets $\{a_1, a_2\}$, $\{a_2\}$, $\{a_1\}$, \emptyset . So there are 4 different subsets of $\{a_1 \cdots a_2\}$.

From the hybrid new set $\{a_1 \cdots a_{-2}\} = \{a_0, a_{-1}\}$ one can remove three subsets with cardinality 2, $\{a_0, a_0\}$, $\{a_0, a_{-1}\}$ and $\{a_{-1}, a_{-1}\}$, to obtain three subsets with

cardinality -4 , $\{a_0, a_0, a_0, a_{-1}\}$, $\{a_0, a_0, a_{-1}, a_{-1}\}$, $\{a_0, a_{-1}, a_{-1}, a_{-1}\}$. So there are 3 subsets of $\{a_1 \cdots a_{-2}\}$ with cardinality 2 and 3 subsets with cardinality -4 , while $\{a_1 \cdots a_{-2}\}$ has infinitely many subsets in total.

Loeb [6] proved that, given a hybrid new set with cardinality n , the number of subsets with cardinality k is equal to the absolute value of $\binom{n}{k}$ for all $n, k \in \mathbb{Z}$. Formichella and Straub [2] extended this result to a q -weighted version. In the following, we will establish a general weighted extension by showing that subsets of hybrid new sets are in one-to-one correspondence with hybrid lattice paths.

For all $n \in \mathbb{Z}$ let $[n]$ be the hybrid new set

$$[n] = \begin{cases} \{1, 2, 3, \dots, n\}, & n > 0 \\ \emptyset, & n = 0 \\ \{0, -1, -2, \dots, n+1\}, & n < 0. \end{cases}$$

Let Y be a subset of $[n]$ with k elements, then we write it in a canonical form with ordered elements as follows. If $n \geq 0$, we write $Y = \{y_1, y_2, \dots, y_k\}$, where $y_i \leq y_{i+1}$ and, if $n < 0$, we write $Y = \{y_1, y_2, \dots, y_k\}$ (for $k \geq 0$) or $Y = \{|y_1, y_2, \dots, y_{-k}\}$ (for $k < 0$) with $y_i \geq y_{i+1}$.

We identify k -element subsets Y of $[n]$ with hybrid lattice paths ending at $(k, n - k)$ as follows: If $k \geq 0$, each element y_i of Y corresponds to an east step ending at $(i, y_i - i)$. If $k < 0$, each element y_i of Y corresponds to a west step starting at $(i, y_i - i)$. By connecting the horizontal steps, the origin and the end-point $(k, n - k)$ with north or south steps wherever possible, one can check, region by region, that we obtain a unique hybrid lattice path from $(0, 0)$ to $(k, n - k)$, since the lattice path is determined by its horizontal steps. For example, the path in Figure 2 corresponds to the subset $\{1, 3, 5, 6\}$ of $\{1, 2, 3, 4, 5, 6\}$. The left path in Figure 3 corresponds to the subset $\{0, -1\}$ of $\{0, -1\}$ whereas the right path corresponds to the subset $\{0, 0, -1, -1\}$ of $\{0, -1\}$.

This correspondence immediately yields

$$w \begin{bmatrix} n \\ k \end{bmatrix} = \epsilon \sum_Y \prod_{i=1}^k W(i, y_i - i), \quad (2.30)$$

where the sum ranges over all k -element subsets $Y = \{y_1 \cdots y_k\}$ (in canonical form) of $[n]$ and $\epsilon = \text{sgn}(k)^n \text{sgn}(n)^k$. For $w(s, t) = q$ (and $W(s, t) = q^t$) this reduces to the weighted model of Formichella and Straub [2, Theorem 4.5], which can be stated as

$$\begin{bmatrix} n \\ k \end{bmatrix}_q = \epsilon \sum_Y q^{\sigma(Y) - k(k+1)/2},$$

where the sum ranges over all k -element subsets $Y = \{y_1 \cdots y_k\}$ of $[n]$ and $\sigma(Y) = \sum_{y_i \in Y} y_i$.

3. SYMMETRIC FUNCTIONS

In [14] two important specializations of the weights $w(s, t)$ involving symmetric functions were worked out in the case $n, k \geq 0$. Here we discuss how this approach generalizes naturally to the case $n, k \in \mathbb{Z}$.

In [1] Damiani, D'Antona and Loeb define generalized complete homogeneous symmetric functions and elementary symmetric functions over hybrid sets. For our purposes it is sufficient to look at the following simplified definitions. See [1] for a more extensive discussion.

Recall the definition of the hybrid set $\{a_1 \cdots a_n\}$ from (2.29) and define the *elementary symmetric function* $e_k(\{a_1 \cdots a_n\})$ and the *complete homogeneous symmetric function* $h_k(\{a_1 \cdots a_n\})$ for $n \in \mathbb{Z}$ and $k \geq 0$ by

$$\prod_{i=1}^n (1 + a_i t) = \sum_{k \geq 0} e_k(\{a_1 \cdots a_n\}) t^k \quad (3.1a)$$

and

$$\prod_{i=1}^n (1 - a_i t)^{-1} = \sum_{k \geq 0} h_k(\{a_1 \cdots a_n\}) t^k. \quad (3.1b)$$

In the spirit of Theorem 2.15 it makes sense to extend these definitions for all integers n and $k \leq n$ or $k \leq -n$ by

$$\prod_{i=1}^n (1 + a_i t) = \sum_{k \leq n} e_k(\{a_1 \cdots a_n\}) t^k \quad (3.2a)$$

and

$$\prod_{i=1}^n (1 - a_i t)^{-1} = \sum_{k \leq -n} h_k(\{a_1 \cdots a_n\}) t^k, \quad (3.2b)$$

where we expand the left side in the variable t^{-1} . For example, for $n = -1$ we get:

$$\begin{aligned} \prod_{i=1}^{-1} (1 + a_i t) &= \frac{1}{1 + a_0 t} = a_0^{-1} t^{-1} \frac{1}{1 + a_0^{-1} t^{-1}} \\ &= a_0^{-1} t^{-1} \sum_{k \geq 0} (-1)^k a_0^{-k} t^{-k} = \sum_{k \leq -1} (-1)^k a_0^k t^k. \end{aligned}$$

For convenience, we will also use the abbreviated notations $e_k(n)$ and $h_k(n)$, for $e_k(\{a_1 \cdots a_n\})$ and $h_k(\{a_1 \cdots a_n\})$, respectively. The elementary and complete homogeneous symmetric functions satisfy for all $n, k \in \mathbb{Z}$, provided that $(n + 1, k) \neq (0, 0)$, the recurrence relations

$$\begin{aligned} e_k(n + 1) &= e_k(n) + a_{n+1} e_{k-1}(n) \\ h_k(n) &= h_k(n - 1) + a_n h_{k-1}(n) \end{aligned}$$

with initial conditions

$$\begin{aligned} e_0(n) &= 1, & h_0(n) &= 1 \\ e_n(n) &= \prod_{i=1}^n a_i, & h_n(1) &= \operatorname{sgn}(n)a_1^n. \end{aligned}$$

We can deduce directly from the definitions that for all $n, k \in \mathbb{Z}$ there holds (see also [1, Proposition 1])

$$e_k(\{a_1 \cdots a_n\}) = h_k(\{(-a_{n+1}) \cdots (-a_0)\}) \quad (3.3a)$$

$$e_k(\{a_1 \cdots a_n\}) = e_{n-k}(\{a_1^{-1} \cdots a_n^{-1}\}) \prod_{i=1}^n a_i. \quad (3.3b)$$

$$h_k(\{a_1 \cdots a_n\}) = h_{-n-k}(\{a_1^{-1} \cdots a_n^{-1}\}) (-1)^n \prod_{i=1}^n a_i^{-1} \quad (3.3c)$$

Remark 3.1. Loeb [6] defined ordinary binomial coefficients for $n \in \mathbb{Z}$ and $k \geq 0$ as $\binom{n}{k} = e_k(\{a_1 \cdots a_n\})$ with $a_i = 1$ for all $i \in \mathbb{Z}$. He extended this definition for negative k by an explicit formula containing gamma functions. With the extension (3.2) of the definition of $e_k(n)$ and $a_i = 1$ for all $i \in \mathbb{Z}$ we now have the equality $\binom{n}{k} = e_k(\{a_1 \cdots a_n\})$ which holds for all $n, k \in \mathbb{Z}$.

For nonnegative integers n and k the definitions (3.1) correspond to the sum formulae

$$e_k(\{a_1, a_2, \dots, a_n\}) = \sum_{1 \leq j_1 < j_2 < \cdots < j_k \leq n} a_{j_1} a_{j_2} \cdots a_{j_k} \quad (3.4)$$

$$h_k(\{a_1, a_2, \dots, a_n\}) = \sum_{1 \leq j_1 \leq j_2 \leq \cdots \leq j_k \leq n} a_{j_1} a_{j_2} \cdots a_{j_k} \quad (3.5)$$

and $e_0(n) = h_0(n) = 1$ (see for example [11, Proposition 4.3.5]).

This definition extends even to the case where n might be negative as follows. Analogously to the extended definition for products in (2.3), we define sums generally by

$$\sum_{j=l}^m A_j = \begin{cases} A_l + A_{l+1} + \cdots + A_m & m > l - 1 \\ 0 & m = l - 1 \\ -A_{l-1} - A_{l-2} - \cdots - A_{m+1} & m < l - 1 \end{cases}. \quad (3.6)$$

Then, for $n < 0$ and $k > 0$, the sum in (3.4) becomes

$$\begin{aligned} \sum_{1 \leq j_1 < j_2 < \cdots < j_k \leq n} a_{j_1} a_{j_2} \cdots a_{j_k} &= \sum_{j_1=1}^{n-k+1} \sum_{j_2=j_1+1}^{n-k+2} \cdots \sum_{j_k=j_{k-1}+1}^n a_{j_1} a_{j_2} \cdots a_{j_k} \\ &= \sum_{j_1=n-k+2}^0 \sum_{j_2=n-k+3}^{j_1} \cdots \sum_{j_k=n+1}^{j_{k-1}} (-1)^k a_{j_1} a_{j_2} \cdots a_{j_k} \\ &= \sum_{n+1 \leq j_k \leq j_{k-1} \leq \cdots \leq j_1 \leq 0} (-a_{j_1}) (-a_{j_2}) \cdots (-a_{j_k}) \end{aligned}$$

which is by (3.5) equal to $h_k(\{-a_{n+1}, -a_{n+2}, \dots, -a_0\})$. Indeed, also by (3.3) we have $e_k(\{a_0, a_{-1}, \dots, a_{n+1}\}) = h_k(\{-a_{n+1}, -a_{n+2}, \dots, -a_0\})$.

3.1. Elementary symmetric functions. The first choice of the weights is $w(s, t) = \frac{a_{s+t}}{a_{s+t-1}}$. In this case we have ${}_w[n]_k = e_k(n) \prod_{i=1}^k a_i^{-1}$. The noncommutative binomial theorem in Theorem 2.6 now gives the expansions

$$(x + y)^n = \sum_{k \geq 0} e_k(n) \left(\prod_{i=1}^k a_i \right) x^k y^{n-k} \quad (3.7a)$$

and

$$(x + y)^n = \sum_{k \leq n} e_k(n) \left(\prod_{i=1}^k a_i \right) x^k y^{n-k} \quad (3.7b)$$

for x and y noncommutative invertible variables satisfying

$$yx = \frac{a_2}{a_1}xy, \quad (3.8a)$$

$$x \frac{a_{s+t}}{a_{s+t-1}} = \frac{a_{s+t+1}}{a_{s+t}}x, \quad (3.8b)$$

$$y \frac{a_{s+t}}{a_{s+t-1}} = \frac{a_{s+t+1}}{a_{s+t}}y. \quad (3.8c)$$

Example 3.2. Define ϵ_a to be an operator that shifts all a_i to a_{i+1} , $i \in \mathbb{Z}$. For example, $\epsilon_a(a_1 + \frac{a_{-2}a_3}{a_5}) = a_2 + \frac{a_{-1}a_4}{a_6}$. Now let $x = a_1 t \epsilon_a$ and $y = \epsilon_a$, such that all relations in (3.8) are satisfied. Evaluating (3.7) by applying all operators on both sides recovers the generating functions

$$\prod_{i=1}^n (1 + a_i t) = \sum_{k \geq 0} e_k(n) t^k \quad \text{and} \quad \prod_{i=1}^n (1 + a_i t) = \sum_{k \leq n} e_k(n) t^k$$

and applying the duality (3.3) and $h_k(\{a_1 \cdots a_n\})(-1)^k = h_k(\{(-a_1) \cdots (-a_n)\})$ yields

$$\prod_{i=1}^n (1 - a_i t)^{-1} = \sum_{k \geq 0} h_k(n) t^k \quad \text{and} \quad \prod_{i=1}^n (1 - a_i t)^{-1} = \sum_{k \leq -n} h_k(n) t^k,$$

A second choice of x and y would be $x = -a_1 \epsilon_a$ and $y = t \epsilon_a$. Again, all relations in (3.8) are satisfied and we obtain another well-known generating function (see [1, p. 208])

$$(t - a_1)(t - a_2) \cdots (t - a_n) = \sum_{k \geq 0} e_k(\{(-a_1) \cdots (-a_n)\}) t^{n-k} \quad (3.9)$$

for $n \geq 0$ and

$$(t - a_1)^{-1}(t - a_2)^{-1} \cdots (t - a_n)^{-1} = \sum_{k \geq 0} e_k(\{(-a_1) \cdots (-a_n)\}) t^{n-k}$$

and

$$(t - a_1)^{-1}(t - a_2)^{-1} \cdots (t - a_n)^{-1} = \sum_{k \leq n} e_k(\{(-a_1) \cdots (-a_n)\}) t^{n-k}$$

for $n < 0$.

The convolutions in Corollary 2.16 and 2.17, respectively, give

$$e_k(n+m) = \sum_{j=0}^k e_j(\{a_1 \cdots a_n\}) e_{k-j}(\{a_{n+1} \cdots a_{n+m}\}) \quad (3.10)$$

and

$$e_k(n+m) = \sum_{j=k-m}^n e_j(\{a_1 \cdots a_n\}) e_{k-j}(\{a_{n+1} \cdots a_{n+m}\}). \quad (3.11)$$

Note that these convolutions are extensions of the corresponding convolution in [14, (3.6a)], since n, m and k can be negative. One consequence of this observation is the following example.

Example 3.3. Choose $m = -n$ in (3.10). Then, by using the duality of e_k and h_k (3.3), we recover the well-known identity (cf. [11])

$$\sum_{j=0}^k (-1)^j e_j(\{a_1 \cdots a_n\}) h_{k-j}(\{a_1 \cdots a_n\}) = \delta_{k,0}.$$

More generally, we obtain

$$\sum_{j=0}^k e_j(\{a_1 \cdots a_n\}) h_{k-j}(\{(-a_{n+m+1}) \cdots (-a_n)\}) = e_k(n+m).$$

3.2. Complete homogeneous symmetric functions. The second choice of the weights is $w(s, t) = \frac{a_{t+1}}{a_t}$. In this case we have ${}_w[n] = \text{sgn}(k) h_k(n - k + 1) a_1^{-k}$. The noncommutative binomial theorem in Theorem 2.6 now gives the expansions

$$(x + y)^n = \sum_{k \geq 0} h_k(n - k + 1) a_1^{-k} x^k y^{n-k} \quad (3.12a)$$

and

$$(x + y)^n = \sum_{k \leq n} \text{sgn}(k) h_k(n - k + 1) a_1^{-k} x^k y^{n-k} \quad (3.12b)$$

for x and y noncommutative invertible variables satisfying

$$yx = \frac{a_2}{a_1} xy, \quad (3.13a)$$

$$x \frac{a_{t+1}}{a_t} = \frac{a_{t+1}}{a_t} x, \quad (3.13b)$$

$$y \frac{a_{t+1}}{a_t} = \frac{a_{t+2}}{a_{t+1}} y. \quad (3.13c)$$

Example 3.4. Let $x = a_1$ and $y = (t - a_1)\epsilon_a$, such that all relations in (3.13) are satisfied. Evaluating (3.12) by applying all operators on both sides recovers the generating functions

$$t^n = \sum_{k \geq 0} h_k(\{a_1 \cdots a_{n-k+1}\})(t - a_1)(t - a_2) \cdots (t - a_{n-k}) \quad (3.14)$$

for $n \geq 0$ (see also [1, p. 208]) and

$$t^n = \sum_{k \geq 0} h_k(\{a_1 \cdots a_{n-k+1}\})(t - a_1)^{-1}(t - a_2)^{-1} \cdots (t - a_{n-k})^{-1}$$

and

$$t^n = \sum_{k \leq n} \operatorname{sgn}(k) h_k(\{a_1 \cdots a_{n-k+1}\})(t - a_1)(t - a_2) \cdots (t - a_{n-k})$$

for $n < 0$.

The convolutions in Corollary 2.16 and 2.17, respectively, give

$$\begin{aligned} & h_k(n + m - k + 1) \\ &= \sum_{j=0}^k h_j(\{a_1 \cdots a_{n-j+1}\}) h_{k-j}(\{a_{n-j+1} \cdots a_{n+m-k+1}\}) \end{aligned} \quad (3.15)$$

and

$$\begin{aligned} & h_k(n + m - k + 1) \operatorname{sgn}(k) \\ &= \sum_{j=k-m}^n \operatorname{sgn}(j) \operatorname{sgn}(k - j) h_j(\{a_1 \cdots a_{n-j+1}\}) h_{k-j}(\{a_{n-j+1} \cdots a_{n+m-k+1}\}). \end{aligned} \quad (3.16)$$

Remark 3.5. By applying the involution (2.7f) to the weight $w(s, t) = \frac{a_{s+t}}{a_{s+t-1}}$, we obtain

$$\check{w}(s, t) = w(s, 1 - s - t)^{-1} = \frac{a_{-t}}{a_{1-t}},$$

which is the weight for the complete homogeneous symmetric functions subject to the substitution $a_n \mapsto a_{-n+1}$. The reflection formula (2.22) reduces to (3.3a) in this case.

3.3. Application to Stirling numbers. Here we define weighted integers

$${}_w[n] := \begin{bmatrix} n \\ 1 \end{bmatrix}_w. \quad (3.17)$$

Note that by Proposition 2.14, ${}_w[n]$ is well-defined for all $n \in \mathbb{Z}$.

It is well known that the Stirling numbers of the first kind and the second kind, denoted by $s(n, k)$ and $S(n, k)$, respectively, can be defined as the connecting coefficients of the following identities

$$t(t-1) \cdots (t-n+1) = \sum_{k=0}^n s(n, k) t^k \quad (3.18a)$$

and

$$t^n = \sum_{k=0}^n S(n, k)t(t-1)\cdots(t-k+1). \quad (3.18b)$$

We also have the recursions

$$s(n, k) = s(n-1, k-1) - (n-1)s(n-1, k)$$

and

$$S(n, k) = kS(n-1, k) + S(n-1, k-1)$$

which can uniquely determine the Stirling numbers, given the initial conditions $s(n, 0) = \delta_{n,0}$ and $s(n, k) = 0$ for $k > n$, for the Stirling numbers of the first kind, and $S(n, 0) = \delta_{n,0}$ and $S(n, k) = 0$ for $k > n$, for the Stirling numbers of the second kind. Comparing (3.18a) to the generating function of the elementary symmetric function given in (3.9) gives the well known fact that $s(n, k)$ is the $(n-k)^{\text{th}}$ elementary symmetric function of $-1, -2, \dots, -n+1$ (cf. [7, I.2, Ex. 11 (a)]). Similarly, comparison of (3.18b) and (3.14) gives the fact that $S(n, k)$ is the $(n-k)^{\text{th}}$ complete homogeneous symmetric function of $1, 2, \dots, k$ (cf. [7, I.2, Ex. 11 (b)]).

We replace each integer showing up in (3.18) by the weighted integer defined in (3.17) to define weighted analogues of the Stirling numbers

$$t(t-w[1])\cdots(t-w[n-1]) = \sum_{k=0}^n s_w(n, k)t^k \quad (3.19a)$$

and

$$t^n = \sum_{k=0}^n S_w(n, k)t(t-w[1])\cdots(t-w[k-1]). \quad (3.19b)$$

From (3.19), we can obtain the recurrence relations

$$s_w(n, k) = s_w(n-1, k-1) - w[n-1]s_w(n-1, k) \quad (3.20a)$$

and

$$S_w(n, k) = w[k]S_w(n-1, k) + S_w(n-1, k-1). \quad (3.20b)$$

By comparing (3.19a) to the generating function of the elementary symmetric function given in (3.9), for any nonnegative integers n and k , we get

$$s_w(n, k) = e_{n-k}(\{-w[0], -w[1], -w[2], \dots, -w[n-1]\}). \quad (3.21)$$

Furthermore, the recurrence relation (3.20a) is valid for negative n and k values with $k \leq n$. As a result of using the recurrence relation for $k \leq n < 0$, we can prove that (3.21) extends to hold for $n, k \in \mathbb{Z}$ with $k \leq n$.

Similarly, for the weighted analogue of the Stirling numbers of the second kind, we compare (3.19b) to (3.14) and obtain, for any nonnegative integers n and k ,

$$S_w(n, k) = h_{n-k}(\{w[0], w[1], \dots, w[k]\}). \quad (3.22)$$

Also, the recurrence relation (3.20b) allows us to extend the definition of $S_w(n, k)$ for negative n and k values, with $k \leq n$. As a result, we can prove that (3.22) holds for $k \leq n < 0$ as well.

Identities (3.10), (3.11), (3.15) and (3.16) satisfied by elementary symmetric functions and complete homogeneous symmetric functions coming from the convolution formulas give relations satisfied by weighted analogues of the Stirling numbers. To do that, however, we need a slightly more generalized definition of the weighted Stirling numbers. Namely, we define α -shifted weighted Stirling numbers by

$$(t - {}_w[\alpha])(t - {}_w[\alpha + 1]) \cdots (t - {}_w[\alpha + n - 1]) = \sum_{k=0}^n s_w^\alpha(n, k) t^k \quad (3.23a)$$

and

$$t^n = \sum_{k=0}^n S_w^\alpha(n, k) (t - {}_w[\alpha])(t - {}_w[\alpha + 1]) \cdots (t - {}_w[\alpha + k - 1]), \quad (3.23b)$$

for some parameter α . Note that we recover the weighted Stirling numbers when $\alpha = 0$. Then again by comparing to the generating functions of symmetric functions, we get

$$s_w^\alpha(n, k) = e_{n-k}(\{-{}_w[\alpha], -{}_w[\alpha + 1], \dots, -{}_w[\alpha + n - 1]\}), \quad (3.24a)$$

and

$$S_w^\alpha(n, k) = h_{n-k}(\{{}_w[\alpha], {}_w[\alpha + 1], \dots, {}_w[\alpha + k]\}), \quad (3.24b)$$

for any $n, k \in \mathbb{Z}$ with $k \leq n$. These two identities, combined with (3.3a), immediately imply the relation

$$s_w^\alpha(n, k) = S_w^{\alpha+n}(-k - 1, -n - 1), \quad (3.25)$$

valid for $n, k \in \mathbb{Z}$ with $k \leq n$, that connects the first and second kinds of α -shifted weighted Stirling numbers. This is actually an extension of a well-known duality for the Stirling numbers which takes the form

$$s(n, k) = (-1)^{n-k} S(-k, -n), \quad (3.26)$$

that can be recovered from (3.25) by letting $\alpha = 0$ and the letting the weights $w(s, t) \rightarrow 1$. The duality relation in (3.26) is very classical and appears, for instance, in the (almost) two centuries old treatise [17, p. 305] by von Ettingshausen, in different notation. See also the discussion by Knuth [4].

The recurrence relations for the α -shifted weighted Stirling numbers that extend those in (3.20) are

$$s_w^\alpha(n, k) = s_w^\alpha(n - 1, k - 1) - {}_w[\alpha + n - 1] s_w^\alpha(n - 1, k) \quad (3.27a)$$

and

$$S_w^\alpha(n, k) = {}_w[\alpha + k] S_w^\alpha(n - 1, k) + S_w^\alpha(n - 1, k - 1). \quad (3.27b)$$

The identities (3.10), (3.11), (3.15) and (3.16) can be written in terms of weighted (and shifted weighted) Stirling numbers as follows:

$$S_w(n+m, n+m-k) = \sum_{j=0}^k S_w(n, n-j) s_w^{n+m-k+1}(k-j-m-1, -m-1),$$

$$S_w(n+m, n+m-k) = \sum_{j=k-m}^n S_w(n, n-j) s_w^{n+m-k+1}(k-j-m-1, -m-1),$$

and

$$s_w(n+m, k-n-m) = \sum_{j=0}^k s_w(n, n-j) S_w^{n+m}(k-j-m-1, -m-1),$$

$$s_w(n+m, k-n-m) = \sum_{j=k-m}^n s_w(n, n-j) S_w^{n+m}(k-j-m-1, -m-1).$$

Remark 3.6. The α -shifted Stirling numbers have been defined by Remmel and Wachs in [9] when the weighted integer $_w[n]$ is given by $[n]_{p,q}$ where

$$[n]_{p,q} = \frac{p^n - q^n}{p - q}.$$

4. ELLIPTIC HYPERGEOMETRIC SERIES

A very important specialization of the weights in [14], which also served as a major motivation for the present work, is the “elliptic” specialization. In this section we will recall some important notions of the theory of elliptic hypergeometric series and study the results from the previous sections in the elliptic case.

Crucial in the theory of elliptic functions is the *modified Jacobi theta function*, defined by

$$\theta(x; p) := \prod_{j \geq 0} \left((1 - p^j x) \left(1 - \frac{p^{j+1}}{x} \right) \right), \quad \theta(x_1, \dots, x_\ell; p) = \prod_{k=1}^{\ell} \theta(x_k; p),$$

where $x, x_1, \dots, x_\ell \neq 0$ and $|p| < 1$. The modified Jacobi theta function satisfies some fundamental relations [19, cf. p. 451, Example 5], like the inversion formula

$$\theta(x; p) = -x\theta(1/x; p), \tag{4.1a}$$

the quasi-periodicity relation

$$\theta(px; p) = -\frac{1}{x}\theta(x; p), \tag{4.1b}$$

and the three-term identity

$$\theta(xy, x/y, uz, u/z; p) = \theta(uy, u/y, xz, x/z; p) + \frac{x}{z}\theta(z/y, z/y, ux, u/x; p). \tag{4.1c}$$

We define the theta shifted factorial as

$$(x; q, p)_k = \prod_{i=0}^{k-1} \theta(xq^i; p), \tag{4.2}$$

where the product is defined for all integers k by (2.3) and for brevity, we write

$$(x_1, x_2, \dots, x_\ell; q, p)_k = (x_1; q, p)_k (x_2; q, p)_k \cdots (x_\ell; q, p)_k.$$

An *elliptic function* is a function of a complex variable that is meromorphic and doubly periodic. It is well known that elliptic functions can be obtained as quotients of modified Jacobi theta functions [10, 19].

Let $q = e^{2\pi i\sigma}$, $p = e^{2\pi i\tau}$, with complex σ , τ , then a multivariate function over \mathbb{C} of the complex variables u_1, \dots, u_n is called *totally elliptic*, if it is meromorphic in each variable with equal periods, σ^{-1} and $\tau\sigma^{-1}$, of double periodicity. The *field of totally elliptic multivariate functions* is denoted by $\mathbb{E}_{q^{u_1}, \dots, q^{u_n}; q, p}$.

4.1. Elliptic weights. We consider the elliptic specialization of the weights $w(s, t)$ from [14], here defined for all $s, t \in \mathbb{Z}$ by

$$w_{a,b;q,p}(s, t) := \frac{\theta(aq^{s+2t}, bq^{2s+t-2}, aq^{t-s-1}/b)}{\theta(aq^{s+2t-2}, bq^{2s+t}, aq^{t-s+1}/b)} q \quad (4.3)$$

to obtain the big weights

$$W_{a,b;q,p}(s, t) := \frac{\theta(aq^{s+2t}, bq^{2s}, bq^{2s-1}, aq^{1-s}/b, aq^{-s}/b)}{\theta(aq^s, bq^{2s+t}, bq^{2s+t-1}, aq^{1+t-s}/b, aq^{t-s}/b)} q^t \quad (4.4)$$

for all $s, t \in \mathbb{Z}$ and the *elliptic binomial coefficients*

$$\begin{bmatrix} n \\ k \end{bmatrix}_{a,b;q,p} := \frac{(q^{1+k}, aq^{1+k}, bq^{1+k}, aq^{1-k}/b; q, p)_{n-k}}{(q, aq, bq^{1+2k}, aq/b; q, p)_{n-k}}. \quad (4.5)$$

It is not hard to check that the elliptic binomial coefficient satisfies

$$\begin{bmatrix} n \\ 0 \end{bmatrix}_{a,b;q,p} = \begin{bmatrix} n \\ n \end{bmatrix}_{a,b;q,p} = 1 \quad \text{for } n \in \mathbb{Z},$$

and for $n, k \in \mathbb{Z}$, provided that $(n+1, k) \neq (0, 0)$,

$$\begin{bmatrix} n+1 \\ k \end{bmatrix}_{a,b;q,p} = \begin{bmatrix} n \\ k \end{bmatrix}_{a,b;q,p} + \begin{bmatrix} n \\ k-1 \end{bmatrix}_{a,b;q,p} W_{a,b;q,p}(k, n+1-k),$$

where the recurrence relation is a consequence of the three-term relation (4.1c). The weight functions (4.3) and (4.4) and the elliptic binomial coefficient (4.5) are totally elliptic, i.e., periodic in each of $\log_q a$, $\log_q b$, k and n , with equal periods of double periodicity [13, 14]. We denote the field of totally elliptic functions over \mathbb{C} , in the complex variables $\log_q a$ and $\log_q b$, with equal periods σ^{-1} , $\tau\sigma^{-1}$ (where $q = e^{2\pi i\sigma}$, $p = e^{2\pi i\tau}$, $\sigma, \tau \in \mathbb{C}$), of double periodicity, by $\mathbb{E}_{a,b;q,p}$.

We now focus on an elliptic version of the noncommutative algebra from Definition 2.1. The following definition is not a direct specialization of the weight-dependent algebra but a convenient extension of the specialization.

Definition 4.1. Let $x, x^{-1}, y, y^{-1}, a, b$ be noncommuting variables such that a and b commute with each other. Further let q and p be two complex numbers with $|p| < 1$. Let $\mathbb{C}_{a,b;q,p}[x, x^{-1}, y, y^{-1}]$ denote the associative unital algebra over \mathbb{C} , generated by the

invertible variables x, x^{-1}, y, y^{-1} and the set of all totally elliptic functions $\mathbb{E}_{a,b;q,p}$, satisfying the relations

$$x^{-1}x = xx^{-1} = 1, \quad (4.6a)$$

$$y^{-1}y = yy^{-1} = 1, \quad (4.6b)$$

$$yx = w_{a,b;q,p}(1, 1)xy, \quad (4.6c)$$

$$xf(a, b) = f(aq, bq^2)x, \quad (4.6d)$$

$$yf(a, b) = f(aq^2, bq)y, \quad (4.6e)$$

for all $f \in \mathbb{E}_{a,b;q,p}$.

We refer to the variables $x, x^{-1}, y, y^{-1}, a, b$ forming $\mathbb{C}_{a,b;q,p}[x, x^{-1}, y, y^{-1}]$ as *elliptic-commuting* variables. The actions of x and y on a weight $w(s, t)$ in (2.1d) and (2.1e) correspond to the shifts of the parameters a and b as described in (4.6d) and (4.6e).

The elliptic binomial coefficients appeared first in [13] to obtain an elliptic weighted enumeration of lattice paths and nests of nonintersecting lattice paths. In [14], a non-commutative binomial theorem in $\mathbb{C}_{a,b;q,p}[x, y]$ for the elliptic binomial coefficients and several convolution formulae analogous to the Chu–Vandermonde convolution formula were derived. Since these convolutions were equivalent to Frenkel and Turaev’s ${}_{10}V_9$ summation [3] (see also [10, Theorem 2.3.1.]), this provided a combinatorial interpretation of this summation formula, which is one of the main identities in the theory of elliptic hypergeometric series and can be stated as follows.

Proposition 4.2 (FRENKEL AND TURAEV’S ${}_{10}V_9$ SUMMATION). *Let $n \in \mathbb{N}_0$ and $a, b, c, d, e, q, p \in \mathbb{C}$ with $|p| < 1$. Then we have*

$$\sum_{k=0}^n \frac{\theta(aq^{2k}; p)}{\theta(a; p)} \frac{(a, b, c, d, e, q^{-n}; q, p)_k}{(q, aq/b, aq/c, aq/d, aq/e, aq^{n+1}; q, p)_k} q^k = \frac{(aq, aq/bc, aq/bd, aq/cd; q, p)_n}{(aq/b, aq/c, aq/d, aq/bcd; q, p)_n}, \quad (4.7)$$

where $a^2q^{n+1} = bcde$.

The convolution formulae in [14] were already extended to complex values by analytic continuation. In this section we extend the binomial theorem to negative values of n and k and derive reflection and convolution formulae for the elliptic binomial coefficients. Since we proved the weight-dependent convolution formulae combinatorially in Section 2.6, we extend the combinatorial proof of the second author in [14] of Proposition 4.2 to negative values.

4.2. Reflection formulae for elliptic binomial coefficients. In (2.7) we defined several involutions in the algebra $\mathbb{C}_w[x, x^{-1}, y, y^{-1}]$. Some of these involutions turn out to be particularly nice in the elliptic case. Recall that

$$\begin{aligned} \widehat{w}(s, t) &= w(t, s)^{-1}, \\ \widetilde{w}(s, t) &= w(1 - s - t, t)^{-1}, \\ \check{w}(s, t) &= w(s, 1 - s - t)^{-1}. \end{aligned}$$

For the elliptic small weights we obtain

$$\widehat{w}_{a,b;q,p}(s,t) = w_{b,a;q,p}(s,t) \quad (4.8a)$$

$$\widetilde{w}_{a,b;q,p}(s,t) = w_{a/b,1/b;q,p}(s,t) \quad (4.8b)$$

$$\check{w}_{a,b;q,p}(s,t) = w_{1/a,b/a;q,p}(s,t), \quad (4.8c)$$

which follows from (4.1a). Equation (4.8b) was recently introduced by the second and third author in [15]. We are now ready to derive the following reflection formulae from Theorem 2.12 and 2.13

Corollary 4.3. *Let $n, k \in \mathbb{Z}$. Then,*

$$\begin{aligned} \begin{bmatrix} n \\ k \end{bmatrix}_{a,b;q,p} &= \begin{bmatrix} n \\ n-k \end{bmatrix}_{b,a;q,p} \prod_{j=1}^k W_{a,b;q,p}(j, n-k) \\ &= (-1)^{n-k} \operatorname{sgn}(n-k) \begin{bmatrix} -k-1 \\ -n-1 \end{bmatrix}_{a/b,1/b;q,p} \prod_{j=1}^{n-k} W_{a,b;q,p}(n+1-j, j)^{-1} \\ &= (-1)^k \operatorname{sgn}(k) \begin{bmatrix} k-n-1 \\ k \end{bmatrix}_{1/a,b/a;q,p} \prod_{j=1}^k W_{a,b;q,p}(j, -j), \end{aligned}$$

where $\operatorname{sgn}(k)$ is defined by (2.5).

4.3. Elliptic binomial theorem. Recall the definition of $\mathbb{C}_{a,b;q,p}[x, y]$ from Definition 4.1. We will also consider the algebra of formal power series $\mathbb{C}_{a,b;q,p}[[x, y, y^{-1}]]$ and $\mathbb{C}_{a,b;q,p}[[x, x^{-1}, y]]$. Then, the weight-dependent noncommutative binomial theorem (Theorem 2.15) reduces to the following theorem.

Theorem 4.4. *Let $n, k \in \mathbb{Z}$. Then we have*

$$[x^k y^{n-k}](x+y)^n = \begin{bmatrix} n \\ k \end{bmatrix}_{a,b;q,p}. \quad (4.9)$$

In particular, we have the expansions

$$(x+y)^n = \sum_{k \geq 0} \begin{bmatrix} n \\ k \end{bmatrix}_{a,b;q,p} x^k y^{n-k} \quad \text{in } \mathbb{C}_{a,b;q,p}[[x, y, y^{-1}]] \quad (4.10)$$

or

$$(x+y)^n = \sum_{k \leq n} \begin{bmatrix} n \\ k \end{bmatrix}_{a,b;q,p} x^k y^{n-k} \quad \text{in } \mathbb{C}_{a,b;q,p}[[x, x^{-1}, y]]. \quad (4.11)$$

The theorem reduces to the noncommutative q -binomial theorem by Formichella and Straub [2] if we formally let $p \rightarrow 0$, $a \rightarrow 0$, then $b \rightarrow 0$ (in this order).

In [14] the elliptic case of the convolution formula in Corollary 2.16 was already derived for nonnegative n and m , but the restriction to nonnegative values was removed by analytic continuation. In the following Corollary, n and m can also be negative integers.

Corollary 4.5. *Let $n, m \in \mathbb{Z}$, $k \geq 0$ and $a, b, q, p \in \mathbb{C}$ with $|p| < 1$. Then we have*

$$\begin{bmatrix} n+m \\ k \end{bmatrix}_{a,b;q,p} = \sum_{j=0}^k \begin{bmatrix} n \\ j \end{bmatrix}_{a,b;q,p} \begin{bmatrix} m \\ k-j \end{bmatrix}_{aq^{2n-j}, bq^{n+j};q,p} \prod_{i=1}^{k-j} W_{a,b;q,p}(i+j, n-j), \quad (4.12)$$

where the elliptic binomial coefficients and $W_{a,b;q,p}(s, t)$ are defined by (4.5) and (4.4).

By changing the summation index k to j , substituting the parameters (a, b, c, d, e, n) appearing in Equation (4.7) by $(bq^{-n}/a, q^{-n}/a, bq^{1+n+m}, bq^{-n-m+k}/a, q^{-n}, k)$ and doing some basic manipulations one obtains Corollary 4.5. As described in [14], this substitution is reversible if q^{-n} and q^{-m} are treated as complex variables. Therefore, Corollary 4.5 is equivalent to Frenkel and Turaev's ${}_{10}V_9$ summation (4.7) and we provided a combinatorial proof for $n, m \in \mathbb{Z}$ and $k \geq 0$ in Section 2.6.

Corollary 4.6. *Let $n, m \in \mathbb{Z}$, $k \leq n+m$ and $a, b, q, p \in \mathbb{C}$ with $|p| < 1$. Then we have*

$$\begin{bmatrix} n+m \\ k \end{bmatrix}_{a,b;q,p} = \sum_{j=k-m}^n \begin{bmatrix} n \\ j \end{bmatrix}_{a,b;q,p} \begin{bmatrix} m \\ k-j \end{bmatrix}_{aq^{2n-j}, bq^{n+j};q,p} \prod_{i=1}^{k-j} W_{a,b;q,p}(i+j, n-j), \quad (4.13)$$

where the elliptic binomial coefficients and $W_{a,b;q,p}(s, t)$ are defined by (4.5) and (4.4).

As worked out in Section 2.5, these two Convolution formulae are equivalent. Therefore, also Corollary 4.6 is equivalent to Frenkel and Turaev's ${}_{10}V_9$ summation (4.7). By repeated analytic continuation we can extend both corollaries to complex n and m .

5. A MATRIX INVERSION

In this section we will use the fact that Corollary 2.16 is true for all integers n, m to obtain a weight-dependent matrix inversion. Matrix inversions are an important tool in combinatorics and special functions. They are important, for instance, in the theory of ordinary, basic and elliptic hypergeometric functions [5, 12, 18]. Given an infinite-dimensional lower-triangular matrix $F = (f_{n,k})_{n,k \in \mathbb{Z}}$ with $f_{n,k} = 0$ unless $n \geq k$, the matrix $G = (g_{k,l})_{k,l \in \mathbb{Z}}$ is the inverse matrix of F if and only if

$$\sum_{k=l}^n f_{n,k} g_{k,l} = \delta_{n,l} \quad \text{for all } n, l \in \mathbb{Z}.$$

For convenience, in this section sums of the form $\sum_{j=u}^v$ are defined to be 0 if $v \leq u-1$.

Theorem 5.1. *Let $(w(s, t))_{s,t \in \mathbb{Z}}$, x, y be noncommuting variables as in (2.1) and m be some integer. If $F = (f_{n,k})_{n,k \in \mathbb{Z}}$ with*

$$f_{n,k} = x^k y^{-m-k-1} \begin{bmatrix} m+n \\ n-k \end{bmatrix}_w y^{m+k+1} x^{-k} \prod_{i=1}^{n-k} W(i+k, -m-k-1), \quad (5.1a)$$

and $f_{n,k} = 0$ if $k > n$, then $G = (g_{k,l})_{k,l \in \mathbb{Z}}$ with

$$g_{k,l} = x^l \begin{bmatrix} -m-l-1 \\ k-l \end{bmatrix}_w x^{-l} \quad (5.1b)$$

and $g_{k,l} = 0$ if $l > k$ is the inverse matrix of F .

Both $f_{n,k}$ and $g_{k,l}$ are formal in $\mathbb{C}[(w(s,t))_{s,t \in \mathbb{Z}}]$, since they contain noncommuting variables x and y , which can be understood to be shift operators that cancel after shifting the weights $w(s,t)$.

Proof. We begin with Corollary 2.16 and substitute $(n, m, k) \mapsto (-m-l-1, m+n, n-l)$ for some $m, l, n \in \mathbb{Z}$ and $l \leq n$ to obtain that ${}_w \begin{bmatrix} n-l-1 \\ n-l \end{bmatrix}$ is equal to

$$\begin{aligned} & \sum_{k=0}^{n-l} \left(\begin{bmatrix} -m-l-1 \\ k \end{bmatrix} \left(x^k y^{-m-l-k-1} \begin{bmatrix} m+n \\ n-l-k \end{bmatrix} y^{m+l+k+1} x^{-k} \right) \right. \\ & \quad \times \left. \prod_{i=1}^{n-l-k} W(i+k, -m-l-k-1) \right) \\ & = \sum_{k=l}^n \left(\left(x^{k-l} y^{-m-k-1} \begin{bmatrix} m+n \\ n-k \end{bmatrix} y^{m+k+1} x^{-k+l} \right) \right. \\ & \quad \times \left. \prod_{i=1}^{n-k} W(i+k-l, -m-k-1) \begin{bmatrix} -m-l-1 \\ k-l \end{bmatrix} \right). \end{aligned}$$

Multiplying x^l from the left and x^{-l} from the right yields

$$\sum_{k=l}^n f_{n,k} g_{k,l} = x^l \begin{bmatrix} n-l-1 \\ n-l \end{bmatrix} x^{-l} = \delta_{n,l}$$

for all $l \leq n \in \mathbb{Z}$. For $l > n$, the sum is defined to be 0, which completes the proof. \square

REFERENCES

- [1] Ernesto Damiani, Ottavio M. D’Antona, and Daniel E. Loeb. The complementary symmetric functions: connection constants using negative sets. *Adv. Math.*, 135(2):207–219, 1998.
- [2] Sam Formichella and Armin Straub. Gaussian binomial coefficients with negative arguments. *Ann. Comb.*, 23(3-4):725–748, 2019.
- [3] Igor B. Frenkel and Vladimir G. Turaev. Elliptic solutions of the Yang-Baxter equation and modular hypergeometric functions. In *The Arnold-Gelfand mathematical seminars*, pages 171–204. Birkhäuser Boston, Boston, MA, 1997.
- [4] Donald E. Knuth. Two notes on notation. *Amer. Math. Monthly*, 99(5):403–422, 1992.
- [5] Christian Krattenthaler. A new matrix inverse. *Proc. Amer. Math. Soc.*, 124(1):47–59, 1996.
- [6] Daniel E. Loeb. Sets with a negative number of elements. *Adv. Math.*, 91(1):64–74, 1992.
- [7] Ian G. Macdonald. *Symmetric functions and Hall polynomials*. Oxford Classic Texts in the Physical Sciences. The Clarendon Press, Oxford University Press, New York, second edition, 2015. With contribution by A. V. Zelevinsky and a foreword by Richard Stanley, Reprint of the 2008 paperback edition [MR1354144].
- [8] Cormac O’Sullivan. Symmetric functions and a natural framework for combinatorial and number theoretic sequences. *Preprint*, arXiv:2203.03023, 2022.
- [9] Jeffrey B. Remmel and Michelle L. Wachs. Rook theory, generalized Stirling numbers and (p, q) -analogues. *Electron. J. Combin.*, 11(1):Research Paper 84, 48, 2004.
- [10] Hjalmar Rosengren. Elliptic hypergeometric functions. In Howard S. Cohl and Mourad E. H. Ismail, editors, *Lectures on Orthogonal Polynomials and Special Functions*, pages 213–279. Cambridge University Press, Cambridge, 2020.
- [11] Bruce E. Sagan. *The symmetric group*, volume 203 of *Graduate Texts in Mathematics*. Springer-Verlag, New York, second edition, 2001.

- [12] Michael Schlosser. Multidimensional matrix inversions and A_r and D_r basic hypergeometric series. *Ramanujan J.*, 1(3):243–274, 1997.
- [13] Michael J. Schlosser. Elliptic enumeration of nonintersecting lattice paths. *J. Combin. Theory Ser. A*, 114(3):505–521, 2007.
- [14] Michael J. Schlosser. A noncommutative weight-dependent generalization of the binomial theorem. *Sém. Lothar. Combin.*, 81:Art. B81j, 24, 2020.
- [15] Michael J. Schlosser and Meesue Yoo. Elliptic solutions of dynamical Lucas sequences. *Entropy*, 23(2):Paper No. 183, 14, 2021.
- [16] Renzo Sprugnoli. Negation of binomial coefficients. *Discrete Math.*, 308(22):5070–5077, 2008.
- [17] Andreas von Ettingshausen. *Die combinatorische Analysis*. Wallishausser Verlag, Wien, 1826.
- [18] S. Ole Warnaar. Summation and transformation formulas for elliptic hypergeometric series. *Constr. Approx.*, 18(4):479–502, 2002.
- [19] Heinrich Weber. *Elliptische Functionen und algebraische Zahlen*. Vieweg-Verlag, Braunschweig, 1891.

FAKULTÄT FÜR MATHEMATIK, UNIVERSITÄT WIEN, OSKAR-MORGENSTERN-PLATZ 1, A-1090 VIENNA, AUSTRIA

Email address: josef.kuestner@univie.ac.at

FAKULTÄT FÜR MATHEMATIK, UNIVERSITÄT WIEN, OSKAR-MORGENSTERN-PLATZ 1, A-1090 VIENNA, AUSTRIA

Email address: michael.schlosser@univie.ac.at

DEPARTMENT OF MATHEMATICS, CHUNGBUK NATIONAL UNIVERSITY, CHEONGJU 28644, SOUTH KOREA

Email address: meesueyoo@chungbuk.ac.kr