

Fault-tolerant Locating-Dominating Sets on the Infinite King Grid

Devin C. Jean

Computer Science Department

Vanderbilt University

devin.c.jean@vanderbilt.edu

Suk J. Seo

Computer Science Department

Middle Tennessee State University

Suk.Seo@mtsu.edu

Abstract

Let G be a graph of a network system with vertices, $V(G)$, representing physical locations and edges, $E(G)$, representing informational connectivity. A *locating-dominating (LD)* set S is a subset of vertices representing detectors capable of sensing an “intruder” at precisely their location or somewhere in their open-neighborhood—an LD set must be capable of locating an intruder anywhere in the graph. We explore three types of fault-tolerant LD sets: *redundant LD* sets, which allow a detector to be removed, *error-detecting LD* sets, which allow at most one false negative, and *error-correcting LD* sets, which allow at most one error (false positive or negative). In particular, we determine lower and upper bounds for the minimum density of fault-tolerant locating-dominating sets in the *infinite king grid*; to prove the lower bounds, we introduce a new share-discharging strategy.

Keywords: *fault-tolerant locating-dominating set, infinite king grid, density, share*

Mathematics Subject Classification: 05C69

1 Introduction

Let G be a graph—with vertex set $V(G)$ and edge set $E(G)$ —which models some system or facility with vertices representing physical locations or pieces of hardware and edges representing their physical or informational connectivity. There may be some “intruder” or other undesirable event in the system, which must be automatically detected and located anywhere in the graph via detectors placed at some subset $S \subseteq V(G)$ of vertices.

A detector vertex $v \in S$ is associated with a set of *detection regions* $R(v) \subseteq \mathcal{P}(V(G))$, representing the areas in which it can sense an intruder. We will explore *locating-dominating*

(LD) sets, whose detectors—known as *LD detectors*—have two detection regions: $R(v) = \{\{v\}, N(v)\}$, where $N(v)$ denotes the open-neighborhood of v : $\{u \in V(G) : uv \in E(G)\}$. This type of sensor is used in the creation of *locating-dominating (LD) sets*, for which a detector can locate an intruder at its location or somewhere in its open-neighborhood. There are many other choices for $R(v)$, such as $R(v) = \{N(v)\}$, yielding *open-locating-dominating (OLD) sets* [12, 17], or $R(v) = \{N[v]\}$ —where $N[v]$ denotes the closed neighborhood of v : $N(v) \cup \{v\}$ —yielding *identifying codes (ICs)* [11]. Lobstein [13] maintains a bibliography containing over 470 papers on these topics and related graphical parameters.

Conceptually, every LD detector vertex $v \in S$ will transmit a value of 0 (denoting no intruder), 1 (denoting an intruder in the open-neighborhood), or 2 (denoting an intruder at v). The goal is then to select a sufficient subset of vertices $S \subseteq V(G)$ so that we can locate an intruder anywhere in the graph. In this paper we are interested in going one step further: we would like the system to be able to function even in the event of an error, known as a *fault-tolerant LD (FTLD) set*. In particular, we consider three types of FTLD sets: *redundant LD (RED:LD) sets*, in which the system must be fully functioning even if at most one detector is removed or disabled, *error-detecting LD (DET:LD)*, where the system allows at most one false-negative (i.e. sending 0 instead of 1 or 2), and *error-correcting LD (ERR:LD) sets*, where the system allows at most one false-positive or false-negative (i.e. any kind of error).

The following theorems characterize the conditions of LD, RED:LD, and ERR:LD sets in a way that is more conducive to constructing optimal (minimum) sets:

Theorem 1.1 ([8]). *A set $S \subseteq V(G)$ is an LD set if and only if the following are true:*

- i. $\forall v \in V(G) - S, |N(v) \cap S| \geq 1$
- ii. $\forall v, u \in V(G) - S$ with $v \neq u, |(N(v) \cap S) \Delta (N(u) \cap S)| \geq 1$

Theorem 1.2 ([8]). *A set $S \subseteq V(G)$ is a RED:LD set if and only if the following are true:*

- i. $\forall v \in V(G), |N[v] \cap S| \geq 2$
- ii. $\forall v \in S$ and $\forall u \in V(G) - S, |((N(v) \cap S) \Delta (N(u) \cap S)) - \{v\}| \geq 1$
- iii. $\forall v, u \in V(G) - S$ with $u \neq v, |(N(v) \cap S) \Delta (N(u) \cap S)| \geq 2$

Theorem 1.3 ([9]). *A set $S \subseteq V(G)$ is a DET:LD set if and only if the following are true:*

- i. $\forall v \in V(G), |N[v] \cap S| \geq 2$
- ii. $\forall v, u \in S$ with $u \neq v, |(N(v) \cap S) \Delta (N(u) \cap S)| \geq 1$.
- iii. $\forall v \in V(G) - S$ and $\forall u \in S, |(N(v) \cap S) - (N(u) \cap S)| \geq 2$ or $|(N(u) \cap S) - (N(v) \cap S)| \geq 1$
- iv. $\forall v, u \in V(G) - S$ with $u \neq v, |(N(v) \cap S) - (N(u) \cap S)| \geq 2$ or $|(N(u) \cap S) - (N(v) \cap S)| \geq 2$

Theorem 1.4 ([7]). *A set $S \subseteq V(G)$ is an ERR:LD set if and only if the following are true:*

- i. $\forall v \in V(G), |N[v] \cap S| \geq 3$*
- ii. $\forall v, u \in S$ with $u \neq v, |(N(v) \cap S) \Delta (N(u) \cap S) - \{v, u\}| \geq 1$*
- iii. $\forall v \in V(G) - S$ and $\forall u \in S, |(N(v) \cap S) \Delta (N(u) \cap S) - \{u\}| \geq 2$*
- iv. $\forall v, u \in V(G) - S$ with $u \neq v, |(N(v) \cap S) \Delta (N(u) \cap S)| \geq 3$*

The properties given in Theorems 1.2 and 1.4 can be rewritten as the following, which make the similarities between RED:LD and ERR:LD easier to see.

Corollary 1.1 ([8]). *A set $S \subseteq V(G)$ is a RED:LD set if and only if the following are true:*

- i. $\forall v \in V(G), |N[v] \cap S| \geq 2$*
- ii. $\forall v, u \in V(G)$ with $u \neq v, |(N(v) \cap S) \Delta (N(u) \cap S) - \{v, u\}| \geq 2 - |\{v, u\} \cap S|$*

Corollary 1.2 ([7]). *A set $S \subseteq V(G)$ is an ERR:LD set if and only if the following are true:*

- i. $\forall v \in V(G), |N[v] \cap S| \geq 3$*
- ii. $\forall v, u \in V(G)$ with $u \neq v, |(N(v) \cap S) \Delta (N(u) \cap S) - \{v, u\}| \geq 3 - |\{v, u\} \cap S|$*

Given a graph, G , we are interested in the smallest possible sets with the required properties. For these parameters on general graphs, this minimization problem has been proven to be NP-complete [7, 8, 9]. In this paper, we consider upper and lower bounds for the smallest RED:LD, DET:LD, and ERR:LD sets in the *infinite king grid* (K), an 8-regular graph inspired by a chess board, with edges denoting the typical eight moves of a king. The *density* of a subset $S \subseteq V(G)$ is the ratio of $|S|$ to $|V(G)|$; if generated by uniform tiling, this is equal to the density in any tile, even for infinite graphs. The notations $\text{ERR:LD}(G)$, $\text{DET:LD}(G)$, $\text{RED:LD}(G)$, etc. will denote the minimum density of such a set on G .

In Section 2, we discuss some of the previous results of bounds for optimal (minimum) fault-tolerant variants of LD, OLD, and IC sets. Sections 3 and 5 will determine upper and lower bounds for RED:LD, DET:LD, and ERR:LD sets, respectively, on the infinite king grid. Section 4 introduces the concept of a “share argument” and the notations that are used later in Section 5. Importantly, Subsection 4.1 introduces a new share discharging strategy we will use for proving lower bounds; to the best of our knowledge, this method is novel.

2 Previous Results

The concept of LD sets was originally introduced by Slater [19, 18]. Slater [20] also explored “FTLD” sets, a type of fault-tolerant LD set which is referred to as an *error-detecting LD (DET:LD)* set in [9], and proved upper and lower bounds for optimal DET:LD sets in the *infinite square grid (SQ)*: $[\frac{12}{23}, \frac{3}{5}]$. Jean and Seo [7, 8] introduced two new fault-tolerant LD sets, RED:LD and ERR:LD sets, and fully characterized and established existence criteria for RED:LD, DET:LD, and ERR:LD sets; these characterizations are included in this paper as Theorems 1.2, 1.3, and 1.4. Note that characterizations of general fault-tolerant variants of distinguishing sets were established by Seo and Slater [16], though this does not cover LD set variants due to having more than one detection region. Jean and Seo [9] also proved upper and lower bounds for optimal RED:LD, DET:LD, and ERR:LD sets in *SQ*: $[\frac{2}{5}, \frac{7}{16}]$ for redundant, $[\frac{12}{23}, \frac{7}{12}]$ for error-detecting (improved from [20]), and $[\frac{24}{37}, \frac{2}{3}]$ for error-correcting.

A variety of graphical parameters have been studied on the infinite king grid [2, 3, 5, 14]; for instance, Charon et al. [1] proved $IC(K) = \frac{2}{9}$, Honkala and Laihonen [4] determined that $LD(K) = 1/5$, Seo [15] found that $\frac{6}{25} \leq OLD(K) \leq \frac{1}{4}$, and Jean and Seo [6] proved $\frac{3}{10} \leq RED:OLD(K) \leq \frac{1}{3}$ and $\frac{3}{11} \leq RED:IC(K) \leq \frac{1}{3}$.

Similar types of fault-tolerant open-locating-dominating sets on other infinite graphs have been studied, as well; for instance on the *infinite hexagonal grid (HEX)* and the *infinite triangular grid (TRI)*. Seo and Slater [16] proved that $RED:OLD(HEX) = \frac{2}{3}$, $DET:OLD(HEX) = \frac{6}{7}$, $RED:OLD(SQ) = \frac{1}{2}$, $DET:OLD(SQ) = \frac{3}{4}$, $RED:OLD(TRI) = \frac{3}{8}$, and $DET:OLD(TRI) \leq \frac{5}{9}$. Later, Jean and Seo [10] proved that $DET:OLD(TRI) = \frac{1}{2}$.

3 Upper Bounds

We have constructed LD, RED:LD, DET:LD, and ERR:LD sets on the infinite king grid with densities $\frac{1}{5}$, $\frac{5}{16}$, $\frac{6}{16}$, and $\frac{7}{16}$, respectively, as shown in Figure 1. Note that our construction for an LD set is essentially the same as one of the solutions that were previously found by Honkala and Laihonen [4]. To verify that $S \subseteq V(K)$ represented by the shaded vertices in Figure 1 (d) is an ERR:LD set, we can confirm that for all vertices in $V(K)$ meet the requirements given in Theorem 1.4. A vertex pair (v, u) is *k-distinguished* if $|(N(v) \cap S) \Delta (N(u) \cap S)| \geq k$. A vertex pair (v, u) is *distinguished* if it satisfies the relevant pair property of Theorem 1.4 (for ERR:LD) or Theorem 1.2 (for RED:LD).

Refer to Figure 2. We observe that every vertex in $V(K)$ is 3-dominated, so S satisfies property i) of Theorem 1.4. Now, consider a vertex pair $u, v \in V(G)$ with $u \neq v$. If $d(u, v) \geq 3$, then clearly the pair is 6-distinguished because no detector can dominate both of them, and so are distinguished; thus, we need only consider when $d(u, v) \leq 2$. Because every local (shaded) tile will be identical to any other, we can assume that u is in the tile. We then consider v being any vertex such that $d(u, v) \leq 2$. If every pair is distinguished, then we will have satisfied all four properties of Theorem 1.4, meaning S is an ERR:LD set.

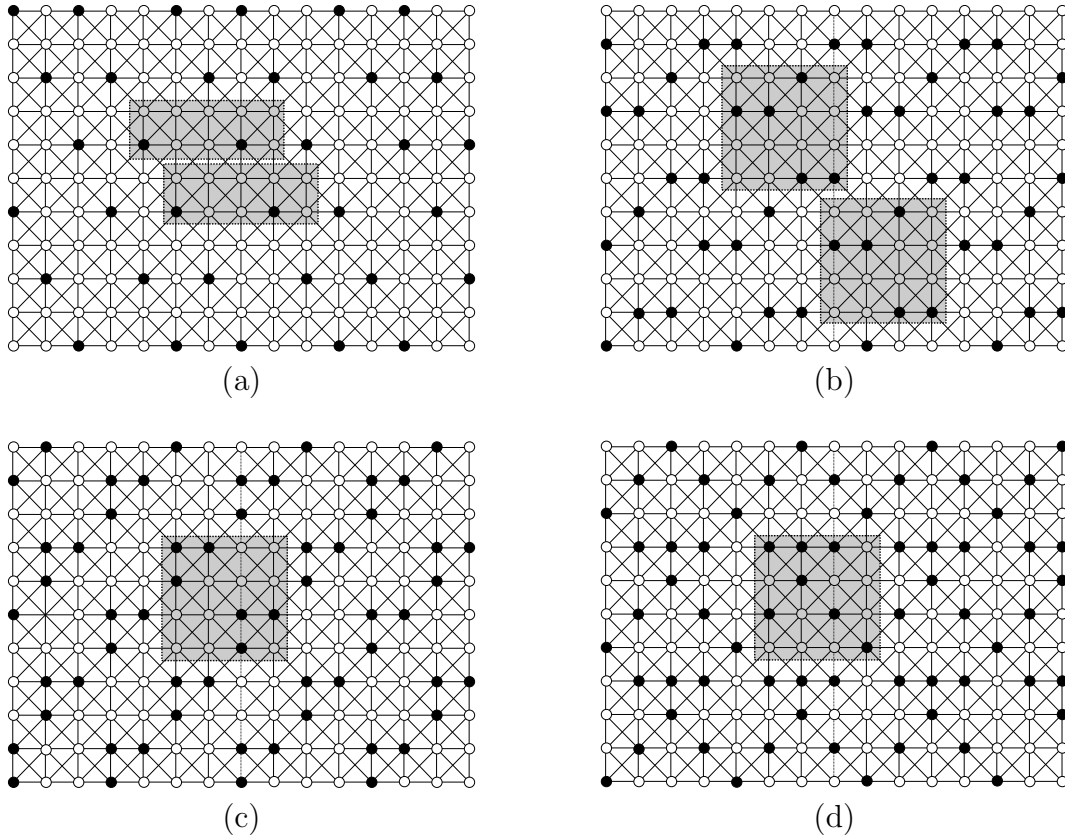

Figure 1: Our best constructions of LD (a), RED:LD (b), DET:LD (c), and ERR:LD (d) sets on the King's grid. Shaded vertices denote detectors.

For example, take the detector pair (v_{c3}, v_{d3}) : aside from themselves, they are dominated by v_{b2} , v_{e3} , and v_{d4} ; however v_{d4} is common to both. Thus, v_{c3} and v_{d3} are 2-distinguished; they need only be 1-distinguished, so they are distinguished. As another example, take the detector pair (v_{e5}, v_{d7}) : they have no common detectors, and are clearly 5-distinguished, so they are distinguished. Consider the non-detector pair (v_{f4}, v_{f5}) ; we see they are 3-distinguished by v_{e3} , v_{g3} , and v_{f6} , and therefore meet the minimum requirements to be distinguished. We also see the non-detector pair (v_{f5}, v_{g6}) are 3-distinguished by v_{e5} , v_{g7} , and v_{h7} , and are thus distinguished. Consider the mixed pair (v_{c5}, v_{d5}) ; we find they are 2-distinguished by v_{b6} and v_{e5} , and thus satisfy the minimum requirements to be distinguished. As another example, we see the mixed pair (v_{d2}, v_{d4})

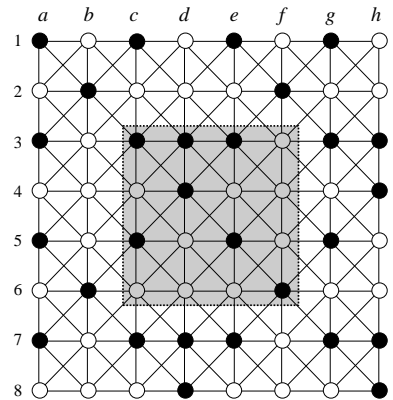

Figure 2: ERR:LD set to demonstrate Theorem 1.4

is 4-distinguished by v_{c1} , v_{e1} , v_{c5} , and v_{e5} , and thus is distinguished. It can be shown that all pairs are distinguished, so S is an ERR:LD set. Thus we have an upper bound for the optimal density: $\text{ERR:LD}(K) \leq \frac{7}{16}$.

Similarly, we can verify that the tilings in (a), (b), and (c) from Figure 1 satisfy the requirements of Theorems 1.1, 1.2, and 1.3, so we have upper bounds for the optimal densities: $\text{RED:LD}(K) \leq \frac{5}{16}$ and $\text{DET:LD}(K) \leq \frac{6}{16}$. Figure 1 shows an upper bound of $\frac{1}{5}$ for $\text{LD}(K)$, which has already been proven to be optimal [4]; it is included for comparison purposes.

4 Share Argument

In this section, we explain the concept of “share” and describe our new discharging technique. We also introduce several compact notations that will be used in the main lower bound proofs in Section 5.

Instead of finding a lowerbound for the optimal density directly, it is often easier to find an upperbound for the average “contribution” of each detector vertex. This “contribution” is measured by the *share* of a detector vertex, which was first introduced by Slater [20]. Let $S \subseteq V(G)$ be a set of LD detectors.

Definition 4.1. *The domination count of a vertex $v \in V(G)$, denoted $\text{dom}(v)$, is the number of detectors which dominate v , $|\{u \in S : v \in N[u]\}|$.*

Definition 4.2. *The partial share of a vertex $v \in V(G)$, denoted $\text{sh}[v]$, is $\frac{1}{\text{dom}(v)}$.*

Definition 4.3. *The (total) share of a detector vertex $v \in S$, denoted $\text{sh}(v)$, is $\sum_{u \in D} \text{sh}[u]$ where D is the set of vertices dominated by v .*

For LD detectors, $\text{dom}(v) = |N[v] \cap S|$ and $\text{sh}(v) = \sum_{u \in N[v]} \text{sh}[u]$. If S is a *dominating set*—that is, $\forall v \in V(G)$, $\text{dom}(v) \geq 1$ —it is clear that, for a finite graph, $\sum_{x \in S} \text{sh}(x) = |V(G)|$ because each vertex which is k -dominated has partial share $\frac{1}{k}$ and this fraction is repeated k times due to having k dominators. By extension, the average share will be equal to $\frac{|V(G)|}{|S|}$, the inverse density of S in $V(G)$, even in an infinite graph.

Definition 4.4. *For some $A \subseteq V(G)$, let $\text{sh}[A]$ denote the block share of A , $\sum_{x \in A} \text{sh}[x]$.*

For example, $\text{sh}[\{v_1, v_2\}] = \text{sh}[v_1] + \text{sh}[v_2]$, though we often shorten this to $\text{sh}[v_1 v_2]$.

Notation 4.1. *Let D_k denote the set of vertices which are exactly k -dominated, $\{v \in V(G) : \text{dom}(v) = k\}$, and D_{k+} denote the set of vertices which are at least k -dominated, $\cup_{j \geq k} D_j$.*

Notation 4.2. *Let σ_A be $\sum_{x \in A} \frac{1}{x}$ where A is a finite sequence of single-character symbols denoting natural numbers (e.g. $\sigma_{123} = \frac{1}{1} + \frac{1}{2} + \frac{1}{3}$ or $\sigma_{abc} = \frac{1}{a} + \frac{1}{b} + \frac{1}{c}$ where $a, b, c \in \mathbb{N}$).*

Consider the graph G in Figure 3, where shaded vertices represent detectors, elements of RED:LD set $S = \{v_1, v_2, v_4, v_6\}$. We observe that $\{v_5, v_6\} \subseteq D_2$, $\{v_1, v_3, v_4\} \subseteq D_3$, and $v_2 \in D_4$, thus $sh[v_5] = sh[v_6] = \frac{1}{2}$, $sh[v_1] = sh[v_3] = sh[v_4] = \frac{1}{3}$, and $sh[v_2] = \frac{1}{4}$. Therefore, $sh(v_1) = sh[N[v_1]] = sh[v_1v_2v_4v_5] = \sigma_{3432} = \frac{17}{12}$ and $sh(v_2) = sh[N[v_2]] = sh[v_1v_2v_3v_4v_6] = \sigma_{34332} = \frac{7}{4}$. Similarly, we can show that $sh(v_4) = \frac{7}{4}$ and $sh(v_6) = \frac{13}{12}$. And we see that the sum of shares for the dominating set S is $\frac{17}{12} + \frac{7}{4} + \frac{7}{4} + \frac{13}{12} = 6 = |V(G)|$, as expected, and the average is indeed $\frac{6}{4} = \frac{3}{2}$, the inverse density. Although it is not shown, using $S = V(G)$ in the example graph from Figure 3 would be an ERR:LD set, and using $S = V(G) - \{v_3\}$ would be a DET:LD set.

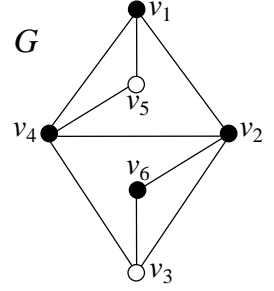

Figure 3:
Example RED:LD set.

4.1 Discharging Technique

In proving a maximum (target) value for the average share of all detector vertices, we would ideally like to prove a maximum value for the share of any individual detector vertex, as this would necessarily be a maximum for the average as well. However, in doing so we might run into “problem cases” where the share of an individual detector vertex exceeds our target. In these cases we will prove that said problem case also induces one or more other detector vertices with sufficiently low share that the average will still be bounded by the target. To do this, we apply a *discharging argument*, in which we attempt to distribute the excess share of any problem detectors to detectors with share below the target such that all detectors after discharging will have share no more than the target. This is a sound operation because the sum of shares, and therefore the average share, remains the same.

Notation 4.3. For some $x \in S$, let $\widehat{sh}(x)$ denote the share of x after discharging.

Notation 4.4. For some $x \in S$, let $sh_{max}(x)$ denote the maximum value of $sh(x)$ in any sub-configuration.

When discussing problem cases, we consider having a “center” vertex, say x , which is assumed to have $sh(x) > t$ where t is the target. In order for the discharging argument to be valid, we require that $\forall u \in S, \widehat{sh}(u) \leq t$. We allow discharging only to neighbors: for any $v \in N(x) \cap S$ with $sh(v) < t$, v can accept at most $t - sh_{max}(v)$ discharge in total. In particular, we allow x to discharge at most $\frac{1}{k}[t - sh_{max}(v)]$ to v , where $k \in \mathbb{N}$ is at least as large as the maximum number of neighbors of v which can simultaneously have shares exceeding t , including x itself; as a conservative value, $k \geq |u \in N(v) \cap S : sh_{max}(u) > t|$ can be used. By this construction, it is clear that this discharging rule is sound, as $\widehat{sh}(v)$ will never exceed t .

This strategy differs from other discharging approaches that have been used in that it works backwards: instead of determining the excess share of a problem vertex and dividing

it equally to its neighbors, we determine for each neighbor the amount of discharge it can receive from the problem vertex. Instead of uniform outgoing discharge from the problem case, we have uniform incoming discharge to the non-problem neighbors. This technique is perhaps more powerful for problem cases with asymmetric shares; that is, where the maximum shares of discharge targets are not equal.

Algorithm 1 Problem case resolution algorithm

```

1: function DISCHARGERESOLVES( $x, t$ )                                ▷ we assume  $x \in S$  with  $sh(x) > t$ 
2:    $p \leftarrow sh(x)$ 
3:   for all  $v \in N(x) \cap S$  do                                    ▷ for any discharge destination  $v$ 
4:      $s \leftarrow sh_{max}(v)$                                        ▷ find the highest share  $v$  can have
5:     if  $s < t$  then                                             ▷ check if discharge to  $v$  is possible
6:        $k \leftarrow |\{u \in N(v) \cap S : sh_{max}(u) > t\}|$      ▷ number of discharge sources for  $v$ 
7:        $p \leftarrow p - (t - s)/k$                                    ▷ safely discharge from  $x$  to  $v$ 
8:     end if
9:   end for
10:  return  $p \leq t$                                              ▷  $p$  is now  $\widehat{sh}(x)$ ; check if we resolved
11: end function

```

Algorithm 1 expresses how we will use this discharging strategy to resolve problem cases. Suppose we have some vertex $x \in S$ with $sh(x) > t$; this problem case can be resolved if Algorithm 1 returns *true*, given arguments x and t . Note that it is not strictly necessary to test all $v \in N(x) \cap S$, because as soon as $p \leq t$ we are done.

5 Lower Bounds

In this section we will determine lower bounds for the optimal (minimum) densities of ERR:LD, RED:LD, and DET:LD sets on infinite king grid, K . If S is a RED:LD set, then Theorem 1.2 guarantees every $v \in V(K)$ must be 2-dominated, so $sh[v] \leq \frac{1}{2}$; thus, $\forall x \in S$, $sh(x) \leq 9 \times \frac{1}{2} = \frac{9}{2}$, giving us a simple lower bound: $RED:LD(K) \geq \frac{2}{9}$. Similarly, by Theorems 1.3 and 1.4, we find that $DET:LD(K) \geq \frac{2}{9}$ and $ERR:LD(K) \geq \frac{3}{9} = \frac{1}{3}$.

Next, we prove lower bounds which are closer to the upper bounds presented in Section 3.

5.1 Lower bound on ERR:LD(K)

Theorem 5.1. *Let $S \subseteq V(G)$ be an ERR:LD set for the king's grid. Then, the average share of all vertices in S is at most $\frac{38}{15}$.*

Proof. Let $S \subseteq V(G)$ be an ERR:LD set on K , let the notations sh , dom , and k -dominated implicitly use S , and let a vertex pair being *distinguished* denote satisfying the relevant

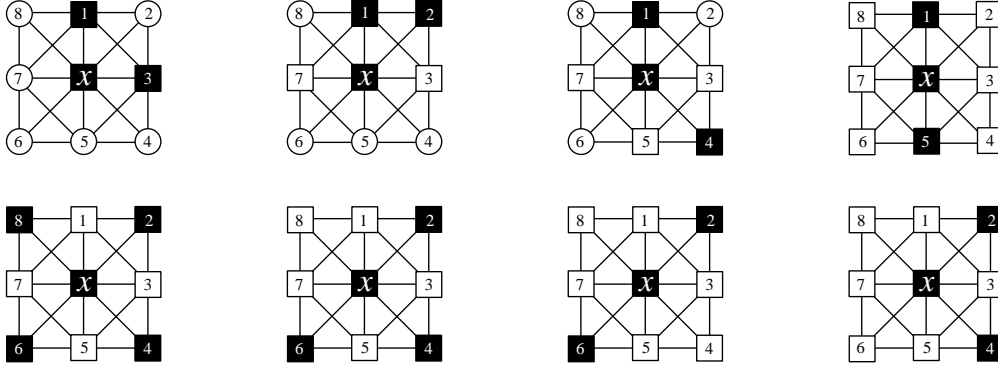

Figure 4: Configurations around a detector vertex x .

pair property of Theorem 1.4. Let $x \in S$ be a detector vertex; Theorem 1.4 yields that $|N[x] \cap S| \geq 3$. There are eight non-isomorphic ways to at least 3-dominate x , as shown in Figure 4. Square vertices represent detectors (shaded) or non-detectors (non-shaded), and round vertices denote unknowns. Note that vertices are labeled with numbers such as k , but will be referenced in the text as v_k .

Case L shape: First, we consider the partial shares of vertices $A = \{x, v_1, v_2, v_3\}$. We require $|A \cap D_{4+}| \geq 2$ for the vertices in A to be distinguished. Suppose v_2 is a non-detector. Let $d = \min_{w \in \{x, v_1, v_3\}} \text{dom}(w)$. If $d = 3$ then $\text{dom}(v_2) \geq 5$ to be distinguished; if $d = 4$ then $\text{dom}(v_2) \geq 4$ to be distinguished; otherwise $d \geq 5$ and $\text{dom}(v_2) \geq 3$. Thus, $sh[xv_1v_2v_3] \leq \max\{\sigma_{3445}, \sigma_{3445}, \sigma_{4444}, \sigma_{5553}\} = \frac{31}{30}$. Otherwise, v_2 is a detector; in order to distinguish it from the other three detectors, x, v_1 , and v_3 , we need $sh[xv_1v_2v_3] \leq \sigma_{4555} < \frac{31}{30}$. In either case, $sh[xv_1v_2v_3] \leq \frac{31}{30}$.

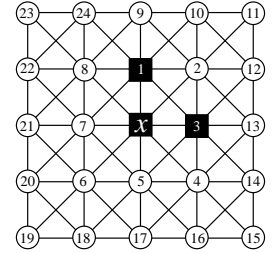

Figure 5: L shape

Next, we consider the partial shares of v_4 and v_5 . If both are detectors, then $sh[v_4v_5] \leq \sigma_{45}$ to be distinguished. If both are non-detectors, then $sh[v_4v_5] \leq \sigma_{34}$ to be distinguished. Otherwise, we let v_1 be unknown to allow symmetry between v_4 and v_5 ; then by symmetry let $\{v_4, v_5\} \cap S = \{v_4\}$; then $sh[v_4v_5] \leq \max\{\sigma_{35}, \sigma_{44}\}$. Thus, $sh[v_4v_5] \leq \sigma_{34}$, and by symmetry, $sh[v_7v_8] \leq \sigma_{34}$ as well. Therefore, $sh(x) = sh[xv_1v_2v_3] + sh[v_4v_5] + sh[v_6] + sh[v_7v_8] \leq \sigma_{3445} + \sigma_{34} + \sigma_3 + \sigma_{34} = \frac{38}{15}$, and we are done.

Case Triangle: Next, we consider the case where x is dominated by two neighbors in a “triangle” shape, as in Figure 6. We will assume that $\{v_3, v_7\} \cap S = \emptyset$, as otherwise we fall into the previous case.

We consider $sh[xv_1v_2v_3]$, $sh[v_7v_8]$, and $sh[v_4v_5v_6]$. First, if $\text{dom}(v_3) = 3$, then $\{x, v_1, v_2\} \subseteq D_{5+}$ to distinguish from v_3 , so $sh[xv_1v_2v_3] \leq \sigma_{3555}$; if $\text{dom}(v_3) = 4$, then $sh[xv_1v_2v_3] \leq \sigma_{4444}$ to be distinguished; otherwise

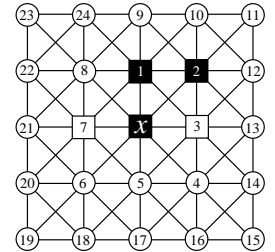

Figure 6: Triangle

$dom(v_3) \geq 5$, in which case $sh[xv_1v_2v_3] \leq \sigma_{3445}$. Therefore, $sh[xv_1v_2v_3] \leq \sigma_{3445}$. If $v_8 \in S$, then $sh[v_7v_8] \leq \max\{\sigma_{35}, \sigma_{44}\} < \sigma_{34}$; otherwise, $sh[v_7v_8] \leq \sigma_{34}$. If $\{v_4, v_5, v_6\} \cap D_{4+} \neq \emptyset$, then $sh(x) = sh[xv_1v_2v_3] + sh[v_4v_5v_6] + sh[v_7v_8] \leq \sigma_{3445} + \sigma_{334} + \sigma_{34} = \frac{38}{15}$ and we will be done.

Otherwise, we assume $\{v_4, v_5, v_6\} \subseteq D_3$; we consider the following sub-cases depending on whether these three vertices are detectors or not. **Subcase 1:** If $\{v_4, v_5, v_6\} \cap S = \emptyset$, then v_5 needs two additional detectors, but at least one of them will be in $N(v_4)$; thus, v_4 and v_5 are not distinguished, a contradiction. **Subcase 2:** If $\{v_4, v_5, v_6\} \cap S = \{v_5\}$, then v_4 and v_6 are not distinguished, a contradiction. **Subcase 3:** If $\{v_4, v_5, v_6\} \cap S = \{v_6\}$, then v_5 needs one additional detector, $w \in S$; if $w \in N(v_4)$ then $\{v_4, v_5\}$ are not distinguished, a contradiction; otherwise $w = v_{18}$ and $\{v_5, v_6\}$ are not distinguished, a contradiction. Similarly, if $\{v_4, v_5, v_6\} \cap S = \{v_4\}$ then we reach a contradiction. **Subcase 4:** If $\{v_4, v_5, v_6\} \cap S = \{v_4, v_5\}$ then v_4 and v_5 are not distinguished, a contradiction; similarly, if $\{v_4, v_5, v_6\} \cap S = \{v_5, v_6\}$ then v_5 and v_6 are not distinguished, contradiction. **Subcase 5:** If $\{v_4, v_5, v_6\} \cap S = \{v_4, v_6\}$, consider the third dominator for v_6 . If $v_{17} \in S$ or $v_{18} \in S$ is the third dominator, we get $dom(v_5) \geq 4$, a contradiction. If $v_{20} \in S$ or $v_{21} \in S$ is the third dominator, then we need $v_8 \in S$ or $v_{22} \in S$ to distinguish v_7 from v_6 , which in turn will make $dom(v_7) \geq 5$ and $dom(v_8) \geq 4$; thus $sh(x) = sh[xv_1v_2v_3] + sh[v_4v_5v_6] + sh[v_7v_8] \leq \sigma_{3445} + \sigma_{333} + \sigma_{45} < \frac{38}{15}$. Otherwise, $v_{19} \in S$ is the third dominator. Then we need $v_8 \in S$ or $v_{22} \in S$ to distinguish v_7 from v_5 , which will make $dom(v_7) \geq 4$ and $dom(v_8) \geq 4$; thus $sh(x) = sh[xv_1v_2v_3] + sh[v_4v_5v_6] + sh[v_7v_8] \leq \sigma_{3445} + \sigma_{333} + \sigma_{44} = \frac{38}{15}$, completing the proof of the triangle case.

Case ‘‘Bent’’: Consider the case where x is dominated by two neighbors in a ‘‘bent’’ shape, as in Figure 7. We will assume that $\{v_2, v_3, v_5, v_7, v_8\} \cap S = \emptyset$, as otherwise we fall into previous cases.

First, we consider when $v_6 \in S$, then $dom(x) = 4$. We observe that $\{v_3, v_5, v_7\} \subseteq D_{4+}$ to be distinguished from x . We now consider how to 4-dominate v_7 . Suppose $v_{20} \notin S$, then $\{v_{21}, v_{22}\} \cap S \neq \emptyset$, and we observe that $dom(v_8) \geq 5$ to be distinguished from v_7 , so $sh(x) \leq \frac{38}{15}$ and we are done. Thus, we assume that $v_{20} \in S$. If $\{v_{21}, v_{22}\} \cap S \neq \emptyset$ then again $dom(v_8) \geq 5$ to be distinguished from v_7 and we are done; so we assume $\{v_{21}, v_{22}\} \cap S = \emptyset$. By symmetry, we can assume that $\{v_{12}, v_{13}, v_{14}\} \cap S = \{v_{14}\}$. If $\{v_2, v_8\} \subseteq D_{4+}$ we are done, so without loss of generality we assume $dom(v_8) = 3$. If $v_{23} \in S$ then v_1 and v_2 cannot be distinguished, a contradiction. Otherwise $v_{24} \in S$ or $v_9 \in S$; in either case, v_1 and v_8 cannot be distinguished, a contradiction. Therefore, $sh(x) \leq \frac{38}{15}$.

Finally, we consider when $v_6 \notin S$. We observe that $dom(v_3) \geq 5$ to be distinguished from x , which in turn requires $dom(v_2) \geq 4$ to distinguish it from v_3 ; thus, $sh[xv_2v_3] \leq \sigma_{345}$. Next, we consider $sh[v_1v_7v_8]$ based on $dom(v_7)$. If v_7 is 5-dominated, then we need $dom(v_8) \geq 6$ to

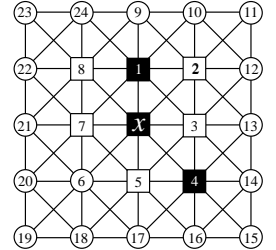

Figure 7: Bent

distinguish it from v_7 . If v_7 is 4-dominated with $\{v_{20}, v_{21}\}$ or $\{v_{20}, v_{22}\}$, we need $dom(v_8) \geq 5$ to distinguish from v_7 ; otherwise, v_7 is 4-dominated with $\{v_{21}, v_{22}\}$ and we need $dom(v_8) \geq 7$ to distinguish from v_7 . If v_7 is 3-dominated with v_{21} or v_{22} , we need $dom(v_8) \geq 6$ to distinguish from v_7 ; otherwise, v_7 is 3-dominated with v_{21} and we need $dom(v_8) \geq 4$, which in turn requires $dom(v_1) \geq 4$. From the three cases of $dom(v_7)$, we have $sh[v_1v_7v_8] \leq \sigma_{344}$. If $\{v_4, v_5, v_6\} \cap D_{4+} \neq \emptyset$ then we will be done because $sh(x) = sh[xv_2v_3] + sh[v_4v_5v_6] + sh[v_1v_7v_8] \leq \sigma_{345} + \sigma_{334} + \sigma_{344} \leq \frac{38}{15}$. Otherwise, we assume $\{v_4, v_5, v_6\} \subseteq D_3$. Then, we observe $\{v_{15}, v_{16}, v_{17}\} \cap S = \emptyset$ because v_4 is already 3-dominated, which in turn requires $v_{18} \in S$ to 3-dominate v_5 . We find that v_5 and v_6 are not distinguished, a contradiction, completing the proof for Case “bent.”

Case Vertical: Consider the case where x is dominated by two neighbors in a “vertical” shape, as in Figure 8. We can assume that $\{v_2, v_3, v_4, v_6, v_7, v_8\} \cap S = \emptyset$, as otherwise we fall into previous cases.

We observe that $dom(v_3) \geq 5$ to be distinguished from x . Further, $\{v_2, v_4\} \subseteq D_{4+}$ to be distinguished from v_3 , thus $sh[v_2v_3v_4] \leq \sigma_{454}$. By symmetry, we have $sh[v_6v_7v_8] \leq \sigma_{454}$, as well. Therefore, $sh(x) = sh[xv_1v_5] + sh[v_2v_3v_4] + sh[v_7v_8v_9] \leq \sigma_{333} + \sigma_{454} + \sigma_{454} \leq \frac{38}{15}$, and we are done.

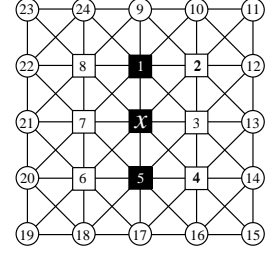

Figure 8: Vertical

Case “X” Shape: Consider the case where x is dominated by four neighbors in a “X” shape, as in Figure 9. We can assume that $\{v_1, v_3, v_5, v_7\} \cap S = \emptyset$, as otherwise we fall into previous cases.

Suppose $\{v_1, v_3, v_5, v_7\} \subseteq D_{4+}$, then $sh(x) \leq \frac{38}{15}$ and we are done; otherwise, without loss of generality we assume $dom(v_7) = 3$. Then $\{v_1, v_5\} \subseteq D_{4+}$ to be distinguished from v_7 . Suppose $dom(v_3) \geq 4$. If $v_{14} \notin S$, then $dom(v_2) \geq 4$ to be distinguished from v_3 and we are done; thus, we assume with symmetry that $\{v_{12}, v_{14}\} \subseteq S$. If $v_{13} \in S$, then $dom(v_2) \geq 4$ and we are done, so we assume $v_{13} \notin S$. If $dom(v_2) \geq 4$ we are done, so we assume $\{v_9, v_{10}, v_{11}\} \cap S = \emptyset$, requiring $v_{24} \in S$ to 3-dominate v_1 . If $dom(v_8) \geq 4$ we are done, otherwise we find v_1 and v_8 are not distinguished, a contradiction. Now, we can assume $\{v_3, v_7\} \subseteq D_3$ and examine $dom(v_1)$ and $dom(v_5)$. Without loss of generality we can assume $dom(v_1) \leq dom(v_5)$; then $(dom(v_1), dom(v_5)) \in \{(4, 4), (4, 5), (4, 6), (5, 5), (5, 6), (6, 6)\}$ and consider the following four sub-cases: where $dom(v_5) = 6$, and the other three possibilities.

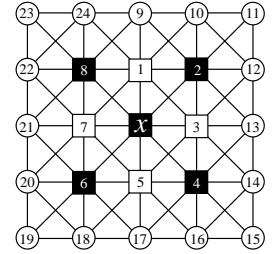

Figure 9: X-shape

First, if $dom(v_5) = 6$, then it requires $\{v_{16}, v_{17}, v_{18}\} \subseteq S$, which implies that $\{v_4, v_6\} \subseteq D_4$, so $sh(x) = sh[xv_2v_3v_7v_8] + sh[v_1v_5] + sh[v_4v_6] \leq \sigma_{53333} + \sigma_{46} + \sigma_{44} \leq \frac{38}{15}$. Second, assume $dom(v_1) = dom(v_5) = 4$. If $v_9 \in S$ to 4-dominate v_1 , then $\{v_2, v_8\} \subseteq D_{4+}$ to distinguish from v_1 . Otherwise, $v_{24} \in S$ or $v_{10} \in S$, then $\{v_2, v_8\} \cap D_{4+} \neq \emptyset$ to distinguish from v_1 . Hence, $sh[v_1v_2v_8] \leq \sigma_{344}$ and by symmetry, we also have $sh[v_4v_5v_6] \leq \sigma_{344}$. Therefore, $sh(x) = sh[xv_3v_7] + sh[v_1v_2v_8] + sh[v_4v_5v_6] \leq \sigma_{533} + \sigma_{344} + \sigma_{344} = \frac{38}{15}$ and we are done.

Next, assume $dom(v_1) = 4$ and $dom(v_5) = 5$. If $v_9 \in S$, then we need $\{v_2, v_8\} \subseteq D_{4+}$ for v_1 to be distinguished from v_2 and v_8 , and we get $sh(x) = sh[xv_3v_7] + sh[v_1v_2v_8] + sh[v_4v_5v_6] \leq \sigma_{533} + \sigma_{444} + \sigma_{353} = \frac{149}{60} < \frac{38}{15}$, so we are done; thus, we assume $v_9 \notin S$. We need $v_{10} \in S$ or $v_{24} \in S$ to 4-dominate v_1 ; by symmetry, let $v_{24} \in S$, which requires $v_{11} \in S$ to 3-dominate v_2 and $v_{23} \in S$ to distinguish v_8 from v_1 . If $v_{17} \in S$, then we need $v_{16} \in S$ or $v_{18} \in S$ to 5-dominate v_5 ; by symmetry, let $v_{16} \in S$, then $dom(v_4) \geq 5$ to be distinguished from v_5 and we are done. Thus, we assume $v_{17} \notin S$, requiring $\{v_{16}, v_{18}\} \subseteq S$ to 5-dominate v_5 . If $v_{15} \in S$ or $v_{19} \in S$, then $sh(x) = sh[xv_3v_7] + sh[v_1v_2v_8] + sh[v_4v_5v_6] \leq \sigma_{533} + \sigma_{434} + \sigma_{453} \leq \frac{38}{15}$, and we are done. Therefore, we assume $v_{15} \notin S$ and $v_{19} \notin S$, which leads us to the first problem configuration, which will be handled separately.

Lastly, assume $dom(v_1) = 5$ and $dom(v_5) = 5$. Similarly to the previous case, if $v_{17} \in S$, then $sh(x) \leq \frac{38}{15}$ and we are done, so with symmetry we assume $v_{17} \notin S$ and $v_9 \notin S$. Therefore, we require $\{v_{10}, v_{24}, v_{16}, v_{18}\} \subseteq S$ to 5-dominate v_1 and v_5 . If $\{v_{11}, v_{15}, v_{19}, v_{23}\} \cap S \neq \emptyset$, then $sh(x) = sh[xv_3v_7] + sh[v_1v_5] + sh[v_2v_4v_6v_8] \leq \sigma_{533} + \sigma_{55} + \sigma_{3334} \leq \frac{38}{15}$, and we are done. Thus, we assume $\{v_{11}, v_{15}, v_{19}, v_{13}\} \cap S = \emptyset$, which leads to the second problem configuration, which will be handled separately.

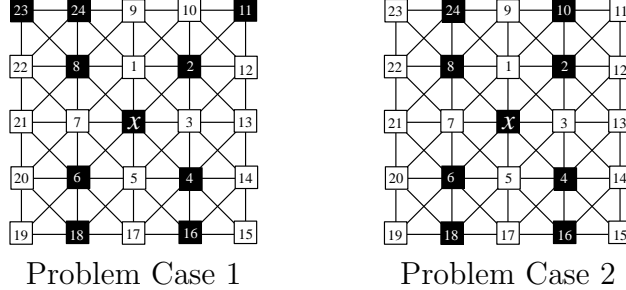

Figure 10: X-shape problem cases

In either of the Problem Cases—as shown in Figure 10—we see that $sh(x) \leq \max\{\frac{77}{30}, \frac{13}{5}\} = \frac{13}{5}$. To handle these problems, we consider the maximum share of v_4 , which will be the same in either configuration. We observe that we need $dom(v_{17}) \geq 6$ to distinguish from v_5 , $dom(v_{13}) \geq 4$ to distinguish from v_3 , and $sh[v_{14}v_{15}] \leq \sigma_{34}$ to distinguish v_{14} from v_{15} . Thus $sh(x) = sh[xv_3v_4v_5v_{17}] + sh[v_{13}v_{14}v_{15}v_{16}] = \sigma_{53356} + \sigma_{4343} = \frac{12}{5} < \frac{38}{15}$. Additionally, the only detector vertex adjacent to v_4 other than x is v_{16} , which previous cases have shown to have share at most $\frac{38}{15}$. Thus, v_4 can safely accept $\frac{38}{15} - \frac{12}{5} = \frac{2}{15}$ from x . Therefore, $\widehat{sh}(x) \leq \frac{13}{5} - \frac{2}{15} = \frac{37}{15} < \frac{38}{15}$ and we are done.

Case Lambda: Consider the case where x is dominated by three neighbors in a “lambda” shape, as in Figure 11. We will assume that $\{v_1, v_3, v_5, v_7, v_8\} \cap S = \emptyset$, as otherwise we fall into previous cases.

Firstly, we observe that $\{v_3, v_5\} \subseteq D_{4+}$ to be distinguish from x ; so $sh[xv_3v_5] \leq \sigma_{444}$. Suppose $\{v_{20}, v_{21}\} \cap S \neq \emptyset$, then we find $sh[v_6v_7] \leq \sigma_{35}$ to distinguish $\{v_6, v_7\}$. By symmetry, $\{v_9, v_{10}\} \cap S \neq \emptyset$ implies $sh[v_1v_2] \leq \sigma_{35}$. Therefore, if $\{v_{20}, v_{21}\} \cap S \neq \emptyset$ and $\{v_9, v_{10}\} \cap S \neq \emptyset$, then $sh(x) \leq \sigma_{444} + \sigma_{35} + \sigma_{35} + \sigma_{33} < \frac{38}{15}$ and we are done; otherwise by symmetry we assume that $\{v_9, v_{10}\} \cap S = \emptyset$, requiring $v_{24} \in S$ to 3-dominate v_1 . We then see that $dom(v_8) \geq 4$ to be distinguished from v_1 . Suppose $\{v_{20}, v_{21}\} \cap S \neq \emptyset$ then $sh[v_6v_7] \leq \sigma_{35}$ and we are done; thus, we assume $\{v_{20}, v_{21}\} \cap S = \emptyset$, requiring $\{v_{22}, v_{23}\} \subseteq S$ to 4-dominate v_8 . If $\{v_{12}, v_{13}\} \cap S \neq \emptyset$, then $sh[v_2v_3] \leq \sigma_{35}$ and we are done; thus, by symmetry, we assume that $\{v_{12}, v_{13}, v_{17}, v_{18}\} \cap S = \emptyset$, requiring $v_{11} \in S$ and $v_{19} \in S$ to 3-dominate v_2 and v_6 , respectively. Additionally, we require $v_{14} \in S$ and $v_{16} \in S$ to 4-dominate v_3 and v_5 , respectively. If $v_{15} \in S$ then $dom(v_4) \geq 5$ and we are done, so we assume $v_{15} \notin S$, leading to the configuration shown in Figure 12.

To handle this problem case, we look at the share of v_4 . We observe that we need $dom(v_{15}) \geq 4$ and $dom(v_{13}) \geq 5$ to be distinguished from v_4 and v_3 , respectively. Therefore, $sh(v_4) \leq \frac{2}{5} + \frac{5}{4} + \frac{2}{3} = \frac{139}{60}$. Additionally, v_4 is only adjacent to v_{14} and v_{16} , which preceding Cases have proven to have share at most $\frac{38}{15}$. Thus, v_4 has no neighboring detectors with share exceeding $\frac{38}{15}$ other than x itself, so it can safely accept $\frac{38}{15} - \frac{139}{60} = \frac{13}{60}$ discharge from x . Therefore, $\widehat{sh}(x) \leq \frac{31}{12} - \frac{13}{60} = \frac{71}{30} < \frac{38}{15}$ and we are done.

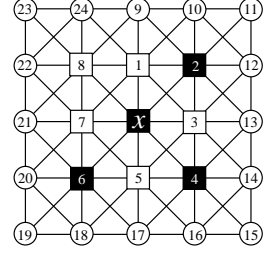
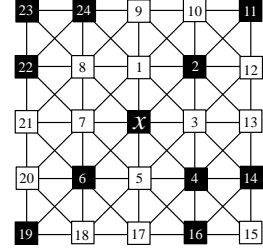
Figure 11: λ Figure 12: λ problem case

Case Diagonal: Consider the case where x is dominated by two neighbors in a “diagonal” shape, as in Figure 13. We can assume that $\{v_1, v_3, v_4, v_5, v_7, v_8\} \cap S = \emptyset$, as otherwise we fall into previous cases. As this case is perhaps the most complicated, we will begin by proving two smaller claims:

Claim 1. $|\{w \in A : dom(w) = 3\}| \leq 1$ for $A = \{v_1, v_3\}$ or $A = \{v_5, v_7\}$.

Proof. By symmetry, we need only examine one event: suppose that $dom(v_1) = dom(v_3) = 3$; then v_1 and v_3 are not distinguished, a contradiction. \square

Claim 2. If $dom(v_1) \geq k$ or $dom(v_3) \geq k$ in the diagonal configuration, then $dom(v_2) \geq k$.

Proof. By Theorem 1.4, we know $k \leq 3$ is always satisfied, and vertices v_1 and v_3 can be at most 5-dominated, so we consider two cases: $k = 4$ and $k = 5$.

For $k = 4$, without loss of generality assume to the contrary that $dom(v_3) \geq 4$ but $dom(v_2) \leq 3$. We see that v_2 is already dominated by itself and x , and we consider the third

dominator for v_2 . If $\{v_9, v_{10}, v_{11}\} \cap S \neq \emptyset$, then $dom(v_3) < 4$, a contradiction; thus, we assume $\{v_9, v_{10}, v_{11}\} \cap S = \emptyset$. We see that v_2 and v_3 are not distinguished, a contradiction.

For $k = 5$, without loss of generality, assume to the contrary that $dom(v_3) \geq 5$ but $dom(v_2) \leq 4$. We require $\{v_{12}, v_{13}, v_{14}\} \subseteq S$ to 5-dominate v_3 ; thus $dom(v_2) \geq 4$, so $dom(v_2) = 4$ and we observe that v_2 and v_3 are not distinguished, a contradiction. \square

By symmetry, Claim 2 also applies to $dom(v_5)$ and $dom(v_7)$ influencing $dom(v_6)$.

Resuming with the diagonal case expansion, suppose $\{v_9, v_{10}\} \cap S = \emptyset$, then $dom(v_1) = 3$ with $v_{24} \in S$. Then Claim 1 yields that $dom(v_3) \geq 4$, and Claim 2 yields that $dom(v_2) \geq 4$. Additionally, $\{v_5, v_7\} \cap D_{4+} \neq \emptyset$, implying $dom(v_6) \geq 4$. We also require $dom(v_8) \geq 4$ to be distinguished from v_1 . We now have five 4-dominated vertices; if we have any more or if any of them is at least 5-dominated then we are done. Thus, we will assume $\{v_1, v_4\} \subseteq D_3$, $\{v_2, v_3, v_6, v_8\} \subseteq D_4$, and $(dom(v_5), dom(v_7)) \in \{(3, 4), (4, 3)\}$. If $\{v_{17}, v_{18}\} \subseteq S$ then v_5 and v_6 are not distinguished, a contradiction. If $\{v_{17}, v_{18}\} \cap S = \emptyset$, then v_4 and v_5 are not distinguished, a contradiction. Therefore, we assume $|\{v_{17}, v_{18}\} \cap S| = 1$; then $dom(v_5) = 4$ to be distinguished from v_6 , requiring $dom(v_7) = 3$. If $v_{20} \in S$ then v_6 and v_7 are not distinguished, a contradiction, so we assume $v_{20} \notin S$; similarly, we can assume $v_{21} \notin S$, requiring $\{v_{22}, v_{23}\} \subseteq S$. If $\{v_{12}, v_{13}\} \subseteq S$ then v_2 and v_3 are not distinguished, a contradiction. If $\{v_{12}, v_{13}\} \cap S = \emptyset$ then $dom(v_2) = 3$, a contradiction. Therefore, we assume $|\{v_{12}, v_{13}\} \cap S| = 1$, providing symmetry with $\{v_{17}, v_{18}\}$. If $v_{18} \notin S$ then v_4 and v_5 are not distinguished, a contradiction, so we assume $v_{18} \in S$, requiring $v_{17} \notin S$; by symmetry $v_{12} \in S$ and $v_{13} \notin S$. Then we require $\{v_{16}, v_{19}\} \subseteq S$ and $\{v_{11}, v_{14}\} \subseteq S$. Finally, $v_{15} \notin S$ because $dom(v_4) = 3$. This gives us Problem Case 1, which will be handled separately.

Otherwise, $\{v_9, v_{10}\} \cap S \neq \emptyset$, and by symmetry $\forall A \in \{\{v_{12}, v_{13}\}, \{v_{17}, v_{18}\}, \{v_{20}, v_{21}\}\}$, $A \cap S \neq \emptyset$. Consider the corner $\{v_1, v_2, v_3\}$: we now know that $sh[v_1 v_2] \leq \max\{\sigma_{35}, \sigma_{44}\}$, and similarly for $sh[v_2 v_3]$. Thus, $sh[v_1 v_2 v_3] \leq \max\{\sigma_{345}, \sigma_{444}\} = \sigma_{345}$. Suppose $sh[v_1 v_2 v_3] \leq \sigma_{444}$, then by symmetry $sh[v_5 v_6 v_7] \leq \sigma_{345}$ and we are done. So we can assume $\exists w \in \{v_1, v_2, v_3\}$ such that $dom(w) = 3$, and by Claims 1 and 2, w is unique. Suppose $w = v_2$, then by Claim 2 we reach a contradiction; without loss of generality let $w = v_1$; then $dom(v_2) \geq 5$ to distinguish from v_1 because $\{v_9, v_{10}\} \cap S \neq \emptyset$. If $dom(v_3) \geq 5$ then we are done, so we assume $dom(v_3) = 4$. If $dom(v_2) \geq 6$ we are done, so we assume $dom(v_2) = 5$. With symmetry we can also assume that $dom(v_6) = 5$, that $(dom(v_5), dom(v_7)) \in \{(3, 4), (4, 3)\}$, and that $dom(v_4) = dom(v_8) = 3$. If $v_9 \in S$ or $v_{24} \in S$ then v_1 and v_8 are not distinguished, a contradiction; thus, $v_9 \notin S$ and $v_{24} \notin S$, requiring $v_{10} \in S$. If $dom(v_7) = 3$ then by symmetry $v_{21} \notin S$ and $v_{22} \notin S$, but we see that v_8 cannot be 3-dominated, a contradiction; therefore $dom(v_7) = 4$, meaning $dom(v_5) = 3$. By symmetry with $\{v_9, v_{10}, v_{24}\}$, we can assume $\{v_{16}, v_{17}, v_{18}\} \cap S = \{v_{18}\}$. If $v_{21} \in S$ then $v_{20} \in S$ to distinguish v_7 from v_8 , however

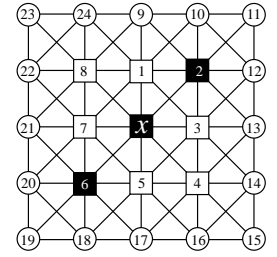

Figure 13:
Diagonal

this results in v_6 and v_7 not being distinguished, a contradiction; thus, we assume $v_{21} \notin S$. Then to 5-dominate v_6 and 3-dominate v_8 we require $\{v_{19}, v_{20}, v_{22}, v_{23}\} \subseteq S$. By symmetry, we can also assume that $v_{13} \notin S$ and $\{v_{11}, v_{12}, v_{14}, v_{15}\} \subseteq S$. This results in Problem Case 2, which will be handled separately.

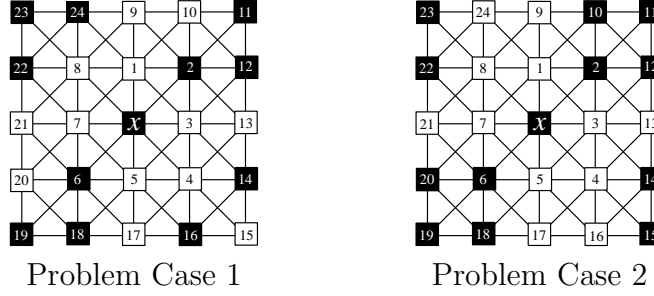

Figure 14: Diagonal problem cases

To handle the first “diagonal” problem case, we consider the share of v_6 . We observe that we need $dom(v_{17}) \geq 5$, $dom(v_{20}) \geq 4$, and $dom(v_{21}) \geq 4$ to distinguish from v_5 , v_6 , and v_7 , respectively. We also see that $\{v_{18}, v_{19}\} \cap D_{4+} \neq \emptyset$ to distinguish from each other. Therefore, $sh(v_6) \leq \frac{1}{5} + \frac{5}{4} + \frac{3}{3} = \frac{49}{20}$. Additionally, the only detectors adjacent to v_6 other than x are v_{18} and v_{19} , which preceding Cases have proven to have share at most $\frac{38}{15}$. Thus, v_6 has no neighboring detectors with share exceeding $\frac{38}{15}$ other than x itself, so it can safely accept $\frac{38}{15} - \frac{49}{20} = \frac{1}{12}$ discharge from x . Therefore, $\widehat{sh}(x) \leq \frac{31}{12} - \frac{1}{12} = \frac{5}{2} < \frac{38}{15}$ and we are done.

To handle the other “diagonal” problem case, we consider the share of v_6 . We observe that we need $dom(v_{17}) \geq 4$ and $dom(v_{21}) \geq 5$ to distinguish from v_7 and v_5 , respectively. We also see that $|\{v_{18}, v_{19}, v_{20}\} \cap D_{5+}| \geq 2$ to be distinguished. Therefore, $sh(v_6) \leq \frac{4}{5} + \frac{3}{4} + \frac{2}{3} = \frac{133}{60}$. Additionally, the only detectors adjacent to v_6 other than x are v_{18} , v_{19} and v_{20} , which preceding Cases have proven to have share at most $\frac{38}{15}$. Thus, v_6 has no neighboring detectors with share exceeding $\frac{38}{15}$ other than x itself, so it can accept $\frac{38}{15} - \frac{133}{60} = \frac{19}{60}$ discharge from x . Therefore, $\widehat{sh}(x) \leq \frac{77}{30} - \frac{19}{60} = \frac{9}{4} < \frac{38}{15}$, completing the diagonal configuration.

Case Wedge: As the last case, we consider when x is dominated by two neighbors in a “wedge” shape, as in Figure 15. We can assume that $\{v_1, v_3, v_5, v_6, v_7, v_8\} \cap S = \emptyset$, as otherwise we fall into previous cases.

First, we observe that $dom(v_3) \geq 5$ to be distinguished from x , and $dom(v_7) \in \{3, 4\}$. If $dom(v_7) = 4$, then $dom(v_6) \geq 5$ is required to be distinguished from v_7 ; by symmetry, $dom(v_8) \geq 5$, so $sh(x) \leq \frac{3}{5} + \frac{1}{4} + \frac{5}{3} \leq \frac{38}{15}$ and we are done. If v_7 is 3-dominated with $\{v_{21}, v_{22}\} \subseteq S$, then we observe that $dom(v_8) \geq 6$ to be distinguished from v_7 , requiring $\{v_9, v_{23}, v_{24}\} \subseteq S$; thus, $dom(v_1) \geq 4$. We also find that $dom(v_6) \geq 4$ to be distinguished from v_7 . Therefore, $sh(x) \leq \frac{1}{6} + \frac{1}{5} + \frac{2}{4} + \frac{5}{3} = \frac{38}{15}$ and we

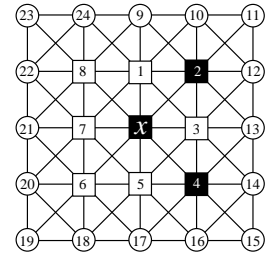

Figure 15: Wedge

are done. By symmetry, we get the same results if v_7 is 3-dominated with $\{v_{20}, v_{21}\} \subseteq S$.

Therefore, we assume v_7 is 3-dominated with $\{v_{20}, v_{22}\} \subseteq S$. We observe that $dom(v_8) \geq 4$ to be distinguished from v_7 ; by symmetry, this is also true for v_6 . Suppose that $v_{19} \notin S$. Then $\{v_{17}, v_{18}\} \subseteq S$ to 4-dominate v_6 , and the only way to distinguish v_5 and v_6 is to have $v_{16} \in S$, so $dom(v_5) = 5$ and $dom(v_4) \geq 4$. Therefore, $sh(x) \leq \frac{2}{5} + \frac{3}{4} + \frac{4}{3} = \frac{149}{60} < \frac{38}{15}$ and we are done; otherwise, we assume $v_{19} \in S$, and by symmetry we also assume $v_{23} \in S$. Next, suppose that $\{v_{18}, v_{24}\} \cap S = \emptyset$, then $v_{17} \in S$ and $v_9 \in S$ to 4-dominate v_6 and v_8 , respectively. We observe that we need $dom(v_2) \geq 5$ to be distinguished from v_1 , and by symmetry $dom(v_4) \geq 5$ as well; thus, $sh(x) \leq \frac{3}{5} + \frac{2}{4} + \frac{4}{3} = \frac{73}{30} < \frac{38}{15}$ and we are done. Otherwise we can assume that $\{v_{18}, v_{24}\} \cap S \neq \emptyset$, and without loss of generality let $v_{18} \in S$; we now consider the two cases depending on whether v_{24} is a detector.

If $v_{24} \notin S$, then $v_9 \in S$ to 4-dominate v_8 and we observe that $dom(v_2) \geq 5$ to be distinguished from v_1 . If $v_{17} \in S$ then $dom(v_6) = 5$ and $dom(v_5) \geq 4$, resulting in $sh(x) \leq \frac{3}{5} + \frac{2}{4} + \frac{4}{3} = \frac{73}{30} < \frac{38}{15}$ and we are done; otherwise we assume $v_{17} \notin S$. If $\{v_1, v_4, v_5\} \cap D_{4+} \neq \emptyset$ then $sh(x) \leq \frac{2}{5} + \frac{3}{4} + \frac{4}{3} = \frac{149}{60} < \frac{38}{15}$ and we are done; thus, we can assume that $\{v_1, v_4, v_5\} \subseteq D_3$. Therefore, $v_{10} \notin S$ and $v_{16} \notin S$ because v_1 and v_5 are 3-dominated, respectively. Suppose $v_{13} \in S$; then $\{v_{14}, v_{15}\} \cap S = \emptyset$ because v_4 is 3-dominated, so we require $v_{12} \in S$ to 5-dominate v_3 . If $v_{11} \in S$ then $dom(v_2) = 6$, resulting in $sh(x) \leq \frac{1}{6} + \frac{1}{5} + \frac{2}{4} + \frac{5}{3} = \frac{38}{15}$ and we are done; otherwise $v_{11} \notin S$ and we arrive at Problem Case 1, which will be handled separately. Otherwise, we consider $v_{13} \notin S$; then $\{v_{12}, v_{14}\} \subseteq S$ to 5-dominate v_3 . This requires $v_{15} \notin S$

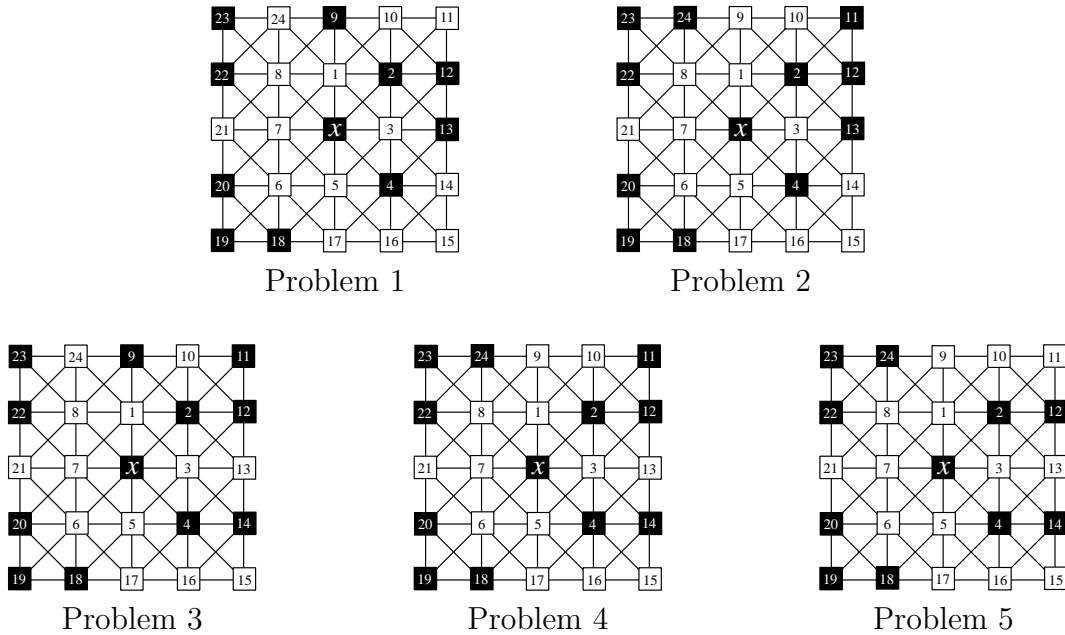

Figure 16: Wedge problem cases

because v_4 is 3-dominated, and $v_{11} \in S$ to 5-dominate v_2 ; this leads to Problem Case 3, which will be handled separately.

We now consider when $v_{24} \in S$. Suppose that $v_9 \in S$; then $dom(v_8) = 5$ and $dom(v_1) \geq 4$. If $dom(v_2) \geq 4$ then $sh(x) \leq \frac{2}{5} + \frac{3}{4} + \frac{4}{3} = \frac{149}{60} < \frac{38}{15}$ and we are done; otherwise, we assume that $dom(v_2) = 3$. Therefore, $\{v_{10}, v_{11}, v_{12}, v_{13}\} \cap S = \emptyset$, however this results in v_1 and v_2 not being distinguished, a contradiction. Therefore, $v_9 \notin S$, and by symmetry $v_{17} \notin S$ as well. By applying the same argumentation, we can also prove that $v_{10} \notin S$, and by symmetry $v_{16} \notin S$ as well. Suppose $v_{13} \in S$. If $dom(v_4) = 3$ then $\{v_{14}, v_{15}\} \cap S = \emptyset$, we require $v_{12} \in S$ to 5-dominate v_3 and $v_{11} \in S$ to distinguish v_2 and v_3 ; this leads to Problem Case 2 and will be handled separately. Otherwise, $dom(v_4) \geq 4$, and by symmetry $dom(v_2) \geq 4$ as well, so $sh(x) \leq \frac{1}{5} + \frac{4}{4} + \frac{4}{3} = \frac{38}{15}$ and we are done. Therefore, we can assume $v_{13} \notin S$; then $\{v_{12}, v_{14}\} \subseteq S$ to 5-dominate v_3 . If $\{v_{11}, v_{15}\} \subseteq S$ then $\{v_2, v_4\} \subseteq D_{4+}$, so we are done; otherwise, without loss of generality we assume $v_{15} \notin S$. If $v_{11} \in S$ then we arrive at Problem Case 4, otherwise we arrive at Problem Case 5; both of these will be handled separately later.

Wedge Problem Case 1: To handle Wedge Problem Case 1 configuration, we consider the maximum share of v_2 ; we will show that $sh(v_2) \leq \frac{37}{15}$. We observe that $dom(v_{13}) \geq 5$ and $dom(v_{10}) \geq 4$ to distinguish from v_3 and v_1 , respectively. If $dom(v_{10}) \geq 5$ then $sh(v_2) \leq \frac{4}{5} + \frac{5}{3} = \frac{37}{15}$ and we are done; otherwise we assume $dom(v_{10}) = 4$. If $\{v_9, v_{11}\} \cap D_{4+} \neq \emptyset$ then we are done; so we assume $\{v_9, v_{11}\} \subseteq D_3$. If $v_{26} \in S$ or $v_{27} \in S$ to 4-dominate v_{10} , then v_{10} and v_{11} are not distinguished, a contradiction. Thus, $v_{25} \in S$, $v_{26} \notin S$, and $v_{27} \notin S$, but we find that v_9 and v_{10} are not distinguished, a contradiction; therefore, $sh(v_2) \leq \frac{37}{15}$. Additionally, v_2 is only adjacent to three detectors other than x , v_9 , v_{12} , and v_{13} . From previous cases, we know that $sh(v_{12}) \leq \frac{38}{15}$ and $sh(v_{13}) \leq \frac{38}{15}$; however, $sh(v_9)$ might exceed $\frac{38}{15}$. Therefore, we conservatively allow v_2 to accept discharge from two sources— x and potentially v_9 —up to $\frac{1}{2} [\frac{38}{15} - \frac{37}{15}] = \frac{1}{30}$ from each. Thus, $\widehat{sh}(x) = \frac{77}{30} - \frac{1}{30} = \frac{38}{15}$ and we are done.

Wedge Problem Case 2: To handle this situation, we look at the share of v_2 . We observe that $sh[v_{10}v_{11}] \leq \sigma_{35}$ to distinguish v_{10} and v_{11} . Therefore, $sh(v_2) \leq \frac{3}{5} + \frac{2}{4} + \frac{4}{3} = \frac{73}{30}$. Additionally, v_2 is only adjacent to v_{11} , v_{12} , v_{13} , which “L” shape and “triangle” Cases have proven to have share at most $\frac{38}{15}$. Thus, v_2 has no neighboring detectors with share exceeding $\frac{38}{15}$ other than x itself, so it can accept $\frac{38}{15} - \frac{73}{30} = \frac{1}{10}$ discharge from x . Therefore, $\widehat{sh}(x) \leq \frac{77}{30} - \frac{1}{10} = \frac{37}{15} < \frac{38}{15}$ and we are done.

Wedge Problem Cases 3, 4, and 5: Consider Problem Cases 3–5, as shown in Figure 16; to handle these cases, we will show that $sh(v_4) \leq \frac{49}{20}$. We observe that $dom(v_{13}) \geq 6$ to distinguish from v_3 ,

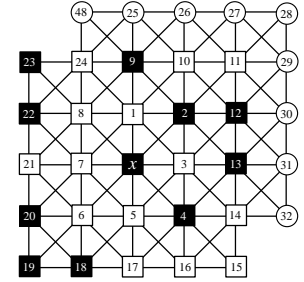

Figure 17: Problem case 1, expanded

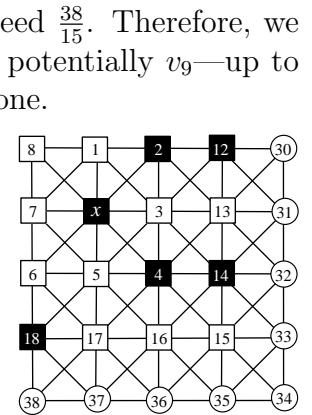

Figure 18: Problems 3–5 common region

$dom(v_{17}) \geq 4$ to distinguish from v_5 . If $\{v_{35}, v_{36}\} \cap S \neq \emptyset$ then we require $sh[v_{15}v_{16}] \leq \max\{\sigma_{36}, \sigma_{45}\} = \sigma_{36}$ to distinguish v_{15} from v_{16} , so $sh(v_4) \leq \frac{49}{20}$ and we are done; thus, we assume $\{v_{35}, v_{36}\} \cap S = \emptyset$, meaning $dom(v_{16}) = 3$, so $dom(v_{15}) \geq 4$. If $dom(v_{14}) \geq 4$ then we will be done, so we assume $dom(v_{14}) = 3$. If $v_{30} \notin S$ or $v_{33} \in S$ then we contradict that $dom(v_{13}) \geq 6$, so we assume $v_{30} \in S$ and $v_{33} \notin S$. Thus, we require $\{v_{32}, v_{34}\} \subseteq S$ to 4-dominate v_{15} , and $v_{31} \notin S$ because $dom(v_{14}) = 3$. We see that v_{14} and v_{15} are not distinguished, a contradiction. Therefore, we have proven that $sh(x_4) \leq \frac{49}{20}$. Additionally, the only detector adjacent to v_4 other than x is v_{14} , which previous cases have shown to have share no more than $\frac{38}{15}$; so v_4 can accept $\frac{38}{15} - \frac{49}{20} = \frac{1}{12}$ discharge from x . Consider Problem Cases 3 and 4: $sh(x) \leq \max\{\frac{157}{60}, \frac{77}{30}\} = \frac{157}{60}$. Then $\widehat{sh}(x) \leq \frac{157}{60} - \frac{1}{12} = \frac{38}{15}$ and we are done. Consider Problem Case 5: $sh(x) = \frac{27}{10}$. By symmetry, we can also discharge up to $\frac{1}{12}$ from x into v_2 , so $\widehat{sh}(x) \leq \frac{27}{10} - 2 \times \frac{1}{12} = \frac{38}{15}$, completing the proof of Theorem 5.1. \square

5.2 Lower bound on RED:LD(K)

Theorem 5.2. *Let $S \subset V(G)$ be a RED:LD set on K . Then, the average share of all vertices in S is at most $\frac{11}{3}$.*

Proof. Let $S \subseteq V(G)$ be a RED:LD set on K , let the notations sh , dom , and k -dominated implicitly use S , and let a vertex pair being *distinguished* denote satisfying the relevant pair property of Theorem 1.2. Let $x \in S$ be a detector vertex; Theorem 1.2 yields that $|N[x] \cap S| \geq 2$. There are two non-isomorphic ways to 2-dominate x , either “vertically” or “diagonally”.

Case Vertical: Consider the “vertical” configuration given in Figure 19. We begin by examining the vertex pair (v_2, v_3) . If $|\{v_2, v_3\} \cap S| = 2$ then $\{x, v_1, v_2, v_3\} \subseteq D_{4+}$, so $sh(x) \leq \frac{4}{4} + \frac{5}{2} < \frac{11}{3}$ and we are done. Next, suppose $|\{v_2, v_3\} \cap S| = 1$, then $\{x, v_1, v_2, v_3\} \subseteq D_{3+}$. If $\{v_7, v_8\} \cap S \neq \emptyset$ then $sh(x) \leq \frac{2}{4} + \frac{2}{3} + \frac{5}{2} = \frac{11}{3}$ and we are done, so we assume $\{v_7, v_8\} \cap S = \emptyset$. We observe that if $\{v_7, v_8\} \subseteq D_2$ then they will not be distinguished, so $dom(v_7) \geq 3$ or $dom(v_8) \geq 3$ and we are done. Lastly, suppose $|\{v_2, v_3\} \cap S| = 0$; by symmetry we can assume that $\{v_7, v_8\} \cap S = \emptyset$ as well. We require $sh[v_2v_3] \leq \max\{\sigma_{33}, \sigma_{24}\}$ to be distinguished; by symmetry, this is also true for $sh[v_7v_8]$. If $dom(v_2) = 2$, then $\{x, v_1\} \subseteq D_{3+}$ and $dom(v_3) \geq 4$ to distinguish from v_2 ; thus $sh(x) \leq \sigma_{24} + \sigma_{24} + \sigma_{33} + \sigma_{222} = \frac{11}{3}$ and we are done. Similarly, we are also done if $dom(v_3) = 2$. Therefore, we can assume $\{v_2, v_3, v_7, v_8\} \subseteq D_{3+}$. If $dom(x) \geq 3$ we are done, so $\{v_4, v_5, v_6\} \cap S = \emptyset$. If $\{v_4, v_5, v_6\} \cap D_{3+} \neq \emptyset$ then we will be done, so we assume $\{v_4, v_5, v_6\} \subseteq D_2$. Vertex v_5 must be 2-dominated by exactly one of v_{16}, v_{17} , or v_{18} . If $v_{16} \in S$

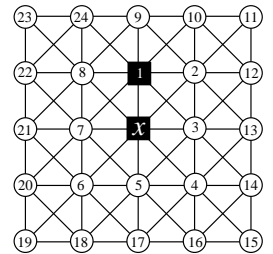

Figure 19:
“Vertical”

or $v_{17} \in S$ then v_4 and v_5 will not be distinguished, a contradiction; otherwise $v_{18} \in S$, but then v_5 and v_6 are not distinguished, a contradiction.

Case Diagonal: Consider the other case for 2-dominating x , the “diagonal” configuration show in Figure 20. We can assume that $\{v_1, v_3, v_5, v_7\} \cap S = \emptyset$, as otherwise we fall into the previous case.

We observe that $sh[v_1v_3] \leq \max\{\sigma_{33}, \sigma_{24}\}$ to be distinguished. Suppose $dom(v_1) = 2$, then $dom(v_3) \geq 4$ to be distinguished. Additionally, $\{x, v_2\} \subseteq D_{3+}$ to be distinguished from v_1 . If $v_6 \in S$ then $sh[v_5v_7] \leq \sigma_{24}$ and we are done; so we assume $v_6 \notin S$. Suppose $v_8 \in S$, then $dom(v_7) \geq 4$ to distinguish from v_1 and we are done; so we assume $v_8 \notin S$. Thus, $v_4 \in S$ to 3-dominate x . If $\{v_4, v_5\} \subseteq D_2$ then they are not distinguished, so $sh[v_4v_5] \leq \sigma_{23}$ and we are done. Therefore, we can assume that $\{v_1, v_3\} \subseteq D_{3+}$. If $v_6 \in S$ then we can assume

$\{v_5, v_7\} \subseteq D_{3+}$, and $dom(x) \geq 3$, so we are done; thus, we assume $v_6 \notin S$. Next, we consider the vertex pair (v_4, v_8) . Suppose $\{v_4, v_8\} \subseteq S$. If $\{v_4, v_5\} \subseteq D_2$ they will not be distinguished, so $sh[v_4v_5] \leq \sigma_{23}$, and by symmetry $sh[v_7v_8] \leq \sigma_{23}$, and we are done. Next, we assume $|\{v_4, v_8\} \cap S| = 1$, and without loss of generality let $v_4 \in S$. We see that $sh[v_4v_5] \leq \sigma_{23}$ to be distinguished. If $\{v_6, v_7, v_8\} \cap D_{3+} \neq \emptyset$ we will be done, so we assume $\{v_6, v_7, v_8\} \subseteq D_2$. Any way to 2-dominate v_7 will result in either (v_7, v_8) or (v_6, v_7) not being distinguished, a contradiction.

Finally, we assume that $\{v_4, v_8\} \cap S = \emptyset$. Suppose $v_{17} \in S$ then $dom(v_4) \geq 3$ and $dom(v_6) \geq 3$ to distinguish from v_5 . If $dom(v_5) \geq 3$ we are done, so we assume $dom(v_5) = 2$, so $\{v_{16}, v_{17}\} \cap S = \emptyset$. Thus, $dom(v_4) \geq 4$ and $dom(v_6) \geq 4$ to distinguish from v_5 , and we are done; so we assume $v_{17} \notin S$, and by symmetry $v_{21} \notin S$. If $dom(v_5) \geq 3$, then $\{v_{16}, v_{18}\} \subseteq S$; we require $dom(v_4) \geq 3$ and $dom(v_6) \geq 3$ to distinguish from v_5 , and we are done, so we can assume $dom(v_5) = 2$, and by symmetry $dom(v_7) = 2$. Suppose $v_{16} \in S$, then $v_{18} \notin S$. We require $dom(v_4) \geq 4$ to distinguish from v_5 . If $v_{22} \in S$ as well, then $v_{20} \notin S$ and we find that $dom(v_8) \geq 4$ to distinguish from v_7 , and we are done; thus, we assume $v_{22} \notin S$, so $v_{20} \in S$ to 2-dominate v_7 . We find that v_6 and v_7 are not distinguished, a contradiction; therefore, we assume $v_{16} \notin S$, and by symmetry $v_{22} \notin S$. Thus, $\{v_{18}, v_{20}\} \subseteq S$, and $dom(v_6) = 4$ with $v_{19} \in S$ to distinguish from v_5 . Suppose $\{v_{12}, v_{13}\} \cap S \neq \emptyset$; then $dom(v_2) \geq 3$. If $dom(v_2) \geq 4$ we are done, so we assume $dom(v_2) = 3$; thus, $\{v_9, v_{10}, v_{11}\} \cap S = \emptyset$. We require $v_{24} \in S$ to 3-dominate v_1 and $dom(v_8) \geq 3$ to distinguish from v_1 , so we are done. Therefore, we can assume $\{v_{12}, v_{13}\} \cap S = \emptyset$. Then $v_{14} \in S$ to 3-dominate v_3 and $dom(v_4) \geq 3$ to distinguish from v_3 , and by symmetry we find $dom(v_8) \geq 3$ as well, completing the proof of Theorem 5.2. \square

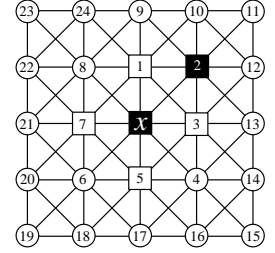

Figure 20: “Diagonal”

Corollary 5.1. $\frac{3}{11} \leq \text{RED:LD}(K)$

Proof of Corollary 5.1 follows directly from Theorem 5.2; thus, $\frac{3}{11} \leq \text{RED:LD}(K) \leq \frac{5}{16}$.

Corollary 5.2. $\frac{3}{11} \leq \text{DET:LD}(K)$

Proof of Corollary 5.2 follows from the observation that by Theorems 1.2 and 1.3, every DET:LD set is a RED:LD set [9]. Thus, $\frac{3}{11} \leq \text{DET:LD}(K) \leq \frac{3}{8}$.

Corollary 5.3. $\frac{15}{38} \leq \text{ERR:LD}(K)$

Proof of Corollary 5.3 follows directly from Theorem 5.1; thus, $\frac{15}{38} \leq \text{ERR:LD}(K) \leq \frac{7}{16}$.

Conjecture 5.1. $\frac{15}{44} \leq \text{DET:LD}(K)$

We believe Conjecture 5.1 can be proven using similar techniques and the discharging strategy introduced in Subsection 4.1. It may be possible to prove higher lower bounds for RED:LD(K) and ERR:LD(K). We are currently exploring other possible approaches, but we conjecture that any higher value must use either more advanced discharging techniques or expand further from the center vertex, x .

References

- [1] CHARON, I., HUDRY, O., AND LOBSTEIN, A. Identifying codes with small radius in some infinite regular graphs. *Electronic Journal of Combinatorics* 9, R11 (2002).
- [2] DANTAS, R., HAVET, F., AND SAMPAIO, R. M. Minimum density of identifying codes of king grids. *Discrete Mathematics* 341, 10 (2018), 2708–2719.
- [3] FOUCAUD, F., LAIHONEN, T., AND PARREAU, A. An improved lower bound for $(1, \leq 2)$ -identifying codes in the king grid. *Advances in Mathematics of Communications* 8 (2014), 35–52.
- [4] HONKALA, I., AND LAIHONEN, T. On locating-dominating sets in infinite grids. *European Journal of Combinatorics* 27, 2 (2006), 218–227.
- [5] HONKALA, I., AND LAIHONEN, T. On identifying codes in the king grid that are robust against edge deletions. *Electronic Journal of Combinatorics* 15, R3 (2008).
- [6] JEAN, D. C., AND SEO, S. J. Fault-tolerant detection systems on the king’s grid. In review.
- [7] JEAN, D. C., AND SEO, S. J. Fault-Tolerant Locating-Dominating Codes with Error-correction. In review.

- [8] JEAN, D. C., AND SEO, S. J. On Redundant Locating-Dominating Sets. In review.
- [9] JEAN, D. C., AND SEO, S. J. Progress on Fault-tolerant Locating-Dominating Set. In review.
- [10] JEAN, D. C., AND SEO, S. J. Optimal Error-Detecting Open-Locating-Dominating Set on the Infinite Triangular Grid. *Discussiones Mathematicae: Graph Theory (in press)* (2021).
- [11] KARPOVSKY, M. G., CHAKRABARTY, K., AND LEVITIN, L. B. On a new class of codes for identifying vertices in graphs. *IEEE transactions on information theory* 44, 2 (1998), 599–611.
- [12] KINCAID, R., OLDHAM, A., AND YU, G. Optimal open-locating-dominating sets in infinite triangular grids. *Discrete Applied Mathematics* 193 (2015), 139–144.
- [13] LOBSTEIN, A. Watching Systems, Identifying, Locating-Dominating and Discriminating Codes in Graphs. <https://www.lri.fr/~elobstein/debutBIBidetlocdom.pdf>.
- [14] PELTO, M. *On identifying and locating-dominating codes in the infinite king grid*. PhD thesis, University of Turku, 2012.
- [15] SEO, S. Open-locating-dominating sets in the infinite king grid. *Journal of Combinatorial Mathematics and Combinatorial Computing* 104 (2018), 31–47.
- [16] SEO, S., AND SLATER, P. Fault tolerant detectors for distinguishing sets in graphs. *Discussiones Mathematicae Graph Theory* 35 (2015), 797–818.
- [17] SEO, S. J., AND SLATER, P. J. Open neighborhood locating dominating sets. *Australas. J Comb.* 46 (2010), 109–120.
- [18] SLATER, P. J. Domination and location in acyclic graphs. *Networks* 17, 1 (1987), 55–64.
- [19] SLATER, P. J. Dominating and reference sets in a graph. *J. Math. Phys. Sci* 22, 4 (1988), 445–455.
- [20] SLATER, P. J. Fault-tolerant locating-dominating sets. *Discrete Mathematics* 249, 1-3 (2002), 179–189.