

TOPOLOGICAL QUANTUM COMPUTATION IS HYPERBOLIC

ERIC SAMPERTON

ABSTRACT. We show that a topological quantum computer based on the evaluation of a Witten-Reshetikhin-Turaev TQFT invariant of knots can always be arranged so that the knot diagrams one compiles are hyperbolic. Furthermore, the diagrams can be arranged to have additional nice properties, such as being alternating with minimal crossing number. Various complexity-theoretic hardness results regarding the calculation of quantum invariants of knots follow as corollaries. In particular, we argue that the hyperbolic geometry of knots is unlikely to be useful for topological quantum computation.

1. INTRODUCTION

Topology, quantum computing, and condensed matter theory have had significant interactions in recent decades, one of the most notable being topological quantum computation. Freedman, Kitaev, Larsen and Wang established this quantum computing paradigm by showing that there exist unitary topological quantum field theories (TQFTs) based on evaluations of the Jones polynomial at roots of unity for which certain approximations of knot and link invariants are equivalent in power to the usual quantum circuit model of BQP [FLW02a, FLW02b, FKW02]. On the other hand, topology and geometry—especially *hyperbolic* geometry—also have significant interactions in low dimensions, thanks to pioneering work of Thurston and countless others. Moreover, there are various conjectural relationships expected to connect the hyperbolic geometry of a knot with its TQFT invariants, the volume conjecture of Kashaev, Murakami and Murakami being perhaps the most infamous [Kas95, MM01].

Idly combining these various lines of thought leads to a question: Can the hyperbolic geometry of knots be used as a resource to speed-up topological quantum computations?

1.1. Main results. We argue *no*. To this end, we first show that any topological quantum computation can be arranged so that all of the knots one uses to perform quantum calculations are guaranteed to be hyperbolic knots, a fact we might glibly call “hyperbolic quantum computation.”¹ In mathematical terms, we show that for any fixed Witten-Reshetikhin-Turaev TQFT invariant of ribbon knots Z , there is a polynomial time algorithm that replaces a given knot diagram K with a particularly nice kind of diagram of a hyperbolic knot K' so that $Z(K)$ and $Z(K')$ are essentially equal. In fact, we have in mind two different ways in which a diagram can be “particularly nice,” and our first two results make each of them precise.

Theorem 1. *Fix a semisimple modular category \mathcal{C} and an object V with twist θ . Let Z be the Witten-Reshetikhin-Turaev invariant of oriented ribbon knots colored by V . Then there exists a polynomial time algorithm that converts a given oriented ribbon knot diagram K into a diagram K' such that*

$$Z(K') = \theta^{r(K)} Z(K)$$

where $r(K)$ is a polynomial-time computable integer, and K' has the follow additional properties:

- K' is alternating,
- K' has minimal crossing number (over all diagrams of equivalent knots), and
- K' is a hyperbolic knot.

Date: January 6, 2022.

Supported in part by NSF grant DMS #2038020. smprtn@illinois.edu.

¹To be clear, we have in mind a strict notion of “topological quantum computation” along the lines of the original papers [FLW02a, FLW02b, FKW02] that means “approximate a TQFT invariant of a knot or link inside a 3-manifold.” There are now more wide-ranging ideas of topological quantum computation that allow for invariants of colored, trivalent ribbon graphs (meaning projective measurements are performed during the computation), or even adaptive measurements (in which the amplitudes with which one computes are not exactly topological invariants of 3-dimensional objects). We shall make no attempt to address these broader paradigms.

Theorem 2. Fix a semisimple modular category \mathcal{C} and an object V . Let Z be the Witten-Reshetikhin-Turaev invariant of oriented ribbon knots colored by V . Then there exists a classical polynomial time algorithm that converts a given oriented ribbon knot diagram K into a diagram K' such that $Z(K') = Z(K)$, and K' has the following additional properties:

- K' is in bridge position,
- the distance of the induced bridge sphere of K' is known,
- the bridge number $b(K')$ of K' is minimal (over all diagrams of equivalent knots) and the induced bridge sphere of K' is the unique minimal bridge sphere (up to isotopy), and
- K' is a hyperbolic knot.

For discussion of why it is helpful to know either the crossing number or bridge number of a knot, see the last paragraph of Section 1.2. We conjecture that there exists a single reduction that builds a knot K' with a combination of *all* of the properties in both Theorems 1 and 2.

Complexity-theoretic hardness results—both quantum and classical—follow from Theorems 1 and 2 as an easy corollary. Roughly speaking, each theorem implies that whenever a Witten-Reshetikhin-Turaev invariant Z is known to be hard to compute (or approximate) on knots, then the same hardness result persists even on the restricted class of nice knot diagrams indicated. We list some concrete applications of this principle here:

Corollary 3. Fix $i = 1$ or 2 . Let K be a diagram of a knot in S^3 , treated as computational input, and suppose as a promise that K satisfies all of the listed properties in the conclusion of Theorem i . Then each of the following previously known hardness results continues to hold for such restricted diagrams:

- (1) Fix a principal root of unity t that is not of order $1, 2, 3, 4$ or 6 , and let $V(K, t)$ be the value of the Jones polynomial of K at t . Then it is BQP-hard to “additively approximate” the complex number $V(K, t)$. More precisely, given a quantum circuit C over some fixed, finite gate set and a fixed error $\varepsilon > 0$, there is a classical polynomial time reduction that encodes C as a knot diagram K_C such that

$$\left| \mathbb{P}(C \text{ accepts on } \vec{0}) - \left| \frac{V(K_C, t)}{(t^{1/2} + t^{-1/2})^{b(K_C) - 1}} \right|^2 \right| < \varepsilon \quad (\star)$$

- (2) Fix a principal root of unity t that is not of order $1, 2, 3, 4$ or 6 . Let $0 < a < b$ be two positive real numbers, and assume as a further promise that either $|V(K, t)| < a$ or $|V(K, t)| > b$. Then it is #P-hard, in the sense of Cook-Turing reduction, to decide which inequality holds.
- (3) Fix a nonabelian finite simple group G and a non-trivial conjugacy class $C \subset G$. Orient K and let $\gamma \in \pi_1(S^3 - K)$ be a meridian. Then it is #P-hard, via almost parsimonious reduction, to compute

$$\#H(K, G, C) \stackrel{\text{def}}{=} \#\{\phi : \pi_1(S^3 - K) \rightarrow G \mid \phi(\gamma) \in C\}.$$

In particular, deciding when $\pi_1(S^3 - K)$ admits a homomorphism to G with non-cyclic image and γ mapping to C is NP-hard.

If we were to remove the listed promises on the diagram K , then parts (1), (2), and (3) in Corollary 3 are almost verbatim the main results of [FLW02b], [Kup15], and [KS21], respectively. The only difference is that [FLW02b] proves the BQP-hardness of additively approximating $V(K, t)$ for *links* K , while [Kup15] improves their result to *knots* K . Kuperberg [Kup15, Sec. 5.1] conjectured that his results should hold for atoroidal knots. Part (2) of Corollary 3 confirms this conjecture, because hyperbolic knots are atoroidal.

In particular, our results show that when a knot invariant can be used for universal quantum computation, then hyperbolic geometry can not generally be expected to be helpful for achieving significant qualitative improvements in the calculation of such invariants without violating various standard conjectures such as $\text{BQP} \neq \text{P}$ or $\text{P}^{\#\text{P}} \neq \text{P}$. This justifies our claim that hyperbolic geometry is not useful for algorithmic purposes in topological quantum computation.

We now turn to three additional take-aways from our results.

1.2. Additional take-aways. First, there is a subtle proviso we should make about the phrase “ K is hyperbolic,” which stems from the fact that promises do not come with certificates. Namely, when we say K is promised to be a hyperbolic knot, this does not mean we necessarily have a description of a hyperbolic structure on its complement in hand, say, as an ideal triangulation equipped with an algebraic solution to Thurston’s gluing equations. Rather, the diagram K will satisfy an easily-verified combinatorial condition that indirectly guarantees its hyperbolicity by

combining work of Johnson and Moriah [JM16] with Thurston’s hyperbolization theorem. So it is still conceivable that a more explicit description of a hyperbolic structure could be exploited, for example, to decide if a hyperbolic knot’s fundamental group admits a non-trivial homomorphism to the alternating group A_5 in polynomial time. We consider this unlikely, since if this were the case then by part 3 of Corollary 3 either computing hyperbolic structures on hyperbolic knots is NP-hard, or $P = NP$. Instead, we conjecture that the diagrams of hyperbolic knots that we construct all admit geometric triangulations constructible in polynomial time. Recent work of Ham and Purcell lends further evidence to this conjecture [HP21].

Second, while we already have argued that hyperbolic geometry is not useful for algorithmic purposes in topological quantum computation, we note that we also have low expectations regarding the possibility of useful applications of “hyperbolic quantum computation” to the subject of (quantum) circuit complexity. One reason is that there exist large quantum circuits that implement the same unitary as the trivial circuit, and our reduction sends these “complicated-but-trivial” circuits to highly non-trivial knots. This means the hyperbolic geometry of the encoding knot (more specifically, its volume) can not be used to derive lower bounds on circuit complexity, only upper bounds.

Third, from the perspective of practical algorithmic topology the most important part of Theorem 1 is the promise that K' has minimal crossing number. Likewise, the most important part of Theorem 2 is the promise that K'' has minimal bridge number. Indeed, a common strategy when computing an invariant of a knot from a diagram K is to first perform some heuristic preprocessing that replaces K with a simpler diagram K' of the same knot. Depending on the specifics of the implementation, the diagram K' might be simpler because it has smaller crossing number than K , or it might be “thinner” in various senses (e.g. smaller bridge number or tree width). This strategy is often quite useful in practice, and results on the role of parameterized complexity in knot theory give some sense of the reasons why [BMS18]. However, unfortunately, Theorem 1 implies that even with oracle access to a blackbox that replaces an input diagram with an equivalent minimal crossing diagram, computing a TQFT invariant still typically has #P-hard worst case complexity. Theorem 2 provides a similar conclusion for oracle access to a blackbox that replaces a diagram with an equivalent minimal bridge number diagram.

1.3. Related results. In a related vein, our results and their proof complement the ideas of Cui, Freedman and Wang in [Fre09, CFW16]. These papers begin with the observation that for a TQFT invariant of knots there exist, in addition to the usual Reidemeister moves, more severe diagrammatic simplifications one can make that change the topology of the knot represented by the diagram but nevertheless preserve the value of the invariant. So, one might try to perform a similar simplification strategy as in the previous paragraph using this larger set of moves. The main result of [CFW16] builds on the ideas of [Fre09] to show that if the separation conjecture $BQP \not\subseteq NDQC1$ holds, then polynomially many applications of the simplifying moves can not always effect linear simplifications of diagrams.

Finally, we note that the early work [JW90] of Jaeger, Vertigan and Welsh shows that exact calculation of the value of the Jones polynomial at any t that is not a root of unity of order 1, 2, 3, 4, or 6 is #P-hard for alternating links. They prove their result by first establishing hardness results for evaluations of the Tutte polynomial of planar graphs. Then they identify planar graphs with alternating diagrams of links via the Tait/checkerboard graph construction, and exploit elementary identities between the Tutte polynomial of the Tait graphs and the Jones polynomials of the associated link diagrams. While their result does not make any promises about crossing number, hyperbolicity, having only one component, *etc.*, we can imagine a strengthening of their result along these lines with a proof that builds on their techniques. However, we believe our proof is conceptually much simpler, essentially only requiring Vafa’s theorem for modular tensor categories. In particular, our technique generalizes to arbitrary Witten-Reshetikhin-Turaev invariants of knots and can be “plugged into” different kinds of hardness results in a blackbox fashion.

1.4. Notation caveats. We warn the reader that we regularly abuse notation by letting K denote both a knot and a diagram of that knot. It should always be clear in context which we mean (almost always the latter). “Crossing number” will always mean crossing number of a diagram. We may also abuse language by saying “knot” when strictly speaking, in the context of Witten-Reshetikhin-Turaev invariants, we ought to consider *ribbon* knots. To rectify this, we use the blackboard framing.

Acknowledgements. We thank Chris Leininger for many helpful conversations about curve complexes. We also thank Colleen Delaney for very helpful feedback on early drafts of this work.

2. KNOT DIAGRAMS AND HYPERBOLIC GEOMETRY

A knot K in the 3-sphere S^3 is *hyperbolic* if there exists a complete hyperbolic structure on its complement $S^3 \setminus K$. Such a structure can be described explicitly either by finding a triangulation of $S^3 \setminus K$ together with a solution to Thurston’s gluing equations, or by finding a discrete and faithful representation $\pi_1(S^3 \setminus K) \rightarrow \mathrm{PSL}(2, \mathbb{C})$. As mentioned in Section 1.2, explicit descriptions of hyperbolic structures are not necessary for our purposes. Thanks to the central role of both knots and hyperbolic geometry throughout 3-manifold topology, there is an extensive literature on the problem of converting combinatorial properties of a knot diagram to hyperbolic geometric properties of the knot. We make no attempt to summarize this large body of work, but focus on two well-studied such combinatorial properties: alternating diagrams, and the *bridge distance* of a plat diagram. Nothing in this section is new, and ribbon framings play no role.

2.1. Alternating diagrams and Menasco’s theorem. A crossing in a knot diagram is called *nugatory* if it looks like

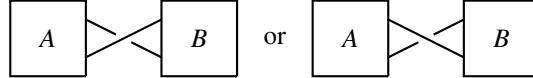

where A and B are tangle sub-diagrams. One of the Tait conjectures, independently proved by Kauffman [Kau87], Murasugi [Mur87] and Thistlethwaite [Thi87] (all using the Jones polynomial!), says that an alternating link diagram has minimal crossing number whenever it has no nugatory crossings. A single nugatory crossing can be found and removed in time quadratic in the crossing number of L , so removing all of them takes at most cubic time. This proves:

Lemma 4. *An alternating link diagram L can be reduced to a minimal crossing alternating diagram in polynomial time.*

Call a knot or link diagram *reduced* if all nugatory crossings have been removed as above. Menasco proved in [Men84] that reduced alternating diagrams of knots are either trivial, $(2, p)$ torus knots, or hyperbolic. By the solution to the Tait flying conjecture [MT93], a $(2, p)$ torus knot has a unique minimal crossing alternating diagram. We summarize these observations in the following lemma.

Lemma 5. *Any minimal crossing alternating knot diagram is either the trivial unknot diagram, the unique minimal crossing alternating diagram of a $(2, p)$ torus knot (in particular, p is odd and $|p| \geq 3$), or a hyperbolic knot.*

2.2. Plat diagrams and bridge distance. For any knot K in S^3 , a *bridge sphere* Σ is an embedded 2-sphere in S^3 such that K intersects both sides of Σ in a trivial tangle. That is, a bridge sphere Σ of K cuts S^3 into two closed balls V and W such that:

- $V \cap W = \Sigma$,
- $K \cap \Sigma$ is $2m$ points for some positive integer m ,
- $K \cap V$ can be ambiently isotoped rel Σ into Σ ,
- $K \cap W$ can be ambiently isotoped rel Σ into Σ .

Define

$$\Sigma_K \stackrel{\text{def}}{=} \Sigma \setminus K, \quad V_K \stackrel{\text{def}}{=} V \setminus K, \quad \text{and} \quad W_K \stackrel{\text{def}}{=} W \setminus K.$$

The decomposition

$$S^3 \setminus K = V_K \bigsqcup_{\Sigma_K} W_K$$

is called a *bridge decomposition* of $S^3 \setminus K$, and m is called the *bridge number* of the bridge decomposition. Bridge decompositions of knots are knot-theoretic analogs of Heegaard splittings of closed, orientable 3-manifolds.

A diagram K in the xy -plane is in *bridge position* if, with respect to the y coordinate, all local maxima of the diagram occur above all local minima. A knot diagram in bridge position encodes an obvious bridge sphere by horizontally slicing through the thickest part. More precisely, suppose the diagram K lies in the xy -plane, considered as a subset of \mathbb{R}^3 equipped with the usual coordinates x, y, z , and let S^3 be \mathbb{R}^3 together with a point at infinity ∞ . Let $y = c$ be any plane that cuts K so that the minima and maxima of K are on opposite sides. Then $\Sigma = \{y = c\} \cup \{\infty\}$ is a bridge sphere for K . We call Σ an *induced bridge sphere* of the bridge diagram. The bridge number of Σ equals the number of local minima (equivalently, maxima) in the diagram K . If an induced bridge sphere Σ of the bridge diagram K has bridge number m , then we say K is an *m -bridge diagram*. Every knot-bridge sphere pair can be ambiently isotoped so the bridge sphere is an induced bridge sphere of a bridge diagram.

Our interest is mainly in bridge diagrams of a specific type. We say a diagram K is in m -plat position if:

- K is in m -bridge position,
- all of the local maxima of K occur above all of the crossings, and
- all of the local minima of K occur below all of the crossings.

The *plats* of the diagram are the arcs where minima or maxima occur. Every diagram in plat position determines two sets of plats, the *top plats* and the *bottom plats*, each of which is equivalent to a planar matching of $2m$ points.

We shall arrange all of our plat diagram into *rows*, which are tangle subdiagrams of the form

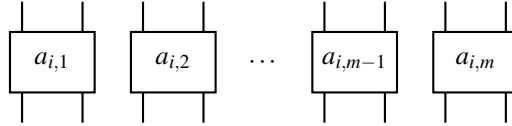

if i is even, or

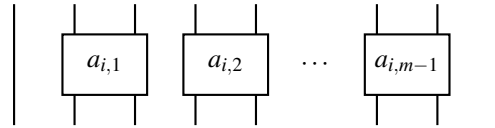

if i is odd. Each box is called a *twist region*, and is labeled by an integer $a_{i,j} \in \mathbb{Z}$ called a *twist coefficient* that indicates a number of half-twists, e.g.

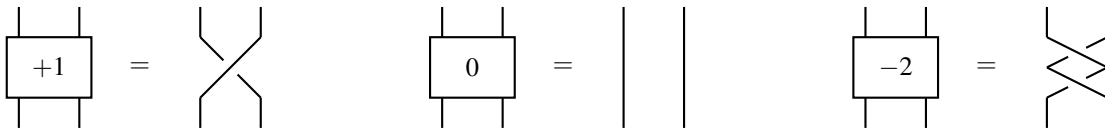

For a typical m -plat diagram, many of the twist coefficients $a_{i,j}$ may equal 0. An m -plat diagram with an even number of rows is *standard* if the top plats form this planar matching:



and the bottom plats form this one:



When an m -plat diagram has an odd number of rows, it is *standard* if the bottom plats are as above, but the top plats form this planar matching:



See Figures 1 and 2. Finally, we say an m -plat diagram is *highly twisted* if it is standard and $|a_{i,j}| \geq 3$ for all i and j .

Suppose Σ is a bridge sphere for a knot K . The *curve graph* $\mathcal{C}(\Sigma_K)$ of Σ_K is the infinite simplicial graph defined as follows:

- the vertices of $\mathcal{C}(\Sigma_K)$ are the isotopy classes $[\gamma]$ of simple closed curves $\gamma \subset \Sigma_K$ that are non-trivial and non-peripheral (meaning γ bounds neither a disk nor a once-punctured disk in Σ_K), and
- two vertices $v_1 \neq v_2$ of $\mathcal{C}(\Sigma_K)$ are connected by an edge if and only if $v_1 = [\gamma_1]$ and $v_2 = [\gamma_2]$ where $\gamma_1 \cap \gamma_2 = \emptyset$.

If v_1 and v_2 are two vertices of $\mathcal{C}(\Sigma_K)$, we let $d(v_1, v_2)$ denote their distance from one another with respect to the combinatorial path metric on $\mathcal{C}(\Sigma_K)$. More generally, if A and B are two subsets of the vertex set of $\mathcal{C}(\Sigma_K)$, we define

$$d(A, B) \stackrel{\text{def}}{=} \min\{d(a, b) \mid a \in A, b \in B\}.$$

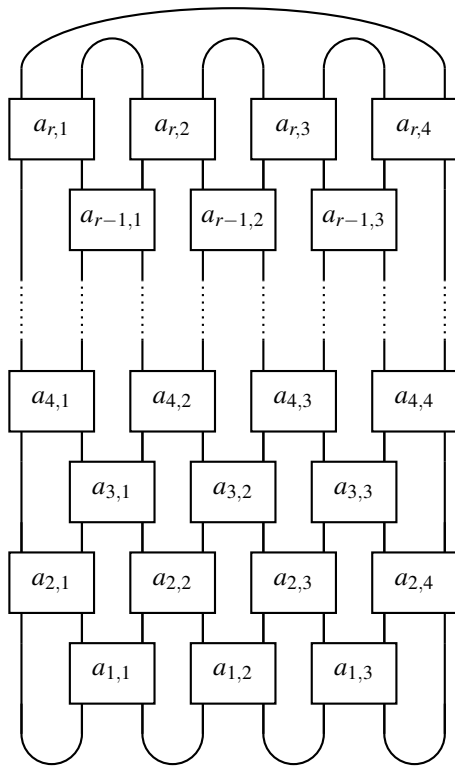

FIGURE 1. A standard 4-plat diagram with an even number of rows.

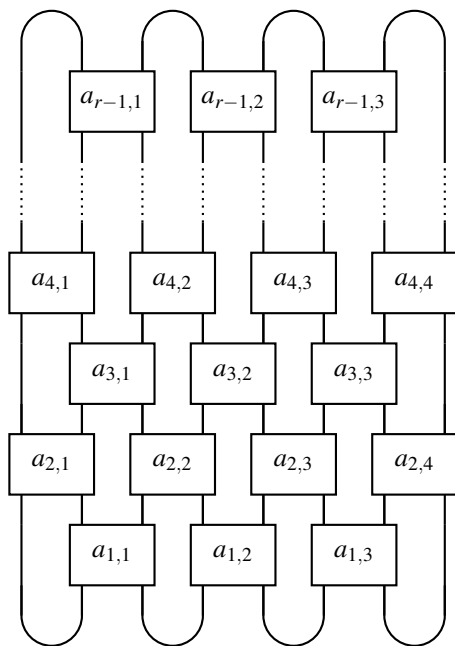

FIGURE 2. A standard 4-plat diagram with an odd number of rows.

Computing or bounding the distance between various subsets of curve graphs is a basic and important problem in combinatorial topology, as the following exemplifies.

Let $[\gamma]$ be a vertex of $\mathcal{C}(\Sigma_K)$. We say $[\gamma]$ *bounds a disk* in V_K if there exists a properly embedded disk $D \subset V_K$ with $\partial D = \gamma$. Let $\mathcal{D}(V_K)$ denote the *disk set* of V_K consisting of all vertices in $\mathcal{C}(\Sigma_K)$ that bound a disk in V_K . Likewise, $\mathcal{D}(W_K)$ denotes the disk set of W_K . The *distance* of the bridge decomposition of K by Σ is

$$d(K, \Sigma) \stackrel{\text{def}}{=} d(\mathcal{D}(V_K), \mathcal{D}(W_K)).$$

We refer the reader to [BS05, Tom07, JM16] for much more information about bridge distance.² We summarize everything we need with the following mega-proposition.

Proposition 6 (After Johnson and Moriah [JM16, Thm. 1.2]). *If K is a highly twisted standard m -plat link diagram with n rows where $m \geq 3$ and $n > 4m(m-2)$ then the following hold:*

- (1) *the distance of the induced bridge sphere Σ is $d(K, \Sigma) = \lceil n/(2(m-2)) \rceil$,*
- (2) *the bridge number m is minimal (over all diagrams of equivalent links) and the induced bridge sphere of K is the unique minimal bridge sphere (up to isotopy), and*
- (3) *K is a hyperbolic link.*

Proof. (1) This is the conclusion of [JM16, Thm. 1.2], which holds without the assumption $n > 4m(m-2)$.
(2) The assumptions on m and n imply $d(K, \Sigma) > 2m$, so Tomova’s work [Tom07] shows Σ is the unique minimal bridge sphere of K .
(3) Since $d(\Sigma) > 2$, K is prime, atoroidal, and an-annular. Thus K is hyperbolic by Thurston’s hyperbolization theorem. (The same argument is found in the proof of [BS05, Cor. 6.2], for example.) \square

3. PROOFS

The proofs of Theorems 1 and 2 use the same basic idea. Given a knot diagram K , we pad it by inserting additional crossings in the diagram. The result is another diagram K' of a different knot, but if we pad with an appropriate number of crossings in a row (see Vafa’s theorem, Lemma 7 below), then we can guarantee $Z(K) = Z(K')$. If we perform this kind of padding in enough places, and also use some other tricks, then we can apply the results of Section 2 to build K' and K'' with the desired properties in the conclusions of the two theorems.

3.1. Braiding exponents in semisimple modular categories. Given a pair of objects V, W in a modular category \mathcal{C} , define the *braiding exponent* $e(V, W)$ to be the order of the “squared braiding” morphism $br_{V,W}^2 \stackrel{\text{def}}{=} br_{W,V} \circ br_{V,W}$. Vafa’s theorem says $e(V, W)$ is a well-defined integer.

Lemma 7 (Vafa’s theorem [Vaf88], see also [AM88, Eti02]). *In any $(2+1)$ -dimensional Witten-Reshetikhin-Turaev TQFT determined by a semisimple modular category, the square of the braiding of any two objects is a finite order linear map.*

3.2. Proof of Theorem 2. Theorem 2 follows immediately by combining the following result with Proposition 6.

Proposition 8. *Fix a semisimple modular category \mathcal{C} and an object V . Let Z be the Witten-Reshetikhin-Turaev invariant of oriented ribbon knots colored by V . Then there exists a classical polynomial time algorithm that converts an oriented ribbon knot diagram K into an alternating and highly twisted standard m -plat ribbon diagram K'' with $Z(K'') = Z(K)$ and $n = 2k$ rows, where $m \geq 3$ and $n > 4m(m-2)$.*

Proof. Using Vafa’s theorem, we fix an even constant $2T > 0$ (depending on \mathcal{C} and V) such that adding a string of $2T$ crossings (all with the same sign) anywhere in a diagram produces a new knot diagram with the same Z invariant. That is, we pick T so that

$$Z\left(\text{---}\right) = Z\left(\boxed{\pm 2T}\right).$$

Let $K = K_0$ be our initial (oriented, ribbon) knot diagram. We reduce it to K'' in two steps.

First, if necessary, we apply a sequence of Reidemeister 1 and 2 moves to K_0 to get a regularly isotopic diagram K_1 that is a standard m -plat diagram where $m \geq 3$, and the number of rows n is greater than $4m(m-2)$. In detail, let m be the number of local maxima in K_0 (which equals the number of local minima) with respect to some preferred

²Note that the first reference uses a slightly different (but equivalent) definition of distance. Our definition follows [Tom07] and [JM16].

coordinates on the diagram plane. If $m < 3$, then introduce a pair of Reidemeister 1 moves whose framings cancel (recall from Section 1.4 that we use the blackboard framing). The result will have $m \geq 3$. Now apply a sequence of Reidemeister 2 moves to make a standard m -plat diagram. Since we are not requiring K_1 be highly twisted, if necessary, we introduce twist regions with coefficients $a_{i,j} = 0$ to ensure that $n > 4m(m-2)$. Since K_1 is regularly isotopic to K_0 , $Z(K_1) = Z(K_0)$. This step takes quadratic time in the crossing number of K_0 .

Second, we add additional twists to K_1 in order to get a highly twisted alternating diagram. Let the twist coefficients of K_2 be $a_{i,j}$. Build K_2 by replacing each $a_{i,j}$ in K_2 with $a'_{i,j}$ as follows:

$$a'_{i,j} = \begin{cases} a_{i,j} + 2T & \text{if } a_{i,j} \geq 0, \\ a_{i,j} - 2T & \text{otherwise.} \end{cases}$$

This step takes a linear amount of time in the crossing number of K_1 (if $a_{i,j} = 0$, we still count it as a single ‘‘crossing’’).

Let $K'' = K_2$. It is evident from the construction that K'' has the same number of plats and rows as K_2 , and the assumption $2T > 2$ guarantees $|a'_{i,j}| \geq 3$ for all i, j . Therefore, K'' is a highly-twisted standard m -plat with n rows where $m \geq 3$ and $n > 4m(m-2)$. Of course, by Vafa’s theorem,

$$Z(K'') = Z(K_2) = Z(K_1) = Z(K_0) = Z(K).$$

The entire procedure taking K to K'' takes quadratic time. □

3.3. Proof of Theorem 1. As before, fix an even constant $2T > 2$ (depending on \mathcal{C} and V) such that adding $2T$ crossings anywhere in the diagram produces a new knot diagram with the same Z invariant.

Let K be our initial diagram. We must describe a polynomial time algorithm that builds a diagram K' that is alternating, has minimal crossing number, is hyperbolic, and satisfies

$$Z(K') = \theta^{r(K)} Z(K)$$

for some polynomial time computable function $r(K)$. We perform the reduction in two steps, with a conditional third step. Let $K_0 = K$.

First, we alter some of the crossings of K_0 in order to get an alternating diagram K_1 with $Z(K_1) = Z(K_0)$. This is performed as follows. If K_0 is not alternating, then in linear time we may identify a nonempty set of crossings v_1, v_2, \dots, v_k such that reversing them yields an alternating diagram. However, doing this reversal will not necessarily preserve Z (unless $T = 1$). Instead, for each of the positive crossings that need to be made negative, we replace them with $2T - 1$ negative crossings, and vice versa for negative crossings that need to be made positive. The resulting diagram K_2 is an alternating knot diagram, and each of these crossing replacements can be understood in two steps: insert $2T$ additional twists in the opposite direction, then apply a Reidemeister 2 move. Thus $Z(K_1) = Z(K_0)$. This entire padding process takes linear time.

Second, we use Lemma 4 to reduce K_1 to a minimal crossing alternating diagram K_2 in polynomial time. The removal of each nugatory crossing in the reduction algorithm changes the writhe of K_1 by ± 1 . If we let $r'(K)$ be the total change in the writhe $w(K_2) - w(K_1)$, then

$$Z(K_2) = \theta^{w(K_2) - w(K_1)} Z(K_1) = \theta^{r'(K)} Z(K).$$

Clearly $r'(K)$ is computable in polynomial time from K .

Finally, by Lemma 5, K_2 is either hyperbolic, the unique minimal crossing alternating diagram of a $(2, p)$ torus knot for some odd p , or the trivial unknot diagram. We can recognize whether either of the latter two possibilities holds in linear time.

If K_2 is hyperbolic (this is by far the likeliest outcome), then we let $K' = K_2$ and $r(K) = r'(K)$.

If K_2 is the minimal crossing alternating $(2, p)$ torus knot diagram, then we use the Vafa padding trick and Proposition 6 as in Section 3.2 to build a highly twisted alternating knot K_3 that has no nugatory crossings, satisfies the conditions of Proposition 6 necessary to guarantee it is hyperbolic, and has $Z(K_3) = \theta \cdot Z(K_2)$. Indeed, if $p > 0$, pick any one of the diagrams as in Figure 3 with at least $n > 4 \times 3(3-2) = 12$ rows. If $p < 0$, do the same, but switch all of the signs in the picture. This reduction works in linear time in p . Now let $K' = K_3$ and $r(K) = r'(K) + 1$.

If K_2 is the trivial unknot diagram, then by similar reasoning setting $p = 2T + 1$ in Figure 3 and choosing one of such diagram with $n > 12$ rows yields an alternating hyperbolic knot diagram K_3 with no nugatory crossings and $Z(K_3) = \theta^2 Z(K_2)$ for some polynomial time $r''(K)$. Let $K' = K_3$ and $r(K) = r'(K) + 2$. □

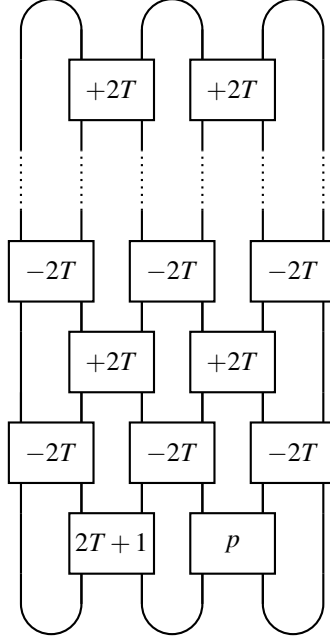

FIGURE 3. Padding torus knots so they become alternating and hyperbolic.

3.4. Proof of Corollary 3. Let $Z(-)$ be any one of the invariants considered in Corollary 3. So, for example, we could have $Z(-) = V(-, e^{2i\pi/7})$ or $Z(-) = \#H(-, A_5, (1\ 2\ 3\ 4\ 5)^{A_5})$ where $(1\ 2\ 3\ 4\ 5)^{A_5}$ is the conjugacy class of $(1\ 2\ 3\ 4\ 5)$ in A_5 . Note that we fix *one* such Z , we do not work uniformly in all of them.

Recall that for a fixed root of unity q , the value of the Jones polynomial $V(K, q)$ can be identified (after some minor normalization) with the Witten-Reshetikhin-Turaev invariant of K determined from the modular category $U_q(\mathfrak{sl}_2)$ -mod by coloring K with the fundamental representation V of the quantum group $U_q(\mathfrak{sl}_2)$. (Recall that the defining representation V of $U_q(\mathfrak{sl}_2)$ is self dual, hence yields an invariant of *unoriented* knots.) Likewise, $\#H(K, G, C)$ can be computed as a WRT invariant using the Dijkgraaf-Witten TQFT based on the modular category DG -mod, where DG is the untwisted Drinfeld double of G . Thus, Theorems 1 and 2 apply to these invariants.

In caricature, each of the main results of [FLW02b], [Kup15] and [KS21] is proved using a similar strategy: given Z , one first finds some model of reversible circuits and associated problem L that is hard. Then given a circuit C in this model, one constructs a polynomial time reduction to a knot diagram K_C such that computing (or approximating) $|Z(K_C)|$ allows one to compute $L(C)$. Of course, there is significant work involved in proving that these reductions are possible, but this is all we need to know, since it means we can prove Corollary 3 if we can accomplish the following:

Fix Z and fix $i = 1$ or 2 . Provide a classical polynomial time algorithm that converts a given knot diagram K to another diagram K' (possibly of a different knot!) so that $|Z(K')| = |Z(K)|$ and K' satisfies all of the desired promises in Theorem i .

Indeed, if we can do this, then we can first reduce a circuit C to the knot diagram K_C exactly as in [FLW02b], [Kup15] or [KS21] (as appropriate, depending on Z), and then simply reduce K_C to $(K_C)'$. Theorems 1 and 2 say this is possible. \square

REFERENCES

- [AM88] Greg Anderson and Greg Moore. Rationality in conformal field theory. *Comm. Math. Phys.*, 117(3):441–450, 1988. URL <http://projecteuclid.org/euclid.cmp/1104161742>.
- [BMS18] Benjamin A. Burton, Clément Maria, and Jonathan Spreer. Algorithms and complexity for Turaev-Viro invariants. *J. Appl. Comput. Topol.*, 2(1-2):33–53, 2018. doi:10.1007/s41468-018-0016-2.
- [BS05] David Bachman and Saul Schleimer. Distance and bridge position. *Pacific J. Math.*, 219(2):221–235, 2005. doi:10.2140/pjm.2005.219.221.
- [CFW16] Shawn X. Cui, Michael H. Freedman, and Zhenghan Wang. Complexity classes as mathematical axioms II. *Quantum Topol.*, 7(1):185–201, 2016. doi:10.4171/QT/75.

- [Eti02] Pavel Etingof. On Vafa's theorem for tensor categories, 2002, arXiv:math/0207007v1.
- [FKW02] Michael H. Freedman, Alexei Kitaev, and Zhenghan Wang. Simulation of topological field theories by quantum computers. *Comm. Math. Phys.*, 227(3):587–603, 2002, arXiv:quant-ph/0001071. doi:10.1007/s002200200635.
- [FLW02a] Michael H. Freedman, Michael Larsen, and Zhenghan Wang. A modular functor which is universal for quantum computation. *Comm. Math. Phys.*, 227(3):605–622, 2002, arXiv:quant-ph/0001108. doi:10.1007/s002200200645.
- [FLW02b] Michael H. Freedman, Michael J. Larsen, and Zhenghan Wang. The two-eigenvalue problem and density of Jones representation of braid groups. *Comm. Math. Phys.*, 228(1):177–199, 2002, arXiv:math/0103200. doi:10.1007/s002200200636.
- [Fre09] Michael H. Freedman. Complexity classes as mathematical axioms. *Ann. of Math. (2)*, 170(2):995–1002, 2009. doi:10.4007/annals.2009.170.995.
- [HP21] Sophie L. Ham and Jessica S. Purcell. Geometric triangulations and highly twisted links, 2021, arXiv:2005.11899.
- [JM16] Jesse Johnson and Yoav Moriah. Bridge distance and plat projections. *Algebr. Geom. Topol.*, 16(6):3361–3384, 2016. doi:10.2140/agt.2016.16.3361.
- [JVW90] F. Jaeger, D. L. Vertigan, and D. J. A. Welsh. On the computational complexity of the Jones and Tutte polynomials. *Math. Proc. Cambridge Philos. Soc.*, 108(1):35–53, 1990. doi:10.1017/S0305004100068936.
- [Kas95] R. M. Kashaev. A link invariant from quantum dilogarithm. *Modern Phys. Lett. A*, 10(19):1409–1418, 1995. doi:10.1142/S0217732395001526.
- [Kau87] Louis H. Kauffman. State models and the Jones polynomial. *Topology*, 26(3):395–407, 1987. doi:10.1016/0040-9383(87)90009-7.
- [KS21] Greg Kuperberg and Eric Samperton. Coloring invariants of knots and links are often intractable. *Algebr. Geom. Topol.*, 21(3):1479–1510, 2021, arXiv:1907.05981. doi:10.2140/agt.2021.21.1479.
- [Kup15] Greg Kuperberg. How hard is it to approximate the Jones polynomial? *Theory Comput.*, 11:183–219, 2015, arXiv:0908.0512. doi:10.4086/toc.2015.v011a006.
- [Men84] W. Menasco. Closed incompressible surfaces in alternating knot and link complements. *Topology*, 23(1):37–44, 1984. doi:10.1016/0040-9383(84)90023-5.
- [MM01] Hitoshi Murakami and Jun Murakami. The colored Jones polynomials and the simplicial volume of a knot. *Acta Math.*, 186(1):85–104, 2001. doi:10.1007/BF02392716.
- [MT93] William Menasco and Morwen Thistlethwaite. The classification of alternating links. *Ann. of Math. (2)*, 138(1):113–171, 1993. doi:10.2307/2946636.
- [Mur87] Kunio Murasugi. Jones polynomials and classical conjectures in knot theory. *Topology*, 26(2):187–194, 1987. doi:10.1016/0040-9383(87)90058-9.
- [Thi87] Morwen B. Thistlethwaite. A spanning tree expansion of the Jones polynomial. *Topology*, 26(3):297–309, 1987. doi:10.1016/0040-9383(87)90003-6.
- [Tom07] Maggy Tomova. Multiple bridge surfaces restrict knot distance. *Algebr. Geom. Topol.*, 7:957–1006, 2007. doi:10.2140/agt.2007.7.957.
- [Vaf88] Cumrun Vafa. Toward classification of conformal theories. *Phys. Lett. B*, 206(3):421–426, 1988. doi:10.1016/0370-2693(88)91603-6.