

ALGEBRAIC VERSUS GEOMETRIC CATEGORIFICATION OF THE ALEXANDER POLYNOMIAL: A SPECTRAL SEQUENCE

ANNA BELIAKOVA, KRZYSZTOF K. PUTYRA, LOUIS-HADRIEN ROBERT, AND EMMANUEL WAGNER

ABSTRACT. We construct a bigraded spectral sequence from the \mathfrak{gl}_0 -homology to knot Floer homology. This spectral sequence is of Bockstein type and comes from a subtle manipulation of coefficients. The main tools are quantum traces of foams and of singular Soergel bimodules.

CONTENTS

1. Introduction	1
1.1. Main results	3
Outline	5
1.2. Conventions	5
1.3. Acknowledgements	6
2. Algebraic preliminaries	6
2.1. Symmetric polynomials and Soergel bimodules	6
2.2. Hochschild homology	8
2.3. Webs and foams	9
2.4. Foams and webs as Soergel bimodules	14
2.5. A quantum trace deformation of annular foams	17
3. Link homologies	19
3.1. The Gilmore complex and knot Floer homology	19
3.2. \mathfrak{gl}_1 homology	23
3.3. \mathfrak{gl}_0 homology	26
4. Main results	27
4.1. Revised Gilmore complex	27
4.2. Functoriality	30
4.3. A pseudo completion	33
4.4. Spectral sequence	34
Appendix A. On Bockstein spectral sequences	34
A.1. The mod- p Bockstein spectral sequence.	35
A.2. The $(t \mapsto 1)$ -Bockstein sequence	36
Appendix B. Cyclicity of the quantum Hochschild homology	37
References	39

1. INTRODUCTION

The discovery of the Alexander polynomial $\Delta_K(q)$ in 1929 marked the birth of knot theory, manifested in the transition from conjectures to proofs. In the 1970s Conway found a first diagrammatic

algorithm to compute this invariant using the so-called skein relation:

$$(1) \quad \begin{array}{c} \text{---} \\ \diagup \diagdown \\ \text{---} \end{array} \ominus \begin{array}{c} \text{---} \\ \diagdown \diagup \\ \text{---} \end{array} = (q - q^{-1}) \begin{array}{c} \text{---} \\ \text{---} \\ \text{---} \end{array},$$

where the three pictures represent link diagrams that coincide outside of the small regions depicted above.

In the 1980s the second big player in knot theory was introduced by Jones and later extended to the two variable HOMFLY-PT polynomial $P_K(\mathbf{a}, \mathbf{q})$ with the skein relation

$$\mathbf{a}^{-1} \begin{array}{c} \text{---} \\ \diagup \diagdown \\ \text{---} \end{array} \ominus \mathbf{a} \begin{array}{c} \text{---} \\ \diagdown \diagup \\ \text{---} \end{array} = (q - q^{-1}) \begin{array}{c} \text{---} \\ \text{---} \\ \text{---} \end{array}.$$

It specializes to the Alexander polynomial for $\mathbf{a} = 1$ and to the Jones polynomial for $\mathbf{a} = \mathbf{q}^2$. Setting $\mathbf{a} = \mathbf{q}^N$ recovers the \mathfrak{sl}_N polynomial of the knot K .

At the beginning of this century Jones and HOMFLY-PT polynomials were moved one categorical level higher by Khovanov and Khovanov–Rozansky [Kho00, KR08a, KR08b]. These new theories associate with a link diagram graded chain complexes, the homology of which yield new powerful link invariants. The polynomials can be reconstructed by taking the graded Euler characteristics of these chain complexes. One powerful aspect of these new invariants is that link cobordisms induce maps on homology, but not on the Euler characteristics.

After presenting a knot K as a closure of a braid β with n crossings, the Khovanov–Rozansky chain complex is defined by resolving each crossing of β in two ways and by assigning to each full resolution, which is an oriented planar graph called a *web*, a Soergel bimodule. Webs are then organized as vertices of an n -dimensional cube. The differentials assigned to the edges of the cube are given by bimodule maps induced by singular 2-dimensional cobordisms called *foams*. This construction is secretly based on a functor of bicategories

$$B: \mathbf{Foam} \rightarrow \mathbf{sSBim}$$

discussed in Section 2. Closing up the braid is achieved by taking the horizontal trace of B , realized on the target by assigning the Hochschild homology of the Soergel bimodule associated with a web. The homology HHH of the resulting complex is a triply graded link invariant that categorifies $P_K(\mathbf{a}, \mathbf{q})$. By putting a base point on the diagram and killing the corresponding variable in the Soergel bimodule, we obtain the so-called *reduced* homology HHH^{red} , which in case of knots does not depend on the position of the base point. For technical reasons the reduced homology requires coefficients in a ring where 2 is invertible. Both constructions admit algorithmic computations.

Parallel to these developments, the Alexander polynomial was categorified by Ozsváth and Szabó using completely different, geometric techniques. Here chain complexes are generated by Lagrangian intersections in a symmetric product of (pointed) Heegaard diagrams and the differential counts holomorphic discs. The resulting homology, known as *knot Floer* homology, is denoted by \widehat{HFK} . The knot Floer homology has important topological applications: it detects the braid index, the genus and fiberedness of a knot [Ni07]. However, this theory is essentially non-local and hard to compute in general. In the analogy to \mathfrak{sl}_N link homology, Dunfield, Gukov and Rasmussen conjectured the existence of a spectral sequence between HHH^{red} and \widehat{HFK} as a lift of the relation $\Delta_K(\mathbf{q}) = P_K(1, \mathbf{q})$. This conjecture is still open.

Recently, the last two authors of the present paper found an evaluation of foams leading to a new knot homology theory $H^{\mathfrak{gl}_0}$ that categorifies the Alexander polynomial. Moreover, they exhibited a spectral sequence from HHH^{red} to $H^{\mathfrak{gl}_0}$. In this paper we investigate a relationship between $H^{\mathfrak{gl}_0}$ and \widehat{HFK} . There is no reason a priori to think that these homologies should be isomorphic because they categorify the same polynomial invariant. For instance, the Jones polynomial has several non-isomorphic categorification: the original Khovanov homology [Kho00], its odd version [ORS13] and a recent new categorification [Cau17], all of which are known to be pairwise non-isomorphic.

Our starting point was the cube of resolutions model for \widehat{HFK} with twisted coefficients constructed by Ozsváth and Szabó in [OS09] and later explored in details by Gilmore [Gil16], where she associated with a knot K represented as a braid closure $\widehat{\beta}$ a complex $C^{AG}(\widehat{\beta})$ of $\mathbb{Z}[t, t^{-1}]$ -modules, such that

$$(2) \quad H_{\bullet}(C^{AG}(\widehat{\beta}) \otimes \mathbb{F}[t^{-1}, t]) \cong \widehat{HFK}(K) \otimes \mathbb{F}[t^{-1}, t]$$

where \mathbb{F} is the field with two elements and the completion allows power series in t , but not in t^{-1} . The Gilmore complex arises as a flattening of a hypercube with vertices decorated by algebras $\mathcal{A}(\widehat{\beta}_I)$, each associated to a resolution $\widehat{\beta}_I$ of the braid closure. The algebra is a quotient of a polynomial ring by local and *non-local* relations and, when specialized at $t = 1$, it can be seen as a quotient of a Soergel bimodule associated with $\widehat{\beta}_I$. Furthermore, Gilmore's differential specializes at $t = 1$ to the one for HHH . However, the isomorphism (2) does not hold in this case.

1.1. Main results. We begin with a three-fold improvement of the Gilmore construction. First, we extend it to all annular webs in contrast to webs with thicknesses 1 and 2. This is done over an arbitrary commutative ring \mathbb{k} with a fixed invertible element q . The space $\mathcal{A}'(\omega)$ assigned to a web ω is a quotient of the *quantum* Hochschild homology [BPW19] of the Soergel bimodule associated with the web by (renormalized) non-local relations. In the case of a resolution $\widehat{\beta}_I$ of a braid with n crossings, we identify this quotient with the Gilmore's algebra $\mathcal{A}(\widehat{\beta}_I)$ by taking coefficients¹ in $\mathbb{Z}[t^{1/2}, t^{-1/2}]$ with $q = t^{-(n+1)/2}$, and renormalizing variables generating $\mathcal{A}(\widehat{\beta}_I)$. This requires a careful check that, in the renormalized variables, Gilmore's local relations coincide with the Soergel relations, whereas non-local relations with those defined for webs.

In the same spirit as in the non-quantized setting, the quantum horizontal trace induces a functor from the quantum annular foams² to quantum Hochschild homology of Soergel bimodules. We check that the non-local relations are preserved by this functor. Hence, we obtain a new functorial evaluation of quantum annular foams by using the *quotient* of the quantum Hochschild homology by the non-local relations. This quotient can a priori be used to define new homology theories.

In the third step we modify this quotient by killing q -torsion. Namely, given a web ω we consider the map

$$(3) \quad \phi_{\omega}: \mathcal{A}'(\omega) \rightarrow \mathcal{A}'(\omega; \mathbb{Z}[q, q^{-1}]) \otimes_{\mathbb{Z}[q, q^{-1}]} \mathbb{Z}[q^{-1}, q],$$

induced by the inclusion of coefficient rings, where in $\mathbb{Z}[q^{-1}, q]$ we allow the elements to consist of infinitely many positive powers of q , but only finitely many negative powers. In general the map ϕ_{ω} is not injective. Dividing the previous construction by the kernel of ϕ_{ω} (tensored with \mathbb{k} over $\mathbb{Z}[q, q^{-1}]$) produces a new functorial assignment of a \mathbb{k} -algebra $qAG(\omega)$ to a quantum annular web ω . Inserting these algebras into a cube of resolutions of a knot $K = \widehat{\beta}$ results in a new chain complex³ $qAG(\widehat{\beta})$ with homology denoted by $qAGH(\widehat{\beta})$. Their specializations at $q = 1$ are written as $AG(\widehat{\beta})$ and $AGH(\widehat{\beta})$ respectively. As we shall see, this new chain complex interpolates between the algebraic and geometric settings previously discussed in the following way.

Proposition A. *If \mathbb{k} is a field of characteristic 0, then AGH coincides with $H^{\mathfrak{gl}_0}$. Hence, it is a knot invariant.*

We expect the following to be true.

¹In order to avoid fractional exponents, later in the paper we denote by t a square root of the variable used by Ozsváth, Szabó, and Gilmore, see Section 4.1 and Proposition 4.3.

²Quantum annular foams are annular foams together with a membrane, subject to additional relations involving the membrane.

³The name of the new complex is motivated by the fact that it interpolates the **A**lgebraic categorification of the last two authors and the **G**eometric categorification of Ozsváth and Szabó.

Conjecture 1. *If \mathbb{k} is a field of characteristic 0 then $qAGH$ is a knot invariant for any q .*

We then analyze a Bockstein spectral sequence from AGH , associated with specializing $qAGH$ at $q = 1$, that preserves the Alexander grading. According to Proposition A we can think of it as a spectral sequence from $H^{\mathfrak{gl}_0}$. We show that it converges and in case $\mathbb{k} = \mathbb{F}$ we identify the limit with the Heegaard–Floer knot homology.

Theorem B. *Let K be a knot obtained as the closure $\widehat{\beta}$ of a braid diagram, the $(t \mapsto 1)$ -Bockstein spectral sequence applied to $qAG(\widehat{\beta}; \mathbb{F}[t, t^{-1}])$ has $H^{\mathfrak{gl}_0}(K; \mathbb{F})$ on its first page and converges after finitely many steps. The last page is (non canonically) isomorphic to $\widehat{HFK}(K, \mathbb{F})$.*

An immediate consequence of this result is that $H^{\mathfrak{gl}_0}$ is an unknot detector. Indeed, for any non-trivial knot, the total dimension of \widehat{HFK} is strictly greater than 1 and so is that for $H^{\mathfrak{gl}_0}$.

Corollary C. *The groups $H^{\mathfrak{gl}_0}$ detect the unknot.*

If Conjecture 1 holds the same would be true for $qAGH$ at any q .

Theorem B is stated with \mathbb{F} -coefficients. But we conjecture that it remains true over \mathbb{Q} .

Conjecture 2. *Theorem B holds over $\mathbb{k} = \mathbb{Q}$, i.e. there exists a spectral sequence starting at $H^{\mathfrak{gl}_0}$ and converging to \widehat{HFK} with \mathbb{Q} coefficients.*

Let us comment on the last conjecture. In the arXiv version of [OSS09] the model for \widehat{HFK} based on the cube of resolutions was defined over \mathbb{Z} and the signs in the edge maps matched those in Gilmore’s construction. In the published version the coefficients were switched to \mathbb{F} , since the Heegaard–Floer homology for multi-pointed diagrams was not yet defined over \mathbb{Z} or \mathbb{Q} .

Theorem D. *Assume that (2) holds with \mathbb{F} replaced by \mathbb{Q} . Then Conjecture 2 holds.*

Recall that in [RW19] a spectral sequence from HHH^{red} to $H^{\mathfrak{gl}_0}$ was constructed over \mathbb{Q} .

Theorem. [RW19] *There exists a differential d_0 of $(\mathbf{a}, \mathbf{q}, \mathbf{t})$ -degree $(2, 0, 0)$ on the Hochschild homology of reduced Soergel bimodules over \mathbb{Q} that induces a (bicomplex) spectral sequence from HHH^{red} to $H^{\mathfrak{gl}_0}$.*

For gradings, the former theorem uses Rasmussen’s conventions [Ras15]: the Koszul differential d_K is of $(\mathbf{a}, \mathbf{q}, \mathbf{t})$ -degree $(2, -2, 0)$, whereas the degree of the hypercube differential d_{top} is $(0, 0, 2)$.

Combining this spectral sequence with the one constructed in this paper we get:

Theorem E. *Under assumption of Theorem D, there exists a spectral sequence from HHH^{red} to \widehat{HFK} with \mathbb{Q} coefficients.*

To investigate the question whether our spectral sequence for $q = 1$ collapses at the first step requires to compute the homology $H^{\mathfrak{gl}_0}$. With \mathbb{F} coefficients, this seems complicated at the moment. However, over \mathbb{Q} this question can be handled using the known computations for HHH^{red} and the spectral sequence between HHH^{red} and $H^{\mathfrak{gl}_0}$.

Consider the first case of interest, namely the $T(3, 4)$ -torus knot. The Poincaré polynomial of the reduced triply graded link homology of this knot is, with Rasmussen’s conventions,

$$P(\mathbf{a}, \mathbf{q}, \mathbf{t}) = \mathbf{a}^6 \mathbf{q}^{-6} \mathbf{t}^6 + (\mathbf{a}^6 \mathbf{q}^{-2} + \mathbf{a}^8 \mathbf{q}^{-4}) \mathbf{t}^2 + (\mathbf{a}^6 \mathbf{q}^0 + \mathbf{a}^6 \mathbf{q}^2 + \mathbf{a}^8 \mathbf{q}^{-2} + \mathbf{a}^8 \mathbf{q}^0) \mathbf{t}^{-2} + (\mathbf{a}^6 \mathbf{q}^6 + \mathbf{a}^8 \mathbf{q}^2 + \mathbf{a}^8 \mathbf{q}^4 + \mathbf{a}^{10} \mathbf{q}^0) \mathbf{t}^{-6}.$$

On one hand, a direct investigation using the degree of the differential d_0 shows that the total dimension of the $H^{\mathfrak{gl}_0}$ [RW19] is at least 9. The only terms that can cancel out are $\mathbf{a}^8 \mathbf{q}^0 \mathbf{t}^{-2}$ and $\mathbf{a}^6 \mathbf{q}^0 \mathbf{t}^{-2}$. On the other hand, the total dimension of \widehat{HFK} for the same knot is 5, with three pairs that should cancel out:

$$\mathbf{a}^{10} \mathbf{q}^0 \mathbf{t}^{-6} \leftrightarrow \mathbf{a}^8 \mathbf{q}^0 \mathbf{t}^{-2}, \quad \mathbf{a}^8 \mathbf{q}^2 \mathbf{t}^{-6} \leftrightarrow \mathbf{a}^6 \mathbf{q}^2 \mathbf{t}^{-2}, \quad \text{and} \quad \mathbf{a}^8 \mathbf{q}^{-2} \mathbf{t}^{-2} \leftrightarrow \mathbf{a}^6 \mathbf{q}^{-2} \mathbf{t}^2.$$

A direct consequence is that $H^{\mathfrak{a}_0}$ and \widehat{HFK} do not coincide over \mathbb{Q} . Hence, the expected spectral sequence of Conjecture 2 does not always degenerate.

To finish let us mention that the previous discussion is compatible with the expected degree of the differential from HHH^{red} to \widehat{HFK} . Indeed all the (higher) differentials of this conjectural spectral sequence have $(\mathfrak{a}, \mathfrak{q}, \mathfrak{t})$ -degree $(k, 0, \ell)$ with $k + \ell = 2$. The spectral sequence in [RW19] collapses the \mathfrak{a} - and \mathfrak{t} -gradings and the (higher) differentials of the present paper are of degree 2 with respect to the sum of \mathfrak{a} - and \mathfrak{t} -degrees.

In the example of $T(3, 4)$, the term $\mathfrak{a}^8 \mathfrak{q}^0 \mathfrak{t}^{-2}$ cancels out with either $\mathfrak{a}^{10} \mathfrak{q}^0 \mathfrak{t}^{-6}$ or $\mathfrak{a}^6 \mathfrak{q}^0 \mathfrak{t}^{-2}$. It is unclear, though, with which one and in which of the two spectral sequences the cancellation happens.

Outline. Besides the introduction, this paper is divided in three sections. The first section is devoted to algebraic preliminaries: we recall classical facts and introduce notations concerning symmetric polynomials, Soergel bimodules and Hochschild homology. Then we discuss webs and foams and finally we apply the technology of quantum traces [BPW19] to webs and foams. In particular, we compute quantum Hochschild homology of singular Soergel bimodules (Theorem 2.33). Section 3 reviews three different link homologies:

- (1) a version of knot Floer homology using an hypercube of resolution [OS09, Gil16],
- (2) the symmetric \mathfrak{gl}_1 link homology first introduced by Cautis [Cau17] with the point of view of [RW20b], and
- (3) the \mathfrak{gl}_0 -homology introduced by the two last authors in [RW19].

The last section is the heart of the paper: we introduce $qAGH$ a fourth homology interpolating between \mathfrak{gl}_0 -homology and knot Floer homology and we prove Theorem B. Finally, Appendix A gives a self-contained account on Bockstein spectral sequences whereas Appendix B contains a technical lemma about quantum Hochschild homology.

1.2. Conventions. In this paper we work over a fixed commutative unital ring \mathbb{k} with no further restrictions and we pick an invertible $q \in \mathbb{k}$. An unadorned tensor product means a tensor product over \mathbb{k} . In a few places we restrict the coefficients to the two-element field \mathbb{F} or the field \mathbb{Q} of rational numbers. The ring $\mathbb{Z}[t, t^{-1}]$ of Laurent polynomials in t is denoted by \mathbb{L} . Its *completion* $\widehat{\mathbb{L}} = \mathbb{Z}[t^{-1}, t]$ consists of power series in t that can have finitely many terms with a negative exponent. For a technical reason, the variable t corresponds to a square root of the variable used in [OS09, Gil16].

The bold letter \mathfrak{q} is used for a shift functor in a graded category. In particular, $\mathfrak{q}^d M$ is a graded module M shifted upwards by d , so that $(\mathfrak{q}^d M)_i = M_{i-d}$. More generally, if $p(q) = \sum_{i \in \mathbb{Z}} a_i q^i$ is a Laurent polynomial in q with positive integral coefficients, then

$$p(\mathfrak{q})M := \bigoplus_i \mathfrak{q}^i M^{\oplus a_i}$$

In particular, we will often use *quantum integers*, *quantum factorials*, and *quantum binomials*, defines respectively as

$$[k] = \frac{q^k - q^{-k}}{q - q^{-1}}, \quad [k]! = \prod_{i=1}^k [i] \quad \text{and} \quad \begin{bmatrix} n \\ k \end{bmatrix} = \frac{[n]!}{[k]![n-k]}.$$

for any integers $0 \leq k \leq n$.

Finally, braids and webs are drawn and read from left to right, whereas foams are drawn and read from bottom to top.

1.3. Acknowledgements. AB and KP are supported by NCCR SwissMAP of the Swiss National Science Foundation. LHR is supported by the Luxembourg National Research Fund PRIDE17/1224660/GPS. EW is partially supported by the ANR projects AlMaRe (ANR-19-CE40-0001-01), AHA (JCJC ANR-18-CE40-0001) and CHARMES (ANR-19-CE40-0017).

2. ALGEBRAIC PRELIMINARIES

2.1. Symmetric polynomials and Soergel bimodules. In this section we summarize some useful facts about symmetric polynomials and Soergel bimodules. We refer to [Mac15] and [EMTW20] for a detailed account.

Notation 2.1. The number of boxes of a given Young diagram λ is denoted by $|\lambda|$. We write $T(a, b)$ for the set of Young diagrams with at most a columns and at most b rows. The maximal diagram, a rectangle of width a and height b , is hereafter denoted by $\text{box}(a, b)$. Given a Young diagram $\lambda \in T(a, b)$ we construct its

- *complement* $\lambda^c \in T(a, b)$ by rotating by 180 degrees the set of boxes from $\text{box}(a, b)$ that are not in λ ,
- *transpose* $\lambda^t \in T(b, a)$ by exchanging rows with columns in λ ,
- *dual* $\widehat{\lambda} \in T(b, a)$ as the diagram $(\lambda^t)^c = (\lambda^c)^t$.

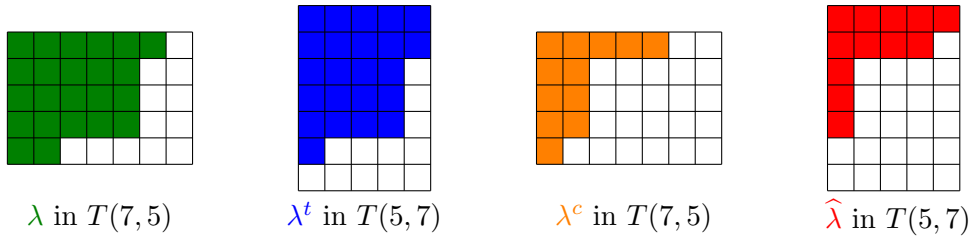

FIGURE 1. Pictorial definition of λ^c , λ^t and $\widehat{\lambda}$.

Fix a positive number $N > 0$ and recall that \mathbb{k} is a fixed commutative unital ring. Consider the polynomial ring $R := \mathbb{k}[x_1, \dots, x_N]$ with an action of the symmetric group \mathfrak{S}_N that permutes the variables. Endow R with a grading by declaring that all x_i are homogeneous of degree 2. It is a standard fact that the ring of invariant polynomials

$$\text{Sym}_N := R^{\mathfrak{S}_N}$$

is freely generated by elementary symmetric functions

$$e_k(x_1, \dots, x_N) = \sum_{i_1 < \dots < i_k} x_{i_1} \cdots x_{i_k}$$

for $k = 1, \dots, N$. A linear basis of Sym_N is given by *Schur polynomials* s_λ parametrized by Young diagrams λ with at most N rows. They satisfy

$$s_\lambda s_\mu = \sum_{\nu} c_{\lambda\mu}^{\nu} s_\nu$$

where $c_{\lambda,\mu}^{\nu} \in \mathbb{N}$, the Littlewood–Richardson coefficients, are independent of N . Because $c_{\lambda\mu}^{\nu} = 0$ unless $|\lambda| + |\mu| = |\nu|$, the above sum is finite.

Proposition 2.2. *Let X, Y and Z be pairwise disjoint finite sets of variables. Then the following equations hold for any Young diagram λ :*

$$(4) \quad s_\lambda(X \sqcup Z) = \sum_{\alpha, \beta} c_{\alpha\beta}^{\lambda} s_\alpha(X) s_\beta(Z),$$

$$(5) \quad s_\lambda(X) = \sum_{\alpha, \beta} c_{\alpha\beta}^\lambda (-1)^{|\beta|} s_\alpha(X \sqcup Z) s_{\beta^t}(Z), \text{ and}$$

$$(6) \quad \sum_{\alpha, \beta} (-1)^{|\beta|} c_{\alpha\beta}^\lambda s_\alpha(X) s_{\beta^t}(Y) = \sum_{\alpha, \beta} (-1)^{|\beta|} c_{\alpha\beta}^\lambda s_\alpha(X \sqcup Z) s_{\beta^t}(Y \sqcup Z).$$

Proof. The derivation of (4) can be found in [Mac15, eq.(5.9)] and the formula (5) is the special case of (6) for $Y = \emptyset$. The last equality is proven in [RW20a, Lemma A.7]. \square

Corollary 2.3. *Let ν be a Young diagram and X, Y, Z pairwise disjoint finite sets of variables. Then*

$$\sum_{\alpha \in T(a,b)} (-1)^{|\hat{\alpha}|} s_\alpha(X) s_{\hat{\alpha}}(Y) = \sum_{\alpha \in T(a,b)} (-1)^{|\hat{\alpha}|} s_\alpha(X \sqcup Z) s_{\hat{\alpha}}(Y \sqcup Z).$$

Proof. Set $\lambda = \text{box}(a, b)$ in (6). \square

A sequence of positive numbers $\underline{k} = (k_1, \dots, k_r)$ with $k_1 + \dots + k_r = N$ is called a *composition of N* . It determines a parabolic subgroup $\mathfrak{S}_{\underline{k}} := \mathfrak{S}_{k_1} \times \dots \times \mathfrak{S}_{k_r}$ of \mathfrak{S}_N and a ring $R^{\underline{k}} := R^{\mathfrak{S}_{\underline{k}}}$ of polynomials invariant under the action of the subgroup. In particular, $R^{(1, \dots, 1)} = R$ and $R^{(N)} = \text{Sym}_N$. Clearly, $R^{\underline{k}} \cong \text{Sym}_{k_1} \otimes \dots \otimes \text{Sym}_{k_r}$.

We say that a composition $\underline{\ell}$ is a *refinement* of \underline{k} if it is obtained by replacing each k_i with its composition, possibly of length 1. In such case $\mathfrak{S}_{\underline{\ell}} \subseteq \mathfrak{S}_{\underline{k}}$ and $R^{\underline{k}}$ is a subring of $R^{\underline{\ell}}$. The following is a standard fact from representation theory.

Theorem 2.4 ([EMTW20, Theorem 24.40]). *Let $\underline{\ell}$ be a refinement of a composition \underline{k} . Then $R^{\underline{k}} \subseteq R^{\underline{\ell}}$ is a graded Frobenius extension.⁴ In particular, $R^{\underline{\ell}}$ is a free module over $R^{\underline{k}}$.*

Example 2.5 (cf. [KLMS12, Theorem 2.12]). Assume that $\underline{\ell} = (\ell_1, \dots, \ell_{r+1})$ is an *elementary* refinement of \underline{k} , i.e. there exists an index i , such that

$$k_j = \begin{cases} \ell_j, & j < i, \\ \ell_i + \ell_{i+1}, & j = i, \\ \ell_{j+1}, & j > i. \end{cases}$$

Then the extension $R^{\underline{k}} \subseteq R^{\underline{\ell}}$ has degree $\ell_i \ell_{i+1}$ and the basis of $R^{\underline{\ell}}$ is given by elements

$$b_\lambda := 1^{\otimes i} \otimes s_\lambda \otimes 1^{\otimes r-i}$$

with $\lambda \in T(\ell_{i+1}, \ell_i)$. The trace map $\epsilon: R^{\underline{\ell}} \rightarrow R^{\underline{k}}$ takes b_λ to 1 if $\lambda = \text{box}(\ell_{i+1}, \ell_i)$ and to 0 otherwise.

Example 2.6. The ring $R^{\underline{k}}$ is a free module over $R^{(N)} \cong \text{Sym}_N$. Its basis is given by pure tensors of Schur polynomials

$$1 \otimes s_{\lambda_2} \otimes \dots \otimes s_{\lambda_r}$$

where λ_i is a Young diagram with at most and $k_1 + \dots + k_{i-1}$ columns and k_i rows.

Let **Bim** be the bicategory of rings, bimodules, and bimodule maps, with the horizontal composition given by the tensor product of bimodules. Consider the induction and restriction bimodules

$$\text{Ind}_{\underline{k}}^{\underline{\ell}} \cong_{R^{\underline{\ell}}(R^{\underline{k}})_{R^{\underline{k}}}} \quad \text{Res}_{\underline{k}}^{\underline{\ell}} \cong_{R^{\underline{k}}(\mathbf{q}^d R^{\underline{\ell}})_{R^{\underline{\ell}}}}$$

for all Frobenius extensions $R^{\underline{k}} \subseteq R^{\underline{\ell}}$, where d is the degree of the extension. Their finite compositions, i.e. tensor products over the polynomial rings, are called *singular Bott–Samelson bimodules*.

⁴An extension $A \subseteq B$ is *Frobenius* if there is a nondegenerate A -linear trace $\epsilon: B \rightarrow A$. It is a *graded extension of degree d* if A and B are graded and ϵ is homogeneous of degree $-2d$.

Definition 2.7. The *bicategory of singular Soergel bimodules* \mathbf{sSBim} is the full graded additive and idempotent complete subcategory of \mathbf{Bim} with rings R^k as objects and 1-morphisms generated by singular Bott–Samelson bimodules. In other words, every 1-morphism in $\mathbf{sSBim}(R^k, R^\ell)$ is a direct summand of a bimodule of the form $\bigoplus_{i=1}^r \mathbf{q}^{d_i} B_i$, where each $B_i \in \mathbf{Bim}(R^k, R^\ell)$ is a singular Bott–Samelson bimodule.

Remark 2.8. It follows directly from the definition that a singular Soergel bimodule is projective when seen as a left or as a right module. Moreover, it is free when it is a direct sum of singular Bott–Samelson bimodules.

Remark 2.9. The morphism category $\mathbf{sSBim}(R, R)$ is the category of classical (non-singular) Soergel bimodules.

2.2. Hochschild homology. Let A be a \mathbb{k} -algebra and M an (A, A) -bimodule. The *Hochschild homology of M* is the homology of the chain complex $CH_\bullet(A, M)$ with chain groups $CH_n(A, M) := M \otimes A^{\otimes n}$ and the differential given by the alternating sum

$$(7) \quad \begin{aligned} \partial(m \otimes a_1 \otimes \cdots \otimes a_n) &= ma_1 \otimes a_2 \otimes \cdots \otimes a_n \\ &+ \sum_{i=1}^{n-1} (-1)^i m \otimes a_1 \otimes \cdots \otimes a_i a_{i+1} \otimes \cdots \otimes a_n \\ &+ (-1)^n a_n m \otimes a_1 \otimes \cdots \otimes a_{n-1}. \end{aligned}$$

The group $HH_0(A, M) \cong M/[A, M]$ is known as the *space of coinvariants of M* , where $[A, M] := \{am - ma \mid a \in A, m \in M\}$ is the commutator of A and M .

The above definition can be deformed by an algebra automorphism $\varphi \in \text{Aut}(A)$ by replacing the last term of the differential with

$$(8) \quad (-1)^n \varphi(a_n) m \otimes a_1 \otimes \cdots \otimes a_{n-1}.$$

The resulting complex $CH_\bullet^\varphi(A, M)$ is the *φ -twisted Hochschild complex*. When A and M are graded, then there is a natural automorphism, leading to *quantum Hochschild homology* introduced in [BPW19]. Fix an invertible element $q \in \mathbb{k}$ and define $\varphi(a) = q^{-|a|}$, where $|a|$ is the degree of a homogeneous element $a \in A$. Then the last term of the twisted Hochschild differential (8) takes the form

$$(9) \quad (-1)^n q^{-|a_n|} a_n m \otimes a_1 \otimes \cdots \otimes a_{n-1}.$$

The *quantum Hochschild homology of M* , denoted by $qHH_\bullet(A, M)$, is the homology of this complex. This construction was also reviewed in [Lip20]. Following the usual conventions we write $qCH(A)$ and $qHH(A)$ when $M = A$. Additionally, when A is clear from the context, we write $qHH(M)$.

Remark 2.10. Hochschild chains can be visualized by circles divided into segments, one labeled with $m \in M$ and the others with a_0, \dots, a_n . Each of the terms of the differential merges two segments multiplying their labels.

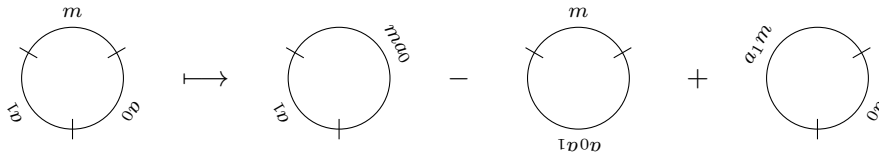

In the twisted case add a mark on the circle between segments labeled m and a_n . To merge these two segments, one has to move a_n over the mark, acting upon it with φ as depicted below.

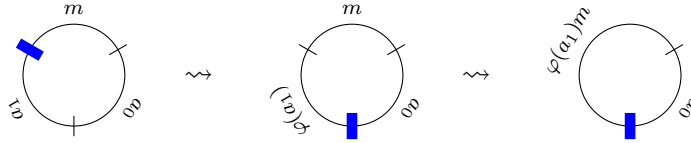

The quantum Hochschild homology can be seen as arising from twisting bimodules by algebra automorphisms. Namely, given $\varphi \in \text{Aut}(A)$ and a left A -module M , denote by ${}_{\varphi}M$ its φ -twist, defined as the module M with the action twisted by φ , i.e. $a \cdot m := \varphi(a)m$. If M is an (A, A) -bimodule, then it follows directly from the definition that

$$(10) \quad CH_{\bullet}^{\varphi}(A, M) \cong CH_{\bullet}(A, {}_{\varphi}M).$$

The following property is proven in [BPW19].

Proposition 2.11. *Choose graded \mathbb{k} -algebras A, B, C and graded (A, B) - and (B, C) -bimodules M and N . Then for any invertible scalars $q_1, q_2 \in \mathbb{k}$ there is a bimodule isomorphism*

$$q_1 M \otimes_B q_2 N \xrightarrow{\cong} q_1 q_2 (M \otimes_B N)$$

defined as $m \otimes n \mapsto q_2^{|m|} m \otimes n$ for homogeneous $m \in M$ and $n \in N$.

This implies together with (10) that the quantum Hochschild homology is invariant under cyclic permutation of tensor factors.

Proposition 2.12. *Pick graded \mathbb{k} -algebras A and B and graded (A, B) - and (B, A) -bimodules M and N that are projective as left modules. Then there is an isomorphism*

$$qHH_{\bullet}(A, M \otimes_B N) \cong qHH_{\bullet}(B, N \otimes_A M)$$

for any invertible parameter $q \in \mathbb{k}$.

We end this section with a statement about the quantum Hochschild homology for the algebra $R^{\mathbb{k}}$. The proof, which is rather technical, is postponed to Appendix B.

Proposition 2.13. *Suppose that $1 - q^d$ is invertible for $d \neq 0$. Then the inclusion $\mathbb{k} \subset R^{\mathbb{k}}$ induces a homotopy equivalence of chain complexes*

$$qCH_{\bullet}(R^{\mathbb{k}}) \simeq qCH_{\bullet}(\mathbb{k}) \simeq \mathbb{k},$$

where \mathbb{k} lives in homological degree 0. In particular, higher quantum Hochschild homology vanishes.

2.3. Webs and foams. This section provides the basics of webs and foams and results that are fundamental for this paper. More details can be found in [RW20a, RW19] and [QR16, QRS18]. We consider only webs and foams embedded in smooth manifolds and for a technical reason we assume that they have *collared boundary*. This means that for a smooth manifold M we fix a smooth embedding $\partial M \times [0, 1] \rightarrow M$ that takes $(x, 0)$ to x . This technical condition implies a canonical smooth structure on the gluing of two such manifolds along a boundary component.

Definition 2.14. Let Σ be an oriented smooth surface with a collared boundary. A *web* $\omega \subset \Sigma$ is an oriented trivalent graph, possibly with endpoints, smoothly embedded in Σ in a way, such that it coincides with $\partial\omega$ on the collar of $\partial\Sigma$, and with edges labeled with positive integers such that at each trivalent vertex the *flow condition* holds: the sum of labels of incoming edges is equal to the sum of labels of outgoing edges. We write $E(\omega)$ and $V(\omega)$ respectively for the sets of edges and vertices of a web ω and $\ell(e)$ for the label of an edge e . We call $\ell(e)$ the *thickness* of e .



FIGURE 2. A split and a merge vertex in a web.

The flow condition implies that each vertex of a web is either a *split* or a *merge*, illustrated respectively on the left and the right hand side of Figure 2.

In this paper we are mostly interested in webs in a strip $[0, 1] \times \mathbb{R}$ (*planar webs*) or an annulus $\mathbb{S}^1 \times \mathbb{R}$ (*annular webs*). We say that such a web ω is *directed* if the projection on $[0, 1]$ or \mathbb{S}^1 respectively has no critical points when restricted to ω and that projection of orientations agree with that of $[0, 1]$ or \mathbb{S}^1 respectively. Such a web can be visualized as a result of a tangential gluing of parallel intervals oriented from left to right (or circles oriented anticlockwise in the annular case), see Figure 3. The reverse operation is called a *lamination* [QW21]. In particular, a directed web ω



FIGURE 3. A directed planar web of index 4 (on the left) and its lamination (on the right).

can be decomposed into a sequence of merges and splits. Hence, the sum of thicknesses at a generic section $\omega_t := \omega \cap (\{t\} \times \mathbb{R})$ is constant. We call it the *index* of ω . In case of webs in a strip, the section ω_0 and ω_1 are called respectively the *input* and the *output* of ω .

Remark 2.15. Directed annular webs are called *vinyl graphs* in [RW20b].

Definition 2.16. Let M be an oriented smooth 3-manifold with a collared boundary. A *foam* $W \subset M$ is a collection of *facets*, that are compact oriented surfaces labeled with positive integers and glued together along their boundary points in a way, such that every point p of W has a closed neighborhood homeomorphic to one of the following:

- a disk, when p belongs to a unique facet,
- $Y \times [0, 1]$, where Y is a merge or a split web, when p belongs to three facets, or
- the cone over the 1-skeleton of a tetrahedron with p as the vertex of the cone (so that it belongs to six facets).

See Figure 4 for a pictorial representation of these three cases. The set of points of the second type is a collection of curves called *bindings* and the points of the third type are called *singular vertices*. The *boundary* ∂W of W is the closure of the set of boundary points of facets that do not belong to a binding. It is understood that W coincides with $\partial W \times [0, 1]$ on the collar of ∂M . We write $F(W)$ for the collection of facets of W and $\ell(f)$ for the thickness of a facet f . A foam W is *decorated* if each facet $f \in F(W)$ is assigned a symmetric polynomial $P_f \in \text{Sym}_{\ell(f)}$.

Remark 2.17. A foam satisfies a 2-dimensional version of the flow condition: three facets meet at each binding in a way, such that the thickness of one of them is equal to the sum of thicknesses of the other two. The binding induces orientation from the two thinner facets; it is opposite to the one induced from the thickest facet.

The boundary of a foam $W \subset M$ is a web in ∂M . In case $M = \Sigma \times [0, 1]$ is a thickened surface, we require that $\partial W \cap (\partial \Sigma \times [0, 1])$ is a collection of vertical lines. A generic section $W_t := W \cap (\Sigma \times \{t\})$ is a web, each with the same boundary. The bottom and top webs W_0 and W_1 are called respectively the *input* and *output* of W .

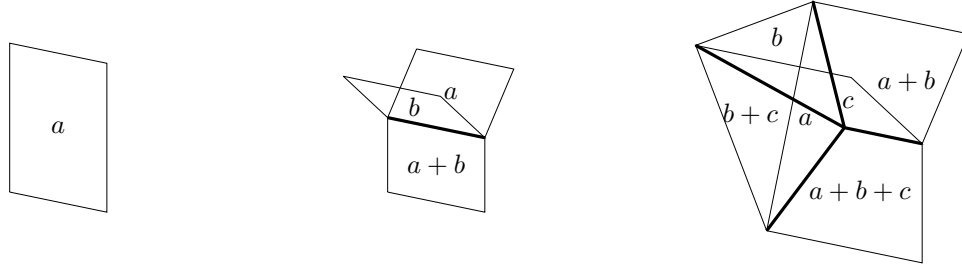

FIGURE 4. The three local models for a foam.

Let $\text{Foam}(M)$ be the \mathbb{k} -module generated by decorated foams in M modulo *local relations*, defined as follows. Consider the collection of Robert–Wagner evaluations

$$\langle -, - \rangle_N : \text{Foam}(M) \otimes \text{Foam}(M) \rightarrow \text{Sym}_N$$

from [RW20a]. We impose the relation $a_1 W_1 + \dots + a_r W_r = 0$ whenever there is a 3-ball $B \subset M$, such that all sets $W_i \setminus B$ coincide and the linear combination $\sum_i a_i (W_i \cap B)$ is in the kernel of $\langle -, - \rangle_N$ for all $N > 0$. The set $\text{Foam}(M)$ is graded by $\mathbb{Z} \oplus \mathbb{Z}$, see [ETW18] for details.⁵

The bicategory of directed foams. Let us now consider foams between planar directed webs (so that $\Sigma = [0, 1] \times \mathbb{R}$). In this situations we impose the additional condition that a foam W is “directed” itself, i.e. that the projection onto the side square $[0, 1] \times [0, 1]$ has no critical points when restricted to W . This immediately implies that a generic section of W is a directed web as defined above. A foam of this type can be decomposed into seven basic homogeneous pieces: traces of isotopies and six singular blocks shown in Figure 5. For all of them the second component of the $(\mathbb{Z} \oplus \mathbb{Z})$ -grading vanishes, so that the space of directed foams is \mathbb{Z} -graded.

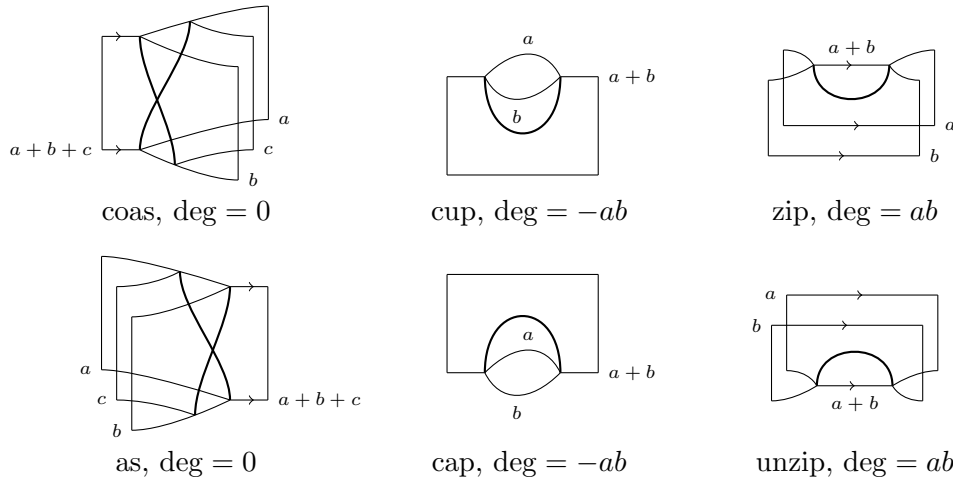

FIGURE 5. Local models for all singularities of directed foams, together with their degrees.

Definition 2.18. Let **Foam** be the bicategory of ∞ -foams, in which

- objects are finite sequences of points on a line, labeled with positive integers,
- 1-morphisms from \underline{a} to \underline{b} are formal finite direct sums $\bigoplus_i \mathbf{q}^{d_i} \omega_i$, where each ω_i is a directed web $\omega \subset [0, 1] \times \mathbb{R}$ with input \underline{a} and output \underline{b} ,

⁵This $\mathbb{Z} \oplus \mathbb{Z}$ -grading is related to the \mathbb{Z} -grading of \mathfrak{gl}_n -foams by collapsing (a, b) into $a + Nb$.

- 2-morphisms from $\bigoplus_i \mathbf{q}^{d_i} \omega_i$ to $\bigoplus_j \mathbf{q}^{d'_j} \omega'_j$ are matrices (m_{ij}) , where m_{ij} is a linear combination of decorated directed foams in a thickened strip with input ω_i , output ω_j , and degree $d'_j - d_i$.

Remark 2.19. The approach to **Foam** is slightly different in [QR16]. Here one first constructs a bicategory $n\mathbf{Foam}$ of (directed) \mathfrak{gl}_n foams using technics from higher representation theory and writes down its presentation in terms of generators and relations. Then it is shown that these categories admit a limit when N goes to infinity. It can be shown that the limit category coincides with **Foam** as defined above.

Proposition 2.20 ([RW20b, Proposition 5.10], [QR16]). *There are graded isomorphisms of webs in **Foam***

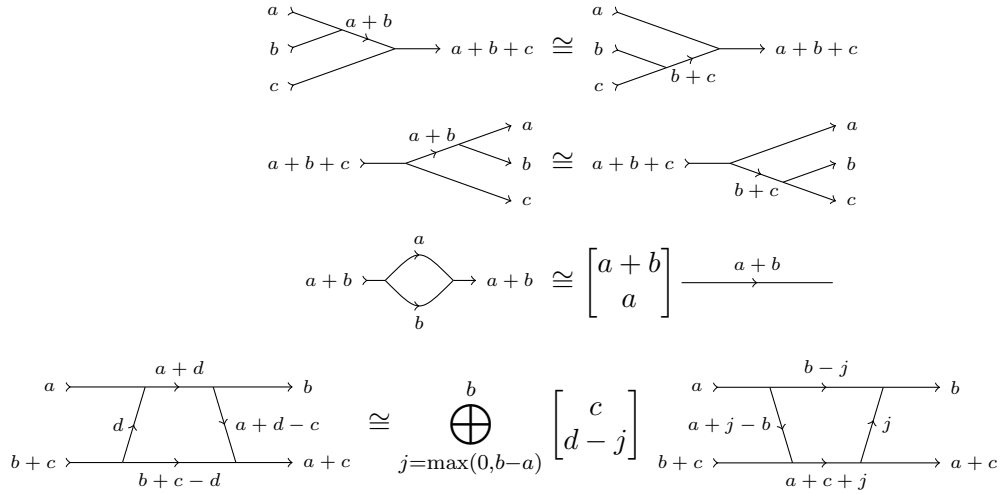

Of particular interest to us are webs and foams with labels at most 2, the former having all endpoints labeled one. They arise naturally as resolutions of uncolored link diagrams. Following [RW19] we call them *elementary*. In what follows we write $\mathbf{Foam}^{\leq 2}$ for the linear subcategory of **Foam** generated by elementary foams and webs.

Proposition 2.21. *There are isomorphisms of elementary webs in $\mathbf{Foam}^{\leq 2}$:*

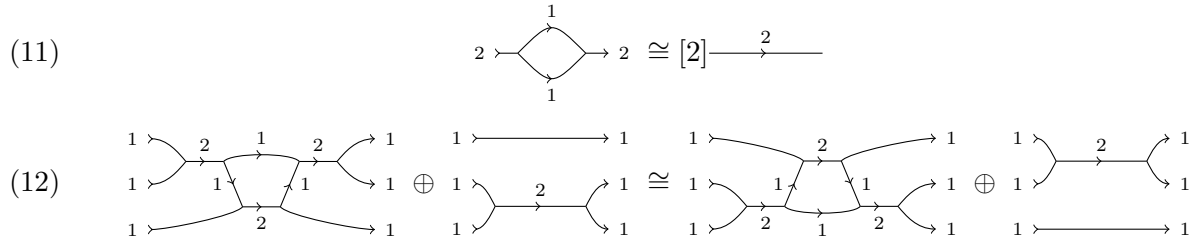

Directed annular webs and foams. Consider now directed annular webs, so that $\Sigma = \mathbb{S}^1 \times \mathbb{R}$. Again, we consider only *directed foams* between them, on which the projection onto $\mathbb{S}^1 \times [0, 1]$ has no critical points. These foams have the same six types of singularities from Figure 5 as directed foams in a thickened strip.

Annular webs and foams constitute a category \mathcal{AFoam} constructed in the same fashion as **Foam**, keeping in mind that annular webs have no endpoints. The objects of \mathcal{AFoam} are formal finite direct sums $\bigoplus_i \mathbf{q}^{d_i} \omega_i$, where each ω_i is a directed annular web, and morphisms from $\bigoplus_i \mathbf{q}^{d_i} \omega_i$ to $\bigoplus_j \mathbf{q}^{d'_j} \omega'_j$ are matrices (m_{ij}) , where each m_{ij} is a linear combination of decorated directed annular foams with input ω_i , output ω_j , and degree $d'_j - d_i$. We impose the same local relations as discussed above. It

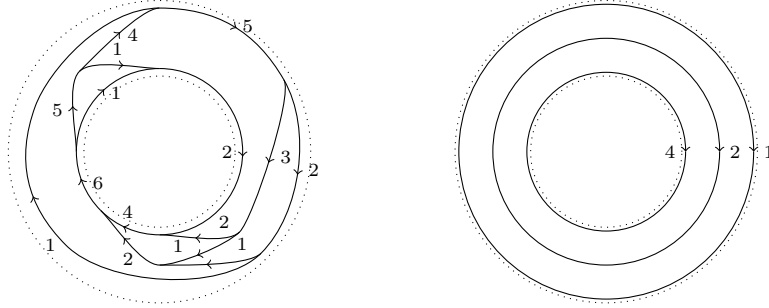

FIGURE 6. Examples of directed annular webs of index 7. The one to the right is $\mathbb{S}_{(4,2,1)}$.

contains a subcategory $\mathcal{AFoam}^{\leq 2}$ of *elementary annular webs and foams*, where we consider only webs and foams with edges and facets of thickness at most 2.

Example 2.22. Given a finite sequence $\underline{k} = (k_1, \dots, k_r)$ one can consider a disjoint union of r concentric clockwise oriented circles with thicknesses k_1, \dots, k_r , read from the most nested circle towards the unnested one. We called it a *circular web* and denote by $\mathbb{S}_{\underline{k}}$.

The next proposition follows from the Queffelec–Rose–Sartori reduction algorithm for annular webs.

Proposition 2.23 (cp. [QRS18, Theorem 3.2]). *Given an annular directed web ω , there are graded direct sums of circular webs S_L and S_R , such that $\omega \oplus S_L \cong S_R$ in \mathcal{AFoam} .*

There is a similar result for elementary annular webs, with circular webs replaced by another class of webs.

Definition 2.24. A *chain of dumbbells of index k* is an annular web D_k obtained from k concentric circles by gluing each pair of neighboring circles along an arc, such that i -th circle is glued with $(i + 1)$ -th immediately after it is glued with $(i - 1)$ -th, see Figure 7.

Note that a chain of dumbbells of index $k \geq 3$ consists of $k - 1$ thick edges and $2k - 1$ thin edges. We say that an elementary web is *basic* if it is a concentric collections of circles and chains

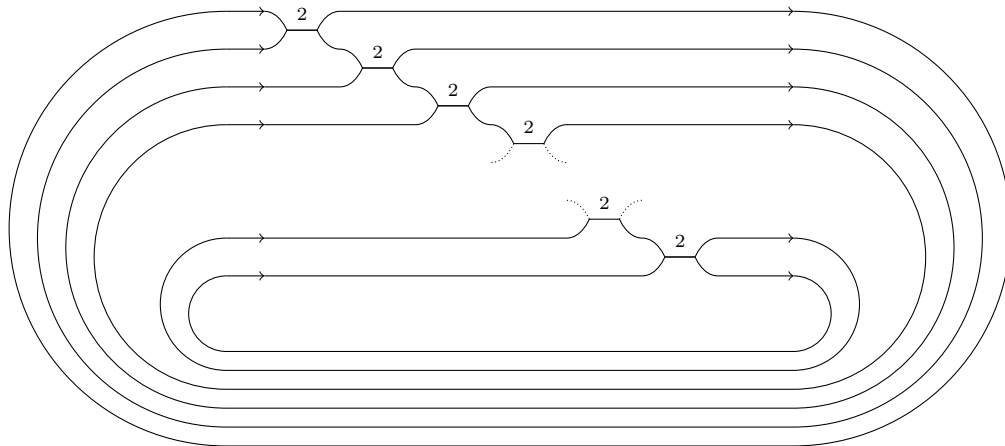

FIGURE 7. A chain of dumbbells.

of dumbbells. They play the role of circular webs in $\mathcal{AFoam}^{\leq 2}$.

Proposition 2.25 ([RW19, Corollary 2.5]). *Given an elementary annular directed web ω , there are graded direct sums of basic elementary webs X_L and X_R , such that $\omega \oplus X_L \cong X_R$ in $\mathcal{AFoam}^{\leq 2}$.*

Marked annular webs. The last category of webs we consider is the category \mathcal{AFoam}^\star of *marked annular webs*, the objects of which are directed annular webs, each with a *basepoint* \star placed on an edge of thickness 1. In particular, not all webs appear in this category. Morphisms between two such webs are generated by annular foams with the property that the basepoints of the top and bottom boundary webs lie on the same facet. There is a forgetful functor $\mathcal{AFoam}^\star \rightarrow \mathcal{AFoam}$.

We can actually assume that the basepoints of the two webs are located at the same point of the annulus and the vertical line connecting them is contained in the foam. In order to simplify the exposition, in this paper we impose another restriction: the edge marked by the basepoint is on the outer side of the web. In the view of this restriction (as well as the fact that basepoints restrict the set of foams) there is no direct analogue of Proposition 2.23. However, Proposition 2.25 still holds for chains of dumbbells with a marking on the outer thin edge.

2.4. Foams and webs as Soergel bimodules. Directed webs and foams can be seen as a graphical representation of Soergel bimodules and bimodule maps. Indeed, there is a fully faithful functor from foams to Soergel bimodules, the construction of which we recall in what follows. We refer to [Wed19, RW20b] for more details.

Pick a web ω and associate with each edge $u \in E(\omega)$ of thickness r the graded \mathbb{k} -algebra of symmetric polynomials $R_u := \mathbb{k}[x_{u,1}, \dots, x_{u,r}]^{\mathfrak{S}_r}$, where $\deg x_{u,i} = 2$. For simplicity we will often write X_u for the set of variables corresponding to the edge u . The tensor product over \mathbb{k}

$$D(\omega) := \bigotimes_{u \in E(\omega)} R_u,$$

is called the *space of decorations* of ω . It is the algebra of polynomials in edge variables that are symmetric with respect to permutations that preserve each set X_u . A pure tensor from $D(\omega)$ corresponds to assigning a symmetric polynomial $P_u \in R_u$ to each edge $u \in E(\omega)$. Therefore, we represent such elements with collections of dots on edges of ω , each labeled with the corresponding polynomial, see Figure 8. As special cases we consider

- a dot labeled by a Young diagram λ representing the Schur polynomial s_λ , and
- a dot labeled by an integer $i > 0$ on an edge u of thickness 1 to represent the monomial x_u^i .

Dots on the same edge follow the multiplicative convention: two dots labeled P_1 and P_2 on the same edge are equal to a dot labeled $P_1 P_2$ and an edge with no dot is decorated by 1.

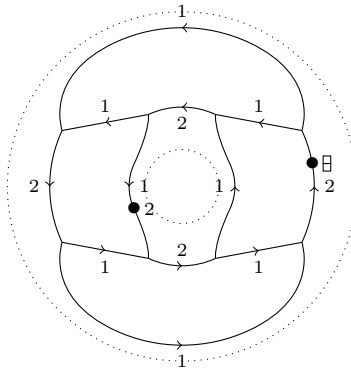

FIGURE 8. An annular web with a decoration.

Consider now the ideal of *local relations* $I(\omega) \subset D(\omega)$ constituted by all differences

$$(13) \quad P(X_u) - P(X_{u'} \sqcup X_{u''}),$$

where u is an edge of thickness $a + b$ that splits into or is a merge of u' of thickness a and u'' of thickness b , and P is a symmetric polynomial in $a + b$ variables. Diagrammatically,

$$(14) \quad \begin{array}{c} a + b \xrightarrow{P} \begin{array}{c} \nearrow a \\ \searrow b \end{array} = \sum_i a + b \xrightarrow{R(i)} \begin{array}{c} \xrightarrow{Q(i)} a \\ \searrow \\ \xrightarrow{R(i)} b \end{array} \quad \text{and} \\ \\ a \xrightarrow{\quad} \begin{array}{c} \nearrow \\ \searrow \end{array} \xrightarrow{P} a + b = \sum_i \begin{array}{c} \xrightarrow{Q(i)} a \\ \searrow \\ \xrightarrow{R(i)} b \end{array} \rightarrow a + b, \end{array}$$

where the symmetric polynomials $Q_{(i)}$ and $R_{(i)}$ satisfy

$$P(X_{u'} \sqcup X_{u''}) = \sum_i Q_{(i)}(X_{u'}) R_{(i)}(X_{u''}).$$

Note that the generators of $I(\omega)$ are homogeneous, so that the ideal is graded. Finally, given a vertex $v \in V(\omega)$ denote by $\text{gr}(v)$ the product of thicknesses of the thin edges adjacent to v . The *Soergel space* associated with ω is the graded quotient

$$B(\omega) := \mathbf{q}^{-\frac{1}{2} \sum_{v \in V(\omega)} \text{gr}(v)} D(\omega) / I(\omega).$$

Suppose now that $\omega \subset [0, 1] \times \mathbb{R}$ is a planar directed web of index k . Its input and output determine compositions \underline{a} and \underline{b} of k and $B(\omega)$ admits a left and a right action by the algebras $R^{\underline{a}}$ and $R^{\underline{b}}$ respectively. Furthermore, when ω consists of a single vertex that is a merge (resp. a split), then $B(\omega)$ coincides up to a grading shift with the induction $\text{Ind}_{\underline{b}}^{\underline{a}}$ (resp. restriction $\text{Res}_{\underline{b}}^{\underline{a}}$) bimodule. The results below follow immediately from the above and the definition of the Soergel space for a web.

Proposition 2.26. *Let ω_1 and ω_2 be planar directed webs with $\text{out}(\omega_1) = \underline{a} = \text{in}(\omega_2)$. Then*

$$B(\omega_1 \circ \omega_2) \cong B(\omega_1) \otimes_{R^{\underline{a}}} B(\omega_2).$$

In particular, $B(\omega)$ is a singular Soergel bimodule for any planar directed web ω .

Proposition 2.27. *Let $\widehat{\omega}$ be the annular closure of a directed web ω . Then $B(\widehat{\omega}) \cong HH_0(B(\omega))$.*

Example 2.28. The Soergel bimodule associated with the directed web ω in Figure 3 is a quotient of the tensor product

$$R(\omega) = R^{(3,1)} \otimes R^{(4)} \otimes R^{(2,2)}$$

by relations that identify any generator of $R^{(4)}$ with its image in either of the two other factors. Hence, taking into account the overall shift,

$$B(\omega) = \mathbf{q}^{-\frac{7}{2}} R^{(3,1)} \otimes_{R^{(4)}} R^{(2,2)}.$$

Let us now introduce maps between Soergel spaces that correspond to the basic building blocks from Figure 5 (compare [Wed19, RW20b]). The first four arises as the units and traces of associated graded Frobenius extensions [EMTW20].

The cup foam is assigned the inclusion

$$\text{cup: } B\left(\xrightarrow{a+b}\right) \longrightarrow \mathbf{q}^{ab} B\left(\begin{array}{c} a \\ \nearrow \searrow \\ a+b \xrightarrow{\quad} \quad \rightarrow a+b \\ \searrow \nearrow \\ b \end{array}\right)$$

$$\xrightarrow{a+b} \mapsto a+b \begin{array}{c} \nearrow^a \\ \searrow_b \end{array} \rightarrow a+b,$$

whereas with the cap foam we associate the the projection

$$\text{cap: } B \left(a+b \begin{array}{c} \nearrow^a \\ \searrow_b \end{array} \rightarrow a+b \right) \longrightarrow \mathbf{q}^{ab} B \left(\xrightarrow{a+b} \right)$$

$$a+b \begin{array}{c} \nearrow^a \\ \searrow_b \end{array} \begin{array}{c} \bullet \\ P \\ \bullet \\ Q \end{array} \mapsto a+b \xrightarrow{\bullet} P \star Q,$$

where $P \star Q = \sum_{\substack{I \sqcup J = \{1, \dots, a+b\} \\ \#I=a, \#J=b}} \frac{P(x_I)Q(x_J)}{\nabla(x_I, x_J)}$ and $\nabla(x_I, x_J) = \prod_{\substack{i \in I \\ j \in J}} (x_j - x_i)$.

A *zip* is associated with the inclusion

$$\text{zip: } B \left(\begin{array}{c} a \longrightarrow \\ b \longrightarrow \end{array} \right) \longrightarrow \mathbf{q}^{-ab} B \left(\begin{array}{c} a \curvearrowright \\ b \curvearrowright \end{array} \xrightarrow{a+b} \begin{array}{c} \curvearrowleft a \\ \curvearrowleft b \end{array} \right)$$

$$\begin{array}{c} a \longrightarrow \\ b \longrightarrow \end{array} \mapsto \sum_{\alpha \in T(a,b)} (-1)^{|\hat{\alpha}|} \begin{array}{c} a \curvearrowright \\ b \curvearrowright \end{array} \xrightarrow{\alpha} \begin{array}{c} \curvearrowleft a \\ \curvearrowleft b \end{array}$$

and an *unzip* with the projection

$$\text{unzip: } B \left(\begin{array}{c} a \curvearrowright \\ b \curvearrowright \end{array} \xrightarrow{a+b} \begin{array}{c} \curvearrowleft a \\ \curvearrowleft b \end{array} \right) \longrightarrow \mathbf{q}^{-ab} B \left(\begin{array}{c} a \longrightarrow \\ b \longrightarrow \end{array} \right)$$

$$\begin{array}{c} a \curvearrowright \\ b \curvearrowright \end{array} \xrightarrow{a+b} \begin{array}{c} \curvearrowleft a \\ \curvearrowleft b \end{array} \mapsto \begin{array}{c} a \longrightarrow \\ b \longrightarrow \end{array}.$$

The *multiplication* by a homogeneous symmetric polynomial P is the map

$$m_P: B \left(a \longrightarrow \right) \longrightarrow \mathbf{q}^{-\deg P} B \left(a \longrightarrow \right)$$

$$a \longrightarrow \mapsto a \xrightarrow{\bullet} P.$$

Finally, the *associativity* and *coassociativity* foams are assigned the maps

$$\text{as: } B \left(\begin{array}{c} a \searrow \\ b \searrow \\ c \searrow \end{array} \xrightarrow{a+b} a+b+c \right) \longrightarrow B \left(\begin{array}{c} a \searrow \\ b \searrow \\ c \searrow \end{array} \xrightarrow{b+c} a+b+c \right)$$

$$\begin{array}{c} a \searrow \\ b \searrow \\ c \searrow \end{array} \xrightarrow{a+b} a+b+c \mapsto \begin{array}{c} a \searrow \\ b \searrow \\ c \searrow \end{array} \xrightarrow{b+c} a+b+c$$

$$\text{coas: } B \left(a+b+c \xrightarrow{a+b} \begin{array}{c} a \\ b \\ c \end{array} \right) \longrightarrow B \left(a+b+c \xrightarrow{a+b} \begin{array}{c} a \\ b \\ c \end{array} \right)$$

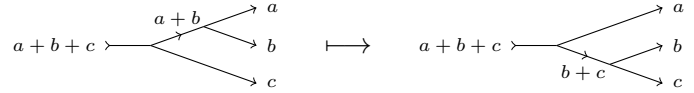

Because of the local nature of the above definitions, they can be interpreted as maps assigned to foams between either planar or annular directed webs. It is known that this assignment preserves local relations.

Proposition 2.29. *When applied to planar directed webs, the above describe a functor of bicategories*

$$B: \mathbf{Foam} \rightarrow \mathbf{sSBim}$$

and in case of annular directed webs, a functor

$$B: \mathcal{AFoam} \rightarrow grAb.$$

Finally, there is a functor

$$\overline{B}: \mathcal{AFoam}^* \rightarrow grAb$$

that assigns the quotient $\overline{B}(\omega) := B(\omega)/(x_u)$ to a marked web ω , where the variable x_u is associated with the edge marked by the basepoint.

2.5. A quantum trace deformation of annular foams. Following [BPW19] one can show that \mathcal{AFoam} is equivalent to the so-called *horizontal trace* $h\text{Tr}(\mathbf{Foam})$ of the bicategory \mathbf{Foam} . What it roughly means is that

- every annular web is isomorphic to a web with vertices away from a fixed *section* $\mu := \{*\} \times \mathbb{R}$ of the annulus $\mathbb{S}^1 \times \mathbb{R}$,
- morphisms are generated by foams that intersect the *membrane* $M := \mu \times [0, 1]$ in a directed web modulo local relations away from the membrane and the *horizontal trace relation* that allows to isotope a piece of a foam through M .

The horizontal trace can be defined on any bicategory and is functorial [BPW19]. Having such a description of \mathcal{AFoam} we can now deform it by replacing the horizontal trace relation with its quantum version, which we will now state more precisely. Notice first that an orientation of the circle $\mathbb{S}^1 \times \{0\} \times \{0\}$ induces a coorientation of the section μ and membrane M . Let W be an annular foam W that intersects M in a web ω and consider a generic admissible ambient isotopy ϕ that pushes M according to its coorientation, so that

- $\phi(W)$ intersects M in a web ω' , and
- $M' := \phi(M)$ intersects M only at the collar, where both M and M' coincide.

Then M and M' bound a 3-ball B with a foam $W \cap B$ from ω' to ω inside. The *quantum horizontal trace relation* states that in this setting

$$W = q^{-\text{deg}(W \cap B)} \phi(W),$$

see Figure 9 for an example.

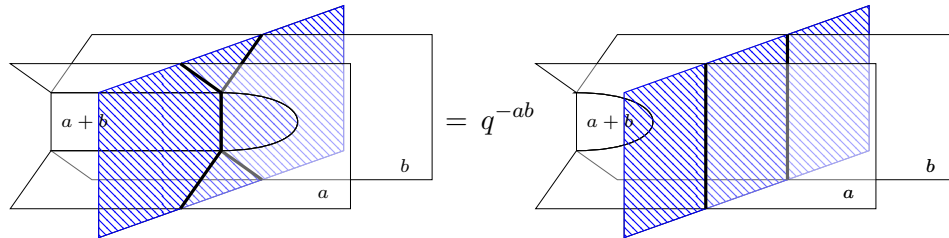

FIGURE 9. The effect of moving a foam through the membrane (depicted in hashed blue).

Definition 2.30. The category \mathcal{AFoam}_q is a deformation of \mathcal{AFoam} , where we consider only annular directed webs that intersect μ generically, whereas on foams we impose the quantum horizontal trace relations and only local relations away from the membrane M . We write $\mathcal{AFoam}_q^{\leq 2}$ for its subcategory generated by elementary webs and foams.

Remark 2.31. The quantum trace relation simply identifies a foam W with $\phi(W)$ when $q = 1$. Hence, in this case \mathcal{AFoam}_q coincides with \mathcal{AFoam} .

Propositions 2.20 and 2.21 are proven locally, so that they still hold in the deformed setting. Likewise, the quantum trace relation is enough for Propositions 2.23 and 2.25.

Proposition 2.32. *There is a functor of categories*

$$(15) \quad B_q: \mathcal{AFoam}_q \rightarrow \text{grMod}$$

that assigns with an annular closure $\widehat{\omega}$ of a web ω the graded \mathbb{k} -module $qHH_0(B(\omega))$. In particular, there is an isomorphism

$$(16) \quad B_q(\widehat{\omega_1 \circ \omega_2}) \cong B_q(\widehat{\omega_2 \circ \omega_1})$$

for any webs $\omega_1: \underline{k} \rightarrow \underline{\ell}$ and $\omega_2: \underline{\ell} \rightarrow \underline{k}$.

Sketch of proof. The functoriality of hTr_q provides a functor

$$\text{hTr}_q(B): \mathbf{Foam} \rightarrow \text{hTr}_q(\mathbf{sSBim}).$$

Because \mathbf{sSBim} has duals, there is a functor on $\text{hTr}_q(\mathbf{sSBim})$ that assigns with a $(R^{\underline{k}}, R^{\underline{k}})$ -bimodule M its quantum space of coinvariants (cp. [BPW19, Section 3.8.2]). Combining the two functors proves the thesis. \square

Let us now unroll the definition of B_q from the above proposition. Pick a web $\widehat{\omega}$ in the annulus $\mathbb{S}^1 \times \mathbb{R}$ that intersects generically the line $\mu = \{*\} \times \mathbb{R}$. Cutting it along μ results in a directed web ω with $\text{in}(\omega) = \text{out}(\omega) = \underline{k}$ for some sequence \underline{k} . To compute $B_q(\widehat{\omega})$, take the singular Soergel bimodule associated with ω and divide it by the quantum trace relation. Explicitly, $B_q(\widehat{\omega})$ is the \mathbb{k} -tensor product

$$D(\omega) = \bigotimes_{e \in E(\omega)} \text{Sym}_{\ell(e)}$$

subjected to the Soergel relations (14) and the quantum trace relation

$$a \xrightarrow{P} \begin{array}{c} | \\ \bullet \\ | \\ q \end{array} = q^{-d} \begin{array}{c} | \\ \bullet \\ | \\ q \end{array} \xrightarrow{P} a$$

where P is a homogeneous symmetric polynomial of degree d .

In a similar way one can deform the category \mathcal{AFoam}^* of marked webs into \mathcal{AFoam}_q^* . Here we always place the basepoint at the preferred section μ and the trace relation is imposed only away from the basepoint.⁶ Notice that the basepoint \star is no longer a mark on an edge, but rather a bivalent vertex with a distinguished edge coming out of it. There is a forgetful functor $\mathcal{AFoam}_q^* \rightarrow \mathcal{AFoam}_q$, which allows us to construct a functor

$$\overline{B}_q: \mathcal{AFoam}_q^* \rightarrow \text{grMod}$$

that takes a marked web $\widehat{\omega}$, represented as a closure of ω , to the quotient

$$\overline{B}_q(\widehat{\omega}) = qHH_0(B(\omega))/(x_\star),$$

where x_\star is the variable associated with edge coming out of the basepoint. However, because of the restricted trace relation in \mathcal{AFoam}_q^* , the cyclicity property (16) does not hold for \overline{B}_q unless

⁶Formally speaking, \mathcal{AFoam}_q^* is a quotient of a *partial horizontal trace* of \mathbf{Foam} .

in one of the webs, ω_1 or ω_2 , the top most endpoints are connected by an interval disjoint from the rest of the web.

We end this section with a result about singular Soergel bimodules, which explains why we take only the quantum trace to define B_q instead of the full quantum Hochschild homology.

Theorem 2.33. *Assume that $1 - q^d$ is invertible for all $d \neq 0$. Then for any sequence \underline{k} and a bimodule $B \in \mathbf{sSBim}(R^{\underline{k}}, R^{\underline{k}})$ one has*

$$qHH_i(R^{\underline{k}}, B) = 0 \quad \text{for } i > 0.$$

Proof. Because singular Soergel bimodules are direct summands of singular Bott–Samelson bimodules, it is enough to prove the formula only for the latter. For that notice that every singular Bott–Samelson bimodule is of the form $B(\omega)$ for some directed web ω . The thesis follows from Propositions 2.23 and 2.13. \square

3. LINK HOMOLOGIES

In this section we recall the definitions of the Gilmore complex computing the knot Floer homology, as well as the ones of the \mathfrak{gl}_1 and \mathfrak{gl}_0 homologies constructed by the last two authors.

3.1. The Gilmore complex and knot Floer homology. The aim of the present section is to give an executive summary of the constructions of [Gil16], where Gilmore recovers the knot Floer homology from a hypercube of resolutions close to Khovanov’s one. Gilmore’s construction works over \mathbb{Z} , but needs to be tensored with \mathbb{F} to reproduce the knot Floer homology. As explained in [OS09, OSS09], statements over \mathbb{Z} are likely to be correct, but this would require a deeper investigation of sign assignments in the definition of Floer homology for general diagrams of singular knots. Such an investigation seems worth pursuing, see Conjecture 2, but will not be discussed here.

In this section we work with coefficients in the ring of Laurent polynomials $\mathbb{L} = \mathbb{Z}[t, t^{-1}]$, where the variable t is a *square root* of what is called t in [OS09, Gil16]. While not necessary to define the complex, this small modification makes it easier to extend the construction to webs and foams in Section 4.1. Braids diagrams are written from left to right and braid closures are performed below the braid itself (see Figure 10).

3.1.1. The polynomial ring of a resolution. Let β be a braid diagram of index k with n crossings, such that its annular closure $\widehat{\beta}$ represents a knot. We denote the set of crossings of β by \mathfrak{X} . We endow $\widehat{\beta}$ with a basepoint \star on the topmost left endpoint of β , see Figure 10. In addition to this base point, $(n + 1)(k - 2) + 1$ bivalent vertices are drawn on $\widehat{\beta}$: for each crossing c , we put at the same x -coordinate $k - 2$ such vertices on strands not involved in the crossing and likewise we add $k - 1$ vertices below the basepoint \star . The last $k - 1$ vertices do not appear in [Gil16], but adding them does not affect the construction much, yet they will play a special role later. They arise naturally as images of the endpoints of the braid in the closure. Therefore, we call them the *trace vertices*. The basepoint itself is a bivalent vertex of a special role. Forgetting about the crossing information, these data can be encoded by an oriented planar graph with bi- and 4-valent vertices. Denote by $\underline{x}(\widehat{\beta})$ the edges of this graph, which we call *semi-arcs* of β , and consider them as formal variables of the polynomial algebra $\mathbb{L}[\underline{x}(\widehat{\beta})]$.

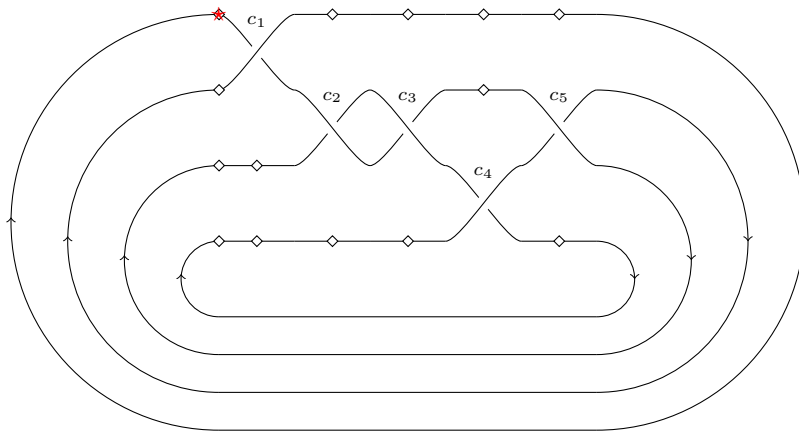
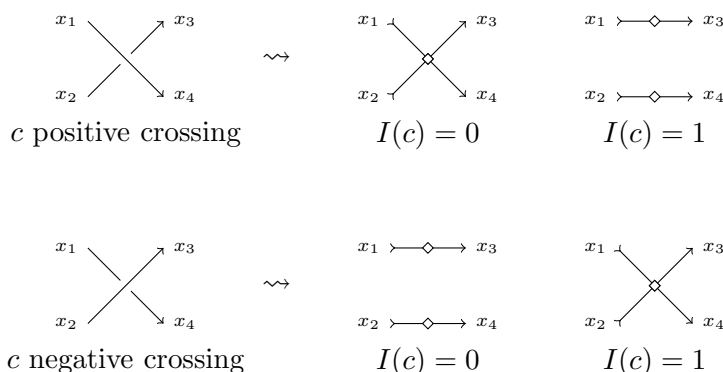

FIGURE 10. Diagram of the closure of $\beta = \sigma_1^{-1}\sigma_2^2\sigma_3^{-1}\sigma_2$ with bivalent vertices and base points. For further reference in examples, we gave names to crossings.

A map $I: \mathfrak{X} \rightarrow \{0, 1\}$ determines a planar oriented graph $\widehat{\beta}_I$, called the I -resolutions of $\widehat{\beta}$, constructed by replacing locally the crossings as follows:



Note that there is a canonical correspondence between edges of $\widehat{\beta}_I$ and semi-arcs of β . For each such resolution $\widehat{\beta}_I$ Gilmore constructs two ideals \mathcal{L}_I and \mathcal{N}_I in $\mathbb{L}[\underline{x}(\widehat{\beta})]$, generated respectively by *local* and *non-local* relations, which are described below.

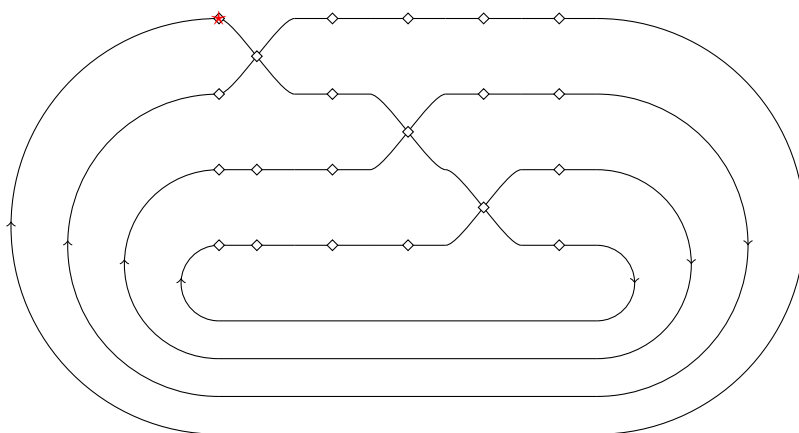

FIGURE 11. The resolution of the braid from Figure 10 associated with $(I(c_i))_{1 \leq i \leq 5} = (0, 0, 1, 0, 0)$.

The ideal \mathcal{L}_I is generated by linear relations L_v and quadratic relations Q_v associated with each vertex v of $\widehat{\beta}_I$ as listed in Table 1. Note the special role of the basepoint.

		
$L_v = x_0$	$L_v = t^2 x_2 - x_1$	$L_v = t^2(x_3 + x_4) - (x_1 + x_2)$
$Q_v = 0$	$Q_v = 0$	$Q_v = t^4 x_3 x_4 - x_1 x_2$

TABLE 1. The local relations associated with bivalent and 4-valent vertices

Non-local relations are parametrized by simple closed paths in $\widehat{\beta}_I$ that are oriented consistently with the diagram and do not pass through the basepoint. Let Z be such a path. It bounds a region R_Z that contains the braid axis. The *weight* $w(Z)$ of Z is twice the number of 4-valent vertices plus the number of bivalent vertices in the closure of R_Z . Denote $NL_Z = t^{2w(Z)} x_{\text{out}(Z)} - x_{\text{in}(Z)}$, where $x_{\text{out}(Z)}$ (respectively $x_{\text{in}(Z)}$) is the product of the edges incident to exactly one vertex of Z that lie outside of R_Z and that point out of (respectively into) the region. The ideal \mathcal{N}_I is generated by NL_Z for all such closed paths Z .

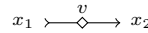
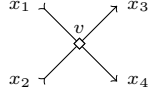
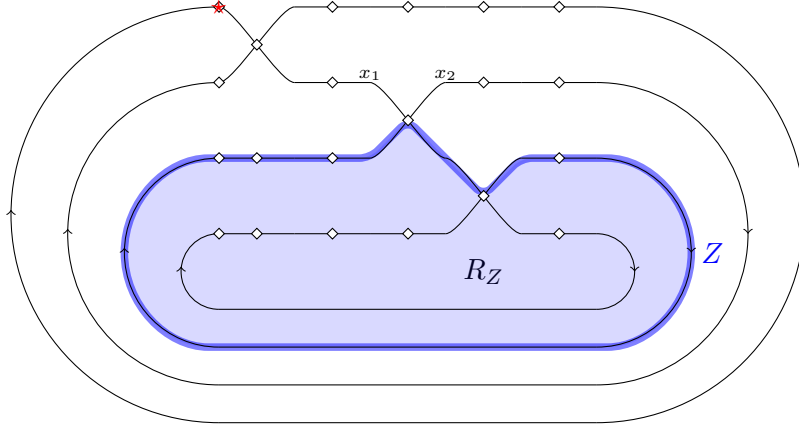

FIGURE 12. Example of a non-local relation for a resolution of Figure 11: the cycle Z is blue and it bounds a region R_Z . In this specific case, $x_{\text{out}(Z)} = x_2$, $x_{\text{in}(Z)} = x_1$, and $w(Z) = 13$, so that $NL_Z = t^{26} x_2 - x_1$.

The central objects under consideration in what follows are the algebras

$$(17) \quad \mathcal{A}(\widehat{\beta}_I) = \frac{\mathbb{L}[\underline{x}(\widehat{\beta})]}{\mathcal{N}_I + \mathcal{L}_I}.$$

They form the building blocks of the hypercube and consequently of the chain complex recovering the knot Floer homology.

3.1.2. Cube of resolutions. The algebras $\mathcal{A}(\widehat{\beta}_I)$ are graded with variables in $\underline{x}(\widehat{\beta})$ in degree 2. We shift the degree by $k - 1 - m(I) + n_- - |I|$, where $|I| = \sum_{c \in \mathfrak{X}} I(c)$ and $m(I)$ is the number of 4-valent vertices in $\widehat{\beta}_I$. Thence, the shifted degree of a homogeneous degree a polynomial in variables $\underline{x}(\widehat{\beta})$ is $2a + k - 1 - m(I) + n_- - |I|$. We call it the *quantum* or *q-grading*.

Remark 3.1. The degree conventions in [Gil16] are different: variables have degree -1 and shifts are adjusted accordingly.

Two resolutions I and I' are *neighboring* if they agree on all but one crossing c , in which case we write $I \xrightarrow{c} I'$ if $I(c) = 0$ and $I'(c) = 1$. For two such neighboring resolutions define a linear map $\partial_{I,c}: \mathcal{A}(\widehat{\beta}_I) \rightarrow \mathcal{A}(\widehat{\beta}_{I'})$ as follows. If c is a positive crossing, then

$$\partial_{I,c}: \mathcal{A} \left(\begin{array}{ccc} x_1 & \times & x_3 \\ & \diagdown \quad \diagup & \\ x_2 & & x_4 \end{array} \right) \longrightarrow \mathcal{A} \left(\begin{array}{ccc} x_1 & \rightsquigarrow & x_3 \\ & \diamond & \\ x_2 & \rightsquigarrow & x_4 \end{array} \right)$$

is induced by the identity on $\mathbb{L}[\underline{x}(\widehat{\beta})]$. If c is a negative crossing, then

$$\partial_{I,c}: \mathcal{A} \left(\begin{array}{ccc} x_1 & \rightsquigarrow & x_3 \\ & \diamond & \\ x_2 & \rightsquigarrow & x_4 \end{array} \right) \longrightarrow \mathcal{A} \left(\begin{array}{ccc} x_1 & \times & x_3 \\ & \diagdown \quad \diagup & \\ x_2 & & x_4 \end{array} \right)$$

is induced by the $\mathbb{L}[\underline{x}(\widehat{\beta})]$ -linear endomorphism of $\mathbb{L}[\underline{x}(\widehat{\beta})]$ that maps 1 onto $t^2x_4 - x_1$ (or equivalently onto $t^2x_3 - x_2$). It is an easy exercise to show that these maps are well-defined. Note that both maps respect the q -grading.

One can arrange graded modules $\mathcal{A}(\widehat{\beta}_I)$ and maps $\partial_{I,c}$ into an n -dimensional hypercube once a total order \prec on the set of crossings is fixed, so that one can identify a resolution with a finite sequence of 0's and 1's. Flattening this hypercube yields a chain complex of graded modules. More precisely, the chain groups are given by direct sums⁷

$$C_i^{AG}(\beta) := \bigoplus_{|I|=i+n_-} \mathcal{A}(\widehat{\beta}_I),$$

and the differential $\partial_i: C_i^{AG}(\beta) \rightarrow C_{i-1}^{AG}(\beta)$ is the sum

$$\partial_i := \sum_{\substack{I: |I|=i \\ c: I(c)=0}} (-1)^{I_{\prec c}} \partial_{I,c},$$

where $I_{\prec c} := \sum_{c' \prec c} I(c')$. A standard argument ensures that the isomorphism type of this chain complex does not depend on the total order \prec .

Remark 3.2. Another way of presenting this construction is to say that one takes iterated cones of the homomorphisms $\partial_{I,c}$ associated with each crossings.

3.1.3. Other coefficients. The above construction can be repeated with the ring \mathbb{L} replaced with any \mathbb{L} -module L . In this case we write $\mathcal{A}(\widehat{\beta}_I; L)$ for the analogue of the Gilmore algebra and $C^{AG}(\beta; L)$ for the chain complex associated with a braid diagram β . Equivalently,

$$\mathcal{A}(\widehat{\beta}_I; L) \cong \mathcal{A}(\widehat{\beta}_I) \otimes_{\mathbb{L}} L \quad \text{and} \quad C^{AG}(\beta; L) \cong C^{AG}(\beta) \otimes_{\mathbb{L}} L.$$

We shall now discuss a few special cases.

Example 3.3. Let $L := \widehat{\mathbb{L}} = \mathbb{Z}[t^{-1}, t]$ be the completion of \mathbb{L} , defined as the ring of power series in t with possibly finitely many terms with a negative power of t . In this ring $1 - t^n$ is invertible for $t \neq 0$, which simplifies the spaces considerably: $\mathcal{A}(\widehat{\beta}_I; \widehat{\mathbb{L}}) = 0$ when the resolution is disconnected. Indeed, a curve separating two connected component of $\widehat{\beta}_I$ gives a non-local relation of the form $1 - t^n = 0$ for some $n > 0$.

Example 3.4. Identify now \mathbb{Z} with the \mathbb{L} -module $\mathbb{L}/(t-1)$. Computing $C^{AG}(\beta; \mathbb{Z})$ is equivalent to setting $t = 1$. The non-local relation associated with a separating curve becomes trivial in this case, so that $\mathcal{A}(\widehat{\beta}_I; \mathbb{Z})$ does not vanish for disconnected resolutions.

⁷The upper index *AG* refers to Allison Gilmore.

The most interesting case is $L = \mathbb{F}[t^{-1}, t]$, the modulo two reduction of Example 3.3, because with coefficients in this ring the Gilmore complex recovers the knot Floer homology. More precisely, let us denote by $\widehat{CFK}(K)$ a chain complex over \mathbb{F} used to compute the knot Floer complex $\widehat{HFK}(K)$ for a knot K and recall that both admit Maslov (homological) and Alexander gradings.

Theorem 3.5 ([Gil16, Proposition 9.1], [OS09, Theorem 1.2]). *Assume that a knot K is the closure of a braid β . Then there is a quasi-isomorphism $\widehat{CFK}(K) \otimes \mathbb{F}[t^{-1}, t] \longrightarrow C^{AG}(\beta; \mathbb{F}[t^{-1}, t])$ of chain complexes of graded $\mathbb{F}[t^{-1}, t]$ -modules.*

In fact, a detailed analysis of the proof reveals that the connecting chain map can be constructed over $\mathbb{F}[t, t^{-1}]$. Indeed, the complex $\widehat{CFK}(K) \otimes \mathbb{F}[t, t^{-1}]$ is homotopy equivalent to a complex constructed from the cube of resolutions with vertices decorated by certain complexes $\widehat{CFS}(\widehat{\beta}_I)$ of $\mathbb{F}[t, t^{-1}]$ -modules, called the *twisted singular Floer homology*. Each complex $\widehat{CFS}(\widehat{\beta}_I)$ contains a canonical generator, sending which to $1 \in \mathcal{A}(\widehat{\beta}_I)$ defines a component-wise epimorphic chain map

$$(18) \quad \Phi: \widehat{CFK}(K) \otimes \mathbb{F}[t, t^{-1}] \longrightarrow C^{AG}(\widehat{\beta})$$

that becomes a quasi-isomorphism when the coefficients are extended to the completed ring.

3.2. \mathfrak{gl}_1 homology. The technology developed here was first introduced in [RW20b] using *foam* in a more general framework. It was recasted in [RW19] in a foam-free framework. Here we use this latter point of view to recall the construction. Unless stated otherwise, in this section we work with integral coefficients.

With a web ω we have associated in Section 2.4 the *space of decorations* $D(\omega) = \bigotimes_{u \in E(\omega)} R_u$, where the *edge ring* R_u consists of symmetric polynomials in as many variables as the thickness of the edge u . A pure tensor from $D(\omega)$ is visualized by dots on ω , see Figure 8. In what follows we will consider quotients and subquotients of $D(\omega)$.

Definition 3.6. Let ω be an annular web of index k . Denote by $\mathcal{P}(\{X_1, \dots, X_k\})$ the power set⁸ of $\{X_1, \dots, X_k\}$. An *omnichrome coloring* of ω is a map $c: E(\omega) \rightarrow \mathcal{P}(\{X_1, \dots, X_k\})$, such that

- for each edge $u \in E(\omega)$ the cardinality of $c(u)$ equals the thickness of u ,
- given a generic section r of the annulus, the union of the sets $c(u)$ for all edges u intersecting r is equal to $\{X_1, \dots, X_k\}$, and
- the *flow condition* holds: if u_1, u_2 and u_3 are three adjacent edges with $\ell(u_1) = \ell(u_2) + \ell(u_3)$, then $c(u_1) = c(u_2) \sqcup c(u_3)$.

The set $c(u)$ is called the *color of u* .

The definition of omnichrome colorings has several direct implications.

- (1) At each vertex of ω , the color of the thickest edge is the disjoint union of the colors of the two thin edges.
- (2) For a generic section r of the annulus, the union of sets $c(u)$ associated with the edges u that intersect r is actually a disjoint union.
- (3) Each coloring c induces an algebra homomorphism $\varphi_c: D(\omega) \rightarrow \mathbb{Z}[X_1, \dots, X_k]$ that for every edge u identifies the ring R_u with the subring $\mathbb{Z}[c(u)]^{\mathfrak{S}_{\ell(u)}}$.

Let ω be an annular web and c be an omnichrome coloring of ω . For each split vertex v , denote by $u_l(v)$ and $u_r(v)$ the left and right edges going out of v . Set

$$Q(\omega, c) := \prod_{\substack{v \text{ split} \\ \text{vertex}}} \prod_{\substack{X_i \in c(u_l(v)) \\ X_j \in c(u_r(v))}} (X_i - X_j).$$

⁸The power set of a set S is the family of all subsets of S .

Given a pure tensor $T \in D(\omega)$ write T_u for the factor associated with an edge u . We set:

$$P(\omega, T, c) = \varphi_c(T) = \prod_{u \in E(\omega)} T_u(c(u))$$

and extend it linearly to all elements of $D(\omega)$. Finally, define

$$\langle \omega, T, c \rangle_\infty = \frac{P(\omega, T, c)}{Q(\omega, c)}.$$

Example 3.7. Consider the omnichrome coloring c

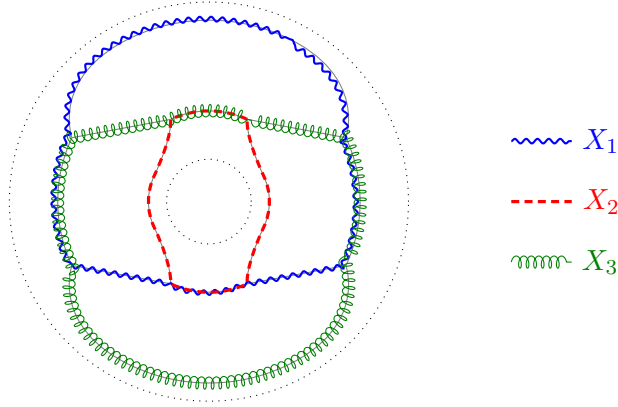

of the decorated annular web (ω, T) from Figure 8. We compute

$$\begin{aligned} P(\omega, T, c) &= X_2^2 X_1 X_3, \\ Q(\omega, T, c) &= (X_3 - X_1)(X_2 - X_3)(X_1 - X_3)(X_2 - X_1) \end{aligned}$$

so that

$$\langle \omega, T, c \rangle_\infty = \frac{X_2^2 X_1 X_3}{(X_3 - X_2)(X_2 - X_1)(X_3 - X_1)^2}.$$

Definition 3.8. Choose an annular web ω . The ∞ -evaluation of $T \in D(\omega)$ is the sum

$$\langle \omega, T \rangle_\infty = \sum_{c \text{ omnichrome coloring}} \langle \omega, T, c \rangle_\infty$$

and the ∞ -pairing is the bilinear form $\langle -, \omega; - \rangle_\infty$ on $D(\omega)$, defined on decorations S and T as $\langle S; \omega; T \rangle_\infty := \langle \omega, ST \rangle_\infty$. The \mathfrak{gl}_∞ -state space of ω is the quotient

$$\mathcal{S}_\infty(\omega) := D(\omega) / \ker \langle -, \omega; - \rangle_\infty.$$

For another ring of coefficients \mathbb{k} we set $\mathcal{S}_\infty(\omega, \mathbb{k}) := \mathcal{S}_\infty(\omega) \otimes_{\mathbb{Z}} \mathbb{k}$.

Proposition 3.9. Choose an annular web ω of index k .

- (1) The ∞ -evaluation $\langle \omega, T \rangle_\infty$ is a symmetric polynomial in X_1, \dots, X_k for any $T \in D(\omega)$.
- (2) The graded \mathbb{k} -modules $\mathcal{S}_\infty(\omega, \mathbb{k})$ and $B(\omega)$ coincide when seen as quotients of $D(\omega)$. In particular, the Soergel relations (14) hold in $\mathcal{S}_\infty(\omega, \mathbb{k})$.

Proof. The first statement is the content of [RW19, Lemma 3.13] and the second one follows directly from [RW20b, Proposition 4.18], because $B(\omega)$ coincides with $qHH_0(B(\tilde{\omega}))$ when ω is a closure of a directed web $\tilde{\omega}$. \square

Definition 3.10. Choose an annular web ω of index k . Define the \mathfrak{gl}_1 -evaluation of $T \in D(\omega)$ by

$$\langle \omega, T \rangle_1 := (\langle \omega, T \rangle_\infty)_{|X_1, \dots, X_k \mapsto 0}.$$

In other words, $\langle \omega, T \rangle_1$ is the constant coefficient of $\langle \omega, T \rangle_\infty$. The \mathfrak{gl}_1 -pairing on ω is the bilinear form $\langle -; \omega; - \rangle_1$ on $D(\omega)$ defined on decorations S and T by $\langle S; \omega; T \rangle_1 := \langle \omega, ST \rangle_1$. The \mathfrak{gl}_1 -state space of ω is the quotient

$$\mathcal{S}_1(\omega) := D(\omega) / \ker \langle -; \omega; - \rangle_1.$$

For another ring of coefficients \mathbb{k} we set $\mathcal{S}_1(\omega, \mathbb{k}) = \mathcal{S}_1(\omega) \otimes_{\mathbb{Z}} \mathbb{k}$.

Following its very definition $\mathcal{S}_1(\omega)$ is a quotient of $B(\omega)$.

Proposition 3.11 ([RW20b, RW19]).

- (1) The assignment $\omega \mapsto \mathcal{S}_1(\omega)$ extends to a functor $\mathcal{S}_1: \mathcal{AFoam} \rightarrow \mathcal{Ab}$ that is a quotient of the functor from Section 2.4. In particular, the isomorphisms from Proposition 2.20 induce isomorphisms between \mathfrak{gl}_1 -state spaces.
- (2) $\mathcal{S}_1(\omega)$ is a free graded abelian group for any web ω . It has rank 1 and is concentrated in quantum degree 0 in case ω is a collection of concentric circles.
- (3) Suppose that a generic section of the annulus intersects edges u_1, \dots, u_s of a annular web ω and let $P \in D(\omega)$ represent a symmetric polynomial in variables $T_{u_1} \sqcup \dots \sqcup X_{u_s}$. Then T annihilates $\mathcal{S}_1(\omega)$.

Let L be a link presented as a braid closure $\widehat{\beta}$ and write \mathfrak{X} for its set of crossings. With a map $I: \mathfrak{X} \rightarrow \{0, 1\}$ we associate an annular web $V_I(\beta)$, the I -resolutions of $\widehat{\beta}$, according to the following rules:

$$(19) \quad \begin{array}{ccc} \begin{array}{c} 1 \quad \quad \quad 1 \\ \quad \quad \quad \diagdown \quad \diagup \\ \quad \quad \quad \diagup \quad \diagdown \\ 1 \quad \quad \quad 1 \\ c \text{ positive crossing} \end{array} & \rightsquigarrow & \begin{array}{c} 1 \quad \quad \quad 1 \\ \quad \quad \quad \curvearrowright \quad \curvearrowleft \\ \quad \quad \quad 2 \\ \quad \quad \quad \curvearrowleft \quad \curvearrowright \\ 1 \quad \quad \quad 1 \\ I(c) = 0 \end{array} \quad \begin{array}{c} 1 \quad \quad \quad 1 \\ \quad \quad \quad \longrightarrow \\ \quad \quad \quad \longrightarrow \\ 1 \quad \quad \quad 1 \\ I(c) = 1 \end{array} \\ \\ \begin{array}{c} 1 \quad \quad \quad 1 \\ \quad \quad \quad \diagdown \quad \diagup \\ \quad \quad \quad \diagup \quad \diagdown \\ 1 \quad \quad \quad 1 \\ c \text{ negative crossing} \end{array} & \rightsquigarrow & \begin{array}{c} 1 \quad \quad \quad 1 \\ \quad \quad \quad \longrightarrow \\ \quad \quad \quad \longrightarrow \\ 1 \quad \quad \quad 1 \\ I(c) = 0 \end{array} \quad \begin{array}{c} 1 \quad \quad \quad 1 \\ \quad \quad \quad \curvearrowleft \quad \curvearrowright \\ \quad \quad \quad 2 \\ \quad \quad \quad \curvearrowright \quad \curvearrowleft \\ 1 \quad \quad \quad 1 \\ I(c) = 1 \end{array} \end{array}$$

As in the previous section, for two neighboring resolutions $I \xrightarrow{c} I'$ there is an associated homomorphism $\partial_{I,c}: \mathcal{S}_1(V_I(\beta)) \rightarrow \mathcal{S}_1(V_{I'}(\beta))$: the zip map when c is a positive crossing and the unzip map otherwise. Diagrammatically, this reads:

$$\begin{array}{l} \partial_{I,c} \left(\begin{array}{c} 1 \quad \quad \quad 1 \\ \quad \quad \quad \curvearrowright \quad \curvearrowleft \\ \quad \quad \quad 2 \\ \quad \quad \quad \curvearrowleft \quad \curvearrowright \\ 1 \quad \quad \quad 1 \end{array} \right) = \begin{array}{c} 1 \quad \quad \quad 1 \\ \quad \quad \quad \longrightarrow \\ \quad \quad \quad \longrightarrow \\ 1 \quad \quad \quad 1 \end{array} \quad \text{if } c \text{ is positive,} \\ \\ \partial_{I,c} \left(\begin{array}{c} 1 \quad \quad \quad 1 \\ \quad \quad \quad \longrightarrow \\ \quad \quad \quad \longrightarrow \\ 1 \quad \quad \quad 1 \end{array} \right) = \begin{array}{c} 1 \quad \quad \quad 1 \\ \quad \quad \quad \curvearrowleft \quad \curvearrowright \\ \quad \quad \quad 2 \\ \quad \quad \quad \curvearrowright \quad \curvearrowleft \\ 1 \quad \quad \quad 1 \end{array} - \begin{array}{c} 1 \quad \quad \quad 1 \\ \quad \quad \quad \curvearrowright \quad \curvearrowleft \\ \quad \quad \quad 2 \\ \quad \quad \quad \curvearrowleft \quad \curvearrowright \\ 1 \quad \quad \quad 1 \end{array} \quad \text{if } c \text{ is negative.} \end{array}$$

Therefore one obtains a hypercube, that we can think of as a multicomplex of graded free \mathbb{k} -modules. Flattening this multicomplex produces an honest chain complex of graded \mathbb{k} -modules $C^{\mathfrak{gl}_1}(\beta; \mathbb{k})$ with homology denoted by $H^{\mathfrak{gl}_1}(\beta; \mathbb{k})$; we call it the \mathfrak{gl}_1 -homology of β .

Theorem 3.12 ([RW20b]). *If \mathbb{k} is a field of characteristic 0, then \mathfrak{gl}_1 -homology $H^{\mathfrak{gl}_1}$ is a link invariant. Its graded Euler characteristic is 1 for every link.*

Remark 3.13. The construction in [RW20b] is done in an equivariant setting and over \mathbb{Q} . Here we consider a simpler non-equivariant setting, in which case the construction can be performed with integral coefficients. The proof of invariance, however, requires inverses of nonzero integers, see [RW20b, Lemma 5.21] and [RW20b, Lemma 5.25].

Remark 3.14. This invariant can be easily extended to links colored by arbitrary positive integers. The setup described here corresponds to the case where all components are colored by 1, known as the uncolored case.

3.3. \mathfrak{gl}_0 homology. The material of this section is extracted from [RW19]. Let K be a knot represented as a closure $\widehat{\beta}$ of a braid diagram β of index k . As in previous sections, braids are depicted horizontally from left to right and the closure is performed below the braid.

Consider the chain complex $C^{\mathfrak{gl}_1}(\widehat{\beta}; \mathbb{k})$. Having picked a basepoint \star on $\widehat{\beta}$, one defines an endomorphism φ_\star of $C^{\mathfrak{gl}_1}(\widehat{\beta}; \mathbb{k})$ that multiplies the decoration of the marked edge by x^{k-1} . Diagrammatically, this reads:

$$\text{---}\star\text{---}\rightarrow 1 \quad \mapsto \quad \text{---}\overset{k-1}{\bullet}\text{---}\rightarrow 1.$$

The fact that this is indeed a chain map follows from the locality of the differential and φ_\star . The image of φ_\star is a subcomplex of $C^{\mathfrak{gl}_1}(\widehat{\beta}; \mathbb{k})$.

For a given braid β , let us place a basepoint on the top left endpoint of the braid diagram, and denote by $C^{\mathfrak{gl}_0}(\beta; \mathbb{k})$ and $H^{\mathfrak{gl}_0}(\beta; \mathbb{k})$ the chain complex $\mathbf{q}^{1-k} \text{Im}(\varphi_\star)$ and its homology. It is called the \mathfrak{gl}_0 -homology of K . Of course, one can act with φ_\star on $\mathcal{S}_1(\omega; \mathbb{k})$ for any marked annular web ω_\star .⁹ The image defines a space $\mathcal{S}'_0(\omega_\star; \mathbb{k})$ called the \mathfrak{gl}_0 state space of ω_\star .

Theorem 3.15 ([RW19]).

- (1) If \mathbb{k} is a field, then the bigraded \mathbb{k} -vector space $H^{\mathfrak{gl}_0}(\beta; \mathbb{k})$ is an invariant of the knot $K = \widehat{\beta}$. Its graded Euler characteristic is the Alexander polynomial $\Delta_{\widehat{\beta}}(\mathbf{q})$ normalized to satisfy the skein relation (1).
- (2) There is a bigraded spectral sequence from the reduced triply graded homology to the \mathfrak{gl}_0 -homology.

Remark 3.16.

- (1) In [RW19], everything is defined and stated over \mathbb{Q} . There is no difficulty for extending definition over \mathbb{Z} or any ring \mathbb{k} . The fact that \mathbb{k} is a field is needed for proving that the construction is independent from the base point: in the proof of [RW19, Proposition 5.6], one needs to know that the homology of a chain complex has no torsion.
- (2) It is important to notice that, contrary to $H^{\mathfrak{gl}_1}$, there is no condition on the invertibility of any integers. This comes from the fact that proofs of invariance under the first Markov move (stabilization) are very different in the two contexts.
- (3) The same definition works for links with a base point. However the resulting homology may depend on the component of the link where the base point is placed. We do not have an example, though, for which different choices of components yield different invariants.

The endomorphism φ_\star used to define $C^{\mathfrak{gl}_0}$ admits an alternative description. Instead of adding $k-1$ dots on the edge with base point, one can add a dot on each edge below the base point.

⁹We write ω_\star to emphasize a choice of a basepoint on the web ω . When this is less relevant, the reference to the basepoint \star may be dropped.

Indeed, in $\mathcal{S}_1(\omega)$, the following relation holds

$$k \left\{ \begin{array}{l} \xrightarrow{k-1} 1 \\ \xrightarrow{\bullet} 1 \\ \xrightarrow{\quad} 1 \\ \vdots \\ \xrightarrow{\quad} 1 \end{array} \right\} = (-1)^{k-1} \left\{ \begin{array}{l} \xrightarrow{\quad} 1 \\ \xrightarrow{\bullet} 1 \\ \xrightarrow{\bullet} 1 \\ \vdots \\ \xrightarrow{\bullet} 1 \end{array} \right\} k$$

because of the equality $x_2 \cdots x_k = \sum_{i=1}^k (-1)^{i-1} x_1^{i-1} e_{k-i}(x_1, \dots, x_k)$ and Proposition 3.11 (3). The signs in this formula has absolutely no consequence on the definition of $C^{\mathfrak{gl}_0}$ since we are only interested in the image of φ_\star .

Remark 3.17. The chain complex $C^{\mathfrak{gl}_0}(\beta)$ is defined as a subcomplex of $\mathfrak{q}^{1-k} C^{\mathfrak{gl}_1}(\widehat{\beta})$, where k is the number of strands in the braid β . Since the functor \mathcal{S}_1 is defined via a universal construction, one can change of the point of view and construct $C^{\mathfrak{gl}_0}(\beta)$ as a quotient of $\mathfrak{q}^{k-1} C^{\mathfrak{gl}_1}(\widehat{\beta})$. Indeed, given a decoration T of ω consider a linear form Ψ_T on $D(\omega)$ defined by $\Psi_T(S) = \langle \omega, ST \rangle$. By definition,

$$\mathcal{S}_1(\omega) = D(\omega) / \bigcap_{T \in D(\omega)} \ker(\Psi_T).$$

For a marked annular web ω_\star define $\mathcal{S}'_0(\omega_\star)$ as the image of $\mathcal{S}_1(\omega)$ under the homomorphism $\varphi_\star: \mathfrak{q}^{k-1} \mathcal{S}_1(\omega) \rightarrow \mathfrak{q}^{1-k} \mathcal{S}_1(\omega)$. Note that the map φ_\star is the multiplication by a decoration, say R_\star . Hence

$$(20) \quad \mathcal{S}'_0(\omega_\star) \cong \mathfrak{q}^{k-1} D(\omega) / \bigcap_{T \in D(\omega)} \ker(\Psi_{R_\star T}).$$

Clearly, $\bigcap_{T \in D(\omega)} \ker(\Psi_{R_\star T}) \subseteq \bigcap_{T \in D(\omega)} \ker(\Psi_T)$ and the isomorphism (20) commutes with the differentials, so that $C^{\mathfrak{gl}_0}(\beta)$ is a quotient of $\mathfrak{q}^{k-1} C^{\mathfrak{gl}_1}(\widehat{\beta})$. In particular, for any marked annular web ω_\star , the space $\mathcal{S}'_0(\omega_\star; \mathbb{k})$ is a quotient of $B(\omega)$.

4. MAIN RESULTS

4.1. Revised Gilmore complex. The aim of this section is to give another point of view on constructions described in Section 3.1 and to generalize them to all webs. In this section we work with coefficients in an arbitrary commutative ring \mathbb{k} with a fixed invertible element q .

Choose a marked annular web ω_\star . Recall that the basepoint is required to mark an edge of thickness 1 that is at the same time an outmost edge. Suppose that γ is a simple closed curve representing a generator of the homology of the ambient annulus, identified here with a punctured plane. We say that such a curve is *adapted to ω_\star* if it avoids vertices of the web, intersects its edges transversally, and the region R_γ bounded by the curve does not contain the basepoint \star . The intersection points between ω and γ fall into two categories: *incoming* and *outgoing* points, at which the web is oriented inwards and outwards the region R_γ respectively.

In Section 2.5 we have associated with a marked annular web ω_\star the polynomial algebra $\overline{B}_q(\omega_\star) = qHH_0(R^k; B(\tilde{\omega})) / (x_\star)$, where x_\star is the variable associated with the edge coming out of the basepoint and $\tilde{\omega}$ is the directed web obtained by cutting the anulus along the membrane. Consider the ideal $\mathcal{N}_\omega \subset \overline{B}_q(\omega_\star)$ of non-local relations defined as follows. Pick a curve γ adapted to ω_\star and write $e_{\text{top}}(X_p)$ for the product of variables associated with the edge containing the intersection point $p \in \omega \cap \gamma$. Define

$$x_{\text{in}(\gamma)} := \prod_{p \in (\omega \cap \gamma)^+} e_{\text{top}}(X_p) \quad x_{\text{out}(\gamma)} := \prod_{p \in (\omega \cap \gamma)^-} e_{\text{top}}(X_p),$$

where $(\omega \cap \gamma)^+$ and $(\omega \cap \gamma)^-$ are respectively the sets of incoming and outgoing intersection points, and put

$$(21) \quad NL_\gamma^\omega := x_{\text{out}(\gamma)} - q^{2i} x_{\text{in}(\gamma)},$$

where i is the number of trace vertices in the bounded region R_γ . Note that γ may intersect an edge several times, in which case the variables associated with such an edge appear in both products, possibly with exponents bigger than 1. The ideal \mathcal{N}_ω is generated by NL_γ for all such curves γ .

Definition 4.1. The quotient space

$$\mathcal{A}'(\omega_\star) = \overline{B}_q(\omega_\star) / \mathcal{N}_\omega$$

is called the *Gilmore space* of the marked annular web ω_\star .

Following the common practice we write $\mathcal{A}'(\omega_\star; \mathbb{k})$ to emphasize the choice of coefficients.

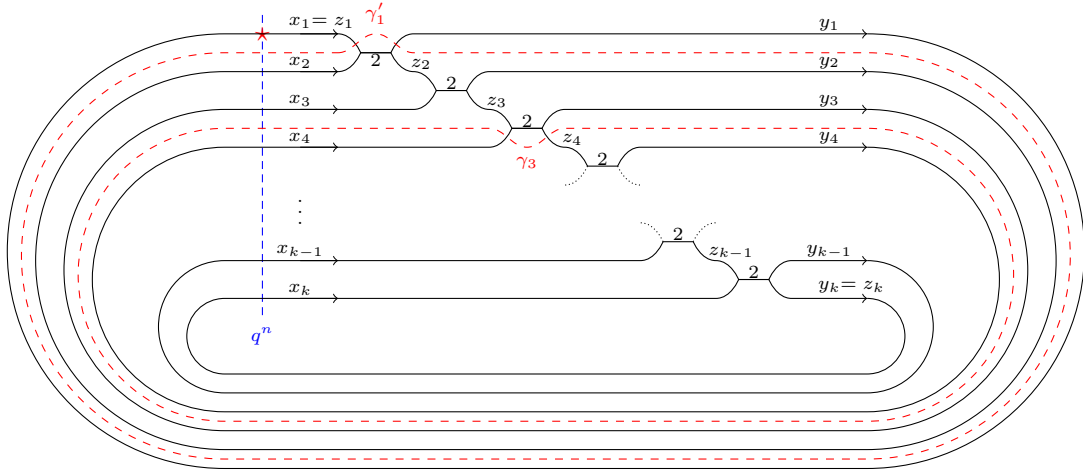
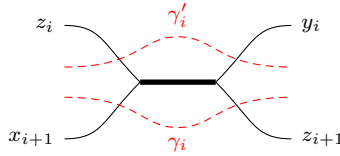

FIGURE 13. A chain of dumbbells with a membrane and a basepoint.

Example 4.2. If ω is a chain of dumbbells (see Figure 13), then $\mathcal{A}'(\omega) \cong \mathbb{k}$ is generated by the constant polynomial if $1 - q^n$ is invertible for each $n > 1$. To see this, assign to thin edges of ω variables x_i, y_i , and z_i for $i = 1, \dots, k$, so that at the i -th thick edge we have the following situation:



where the curves γ and γ' have no more intersections with ω and the edges with variables x_i and y_i meet at a trace vertex, so that $x_i = q^2 y_i$. It is understood that $z_0 = x_0$ and $z_k = y_k$. The non-local relations associated with curves γ_i and γ'_i forces $z_i = q^{2i-2k} y_i$ for each i . Substituting that in the linear local relation

$$z_i + x_{i+1} = y_i + z_{i+1}$$

forces $(q^{2i-2k} - 1)(y_i - q^2 y_{i+1}) = 0$, from which it follows that all variables are proportional to each other. In particular, to x_1 , which is killed by the basepoint relation. Finally, since there is no non-trivial relation involving polynomials of degree 0, one has $\mathcal{A}'(\omega) \cong \mathbb{k}$ as claimed.

We shall now show that the above construction coincides with the one from Section 3.1. For that choose a Gilmore resolution $\widehat{\beta}_I$ of a braid closure $\widehat{\beta}$ and let $\widehat{\beta}_I^\omega$ be the analogous web resolution, which can be constructed from the former by forgetting bivalent vertices in $\widehat{\beta}_I$ except the trace vertices and by expanding singular crossings to thick edges. Recall that the Gilmore space $\mathcal{A}(\widehat{\beta}_I)$ is generated over $\mathbb{L} = \mathbb{Z}[t, t^{-1}]$ by variables associated with semi-arcs of β . In what follows we write x_α for the variable associated with a semi-arc α .

Proposition 4.3. *Let $\mathbb{k} = \mathbb{L}$ with $q = t^{-(n+1)}$, where n is the number of crossings in β . Then there is an isomorphism*

$$\mathcal{A}(\widehat{\beta}_I) \ni x_\alpha \xrightarrow{\cong} t^{-2n(\alpha)} x_{\bar{\alpha}} \in \mathcal{A}'(\widehat{\beta}_I^\omega; \mathbb{L}),$$

where $\bar{\alpha}$ is the edge of ω that contains the image of the semi-arc α in the resolution and $n(\alpha)$ is the number of crossings in β to the left of α .

Before giving a proof of the above proposition, let us discuss the analogue of the relation NL_γ in the original Gilmore's framework. For that define $\mathcal{N}'_I \subset \mathbb{L}[\underline{x}(\widehat{\beta})]$ as the ideal generated by the elements

$$(22) \quad NL_\gamma := t^{2w(\gamma)} x_{\text{out}(\gamma)} - x_{\text{in}(\gamma)},$$

where $w(\gamma)$ of γ is twice the number of 4-valent vertices plus the number of bivalent vertices of $\widehat{\beta}_I$ contained in R_γ . Notice that $\mathcal{N}'_I \supset \mathcal{N}_I$. Indeed, if Z is a path in $\widehat{\beta}_I$ considered in Section 3.1.1, then the boundary of a small tubular neighbourhood of the region R_Z is a curve γ adapted to $\widehat{\beta}_I$ and $NL_\gamma = NL_Z$. Not every curve adapted to $\widehat{\beta}_I$ is of this form, so *a priori* \mathcal{N}'_I might contain more relations. This is not the case.

Lemma 4.4. *The canonical quotient map*

$$\pi: \mathcal{A}(\widehat{\beta}_I) \longrightarrow \frac{\mathbb{L}[\underline{x}(\widehat{\beta})]}{\mathcal{N}'_I + \mathcal{L}_I}$$

is an isomorphism.

Proof. We have already seen that \mathcal{N}'_I contains \mathcal{N}_I , so that π is a well-defined epimorphism. Hence, to prove the thesis it suffices to show that $\mathcal{N}'_I \subset \mathcal{N}_I + \mathcal{L}_I$. For that we use another description of relations in $\mathcal{A}(\widehat{\beta}_I)$. In [Gil16, Definition 3.3] a relation NL_S is associated with a subset S of vertices of the graph $\widehat{\beta}_I$. These relations generate not only relations from \mathcal{N}_I , but also a subset of local relations (when S contains a single vertex). We claim that if a curve γ is adapted to $\widehat{\beta}_I$ and S is the set of vertices inside the bounded region R_γ , then $NL_\gamma = m_\gamma NL_S$, where m_γ is the largest monomial factor of NL_γ . First, notice that x appears in m_γ with power d exactly when γ intersects the associated edge in $2d$ or $2d + 1$ points. In the first case both endpoints of the edge are either in S or outside of S and x does not contribute to NL_S . In the latter case exactly one endpoint of the edge is in S , whereas the remaining copy of x contributes towards $x_{\text{out}(\gamma)}$ if the source of the edge is in S and towards $x_{\text{in}(\gamma)}$ otherwise. This is exactly how the relation NL_S is defined. \square

Proof of Proposition 4.3. Renormalize the basis of $\mathcal{A}(\widehat{\beta}_I)$ by setting $\tilde{x}_\alpha := t^{2n(\alpha)} x_\alpha$. Clearly, the local relations at non-trace vertices do not involve t anymore, whereas at a trace vertex the linear relation $x_r = t^2 x_\ell$ is replaced with $\tilde{x}_r = t^{2n+2} \tilde{x}_\ell$, that coincides with the quantum trace relation $\tilde{x}_r = q^{-2} \tilde{x}_\ell$. In particular, variables at both sides of a bivalent vertex other than the trace vertex are identified. It remains to show that the non-local relation NL_γ associated with a nice curve γ takes the form (21) when rewritten in the new basis. For that resolve $\widehat{\beta}_I$ into a collection of concentric loops ℓ_1, \dots, ℓ_k by replacing every singular crossing with two vertical lines, each with a bivalent vertex on it. The exponent $w(\gamma)$ counts then bivalent vertices inside γ . As before, let i be the number of trace vertices surrounded by γ .

Consider first a loop ℓ_r , the trace vertex of which is inside γ . If it is entirely contained by γ , then it contributes exactly $2n + 2$ towards the power of t . Otherwise, each arc with s bivalent vertices outside of γ

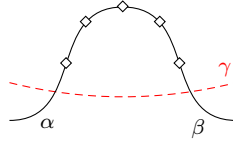

lowers the contributions of the loop towards $w(\gamma)$ by $2s$. However, the semi-arcs α and β containing the bottom and top endpoints of the arc satisfy $n(\beta) = n(\alpha) + s$, so that renormalizing the variables increases the contribution back. Hence, in the renormalized basis, each such loop contributes exactly $2n + 2$ towards $w(\gamma)$.

Conversely, if the trace vertex of ℓ_r is outside of γ , then ℓ_r does not contribute towards the power of t . Indeed, for every arc of ℓ_r with s vertices inside γ

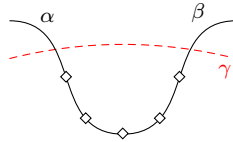

and the bottom and top endpoints on semi-arcs α and β respectively, we have $n(\beta) - n(\alpha) = s$. Hence, renormalizing variables lowers the power of t by $2s$, cancelling the contribution of the vertices from the arc.

Therefore, the power of t in NL_γ , when rewritten in the new basis, is equal to $2i(n + 1)$ as desired. \square

4.2. Functoriality. The main advantage of Definition 4.1 over the original one is its independence on the number of crossings: comparing the algebras \mathcal{A} for resolutions of braids with different numbers of crossings requires a tedious renormalization of coefficients. This is no longer the case for \mathcal{A}' , which makes it much easier to analyze linear maps associated with foams.

Proposition 4.5. *The assignment $\omega \mapsto \mathcal{A}'(\omega)$ extends to a functor*

$$\mathcal{A}': \mathcal{AFoam}_q^* \rightarrow grMod$$

that is a quotient of the functor \overline{B}_q from Section 2.5.

In order to prove the proposition, we need the following property of non-local relations.

Lemma 4.6. *Let γ and γ' be curves adapted to a marked annular web ω_\star that coincide everywhere except a small neighborhood of a trivalent vertex v , in which γ intersects only the thick edge, whereas γ' intersects the two thin edges. Then $NL_\gamma^\omega = NL_{\gamma'}^\omega$ in $\overline{B}_q(\omega_\star)$.*

Proof. The polynomial $NL_{\gamma'}^\omega$ differs from NL_γ^ω in that in one of its two summands a product of variables associated with the thick edge is replaced by a product of variables associated with the thin edges. The equality of both monomials is imposed by the Soergel location. \square

Proof of Proposition 4.5. We have to check that linear maps induced by foams preserve the ideal of non-local relations. In all diagrams, the bounded part delimited by a simple closed curve γ is supposed to be below γ .

There are six maps (cup, cap, zip, unzip, as and coas) to be inspected, but in the view of Lemma 4.6 only zip required a non-trivial check. Indeed, let us demonstrate how the lemma is used in case of the map cap, that eliminates a bigon.

Denote by ω and ω' marked annular webs with a membrane that are identical except in a small disk D disjoint from the membrane and the marked point, where

$$\omega = \begin{array}{c} \xrightarrow{a} \\ \xrightarrow{b} \end{array} \quad \text{and} \quad \omega' = \xrightarrow{a+b}.$$

If a curve γ does not pass through the bigon in ω , then the relation NL_γ is clearly preserved. Otherwise, we apply Lemma 4.6 to isotope γ away from the bigon:

Analogue arguments ensure that as, coas, cup and unzip induce morphisms on quotient spaces.

Let us now deal with zip. Denote by ω and ω' marked annular webs with a membrane that are identical except in a small disk D disjoint from the membrane and the marked point, where:

$$\omega = \begin{array}{c} a \xrightarrow{} \\ b \xrightarrow{} \end{array} \quad \text{and} \quad \omega' = \begin{array}{c} a \curvearrowright \\ b \curvearrowright \end{array} \xrightarrow{a+b} \begin{array}{c} \curvearrowleft a \\ \curvearrowleft b \end{array}.$$

The only problematic curves are the ones that, inside D , go between the two edges of ω :

$$\begin{array}{c} a \xrightarrow{} \\ \text{---} \text{---} \text{---} \gamma \text{---} \\ b \xrightarrow{} \end{array}$$

Let us denote by γ_1 and γ_2 curves adapted to ω' that are identical to γ outside of D , whereas inside they look like in the following diagram:

In order to prove that the zip map is well-defined, we shall show that NL_γ^ω is mapped onto an element of $\mathcal{N}_{\omega'}$ of the form

$$(23) \quad NL_{\gamma_1}^\omega \sum_{\alpha \in T(a-1,b)} (-1)^{|\hat{\alpha}|} s_\alpha(Y') s_{\hat{\alpha}}(Z) + NL_{\gamma_2}^\omega \sum_{\alpha \in T(a,b-1)} (-1)^{|\hat{\alpha}|} s_\alpha(Y') s_{\hat{\alpha}}(Z),$$

where the set of variables Y , Z , Y' , and Z' are associated with edges of the web as indicated in the figure below:

Using the equality

$$(24) \quad \sum_{\alpha \in T(a,b)} (-1)^{|\hat{\alpha}|} s_\alpha(Y') s_{\hat{\alpha}}(Z) = \sum_{\alpha \in T(a,b)} (-1)^{|\hat{\alpha}|} s_\alpha(Y) s_{\hat{\alpha}}(Z').$$

we can rewrite the image of $NL_\gamma^\omega = q^i x_{\text{out}(\gamma)} - x_{\text{in}(\gamma)}$ under the zip map as

$$(25) \quad x_{\text{out}(\gamma)} \sum_{\alpha \in T(a,b)} (-1)^{|\hat{\alpha}|} s_\alpha(Y') s_{\hat{\alpha}}(Z) - q^{2i} x_{\text{in}(\gamma)} \sum_{\alpha \in T(a,b)} (-1)^{|\hat{\alpha}|} s_\alpha(Y) s_{\hat{\alpha}}(Z').$$

We will analyze each term separately. Notice first that

$$(26) \quad x_{\text{in}(\gamma_1)} = x_{\text{in}(\gamma)} e_a(Y), \quad x_{\text{in}(\gamma_2)} = x_{\text{in}(\gamma)} e_b(Z'),$$

$$(27) \quad x_{\text{out}(\gamma_1)} = x_{\text{out}(\gamma)} e_a(Y'), \quad x_{\text{out}(\gamma_2)} = x_{\text{out}(\gamma)} e_b(Z).$$

Denote by $T_1(a,b)$ the subset of Young diagrams with exactly a boxes in the first column and set $T_2(a,b) = T(a,b) \setminus T_1(a,b)$. Note that $\hat{\beta}$ has exactly b boxes the first column when $\beta \in T_2(a,b)$. Hence, for such α and β one has

$$\begin{aligned} s_\alpha(Y) &= e_a(Y) s_{\alpha'}(Y), & s_{\hat{\beta}}(Z) &= e_b(Z) s_{\hat{\beta}'}(Z), \\ s_\alpha(Y') &= e_a(Y') s_{\alpha'}(Y'), & s_{\hat{\beta}}(Z') &= e_b(Z') s_{\hat{\beta}'}(Z'), \end{aligned}$$

where α' (resp. $\hat{\beta}'$) is the Young diagram α (resp. $\hat{\beta}$) with its first column removed. On one hand, using (27) one obtains:

$$\begin{aligned} (28) \quad x_{\text{out}(\gamma)} \sum_{\alpha \in T(a,b)} (-1)^{|\hat{\alpha}|} s_\alpha(Y') s_{\hat{\alpha}}(Z) & \\ = x_{\text{out}(\gamma_1)} \sum_{\alpha \in T_1(a,b)} (-1)^{|\hat{\alpha}|} s_{\alpha'}(Y') s_{\hat{\alpha}}(Z) + x_{\text{out}(\gamma_2)} \sum_{\alpha \in T_2(a,b)} (-1)^{|\hat{\alpha}|} s_\alpha(Y') s_{\hat{\alpha}'}(Z) & \\ = x_{\text{out}(\gamma_1)} \sum_{\alpha \in T(a-1,b)} (-1)^{|\hat{\alpha}|} s_\alpha(Y') s_{\hat{\alpha}}(Z) + x_{\text{out}(\gamma_2)} \sum_{\alpha \in T(a,b-1)} (-1)^{|\hat{\alpha}|} s_\alpha(Y') s_{\hat{\alpha}}(Z). & \end{aligned}$$

On the other hand, using (26) and Corollary 2.3 one computes

$$\begin{aligned} (29) \quad x_{\text{in}(\gamma)} \sum_{\alpha \in T(a,b)} (-1)^{|\hat{\alpha}|} s_\alpha(Y) s_{\hat{\alpha}}(Z') & \\ = x_{\text{in}(\gamma_1)} \sum_{\alpha \in T(a-1,b)} (-1)^{|\hat{\alpha}|} s_\alpha(Y) s_{\hat{\alpha}}(Z') + x_{\text{in}(\gamma_2)} \sum_{\alpha \in T(a,b-1)} (-1)^{|\hat{\alpha}|} s_\alpha(Y) s_{\hat{\alpha}}(Z') & \\ = x_{\text{in}(\gamma_1)} \sum_{\alpha \in T(a-1,b)} (-1)^{|\hat{\alpha}|} s_\alpha(Y \sqcup Z) s_{\hat{\alpha}}(Z' \sqcup Z) + x_{\text{in}(\gamma_2)} \sum_{\alpha \in T(a,b-1)} (-1)^{|\hat{\alpha}|} s_\alpha(Y \sqcup Z) s_{\hat{\alpha}}(Z' \sqcup Z) & \\ = x_{\text{in}(\gamma_1)} \sum_{\alpha \in T(a-1,b)} (-1)^{|\hat{\alpha}|} s_\alpha(Y' \sqcup Z') s_{\hat{\alpha}}(Z' \sqcup Z) + x_{\text{in}(\gamma_2)} \sum_{\alpha \in T(a,b-1)} (-1)^{|\hat{\alpha}|} s_\alpha(Y' \sqcup Z') s_{\hat{\alpha}}(Z' \sqcup Z) & \\ = x_{\text{in}(\gamma_1)} \sum_{\alpha \in T(a-1,b)} (-1)^{|\hat{\alpha}|} s_\alpha(Y') s_{\hat{\alpha}}(Z) + x_{\text{in}(\gamma_2)} \sum_{\alpha \in T(a,b-1)} (-1)^{|\hat{\alpha}|} s_\alpha(Y') s_{\hat{\alpha}}(Z). & \end{aligned}$$

Putting (28) and (29) together, we get that formulas (23) and (25) coincide as desired. \square

Remark 4.7. The above proposition, when paired with the invariance of the formal complex constructed purely with foams [QRS18], implies immediately that a homology based on \mathcal{A}' is invariant under braid moves and conjugation away from the basepoint. It can be also shown that the homology is invariant under stabilization if $1 - q^n$ is invertible for each $n > 0$. The question whether the complex based on \mathcal{A}' is truly a knot invariant remains open.

4.3. A pseudo completion. In this section, we introduce a functor qAG that interpolates \mathfrak{gl}_0 -homology and knot Floer homology. It comes from the observation that Theorem 3.5 relates Gilmore's construction to knot Floer homology when coefficients are $\mathbb{F}[t^{-1}, t]$, where $1 - t^n$ is invertible for all $n \neq 0$. On the other hand, the definition of \mathfrak{gl}_0 -homology can be morally thought of as Gilmore specialized at $t = 1$. The functor qAG aims to take the best of these two incompatible worlds.

Coefficients over which chain complexes are considered will play an important role in this section. We emphasize this importance by writing them systematically. Moreover, despite the construction of qAG makes sense for any marked annular web, we focus on the case of elementary webs.

Given an annular web ω , consider the map:

$$\varphi_\omega: \mathcal{A}'(\omega; \mathbb{Z}[q, q^{-1}]) \longrightarrow \mathcal{A}'(\omega; \mathbb{Z}[q^{-1}, q])$$

given by extending the scalars. It may not be injective. Define

$$qAG(\omega) := \mathcal{A}'(\omega; \mathbb{Z}[q, q^{-1}]) / \ker \varphi_\omega.$$

and more generally $qAG(\omega; \mathbb{k}) := qAG(\omega) \otimes_{\mathbb{Z}[q, q^{-1}]} \mathbb{k}$ for any $\mathbb{Z}[q, q^{-1}]$ -module \mathbb{k} . We simplify the notation to AG and AGH respectively if $q - 1$ annihilates \mathbb{k} , i.e. when q acts on \mathbb{k} as the unit.

Notice that we kill in $qAG(\omega; \mathbb{k})$ every decoration $x \in D(\omega)$ that is annihilated in $\mathcal{A}'(\omega; \mathbb{Z}[q, q^{-1}])$ by some nontrivial polynomial $p(q) \in \mathbb{Z}[q, q^{-1}]$. Because the homomorphism φ_ω is natural with respect to actions of foams, $qAG(-; \mathbb{k})$ extends to a functor on \mathcal{AFoam}_q^* .

Lemma 4.8. *If \mathbb{k} is a PID and ω is a marked elementary annular web, then $qAG(\omega; \mathbb{k})$ is a free \mathbb{k} -module of finite rank.*

Proof. Notice first that $qAG(\omega; \mathbb{k})$ vanishes when ω is disconnected and is free of rank one when ω is a chain of dumbbells, see Example 4.2. The thesis now follows from the functoriality of $qAG(-; \mathbb{k})$ and Proposition 2.25, because a submodule of a finitely generated free module over a PID is finitely generated and torsion-free, hence free. \square

Using crossing resolution and differentials one extends qAG to braid diagrams and we write $qAGH(\widehat{\beta}; \mathbb{k})$ for the homology of this complex. It is the central player of this paper. While it can be shown that $qAGH(\widehat{\beta}; \mathbb{k})$ is a braid invariant that is preserved under stabilization, checking the first Markov move (conjugacy) is challenging.

Question 4.9. *Is the homology $qAGH(\widehat{\beta}; \mathbb{k})$ a knot invariant?*

As a direct consequence of the construction of $qAG(\omega)$, it can be identified with a $\mathbb{Z}[q, q^{-1}]$ -subspace of $\mathcal{A}'(\omega; \mathbb{Z}[q^{-1}, q])$ of maximal rank. This observation leads immediately to the following result.

Proposition 4.10. *Choose a braid diagram $\widehat{\beta}$ with n crossings and let $\mathbb{k} = \widehat{\mathbb{L}}$ with $q = t^{-(n+1)}$. Then $qAG(\widehat{\beta}; \widehat{\mathbb{L}})$ and $C^{AG}(\widehat{\beta}; \widehat{\mathbb{L}})$ are isomorphic complexes of graded $\widehat{\mathbb{L}}$ -modules. In particular, $qAG(\widehat{\beta}; \mathbb{F}[t^{-1}, t])$ is quasi-isomorphic to $\widehat{CFK}(\widehat{\beta}) \otimes \mathbb{F}[t^{-1}, t]$.*

Proof. The inclusion $qAG(\omega) \rightarrow \mathcal{A}'(\omega, \mathbb{Z}[q^{-1}, q])$ induced by φ_ω is an isomorphism when tensored with $\mathbb{Z}[q^{-1}, q]$ over $\mathbb{Z}[q, q^{-1}]$. The last statement follows from Theorem 3.5. \square

Contrary to \mathcal{A}' , specializing qAG at $q = 1$ recovers the \mathfrak{gl}_0 -complex.

Proposition 4.11. *For every marked elementary annular web ω there is an isomorphism $AG(\omega) \cong S'_0(\omega)$ that intertwines the action of foams. In particular, the complexes of graded \mathbb{k} -modules $AG(\widehat{\beta}; \mathbb{k})$ and $C^{\mathfrak{gl}_0}(\widehat{\beta}; \mathbb{k})$ are naturally isomorphic.*

Proof. Both $AG(\omega; \mathbb{k})$ and $\mathcal{S}'_0(\omega; \mathbb{k})$ are quotients of the Soergel space $B(\omega)$ of the web ω . We claim that the identity on $B(\omega)$ induces the desired isomorphism. Due to functoriality of both constructions and Proposition 2.25 it is enough to check the claim for basic elementary webs.

This is clear if ω has more than one component, because in this case both spaces are zero. Otherwise ω is either a single circle or a chain of dumbbells and in each case both spaces are freely generated by the empty decoration. \square

Notice that the first proposition from the introduction is an immediate corollary of the above result.

Proof of Proposition A. The \mathfrak{gl}_0 -homology is a knot invariant when \mathbb{k} is a field, and so is AGH by Proposition 4.11. \square

4.4. Spectral sequence. In this short section we establish the main theorem. We will use the result of Section 4.3 for $\mathbb{k} = \mathbb{F}$ because in this case, we can use Theorems 3.5 and 3.12.

Lemma 4.12. *For any braid diagram $\widehat{\beta}$, the free part of $H(qAG(\widehat{\beta}; \mathbb{F}[t, t^{-1}]))$ tensored over $\mathbb{F}[t, t^{-1}]$ with \mathbb{F} is (non-canonically) isomorphic to $\widehat{HFK}(\widehat{\beta}; \mathbb{F})$.*

Proof. Since $\mathbb{F}[t^{-1}, t]$ contains the fields of fraction of $\mathbb{F}[t, t^{-1}]$, the universal coefficient theorem implies that the groups $H(qAG(\widehat{\beta}, \mathbb{F}[t, t^{-1}]))$ and $H(C^{AG}(\widehat{\beta}, \mathbb{F}[t^{-1}, t]))$ have the same rank.

From Theorem 3.5, we know that $H(C^{AG}(\widehat{\beta}, \mathbb{F}[t^{-1}, t]))$ is isomorphic to $\widehat{HFK}(\widehat{\beta}, \mathbb{F}) \otimes \mathbb{F}[t^{-1}, t]$. Hence the free part of $H(qAG(\widehat{\beta}, \mathbb{F}[t, t^{-1}]))$ has the same rank as $\widehat{HFK}(\widehat{\beta}, \mathbb{F}) \otimes \mathbb{F}[t, t^{-1}]$. We conclude by tensoring on both sides with \mathbb{F} . \square

We are now in a position to apply the $(t \mapsto 1)$ -Bockstein spectral sequence to $qAGH(\widehat{\beta}; \mathbb{F}[t, t^{-1}])$, see Appendix A, which proves the main result of the paper.

Theorem B. *Let K be a knot represented by a braid closure $\widehat{\beta}$. Then the $(t \mapsto 1)$ -Bockstein spectral sequence applied to $qAG(\widehat{\beta}; \mathbb{F}[t, t^{-1}])$ has $H^{\mathfrak{gl}_0}(K; \mathbb{F})$ on its first page and converges after finitely many steps. The last page is (non-canonically) isomorphic to $\widehat{HFK}(K; \mathbb{F})$.*

Proof. The thesis follows directly from Proposition A.3, which we can apply thanks to Lemma 4.8. Indeed it states that the $(t \mapsto 1)$ -Bockstein spectral sequence has $H(qAG(\widehat{\beta}; \mathbb{F}[t, t^{-1}]) \otimes_{t \mapsto 1} \mathbb{F})$ on the first page and converges on the free part of $H(qAG(\widehat{\beta}; \mathbb{F}[t, t^{-1}]))$ tensored with \mathbb{F} . The former is isomorphic to $H^{\mathfrak{gl}_0}(K, \mathbb{F})$ by Proposition 4.11 and the latter is isomorphic to $\widehat{HFK}(K, \mathbb{F})$ by Lemma 4.12. \square

The Bockstein spectral sequence which appears in Theorem B exists and converges in finitely many steps over any field \mathbb{k} . However if $\mathbb{k} \neq \mathbb{F}$ (or any other field of characteristic 2) then we do not understand the ∞ -page of this spectral sequence. In particular we do not know if it is a knot invariant. The case $\mathbb{k} = \mathbb{Q}$ would be especially interesting since it potentially gives a spectral sequence from the triply graded homology to knot Floer homology (with \mathbb{Q} -coefficients), see Conjecture 2 and Theorems D and E.

APPENDIX A. ON BOCKSTEIN SPECTRAL SEQUENCES

The aim of this appendix is to explain how Bockstein spectral sequence can be adapted in a context of chain complexes of \mathbb{L} -modules. We start with recalling the classical Bockstein sequence in the context of \mathbb{Z} -modules. The material exposed here is largely inspired by [May09].

A.1. The mod- p Bockstein spectral sequence. Let C_\bullet be a chain complex of \mathbb{Z} -modules and p be a prime number. The short exact sequence

$$0 \longrightarrow \mathbb{Z} \xrightarrow{\cdot p} \mathbb{Z} \xrightarrow{\pi} \mathbb{Z}/p\mathbb{Z} \longrightarrow 0$$

induces a homological long exact sequence

$$\dots \xrightarrow{\partial} H_\bullet(C; \mathbb{Z}) \xrightarrow{H(\cdot p)} H_\bullet(C; \mathbb{Z}) \xrightarrow{H(\pi)} H_\bullet(C; \mathbb{Z}/p\mathbb{Z}) \xrightarrow{\partial} H_{\bullet-1}(C; \mathbb{Z}) \xrightarrow{H(\cdot p)} H_{\bullet-1}(C; \mathbb{Z}) \xrightarrow{H(\pi)} \dots$$

which can be thought of as an exact triangle:

$$\begin{array}{ccc} H_\bullet(C; \mathbb{Z}) & \xrightarrow{H(\cdot p)} & H_\bullet(C; \mathbb{Z}) \\ & \swarrow \partial & \searrow H(\pi) \\ & & H_\bullet(C; \mathbb{Z}/p\mathbb{Z}) \end{array}$$

or as an exact couple $(H_\bullet(C; \mathbb{Z}), H_\bullet(C; \mathbb{Z}/p\mathbb{Z}), H(\cdot p), H(\pi), \partial)$.

Recall from [Mas52] that an exact couple is an 5-tuple (A, B, f, g, h) where A and B are two objects in an abelian category and $f: A \rightarrow A, g: A \rightarrow B$ and $h: B \rightarrow A$ are morphisms such that $\text{Im } f = \text{Ker } g, \text{Im } g = \text{Ker } h$ and $\text{Im } h = \text{Ker } f$.

Defining

- $A' = \text{Im } f,$
- $B' = \text{Ker}(g \circ h) / \text{Im}(g \circ h),$
- $f': A' \rightarrow A'$ as the restriction of f to $A',$
- $h': C' \rightarrow A'$ induced by $h,$
- $g': A' \rightarrow C'$ by declaring that map $a' = f(a) \in A'$ is mapped on $g(a') = g(a) \in C',$

yields another exact couple (A', B', f', g', h') . Inductively one can construct a sequence of exact couples $(A^{(n)}, B^{(n)}, f^{(n)}, g^{(n)}, h^{(n)})_{n \in \mathbb{N}}$ and one can check that $(B^{(n)}, g^{(n)} \circ f^{(n)})$ is a spectral sequence¹⁰.

The *Bockstein spectral sequence* is the spectral sequence using the exact couple

$$(H_\bullet(C; \mathbb{Z}), H_\bullet(C; \mathbb{Z}/p\mathbb{Z}), H(\cdot p), H(\pi), \partial).$$

Example A.1. Consider the chain complex $C = \mathbb{Z} \xrightarrow{\cdot p^k} \mathbb{Z}$ for some $k \geq 1$. The first exact couple at stake is:

$$\begin{array}{ccc} \mathbb{Z}/p^k\mathbb{Z} & \xrightarrow{\cdot p} & \mathbb{Z}/p^k\mathbb{Z} \\ & \swarrow (p^{k-1} \ 0) & \searrow \begin{pmatrix} 0 \\ 1 \end{pmatrix} \\ & & \mathbb{Z}/p\mathbb{Z} \oplus \mathbb{Z}/p\mathbb{Z} \end{array} .$$

In general, for $1 \leq i \leq k$, the i th exact couple is given by:

$$\begin{array}{ccc} \mathbb{Z}/p^{k+1-i}\mathbb{Z} & \xrightarrow{\cdot p} & \mathbb{Z}/p^{k+1-i}\mathbb{Z} \\ & \swarrow (p^{k-i} \ 0) & \searrow \begin{pmatrix} 0 \\ 1 \end{pmatrix} \\ & & \mathbb{Z}/p\mathbb{Z} \oplus \mathbb{Z}/p\mathbb{Z} \end{array}$$

and finally the $k + 1$ st exact couple is identically 0.

¹⁰Not necessarily bigraded in general.

Proposition A.2. *The first page of the Bockstein spectral sequence of a chain complex C of $\mathbb{Z}/p\mathbb{Z}$ -modules is $H(C; \mathbb{Z}/p\mathbb{Z})$. If the chain complex C is free and finitely generated, then the Bockstein spectral sequence converges in finitely many steps and the infinite page is canonically isomorphic to the free part of $H(C; \mathbb{Z})$ tensored with $\mathbb{Z}/p\mathbb{Z}$.*

Sketch of the proof. This is a very classical result and the proof is rather elementary. First, using Smith normal form of differentials, one obtains that every free and finitely generated complex of \mathbb{Z} -modules is a direct sum of shifted complexes of the form

- (1) $0 \longrightarrow \mathbb{Z} \longrightarrow 0$,
- (2) $0 \longrightarrow \mathbb{Z} \xrightarrow{\cdot r} \mathbb{Z} \longrightarrow 0$ with r an integer coprime with p ,
- (3) $0 \longrightarrow \mathbb{Z} \xrightarrow{\cdot p^k r} \mathbb{Z} \longrightarrow 0$ with $k \geq 1$ and r an integer coprime with p .

In case (1), the spectral sequence converges immediately and its infinite page is equal to $\mathbb{Z}/p\mathbb{Z}$. In case (2), the spectral sequence converges immediately and its infinite page is equal to 0. Case (3) is dealt with in Example A.1: it converges at the $(k+1)$ st page and its infinite page is equal to 0. \square

A.2. The $(t \mapsto 1)$ -Bockstein sequence. Let \mathbb{k} be a field and $\mathbb{L} := \mathbb{k}[t, t^{-1}]$ be the ring of Laurent polynomial over \mathbb{k} . In this paper, we are only interested with the cases $\mathbb{k} = \mathbb{Q}$ and $\mathbb{k} = \mathbb{F}$.

The field \mathbb{k} is endowed with a \mathbb{L} -module structure by letting t acting on \mathbb{k} by 1. Consider the exact sequence of \mathbb{L} -modules

$$0 \longrightarrow \mathbb{L} \xrightarrow{\cdot(t-1)} \mathbb{L} \xrightarrow{t \mapsto 1} \mathbb{k} \longrightarrow 0.$$

Let C be a chain complex of \mathbb{L} -modules. Just like in subsection A.1, one can use the induced long exact sequence in homology to construct the exact couple

$$(H_\bullet(C; \mathbb{L}), H_\bullet(C; \mathbb{k}), H(\cdot(t-1)), H(t \mapsto 1), \partial).$$

Finally this exact couple induces a spectral sequence called the $(t \mapsto 1)$ -Bockstein spectral sequence.

Proposition A.3. *The first page of the $(t \mapsto 1)$ -Bockstein spectral sequence of a chain complex C of \mathbb{k} -modules is $H(C; \mathbb{k})$. If the chain complex C is free and finitely generated, then the $(t \mapsto 1)$ -Bockstein spectral sequence converges in finite time and the infinite page is canonically isomorphic to the free part of $H(C; \mathbb{L})$ tensored with \mathbb{k} .*

Sketch of the proof. The proof follows the same line as the one of Proposition A.2. Every free and finitely generated complex of \mathbb{L} -module is a direct sum of shifted complexes of the form

- (1) $0 \longrightarrow \mathbb{L} \longrightarrow 0$,
- (2) $0 \longrightarrow \mathbb{L} \xrightarrow{\cdot P(t)} \mathbb{L} \longrightarrow 0$ with $P(t)$ a polynomial prime with $(t-1)$.
- (3) $0 \longrightarrow \mathbb{L} \xrightarrow{\cdot (t-1)^k P(t)} \mathbb{L} \longrightarrow 0$ with $k \geq 1$ and $P(t)$ a polynomial prime with $(t-1)$.

In case (1), the spectral sequence converges immediately and its infinite page is equal to \mathbb{k} . In case (2), the spectral sequence converges immediately and its infinite page is equal to 0. Case (3) is similar to Example A.1. The first exact couple at stake is

$$\begin{array}{ccc} \mathbb{L}/\langle (t-1)^k P(t) \rangle & \xrightarrow{\cdot(t-1)} & \mathbb{L}/\langle (t-1)^k P(t) \rangle \\ \swarrow & & \searrow \\ ((t-1)^{k-1} P(t) \ 0) & & \begin{pmatrix} 0 \\ 1 \end{pmatrix} \\ & \searrow & \swarrow \\ & \mathbb{k} \oplus \mathbb{k} & \end{array} .$$

In general, for $1 \leq i \leq k$, the i th exact couple is given by:

$$\begin{array}{ccc} \mathbb{L}/\langle (t-1)^{k+1-i}P(t) \rangle & \xrightarrow{\cdot(t-1)} & \mathbb{L}/\langle (t-1)^{k+1-i}P(t) \rangle \\ & \swarrow & \searrow \\ & \mathbb{k} \oplus \mathbb{k} & \end{array}$$

$((t-1)^{k-i}P(t) \ 0)$ $\begin{pmatrix} 0 \\ 1 \end{pmatrix}$

Finally the $(k+1)$ st exact couple is identically 0.

Hence in all three cases, the $(t \mapsto 1)$ -Bockstein spectral sequence converges to the free part of $H(C, \mathbb{L})$ tensored with \mathbb{k} . \square

APPENDIX B. CYCLICITY OF THE QUANTUM HOCHSCHILD HOMOLOGY

For this section we fix a graded algebra A and consider its quantum Hochschild complex $qCH_{\bullet}(A)$ with the differential denoted by ∂ . The complex arises actually from a *simplicial module*,¹¹ which means that each chain group $qCH_n(A)$ admits two families of homomorphisms: the family of *face maps* $\{d_i: M_n \rightarrow M_{n-1}\}_{0 \leq i \leq n}$ and of *degeneracy maps* $\{s_j: M_n \rightarrow M_{n+1}\}_{0 \leq j \leq n}$, which satisfy the equalities

$$(30) \quad d_i d_j = d_{j-1} d_i \quad \text{for } i < j,$$

$$(31) \quad s_i s_j = s_j s_{i-1} \quad \text{for } i > j,$$

$$(32) \quad d_i s_j = \begin{cases} s_{j-1} d_i & \text{for } i < j, \\ id & \text{for } i = j, j+1, \\ s_j d_{i-1} & \text{for } i > j+1. \end{cases}$$

Indeed, the face maps are the components of the quantum Hochschild differential,

$$d_i(a_0 \otimes \cdots \otimes a_n) := \begin{cases} a_0 a_1 \otimes a_2 \otimes \cdots \otimes a_n & \text{if } i = 0, \\ a_0 \otimes \cdots \otimes a_i a_{i+1} \otimes \cdots \otimes a_n & \text{if } 0 < i < n, \\ q^{-|a_n|} a_n a_0 \otimes a_1 \otimes \cdots \otimes a_{n-1} & \text{if } i = n, \end{cases}$$

whereas the degeneracy map s_j inserts $1 \in A$ after j -th factor:

$$s_j(a_0 \otimes \cdots \otimes a_n) := a_0 \otimes \cdots \otimes a_j \otimes 1 \otimes a_{j+1} \otimes \cdots \otimes a_n.$$

In addition to that, there is a family of component-wise endomorphisms

$$t_n(a_0 \otimes \cdots \otimes a_n) := q^{-|a_n|} a_n \otimes a_0 \otimes \cdots \otimes a_{n-1},$$

which satisfy the equalities

$$(33) \quad d_i t_n = \begin{cases} d_n & \text{for } i = 0, \\ t_{n-1} d_{i-1} & \text{for } i > 0, \end{cases} \quad s_j t_n = \begin{cases} t_{n+1}^2 s_n & \text{for } j = 0, \\ t_{n+1} s_{j-1} & \text{for } j > 0. \end{cases}$$

Consider the endomorphism T of $qCH_{\bullet}(A)$ defined by $T_n := t_n^{n+1}$. It is the identity map when $q = 1$, which means that the classing Hochschild homology is a cyclic module, but in general case it scales a homogeneous degree d Hochschild chain by q^d . However, it is not far from the identity map.

Lemma B.1. *The endomorphism T is chain homotopic to the identity map.*

¹¹For more details about simplicial and cyclic module see [Lod98].

Proof. Define $\sigma_n := t_{n+1}s_n$, so that

$$(34) \quad d_i \sigma_n = \begin{cases} id & \text{for } i = 0, \\ \sigma_{n-1} d_{i-1} & \text{for } 0 < i < n, \\ t_n & \text{for } i = n. \end{cases}$$

We claim that $h_n = \sum_{j=0}^n (-1)^{jn} \sigma_n t_n^j$ is a desired chain homotopy. First, write

$$(35) \quad h_{n-1} \partial_n = \sum_{j=0}^{n-1} \sum_{i=0}^n (-1)^{i+j(n-1)} \sigma_{n-1} t_{n-1}^j d_i$$

$$(36) \quad \partial_{n+1} h_n = \sum_{i=0}^{n+1} \sum_{j=0}^n (-1)^{i+jn} d_i \sigma_n t_n^j$$

and notice the following cancellation in (36):

$$(37) \quad (-1)^{n+1+jn} d_{n+1} \sigma_n t_n^j = -(-1)^{(j+1)n} t_n^{j+1} = -(-1)^{(j+1)n} d_0 \sigma_n t_n^{j+1}.$$

Hence,

$$(38) \quad \sum_{j=0}^n (-1)^{jn} (d_0 - (-1)^n d_{n+1}) \sigma_n t_n^j = d_0 \sigma_n - d_{n+1} \sigma_n t_n^n = id - t_n^{n+1}.$$

Put the remaining terms of ∂h as well as the terms of $h \partial$ in the lexicographic order with respect to i then j , to create $n(n+1)$ pairs:

$$(39) \quad \begin{array}{ccccccccc} d_1 \sigma_n & < & d_2 \sigma_n & < & \cdots & < & d_n \sigma_n & < & d_1 \sigma_n t_n & < & d_2 \sigma_n t_n & < & \cdots \\ \updownarrow & & \updownarrow & & & & \updownarrow & & \updownarrow & & \updownarrow & & \updownarrow & & \\ \sigma_{n-1} d_0 & < & \sigma_{n-1} d_1 & < & \cdots & < & \sigma_{n-1} d_{n-1} & < & \sigma_{n-1} d_n & < & \sigma_{n-1} t_{n-1} d_0 & < & \cdots \end{array}$$

It is enough to show that none of the pair contributes to $\partial h + h \partial$.

The term $d_{i+1} \sigma_n t_n^j$ is at the position $jn + i + 1$ in the upper sequence of (39) and it appears in (36) with sign $(-1)^{jn+i+1}$. We compute

$$(40) \quad d_{i+1} \sigma_n t_n^j = \sigma_{n-1} d_i t_n^j = \begin{cases} \sigma_{n-1} t_{n-1}^{j-1} d_{i-j+n+1} & \text{if } 0 \leq i < j, \\ \sigma_{n-1} t_{n-1}^j d_{i-j} & \text{if } j \leq i < n, \end{cases}$$

obtaining a term at the position $jn + i + 1$ in the lower sequence of (39), which appears in (35) with sign $(-1)^{j(n-1)+i-j} = (-1)^{jn+i}$. Hence, the two terms cancel each other and the thesis follows. \square

We are now ready to prove the statement about quantum Hochschild homology for a polynomial algebra R^k . In fact, Proposition 2.13 is a special case of the following result.

Proposition B.2. *Suppose that A is supported in nonnegative degrees and that $1 - q^d$ is invertible for $d \neq 0$. Then the inclusion $A_0 \subset A$ induces a homotopy equivalence of chain complexes $qCH_\bullet(A_0) \rightarrow qCH_\bullet(A)$. In particular, $qHH_\bullet(A) \cong qHH_\bullet(A_0)$.*

Proof. Let T be the endomorphism of $qCH_\bullet(A)$ that maps a homogeneous chain c to $q^{|c|}c$. The map $T - id$ is nullhomotopic by Lemma B.1, so that the subcomplex generated by chains of positive degree is contractible, whereas the degree 0 subcomplex coincides with $qCH_\bullet(A_0)$. \square

REFERENCES

- [BPW19] Anna Beliakova, Krzysztof K. Putyra, and Stephan M. Wehrli. Quantum link homology via trace functor I. *Invent. Math.*, 215(2):383–492, 2019. doi:10.1007/s00222-018-0830-0.
- [Cau17] Sabin Cautis. Remarks on coloured triply graded link invariants. *Algebr. Geom. Topol.*, 17(6):3811–3836, 2017. doi:10.2140/agt.2017.17.3811.
- [EMTW20] Ben Elias, Shotaro Makisumi, Ulrich Thiel, and Geordie Williamson. *Introduction to Soergel bimodules*, volume 5 of *RSME Springer Series*. Springer, Cham, 2020. doi:10.1007/978-3-030-48826-0.
- [ETW18] Michael Ehrig, Daniel Tubbenhauer, and Paul Wedrich. Functoriality of colored link homologies. *Proc. Lond. Math. Soc. (3)*, 117(5):996–1040, 2018. doi:10.1112/plms.12154.
- [Gil16] Allison Gilmore. Invariance and the knot Floer cube of resolutions. *Quantum Topol.*, 7(1):107–183, 2016. doi:10.4171/QT/74.
- [Kho00] Mikhail Khovanov. A categorification of the Jones polynomial. *Duke Math. J.*, 101(3):359–426, 2000. doi:10.1215/S0012-7094-00-10131-7.
- [KLMS12] Mikhail Khovanov, Aaron D. Lauda, Marco Mackaay, and Marko Stošić. Extended graphical calculus for categorified quantum $sl(2)$. *Mem. Amer. Math. Soc.*, 219(1029):vi+87, 2012. doi:10.1090/S0065-9266-2012-00665-4.
- [KR08a] Mikhail Khovanov and Lev Rozansky. Matrix factorizations and link homology. *Fund. Math.*, 199(1):1–91, 2008. doi:10.4064/fm199-1-1.
- [KR08b] Mikhail Khovanov and Lev Rozansky. Matrix factorizations and link homology. II. *Geom. Topol.*, 12(3):1387–1425, 2008. doi:10.2140/gt.2008.12.1387.
- [Lip20] Robert Lipshitz. A remark on quantum hochschild homology, 2020. arXiv:2008.03155.
- [Lod98] Jean-Louis Loday. *Cyclic homology*, volume 301 of *Grundlehren der mathematischen Wissenschaften*. Springer-Verlag, Berlin, second edition, 1998. Appendix E by María O. Ronco, Chapter 13 by the author in collaboration with Teimuraz Pirashvili. doi:10.1007/978-3-662-11389-9.
- [Mac15] Ian G. Macdonald. *Symmetric functions and Hall polynomials*. Oxford Classic Texts in the Physical Sciences. The Clarendon Press, Oxford University Press, New York, second edition, 2015. With contribution by A. V. Zelevinsky and a foreword by Richard Stanley.
- [Mas52] William S. Massey. Exact couples in algebraic topology. I, II. *Ann. of Math. (2)*, 56:363–396, 1952. doi:10.2307/1969805.
- [May09] Jon Peter May. A primer on spectral sequences, 2009. URL: <http://www.math.uchicago.edu/~may/MISC/SpecSeqPrimer.pdf>.
- [Ni07] Yi Ni. Knot Floer homology detects fibred knots. *Invent. Math.*, 170(3):577–608, 2007. doi:10.1007/s00222-007-0075-9.
- [ORS13] Peter S. Ozsváth, Jacob Rasmussen, and Zoltán Szabó. Odd Khovanov homology. *Algebr. Geom. Topol.*, 13(3):1465–1488, 2013. doi:10.2140/agt.2013.13.1465.
- [OS09] Peter Ozsváth and Zoltán Szabó. A cube of resolutions for knot Floer homology. *J. Topol.*, 2(4):865–910, 2009. doi:10.1112/jtopol/jtp032.
- [OSS09] Peter Ozsváth, András Stipsicz, and Zoltán Szabó. Floer homology and singular knots. *J. Topol.*, 2(2):380–404, 2009. doi:10.1112/jtopol/jtp015.
- [QR16] Hoel Queffelec and David E. V. Rose. The \mathfrak{sl}_n foam 2-category: a combinatorial formulation of Khovanov–Rozansky homology via categorical skew Howe duality. *Adv. Math.*, 302:1251–1339, 2016. doi:10.1016/j.aim.2016.07.027.
- [QRS18] Hoel Queffelec, David E. V. Rose, and Antonio Sartori. Annular evaluation and link homology, 2018. arXiv:1802.04131.
- [QW21] Hoel Queffelec and Paul Wedrich. Khovanov homology and categorification of skein modules. *Quantum Topol.*, 12(1):129–209, 2021. doi:10.4171/qt/148.
- [Ras15] Jacob A. Rasmussen. Some differentials on Khovanov–Rozansky homology. *Geom. Topol.*, 19(6):3031–3104, 2015. doi:10.2140/gt.2015.19.3031.
- [RW19] Louis-Hadrien Robert and Emmanuel Wagner. A quantum categorification of the Alexander polynomial, 2019. arXiv:1902.05648.
- [RW20a] Louis-Hadrien Robert and Emmanuel Wagner. A closed formula for the evaluation of foams. *Quantum Topol.*, 11(3):411–487, 2020. doi:10.4171/qt/139.
- [RW20b] Louis-Hadrien Robert and Emmanuel Wagner. Symmetric Khovanov–Rozansky link homologies. *J. Éc. polytech. Math.*, 7:573–651, 2020. doi:10.5802/jep.124.
- [Wed19] Paul Wedrich. Exponential growth of colored HOMFLY-PT homology. *Adv. Math.*, 353:471–525, 2019. doi:10.1016/j.aim.2019.06.023.

UNIVERSITÄT ZÜRICH, INSTITUTE OF MATHEMATICS, WINTERTHURERSTRASSE 190, CH-8057 ZÜRICH, SWITZERLAND

Email address: `anna@math.uzh.ch`

UNIVERSITÄT ZÜRICH, INSTITUTE OF MATHEMATICS, WINTERTHURERSTRASSE 190, CH-8057 ZÜRICH, SWITZERLAND

Email address: `krzysztof.putyra@math.uzh.ch`

UNIVERSITÉ DE LUXEMBOURG, RMATH, 6 AVENUE DE LA FONTE, L-4365 ESCH-SUR-ALZETTE, LUXEMBOURG

Email address: `louis-hadrien.robert@uni.lu`

UNIVERSITÉ DE PARIS, IMJ-PRG, UMR 7586 CNRS, 8 PLACE AURÉLIE NEMOURS, F-75013, PARIS, FRANCE

Email address: `emmanuel.wagner@imj-prg.fr`