

MILNOR CONCORDANCE INVARIANTS FOR SURFACE-LINKS AND BEYOND

BENJAMIN AUDOUX, JEAN-BAPTISTE MEILHAN, AND AKIRA YASUHARA

ABSTRACT. We generalize Milnor link invariants to all types of surface-links in 4–space (possibly with boundary) and more generally to all codimension 2 embeddings. This is achieved by using the notion of cut-diagram, which is a higher dimensional generalization of Gauss diagrams, associated to codimension 2 embeddings in Euclidian spaces. We define a notion of group for cut-diagrams, which generalizes the fundamental group of the complement, and we extract Milnor-type invariants from the successive nilpotent quotients of this group. We show that the latter are invariant under an equivalence relation called cut-concordance, which encompasses the topological notion of concordance. We give several concrete applications of the resulting Milnor concordance invariants for surface-links, comparing their relative strength with previously known concordance invariants, and providing realization results. We also obtain several classification results up to link-homotopy, as well as a criterion for a surface-link to be ribbon. In connection with the k -slice conjecture proved by Igusa and Orr, we show that a classical link has vanishing Milnor invariants of length $\leq 2k$ if and only if it bounds disjoint surfaces in the 4-ball having vanishing Milnor invariants of length $\leq k$. Finally, the theory of cut-diagrams is further investigated, heading towards a combinatorial approach to the study of surfaces in 4–space.

INTRODUCTION

The study of classical knots up to concordance led to many rich developments over the last decades. In higher dimensions, concordance classes of n -knots, *i.e.* smooth embeddings of S^n in S^{n+2} , are in contrast well-understood: in odd dimension, Levine gave an algebraic classification, providing in particular examples of non slice n -knots for any odd $n \geq 3$, while Kervaire proved that all even-dimensional knots are slice [15]. Yet, the question of the existence of a non slice $2k$ -link, *i.e.* a $2k$ -link which does not bound disjoint copies of B^{2k+1} in B^{2k+3} , remains wide open to this date, even in the case $k = 1$. The search for a non trivial concordance invariant of $2k$ -links thus stands as a major open problem in higher-dimensional knot theory, for which very little progress was made, see [16, Problem 1.56].

For classical links, a number of concordance invariants are known, starting with the linking number. The linking number was widely generalized by Milnor in [23, 24], into a family of numerical concordance invariants now called *Milnor invariants*, which can be successfully used to provide obstructions for classical links to be slice. So far, all attempts to generalize Milnor invariants to n -links, for $n \geq 2$, yielded trivial invariants. However, relaxing the embedded condition for n -links, Koschorke did provide in [18] such a non trivial generalization to higher dimensional *link maps*, which are continuous maps from a disjoint union of spheres to a Euclidean space such that the images of the spheres are pairwise disjoint. For 2-component link maps, Kirk also developed link-homotopy invariants [17] in the late eighties, which were recently shown to be complete link-homotopy invariants [34]. We propose here another direction for generalization: relaxing the condition that n -links be spherical, we define Milnor invariants for all codimension 2 embeddings. We discuss in Section 4.6.3 the earlier work of Orr [26] in the same direction. Note that Koschorke’s generalization and ours coincide only in the spherical case, where all invariants vanish. Hence these two works can be regarded as orthogonal.

In order to define our generalization of Milnor invariants, we develop a theory of cut-diagrams. An n -dimensional cut-diagram consists of an $(n - 1)$ -dimensional diagram on some n -manifold, endowed with some labeling. This provides a combinatorial generalization of codimension 2 embedding diagrams, that can be seen as a higher dimensional version of Gauss diagrams. We also introduce a notion of *cut-concordance* for n -dimensional cut-diagrams via $(n + 1)$ -dimensional cut-diagrams. This yields an equivalence relation for cut-diagrams, that encompasses the concordance relation on codimension 2 embeddings, and leads to a theory where concordance can be studied in a combinatorial way. As a matter of fact, our generalization of Milnor invariants are cut-concordance invariants within this cut-diagram theory. The authors believe that this is a promising approach, which can lead to further applications.

The purpose of this paper is thus twofold, and we develop below these two aspects in further details.

A generalization of Milnor concordance invariants. One purpose of this paper is to define Milnor concordance invariants for general codimension 2 embeddings, *i.e.* for smooth embeddings of oriented n -dimensional manifolds in the Euclidian space of dimension $n + 2$, and in particular for surface-links in 4-space, possibly with boundary.

Let S be a codimension 2 embedding of $\Sigma = \Sigma_1 \cup \dots \cup \Sigma_\ell$ in a Euclidian space. As in the original construction of Milnor for classical links, our Milnor-type invariants are extracted from the *nilpotent quotients* of the fundamental group $G(S)$ of the complement of S . These are the quotients $G(S)/G(S)_q$ by the successive terms $G(S)_q$ of the lower central series. A key result in our construction is a presentation for these nilpotent quotients (see Theorem 3.15). This presentation widely generalizes [24, Thm. 4] for usual links, known as the Chen–Milnor theorem. We stress that our proof of Theorem 3.15 is combinatorial, and leads to an algorithm for computing our higher dimensional Milnor invariants, see Remark 4.28. Building on this key result, Milnor-type invariants for S are defined by considering the Magnus expansion of some element of $G(S)/G(S)_q$ associated with a path on Σ , that yields a power series in ℓ non-commuting variables. Although the integer coefficients in this power series depend on several choices made in the construction, we show in Section 4.1 how to extract well-defined invariants from them. For each integer i and sequence of integers I , all in $\{1, \dots, \ell\}$, we have:

- *Milnor loop-invariants* $v_S(Ii)$, which are positive integers extracted from closed curves on Σ_i ;
- *Milnor arc-invariants* $v_S^\partial(I; ij)$, associated to a boundary component p_{ij} of Σ_i , which are residue classes extracted from paths joining p_{ij} to a previously fixed boundary component of Σ_i .

In Section 5.1, we prove the following.

Theorem. *Milnor loop- and arc-invariants are well-defined concordance invariants of codimension 2 embeddings.*

Moreover, in dimensions 1 and 2, if the indexing sequence contains no repetition, the corresponding Milnor invariants are also invariant under link-homotopy, *i.e.*, roughly speaking, under continuous deformations leaving distinct components disjoint at all time.

Although these invariants are all trivial for spherical n -links ($n \geq 2$), they turn out to be rather strong invariants for codimension 2 embedding with at least one non-simply connected component. This is illustrated in Section 6, where a number of applications are provided in the case of surface-links:

- we give general realization results for our invariants in Subsection 6.2; in fact, we can provide infinitely many examples of surface-links in 4-space with non trivial Milnor

concordance invariants, assuming that at least one component is nonspherical. The spherical case thus basically appears as the only remaining case where no obstruction for sliceness exists so far;

- in Subsection 6.3, we consider a family W_m ($m \in \mathbf{N}$) of links made of a sphere and a torus. We show that $W_{m'}$ and W_m are concordant if and only if $m = m'$ by using our Milnor invariants while, in contrast, the Sato-Levine invariant [33] and Cochran's derivation invariants [10] vanish on all W_m , and Saito's invariants [32] of W_m are equal for all values of $m \in \mathbf{N}$;
- in Subsection 6.4.1, we use our Milnor invariants to classify Spun links of 3-components up to link-homotopy (Proposition 6.7), and we characterize link-homotopically trivial Spun links of any number of components (Proposition 6.9);¹
- we state a general link-homotopy classification for proper embeddings of disjoint punctured spheres in the 3-ball in Subsection 6.4.2;
- in Subsection 6.5, we provide a necessary condition for a surface-link to be concordant to a ribbon one.

We note that our construction recovers Milnor's original invariants [23, 24] and Habegger-Lin's version for string links [13], as well as many of the previously known extensions of Milnor invariants, see Section 4.6. The relation with Orr's invariants of surface-links [26, 27] will in particular be discussed in Section 4.6.3, see also Remark 5.24. In Section 4.6.4, we characterize classical links with vanishing Milnor invariants of length $\leq 2k$ in terms of our Milnor invariants of surfaces in 4-space bounded by the link (Proposition 4.29), in connection with the *k-slice conjecture* proved by Igusa and Orr in [14].

Cut-diagrams for codimension 2 embeddings and beyond. The key tool for defining our generalized Milnor invariants is the notion of *cut-diagram*, and building a theory of cut-diagrams is in fact another purpose of this paper.

For simplicity of exposition, let us first focus on the 2-dimensional case. Recall that a surface-link diagram is a generic immersion of a surface Σ into 3-space, endowed with an over/under information on the double point set. Each line of double points inherits a natural orientation from that of Σ and of the ambient space. The lower point set forms a union C of oriented immersed circles and/or intervals in Σ , which is known as the *lower deck* in the literature (see for example [7, § 4.1]), and which splits Σ into connected components called regions. Each arc of C can be labeled by the region where the corresponding arc of higher points is contained. The resulting labeled oriented diagram C on Σ is a *2-dimensional cut-diagram over Σ* for the given surface-link. An example is given in Figure 1 in the case $\Sigma = S^2$. Now, we can abstractly define a notion of cut-diagram over an oriented surface Σ , irrespective of a given embedding of Σ , as an oriented immersed 1-dimensional manifold C on Σ , such that each arc of C is labeled by a region of $\Sigma \setminus C$, subject to some natural labeling condition. This labeling condition emulates the topological constraints arising from triple and/or branch points in a surface-link diagram (see Definition 1.4).

As explained in Subsection 1.2.2, the notion of cut-diagram generalizes naturally to any dimension. There is indeed a general notion of oriented diagrams in an n -manifold Σ , developed by D. Roseman in [30, 31]. Such a diagram C splits Σ into several connected regions; labeling the diagram C by regions so that the same labeling condition as above is satisfied, yields an n -dimensional cut-diagram. In dimension $n = 1$, a cut-diagram is a union of signed points C on a 1-manifold Σ , such that each point in C is labeled by an arc of $\Sigma \setminus C$. This

¹Here, what we call Spun links are knotted tori in 4-space, obtained from a classical link in 3-space by Artin's Spun construction, see Subsection 6.1.

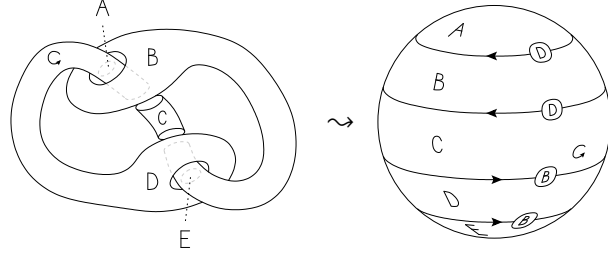

FIGURE 1. From a surface-link diagram to a 2–dimensional cut-diagram.
Here, and in forthcoming figures, regions are named with capital letters, and labels are given by circled nametags

actually correspond to Gauss diagrams modulo the local move which exchanges two adjacent tails on an arc.

We stress that any diagram of a codimension 2 embedding gives rise to a cut-diagram, so that our constructions and results for cut-diagrams, outlined below, have in particular the direct topological corollaries mentioned in the previous section.

Let C be a cut-diagram over $\Sigma = \Sigma_1 \cup \dots \cup \Sigma_\ell$. We define in Section 2 the group $G(C)$ of C as the group abstractly generated by all regions, and with a relation for each double points set, which is a Wirtinger-type relation among the three regions involved; see Definition 2.1. In the case where C arises from a codimension 2 embedding, the group $G(C)$ coincides with the fundamental group of the complement. The Chen–Milnor type presentation mentioned in the previous section is actually a corollary of Theorem 3.15, where a presentation for $G(C)/G(C)_q$ is given for any cut-diagram C . And, building on this result, all generalized Milnor invariants are also defined in this more general context.

In order to build a theory of cut-diagrams, we next consider certain ‘topology-inspired’ equivalence relations.

On the one hand, we define a ‘concordance’ (and ‘reduced concordance’) theory. Two n –dimensional cut-diagrams are *cut-concordant* if they are coherently bounded by an $(n + 1)$ –dimensional cut-diagram (see Subsection 5.1). This notion generalizes the classical notion of concordance, in the sense that a cut-diagram arising from a concordance yields a cut-concordance between the cut-diagrams associated to the boundary manifolds. We show in Corollary 5.6 that our generalized Milnor invariants are cut-concordance invariants, which implies in particular the previously stated theorem. A key technical result here is that a cut-concordance induces isomorphisms between the nilpotent quotients of the associated groups (see Corollary 5.7 for a precise statement); this recovers in a combinatorial way a theorem of Stallings [35, Thm. 5.1], see Remark 4.28.

In Section 5.2, we also introduce a notion of ‘reduced cut-concordance’ for cut-diagrams, which is closely related to link-homotopy for codimension 2 embedded objects, and we show in Proposition 5.23 that Milnor invariants associated to sequences of distinct integers are reduced cut-concordance invariants.

On the other hand, we develop an ‘isotopy’ (and ‘link-homotopy’) theory for cut-diagrams in dimensions 1 and 2. As explained before, cut-diagrams have their origin in the notion of diagrams for codimension 2 embeddings, and there exists in dimension 1 and 2 sets of moves on diagrams, namely Reidemeister and Roseman moves, which realize isotopies. Restricting ourselves to dimensions 1 and 2, it is thus natural to expect for cut-diagrams to be endowed

with some corresponding moves. We provide such an explicit set of moves in Section 7.1. Quotiented by these moves, the notion of 1–dimensional cut-diagrams actually coincides with welded objects. In this sense, the resulting theory of 2–dimensional cut-diagrams can be regarded as a 2–dimensional welded theory.

In dimension 1 and 2, there also exists diagrammatic moves realizing link-homotopy of links and surface-links. Based on these local moves, we finally provide sets of self-singular moves in Section 7.3, leading to some combinatorial ‘link-homotopy’ theory for 1 and 2–dimensional cut-diagrams. This is used effectively in [4] to define link-homotopy invariants of link maps generalizing the Kirk invariant.

Outline of the paper and conventions. We next outline the structure of the rest of this paper. In section 1, we introduce the notion of cut-diagram, first from an intuitive point of view in low dimensions, then in full generality. Section 2 introduces the notion of *peripheral system* for cut-diagrams. This data consists of the group of the cut-diagram, together with a collection of elements in this group called *meridians* and *longitudes*; for a cut-diagram associated with a codimension 2 embedding, these coincide with the eponymous elements in the fundamental group of the complement. Section 3 establishes the above-mentioned Chen–Milnor-like presentation for the nilpotent quotients of the group of a cut-diagram (Theorem 3.15), which is given in terms of a choice of peripheral system. Building on this presentation, we define in Section 4 our generalized Milnor invariants for cut-diagrams; some examples are provided, and the relation with previous (partial) generalizations is also clarified. The fact that these generalized Milnor invariants indeed provide well-defined concordance invariants for codimension 2 embeddings is the main result of Section 5. More generally, we introduce in Subsection 5.1 the notion of cut-concordance for cut-diagrams, and prove the invariance in this more general setting. Subsection 5.2 is likewise devoted to reduced cut-concordance, which is closely related to link-homotopy, and non-repeated Milnor invariants are proved to be invariants for this notion. Our main applications for surface-links in 4–space, summarized above, are detailed in Section 6. The final section 7 introduces sets of local moves for cut-diagrams in dimensions 1 and 2, which provides a diagrammatic tool for the study of surface-links up to isotopy or link-homotopy.

Convention. In this paper, everything is stated in the smooth category.

The term *surface-link* has to be understood in the present paper as proper smooth embedding of a compact oriented surface Σ in the 4–dimensional ball; likewise, *codimension 2 embeddings* are smooth embeddings of an n –dimensional manifold Σ in the $(n + 2)$ –dimensional ball. Two surface-links (and more generally two codimension 2 embeddings) f and g of Σ are *equivalent* if $\text{Im}f$ and $\text{Im}g$ are ambient isotopic relative to boundary or, equivalently, if g is smoothly isotopic to $f \circ \varphi$ for some diffeomorphism φ of Σ . Here, and throughout the paper, by diffeomorphism of Σ we always mean an orientation, component and boundary component preserving diffeomorphism from Σ to itself.

A *surface-link map* is a continuous map from Σ to \mathbb{R}^4 with pairwise disjoint images; more precisely, if $\partial\Sigma \neq \emptyset$, this is a continuous map to the 4–dimensional ball B^4 that embeds $\partial\Sigma$ in $S^3 = \partial B^4$. In particular, a surface-link is a surface-link map. Two surface-link maps f and g are *link-homotopic* if f is homotopic through surface-link maps to some f' such that $\text{Im}f' = \text{Im}g$ or, equivalently, if g is homotopic through surface-link maps to $f \circ \varphi$, for some diffeomorphism φ of Σ .²

We will make use of the following notation and conventions:

²Note that this definition coincides for link maps, *i.e.* in the case where Σ is a union of spheres, with the definition usually used in the literature [18, 17, 34].

- given two elements a, b of some group, their commutator is defined as $[a, b] := a^{-1}b^{-1}ab$, and the conjugate of a by b is given by $a^b := b^{-1}ab$;
- given two normal subgroups G_1 and G_2 of a group G , we denote by $G_1 \cdot G_2$ the normal subgroup of G made of products g_1g_2 with $g_1 \in G_1$ and $g_2 \in G_2$;
- homotopies of paths should always be understood as homotopies fixing the end-points. Moreover, when explicit from the context, we will often suppress the brackets for denoting the element $[\gamma]$ of the fundamental group represented by a path γ ;
- all homology groups are taken with coefficients in \mathbb{Z} , and this shall be omitted in our notation.

Acknowledgments. The first author thanks the IRL PIMS-Europe for its hospitality during the period in which much of the work on this paper was completed. The second author is partially supported by the project AIMaRe (ANR-19-CE40-0001-01) of the ANR. The third author is supported by a JSPS KAKENHI grant Number 21K03237, and by a Waseda University Grant for Special Research Projects (Project number: 2021C-120).

1. CUT-DIAGRAMS

In this section we introduce cut-diagrams, which are combinatorial objects that are derived from, and generalize, diagrams of codimension 2 embeddings. Before providing a general definition, we introduce cut-diagrams when they arise from the familiar situations of classical knot and surface diagrams.

1.1. An intuitive approach. Recall that a classical knot diagram is a generic immersion $S^1 \hookrightarrow \mathbb{R}^2$, with a finite number of transverse double points. Each double point is endowed with the over/under information on the two preimages, which is graphically encoded by cutting off a neighborhood of the lowest preimage, i.e. of the preimage with lowest coordinate in the projection axis.

These lowest points, which we shall call *cut points*, split S^1 into a number of arcs, called *regions*. To each cut point is associated a sign—the sign of the corresponding crossing, and a region—the overpassing arc at the crossing, i.e. the region containing the preimage with highest coordinate. The (1-dimensional) *cut-diagram* built from our classical knot diagram is thus a copy of S^1 , together with a collection of cut points endowed with a sign and labeled by their associated region. See Figure 2 for a couple of examples.

Remark 1.1. Cut points can be thought of as heads of arrows in a Gauss diagram, the label being the arc where the tail is attached. Note however that the relative position of tails attached to a same arc is not specified in this language. Hence 1-dimensional cut-diagrams should rather be thought of as Gauss diagrams modulo the moves which exchanges two adjacent tails on an arc. As we shall see in Section 7.1, we actually recover in dimension 1 the theory of welded objects.

Now, consider a surface-link diagram. This is a generic map $\Sigma \hookrightarrow \mathbb{R}^3$ of a surface Σ , with lines of transverse double points which may meet at triple points and/or end at branch points. As in knot diagrams, the over/under information on the two preimages at each line of double points is encoded by cutting off a neighborhood of the lowest preimage (see the left-hand side of Figure 1, 3 and 4 for some examples). Each line of double points also comes with an orientation, such that the local frame formed by a positive normal vector to the overpassing region, a positive normal vector to the underpassing region, and a positive tangent vector to the line of double points, agrees with the ambient orientation of \mathbb{R}^3 .

The lowest preimages of double points form a union P of immersed circles and/or intervals in Σ , which splits Σ into *regions*. Note that the set P is known as the *lower deck* in the literature

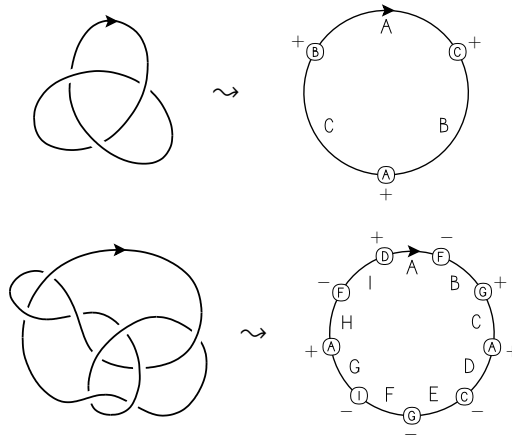

FIGURE 2. From a knot diagram to a 1–dimensional cut-diagram. Regions are named with capital letters, and labels on cut points are given by circled nametags

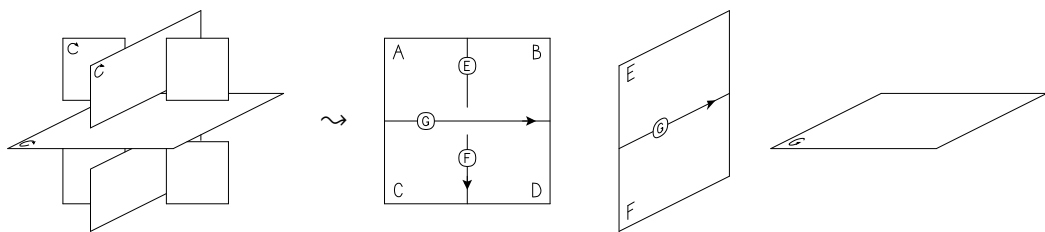

FIGURE 3. From surface-link diagrams to cut-diagrams: triple point

(see for example [7, § 4.1]). Each triple point of the surface diagram provides an over/under information at the corresponding crossing of P , which is encoded as in usual knot diagrams by splitting P into arcs, that we call *cut arcs*. Each cut arc inherits an orientation, which is the orientation of the corresponding line of double points, and we label it by the region containing the preimage with highest coordinate at the corresponding line of double points. The data of the oriented and labeled cut arcs in Σ forms a (2–dimensional) *cut-diagram over* Σ for the given surface-link. This can be thought of as an enhanced version of the lower deck. An example is given in Figure 1 in the case $\Sigma = S^2$. As the figure illustrates, a cut-diagram can be thought of as a cut-and-insert model for a surface-link diagram, where Σ is cut along the cut arcs, and the resulting pieces are assembled according to the labels and orientations.

We stress that the labeling respects some natural conditions, summarized in Definition 1.4, which are inherited from the topological nature of the surface diagram. We investigate these conditions below, by analyzing the local cut-diagrams arising from triple and branch points. A local cut-diagram associated with a triple point is illustrated in Figure 3. A crossing among cut arcs occurs in the leftmost sheet of Σ . There, the overpassing arc is labeled by G , whereas the left and right underpassing cut arcs, with respect to the orientation of the overpassing arc, are labeled by E and F , respectively; these regions E and F are contained in the middle sheet, and are separated by a G –labeled arc, with E on the left and F on the right side of this cut arc. We formalize this as follows.

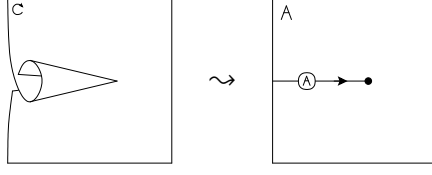

FIGURE 4. From surface-link diagrams to cut-diagrams: branch point

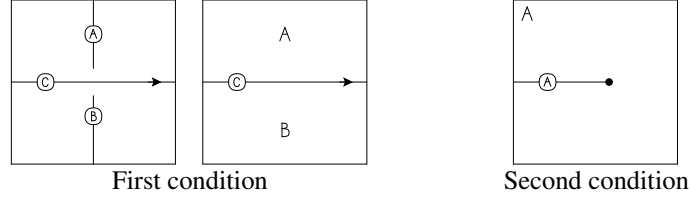

FIGURE 5. Illustrations of the labeling conditions

Definition 1.2. An ordered pair of regions (A, B) is called C -adjacent, for some region C , if there exists a path $\gamma : [0, 1] \rightarrow \Sigma$ such that $\gamma([0, 1/2[) \subset A$, $\gamma(]1/2, 1]) \subset B$, and $\gamma(1/2)$ is a regular point of a cut arc labeled by C , such that the tangent vector $\gamma'(1/2)$ is a positive normal vector for this cut arc. We define similarly the notion of C -adjacency for two cut arcs which are separated by a double point of a C -labeled cut arc.

In the local example of Figure 3, the pair of regions (E, F) is G -adjacent (middle sheet), and we observe that likewise, the E -labeled and F -labeled cut arcs are G -adjacent (leftmost sheet). Figure 4, for its part, illustrates the local cut-diagram associated to a branch point. This yields a local cut-diagram with a boundary point in the interior of the surface Σ .

Definition 1.3. An *internal endpoint* of a cut-diagram over Σ is a point of a boundary component of some cut arc, which is in the interior of Σ . A cut arc containing an internal endpoint is called *terminal*.

In the local example of Figure 4, the terminal cut arc is labeled by A , the region it is adjacent to.

We now specify the labeling condition that we shall use throughout the paper for cut-diagrams.

Definition 1.4. A labeling of the cut arcs by regions is *admissible* if it satisfies the following *labeling conditions*:

- 1) any pair of A -adjacent cut arcs, for some region A , is labeled by two A -adjacent regions;
- 2) a terminal cut arc containing an internal endpoint adjacent to some region A , is labeled by A .

These two conditions are locally represented in Figure 5.

1.2. Abstract cut-diagrams. The above definition of cut-diagrams can be generalized to an abstract notion.



FIGURE 6. Diagrams that violate the first (left) and second (right) labeling condition

1.2.1. *The 2–dimensional case.* Let us begin with the 2–dimensional case, which will be the main focus of this paper. So let Σ be some oriented surface, possibly with boundary. Consider a, non necessarily properly, immersed oriented 1–manifold in Σ , together with an over/under decoration at each transverse double point, as in usual knot diagrams. This immersed 1–manifold splits Σ into pieces called *regions*, and the over/under decoration at each crossing splits the immersed manifold into *cut arcs*, with the induced orientation. Label each cut arc by some region, in such a way that the labeling conditions of Definition 1.4 are satisfied. The result, regarded up to ambient isotopy of Σ , is called a 2–dimensional *cut-diagram* over Σ .

Note in particular that the second labeling condition imposes that all internal endpoints of a given cut arc must be adjacent to the same region. In forthcoming figures, internal endpoints satisfying the second labeling condition will be depicted with a black bullet \bullet .

The left-hand side of Figure 6 provides an example where the first labeling condition is violated. There, the two regions A and B are B –adjacent, and are not R –adjacent for any other region R ; therefore the crossing of cut arcs at the center of the figure, where an A –labeled and a B –labeled cut arcs are C –adjacent, does not respect the first rule.

The right-hand side of Figure 6 shows a situation where the second labeling condition cannot be satisfied. Indeed, the left internal vertex sits in region A , which imposes that the horizontal cut arc must be labeled by A ; but this violates the second labeling condition because of the right internal vertex, which lies in region B .

As discussed in the preceding section, there is a canonical way to associate a cut-diagram to a given surface-link diagram, and the labeling conditions are automatically satisfied in this setting. A number of examples of admissible labelings obtained in this way can be found in Section 6.

1.2.2. *The general case.* We now give a general definition for cut-diagrams in any dimension. The reader who is mainly interested with surface-links and their invariants may safely skip this section.

Let Σ be an n –dimensional oriented compact manifold, possibly with boundary. The following generalized notion of diagrams for codimension 2 embeddings originates from the work of D. Roseman in [30, 31]; see also [28] for a good review of this notion. A diagram on Σ is the image of a map $\varphi : P \looparrowright \Sigma$, where P is an oriented $(n - 1)$ –dimensional manifold, which is in generic position in the sense of [28, § 6.1], equipped with a globally coherent over/under data³ on double points. Roughly speaking, φ is an immersion, except at an $(n - 2)$ –dimensional set of branch points. If $\partial\Sigma \neq \emptyset$, we moreover require that $\varphi(P)$ meets transversally $\partial\Sigma$, so that $\varphi|_{\varphi^{-1}(\partial\Sigma)}$ induces a $(n - 2)$ –dimensional diagram on $\partial\Sigma$.

³More technically, this can be defined as an ordering on $\varphi^{-1}(z)$, for each $z \in \Sigma$, which is locally constant in the sense that, if $x_1 < x_2$ for some $x_1, x_2 \in \varphi^{-1}(z)$, then $x'_1 < x'_2$ for any $x'_1, x'_2 \in \varphi^{-1}(z')$ sufficiently closed in P to x_1 and x_2 , respectively.

For any such diagram, the connected components of $\Sigma \setminus P$ are called *regions*, and the connected components of $\{\text{highest preimages of } \varphi\} \subset P$ are called *cut domains*, although we shall keep calling them *cut points* and *cut arcs* when dealing specifically with the dimensions one and two, respectively.

Definition 1.5. An n -dimensional *cut-diagram* over Σ is the data C of a diagram on Σ , endowed with an *admissible labeling*, which associates a region to each cut domain, so that the labeling conditions of Definition 1.4 are satisfied,⁴ up to ambient isotopy of Σ .

Note that the notions of *A-adjacency* and *internal endpoint*, of Definitions 1.2 and 1.3, apply in any dimension, so that the labeling conditions make sense. Observe also that for $n = 1$, these conditions are vacuous.

Notation 1.6. If C is a cut-diagram with underlying diagram $\varphi : P \looparrowright \Sigma$, then by abuse of notation, we shall also denote $\varphi(P)$ by C . In particular, we shall refer to *regular* and *double points* of C as elements $x \in \Sigma$ such that $\varphi^{-1}(x)$ has 1 or 2 element(s), respectively.

As seen in the previous subsections, a 2-dimensional cut-diagram can be naturally associated to any diagram of a surface-link. although not any cut-diagram arises in this way. Given a diagram of a codimension 2 embedding, the procedure generalizes naturally to produce an n -dimensional cut-diagram. This leads to the following notion.

Definition 1.7. We say that a cut-diagram is *topological* if it comes from the diagram of a codimension 2 embedding.

Note that two codimension 2 embeddings having the same image, may have different topological cut-diagrams, since two such cut-diagrams might differ by diffeomorphism of Σ . This motivates taking the following natural equivalence relation on cut-diagrams:

Definition 1.8. Two cut-diagrams C and C' over Σ are *equivalent* if there exists a diffeomorphism φ of Σ such that $\varphi(C) = C'$.

2. PERIPHERAL SYSTEMS OF CUT-DIAGRAMS

Cut-diagrams contain all the relevant information to define ‘fundamental’ groups and their distinguished elements, meridians and longitudes. The purpose of this section is to introduce these notions in the general context of cut-diagrams. For that, let $\Sigma =: \sqcup_{i=1}^{\ell} \Sigma_i$ be an n -dimensional compact manifold with connected components $\Sigma_1, \dots, \Sigma_{\ell}$, and let C be a cut-diagram over Σ .

2.1. The group of a cut-diagram.

Definition 2.1. The *group of C* is the group $G(C)$ abstractly generated by its regions, and satisfying the Wirtinger relation $B^{-1}A^C$ for every pair (A, B) of C -adjacent regions. When seen as generators of $G(C)$, regions will be called *meridians* of C , and more precisely *i -th meridian* when they belong to Σ_i .

Notation 2.2. We denote by \bar{F} the free group generated by all meridians of C , and by W the normal subgroup of \bar{F} generated by *all* Wirtinger relations, so that we have $G(C) = \bar{F}/W$.

Remark 2.3. Let us call *group of a surface-link*, the fundamental group of the exterior of the image of this surface-link. Surface-link diagrams give rise to Wirtinger presentations of their groups, see e.g. [6]. It is straightforwardly verified, using this Wirtinger presentation, that the group of a topological 2-dimensional cut-diagram, as defined above, agrees with the

⁴There, as well as in Definitions 1.2 and 1.3, the terms *cut arc* should be replaced by *cut domain*. Moreover, in Definition 1.3, an internal endpoint is assumed to be a *regular* point in the boundary of some cut domain.

group of the underlying surface-link. In fact, it is not difficult to check that this is actually true for topological cut-diagrams of any dimension. Moreover, in that case, the above notion of meridian likewise agrees with the usual topological notion of meridian.

Remark 2.4. In the above definition of $G(C)$, regions and meridians are in one-to-one correspondence. However it shall sometimes be convenient to have *multiple* meridians for a given region; this will be the case in the proof of Theorem 5.5. More precisely, we can in general associate a finite number of meridians $R^{(1)}, \dots, R^{(k_R)}$, for some integer $k_R \geq 1$, to each region R . This yields a group with all these meridians as generators, and with relations given by:

- $(R^{(j')})^{-1} R^{(j)}$ for any region R and $1 \leq j < j' \leq k_R$;
- $(B^{(1)})^{-1} (A^{(1)})^{C^{(1)}}$ for every pair (A, B) of C -adjacent regions.

It is straightforwardly checked that such a presentation defines the same group $G(C)$, Definition 2.1 corresponding to the case where $k_R = 1$ for every region R . We shall refer to *duplicated presentations* when at least one k_R is greater than 1. We stress that, unless specified otherwise, the rest of the text will not be dealing with duplicated presentations, except for Remarks 2.9, 3.5, 3.14 and 3.18, which will track down the technical aspects of such duplicated presentations. These remarks are mainly meant to be used in the proof of Theorem 5.5 and can safely be skipped on first reading.

In the sequel, we will be mainly interested in the following quotients.

Definition 2.5. The *lower central series* $(G_q)_{q \in \mathbb{N}}$ of a group G , is the descending series of subgroup defined inductively by $G_1 := G$ and $G_{q+1} := [G, G_q]$. For $q \in \mathbb{N}$, the q -th *nilpotent quotient* of G is its quotient $N_q G := G/G_q$ by the q -th term of its lower central series.

For any $q \in \mathbb{N}$, the q -th *nilpotent group* of C is the nilpotent quotient $N_q G(C)$ of $G(C)$, and we have

$$N_q G(C) \cong \bar{F}/\bar{F}_q \cdot W.$$

2.2. Generic path and associated words. We say that an oriented path $\gamma : [0, 1] \rightarrow \Sigma$ is *generic* if $\gamma(0), \gamma(1) \notin C$ and $\gamma(]0, 1[)$ meets C only transversally, in a finite number of regular points of C . For example, an oriented arc on a surface-link diagram, that avoids all branch and triple points and meets lines of double points transversally, produces a generic arc on the associated cut-diagram.

The next lemma follows from classical Thom's transversality theory.

Lemma 2.6.

- Any path on Σ with endpoints in $\Sigma \setminus C$ is homotopic to a generic path.
- If γ_1 and γ_2 are two homotopic generic paths, then they are related by a finite sequence of homotopies within generic paths, and the following local moves which are supported by a 2-disk in Σ , illustrated below in each case, that intersects C transversally:

H_1 : insertion/deletion of a loop going around a regular point of C

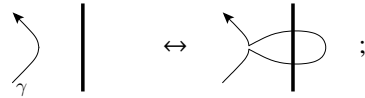

H_2 : insertion/deletion of a loop going around a point of $\partial C \setminus \partial \Sigma$

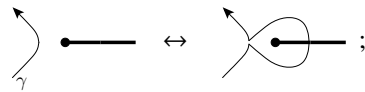

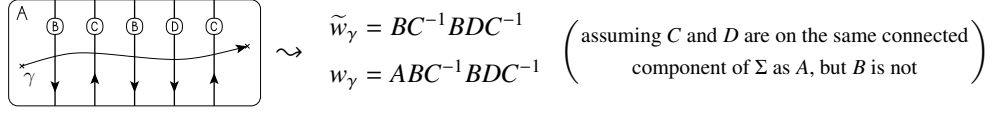
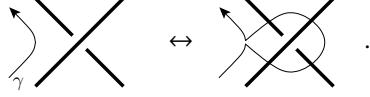
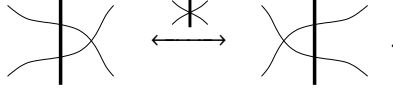

FIGURE 7. An example of word associated to a path

H_3 : insertion/deletion of a loop going around a double point of C



Remark 2.7. Recall that all homotopies of path are assumed to fix endpoints. Notice also that, in the statement of Lemma 2.6, homotopies within generic paths include in particular the following move, which may occur in dimension 2:



Indeed, the definition of generic path allows for a path to meet transversally the cut-diagram C several times at a same point; hence it allows the seemingly singular situation shown above the double-headed arrow.

Given a generic path γ on Σ , we associate unique words \tilde{w}_γ and w_γ of the regions of C as follows. For the k -th intersection point between γ and C met when running γ according to its orientation, denote by A_k the label of the cut domain met at this point, and by $\varepsilon_k = \pm 1$ the local sign of this intersection point. This local sign is 1 if the local orientation given by the orientation of γ and C agrees with the ambient orientation of Σ , and is -1 otherwise. Then the word \tilde{w}_γ associated to γ is given by

$$\tilde{w}_\gamma := A_1^{\varepsilon_1} \cdots A_{|\gamma \cap C|}^{\varepsilon_{|\gamma \cap C|}},$$

whereas the *normalized* word w_γ is given by

$$w_\gamma := A^{-|\gamma|} \tilde{w}_\gamma,$$

where A is the region where γ starts, and $|\gamma|$ is the sum of the exponents ε_i in \tilde{w}_γ such that A_i is in the same connected component as γ ; see Figure 7 for an example.

Hence any generic path on Σ gives rise in this way to elements \tilde{w}_γ and w_γ in the group $G(C)$, simply by regarding each region as the associated meridian in the group.

Remark 2.8. If γ is a generic path joining two regions A and B , then the Wirtinger relations imply that $B = A^{\tilde{w}_\gamma} = A^{w_\gamma}$ in $G(C)$. This elementary observation has two important consequences:

- (1) any two meridians of a same connected component of Σ are conjugate, so that $G(C)$ is normally generated by any choice of one meridian on each connected component of Σ ;
- (2) if γ is a generic loop based in a region R , then $[R, \tilde{w}_\gamma] = [R, w_\gamma] = 1$ in $G(C)$.

In view of Remark 2.8 (1), any conjugate of a meridian of $G(C)$ will also be called *meridian* by abuse of notation—see the last paragraph of Section 7.1 for a full legitimization of this terminology.

Remark 2.9. In the case of a duplicated presentation for $G(C)$, discussed in Remark 2.4, a given region no longer corresponds to a unique meridian in the group. The word \tilde{w}_γ (and, likewise, w_γ), associated to a generic path γ , is then constructed as above, except that the letters are chosen in the larger alphabet $\{(R^{(j)})^{\pm 1} \mid R \text{ region of } C, 1 \leq j \leq k_R\}$ of all meridians; each letter, associated to the intersection of γ with a cut domain labeled by some region R , is then *chosen* among the meridians $\{R^{(j)}\}_{1 \leq j \leq k_R}$. There may be hence several words associated to this path γ and we assume that \tilde{w}_γ (and, likewise, w_γ) is just one of them, freely chosen. It is clear, from the relations in the group $G(C)$ with duplicated meridians, that any two such choices of word will describe the same group element.

2.3. Loop-longitudes. We will now define a notion of longitudes, associated to homotopy classes of paths on Σ . For that, we will need the following.

Lemma 2.10. *If γ and γ' are be two homotopic generic paths in Σ , then $w_\gamma = w_{\gamma'}$ in $G(C)$.*

Proof. Since they are homotopic, γ and γ' differ by a finite sequence of the moves H_1 , H_2 and H_3 , described in Lemma 2.6.⁵ It is sufficient to deal with each of them separately.

The case of move H_1 is clear.

In the case of move H_2 , γ splits into $\gamma_1 \cdot \gamma_2$, where γ_1 starts at the same region B as γ , while γ_2 starts at the region A supporting the local move:

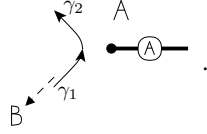

Then we have $w_\gamma = B^s \tilde{w}_{\gamma_1} \tilde{w}_{\gamma_2}$, while $w_{\gamma'} = B^{s-\varepsilon} \tilde{w}_{\gamma_1} A^\varepsilon \tilde{w}_{\gamma_2}$ for some $s \in \mathbb{Z}$ and some $\varepsilon = \pm 1$. But, since γ_1 connects B to A , we have $A = B^{\tilde{w}_{\gamma_1}}$ so that, in $G(C)$:

$$w_{\gamma'} = B^{s-\varepsilon} \tilde{w}_{\gamma_1} (B^\varepsilon)^{\tilde{w}_{\gamma_1}} \tilde{w}_{\gamma_2} = w_\gamma.$$

In the case of move H_3 , we may assume, up to some moves H_1 , that γ splits as follows into $\gamma_1 \cdot \gamma_2$:

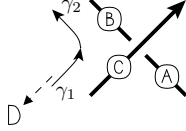

so that $w_\gamma = D^s \tilde{w}_{\gamma_1} \tilde{w}_{\gamma_2}$ and $w_{\gamma'} = D^s \tilde{w}_{\gamma_1} (A^\varepsilon)^C B^{-\varepsilon} \tilde{w}_{\gamma_2}$ for some $s \in \mathbb{Z}$ and some $\varepsilon = \pm 1$, where A , B and C are the labels as shown above, and D is the starting region of γ . But, by the first labeling condition, the pair (A, B) is C -adjacent, hence we have $A^C B^{-1} = 1$ in $G(C)$. \square

Now, for each $i \in \{1, \dots, \ell\}$, pick an i -th meridian R_i and a basepoint $p_i \in \Sigma_i$ in the interior of the corresponding region. This provides in particular a preferred set of normal generators for $G(C)$. Then, thanks to Lemma 2.10, we can define the i -th loop-longitude map

$$\lambda_i^l: \begin{array}{ccc} \pi_1(\Sigma_i, p_i) & \longrightarrow & G(C) \\ [\gamma] & \longmapsto & w_\gamma \end{array},$$

where $[\gamma]$ is an element of $\pi_1(\Sigma_i, p_i)$ represented by a generic loop γ based at p_i .⁶ Observe that λ_i^l is actually a group homomorphism. Indeed, for any two loops γ_1, γ_2 based at p_i , it follows from Remark 2.8 (2) that $w_{\gamma_1 \cdot \gamma_2} = R_i^{-|\gamma_1| - |\gamma_2|} \tilde{w}_{\gamma_1} \tilde{w}_{\gamma_2} = R_i^{-|\gamma_1|} \tilde{w}_{\gamma_1} R_i^{-|\gamma_2|} \tilde{w}_{\gamma_2} = w_{\gamma_1} w_{\gamma_2}$.

⁵Note that homotopies through generic paths clearly preserve the associated words.

⁶As noted at the end of the introduction, we will usually omit the brackets in our notation in the rest of the paper.

Definition 2.11. The elements in $\text{Im}(\lambda_i^l)$ are called *i-th (preferred) loop-longitudes* for C . They are well-defined up to the choice of p_i , that is up to a simultaneous conjugation of R_i and all *i-th* longitudes by some element $w \in G(C)$.

In general, C has an infinite number of loop-longitudes, and it will sometimes be useful to consider only a finite generating set of these loops.

Definition 2.12. Suppose that we are given, for each component Σ_i of Σ , a collection of loops $\{\gamma_{ij}\}_j$ based at p_i , which represent a generating set for $\pi_1(\Sigma_i; p_i)$. We call *system of loop-longitudes* for Σ the collection of associated preferred *i-th* loop-longitudes, each denoted by $w_{ij} := w_{\gamma_{ij}} \in G(C)$.

Observe that any system $\{w_{ij}\}$ of loop-longitudes determines the whole loop-longitude maps λ_i^l .

2.4. Arc-longitudes. By Section 2.2, the homotopy class of any path on Σ leads to a normalized word, which represents a well-defined element of $G(C)$ by Lemma 2.10. It is hence possible to consider a wider range of longitudes. As a matter of fact, if $\partial\Sigma \neq \emptyset$, we shall also consider ‘boundary-to-boundary’ longitudes. So, for each $i \in \{1, \dots, \ell\}$ such that $\partial\Sigma_i \neq \emptyset$, we fix *boundary basepoints* p_{ij} , $j \in \{0, \dots, |\partial\Sigma_i| - 1\}$ on each boundary component of Σ_i . All these boundary basepoints are chosen disjoint from C . This provides an ordering of the components of $\partial\Sigma_i$, and the one containing p_{i0} should be regarded as a ‘marked’ boundary component of Σ_i .

We set $\mathcal{A}(\Sigma_i, \{p_{ij}\}_j)$ to be the set of homotopy classes of paths from p_{i0} to some p_{ij} for $j > 0$, up to homotopy, and we define the *i-th arc-longitude maps*

$$\lambda_i^a : \begin{array}{ccc} \mathcal{A}(\Sigma_i, \{p_{ij}\}_j) & \longrightarrow & G(C) \\ [\gamma] & \longmapsto & w_\gamma \end{array} .$$

Here, $[\gamma]$ is the element of $\mathcal{A}(\Sigma_i, \{p_{ij}\}_j)$ represented by a generic path γ from p_{i0} to some p_{ij} . Elements of $\text{Im}(\lambda_i^a)$ are called *i-th (preferred) arc-longitudes*.

We stress that the well-definedness of arc-longitudes requires the choice of the basepoints $\{p_{ij}\}$, and that these are kept fixed at all time.

Remark 2.13. If Σ_i is not simply connected, for each $j > 0$, $\mathcal{A}(\Sigma_i, \{p_{ij}\}_j)$ contains several element ending at p_{ij} , possibly infinitely many. However, fixing a generic path γ_i from p_i to p_{i0} , there is a simply transitive left action of $\pi_1(\Sigma_i, p_i)$ on $\mathcal{A}(\Sigma_i, \{p_{ij}\}_j)$, defined as $\tau \cdot \gamma := \tau \gamma_i \cdot \gamma$. A *system of arc-longitudes*, made of one arc-longitude per $j > 0$, is hence sufficient to recover all elements of $\mathcal{A}(\Sigma_i, \{p_{ij}\}_j)$.

2.5. Peripheral systems. In the sequel, we shall simply use the terminology *longitude* when referring to either a preferred loop- or arc-longitude. We shall denote by

$$\lambda_i : \pi_1(\Sigma_i, p_i) \sqcup \mathcal{A}(\Sigma_i, \{p_{ij}\}_j) \rightarrow G(C)$$

the *i-th longitude maps*, simply defined by combining λ_i^l and λ_i^a .

All the notions defined so far can now be gathered into the following.

Definition 2.14. A *peripheral system* of C is the data $(G(C); \{R_i\}, \{\lambda_i\})$ of the group of C together with the choice, for each component Σ_i , of a meridian R_i and its longitude map λ_i . Two peripheral systems $(G(C); \{R_i\}, \{\lambda_i\})$ and $(G(C'); \{R'_i\}, \{\lambda'_i\})$ of cut-diagrams over Σ are *equivalent* if there exists a bijection ρ from $\pi_1(\Sigma_i, p_i) \sqcup \mathcal{A}(\Sigma_i, \{p_{ij}\}_j)$ to itself which is induced by a diffeomorphism of Σ , an isomorphism $\varphi : G(C) \rightarrow G(C')$ and elements $w_1, \dots, w_\ell \in G(C')$ such that, for every $i \in \{1, \dots, \ell\}$, we have $R'_i = \varphi(R_i)^{w_i}$ and

$$\lambda'_i(\gamma) = \begin{cases} \varphi(\lambda_i(\rho(\gamma)))^{w_i} & \text{for every loop } \gamma \in \pi_1(\Sigma_i; p_i), \\ \varphi(\lambda_i(\rho(\gamma))) & \text{for every arc } \gamma \in \mathcal{A}(\Sigma_i, \{p_{ij}\}_j). \end{cases}$$

Note that peripheral systems of equivalent cut-diagrams are equivalent. We stress that the above notion of equivalence for peripheral systems involves only the loop-longitudes, and that arc-longitudes are not required to be conjugated. The endpoints p_{ij} of arc-longitudes are indeed fixed throughout.

For every $q \geq 1$, the q -th nilpotent peripheral system of C is the data, associated to a peripheral system $(G(C); \{R_i\}, \{\lambda_i\})$, of the q -th nilpotent quotient $N_q G(C)$, together with the image of each R_i in $N_q G(C)$ and the composite of each longitude map λ_i with the projection from $G(C)$ to $N_q G(C)$. Definition 2.14 naturally induces a notion of equivalence for q -th nilpotent peripheral systems.

Remark 2.15. As far as the authors know, a general notion of (preferred) longitude for surface-links has not been clearly defined in the literature. It is however natural to define those as the image, in the fundamental group of the surface complement, of either a cycle or a (canonically closed) boundary-to-boundary path on the surface, pushed out of the surface in such a way that it has homological intersection zero with the surface. In this setting, it is clear that the preferred longitudes of a topological 2-dimensional cut-diagram agrees with the preferred longitudes of the underlying surface-link. This remains true in higher dimensions.

3. CHEN HOMOMORPHISMS AND A CHEN–MILNOR THEOREM FOR CUT-DIAGRAMS

The purpose of this section is to give an analogue, for cut-diagrams, of the Chen–Milnor presentation for the nilpotent quotients of fundamental group of link complements. In the context of links, Milnor established in [24], building on earlier works of Chen [8], such a presentation, with one generator per component, and meridian/loop-longitude commutation relations.

In what follows, C denotes an n -dimensional cut-diagram over $\Sigma = \sqcup_{i=1}^{\ell} \Sigma_i$. We also denote by $C_i = C \cap \Sigma_i$ the i -th component of C .

3.1. Road networks and the Chen homomorphisms. A central tool in establishing the Chen–Milnor presentation for links is an inductively defined sequence of maps η_q . These are not only a central theoretical tool, but they also provides an effective algorithm to compute the image of preferred longitudes in nilpotent quotients, by expressing recursively each i -th meridian as a conjugate of a chosen meridian R_i . The major difference with the link case is that, in the context of cut-diagrams, there is no canonical way to express these conjugations; as a matter of fact, we shall fix paths joining any region to the basepoint of its connected component.

Fix a basepoint p_i on each connected component Σ_i , away from C . Regions of C living in Σ_i will be denoted by R_{ij} , with $R_i := R_{i0}$ the region containing p_i . We also denote by $F = \langle R_i \rangle$ and $\bar{F} = \langle R_{ij} \rangle$ the free group generated by the R_i and the R_{ij} , respectively.

Definition 3.1. A *road network* α for C is the choice, on each component Σ_i of Σ , of a collection of oriented generic paths α_{ij} , called *roads*, running from p_i to a point in each region R_{ij} . We shall sometimes stress the choice of basepoints by referring to α as a road network *based at* $\{p_i\}$.

Following Section 2.2, a word $v_{ij} := \tilde{w}_{\alpha_{ij}} \in \bar{F}$ can be associated to each road α_{ij} . Notice that, from the Wirtinger presentation of $G(C)$, the relation $R_{ij} = R_i^{v_{ij}}$ holds in $G(C)$ (see Remark 2.8 (1)).

Definition 3.2. We define *Chen homomorphisms* $\eta_q^\alpha : \bar{F} \rightarrow F$ by setting, for every i, j and $q \geq 1$:

$$\begin{aligned} \eta_1^\alpha(R_{ij}) &:= R_i, \\ \eta_{q+1}^\alpha(R_i) &:= R_i \text{ and } \eta_{q+1}^\alpha(R_{ij}) := R_i^{\eta_q^\alpha(v_{ij})}. \end{aligned}$$

As the notation suggests, this sequence of homomorphisms *a priori* depends on the choice of road network α . However, for simplicity we will often drop the α from the notation.

Remark 3.3. Since F is a subgroup of \bar{F} , one can compose η_q^α with itself, and it follows from its definition that $\eta_q^\alpha \circ \eta_q^\alpha = \eta_q^\alpha$. This simple fact will be important later, when dealing with the dependance on the choice of road network.

Remark 3.4. We use the terminology Chen homomorphisms for these η_q maps. In the study of links, they indeed first appeared, implicitly, in the work of Chen [8]. Specifically, in the notation of [8, §4], we have $\eta_q = \varphi \circ \psi^{q-1}$. The inductive definition for η_q appeared in [24].

Remark 3.5. In the case of a duplicated presentation for $G(C)$, F is still the free group generated by a single meridian R_i for each component Σ_i , but \bar{F} is now defined as the free group generated by *all meridians* $R^{(j)}$, rather than all regions. A road network α is then a choice, for each component Σ_i , of a collection of oriented generic paths from the basepoint p_i to each of its regions, such that distinct paths may be chosen for distinct meridians associated to a same region (hence several roads may run from p_i to this region). To each such road r , one associates a choice of word $\tilde{w}_r \in \bar{F}$ as explained in Remark 2.9, and the definition of the Chen homomorphisms proceeds just as in Definition 3.2. Note that, if the meridian R_i is duplicated, then only one copy identifies as the ‘base’ meridian associated to p_i , while other copies are treated as any other meridians, i.e. are connected to p_i by some roads and give rise to conjugations in the definition of the Chen homomorphisms. We note that Lemmas 3.7 and 3.8 below clearly hold in the duplicated setting.

We now derive some elementary properties of the Chen homomorphisms η_q , and for that, we will often make use of the following elementary fact.

Claim 3.6. Let G be a group, N a normal subgroup of G , and $q \geq 1$. For any $x, y, a \in G$, if $x \equiv y \pmod{G_q \cdot N}$, then $a^x \equiv a^y \pmod{G_{q+1} \cdot N}$.

Proof. It follows from the equivalence $a^x = y^{-1}[xy^{-1}, a^{-1}]ay \equiv a^y \pmod{G_{q+1}}$. \square

Lemma 3.7. For all $q \geq 1$, and all $w \in \bar{F}$, $\eta_q(w) \equiv \eta_{q+1}(w) \pmod{F_q}$.

Proof. The claim is obvious for $q = 1$, since $F_1 = F$. Assume now that the claim holds for some $q \geq 1$. Then it suffices to consider the case $w = R_{ij}$ for any i, j . By induction hypothesis, $\eta_{q+1}(v_{ij}) \equiv \eta_q(v_{ij}) \pmod{F_q}$ so that, by Claim 3.6, $\eta_{q+1}(R_{ij}) = R_i^{\eta_{q+1}(v_{ij})} \equiv R_i^{\eta_q(v_{ij})} = \eta_{q+2}(R_{ij}) \pmod{F_{q+1}}$. \square

Lemma 3.8. For any generator R_{ij} of \bar{F} , $\eta_q(R_{ij}) \equiv R_{ij} \pmod{\bar{F}_q \cdot W}$.

Proof. We proceed by induction on q . The case $q = 1$ is trivial. Assume now that $\eta_q(v_{ij}^{\pm 1}) \equiv v_{ij}^{\pm 1} \pmod{\bar{F}_q \cdot W}$. Then, by Claim 3.6 and the definition of η_{q+1} , we have that $\eta_{q+1}(R_{ij}) = R_i^{\eta_{q+1}(v_{ij})} \equiv R_i^{\eta_q(v_{ij})} \equiv R_i^{v_{ij}} \equiv R_{ij} \pmod{\bar{F}_{q+1} \cdot W}$. \square

An immediate consequence of Lemma 3.8 is the following, showing that at the q -th nilpotent level, the choice of road network has no effect on the η_q map.

Corollary 3.9. Let α, α' be two road networks for C , possibly with different basepoints. Then, for any $w \in \bar{F}$, $\eta_q^\alpha(w) \equiv \eta_q^{\alpha'}(w) \pmod{\bar{F}_q \cdot W}$, and hence $\eta_q^\alpha(w) = \eta_q^{\alpha'}(w)$ in $N_q G(C)$.

However we shall see later, in Lemma 4.17, that the choice of road network has more subtle consequences at the level of word representatives for elements of $N_q G(C)$.

3.2. Nilpotent quotients. We can now give a first presentation for the nilpotent quotients of $G(C)$, with as many generators as components in C , and only nilpotent and meridian/longitude commutation relations. The main result of this section, the Chen–Milnor presentation of Theorem 3.15, will later significantly reduce the number of relations.

Before stating our first presentation, we need to define *walls* of C , which are connected components of regular points of C . They actually correspond to regular ‘walls’ between adjacent regions. Note that each cut domain is a union of walls (and some higher singularity loci), so that walls inherit a labeling by regions. Consider now some wall a of C , say on the i -th component and labeled by some region R . Recall from Section 2 that the Wirtinger relation $R_{ik} = R_{ij}^R$ holds in $G(C)$, where (R_{ij}, R_{ik}) is the pair of R -adjacent regions at a . Consider both roads $\alpha_{ij}, \alpha_{ik} \in \alpha$ running from p_i to R_{ij} and R_{ik} , respectively, and denote as above by v_{ij} and v_{ik} the associated words in \bar{F} . We define the word $w_a \in \bar{F}$ by

$$(3.1) \quad w_a := v_{ij} R v_{ik}^{-1},$$

which is actually the (not necessarily normalized) word associated to the p_i -based loop defined by connecting α_{ij} to α_{ik}^{-1} with a segment crossing a transversally.

Notation 3.10. For all $q \geq 1$, we denote by $C_{(q)}$ the normal closure of all relations $[R_i, \eta_q(w_a)]$ in F , for all walls a in C , with w_a defined in Equation (3.1) above.

Lemma 3.11. *For all $q \geq 1$, we have an isomorphism*

$$N_q G(C) \cong F / F_q \cdot C_{(q)}.$$

In other words, $N_q G(C)$ has the following presentation

$$\left\langle R_1, \dots, R_\ell \mid F_q; [R_i, \eta_q(w_a)] \text{ for all } i \text{ and all walls } a \text{ on } C_i \right\rangle.$$

Proof. The homomorphism η_q naturally descends to a map $N_q \bar{F} \rightarrow F / F_q \cdot C_{(q)}$. Now consider, with the above notation, the Wirtinger relator $R_{ik}^{-1} R_{ij}^R$ at some wall a on C_i . We have

$$\begin{aligned} \eta_q(R_{ik}^{-1} R_{ij}^R) &= \left(R_i^{\eta_{q-1}(v_{ik})} \right)^{-1} \eta_q(R)^{-1} R_i^{\eta_{q-1}(v_{ij})} \eta_q(R) \\ &\equiv \left(R_i^{\eta_q(v_{ik})} \right)^{-1} \eta_q(R)^{-1} R_i^{\eta_q(v_{ij})} \eta_q(R) = [R_i, \eta_q(w_a)]^{\eta_q(v_{ik})} \pmod{F_q} \end{aligned}$$

where the equivalence combines Lemma 3.7 and Claim 3.6. This shows that η_q induces a well-defined epimorphism from $N_q G(C)$ to $F / F_q \cdot C_{(q)}$. It is easily checked, using Lemma 3.8 and the above equivalence, that the natural inclusion map $F \rightarrow \bar{F}$ yields an inverse for this latter map, which is thus an isomorphism. \square

We note that we have the following seemingly weaker form of Lemma 3.11, with an infinite number of commutator relations. This version shall however be useful on several occasions.

Proposition 3.12. *For all $q \geq 1$, the group $N_q G(C)$ has the following presentation*

$$\left\langle R_1, \dots, R_\ell \mid F_q; [R_i, \eta_q(w_\gamma)] \text{ for all } i \text{ and all } p_i\text{-based generic loop } \gamma \text{ on } \Sigma_i \right\rangle.$$

Remark 3.13. Notice that we may equally well use relations $[R_i, \eta_q(\tilde{w}_\gamma)]$, with the words \tilde{w}_γ in the above presentation. Indeed we have, for some $s \in \mathbb{Z}$:

$$[R_i, \eta_q(w_\gamma)] = [R_i, \eta_q(R_i^s \tilde{w}_\gamma)] = [R_i, R_i^s \eta_q(\tilde{w}_\gamma)] = [R_i, \eta_q(\tilde{w}_\gamma)].$$

Proof. Using Remark 3.13, we have that relations in Lemma 3.11 are special cases of the relations in Proposition 3.12. It is hence sufficient to show that, for any i -th preferred loop-longitude w_γ , the relation $[R_i, \eta_q(w_\gamma)]$ can be deduced from the relations in

$$\left\{ [R_i, \eta_q(w_a)] \mid a \text{ wall of } C \right\}.$$

The proof is essentially given in the figure below, as follows. Let γ be a p_i -based generic loop on Σ_i . The associated word w_γ is of the form

$$w_\gamma := R_i^s R_{i_1 j_1}^{\varepsilon_1} R_{i_2 j_2}^{\varepsilon_2} \cdots R_{i_m j_m}^{\varepsilon_m},$$

for some $m, s \geq 0$ and $\varepsilon_k \in \{\pm 1\}$, where the $R_{i_k j_k} \in \bar{F}$ are the labels of the successive walls a_k met transversally when running along γ ; see below on the left.

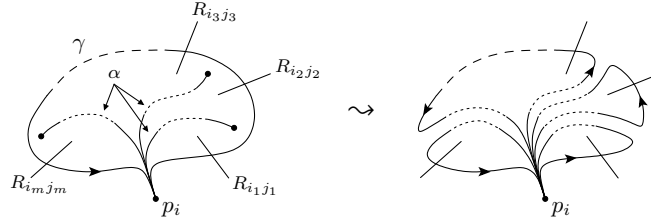

Then, as illustrated in the figure above, a homotopy of γ , guided by the road network α and involving only moves H_1 of Lemma 2.6, gives directly the decomposition

$$w_\gamma = R_i^s w_{a_1}^{\varepsilon_1} w_{a_2}^{\varepsilon_2} \cdots w_{a_r}^{\varepsilon_r},$$

where the words w_{a_k} are defined in Equation (3.1). The commutation of R_i with w_γ then follows easily from the commutation of R_i with each w_{a_k} . \square

Remark 3.14. The statement of Proposition 3.12 can be adapted to the case of a duplicated presentations for $G(C)$. But in this case, in the presentation for $N_q G(C)$, the relations $[R_i, \eta_q(w_\gamma)]$ have to be considered for all i , all p_i -based generic loop γ on Σ_i and all representative words $w_\gamma \in \bar{F}$. Recall indeed from Remark 2.9 that, in the case of a duplicated presentation, the definition of the word w_γ associated with a path γ involves a choice: here we consider one relation for each possible choice. The proof then follows strictly the same lines, with only the following two adjustments:

- the definition of w_a , given in Equation (3.1), has to be considered in several versions, one for each meridian associated to the three involved regions R , R_{ij} and R_{ik} ;
- the relations $(R^{(j)})^{-1} R^{(j)}$ in $G(C)$, corresponding to multiple meridians associated to a region R of Σ_i , induce extra relations $[R_i, \eta_q(w_{\gamma', \gamma^{-1}})]$ in the statement of Lemma 3.11, where γ and γ' are the roads associated to $R_i^{(j)}$ and $R_i^{(j')}$, respectively. But all these relations are directly of the type meridian/loop-longitude commutations of Proposition 3.12, hence this latter statement remains true in the duplicated settings.

3.3. Chen–Milnor type presentations. For each component Σ_i of Σ , pick a system of loop-longitudes $\mathcal{L}_i(\Sigma) := \{w_{ij}\}_j$ associated with a collection of loops $\{\gamma_{ij}\}_j$ based at p_i (see Definition 2.12). The following is the first main result of this paper.

Theorem 3.15. *If C is a cut-diagram over Σ , then for each $q \in \mathbb{N}$ we have the following presentation for the q -th nilpotent quotient $N_q G(C)$ of $G(C)$:*

$$\left\langle R_1, \dots, R_\ell \mid F_q; [R_i, \eta_q(w_{ij})] \text{ for all } i \text{ and all } w_{ij} \in \mathcal{L}_i(\Sigma) \right\rangle.$$

Proof. The proof builds on the presentation given in Proposition 3.12: the idea is to show that the infinite family of commutation relations in Proposition 3.12, involving *all* generic loops on Σ_i , can be realized by just the commutation relations involving the finite collection loops in $\{\gamma_{ij}\}_i$. In fact, we shall prove more precisely that $F_q \cdot L_{(q)} = F_q \cdot V_{(q)}$, where

- $L_{(q)}$ is the normal closure of $\{[R_i, \eta_q(w_\gamma)] \mid \gamma \text{ any } p_i\text{-based generic loop on } \Sigma_i\}$ in F ,
- $V_{(q)}$ is the normal closure of $\{[R_i, \eta_q(w_{ij})] \mid w_{ij} \in \mathcal{L}_i(\Sigma)\}$ in F .

The inclusion $F_q \cdot V_{(q)} \subset F_q \cdot L_{(q)}$ is clear. To prove the converse inclusion, it suffices to show that the map $F/F_q \cdot V_{(q)} \rightarrow F/F_q \cdot L_{(q)}$, induced by identity, is injective. This is a consequence of Proposition 3.16 below. Indeed, since any loop on Σ_i is homotopic to a product of elements in $\{\gamma_{ij}^{\pm 1}\}_j$, this proposition in particular implies that $[R_i, \eta_q(w_\gamma)] \equiv 1 \pmod{F_q \cdot V_{(q)}}$ for any p_i -based loop γ on Σ_i , and the result follows. \square

Proposition 3.16. *Let C be a cut-diagram over Σ . For any two homotopic arcs γ, γ' on Σ , we have*

$$\eta_q(w_\gamma) \equiv \eta_q(w_{\gamma'}) \pmod{F_q \cdot V_{(q)}}.$$

We stress that the paths γ, γ' in the statement may have arbitrary endpoints, and are in particular not required to start at the region R_i .

Proof. Note that the case $q = 1$ of the claim is trivial, and assume inductively that Proposition 3.16 holds for some $q \geq 1$. We first observe the inclusion

$$(3.2) \quad F_{q+1} \cdot V_{(q)} \subset F_{q+1} \cdot V_{(q+1)}, \text{ for all } q \geq 1.$$

This is true, since by Lemma 3.7 and Claim 3.6, we have $[a_i, \eta_q(w_{ij})] \equiv [a_i, \eta_{q+1}(w_{ij})] \pmod{F_{q+1}}$ for any i, j .

Now, two homotopic arcs γ, γ' differ by a sequence of the three local moves H_1, H_2 and H_3 of Lemma 2.6. So it suffices to check the claim when γ and γ' differ by one of these three moves. In the rest of this proof, for a given region R , we shall denote by v_R the word associated with the road, from the road network α , running to R .

- If γ and γ' differ by move H_1 , then $w_\gamma = w_{\gamma'}$ in \bar{F} so the desired equivalence holds trivially.
- We now consider the case where γ and γ' differ by move H_2 , with γ corresponding to the left-hand side of the move. We then have

$$w_\gamma = B^s \tilde{w}_{\gamma_1} \tilde{w}_{\gamma_2} \quad \text{and} \quad w_{\gamma'} = B^{s-\varepsilon} \tilde{w}_{\gamma_1} A^\varepsilon \tilde{w}_{\gamma_2},$$

where γ_1, γ_2 are paths such that $\gamma = \gamma_1 \cdot \gamma_2$, $s \in \mathbb{Z}$, $\varepsilon = \pm 1$, and B is the region of Σ_i where γ_1 starts:

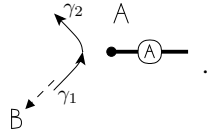

By definition of the Chen homomorphism, we have

$$\eta_{q+1}(w_{\gamma'}) = \eta_q(v_B^{-1}) R_i^{s-\varepsilon} (R_i^\varepsilon)^{\eta_q(v_A) \eta_{q+1}(\tilde{w}_{\gamma_1}^{-1}) \eta_q(v_B^{-1})} \eta_q(v_B) \eta_{q+1}(\tilde{w}_{\gamma_1} \tilde{w}_{\gamma_2}).$$

Observe that $v_A \tilde{w}_{\gamma_1}^{-1} v_B^{-1}$ represents a p_i -based loop on Σ_i , which is homotopic to a product ξ of elements in $\{\gamma_{ij}^{\pm 1}\}$. Using Lemma 3.7 and the induction hypothesis, we thus have

$$\eta_q(v_A) \eta_{q+1}(\tilde{w}_{\gamma_1}^{-1}) \eta_q(v_B^{-1}) \equiv \eta_q(v_A \tilde{w}_{\gamma_1}^{-1} v_B^{-1}) \equiv \eta_q(\tilde{w}_\xi) \pmod{F_q \cdot V_{(q)}}.$$

This implies, by Claim 3.6, that

$$\eta_{q+1}(w_{\gamma'}) \equiv \eta_q(v_B^{-1})R_i^{s-\varepsilon} (R_i^\varepsilon)^{\eta_q(\tilde{w}_\xi)} \eta_q(v_B)\eta_{q+1}(\tilde{w}_{\gamma_1}\tilde{w}_{\gamma_2}) \equiv \eta_{q+1}(w_\gamma) \pmod{F_{q+1}V_{(q)}},$$

where the last equivalence simply uses the fact that $[R_i, \eta_q(\tilde{w}_\xi)] = [R_i, \eta_q(w_\xi)] \equiv 1 \pmod{V_{(q)}}$. The conclusion then follows from (3.2).

- Suppose now that γ and γ' differ by move H_3 , with γ corresponding to the left-hand side of the move. Then, up to some moves H_1 , we may assume that the situation is as shown below, so that there exists two arcs γ_1, γ_2 on Σ_i such that

$$w_\gamma = D^s \tilde{w}_{\gamma_1} \tilde{w}_{\gamma_2} \quad \text{and} \quad w_{\gamma'} = D^s \tilde{w}_{\gamma_1} (A^\varepsilon)^C B^{-\varepsilon} \tilde{w}_{\gamma_2},$$

for some $s \in \mathbb{Z}$ and some $\varepsilon \in \{\pm 1\}$, and where R_{ik} is the starting region of γ_1 and (A, B) is the pair of C -adjacent cut domains on Σ_j involved in the move.

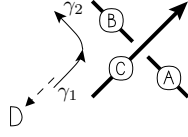

One can then easily check, using the definition of the Chen homomorphisms, that we have

$$\eta_{q+1}(w_{\gamma'}) = \eta_{q+1}(D^s \tilde{w}_{\gamma_1}) [X, R_j^{-\varepsilon}]^{\eta_q(v_B)} \eta_{q+1}(\tilde{w}_{\gamma_2}),$$

where we set $X := \eta_q(v_A)\eta_{q+1}(C)\eta_q(v_B^{-1})$. By Lemma 3.7, we have $X \equiv \eta_q(v_A C v_B^{-1}) \pmod{F_q}$. And the word $v_A C v_B^{-1}$ is associated to a p_j -based loop on Σ_j , which is thus homotopic to a product ξ of elements in $\{\gamma_{jk}^{\pm 1}\}$. So the induction hypothesis gives that $X \equiv \eta_q(\tilde{w}_\xi) \pmod{F_q \cdot V_{(q)}}$. Claim 3.6 then gives

$$[X, R_j^{-\varepsilon}] = (R_j^\varepsilon)^X R_j^{-\varepsilon} \equiv (R_j^\varepsilon)^{\eta_q(\tilde{w}_\xi)} R_j^{-\varepsilon} \equiv 1 \pmod{F_{q+1} \cdot V_{(q)}}.$$

And by (3.2), this implies that

$$\eta_{q+1}(w_{\gamma'}) \equiv \eta_{q+1}(D^s \tilde{w}_{\gamma_1}) \eta_{q+1}(\tilde{w}_{\gamma_2}) \equiv \eta_{q+1}(w_\gamma) \pmod{F_{q+1} \cdot V_{(q+1)}}.$$

This concludes the proof. \square

Remark 3.17. Theorem 3.15 does not only provide a presentation for $N_q G(C)$ derived from a system of loop-longitudes, it also gives, via the Chen homomorphisms, an algorithm to compute representative words for any element in $N_q G(C)$, and in particular for the longitudes in these quotient.

Remark 3.18. The statement of Theorem 3.15 still holds in the context of duplicated presentation for $G(C)$. Following Remark 3.14, Proposition 3.12 can indeed be used in the same way. The proof of Proposition 3.16 requires however one extra argument: in that case, two representative words for a given longitude differ from a finite sequence of four moves, the three moves H_1, H_2 and H_3 of Lemma 2.6, and a fourth move which replaces a letter $R^{(j)}$ by another meridian $R^{(j')}$ associated to the same region R of Σ_k , for some k . It is hence necessary to deal, in the induction process, with this last move. So let $w = w_1(R^{(j)})_2^\varepsilon$ and $w' = w_1(R^{(j')})^\varepsilon w_2$ be two words differing by this move, and denote by v and v' the two words associated to the roads joining the basepoint p_k to $R^{(j)}$ and $R^{(j')}$, respectively. Since $v'v^{-1}$ corresponds to a p_k -based loop, by induction hypothesis, we have $\eta_q(v'v^{-1}) \equiv \eta_q(\tilde{w}_\xi) \pmod{F_q \cdot V_{(q)}}$ for some product ξ of elements in $\{\gamma_{kj}^{\pm 1}\}$; it follows from Claim 3.6 that

$$[\eta_q(v'v^{-1}), R_k^{-\varepsilon}] \equiv [\eta_q(\tilde{w}_\xi), R_k^{-\varepsilon}] \equiv 1 \pmod{F_{q+1} \cdot V_{(q)}}.$$

Then observe that

$$\begin{aligned}\eta_{q+1}(w') &= \eta_{q+1}(w_1)(R_k^\varepsilon)^{\eta_q(v')} \eta_{q+1}(w_2) = [\eta_q(v'v^{-1}), R_k^{-\varepsilon}]^{\eta_q(v)\eta_{q+1}(w_1^{-1})} \eta_{q+1}(w) \\ &\equiv \eta_{q+1}(w) \pmod{F_{q+1} \cdot V_{(q)}},\end{aligned}$$

so that $\eta_{q+1}(w') \equiv \eta_{q+1}(w) \pmod{F_{q+1} \cdot V_{(q+1)}}$ by (3.2). This concludes the proof.

A major advantage of duplicated presentations is that it allows, in the algorithm leading to the explicit relations in Theorem 3.15, to use distinct roads for each occurrence of a same region in the longitudes $\{w_{ij}\}$. This fact will play a key role to prove, in Theorem 5.5, the invariance of the nilpotent peripheral system under concordance.

4. MILNOR INVARIANTS FOR CUT-DIAGRAMS

The purpose of this section is to define Milnor invariants for any cut-diagram C on Σ . In the classical setting of links in the 3–sphere, Milnor invariants are extracted from the coefficients in the Magnus expansion of the preferred longitudes, seen in the nilpotent quotients of the fundamental group of the link exterior. Now, as discussed in Sections 2.3 and 2.4, the notion of (preferred) longitudes for cut-diagrams comes in two flavors: loop-longitudes and arc-longitudes. As a matter of fact, although coming from a same global construction that associates a collection of ‘Milnor numbers’ to any generic path on Σ (Section 4.1), Milnor invariants defined from loop and arc-longitudes have rather different behaviors, and we shall discuss them separately (Sections 4.2 and 4.3).

Let us recall some notation used in the previous sections: $\Sigma = \sqcup_{i=1}^\ell \Sigma_i$ is an oriented n –dimensional manifold, and C is a cut-diagram over Σ . For all i , regions of Σ_i are denoted by $\{R_{ij}\}$. We also fix, for each $i \in \{1, \dots, \ell\}$ such that $\partial\Sigma_i \neq \emptyset$, a point p_{ik} on each boundary component of Σ_i ($k \in \{0, \dots, |\partial\Sigma_i| - 1\}$), and consider the component containing p_{i0} as a marked boundary component.

4.1. Milnor numbers associated with a longitude. Fix an integer $q \geq 1$. Although we are going to define here invariants for the cut-diagram C , we emphasize that they are determined by its q –th nilpotent peripheral system, as defined in Section 2.5. When referring to longitudes, we will often implicitly mean their images in the q –th nilpotent quotient $N_qG(C)$.

Let us choose, for each i , an i –th meridian R_i , and denote by $F := \langle R_i \rangle$ the free group generated by these meridians. We also pick a basepoint p_i on the region R_i . By Theorem 3.15, the above choice of an i –th meridian R_i for each component of C provides a generating set for $N_qG(C)$.

We also fix a system of loop-longitudes $\mathcal{L}_i(\Sigma)$ for Σ . Recall that, for each i , the system $\mathcal{L}_i(\Sigma)$ is given by the i –th loop-longitudes associated with a collection of loops on Σ_i representing a generating set for $\pi_1(\Sigma_i, p_i)$.

Now, let γ be a generic path in $\pi_1(\Sigma_i, p_i) \sqcup \mathcal{A}(\Sigma_i, \{p_{ij}\}_j)$, for some $i \in \{1, \dots, \ell\}$. Let ω_γ be a representative word in $\{R_i^{\pm 1}\}$ for the associated i –th longitude in $N_qG(C)$. This word is not to be confused with the normalized word w_γ , defined in Section 2.2, which is a word in the larger alphabet $\{R_{ij}^{\pm 1}\}$. In what follows, and abusing terminologies, we shall often blur the distinction between the path γ and the associated i –th longitude, seen either in $G(C)$ or in $N_qG(C)$.

Definition 4.1. The *Magnus expansion* of an element $w \in F$ is the formal power series $E(w) \in \mathbb{Z}\langle\langle \ell \rangle\rangle$ in ℓ noncommuting variables X_1, \dots, X_ℓ , obtained by substituting each R_i by $1 + X_i$, and each R_i^{-1} by $\sum_{k \geq 0} (-1)^k X_i^k$.

For any sequence $I = j_1 \cdots j_k$ of integers in $\{1, \dots, \ell\}$, we denote by $\mu_C(I; w)$ the coefficient

of the monomial $X_{j_1} \cdots X_{j_k}$ in $E(w)$, meaning that

$$E(w) = 1 + \sum_{j_1 \cdots j_k} \mu_C(j_1 \cdots j_k; w) X_{j_1} \cdots X_{j_k},$$

where the sum runs over all sequences of (possibly repeated) integers in $\{1, \dots, \ell\}$.

In particular, we can obtain in this way a collection of integers $\mu_C(I; \omega_\gamma)$, one for each sequence I of integers in $\{1, \dots, \ell\}$, from the representative word ω_γ . Of course, the coefficients $\mu_C(I; \omega_\gamma)$ are not determined by the i -th longitude γ , as they depend on the choice of the representative word ω_γ . But Theorem 3.15 tells us precisely how two different representatives may differ. Indeed we have a presentation

$$(4.1) \quad N_q G(C) \cong \left\langle R_i \mid F_q; [R_i, \omega_{ij}] \text{ for all } i, j \right\rangle,$$

where, for each i , the ω_{ij} 's are given word representatives in $\{R_i^{\pm 1}\}$ for the elements of the system of i -th loop-longitudes $\mathcal{L}_i(\Sigma)$. Note that we do not need here the explicit formula for ω_{ij} , given in Theorem 3.15 in terms of the Chen homomorphisms.

In order to extract invariants from the numbers $\mu_C(I; \omega_\gamma)$, we introduce the following indeterminacies.

Definition 4.2. For any sequence Ii of integers in $\{1, \dots, \ell\}$, we define

- $m_C(Ii) := \gcd \{ \mu_C(I; \omega_{ij}) \text{ for all } j \}$;
- $\Delta_C(I)$ is the greatest common divisor of all $m_C(J)$, where J is any sequence obtained from I by deleting at least one index, and possibly permuting the resulting sequence cyclically.

We emphasize the fact that the definition of $\Delta_C(I)$ only involves *loop*-longitudes on Σ .

Proposition 4.3. For any sequence I of at most $q - 1$ integers in $\{1, \dots, \ell\}$ and any $\gamma \in \pi_1(\Sigma_i, p_i) \sqcup \mathcal{A}(\Sigma_i, \{p_{ij}\}_j)$ for some $i \in \{1, \dots, \ell\}$, the residue class

$$\bar{\mu}_C(I; \gamma) := \mu_C(I; \omega_\gamma) \pmod{\Delta_C(Ii)}$$

does not depend on the representative word ω_γ .

This allows for the following definition.

Definition 4.4. The classes $\bar{\mu}_C(I; \gamma)$ are called *Milnor numbers* associated with γ .

We stress that, for Proposition 4.3, a choice of one meridian per component has been made, and $\bar{\mu}_C(I; \gamma)$ and $\Delta_C(Ii)$ may depend on this choice; this will be further discussed in the next subsection. The indeterminacy $\Delta_C(Ii)$ also depends on the choice of system of loop-longitude, which is addressed in Lemma 4.7.

Observe also that Milnor numbers are well-defined regardless of the initially fixed value for q . Indeed, the lower central series being decreasing, any representative word for an element of $G(C)$ in $N_q G(C)$ is also a representative word for its image in $N_{q'} G(C)$, for any $q' < q$. In particular, by taking q to be sufficiently large, Milnor numbers are defined for sequences of arbitrary length.

Proof of Proposition 4.3. We begin with a definition that already appears in the work of Milnor in the classical link case, and which will also be a key tool in our more general context. For every $i \in \{1, \dots, \ell\}$, we denote by D_i the set of all power series $\sum v(i_1 \cdots i_k) X_{i_1} \cdots X_{i_k}$ in $\mathbb{Z}\langle\langle \ell \rangle\rangle$ whose coefficients satisfy $v(i_1 \cdots i_k) \equiv 0 \pmod{\Delta_C(i_1 \cdots i_k)}$ for all $i_1 \cdots i_k$ with $k < q$. Note that, by definition, the Magnus expansions of two words representing an i -th longitude yield the same residue classes up to degree q , if their difference is in D_i . Moreover, following verbatim Milnor's argument in the link case, the following statements are straightforwardly checked.

Claim 4.5.

- (i). The set D_i is a two-sided ideal of $\mathbb{Z}\langle\ell\rangle$; see [24, (16)].
- (ii). For any $j \in \{1, \dots, \ell\}$ and any representative word $\omega_i \in F$ for an i -th loop-longitude, both $X_j(E(\omega_i) - 1)$ and $(E(\omega_i) - 1)X_j$ are elements of D_i ; see [24, (17)].
- (iii). Let $\mu_C(j_1 \cdots j_k; \omega_i)X_{j_1} \cdots X_{j_k}$ be any term in $E(\omega_i)$, for some word $\omega_i \in F$ representing an i -th loop-longitude, and let $\iota_j(X_{j_1} \cdots X_{j_k})$ be a monomial obtained from $X_{j_1} \cdots X_{j_k}$ by inserting at least one copy of X_j , then $\mu_C(j_1 \cdots j_k; \omega_i)\iota_j(X_{j_1} \cdots X_{j_k})$ is in D_i ; see [24, (18)].
- (iv). For any j and k , both $X_j(E(\omega_{jk}) - 1)$ and $(E(\omega_{jk}) - 1)X_j$ are in D_i ; see [24, (19)].
- (v). For any element $w \in F_q$, $E(w)$ is equivalent to 1 modulo D_i ; see [24, (20)].

Now, by (4.1), two word representatives of an element in $N_q G(C)$ differ by a finite sequence of insertions/deletions of

- (1) $R_j^{\pm 1} R_j^{\mp 1}$ for some j ;
- (2) q -iterated commutators;
- (3) commutators $[R_i, \omega_{ij}]$ for some i and j .

It is hence sufficient to check that the insertion of any such word modifies the Magnus expansion by an element of D_i . Case (1) is just clear. Case (2) is a direct consequence of (v) and (i). And case (3) can be shown, using (iv) and (i), with the exact same argument as in [24, pp. 294]. \square

Furthermore, the techniques of the proof above also apply to the following.

Lemma 4.6. *Let I be a sequence of integers in $\{1, \dots, \ell\}$, and let $\omega_i \in F$ be a representative word of an i -th loop-longitude. Let $w_1, w_2 \in F$. Then*

$$\mu_C(I; w_1 \omega_i w_2) \equiv \mu_C(I; \omega_i) + \mu_C(I; w_1 w_2) \pmod{\Delta_C(Ii)}.$$

Proof. The Magnus expansion being a group morphism, we have that

$$E(w_1 \omega_i w_2) = E(w_1 w_2) + \left(1 + (E(w_1) - 1)\right) (E(\omega_i) - 1) \left(1 + (E(w_2) - 1)\right).$$

Using (ii) and (i) of Claim 4.5, this implies that $E(w_1 \omega_i w_2) - E(\omega_i) - E(w_1 w_2) + 1$ is in D_i , which gives the conclusion. \square

As a first application to this lemma, we have the following, which shall be of importance in the next subsection.

Lemma 4.7. *For any sequence I of integers in $\{1, \dots, \ell\}$, we have that both $\gcd\{\Delta_C(Ii), m_C(Ii)\}$ and the indeterminacy $\Delta_C(Ii)$ are independent of the choices of systems of loop-longitudes $\mathcal{L}_i(\Sigma)$ and of representative words ω_{ij} .*

Proof. If for some i, j , we denote by ω'_{ij} another choice of representative word for the element of $\mathcal{L}_i(\Sigma)$ represented by ω_{ij} , then by Proposition 4.3 we have $\mu_C(I; \omega'_{ij}) \equiv \mu_C(I; \omega_{ij}) \pmod{\Delta_C(Ii)}$. This shows that

$$\gcd\{\Delta_C(Ii), m_C(Ii)\} = \gcd\left\{\Delta_C(Ii), \mu_C(I; \omega'_{ij}) \mid \begin{array}{l} \omega'_{ij} \text{ any representative} \\ \text{for the elements of } \mathcal{L}_i(\Sigma) \end{array}\right\}.$$

Then, by definition of a loop-system, any i -th loop-longitude decomposes as a product of elements of $\mathcal{L}_i(\Sigma)$. By Lemma 4.6, we therefore have

$$\gcd\{\Delta_C(Ii), m_C(Ii)\} = \gcd\left\{\Delta_C(Ii), \mu_C(I; \omega_i) \mid \begin{array}{l} \omega_i \text{ any representative} \\ \text{of any } i\text{-th loop-longitude} \end{array}\right\},$$

and the result follows for $\gcd\{\Delta_C(Ii), m_C(Ii)\}$. The statement about $\Delta_C(Ii)$ is obtained by induction on the length of I , since $\Delta_C(Ii)$ is the greatest common divisor of all $m_C(J)$ and

$\Delta_C(J)$, when J runs over all sequences obtained from Ii by deleting one index and applying possibly a cyclic permutation. \square

At this point, each generic path, and in particular each longitude of a cut-diagram, yields Milnor numbers. We now need to analyse how these numbers provide actual invariants of the cut-diagrams. On one hand, the initial choice of i -th meridians R_i must be discussed. On the other hand, comparing longitudes for two different cut-diagrams is in general not possible, as there is no natural identification between the elements of the fundamental groups of the underlying manifolds, and we must further refine the construction to get intrinsic invariants of our cut-diagram. As a matter of fact, the situation is quite different, depending on whether we start with loop-longitudes or arc-longitudes. The main point is that loop-longitudes are based at our chosen basepoint p_i in R_i , so that invariance of the associated Milnor numbers must address the question of basepoint change, while arc-longitudes come with a natural choice of basepoint. We will hence discuss these two cases separately, in the next two subsections.

4.2. Milnor invariants for loop-longitudes. We first focus on the case where γ is (an element of $\pi_1(\Sigma_i; p_i)$ representing) an i -th loop-longitude.

As mentioned above, we need to analyse the effect of replacing a basepoint by a conjugate. Such a basepoint change, say on the j -th component, transforms a nilpotent peripheral system into an equivalent one; the j -th meridian and loop-longitudes are then accordingly conjugated, as in Definition 2.14.

By Lemma 4.6, the residue class $\bar{\mu}_C(I; \gamma)$ remains unchanged when replacing γ by a conjugate. Actually, Lemma 4.6 implies that, for fixed i -th meridians R_i , Milnor numbers for loop-longitudes only depend on their homology class. Hence we can set the following.

Notation 4.8. For $\lambda \in H_1(\Sigma_i)$ and any sequence I of integers in $\{1, \dots, \ell\}$, we set $\bar{\mu}_C(I; \lambda) := \bar{\mu}_C(I; \gamma)$, where γ is a generic loop representing λ .

In fact, the following will be proved at the end of this subsection.

Proposition 4.9. *Let I be any sequence of integers in $\{1, \dots, \ell\}$, and let $\lambda \in H_1(\Sigma_i)$. Then $\Delta_C(I)$ and $\bar{\mu}_C(I; \lambda)$ do not depend on the choice of meridians $\{R_i\}$, nor on the choice of the representing loop γ .*

This leads to the following.

Definition 4.10. For any sequence Ii of integers in $\{1, \dots, \ell\}$, we define the *Milnor map*

$$M_C^{Ii} : H_1(\Sigma_i) \rightarrow \mathbb{Z}/\Delta(Ii)\mathbb{Z},$$

by sending any $\lambda \in H_1(\Sigma_i)$ to the residue class $\bar{\mu}_C(I; \lambda)$.

Note that the Milnor map M_C^{Ii} is a group homomorphism by Lemma 4.6.

Remark 4.11. In the familiar case of classical links, $H_1(\Sigma_i) \cong \mathbb{Z}$ is generated by a preferred i -th longitude, for each i , and we recover Milnor's link invariants as the image of the corresponding Milnor maps; see Section 4.6.

Assuming Proposition 4.9, we obtain the following.

Theorem 4.12. *The Milnor maps are well-defined homomorphisms.*

Note that Milnor maps M_C^{Ii} are *not* invariants of the equivalence class of the cut-diagram C , in the sense of Definition 1.8. However, we can define numerical invariants of the cut-diagram C from loop-longitudes, which essentially record the images of Milnor map.

Definition 4.13. For any sequence I of integers in $\{1, \dots, \ell\}$, we set

$$v_C(Ii) := \gcd \{ \Delta_C(Ii), m_C(Ii) \}$$

and call it *Milnor loop-invariant* of C associated with the sequence I and the i -th component.

Here we use the usual convention that $\gcd(0, 0) = 0$. By Lemma 4.7, and still assuming Proposition 4.9, we have the following.

Theorem 4.14. *The Milnor loop-invariants are well-defined invariants of cut-diagrams.*

We stress that here, and in what follows, the term *invariant* is to be understood relatively to the natural equivalence relation on cut-diagrams given in Definition 1.8.

Remark 4.15. As in the classical settings, Milnor invariants are ordered by their *length*, which is the number of indices in the indexing sequence. For a cut-diagram C , suppose that there is a largest $k > 0$ such that $m_C(J) = 0$ for any sequence J of less than k indices (we set $m_C(i) = 0$ for any i , as a convention). Then for any sequence I of length $k + 1$ we have $\Delta_C(I) = 0$, and the *first non-vanishing* Milnor (loop-)invariants of C are the nontrivial invariants $v_C(I)$, which are simply given by $v_C(I) = m_C(I) \in \mathbb{Z}$.

It thus remains to prove Proposition 4.9, which is done in the rest of this subsection.

Starting with our cut-diagram C with basepoints $\{p_i\}$ materializing the i -th meridians $\{R_i\}$, we pick a new set of basepoints $\{p'_i\}$. This induces a new set of i -th meridians $\{R'_i\}$, which provides a new presentation of the form (4.1) for $N_q G(C)$ by Theorem 3.15. In order to prove Proposition 4.9, we need to understand how a given word in the alphabet $\{R_i^{\pm 1}\}$, representing some element of $N_q G(C)$, translates into a word in this new alphabet $\{R'_i{}^{\pm 1}\}$. This is the purpose of the coming key lemma, Lemma 4.17, where the Chen homomorphisms turn out to provide the desired dictionary between the two presentations of $N_q G(C)$. In order to state this key lemma, we need to introduce some further notation.

Notation 4.16. Given an element x in the free group generated by a set $\{e_1, \dots, e_\ell\}$, we will use the notation $x_{[e_i \mapsto f_i]} \in G$ for the element in a group G obtained by substituting each e_i by $f_i \in G$.

Now, let α be a road network for C based at $\{p_i\}$, and let α' be another choice of road network, based at $\{p'_i\}$. Consider in α' the road a_i running from p'_i to the basepoint p_i of α , and set $v_i := \tilde{w}_{a_i}$, the associated (unnormalized) word. The maps η_q^α take values in the free group $F = \langle R_i \rangle$, while the maps $\eta_q^{\alpha'}$ take values in the free group $F' = \langle R'_i \rangle$, and both can be seen as taking values in the free group $\bar{F} = \langle R_{ij} \rangle$.

Recall that W is the normal subgroup of \bar{F} generated by all Wirtinger relations, see Notation 2.2. Then for any $w \in \bar{F}$, one can see $\eta_q^\alpha(w)$ as an element of $F/F_q \cdot \eta_q^\alpha(W)$, while $\eta_q^{\alpha'}(w)$ is seen as an element of $F'/F'_q \cdot \eta_q^{\alpha'}(W)$.

Lemma 4.17. *In the above notation, for any $w \in \langle R_{ij} \rangle$, we have*

$$\eta_q^{\alpha'}(w) = \eta_q^\alpha(w)_{[R_i \mapsto R'_i \eta_q^{\alpha'}(v_i)]} \text{ in } F'/F'_q \cdot \eta_q^{\alpha'}(W).$$

Remark 4.18. This lemma indeed provides the desired dictionary between our two presentations, as follows. Let w be a word of $\{R_{ij}\}$, representing some given element in $N_q G(C)$, and which happens to only involve the letters $R_i^{\pm 1}$ —any element of F can be seen as sitting in $\langle R_{ij} \rangle$ in this way. Then we have by definition of the Chen homomorphisms that $w = \eta_q^\alpha(w)$. But we also have that $\eta_q^{\alpha'}(w)$ is a representative word of $\{R'_i\}$. Lemma 4.17 tells us that this representative is obtained by replacing each R_i by $R'_i \eta_q^{\alpha'}(v_i)$ in the word w .

Proof of Lemma 4.17. By definition of the homomorphism η_q^α , and regarding $\eta_q^{\alpha'}(w)$ as an element of \bar{F} , we have

$$\eta_q^{\alpha'}(w) \equiv w_{[R_{ij} \mapsto \eta_q^{\alpha'}(R_{ij})]} \pmod{\bar{F}_q \cdot W}.$$

Now, a direct consequence of Lemma 3.8 is that, for any i, j , we have

$$\eta_q^{\alpha'}(\eta_q^\alpha(R_{ij})) \equiv \eta_q^{\alpha'}(R_{ij}) \equiv R_{ij} \pmod{\bar{F}_q \cdot W}.$$

There is hence some element $g \in \bar{F}_q \cdot W$ such that

$$w_{[R_{ij} \mapsto \eta_q^{\alpha'}(R_{ij})]} = w_{[R_{ij} \mapsto \eta_q^{\alpha'}(\eta_q^\alpha(R_{ij}))]} g,$$

and applying $\eta_q^{\alpha'}$ to this equality gives, according to Remark 3.3:

$$w_{[R_{ij} \mapsto \eta_q^{\alpha'}(R_{ij})]} = w_{[R_{ij} \mapsto \eta_q^{\alpha'}(\eta_q^\alpha(R_{ij}))]} \eta_q^{\alpha'}(g).$$

This shows that the word $\eta_q^{\alpha'}(w) = w_{[R_{ij} \mapsto \eta_q^{\alpha'}(R_{ij})]}$ in $F'/F'_q \cdot \eta_q^{\alpha'}(W)$ is obtained from $\eta_q^\alpha(w) = w_{[R_{ij} \mapsto \eta_q^\alpha(R_{ij})]}$ in $F/F_q \cdot \eta_q^\alpha(W)$ by substituting each $R_i \in F$ by $\eta_q^{\alpha'}(R_i)$. Now, by the inductive definition of $\eta_q^{\alpha'}$, we have that $\eta_q^{\alpha'}(R_i) = R_i^{\eta_q^{\alpha'}(v_i)}$, and Lemma 3.7 tells us that $\eta_{q-1}^{\alpha'}(v_i) \equiv \eta_q^{\alpha'}(v_i) \pmod{F'_{q-1}}$. The conclusion then follows from Claim 3.6. \square

We can finally prove Proposition 4.9.

Proof of Proposition 4.9. The proof is by induction on the length of I , the initial case being trivial, and the statement on the indeterminacy $\Delta_C(I)$ being an immediate consequence of the induction hypothesis.

Proving the statement on $\bar{\mu}_C(I; \lambda)$ involves again the ideal D_i introduced in the proof of Proposition 4.3. Pick two i -th loop-longitudes γ and γ' , respectively based at p_i and p'_i and both representing $\lambda \in H_1(\Sigma_i)$. Starting with a representative word $\omega \in F$ for γ , Lemma 4.17 tells us that a representative word ω' for γ' is obtained from a conjugate of ω by replacing each R_j by a conjugate of itself. It then follows from Claim 4.5 (ii) and (iii), in a strictly similar way as with [24, (12) and (13)] in the link case, that $E(\omega) - E(\omega')$ falls in D_i , hence the result. \square

A key technical point of the above proof is Claim 4.5 (ii) and (iii), which is only valid for loop-longitude; this is closely related to the fact that the indeterminacies $\Delta(I)$ are defined in terms of loop-longitude only. This technical point explains that Proposition 4.9 is only valid for Milnor invariants extracted from loop-longitude. As a matter of fact, this independence under the choice of meridians does *not* hold when dealing with arc-longitudes, as we shall now explain.

Remark 4.19. For a given nilpotent peripheral system $(N_q G(C); \{R_i\}, \{\lambda_i\})$, each loop $\gamma \in \Sigma_i$ provides an element $\lambda_i(\gamma) \in N_q G(C)$, which is represented by a word of R_1, \dots, R_ℓ . Taking the Magnus expansion, the resulting Milnor numbers $\bar{\mu}_C(I; \gamma) \equiv \mu_C(I; \lambda_i(\gamma)) \pmod{\Delta_C(I)}$, are well-defined by Proposition 4.9. Hence Milnor maps and Milnor loop-invariants, are determined by the nilpotent peripheral system for C .

Now consider two cut-diagrams C and C' having equivalent nilpotent peripheral systems $(N_q G(C); \{R_i\}, \{\lambda_i\})$ and $(N_q G(C'); \{R'_i\}, \{\lambda'_i\})$. As in Definition 2.14, let ρ be a bijection from $\pi_1(\Sigma_i, p_i) \sqcup \mathcal{A}(\Sigma_i, \{p_{ij}\}_j)$ to itself, φ an isomorphism from $N_q G(C)$ to $N_q G(C')$, and w_1, \dots, w_ℓ elements in $N_q G(C')$. For a loop γ , seen as an element of $\pi_1(\Sigma_i, p_i)$, we have

$$\lambda'_i(\gamma) = \varphi(\lambda_i(\rho(\gamma)))^{w_i} = \left(\lambda_i(\rho(\gamma))_{[R_i \mapsto (R'_i)^{w_i^{-1}}]} \right)^{w_i}.$$

As in the proof of Proposition 4.9, it follows from Claim 4.5 (ii) and (iii) that, for any sequence I in $\{1, \dots, \ell\}$, we have $\Delta_{C'}(I) = \Delta_C(I)$ and $\bar{\mu}_{C'}(I, \gamma) \equiv \bar{\mu}_C(I, \rho(\gamma)) \pmod{\Delta_{C'}(I)}$. Hence $v_{C'}(Ii) = v_C(Ii)$ for each i , and Milnor loop invariants are well-defined invariants for nilpotent peripheral systems up to equivalence. The case of Milnor maps is slightly different: indeed, since $M_{C'}^i(\gamma) = M_C^i(\rho(\gamma))$, Proposition 4.9 gives us that $M_{C'}^i = M_C^i \circ \rho^*$, where ρ^* is the automorphism of $H_1(\Sigma_i)$ induced by $\rho|_{\pi_1(\Sigma_i, p_i)}$.

4.3. Milnor invariants from arc-longitudes. We thus now focus on the case where γ is an i -th arc-longitude. Dealing with an i -th arc-longitude obviously assumes that Σ_i is not closed. It is hence rather natural to assume, at a first stage, that *each* component of Σ has nonempty boundary. Note that this is in particular the case for string links[13] and concordances in 4-space [22], which we aim at generalizing here, see Section 4.6. The general case, where Σ is allowed to contain closed components, shall be shortly addressed in Remark 4.21.

Recall that we chose basepoints $\{p_{ij}\}$ on each boundary component, among which the point p_{i0} indicates a marked boundary component of Σ_i . This piece of data comes with the cut-diagram C , and is fixed, once and for all. This provides a *canonical* choice of i -th meridian, materialized by the basepoint p_{i0} , and hence well-defined Milnor numbers associated to each arc-longitude. In other words, as a corollary of Proposition 4.3, we obtain the following.

Theorem 4.20. *If Σ has no closed component, Milnor numbers associated to arc-longitudes are well-defined invariants of cut-diagrams over Σ .*

Remark 4.21. In the general case, where some component Σ_j of Σ may have empty boundary, the above result remains true, provided that we *fix* a choice of j -th meridian for Σ_j . Hence, in general, Milnor numbers associated to arc-longitudes are well-defined invariants of cut-diagrams, enhanced with a basepoint on each closed connected component of Σ (in addition to the already fixed boundary basepoints).

In general, there are however several, possibly infinitely many, different arc-longitudes running from p_{i0} to some other boundary basepoint p_{ij} . But using the action of loop-longitudes noted in Remark 2.13, all arc-longitudes can be recovered from a single one. More precisely, for any two arcs γ, γ' running from p_{i0} to p_{ij} , there exists by Remark 2.13 some $\tau \in \pi_1(\Sigma_i, p_{i0})$ such that $\gamma' = \tau \cdot \gamma$.⁷ By Lemma 4.6, we then have for any sequence I of integers in $\{1, \dots, \ell\}$,

$$\mu_C(I; \gamma') \equiv \mu_C(I; \gamma) + \mu_C(I; \tau) \pmod{\Delta_C(Ii)}.$$

Since τ decomposes as a product of elements in a system of longitudes (and their inverses), we therefore observe that

$$\mu_C(I; \gamma') \equiv \mu_C(I; \gamma) \pmod{v_C(Ii)},$$

where $v_C(Ii) = \gcd\{\Delta_C(Ii), m_C(Ii)\}$ was introduced in Definition 4.13.

We can thus define intrinsic Milnor invariants from arc-longitudes, as follows.

Definition 4.22. For any sequence I of integers in $\{1, \dots, \ell\}$, we set

$$v_C^\partial(I; ij) := \mu_C(I; \gamma_{ij}) \pmod{v_C(Ii)},$$

where γ_{ij} is any path from p_{i0} to p_{ij} . We call it *Milnor arc-invariant* of C associated with the sequence I and the j -th boundary component of Σ_i .

Remark 4.23. As in Remark 4.19, we have that Milnor arc-invariants are well-defined invariants for nilpotent peripheral systems up to equivalence, since our notion of equivalence fixes the boundary, see Definition 2.14.

⁷Observe that, since Σ_i has nonempty boundary, we picked here $p_i = p_{i0}$ as canonical basepoint for Σ_i , for defining this action.

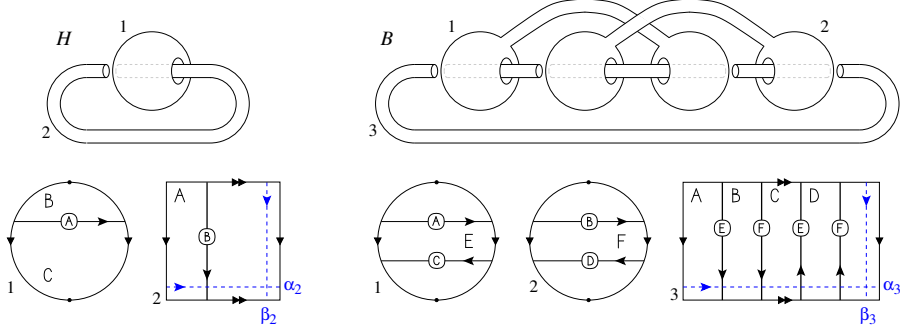

FIGURE 8. Diagrams for the surface-links H and B , and associated cut-diagrams C_H and C_B

4.4. Milnor invariants of codimension 2 embeddings.

Definition 4.24. We call *Milnor invariants* of a cut-diagram C the collection of invariants defined in Sections 4.2 and 4.3, namely Milnor loop-invariants $\nu_C(Ii)$ and Milnor arc-invariants $\nu_C^\partial(I; ij)$, for all indices i, j and all sequences of indices I .

As we will show in Section 5.1.2, when restricted to topological cut-diagrams, the various versions of Milnor invariants defined above provide genuine topological invariants of codimension 2 embeddings. This allows for the following definition.

Definition 4.25. For any codimension 2 embedding S we define Milnor maps and (generalized) Milnor invariants—which are, for any sequence I of indices in $\{1, \dots, \ell\}$, Milnor loop-invariants $\nu_S(Ii)$, and Milnor arc-invariants $\nu_S^\partial(I; ij)$ —as the corresponding invariants for any cut-diagram associated to S .

More precisely, as an immediate consequence of Corollaries 5.3 and 5.6, shown in Section 5.1.2, we will obtain the following invariance result.

Theorem 4.26. *Milnor invariants are well-defined concordance invariants for codimension 2 embeddings.*

4.5. First examples. We now give a couple of basic computational examples for our invariants. More examples can be found in Section 6, where a number of applications are also provided.

We first consider Milnor loop-invariants. Consider the 2-component surface-link H shown on the left-hand side of Figure 8; a topological cut-diagram for H is provided in the figure. Since the first component is a sphere, we have $\nu_H(I1) = 0$ for any sequence I . On the other hand, it is easily verified that $\nu_H(12) = 1$. Indeed, a system of loop-longitudes for the second component is given by the loops (α_2, β_2) represented in dashed lines in the figure. Since β_2 avoids all cut arcs, we clearly have $\mu_{C_H}(I; \beta_2) = 0$ for all sequences I ; however we have $w_{\alpha_2} = A \in G(C_H)$, where A is the chosen meridian for component 1, so that $\mu_{C_H}(1; \alpha_2) = 1$.

Remark 4.27. This number $\mu_{C_H}(1; \alpha_2) = 1$, is merely the usual *linking number* of the loop α_2 with the first component of H . In general, $\nu(ij)$ is likewise the gcd of the linking numbers of component i with all loops forming a system of loop-longitudes for component j .

Consider next the diagram of the 3-component surface-link B shown on the right-hand side of Figure 8, along with the associated cut-diagram C_B . A system of loop-longitudes for

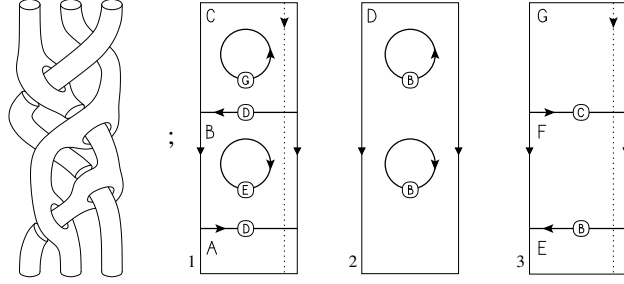
FIGURE 9. Diagram for the surface-link M and associated cut-diagram C_M

the third component is given by the loops (α_3, β_3) represented in dashed lines in the figure. As above, we have $\mu_{C_B}(I; \beta_3) = 0$ for all sequences I . On the other hand, using regions E and F of the first and second components as preferred meridians for these components, we directly have that $w_{\alpha_3} = EFE^{-1}F^{-1} \in G(C_B)$. Hence we have $\nu_B(I) = 0$ for any length 2 sequence I , and

$$\nu_B(123) = \nu_{C_B}(213) = 1 \quad \text{and} \quad \nu_B(I) = 0 \quad \text{for } I \in \{312, 132, 231, 321\}.$$

We now turn to Milnor arc-invariants. Consider the diagram of the 3–component surface-link M shown on the left-hand side of Figure 9, and the cut-diagram C_M for M shown on the right-hand side. For each component of C_M , we choose the preferred boundary component to be the bottom one, so that preferred meridians are given by regions A , D and E for the three components.

It is easily seen that $\nu_M(I) = 0$ for any sequence I , since each component admits a system of longitude given by a single loop running parallel to the lower boundary component; Milnor arc-invariants of B are thus well-defined integers, given as follows. A choice of arc-longitude is specified by an arc running from top to bottom on each component. Such a choice γ_i ($i = 1, 2, 3$) is represented with dashed lines in the figure. We clearly have $w_{\gamma_1} = DD^{-1} = 1$ and $w_{\gamma_2} = 1$ in $G(C_M)$. Moreover, we have $w_{\gamma_3} = B^{-1}C = DA^{-1}D^{-1}A$ in $G(C_M)$. As a result, we obtain that

$$\mu_{C_M}(12; \gamma_3) = -\mu_{C_M}(21; \gamma_3) = 1 \quad \text{and} \quad \mu_{C_M}(I; \gamma_i) = 0 \quad \text{for } i = 1, 2 \quad \text{and any sequence } I.$$

We shall provide in Section 6 a number of applications and further computational examples involving the various invariants defined so far.

We stress that, at this point, the above computations are only for the given cut-diagrams representing the surface-links B and M . As mentioned in the introduction, these are in fact topological invariants of the represented surface-links, *i.e.* do not depend on the chosen cut-diagram: this will be formally stated in Theorem 4.26.

4.6. Relation to previous works. Our construction recovers and generalizes many of the previously known versions of Milnor invariants, as follows.

4.6.1. The classical dimension. In the case of 1–dimensional cut-diagrams, the situation is quite special since Σ_i always comes with a single preferred longitude l_i . Our Milnor invariants then boil down to a unique numerical invariant associated to each sequence I , which correspond to the classical Milnor invariants.

For links, l_i is a loop-longitude. As discussed in Remark 4.11, we have for any cut-diagram C_L representing a link L , and any sequence I :

$$\bar{\mu}_L(Ii) = M_{C_L}^{Ii}(l_i) \text{ in } \mathbb{Z}/\Delta_{C_L}(Ii)\mathbb{Z},$$

where $\bar{\mu}_L(Ii)$ is the classical Milnor invariant defined in [23, 24]. Note also that, on the other hand, we have $m_{C_L}(I) = |\mu_L(I)|$ and $\Delta_{C_L}(I) = \Delta_L(I)$, so that

$$m_{C_L}(I) \equiv |\mu_L(I)| \pmod{\Delta_L(I)}.$$

For string-links, l_i is an arc-longitude and we recover Habegger–Lin’s Milnor invariants for string-links [13]. More precisely, for any cut-diagram C_L representing a string link L , since each component is homologically trivial we have $v_{C_L}(Ii) = 0$ for any sequence I , and

$$\mu_L(Ii) = v_{C_L}^0(I; i1) \in \mathbb{Z}.$$

As we shall explain in Section 7.1, the more general case of 1–dimensional cut-diagrams relates to the theory of welded objects. Then, the case where Σ is a union of ℓ circles recovers the welded extension of Milnor’s link invariant of [9, 25], while the case of ℓ intervals recovers Milnor invariants of welded string links defined in [2], see also [19].

4.6.2. Milnor invariants of concordances. In the case of 2–dimensional cut-diagrams over ℓ annuli, Milnor arc-invariants of Definition 4.22 are precisely Milnor invariants for concordances, i.e. for embedded annuli cobounded by two links, as defined in [22, 3]. Note that in this setting, loop-longitudes are given by parallel copies of the boundary components, so that, in the general case where the latter form a nontrivial link, both $\Delta_C(I)$ and $v_C(I)$ involve Milnor invariants of the link at the boundary; see [22] for a complete description (note that in [22], the indeterminacy $v_C(Ii)$ of Definition 4.22 is denoted by $\Delta(Ii)$).

Remark 4.28. A key ingredient in [22, 3] for defining Milnor invariants of concordances, i.e. knotted annuli in 4–space, is a result of Stallings [35, Thm. 5.1] that provides the Chen–Milnor presentation for the nilpotent quotients of the fundamental group of the complement. This was already the case when defining Milnor invariants of string links [13]. In this paper, rather than using similar techniques for general surface-links, we made use of the notion of cut-diagram to derive Theorem 3.15. Indeed, this combinatorial method not only provides the desired presentation, but also an algorithm for expressing longitudes as words in the meridians. In other words, this approach also gives an algorithm for computing higher dimensional Milnor invariants. As a matter of fact, rather than using Stallings theorem as an external tool, we instead give, as a byproduct, a combinatorial proof for this result in our generalized setting, see Corollary 5.7.

4.6.3. Orr invariants. Orr introduced in [26, 27] (based) concordance invariants θ_q^l for (based) codimension 2 embeddings. The construction can be roughly summarized as follows.

Let L be an embedding of an ℓ –component n –manifold Σ into S^{n+2} , and let $G(L)$ be the fundamental group of its complement. Suppose that the nilpotent quotients satisfy $G(L)/G(L)_q \cong F/F_q$, where F is the free group of rank ℓ (see below regarding this assumption). The natural homomorphisms

$$F \longrightarrow F/F_q \text{ and } G(L) \longrightarrow G(L)/G(L)_q \cong F/F_q,$$

induce continuous maps

$$f_q^\ell : K(F, 1) \longrightarrow K\left(F/F_q, 1\right) \text{ and } \phi_q^\ell : S^{n+2} \setminus L \longrightarrow K\left(F/F_q, 1\right)$$

respectively, where $K(G, 1)$ denotes an Eilenberg–MacLane space for a group G . The map ϕ_q^ℓ extends to a map $\bar{\phi}_q^\ell$ from S^{n+2} to the mapping cone $\text{Cone}(f_q^\ell)$ of the map f_q^ℓ . The fundamental

class $\theta_q^\ell \in \pi_{n+2}(\text{Cone}(f_q))$ of $\overline{\phi}_q^\ell$ is an invariant of L for each $q \geq 1$, and Orr shows that these θ_q^ℓ actually are (based) concordance invariants.

As noted above, the definition of Orr's invariants requires that $G(L)/G(L)_q \cong F/F_q$. Observe that this condition is fulfilled if $H_1(\Sigma) = 0$, which is the (stronger) assumption taken in [26] for the definition. We note that $G(L)/G(L)_q \cong F/F_q$ if and only if all Milnor loop-invariants of L (in the sense of the present paper) with length $< q$ vanish. Hence Orr invariants actually are invariants for codimension 2 embeddings with vanishing higher-dimensional Milnor invariants.

Moreover, as discussed in Remark 5.24, we expect that Orr's construction can be adapted to create new link-homotopy invariants of surface-links.

4.6.4. *k-slice links.* The notion of k -slice classical links was introduced independently by Orr [27] and Cochran [11], as follows.

An ℓ -component link $L = K_1 \cup \dots \cup K_\ell$ in the boundary ∂D^4 of the 4-ball D^4 is k -slice if there is a disjoint union $S = S_1 \cup \dots \cup S_\ell$ of properly embedded surfaces in D^4 with $\partial S_i = K_i$ ($i = 1, \dots, \ell$), such that if the composition of the homomorphism $\pi_1(S_i) \rightarrow \pi_1(D^4 \setminus S)$ induced by the inclusion from S_i to $D^4 \setminus S$ obtained by pushing S in the normal direction, and the natural projection $\pi_1(D^4 \setminus S) \rightarrow N_k \pi_1(D^4 \setminus S)$, is the trivial homomorphism for each k . Igusa and Orr [14] showed that a link is k -slice if and only if all its Milnor invariants of length $\leq 2k$ vanish, a result which is known as the *k-slice conjecture*.

Observe that for each i and all k , the composition

$$\pi_1(S_i) \rightarrow \pi_1(D^4 \setminus S) \rightarrow N_k \pi_1(D^4 \setminus S)$$

is trivial if and only if Milnor loop-invariant $v_S(Ii)$ vanish for any sequence I of length $\leq k-1$. Hence we have the following result, which relates Milnor invariants in dimensions 3 and 4.

Proposition 4.29. *A link has vanishing Milnor invariants of length $\leq 2k$ if and only if it bounds mutually disjoint, smoothly properly embedded once-punctured surfaces in the 4-ball having vanishing Milnor loop-invariants of length $\leq k$.*

5. CUT-CONCORDANCE AND REDUCED CUT-CONCORDANCE

For this section, we fix an n -dimensional manifold Σ .

5.1. **Cut-concordance.** We consider the situation where two cut-diagrams over Σ cobound a cut-diagram over $\Sigma \times [0, 1]$. This yields general notion of concordance for cut-diagrams.

5.1.1. *Definition and first properties.*

Definition 5.1. Two cut-diagrams C_0 and C_1 over Σ , are *cut-concordant* if there is a cut-diagram C over $\Sigma \times [0, 1]$ which intersects $\Sigma \times \{0\}$ and $\Sigma \times \{1\}$ as C_0 and C_1 , respectively. This means that, for $\varepsilon \in \{0, 1\}$:

- $C \cap (\Sigma \times \{\varepsilon\})$ and C_ε are equivalent cut-diagrams, where $C \cap (\Sigma \times \{\varepsilon\})$ is given the inward induced orientation if $\varepsilon = 0$ and the outward one if $\varepsilon = 1$;
- the following diagram commutes:

$$\begin{array}{ccc} \{\text{cut-domains of } C_\varepsilon\} & \xrightarrow{\text{labelling}} & \{\text{regions of } C_\varepsilon\}, \\ \downarrow \psi_\varepsilon^c & & \downarrow \psi_\varepsilon^r \\ \{\text{cut-domains of } C\} & \xrightarrow{\text{labelling}} & \{\text{regions of } C\} \end{array}$$

where ψ_ε^c (resp. ψ_ε^r) sends a cut-domain d_ε (resp. a region r_ε) of C_ε to the unique cut-domain d (resp. region r) of C such that $\psi_\varepsilon^c(d_\varepsilon) \subset d$ (resp. $\psi_\varepsilon^r(r_\varepsilon) \subset r$).

Moreover, if $\partial\Sigma \neq \emptyset$, we also require that $C \cap (\partial\Sigma \times [0, 1]) \cong (C_0 \cap \partial\Sigma) \times [0, 1]$. We also say that C is a *cut-concordance* between C_0 and C_1 .

Note that two equivalent cut-diagrams are cut-concordant.

Cut-concordance defines a natural equivalence relation on cut-diagrams, thus providing a coherent theory for studying these objects. Moreover, this notion generalizes the topological notion of concordance in the following sense.

Proposition 5.2. *Two topological cut-diagrams, associated to two concordant codimension 2 embeddings, are cut-concordant.*

Proof. Let C (resp. C') be a cut-diagram associated to a diagram D (resp. D'), which is the projection of a fixed embedding L (resp. L') in \mathbb{R}^{n+2} . If there exists a concordance from L to L' , then Roseman's theory of projection for codimension 2 embeddings [30, 31] ensures the existence of an equivalent concordance which projects to a diagram, such that the restriction to the boundary coincides with D and D' . The associated cut-diagram is the desired cut-concordance between C and C' . \square

In particular, since two equivalent codimension 2 embeddings are concordant, we have the following.

Corollary 5.3. *Two topological cut-diagrams associated to equivalent codimension 2 embeddings, are cut-concordant.*

Moreover, in any fixed dimension, two 1-component cut-diagrams are always cut-concordant. Indeed, we have the following.

Lemma 5.4. *Let Σ be an oriented n -dimensional manifold. Any 1-component cut-diagram over Σ is cut-concordant to the empty cut-diagram over Σ .*

Proof. Let C be a 1-component cut-diagram over Σ . Then $C \times [0, 1/2] \subset \Sigma \times [0, 1]$ simply defines a cut concordance from C to the trivial diagram, where $C \times \{1/2\} \subset \Sigma \times [0, 1]$ is a union of internal points. \square

Recall that, in dimension 3, Milnor invariants are not only invariant under ambient isotopy; they are also invariant under 'isotopy' in the sense of [23]. In particular, Milnor invariants are trivial for knots. We observe that, by Lemma 5.4, the same holds in any dimension.

5.1.2. *Concordance invariance results.* It is well-known that equivalent classes of nilpotent peripheral systems and Milnor invariants of link in S^3 are concordance invariants. This remains true for cut-diagrams. Indeed, we prove below the following.

Theorem 5.5. *Equivalence classes of nilpotent peripheral systems for cut-diagrams are invariant under cut-concordance.*

By Remarks 4.19 and 4.23, Milnor invariants indexed by sequences I of at most $q \geq 1$ indices only depend on the q -th nilpotent peripheral system. As a consequence, we obtain the following.

Corollary 5.6. *Milnor invariants are invariant under cut-concordance.*

As announced in Section 4.4, this allows for the definition of Milnor loop- and arc-invariants of codimension 2 embeddings, which are indeed well-defined concordance invariants.

Let us now prove the main invariance result.

Proof of Theorem 5.5. Let C be a cut-concordance between two cut-diagrams C_0 and C_1 over a manifold Σ . We fix $\varepsilon \in \{0, 1\}$ and $q \in \mathbb{N}$, and call ε -regions the regions of C intersecting $\Sigma \times \{\varepsilon\}$. Since nilpotent peripheral systems of equivalent cut-diagrams are equivalent, we may assume that $C \cap (\Sigma \times \{\varepsilon\}) = C_\varepsilon$.

Let's consider first the simpler case where each ε -region has a connected intersection with $\Sigma \times \{\varepsilon\}$. Then there is a one-to-one correspondence between the regions of C_ε and the ε -regions of C . Since C is a diagram on the product $\Sigma \times [0, 1]$, we can freely choose basepoints $\{p_i^\varepsilon\}_i$ and defining-cycles for the loop-longitudes of C on the boundary $\Sigma \times \{\varepsilon\}$; in particular, a system of loop-longitudes $\mathcal{L}_i(\Sigma \times [0, 1])$ can be associated with a collection of loops in $\Sigma \times \{\varepsilon\}$. Moreover, when choosing a road network α_ε for C , we can freely pick the roads to the ε -regions as living on $\Sigma \times \{\varepsilon\}$. With such choices, it is immediate that applying Theorem 3.15 to C and C_ε , will provide the exact same presentation for $N_qG(C)$ and $N_qG(C_\varepsilon)$.

Now, if there are ε -regions whose intersections with $\Sigma \times \{\varepsilon\}$ are non connected, then regions of C_ε and ε -regions of C are no longer in one-to-one correspondence. In that case, we duplicate generators, as explained in Remark 2.4, so that we get an injection ι of the meridians of C_ε into the meridians of C . Then for every region/meridian R of C_ε , the road to $\iota(R)$ can be chosen so that it stays within $\Sigma \times \{\varepsilon\}$. Moreover, when associating words to loop-longitudes and roads on $\Sigma \times \{\varepsilon\}$ as explained in Remark 2.9, we use ι to choose letters. This being done, the duplicated version of Theorem 3.15 given in Remark 3.18 provides, as above, the exact same presentation for $N_qG(C)$ and $N_qG(C_\varepsilon)$.

This shows that the nilpotent quotients $N_qG(C_0)$ and $N_qG(C_1)$ are isomorphic, being both isomorphic to $N_qG(C)$. More precisely, $N_qG(C_0)$ and $N_qG(C_1)$ can be given presentations which coincide with the presentations of $G(C)$ associated to the above road networks α_0 and α_1 , respectively. We can then use Lemma 4.17 to get an explicit isomorphism $\psi_{0 \rightarrow 1}$ between these two presentations. In particular, $\psi_{0 \rightarrow 1}$ sends the i -th meridian of C_0 to the conjugate of the i -th meridian of C_1 by $\eta_q^{\alpha_1}(v_i)$, where v_i is the word associated to the path γ_i of α_1 joining the i -th meridian of $C_1 \subset C$ to the i -th meridian of $C_0 \subset C$. Moreover, conjugation by γ_i provides a bijection between p_i^1 -based cycles in $\Sigma \times \{1\}$ and p_i^0 -based cycles in $\Sigma \times \{0\}$, up to homotopy. Hence, using Proposition 3.16, $\psi_{0 \rightarrow 1}$ hence induces a bijection between i -th longitudes of C_0 and those of C_1 , realized as the conjugation by $\eta_q^{\alpha_1}(v_i)$.

We thus proved that the nilpotent peripheral systems for C_0 and C_1 are equivalent. \square

As announced in Remark 4.28, a noteworthy consequence of the former half of this proof is a combinatorial Stallings Theorem, as follows.

Corollary 5.7. *Given a cut-concordance C between two cut-diagrams C_0 and C_1 , the inclusion maps ψ_0^r and ψ_1^r of Definition 5.1 induce isomorphisms for all $q \geq 1$:*

$$N_qG(C_0) \xrightarrow{\cong} N_qG(C) \xleftarrow{\cong} N_qG(C_1).$$

This provides a combinatorial proof of Stallings Theorem [35, Thm. 5.1] in the case of a topological concordance between two codimension 2 embeddings, and a generalization to cut-concordances.

5.2. Reduced cut-concordance. We now introduce the notion of reduced concordance for cut-diagrams, in connection with the topological notion of link-homotopy. In this subsection, we shall essentially revisit many of the previous notions and results in this extended context, focusing on the points that need to be adapted.

5.2.1. Reduced cut-diagrams and cut-concordance. Cut-diagrams were, for a large part, motivated by the study of codimension 2 embeddings and their Milnor *concordance* invariants. But Milnor's work was first introduced in the context of link-homotopy of links [23], and it is natural to extend the theory of cut-diagrams to this setting.

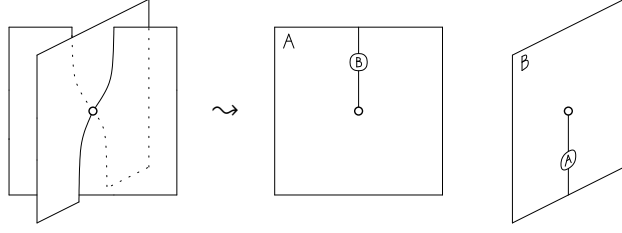

FIGURE 10. From singular surface-link diagrams to reduced cut-diagrams

Let us focus for a moment on the 2–dimensional case. Recall that a surface-link map is generically an immersion, with only a finite number of singularities which are transverse double points. Surface-link diagrams were generalized to this (self-)singular context in [3]; there, a singularity corresponds to the local model given on the left-hand side of Figure 10. The routine explained in Section 1.1, that associates a cut-diagram to a surface-link diagram, extends naturally to surface-link maps. However, as Figure 10 illustrates, any terminal cut arc of a cut-diagram associated to a surface-link map, is always labeled by a region that belongs to the same connected component. This leads to the following general definition, for Σ an n –dimensional oriented compact manifold, possibly with boundary.⁸

Definition 5.8. A *reduced cut-diagram* over Σ is the data C of a diagram on Σ , endowed with a labeling of all cut domains by regions, satisfying the first labeling condition of Definition 1.4 and the following modified second condition:

- 2') a terminal cut domain is labeled by a region which belong to its connected component.

Obviously, the labeling condition 2) of Definition 1.4 is a special case of condition 2') above, so that cut-diagrams are special cases of reduced cut-diagrams. Notice also that the notions of cut-diagram and reduced cut-diagram coincide in dimension 1.

We can now define a ‘reduced’ notion of concordance for cut-diagrams.

Definition 5.9. Two (reduced) cut-diagrams C_0 and C_1 over Σ , are *reduced cut-concordant* if there is a reduced cut-diagram C over $\Sigma \times [0, 1]$ which intersects, in the sense of Definition 5.1, $\Sigma \times \{0\}$ and $\Sigma \times \{1\}$ as C_0 and C_1 , respectively. We call C a *reduced cut-concordance* between C_0 and C_1 .

As emphasized above, the notion of reduced cut-concordance encompasses the notion of cut-concordance, but it is also closely related to the topological notion of ‘self-singular concordance’. Two links are called *self-singular concordant* if they cobound disjointly immersed annuli in 4–space. Considering a reduced cut-diagram representing such self-immersed annuli, as explained above, we easily have the following.

Proposition 5.10. *Two 1–dimensional (topological) cut-diagrams, representing self-singular concordant links, are reduced cut-concordant.*

5.2.2. Reduced peripheral system. Let C be a reduced cut-diagram over $\Sigma = \sqcup_{i=1}^{\ell} \Sigma_i$. Since the second labeling condition plays no role in its definition, a group $G(C)$ can be defined for C in the same way as in the regular case of Definition 2.1, using a Wirtinger presentation. However, in this reduced case, longitudes are no longer well-defined elements in $G(C)$.

⁸The terminology ‘reduced’ is motivated by the notion of reduced peripheral system and Theorem 5.17.

Consequently, we will consider the following quotient, first introduced by Milnor [23] in the study of links up to link-homotopy.

Definition 5.11. The *reduced quotient* $\text{RG}(C)$ of $G(C)$ is defined as the quotient of $G(C)$ by the normal subgroup generated by all relations $[R, R^g]$, for all meridians R and all element $g \in G(C)$.

Remark 5.12. The reduced quotient $\text{RG}(C)$ is equivalently defined as the quotient of $G(C)$ by the normal subgroup generated by commutators $[R_i, R_i^g]$ where $\{R_1, \dots, R_\ell\}$ is any given set of one meridian per component.

Lemma 5.13. *If γ and γ' are two homotopic generic paths in Σ_i , for some $i \in \{1, \dots, \ell\}$, then $w_\gamma = w_{\gamma'}$ in the quotient $\text{RG}(C)/N_{(i)}$ of $\text{RG}(C)$ by the normal subgroup $N_{(i)}$ generated by i -th meridians.*

Note that $N_{(i)}$ can equivalently be defined as the normal subgroup of $\text{RG}(C)$ generated by any i -th meridian.

Proof. The proof follows the exact same lines as the proof of Lemma 2.10. The only difference concerns move H_2 , for which the terminal cut domain may not be labeled by the region it is adjacent to, but by any conjugate of it. But we directly get $w_{\gamma'} = \widetilde{w}_{\gamma'} = \widetilde{w}_\gamma = w_\gamma$ in $\text{RG}(C)/N_{(i)}$. \square

For any $i \in \{1, \dots, \ell\}$, we have by Lemma 5.13 a well-defined map

$$\lambda_{i,R} : \pi_1(\Sigma_i, p_i) \sqcup \mathcal{A}(\Sigma_i, \{p_{ij}\}_j) \rightarrow \text{RG}(C)/N_{(i)}.$$

defined by composing the i -th longitude map λ_i with the projection map from $G(C)$ to $\text{RG}(C)/N_{(i)}$. Elements in the image of $\lambda_{i,R}$ are called *reduced i -th longitudes*. Note that these are cosets of the form $\lambda.N_{(i)}$, where λ is a word representing an i -th longitude.

Definition 5.14. The data $(\text{RG}(C); \{R_i\}, \{\lambda_{i,R}\})$ is called a *reduced peripheral system* of C . Definition 2.14 naturally induces a notion of equivalence for reduced peripheral systems.

Now, for each component Σ_i of Σ , let R_i be a choice of meridian, specified by a basepoint $p_i \in \Sigma_i \setminus C$. As noted in Remark 2.8, $G(C)$ is normally generated by these meridians. It follows, by a result of Habegger and Lin [13, Lem. 1.3], that its reduced quotient is nilpotent of degree at most ℓ , so that $\text{RG}(C) \cong N_q \text{RG}(C)$ for any integer $q \geq \ell$.

As in Section 3.3, pick for each component Σ_i of Σ , a system of loop-longitudes $\mathcal{L}_i(\Sigma) = \{w_{ij}\}$ in $G(C)$, and recall that $F := \langle R_i \rangle$ and $\bar{F} := \langle R_{ij} \rangle$. We have the following Chen–Milnor type presentation for $\text{RG}(C)$, similar to Theorem 3.15.

Theorem 5.15. *For every $q \geq \ell$, the reduced quotient of $G(C)$ has the following presentation:*

$$\text{RG}(C) \cong \left\langle R_1, \dots, R_\ell \left| \begin{array}{l} [R_i, R_i^g] \text{ for all } i, \text{ and all } g \in F \\ [R_i, \eta_q(w_{ij})] \text{ for all } i \text{ and all } w_{ij} \in \mathcal{L}_i(\Sigma) \end{array} \right. \right\rangle.$$

Proof. This presentation for $\text{RG}(C)$ is obtained in a completely similar way as Theorem 3.15 is shown from Proposition 3.12. Hence we just sketch the argument below, stressing only the new ingredients. It is indeed easily checked that the Chen homomorphisms η_q descend to well-defined homomorphisms $R\bar{F} \rightarrow RF$. The arguments proving Lemma 3.11 and Proposition 3.12 then apply verbatim to show that, for any $q \geq 1$, the q -th nilpotent quotient of $\text{RG}(C)$ has the following presentation:

(5.1)

$$N_q \text{RG}(C) \cong \left\langle R_1, \dots, R_\ell \left| \begin{array}{l} F_q \\ [R_i, R_i^g] \text{ for all } i \text{ and all } g \in F \\ [R_i, \eta_q(w_\gamma)] \text{ for all } i \text{ and all } p_i\text{-based generic loop } \gamma \text{ on } \Sigma_i \end{array} \right. \right\rangle.$$

From this point, we can use an induction on q to rework the presentation so that the third type of relations are substituted by commutation relations of the form $[R_i, \eta_q(w_{ij})]$, as in the proof of Theorem 3.15. The only new ingredient here is that move H_2 may now involve a terminal cut domain which is not labeled by the region supporting the move, but by any region in the same connected component. Suppose hence that two arcs γ and γ' on Σ_i differ by such a move H_2 , with γ corresponding to the left-hand side of the move. By the labeling condition 2'), the cut domain involved in this move is labeled by some region A of Σ_i . We then have

$$w_\gamma = B^s \tilde{w}_{\gamma_1} \tilde{w}_{\gamma_2} \quad \text{and} \quad w_{\gamma'} = B^{s-\varepsilon} \tilde{w}_{\gamma_1} A^\varepsilon \tilde{w}_{\gamma_2},$$

where γ_1, γ_2 are paths such that $\gamma = \gamma_1 \cdot \gamma_2$, $s \in \mathbb{Z}$, $\varepsilon = \pm 1$, and B is the region of Σ_i where γ_1 starts. Denoting by v_R , for any region R , the word associated to the road, in the road network α , running to the region R , we have, by the definition of the Chen homomorphisms, that

$$(5.2) \quad \eta_{q+1}(w_{\gamma'}) = (R_i^{-\varepsilon})^{\eta_q(v_B)} (R_i^\varepsilon)^{\eta_q(v_A) \eta_{q+1}(\tilde{w}_{\gamma_1}^{-1} B^{-s})} \eta_{q+1}(\tilde{w}_\gamma).$$

Since $\eta_{q+1}(w_{\gamma'})$ and $\eta_{q+1}(w_\gamma)$ differ by a product of conjugates of R_i , we have that $[R_i, \eta_{q+1}(w_{\gamma'})]$ and $[R_i, \eta_{q+1}(w_\gamma)]$ are equivalent, modulo the normal closure of the relations $[R_i, R_i^g]$ for all i and all $g \in F$.

Now, by Habegger–Lin's result recalled above, we have that $RG(C)$ is a nilpotent group of order at most ℓ . Picking any $q \geq \ell$, it follows that (5.1) provides a presentation for $RG(C) \cong N_q RG(C)$, and also that the relations involving q -th iterated commutators are trivially satisfied. Removing the latter, we obtain hence the presentation of the statement. \square

A consequence of this proof, and more specifically of Equation (5.2) and Proposition 3.16, is the following.

Proposition 5.16. *Let C be a reduced cut-diagram over Σ . For any two homotopic arcs γ, γ' on Σ_i , there exists a product N of conjugates of R_i such that*

$$\eta_q(w_\gamma) \equiv N \eta_q(w_{\gamma'}) \pmod{F_q \cdot V_{(q)}}.$$

The duplication process for the group of a cut-diagram, introduced in Remark 2.4, more generally applies for reduced cut-diagrams. Then, replacing Theorem 3.15 with Theorem 5.15, Proposition 3.16 with Proposition 5.16, and using this duplication process, the same lines of proof as for Theorem 5.5 lead to the following invariance result.

Theorem 5.17. *Equivalence classes of reduced peripheral systems for reduced cut-diagrams are reduced cut-concordance invariants.*

Moreover, just like Corollary 5.7 follows as an immediate byproduct of the proof of Theorem 5.5, we obtain in this way the following reduced version of the combinatorial Stallings theorem.

Corollary 5.18. *Given a reduced cut-concordance C between two cut-diagrams C_0 and C_1 , the boundary inclusion maps (in the sense of Definition 5.1) induce isomorphisms:*

$$RG(C_0) \xrightarrow{\cong} RG(C) \xleftarrow{\cong} RG(C_1).$$

5.2.3. Non-repeated Milnor invariants. Milnor invariants first appeared in [23] as a tool for studying links up to link-homotopy. As a matter of fact, at first, Milnor only considered invariants indexed by a sequence of pairwise distinct indices, and proved that they are indeed invariant under link-homotopy. Actually, they are more generally invariant under self-singular concordance. We now investigate a similar phenomenon in the setting of cut-diagrams.

Definition 5.19. We say that a Milnor number $\bar{\mu}_C(I; \gamma)$ for a cut-diagram C , a sequence I of indices, and a path γ on the i -th component of Σ , is *non-repeated* if all the indices in I are pairwise distinct.

Accordingly, as in Definition 4.24, we shall call *non-repeated Milnor invariants* of a cut-diagram C , all Milnor loop-invariants $\nu_C(Ii)$ and Milnor arc-invariants $\nu_C^\theta(I; i, j)$, for indices i, j and sequences I such that all indices in I are pairwise distinct.

We have the following, which underlies a ‘reduced’ version of Proposition 4.3.

Proposition 5.20. *Let C be a cut-diagram over $\Sigma = \sqcup_{i=1}^\ell \Sigma_i$, and $i \in \{1, \dots, \ell\}$. Let I be a sequence of pairwise distinct integers in $\{1, \dots, \ell\} \setminus \{i\}$, and γ be some path in $\pi_1(\Sigma_i) \sqcup \mathcal{A}(\Sigma_i, \{p_{ij}\}_j)$. Then*

$$\bar{\mu}_C(I; \gamma) \equiv \mu_C(I; \omega) \pmod{\Delta_C(Ii)},$$

where ω is any word in the alphabet $\{R_k^{\pm 1}\}$ such that $\omega.N_{(i)}$ is the reduced i -th longitude associated to γ .

Proof. By Theorem 5.15 and the definition of reduced longitudes, two choices of representative words ω and ω' are related by a finite sequence of insertions/deletions of

- (1) $R_j^{\pm 1} R_j^{\mp 1}$ for some j ;
- (2) commutators $[R_j, \eta_q(w_{jk})]$ for some j and k ;
- (3) commutators $[R_j, R_j^g]$ for some j and $g \in F$;
- (4) conjugates R_i^g for some $g \in F$.

It has already been checked in the proof of Proposition 4.3 that the residue class of $\mu_C(I; \omega_\gamma)$ is invariant under the operations (1) and (2) (there, we denoted $\eta_q(w_{ij})$ by ω_{ij}). It is hence sufficient to check it for operations (3) and (4). Let us first consider operation (3). Suppose that the words ω and ω' differ by a factor $[R_j, R_j^g]$, for some j and $g \in F$. A standard argument on the Magnus expansion shows that $E([R_j, R_j^g]) - 1$ is a sum of monomials, each containing two occurrences of the variable X_j . This readily implies that $\mu_C(I; \omega) = \mu_C(I; \omega')$ for any sequence I of pairwise distinct integers. Concerning operation (4), since the sequence I does not contain i , it is easily seen that $\mu_C(I; \omega) = \mu_C(I; \rho_{R_i}(\omega))$, where the operator ρ_{R_i} removes all occurrences of R_i . If ω' is obtained from ω by inserting a R_i^g factor, then $\rho_{R_i}(\omega')$ is obtained from $\rho_{R_i}(\omega)$ by inserting $\rho_{R_i}(gg^{-1})$, and the result then follows from case (1). \square

By Proposition 5.20, and the same arguments as in Remarks 4.19 and 4.23, non-repeated Milnor invariants are well-defined invariants for the reduced peripheral systems up to equivalence. By Theorem 5.17, we hence obtain the following.

Proposition 5.21. *Non-repeated Milnor invariants for cut-diagrams are invariant under reduced cut-concordance.*

Remark 5.22. Note that Propositions 5.20 and 5.21 are stated for cut-diagrams that are *not* reduced. However, following the same lines as in Section 4, non-repeated Milnor invariants can actually be generalized to well-defined invariants for all reduced cut-diagrams, and these two propositions remain true in this more general setting.

Let us return to topology. As hinted at the beginning of Subsection 5.2.3, reduced cut-concordance can be thought of as a combinatorial generalization of link-homotopy.

In dimension 1, the trace of a link-homotopy gives a self-singular concordance, hence a reduced cut-concordance between the associated diagrams. Proposition 5.21 thus recovers, in a combinatorial way, the link-homotopy invariance for non-repeated Milnor invariants of classical links, known since the seminal works of Milnor [23].

In higher dimensions, it is not clear that the trace of a link-homotopy leads in general to a reduced cut-concordance. However, in the 2-dimensional case, we have a general diagrammatic theory for link-homotopy: any two diagrams of two link-homotopic surface-links F and F' are related by a finite sequence of Roseman moves [29] or self-singular Roseman moves [3].⁹ By considering the trace of this sequence of local moves, and considering the associated cut-diagram, we have a reduced cut-concordance between topological cut-diagrams for F and F' . By Proposition 5.21, we thus have the following.

Proposition 5.23. *Non-repeated Milnor invariants for surface-links are invariant under link-homotopy.*

Note that this result will be shown using an alternative argument in Subsection 7.3.

Remark 5.24. Let L be an embedding of an ℓ -component n -manifold Σ into S^{n+2} . One can adapt the definition of Orr's invariant [26] reviewed in Section 4.6.3, but replacing the nilpotent quotient F/F_q with the reduced free group RF . Under the assumption that $RG(L) \cong RF$, we obtain in this way 'new' invariants $\theta_R^\ell = [\overline{\phi_R^\ell}] \in \pi_{n+2}(\text{Cone}(f_R^\ell))$ of L , where

$$f_R^\ell : K(F, 1) \longrightarrow K(RF, 1) \quad , \text{ and } \quad \overline{\phi_R^\ell} : S^{n+2} \longrightarrow \text{Cone}(f_R^\ell)$$

is the extension of $\phi_R^\ell : S^{n+2} \setminus L \longrightarrow K(RF, 1)$.

Although this will not be further developed in the present paper, we expect that these invariants θ_R^ℓ are (based) link-homotopy invariants; note that one possible ingredient for proving such a result is the reduced Stallings theorem stated in Corollary 5.18. Since the above assumption that $RG(L) \cong RF$ is equivalent to saying that all non-repeated Milnor invariants of L vanish, we could obtain in this way 'new' link-homotopy invariants for codimension 2 embeddings with vanishing non-repeated Milnor invariants. Note however that in the classical dimension $n = 1$, all links with vanishing non-repeated Milnor invariants are link-homotopically trivial [24], so that this construction is only relevant for higher dimensions. In this respect, it is natural to raise the question whether all surface-links with vanishing non-repeated Milnor invariants are link-homotopically trivial.

6. EXAMPLES AND APPLICATIONS

In this section, we gather several topological applications of Milnor invariants for cut-diagrams. These examples involve almost exclusively surface-links. Recall indeed that Milnor invariants for cut-diagrams induce Milnor invariants for codimension 2 embeddings, see Definition 4.25.

6.1. Milnor invariants of Spun links. Spun links refer to a classical construction due to Artin [1], which produces surface-links from classical tangles as follows. Consider in \mathbb{R}^4 the upper 3-dimensional space $\mathbb{R}_+^3 = \{(x, y, z, 0) \mid x, y \in \mathbb{R}, z \geq 0\}$; the (x, y) -plane $P_{xy} = \{(x, y, 0, 0) \mid x, y \in \mathbb{R}\}$ sits as the boundary of \mathbb{R}_+^3 . Given a compact 1-manifold X properly embedded in \mathbb{R}_+^3 , the *Spun of X* is the surface-link $\text{Spun}(X)$ obtained by spinning X around P_{xy} inside $\mathbb{R}^4 \supset \mathbb{R}_+^3$:

$$(6.1) \quad \left\{ (x, y, z \cos \theta, z \sin \theta) \mid (x, y, z, 0) \in X, \theta \in [0, 2\pi] \right\}.$$

Note that the Spuns of a tangle and of its mirror image are isotopic.

⁹Here, these moves are seen as local moves on the immersed surfaces, while in Section 7.3 we shall use them as local moves on immersions of surfaces.

Observe that a closed component of X yields an toroidal component of $\text{Spun}(X)$, while a knotted arc in X produces a spherical component. A diagram of X naturally gives a surface-link diagram of $\text{Spun}(X)$, where each crossing yields a circle of double points without triple or branch point, hence a (topological) 2-dimensional cut-diagram.

Our Milnor invariants are well-behaved under the Spun construction. In particular, we have the following.

Lemma 6.1. *Let X be a tangle in \mathbb{R}_+^3 as above.*

If the i -th component of X is a knot, then for any sequence I we have

$$m_{\text{Spun}(X)}(Ii) \equiv |\mu_X(Ii)| \pmod{\Delta_X(Ii)}.$$

If the i -th component of X is an arc, then for any sequence J we have

$$m_{\text{Spun}(X)}(Ji) = \nu_{\text{Spun}(X)}(Ji) = 0.$$

Remark 6.2. When the i -th component of X is a knot, we have in particular that the first non-vanishing Milnor loop-invariants of $\text{Spun}(X)$ are given by the first non-vanishing Milnor invariants of X by $\nu_{\text{Spun}(X)}(Ii) = |\mu_X(Ii)|$.

Proof. Suppose that the i -th component of X is a knot, so that the i -th component of $\text{Spun}(X)$ is a torus. Let C_X be a cut-diagram for X , whose i -th component is denoted by σ_i . A cut-diagram C_S for $\text{Spun}(X)$ is obtained from C_X for X by setting $C_S := C_X \times S^1$; we denote by Σ_i the i -th component of C_S . A system of i -th loop-longitudes is provided by a choice (α_i, β_i) of two loops in Σ_i , given by:

$$(6.2) \quad \alpha_i = \sigma_i \times \{*\} \quad \text{and} \quad \beta_i = \{*\} \times S^1$$

for some point $*$ of σ_i which is not a cut point. By construction, the loop β_i is disjoint from all cut arcs in Σ_i , hence we have that $\mu_{\text{Spun}(X)}(J; \beta_i) = 0$ for any sequence J , and $m_{\text{Spun}(X)}(Ii) = |\mu_{\text{Spun}(X)}(I; \alpha_i)|$. Observe that there are one-to-one correspondences between the cut arcs (resp. regions) in C_S , and cut points (resp. regions) in C_X , and that the cut arcs of C_S contain no crossing. (See Figure 11 for an example.) It follows not only that the groups $G(C_S)$ and $G(C_X)$ have same presentation, which is a well-known fact on Spun links, but also that the i -th longitude $\lambda_i(\alpha_i) \in G(C_S)$ coincides, up to sign, with the i -th longitude in $G(C_X)$ given by σ_i . This shows that $|\mu_{\text{Spun}(X)}(I; \alpha_i)| = |\mu_{C_X}(I; \alpha_i)| = |\mu_X(Ii)|$, and the result follows.

The second part of the statement is clear: if the i -th component of X is an arc with boundary in P_{xy} , then the i -th component of $\text{Spun}(X)$ is a sphere, hence there is no nontrivial loop-longitude in Σ_i . \square

Remark 6.3. The Spun construction can be generalized to any dimension in a straightforward way. Hence one can iterate this construction, starting with a tangle in \mathbb{R}_+^3 , to build a codimension 2 embedding. The argument of the above proof apply at each step and we can obtain a similar result as Lemma 6.1 in any dimension.

6.2. Realization results. A natural question is to ask whether, for any given sequence I of integers, there exists a surface-link whose Milnor invariant indexed by I takes the value 1.

The examples given in Section 4.5 provide such realization results for length 3 Milnor loop/arc-invariants, and can be straightforwardly generalized to (non-repeating) sequences of any length. In particular, the first example involving the surface-link B of Figure 8 can be generalized straightforwardly to realize any Milnor loop-invariant, by a surface-link containing a single non-spherical component.

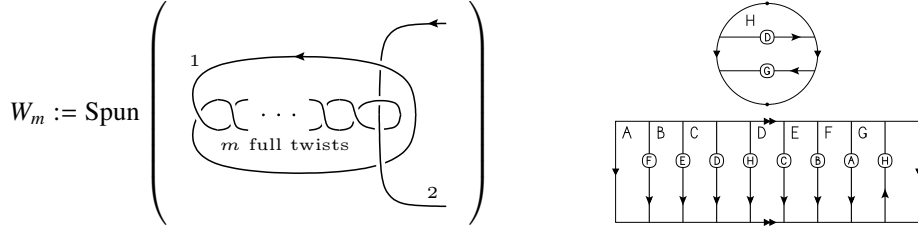
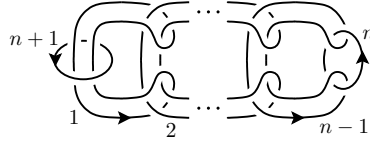

FIGURE 11. Definition of the surface-links $W_m = \text{Spun}(X_m)$, and a cut-diagram for W_3

Alternatively, we can give a general realization result using the Spun construction. Consider the $(n + 1)$ -component link M_{n+1} shown below, known as *Milnor's link*.



Milnor observed that all Milnor invariants of length $\leq n$ vanish for M_{n+1} , and that for any permutation σ in S_{n-1} , we have $\bar{\mu}_{M_{n+1}}(\sigma(1) \cdots \sigma(n-1) n n+1) = \begin{cases} 1 & \text{if } \sigma = \text{Id}, \\ 0 & \text{otherwise.} \end{cases}$

Using Lemma 6.1 and Remark 6.2, we directly obtain a similar realization result for the first non-vanishing Milnor loop invariants $\nu(1 \cdots n+1)$ of surface-links, by considering $\text{Spun}(M_{n+1})$. More generally, by iterating the Spun construction and using Remark 6.3, we obtain in this way a similar result in any dimension.

6.3. A classification result up to concordance. We now compare the relative strength of our Milnor invariants of surface-links with previous invariants defined in the literature.

Definition 6.4. For every $m \in \mathbb{N}$, we define W_m as the spun surface obtained by spinning the tangle X_m described in Figure 11.

Remark 6.5. The family W_m can be extended to negative values of m , but this amounts to spinning the mirror image of the tangle X_{-m} of Figure 11. Hence, W_{-m} is isotopic to W_m .

Many of the previously known concordance invariants of surface-links cannot detect this family of Spun links. Indeed, for all $m \in \mathbb{N}$, we have that

- the Sato–Levine invariant [33] vanishes on W_m ,
- Cochran's derivation invariants [10] all vanishes on W_m ,
- Saito's invariants [32] of W_m are equal for all values of $m \in \mathbb{N}$,
- since W_m is link-homotopic to a union of trivially embedded torus and sphere for all $m \in \mathbb{N}$, all link-homotopy invariants vanish on W_m .

In contrast, using Milnor loop-invariants we show the following.

Proposition 6.6. For any $m_1, m_2 \in \mathbb{N}$, W_{m_1} and W_{m_2} are concordant if and only if $m_1 = m_2$.

Proof. This is an immediate consequence of the fact that, for all $m \in \mathbb{N}$,

$$\nu_{W_m}(2121) = m.$$

This computation can be performed directly on a cut-diagram, as given on the right-hand side of Figure 11 for $m = 3$; although it is technically slightly more involved, this computation follows the exact same lines as the one for B in Section 4.5.

Alternatively, since W_m is a Spun link, one can also use Lemma 6.1 for this computation. Closing the second component of X_m yields a 2–component link which is the Whitehead m –double of the negative Hopf link, in the sense of [21]. Using [21, Thm. 1.1], we obtain that $\mu_{X_m}(I) = 0$ for any sequence I of length ≤ 3 , and that $\mu_{X_m}(2211) = -m$. By Lemma 6.1, we deduce that $\nu_{W_m}(2211) = m_{W_m}(2211) = m$, as desired. \square

6.4. Link-homotopy classification results. The next two applications provide link-homotopy classification results for Spun links and for knotted punctured spheres.

6.4.1. *Spun links up to link-homotopy.* Milnor showed in [23] that links of 3 components are classified up to link-homotopy by their non-repeated Milnor invariants of length ≤ 3 . Using the good behavior of our Milnor invariants under the Spun construction, we show the following.

Proposition 6.7. *Let L and L' be 3–component links. Then $\text{Spun}(L)$ and $\text{Spun}(L')$ are link-homotopic if and only if L is link-homotopic to either L' or its mirror image.*

Remark 6.8. Of course the link-homotopy classification for 2–component Spun links is also implied by this statement, for example by adding a third trivial and unlinked component.

Proof. The ‘if’ part of the statement is clear. Indeed spinning a link-homotopy between L and L' provides a link-homotopy between $\text{Spun}(L)$ and $\text{Spun}(L')$, and we already noted that the Spun of a link and of its mirror image are isotopic.

Next we suppose that $F = \text{Spun}(L)$ and $F' = \text{Spun}(L')$ are link-homotopic. Set $L = L_1 \sqcup L_2 \sqcup L_3$ and $L' = L'_1 \sqcup L'_2 \sqcup L'_3$, and set $F_i = \text{Spun}(L_i)$ and $F'_i = \text{Spun}(L'_i)$ for $i \in \{1, 2, 3\}$. Observe that the topological cut-diagrams C and C' are reduced cut-concordant (using the arguments above Proposition 5.23). Hence by Theorem 5.17, they have equivalent reduced peripheral systems over a disjoint union of tori Σ_i ($i = 1, 2, 3$). Let α_i, β_i (resp. α'_i, β'_i) be loops on Σ_i corresponding to $L_i \times \{*\}$ and $\{*\} \times S^1$ (resp. $L'_i \times \{*\}$ and $\{*\} \times S^1$), respectively. Denote by γ_i the loop which corresponds to α'_i under the equivalence of reduced peripheral systems, and let m_i and n_i be integers such that γ_i is homologous to $m_i\alpha_i + n_i\beta_i$.

Let I be any non-repeated sequence of indices in $\{1, 2, 3\}$. We first note that, if C_L is a cut-diagram for L , then $C = C_L \times S^1$ is a cut-diagram for F , so that we have $\Delta_F(I) = \Delta_L(I)$ and $\mu_F(I; \alpha_i) \equiv \mu_L(I) \pmod{\Delta_L(I)}$. Similarly, $\Delta_{F'}(I) = \Delta_{L'}(I)$ and $\mu_{F'}(I; \alpha'_i) \equiv \mu_{L'}(I) \pmod{\Delta_{L'}(I)}$. Next, by a similar observation as in the proof of Lemma 6.1 we have $\mu_F(I; \beta_i) = 0$, so that by Lemma 4.6 we obtain:

$$\mu_F(I; m_i\alpha_i + n_i\beta_i) = m_i\mu_F(I; \alpha_i) \equiv m_i\mu_L(I) \pmod{\Delta_L(I)}.$$

Finally, because F and F' are link-homotopic, we have that $\Delta_F(I) = \Delta_{F'}(I)$ and

$$\mu_{F'}(I; \alpha'_i) \equiv \mu_F(I; \gamma_i) \pmod{\Delta_F(I)}.$$

All together, we obtain in this way that

$$m_i\mu_L(I) \equiv \mu_{L'}(I) \pmod{\Delta_L(I)}.$$

On the other hand, again because F and F' are link-homotopic and using Lemma 6.1, we have that

$$|\mu_L(I)| \equiv |\mu_{L'}(I)| \pmod{\Delta_L(I)}$$

for any non-repeated sequence I . This implies that $m_i = \pm 1$ for each i . Since $\Delta(I) = 0$ and Milnor invariants have cyclic symmetry, we have

$$\Delta_L(123) = \gcd\{\mu_L(12), \mu_L(13), \mu_L(23)\} = \gcd\{m_2\mu_L(12), m_3\mu_L(13), m_3\mu_L(23)\} = \Delta_L(123)$$

and

$$m_1\mu_L(231) \equiv m_2\mu_L(312) \equiv m_3\mu_L(123) \equiv \mu_{L'}(123) \pmod{\Delta_L(123)}.$$

If $\mu(ij)$ is nonzero for some indices i, j ,

$$m_i\mu_L(ji) = \mu_{L'}(ji) = \mu_{L'}(ij) = m_j\mu_L(ij).$$

This implies that $m_i = m_j$, and moreover $m_i\mu_L(ki) = \mu_{L'}(ki)$ and $m_i\mu_L(kj) = \mu_{L'}(kj)$. Therefore, whichever all $\mu(ij)$ vanish or not, we have that $\Delta_L(123) = \Delta_{L'}(123)$ and, for some m ($m = \pm 1$),

$$m\mu_L(12) = \mu_{L'}(12), \quad m\mu_L(13) = \mu_{L'}(13), \quad m\mu_L(23) = \mu_{L'}(23),$$

and

$$m\mu_L(123) \equiv \mu_{L'}(123) \pmod{\Delta_L(123)}.$$

If $m = 1$, then L and L' are link-homotopic by Milnor's classification result. If $m = -1$, then the same holds for L and the mirror image of L' . This concludes the proof \square

For Spun links with an arbitrary number of components, we also have the following consequence of Lemma 6.1.

Proposition 6.9. *Let L be an m -component link. The following are equivalent:*

- (i) $\text{Spun}(L)$ is link-homotopically trivial;
- (ii) $\nu_{\text{Spun}(L)}(I) = m_{\text{Spun}(L)}(I) = 0$ for any non-repeated sequence I ;
- (iii) L is link-homotopically trivial.

Proof. Implication (i) \Rightarrow (ii) is a consequence of Proposition 5.23. Condition (ii) implies by Lemma 6.1 that all non-repeated Milnor invariants of L are zero, which implies (iii) according to Milnor [23]. Implication (iii) \Rightarrow (i) is clear, as above: spinning a link-homotopy between L and the trivial link U provides a link-homotopy between $\text{Spun}(L)$ and $\text{Spun}(U)$. \square

6.4.2. *Link-homotopy classification of knotted punctured spheres.* We next mention another link-homotopy classification result derived from our construction, whose proof will appear in a forthcoming paper [5].

Let $n \geq 2$ be some integer, and p_1, \dots, p_n some positive integers. A *knotted punctured spheres* is any surface-link which is a proper embedding of $\sqcup_{i=1}^n S_{p_i}^2$ into the 4-ball B^4 , where $S_{p_i}^2$ is the 2-sphere with p_i holes, and such that the boundary is mapped to the trivial link with $\sum_i p_i$ components in $S^3 = \partial B^4$. Notice that taking $p_i = 1$ for all i yields the notion of linked disks introduced by Le Dimet in [20], while taking $p_i = 2$ for all i produces 2-string links, as studied in [3].

We have the following classification result, which generalizes [3, Thm. 4.8].

Theorem 6.10. *Knotted punctured spheres are classified up to link-homotopy by Milnor invariants.*

Note that knotted punctured spheres do not contain any nontrivial loop longitude, since the boundary is assumed to be a trivial link. Therefore, we actually make use here of Milnor arc-invariants.

Remark 6.11. This result can actually be extended to a wider notion of knotted punctured sphere, where the boundary is assumed to form a *slice* link. The slice condition ensures that loop longitudes are still all trivial as nilpotent group elements. As a corollary, we have that all slice disks for a given slice link are link-homotopic, see [5].

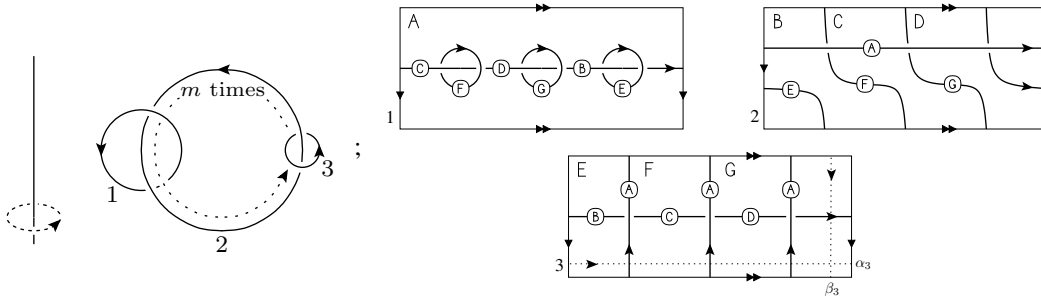
FIGURE 12. The surface S_m (left), and a cut-diagram for S_3 (right).

6.5. An obstruction for ribbonness. Our next application of Milnor invariants for surface-links is a criterion for ribbon surface-links.

Recall that a ribbon immersed 3-manifold in 4-space is an immersion such that the only singularities are 2-disks with two preimages, one embedded in the interior and the other properly embedded. A surface-link is *ribbon* if its image is the boundary of some ribbon immersed 3-dimensional handlebodies in 4-space. We call the latter a *ribbon filling* of the ribbon surface; note that a given ribbon surface generally doesn't admit a unique ribbon filling. These are the natural analogues of the notion of ribbon introduced by Fox in the classical dimension; as a matter of fact, this definition generalizes naturally to any dimension. Spun links turn out to be examples of ribbon surfaces. This is seen, in the notation of Section 6.1, by spinning not only the given tangle X , but also all projection rays from the tangle to the plane P_{xy} around which X is spun.

We now show how Milnor maps can be used to obstruct ribbonness. Let C be some cut-diagram over an n -dimensional manifold Σ , and let Ii be some sequence of indices.

Definition 6.12. The *free kernel* of the Milnor map $M_C^{Ii} : H_1(\Sigma_i) \rightarrow \mathbb{Z}/\Delta_C(Ii)\mathbb{Z}$, is the maximal submodule $\text{Ker}_0(M_C^{Ii}) \subset \text{Ker}(M_C^{Ii})$ such that $H_1(\Sigma_i)/\text{Ker}_0(M_C^{Ii})$ is torsion-free.

Since the Milnor map M^{Ii} up to automorphisms of $H_1(\Sigma_i)$ is an invariant for nilpotent peripheral systems up to equivalence (see the end of Remark 4.19), it is a cut-concordance invariant. In particular, the rank of free kernel is a cut-concordance invariant of C .

Now, a ribbon filling H of a genus g component S_i of a surface-link S , induces a rank g submodule $\text{Ker}(H_1(\Sigma_i) \hookrightarrow H_1(H))$, which is clearly contained in the free kernel of any Milnor map on $H_1(\Sigma_i)$. This implies the following obstruction result for ribbonness.

Proposition 6.13. *Let S be a surface-link which is concordant to a ribbon one. If S_i is a genus g component of S , then $\text{rank}(\bigcap_{I \in \mathcal{I}} \text{Ker}_0(M_S^I)) \geq g$ for any nonempty set \mathcal{I} of sequences ending with i .*

If, moreover, all the sequences in \mathcal{I} are non-repeated, then S is not even link-homotopic to a ribbon one.

Let us give a concrete application of this criterion. For every $m \in \mathbb{Z}$, we denote by S_m the surface-link shown on the left-hand side of Figure 12. It is obtained by spinning a 3-component link as illustrated in Figure 12 and, while spinning, moving the third unknot m times around the second one. The surface-link S_1 appears in [3], where it was proved that it is not link-homotopic, hence not concordant, to any ribbon surface. In fact, the argument given in [3] shows that S_m is not link-homotopic to a ribbon surface for all *odd* values of m . Using free kernels, we can actually prove the following.

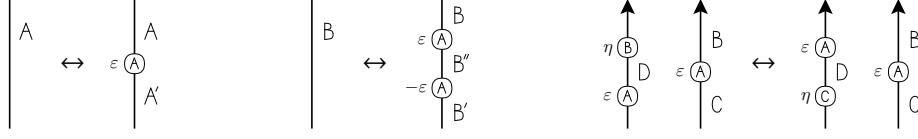

FIGURE 13. Topological moves on 1–dimensional cut-diagrams:
 in the middle and right moves, B'' and D , respectively, are assumed to never occur as the
 label of any cut domain; in the left/middle move, when going from left to right, every
 A/B –label becomes either an A/B or A'/B' –label, and when going from right to left, all the
 A/B and A'/B' –labels become A/B –labels

Proposition 6.14. *The surface-link S_m is link-homotopic to a ribbon surface if and only if $m = 0$.*

Proof. Since S_0 is a Spun link, it is a ribbon surface. Let us now show that, if $m \neq 0$, then S_m is not concordant to a ribbon surface. For the sake of simplicity, we give the proof for $m = 3$: the general case is handled in a strictly similar way. The right-hand side of Figure 12 gives a cut-diagram C_3 for the surface-link S_3 . We denote by $\alpha_3, \beta_3 \in H_1(\Sigma_3)$ the cycles shown in dashed lines on the cut-diagram of Figure 12. It is easily computed that $\text{Ker}_0(M_{S_3}^{13}) = \langle \beta_3 \rangle$ and $\text{Ker}_0(M_{S_3}^{23}) = \langle \alpha_3 \rangle$, so that $\text{rank}(\text{Ker}_0(M_{S_3}^{13}) \cap \text{Ker}_0(M_{S_3}^{23})) = 0$. By Proposition 6.13, this shows that S_3 cannot be link-homotopic to a ribbon surface. \square

7. LOCAL MOVES FOR CUT-DIAGRAMS

In this last section, we introduce sets of local moves on 1 and 2–dimensional cut-diagrams, which emulate usual equivalence relations of isotopy or link-homotopy.

7.1. Topological moves for cut-diagrams. As discussed in Section 1.1, there is a procedure which associates a cut-diagram to any given diagram of a codimension 2 embedding; recall that we called *topological* a cut-diagram arising in this way. We now introduce *topological moves* on cut-diagrams, which generalize the topological notion of isotopy in the sense that they relate any two cut-diagrams associated to diagrams of a same codimension 2 embedding.

Let us first focus on the 1–dimensional case. It is straightforward to translate each of the three Reidemeister moves of knot theory into the language of 1–dimensional cut-diagrams, leading to the three 1–dimensional *topological moves* given in Figure 13. By construction, the assignment of a 1–dimensional cut-diagram to any given tangle yields a well-defined map

$$\Xi_1 : \{\text{tangles}\} / \text{isotopy rel. boundary} \rightarrow \{1\text{-dim. cut-diagrams}\} / \text{topological moves.}$$

Now, as noticed in Remark 1.1, 1–dimensional cut-diagrams are in bijection with Gauss diagrams up to Tail-Commute moves. Since Gauss diagrams up to Reidemeister and Tail-Commute moves exactly correspond to welded objects, 1–dimensional cut-diagrams up to topological moves are just a mere reformulation of the welded theory. In particular, the map Ξ_1 is in fact known to be injective; see Remark 7.4. As a matter of fact, cut-diagrams can be seen as a generalization, in any dimension, of the notion of welded objects, see [37, Question 80].

Next we turn to the 2–dimensional case. Two surface-link diagrams represent isotopic surface-links if and only if they differ by a sequence of the seven Roseman moves given in

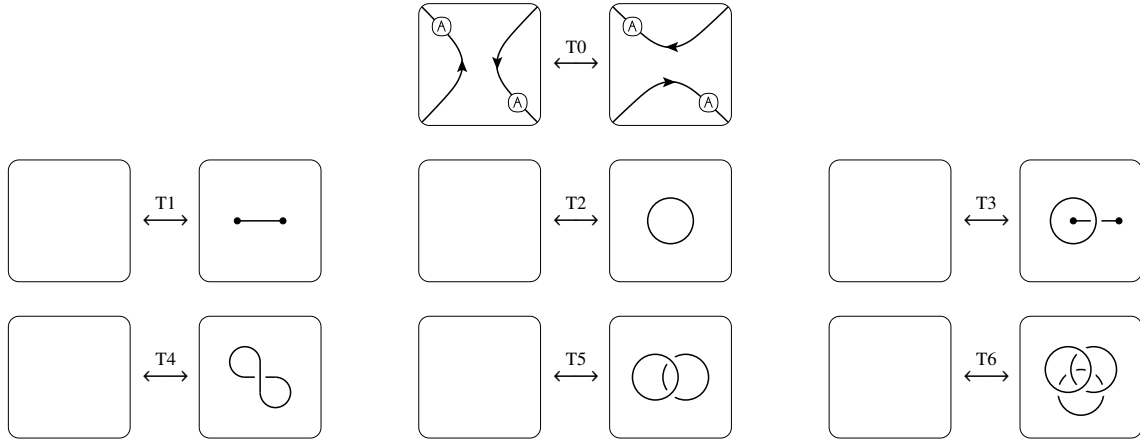

FIGURE 14. Topological moves on 2–dimensional cut-diagrams: we only indicate the labelings when necessary, with the implicit condition that any of these moves is valid only if the labeling conditions are fulfilled before and after the move

[29]. These Roseman moves are straightforwardly translated into moves on cut-diagrams (a list of such moves is given in [4]), and it is easily seen that they are all generated by the 2–dimensional topological moves, given in Figure 14. Observe that the first move T0, may merge two regions or split a region into two: in such a case, all cut arcs labeled by one of the two merged regions are relabeled by the new region, and all cut arcs labeled by the split region are relabeled in an admissible way¹⁰ by any of the two new regions. All other moves in Figure 14 are ‘local’, but may delete a region: such moves are only valid if this region never occurs as the label of any cut arc. This leads to a well-defined map

$$\Xi_2 : \{ \text{surface-links} \} / \text{isotopy rel. boundary} \rightarrow \{ \text{2–dim. cut-diagrams} \} / \text{top. moves.}$$

Remark 7.1. A similar map Ξ_n can be defined for any $n \geq 3$. Indeed, Roseman moves given in [29] for surface-link diagrams, are merely a special case of [31], where Roseman defines local moves for diagrams in any dimension. By simply translating these general Roseman moves in the language of cut-diagrams, one can thus define topological moves in any dimension. In this way, n –dimensional welded objects can be defined directly, without resorting to any ‘virtual’ theory.

7.2. Topological moves and peripheral system. The notion of group and peripheral elements—meridians and preferred longitudes—was defined for cut-diagrams in Section 2. This is actually a well-defined invariant of cut-diagrams up to topological moves.

Proposition 7.2. *In dimension 1 and 2, the equivalence class of the peripheral system is invariant under all topological moves of cut-diagrams.*

Proof. This is proved by analyzing one by one all topological moves, noting that each is supported in a ball that we will denote by B . Details are left to the reader, but the strategy in each case is to compare generators and relators within B , and check that the resulting presentations are related by Tietze transformations. It follows that the groups, before and after the move, are isomorphic. It then remains to show that the preferred longitudes are

¹⁰Note that such an admissible relabeling may not exist, in which case the move is not valid; if several different relabelings are admissible, then the move exists in several valid versions.

preserved by this isomorphism. For that, it suffices to note that any longitude can be described by a path on Σ which is disjoint from B ; note however that this may require to first move the component basepoint outside of B . \square

It follows that nilpotent peripheral systems are also invariant under topological moves in dimensions 1 and 2.

Corollary 7.3. *In dimension 1 and 2, Milnor numbers are invariant under all topological moves of cut-diagrams.*

In the 2–dimensional case, it was already noted in Remarks 2.3 and 2.15 that for a topological cut-diagram, the notions of group and peripheral elements coincide with the group and peripheral elements of the underlying surface-links. In other words, Remarks 2.3 and 2.15 tell that Ξ_2 preserves the peripheral system. The same is true in dimension 1. Using the Wirtinger presentation associated with a diagram of some tangle L , it is indeed straightforwardly checked that the group of $\Xi_1(L)$ is isomorphic to the group of L , and that under this isomorphism, the combinatorial meridians and preferred longitudes of $\Xi_1(L)$ correspond to the topological meridians and longitudes of L . Combined with Corollary 7.3, this observation provides a direct proof of Theorem 4.26 in dimension 1 and 2.

Remark 7.4. Since, in the 1–dimensional case, the peripheral system is a complete invariant, we have that Ξ_1 is an injective map. This, of course, is a mere reformulation of a well-known fact on the inclusion of classical tangles into welded tangles [12]. This naturally raises the question of the injectivity of Ξ_2 , for which the above argument no longer applies since the peripheral system is not a complete invariant for surface-links [36].

7.3. Cut-diagram moves for link-homotopy in dimensions 1 and 2. In addition to the topological moves of Section 7.1, we give here, in dimension 1 and 2, a list of local moves that generate, for topological cut-diagrams, the notion of link-homotopy.

The 1–dimensional *self-singular move* is the following local move:

$$\text{---} \overset{A}{\text{---}} \text{---} \leftrightarrow \text{---} \overset{A}{\text{---}} \text{---} \textcircled{B} \text{---} \overset{A'}{\text{---}}$$

Here, A , A' and B are regions of a same connected component and the cut point on the right-hand side can be given any sign; when going from left to right, every A –label becomes either an A or an A' –label, and when going from right to left, all the A and A' –labels become A –labels. In terms of link diagrams, this move amounts to replacing a classical crossing of two strands of a same component, by a virtual one. This is the *self-virtualization* move, which is known to imply link-homotopy for classical links, see [2].

In dimension 2, Roseman moves have been extended to the case of self-singular surfaces in [3], where three self-singular Roseman moves were introduced. In order to faithfully translate these three moves into the language of cut-diagrams, we shall use a refined version of the notion of reduced cut-diagrams of Definition 5.8, as follows.

Definition 7.5. A *self-singular cut-diagram* over a compact oriented surface Σ is a diagram on Σ , whose set of internal endpoints is partitioned into *black* and *white* endpoints, endowed with a labeling of each white endpoint by a sign and a labeling of each cut arc by a region, satisfying the first labeling condition of Definition 1.4 and the following conditions on internal cut arcs:

- a) an internal cut arc containing a black endpoint in some region A , is labeled by A ;
- b) for each white endpoint in some region X , with incident cut arc labeled by Y , there exists a white endpoint in region Y with incident cut arc labeled by X . Moreover, X and Y are two regions of the same connected component of Σ , and both white endpoints are labeled by the same sign.

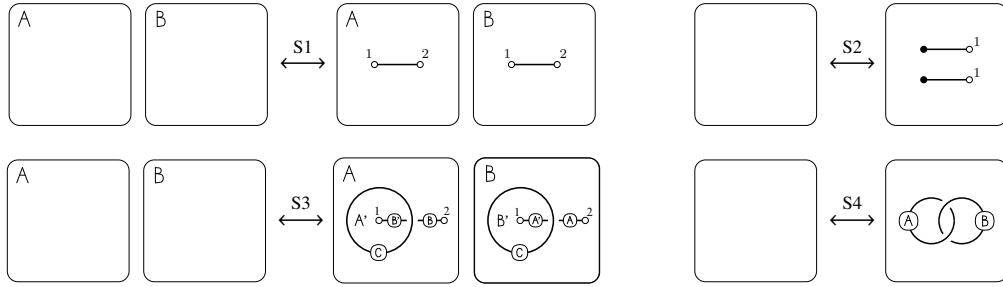

FIGURE 15. 2-dimensional self-singular moves for self-singular cut-diagrams:

A and B are always regions of a same connected component; internal (white) endpoints decorated by the same symbol are paired in the sense of Definition 7.5 b).

Remark 7.6. Note that forgetting the distinction between black and white internal endpoints and the sign label in a self-singular cut-diagram, yields a 2-dimensional reduced cut-diagram. But these extra datas carried by self-singular cut-diagrams, arise naturally from topological objects. Indeed, consider a diagram of some surface-link map. Following the routine of Section 1.1, one obtains a canonical self-singular cut-diagram by associating a black endpoint to each branch point, as in Figure 4, and a pair of white endpoints to each (self-)singularity as in Figure 10, both labeled by the sign of the singularity.

Now, it is a straightforward exercise to translate the three self-singular Roseman moves of [3] into local moves on self-singular cut-diagrams (see [4]), and to show that they are generated by the 2-dimensional self-singular moves of Figure 15.

As a consequence of [3, Prop. 2.4], we thus have that two cut-diagrams of link-homotopic surface-links, are related by a sequence of 2-dimensional topological and self-singular moves, and equivalences of cut-diagrams.

Remark 7.7. Note that a similar statement appears in [4, Thm. 3.12]. The difference lies in the definition of link-homotopy for surface-link maps, see Footnote 2. However, both situations coincide for link maps, which is the main focus of [4].

Now, the equivalence class of the reduced peripheral system is invariant, in dimensions 1 and 2, under these self-singular moves; this is a straightforward verification that we leave to the reader. Consequently, any invariant derived from the reduced peripheral system is also invariant under these moves; by Proposition 5.20, we have hence the following.

Proposition 7.8. *In dimensions 1 and 2, non-repeated Milnor invariants of cut-diagrams are invariant under self-singular moves.*

In view of the above discussion, this implies in particular that non-repeated Milnor invariants for surface-links are invariant under link-homotopy, as stated in Proposition 5.23.

REFERENCES

- [1] E. Artin. Zur isotopie zweidimensionalen flächen im R_4 . *Abh. Math. Sem. Univ. Hamburg*, 4:174–177, 1926.
- [2] B. Audoux, P. Bellingeri, J.-B. Meilhan, and E. Wagner. Homotopy classification of ribbon tubes and welded string links. *Ann. Sc. Norm. Super. Pisa Cl. Sci.*, 17(1):713–761, 2017.
- [3] B. Audoux, J.-B. Meilhan, and E. Wagner. On codimension two embeddings up to link-homotopy. *J. Topol.*, 10(4):1107–1123, 2017.
- [4] B. Audoux, J.-B. Meilhan, and Y. Yasuhara. Higher order Kirk invariants of link maps. arXiv:2311.03015.

- [5] B. Audoux, J.-B. Meilhan, and Y. Yasuhara. Welded graphs, Wirtinger groups and knotted punctured spheres. arXiv:2311.01922.
- [6] J. S. Carter, S. Kamada, and M. Saito. *Surfaces in 4-space*, volume 142 of *Encyclopaedia of Mathematical Sciences*. Springer-Verlag, Berlin, 2004. Low-Dimensional Topology, III.
- [7] J. S. Carter and M. Saito. *Knotted surfaces and their diagrams*, volume 55. Providence, RI: American Mathematical Society, 1998.
- [8] K.-T. Chen. Commutator calculus and link invariants. *Proc. Amer. Math. Soc.*, 3(4):44–55, 1952.
- [9] M. Chrisman. Milnor’s concordance invariants for knots on surfaces. *Alg. Geom. Topol.*, 22:2293–2353, 2022.
- [10] T. D. Cochran. Geometric invariants of link cobordism. *Comment. Math. Helv.*, 60:291–311, 1985.
- [11] T. D. Cochran. Derivatives of links: Milnor’s concordance invariants and Massey’s products. *Mem. Am. Math. Soc.*, 427:73, 1990.
- [12] M. Goussarov, M. Polyak, and O. Viro. Finite-type invariants of classical and virtual knots. *Topology*, 39(5):1045–1068, 2000.
- [13] N. Habegger and X.-S. Lin. The classification of links up to link-homotopy. *J. Amer. Math. Soc.*, 3:389–419, 1990.
- [14] K. Igusa and K. E. Orr. Links, pictures and the homology of nilpotent groups. *Topology*, 40(6):1125–1166, 2001.
- [15] M. A. Kervaire. Les nœuds de dimensions supérieures. *Bull. Soc. Math. Fr.*, 93:225–271, 1965.
- [16] R. Kirby. Problems in low-dimensional topology. in *Geometric Topology*, Providence, RI (1997), pp. 35–473.
- [17] P. A. Kirk. Link maps in the four sphere. *Differential topology*, Proc. 2nd Topology Symp., Siegen/FRG 1987, Lect. Notes Math. 1350, 31-43 (1988), 1988.
- [18] U. Koschorke. A generalization of milnor’s μ -invariants to higher dimensional link maps. *Topology*, 36(2):301–324, 1997.
- [19] O. Kravchenko and M. Polyak. Diassociative algebras and Milnor’s invariants for tangles. *Lett. Math. Phys.*, 95(3):297–316, 2011.
- [20] J.-Y. Le Dimet. Cobordisme d’enlacements de disques. *Mém. Soc. Math. France (N.S.)*, (32):ii+92, 1988.
- [21] J.-B. Meilhan and A. Yasuhara. Whitehead double and Milnor invariants. *Osaka J. Math.*, 48(2):371–381, 2011.
- [22] J.-B. Meilhan and A. Yasuhara. Link concordances as surfaces in 4-space. *Indiana Univ. Math. J.*, 71:2647–2669, 2022.
- [23] J. Milnor. Link groups. *Ann. of Math. (2)*, 59:177–195, 1954.
- [24] J. Milnor. Isotopy of links. *Algebraic geometry and topology*. In *A symposium in honor of S. Lefschetz*, pages 280–306. Princeton University Press, Princeton, N. J., 1957.
- [25] H. A. Miyazawa, K. Wada, and A. Yasuhara. Combinatorial Approach to Milnor Invariants of Welded Links. *Michigan Mathematical Journal*, 73(1):141–170, 2023.
- [26] K. E. Orr. New link invariants and applications. *Comment. Math. Helv.*, 62:542–560, 1987.
- [27] K. E. Orr. Homotopy invariants of links. *Invent. Math.*, 95(2):379–394, 1989.
- [28] J. H. Przytycki and W. Rosicki. Cocycle invariants of codimension 2 embeddings of manifolds. In *Knots in Poland III. Proceedings of the 3rd conference, Stefan Banach International Mathematical Center, Warsaw, Poland, July 18–25, 2010 and Będlewo, Poland, July 25 – August 4, 2010*, pages 251–289. Polish Academy of Sciences, Institute of Mathematics, 2014.
- [29] D. Roseman. Reidemeister-type moves for surfaces in four-dimensional space. In *Knot theory. Proceedings of the mini-semester, Warsaw, Poland, 1995*, pages 347–380. Warszawa: Polish Academy of Sciences, Institute of Mathematics, 1998.
- [30] D. Roseman. Projections of codimension two embeddings. In *Knots in Hellas ’98. Proceedings of the international conference on knot theory an its ramifications, European Cultural Centre of Delphi, Greece, August 7–15, 1998*, pages 380–410. Singapore: World Scientific, 2000.
- [31] D. Roseman. Elementary moves for higher dimensional knots. *Fundam. Math.*, 184:291–310, 2004.
- [32] M. Saito. A note on cobordism of surface links in S^4 . *Proc. Am. Math. Soc.*, 111(3):883–887, 1991.
- [33] N. Sato. Cobordisms of semi-boundary links. *Topology Appl.*, 18:225–234, 1984.
- [34] R. Schneiderman and P. Teichner. The group of disjoint 2-spheres in 4-space. *Ann. Math. (2)*, 190(3):669–750, 2019.
- [35] J. Stallings. Homology and central series of groups. *J. Algebra*, 2:170–181, 1965.
- [36] K. Tanaka. Inequivalent surface-knots with the same knot quandle. *Topology Appl.*, 154(15):2757–2763, 2007.
- [37] B. K. Winter. *Virtual, Welded, and Ribbon Links in Arbitrary Dimensions*. Phd, State University of New York at Buffalo, 2014.

AIX MARSEILLE UNIV, CNRS, CENTRALE MARSEILLE, I2M, MARSEILLE, FRANCE
Email address: benjamin.audoux@univ-amu.fr

UNIV. GRENOBLE ALPES, CNRS, INSTITUT FOURIER, F-38000 GRENOBLE, FRANCE
Email address: jean-baptiste.meilhan@univ-grenoble-alpes.fr

FACULTY OF COMMERCE, WASEDA UNIVERSITY, 1-6-1 NISHI-WASEDA, SHINJUKU-KU, TOKYO 169-8050, JAPAN
Email address: yasuhara@waseda.jp