

DeepZensols: Deep Natural Language Processing Framework

Paul Landes Barbara Di Eugenio Cornelia Caragea

{plande2, bdieugen, cornelia}@uic.edu

Department of Computer Science

University of Illinois at Chicago

Abstract

Reproducing results in publications by distributing publicly available source code is becoming ever more popular. Given the difficulty of reproducing machine learning (ML) experiments, there have been significant efforts in reducing the variance of these results. As in any science, the ability to consistently reproduce results effectively strengthens the underlying hypothesis of the work, and thus, should be regarded as important as the novel aspect of the research itself. The contribution of this work is a framework that is able to reproduce consistent results and provides a means of easily creating, training, and evaluating natural language processing (NLP) deep learning (DL) models.

1 Introduction

Consistently reproducing results is a fundamental criteria of the scientific method, without which, a hypothesis may be weakened or even invalidated. This is becoming even more necessary, because a growing number of publications are inflated by false positives, to the point that they are labeled with the pejorative term “p-hacking”, the intentional or unintentional act to bias results in favor of publication for peer acceptance (Head et al., 2015); efforts in this direction include introducing new statistical methods to detect false findings (Ulrich and Miller, 2015).

The inability to reproduce results has been referred to as the “replication crisis” (Hutton, 2018). The problem of reproducibility in results is becoming more acknowledged as a serious issue in the ML community with efforts to understand and overcome the challenge (Olorisade et al., 2017). Not only has the community addressed the issue in the literature, it has endeavored to assess if experiments

are reproducible and provide recommendations to remedy the problem where reproducibility is lacking. An example of this effort includes reporting on experimental methodology, implementation, analysis and conclusions in the [Reproducibility Challenge](#)¹.

To address these issues, we present DeepZensols, a DL framework for NLP research by and for the academic research community. Not only does the framework address issues of reproducibility, it also is designed to easily and quickly test with varying model configurations such as extending contextual (and non-contextual) word embeddings (Devlin et al., 2019; Mikolov et al., 2013; Pennington et al., 2014) with linguistic token level features (Huang et al., 2015), and join layer document level features (Deerwester et al., 1990; Sparck Jones, 1972) using easy to write configuration with little to no code.

What sets DeepZensols apart from other frameworks is its capability of reproducing results, efficient mini-batch creation for feature swapping for model comparisons, and an emphasis on vectorization of natural language text providing zero coding neural network (NN) construction. The framework was written with NLP researchers, science related outcomers, and students in mind.

The framework’s source code and installable libraries are released under the [MIT License](#)², which is available both on GitHub and as Python pip packages along with extensive and in depth documentation, tutorials and [Jupyter notebook](#)³ examples. The advanced programming interface (API) documentation is fully hyperlinked, includes overview docu-

¹<https://www.cs.mcgill.ca/~jpineau/ICLR2018-ReproducibilityChallenge.html>

²<https://opensource.org/licenses/MIT>

³<https://jupyter.org>

mentation, class diagrams, and tutorials. The framework is validated with 236 unit tests and six integration tests, most of which are automated using continuous integration testing for both functionality and reproducibility.

2 Previous Work

Popular DL frameworks such as TensorFlow⁴ have a dashboard that provides metrics, such as training and validation loss. However, these general purpose frameworks offer basic performance metrics and do not provide a means of producing higher abstraction level NLP specific models. More specifically, frameworks such as Keras, supply a very coarse API allowing solely for cookie-cutter models. They lack the ability to easily create and evaluate models past this surface interface.

Frameworks such as PyTorch⁵, which are more common in academia, provide a more straightforward simple API that is similar to the core TensorFlow⁶ libraries, and thus have the same shortcomings as a tool to bridge the gap between pure research and reproducibility.

AllenNLP⁷ (Gardner et al., 2018) is a flexible configuration driven framework that provides ease of construction of NLP NN architectures, and thus, is the closest framework to ours. However, it does not have fast feature swapping (see Section 3.5) and batch creation capability, and lacks most of the components necessary to consistently reproduce results⁸.

Popular packages providing support for transformer architectures such as BERT (Devlin et al., 2019) include HuggingFace⁹. However, this framework only provides transformer models for contextual word embeddings.

3 Design

Like the DeepDIVA (Alberti et al., 2018), DeepZensols is written in Python and utilizes, but does not replace, PyTorch. The goal of our framework is:

- Reproducibility of results (see Section 3.1),

- Efficiently create and load mini-batches (see Section 3.5),
- Decouple the process of vectorizing data for reuse in NN architectures (see Section 3.4),
- Provide language specific vectorization (see Section 3.6) and DL layers (see Section 3.7).

3.1 Reproducibility

All random state, including utility libraries, scientific libraries, the PyTorch library, and GPU state, is consistent across each run of a Python interpreter execution of the model’s training, evaluation and testing. Results consistency is retained by saving this random state when saving the model, then retrieving and resetting it after loading the model.

The order of mini-batches, and their constituent data can affect the model performance as an aspect of training or the results of validation and testing. This performance inconsistency is addressed by recording the order of all data¹⁰ and tracking the training, validation and test data splits. Not only are mini-batches given in the same order, the ordering in each mini-batch is also preserved. These dataset partitions and their order is saved to the file system so the community has the option of distributing it along with the source code for later experiment duplication.

In addition, the framework also saves the configuration used to recreate the same in memory state along with the model. This duplicates the model structure, parameters, hyper-parameters and all other train-time memory during testing.

3.2 Technology Stack

Each “layer” of the stack builds on more general libraries to reduce the installation footprint based on the needs of each use case. Each library contains the requirements for dependent third-party and lower tier packages. The framework consists of the following libraries (see Figure 1):

- `zensols.util`¹¹: Utility library command line parsing, persistence and a Java

⁴<https://www.tensorflow.org>

⁵<https://pytorch.org>

⁶<https://www.tensorflow.org>

⁷<https://allennlp.org>

⁸<https://github.com/allenai/allennlp/issues/3100>

⁹<https://huggingface.co>

¹⁰Regardless of any user given data pre-processing or shuffling.

¹¹<https://github.com/plandes/util>

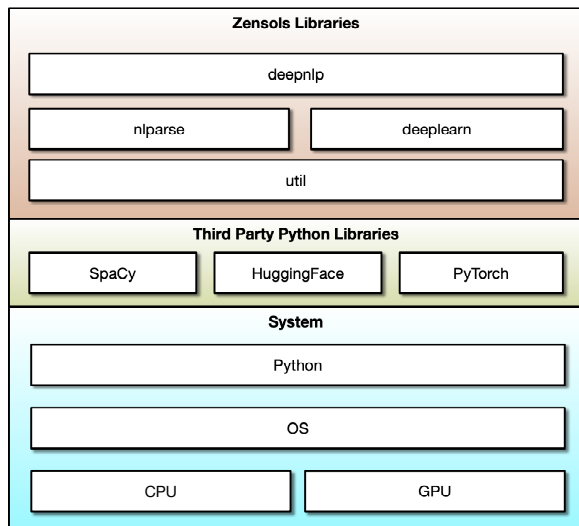

Figure 1: The Python Library Stack

Spring¹² like inversion of control (Mattsson, 1996) configuration system.

- `zensols.nlparse`¹³: Parses natural language text using `spaCy`¹⁴, generates and vectorizes features.
- `zensols.deeplearn`¹⁵: General purpose DL API, much like DeepDIVA, providing mini-batching, vectorization, and training, validation and testing of a model.
- `zensols.deepnlp`¹⁶: Contains language vectorization, such as word embeddings (see Section 3.7), part of speech tags, named entity recognition, and head dependencies (McDonald et al., 2005).

3.3 Execution

The framework provides both a command line and a Jupyter notebook interface to train, test and predict. A “glue” API is used to make a `Python dataclass`¹⁷ class a dynamically generated command line with help usage message documentation. A set of default application classes are available with the framework, but they can be extended to include project specific actions. The default application set provides interactive early stopping or epoch resetting during training.

¹²<https://spring.io>

¹³<https://github.com/plandes/nlparse>

¹⁴<https://spacy.io>

¹⁵<https://github.com/plandes/deeplearn>

¹⁶<https://github.com/plandes/deepnlp>

¹⁷<https://docs.python.org/3/library/dataclasses.html>

The command line and Jupyter notebook both use a common facade interface to the model itself, which is conducive as an entry point to both larger projects or simple run scripts. However, the Jupyter notebook interface provides evaluation training and validation loss plots (see Figure 2).

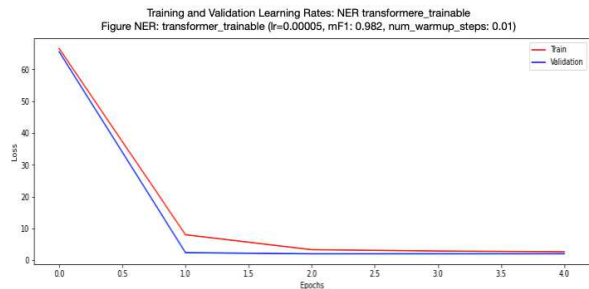

Figure 2: Validation and Training Loss Plot from the NER Token Classification Application

Both interfaces provide a debugging mode that outputs a step of the model training with batch composition, layer names, dimension calculations, using the Python logging system, which is filterable by module or component.

3.4 Vectorization

The DeepZensols framework provides easily configurable components to digitally vectorize data, which in our framework, is encapsulated in a *vectorizer*, which takes a particular input data and outputs a tensor.

The `zensols.deeplearn` library is general purpose with respect to any kind of data, such as: text, images, audio. Examples of data it can vectorize include `Pandas`¹⁸ data frames, enumerated nominal values (typically used for labels), and hot encoded vectors.

The `zensols.deepnlp` library provides a higher abstraction that parses natural language text, sentence chunks, and vectorizes linguistic features. These vectorizers fall into one of the following categories:

token: Features taken from each token, shape congruent with the number of tokens, typically concatenated with the embedding layer include `spaCy` features such as part of speech (POS) tags, named entity recognizer (NER) tags, dependency tree tags and the depth of a token in its head dependency tree.

¹⁸<https://pandas.pydata.org>

document: Features taken from the document level, typically added to a join layer such as count sums of `spaCy` parsed features.

multi-document: Aggregating and shared features between more than one document, such as overlapping POS or NER tags.

embedding: Vectorizes text into word embeddings, such as sentence or document text.

See Section 3.6 for more information on NLP specific feature generation.

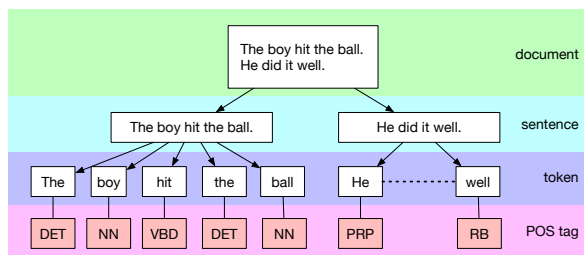

Figure 3: Parse Sentence Chunk and POS Tagged

For example, suppose the following sentences are to be vectorized: “*The boy hit the ball. He did it well.*”. First the `zensols.nlp` library is used to parse, chunk and POS tag the sentence (see Figure 3), then POS tags are converted to one-hot encoded vectors by the `spaCy` feature vectorizer (see Figure 4).

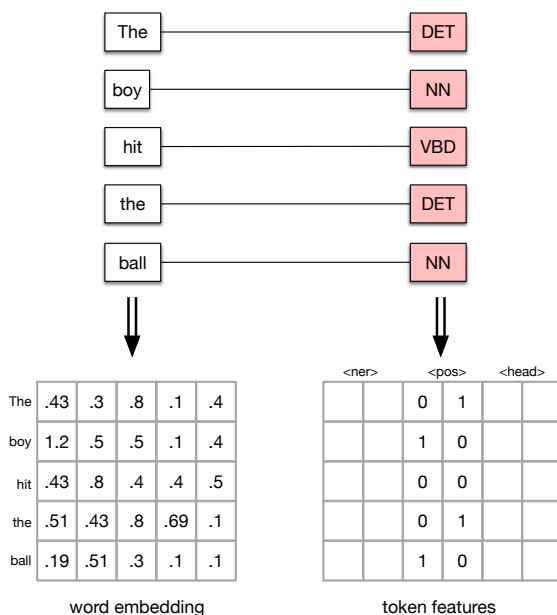

Figure 4: Vectorize Language

3.5 Batching and Persistence

Most NNs expect and perform well using mini-batches (Ioffe and Szegedy, 2015) as input accept or require batched input. A naïve approach to generating these mini-batches would be to re-parse and re-vectorize the data for each mini-batch over each epoch, which is inefficient. Many projects address this inefficiency by pre-processing the data before training. However, this leads to a brittle and difficult to reproduce dataset generated set of ad-hoc text processing scripts that are challenging to re-execute, and thus, reproduce performance metrics.

A cleaner and more efficient method is to wrap this process in the framework and create a file system scheme with the intermediate files in a configured location so as to not clutter the project workspace, which is supported by DeepZensols.

Another desirable feature of any framework is to easily swap in and out feature sets and compare performance metrics, which usually takes the form of the following steps: a) decide which features to use at train time, b) train and evaluate, c) test, d) evaluate performance, e) choose a different feature set, f) go to step a. This incremental process highlights the need to efficiently create mini-batches.

A key observation is that each mini-batch is independent¹⁹. The `zensols.deeplearn` leverages the fact that mini-batches are independent and fit nicely as independent units of work by segmenting datasets into smaller chunks, vectorizing each chunk in parallel sub-processes, and creating one or more batches independently across each sub-processes. This process by which data is written to the file system in a format that is fast to reassemble is called *batch encoding*, and accomplished by:

1. Collecting data needed to vectorize,
2. Chunking data in to equal size parts,
3. Forking processes using the python multiprocessing api,
4. Vectorizing each chunk in each sub-process by:
 - (a) Recreating parent memory by using configuration factory in the `zensols.util` library,

¹⁹There are exceptions for some algorithms that need to index and fit the corpus before vectorization.

- (b) Vectorize each data chunk as separate feature sets,
- (c) Groups the vectorized in to bundles as mini-batches, but in separate files,
- (d) Vectorized data is almost always ready-to-go tensors.

Batch decoding is the process by which data is grouped for training as mini-batches and is accomplished by:

1. Choosing a feature set for a training run,
2. Reassembling features by mini-batch, then feature as a two level directory structure (see Figure 5),
3. Decode each mini-batch in to a tensor, if not unserialized from the file system as a tensor (see Figure 6),
4. Copy tensors to the GPU if available,
5. Cache tensors in CPU or GPU memory²⁰.

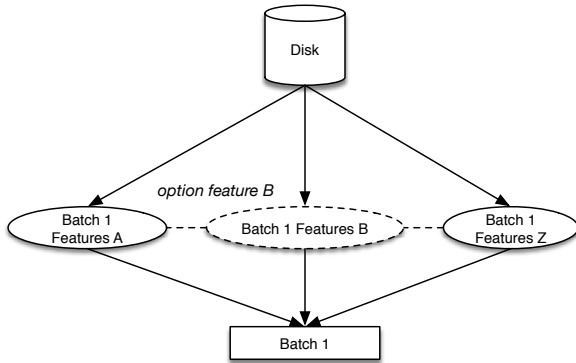

Figure 5: Batch Reassembly Process

Reassembling mini-batches by feature greatly reduces load time and memory space, which speeds up model training and allows for more complex models. This leverage is most apparent when comparing pre-generated frozen large BERT model embeddings for frozen transformers compared to a trainable model. In the case of the former, large data files with output tensors are read back in compared to word piece embeddings (Wu et al., 2016) for a trainable model.

After mini-batch encoding is complete, several feature combinations can be created in configuration, then trained, validated and tested offline. Utility methods exist to aggregate results in tabular form for reporting.

²⁰Cached resources are tracked so GPU memory is maintained.

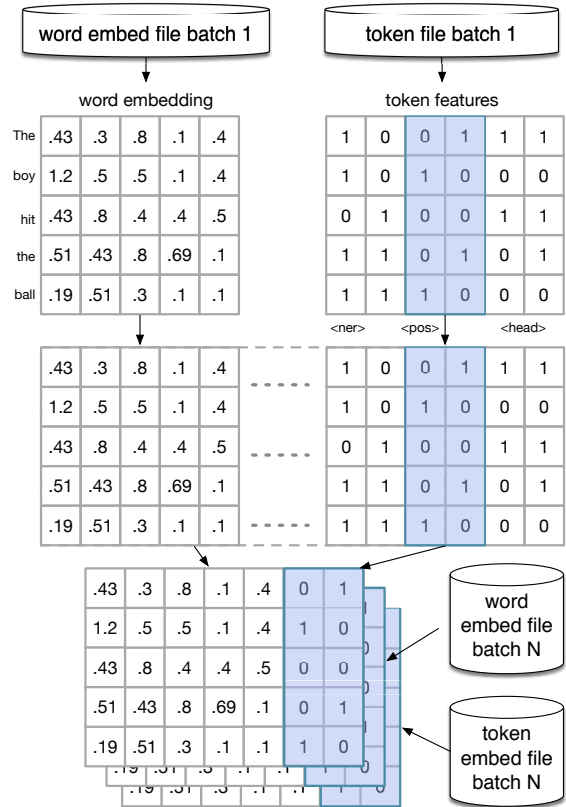

Figure 6: Batch Decode

3.6 Natural Language Features

What sets DeepZensols apart from other frameworks is not only efficient mini-batch creation and feature swapping (Section 3.5), but the tight coupling of natural language features with a deep learning API. Specifically, vectorization of natural language features is at the heart of the utility of the DeepZensols framework, and addresses a need that is otherwise lacking in other APIs.

One such powerful capability is the concatenation of any vectorized data to word embeddings, which is available for both contextual embeddings such as BERT (Devlin et al., 2019) and non-contextual embeddings such as GLoVe (Pennington et al., 2014) (see Section 3.7) for supported word embedding types.

In addition to concatenation of word embeddings, document level features can be added to a join layer (see Figure 7).

3.7 Layers

The framework provides many layer implementations, which extend from the PyTorch Module class, thus any PyTorch module can be

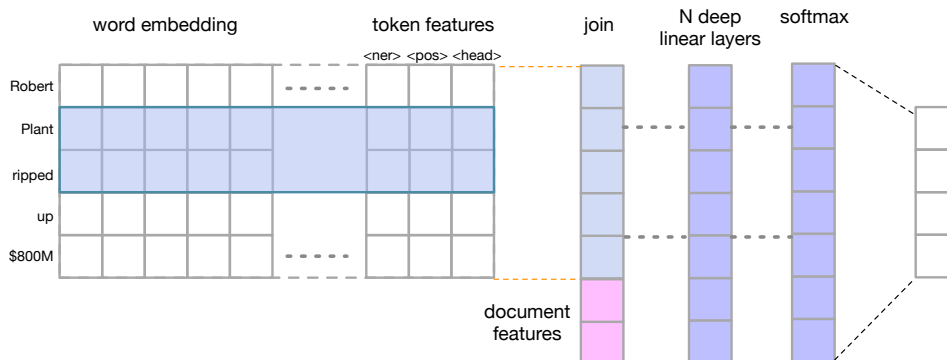

Figure 7: Embedding Concatenation

used in the framework. To this end, it uses layers such as the [pytorch-crf](#)²¹ conditional random field implementation to create an end-to-end model for sequence classification. Layers are configured in memory to offload the construction details to the framework. Other layers provided include, but are not limited to:

- BiLSTM CRF for applications such as sequence tagging ([Huang et al., 2015](#)) as an end-to-end model, which requires no coding with the exception of mapping data input to vectorizers.
- BERT transformer models for sentence and token classification.
- 1D convolution NN that provides calculation for an arbitrarily deep network with input and output dimensionality calculation, pooling, mini-batch ([Ioffe and Szegedy, 2015](#)) centering and activation.
- Expanding or contracting DL feed forward linear networks with repeats with input and output feature calculation.
- Word embedding layer capable of concatenating linguistic features at both the token and document level (see Section 3.4). Supported embeddings include Bert ([Devlin et al., 2019](#)), word2vec ([Mikolov et al., 2013](#)), GLoVe ([Pennington et al., 2014](#)) and FastText ([Bojanowski et al., 2017](#)) (see Section 3.6).
- Document level latent semantic analysis (LSA) ([Deerwester et al., 1990](#)), and term frequency with inverse document frequency weighting ([Sparck Jones, 1972](#)) are also available out of the box with no coding required

HuggingFace transformer features are available as an embeddings vectorizer and document, sentence and token classification are available as layers. In addition a vectorizer is provided to map linguistic features created by spaCy to word piece embeddings ([Wu et al., 2016](#)) for concatenation with the last hidden state of the transformer.

4 Limitations and Future Work

While the framework is thoroughly tested in the areas it was designed for, some work remains to enable more variations in DL architecture for state-of-the-art (SOTA) experimentation.

Any of the [HuggingFace pretrained models](#)²² are available, but only BERT ([Devlin et al., 2019](#)), RoBERTa ([Liu et al., 2019](#)) and DistilBERT ([Sanh et al., 2020](#)) have been tested and next sentence and masking prediction is not yet implemented.

A planned future work is to integrate the framework with TensorFlow's [TensorBoard](#)²³, which provides real-time graphing of metrics such as training and validation loss.

5 Conclusion

The DeepZensols framework has been presented as a viable solution to easily create NLP specific models with APIs and analysis tools to produce consistent results. Such frameworks are not only necessary, but vital in order to ensure the legitimacy of the area of DL in NLP by providing the means necessary to produce reliable reproducible results.

²¹<https://github.com/kmkurn/pytorch-crf>

²²<https://huggingface.co/models>

²³<https://www.tensorflow.org/tensorboard>

References

- Michele Alberti, Vinaychandran Pondenkandath, Marcel Würsch, Rolf Ingold, and Marcus Liwicki. 2018. [DeepDIVA: A Highly-Functional Python Framework for Reproducible Experiments](#). In *2018 16th International Conference on Frontiers in Handwriting Recognition (ICFHR)*, pages 423–428.
- Piotr Bojanowski, Edouard Grave, Armand Joulin, and Tomas Mikolov. 2017. [Enriching Word Vectors with Subword Information](#). *Transactions of the Association for Computational Linguistics*, 5:135–146.
- Scott Deerwester, Susan T. Dumais, George W. Furnas, Thomas K. Landauer, and Richard Harshman. 1990. Indexing by Latent Semantic Analysis. *Journal of the American Society for Information Science; New York, N.Y.*, 41(6):391–407.
- Jacob Devlin, Ming-Wei Chang, Kenton Lee, and Kristina Toutanova. 2019. [BERT: Pre-training of Deep Bidirectional Transformers for Language Understanding](#). In *Proceedings of the 2019 Conference of the North American Chapter of the Association for Computational Linguistics: Human Language Technologies, Volume 1 (Long and Short Papers)*, pages 4171–4186.
- Matt Gardner, Joel Grus, Mark Neumann, Oyvind Tafjord, Pradeep Dasigi, Nelson F. Liu, Matthew E. Peters, Michael Schmitz, and Luke Zettlemoyer. 2018. [AllenNLP: A Deep Semantic Natural Language Processing Platform](#). In *Proceedings of Workshop for NLP Open Source Software (NLP-OSS)*, pages 1–6.
- Megan L. Head, Luke Holman, Rob Lanfear, Andrew T. Kahn, and Michael D. Jennions. 2015. [The Extent and Consequences of P-Hacking in Science](#). *PLoS Biology*, 13(3).
- Zhiheng Huang, Wei Xu, and Kai Yu. 2015. [Bidirectional LSTM-CRF Models for Sequence Tagging](#). arXiv: 1508.01991.
- Matthew Hutson. 2018. [Artificial intelligence faces reproducibility crisis](#). *Science*, 359(6377):725–726.
- Sergey Ioffe and Christian Szegedy. 2015. [Batch Normalization: Accelerating Deep Network Training by Reducing Internal Covariate Shift](#). In *Proceedings of the 32nd International Conference on Machine Learning - Volume 37, ICML'15*, pages 448–456. JMLR.org.
- Yinhan Liu, Myle Ott, Naman Goyal, Jingfei Du, Mandar Joshi, Danqi Chen, Omer Levy, Mike Lewis, Luke Zettlemoyer, and Veselin Stoyanov. 2019. [RoBERTa: A Robustly Optimized BERT Pretraining Approach](#). arXiv: 1907.11692.
- Michael Mattsson. 1996. [Object-Oriented Frameworks](#). masters, Lund University, Ronneby, Sweden.
- Ryan McDonald, Koby Crammer, and Fernando Pereira. 2005. [Online Large-margin Training of Dependency Parsers](#). In *Proceedings of the 43rd Annual Meeting on Association for Computational Linguistics, ACL '05*, pages 91–98. Association for Computational Linguistics.
- Tomas Mikolov, Ilya Sutskever, Kai Chen, Greg S Corrado, and Jeff Dean. 2013. [Distributed Representations of Words and Phrases and their Compositionality](#). In C. J. C. Burges, L. Bottou, M. Welling, Z. Ghahramani, and K. Q. Weinberger, editors, *Advances in Neural Information Processing Systems 26*, pages 3111–3119. Curran Associates, Inc.
- Babatunde K. Olorisade, Pearl Brereton, and Peter Andras. 2017. [Reproducibility in Machine Learning-Based Studies: An Example of Text Mining](#).
- Jeffrey Pennington, Richard Socher, and Christopher Manning. 2014. [Glove: Global Vectors for Word Representation](#). In *Proceedings of the 2014 Conference on Empirical Methods in Natural Language Processing (EMNLP)*, pages 1532–1543. Association for Computational Linguistics.
- Victor Sanh, Lysandre Debut, Julien Chaumond, and Thomas Wolf. 2020. [DistilBERT, a distilled version of BERT: Smaller, faster, cheaper and lighter](#). arXiv: 1910.01108.
- Karen Sparck Jones. 1972. A statistical interpretation of term specificity and its application in retrieval. *Journal of documentation*, 28(1):11–21.
- Rolf Ulrich and Jeff Miller. 2015. [P-hacking by post hoc selection with multiple opportunities: Detectability by skewness test?: Comment on Simonsohn, Nelson, and Simmons \(2014\)](#). *Journal of Experimental Psychology: General*, 144(6):1137–1145.
- Yonghui Wu, Mike Schuster, Zhifeng Chen, Quoc V. Le, Mohammad Norouzi, Wolfgang Macherey, Maxim Krikun, Yuan Cao, Qin Gao, Klaus Macherey, Jeff Klingner, Apurva Shah, Melvin Johnson, Xiaobing Liu, Lukasz Kaiser, Stephan Gouws, Yoshikiyo Kato, Taku Kudo, Hideto Kazawa, Keith Stevens, George Kurian, Nishant Patil, Wei Wang, Cliff Young, Jason Smith, Jason Riesa, Alex Rudnick, Oriol Vinyals, Greg Corrado, Macduff Hughes, and Jeffrey Dean. 2016. [Google’s Neural Machine Translation System: Bridging the Gap between Human and Machine Translation](#). arXiv: 1609.08144.