

Steiner distance matrix of caterpillar graphs

Ali Azimi, R. B. Bapat and Shivani Goel

December 23, 2021

Abstract

For a connected graph $G := (V, E)$, the Steiner distance $d_G(X)$ among a set of vertices X is the minimum size among all the connected subgraphs of G whose vertex set contains X . The k -Steiner distance matrix $D_k(G)$ of G is a matrix whose rows and columns are indexed by k -subsets of V . For k -subsets X_1 and X_2 , the (X_1, X_2) -entry of $D_k(G)$ is $d_G(X_1 \cup X_2)$. In this paper, we show that the rank of 2-Steiner distance matrix of a caterpillar graph on N vertices and with p pendant vertices is $2N - p - 1$.

Keywords. Steiner tree, caterpillar graph, determinant, schur complement, distance matrix, rank of a matrix, Laplacian matrices.

AMS CLASSIFICATION. 05C50

MSC PRIMARY. 05C05, 05C12, 05C50

1 Introduction

Let $G := (V, E)$ be a connected graph with vertex set V and edge set E . Suppose $u, v \in V$. The distance $d(u, v)$ between u and v is the length of the shortest path connecting u and v . The distance $d(u, v)$ can be interpreted as the minimum size of a connected subgraph of G containing both u and v . This insight towards the distance between two vertices gives the motivation to extend the concept of distance between more than two vertices, known as Steiner distance.

Let $X \subseteq V$, containing at least two vertices. The Steiner distance $d_G(X)$ among the vertices of X is the minimum size among all the connected subgraphs of G whose vertex set contains X . We refer to [1] for more details on Steiner distance in graphs. Let $k \geq 2$ be an integer. We define the k -Steiner distance matrix of G , denoted by $D_k(G)$ as follows: The rows and columns of $D_k(G)$ are indexed by k -subsets of V . Let X_1 and X_2 be two k -subsets of V . The (X_1, X_2) -entry of $D_k(G)$ is $d_G(X_1 \cup X_2)$. We illustrate the k -Steiner distance matrix by the following example.

Example 1. Consider the following tree T on 5 vertices. Suppose the rows and columns of $D_2(T)$ are indexed in the following order:

$$\{0, 1\}, \{0, 2\}, \{0, 3\}, \{0, 4\}, \{1, 4\}, \{2, 4\}, \{3, 4\}, \{1, 2\}, \{1, 3\}, \{2, 3\}$$



Figure 1: A tree T on 5 vertices

Then, the 2–Steiner distance matrix of T is

$$D_2(T) = \begin{bmatrix} 1 & 2 & 3 & 4 & 4 & 4 & 4 & 2 & 3 & 3 \\ 2 & 2 & 3 & 4 & 4 & 4 & 4 & 2 & 3 & 3 \\ 3 & 3 & 3 & 4 & 4 & 4 & 4 & 3 & 3 & 3 \\ 4 & 4 & 4 & 4 & 4 & 4 & 4 & 4 & 4 & 4 \\ 4 & 4 & 4 & 4 & 3 & 3 & 3 & 3 & 3 & 3 \\ 4 & 4 & 4 & 4 & 3 & 2 & 2 & 3 & 3 & 2 \\ 4 & 4 & 4 & 4 & 3 & 2 & 1 & 3 & 3 & 2 \\ 2 & 2 & 3 & 4 & 3 & 3 & 3 & 1 & 2 & 2 \\ 3 & 3 & 3 & 4 & 3 & 3 & 3 & 2 & 2 & 2 \\ 3 & 3 & 3 & 4 & 3 & 2 & 2 & 2 & 2 & 1 \end{bmatrix}.$$

Throughout the paper, all vectors are considered as column vectors. For a matrix A and a set of indices X , we will use $A[X, X]$ to denote the submatrix of A determined by the rows and columns indexed by X . The cardinality of a set X is represented by $|X|$. We will use J to denote the matrix of all ones of appropriate order. For a matrix A , $A[i]$ will denote the i^{th} row of A . The notations I and $\mathbf{1}$ will represent the identity matrix and all ones vector of the appropriate order, respectively. The degree of a vertex α in a graph is denoted by $\deg(\alpha)$.

1.1 Objective of the paper

Let G be a connected graph with vertex set $V := \{0, 1, \dots, n\}$. The Laplacian matrix of the graph G is the matrix $L := (l_{ij})$, where

$$l_{ij} := \begin{cases} \delta_i & \text{if } i = j \\ -1 & \text{if } i \text{ and } j \text{ are adjacent} \\ 0 & \text{otherwise.} \end{cases}$$

Here, δ_i is the degree of the vertex i . Let T be a tree with vertex set $\{1, 2, \dots, n\}$ and distance matrix D . Suppose L is the Laplacian of T . In [2], Graham and Lovász, showed that

$$D^{-1} = -\frac{1}{2}L + \frac{1}{2(n-1)}\tau\tau',$$

where $\tau := (2 - \delta_1, \dots, 2 - \delta_n)'$ and δ_i is equal to the degree of the vertex i . In the spirit of Graham and Lovász formula, there are inverse formula for distance matrices of several other connected graphs, see [3], [4], [5], [6] and [7]. We now list the objectives of the paper.

1. Let P_n be a path graph on $n + 1$ vertices $\{0, 1, \dots, n\}$ and let

$$X := \{\{0, \alpha\} \mid \alpha \neq 0\} \cup \{\{\alpha, n\} \mid \deg(\alpha) \neq 1\}.$$

It is easy to note that $|X| = 2n - 1$. Motivated by Graham and Lovász formula, we first show that

$$D_2(P_n)[X, X]^{-1} = -L + \frac{1}{n}uu',$$

where $u := (0, \dots, 0, \underbrace{1}_n, 0, \dots, 0)' \in \mathbb{R}^{2n-1}$ and L is the Laplacian of a path graph on $2n - 1$ vertices.

2. A caterpillar graph is a tree in which all the vertices are within a distance 1 from a central path (see figure 2). Suppose \mathcal{C} is a caterpillar graph with its

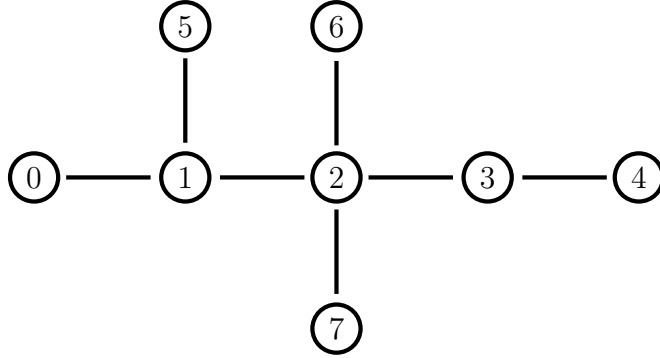

Figure 2: A caterpillar graph

central path of maximum length as P_n . We next show that, if

$$X := \{\{0, \alpha\} \mid \alpha \neq 0\} \cup \{\{\alpha, n\} \mid \deg(\alpha) \neq 1\},$$

then the matrix $D_2(\mathcal{C})[X, X]$ is invertible. In our main result of this paper, we find the rank of $D_2(\mathcal{C})$.

2 Path graphs

Let P_n denotes a path graph on $n + 1$ vertices (see Figure 3). Let $D_2(P_n)$ be the

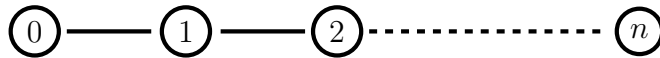

Figure 3: P_n

Steiner distance matrix of P_n and let $X := \{\{0, \alpha\} \mid \alpha \neq 0\} \cup \{\{\alpha, n\} \mid \deg(\alpha) \neq 1\}$. In this section, we will deduce an inverse formula for $D_2(P_n)[X, X]$. The result proved

in this section will be helpful in proving the main result of the paper. Suppose the sets in X are indexed in the following order:

$$\{0, 1\}, \dots, \{0, n\}, \{1, n\}, \dots, \{n-1, n\}.$$

We begin with a few observations on the matrix $D_2(P_n)[X, X]$.

1. Let $X_1 = \{0, \alpha_1\}$, $X_2 = \{0, \alpha_2\}$, $X_3 = \{\alpha_3, n\}$ and $X_4 = \{\alpha_4, n\}$, where $0 < \alpha_1, \alpha_2 \leq n$ and $0 < \alpha_3, \alpha_4 < n$ are pairwise distinct vertices of P_n . It is easy to see that

$$\begin{aligned} d_{P_n}(X_1 \cup X_2) &= \max\{\alpha_1, \alpha_2\}, \\ d_{P_n}(X_3 \cup X_4) &= n - \min\{\alpha_3, \alpha_4\}, \end{aligned}$$

and

$$d_{P_n}(X_1 \cup X_i) = n, \text{ for } i = 3, 4.$$

Using the above observation, the submatrix $D_2(P_n)[X, X]$ of $D_2(P_n)$ can be written in the following block form

$$D_2(P_n)[X, X] = \begin{bmatrix} S_1 & nJ_{n, n-1} \\ nJ_{n-1, n} & S_2 \end{bmatrix},$$

where

$$S_1 := \begin{bmatrix} 1 & 2 & 3 & 4 & \cdots & n \\ 2 & 2 & 3 & 4 & \cdots & n \\ 3 & 3 & 3 & 4 & \cdots & n \\ \cdots & & & & & \\ n & n & n & n & \cdots & n \end{bmatrix} \text{ and } S_2 := \begin{bmatrix} n-1 & n-1 & n-1 & \cdots & n-1 \\ n-1 & n-2 & n-2 & \cdots & n-2 \\ n-1 & n-2 & n-3 & \cdots & n-3 \\ \cdots & & & & \\ n-1 & n-2 & n-3 & \cdots & 1 \end{bmatrix}.$$

2. Using the above block form, we deduce expressions for rows of $D_2(P_n)[X, X]$ as follows. If $1 \leq i \leq n$, then

$$D_2(P_n)[X, X][i] = (\underbrace{i, \dots, i}_i, i+1, i+2, \dots, n, \dots, n), \quad (1)$$

and for $n+1 \leq k \leq 2n-1$

$$D_2(P_n)[X, X][k] = (\underbrace{n, \dots, n}_n, n-1, n-2, \dots, \underbrace{2n-k, \dots, 2n-k}_{2n-k}). \quad (2)$$

In the next two results, we deduce an inverse formula for $D_2(P_n)[X, X]$.

Lemma 1. *Let $D := D_2(P_n)[X, X]$. If L is the Laplacian of a path graph on $2n-1$ vertices, then*

$$LD + I = u\mathbf{1}',$$

where $u := (0, \dots, 0, \underbrace{1}_n, 0, \dots, 0) \in \mathbb{R}^{2n-1}$.

Proof. The Laplacian matrix of a path graph is a tridiagonal matrix with its main diagonal determined by the vector $(1, 2, \dots, 2, 1)$. The first diagonal above and below the main diagonal have all the entries equal to -1 . Using this, we first note that

$$(LD)[1] = D[1] - D[2],$$

$$(LD)[i] = 2D[i] - D[i-1] - D[i+1], \text{ for } 2 \leq i \leq 2n-2$$

and

$$(LD)[2n-1] = D[2n-1] - D[2n-2].$$

We now compute exact expressions for the rows of LD by using (1) and (2), repeatedly. This is done by considering several cases as listed below:

(i) It is easy to see that

$$(LD)[1] = D[1] - D[2] = (-1, 0, \dots, 0).$$

(ii) For $2 \leq i \leq n-1$

$$\begin{aligned} (LD)[i] &= 2D[i] - D[i-1] - D[i+1] \\ &= 2(\underbrace{i, \dots, i}_{i}, i+1, i+2, \dots, n, \dots, n) \\ &\quad - (\underbrace{i-1, \dots, i-1}_{i-1}, i, i+1, i+2, \dots, n, \dots, n) \\ &\quad - (\underbrace{i+1, \dots, i+1}_{i+1}, i+2, \dots, n, \dots, n) \\ &= (0, \dots, 0, \underbrace{-1}_{i}, 0, \dots, 0). \end{aligned}$$

(iii) Next, we note that

$$\begin{aligned} (LD)[n] &= 2D[n] - D[n-1] - D[n+1] \\ &= 2n\mathbf{1}' - (\underbrace{n-1, \dots, n-1}_{n-1}, n, \dots, n) - (\underbrace{n, \dots, n}_n, n-1, \dots, n-1) \\ &= (1, \dots, 1, \underbrace{0}_n, 1, \dots, 1), \end{aligned}$$

and

$$\begin{aligned} (LD)[n+1] &= 2D[n+1] - D[n] - D[n+2] \\ &= 2(\underbrace{n, \dots, n}_n, n-1, \dots, n-1) - n\mathbf{1}' \\ &\quad - (\underbrace{n, \dots, n}_n, n-1, n-2, \dots, n-2) \\ &= (0, \dots, 0, \underbrace{-1}_{n+1}, 0, \dots, 0). \end{aligned}$$

(iv) Let $n + 2 \leq k \leq 2n - 2$. Then

$$\begin{aligned}
(LD)[k] &= 2D[k] - D[k-1] - D[k+1] \\
&= 2(\underbrace{n, \dots, n}_n, n-1, n-2, \dots, \underbrace{2n-k, \dots, 2n-k}_{2n-k}) \\
&\quad - (\underbrace{n, \dots, n}_n, n-1, n-2, \dots, \underbrace{2n-k+1, \dots, 2n-k+1}_{2n-k+1}) \\
&\quad - (\underbrace{n, \dots, n}_n, n-1, n-2, \dots, \underbrace{2n-k-1, \dots, 2n-k-1}_{2n-k-1}) \\
&= (0, \dots, 0, \underbrace{-1}_k, 0, 0, \dots, 0).
\end{aligned}$$

(v) Finally

$$\begin{aligned}
(LD)[2n-1] &= D[2n-1] - D[2n-2] \\
&= (\underbrace{n, \dots, n}_n, n-1, n-2, \dots, 1) - (\underbrace{n, \dots, n}_n, n-1, n-2, \dots, 3, 2, 2) \\
&= (0, \dots, 0, -1).
\end{aligned}$$

From (i), (ii), (iii), (iv) and (v), we note that except the n^{th} row, all other rows of LD are equal to the corresponding rows of the matrix $-I$. Hence $LD + I$ has all other rows except the n^{th} row as zero. Also, the n^{th} row of $LD + I$ is the all one vector. Thus

$$LD + I = u\mathbf{1}',$$

where $u = (0, \dots, 0, \underbrace{1}_n, 0, \dots, 0)'$. This completes the proof. \square

Theorem 1. Let $D = D_2(P_n)[X, X]$ and L be the Laplacian of a path graph on $2n-1$ vertices. Then

$$D^{-1} = -L + \frac{1}{n}uu',$$

where $u = (0, \dots, 0, \underbrace{1}_n, 0, \dots, 0) \in \mathbb{R}^{2n-1}$.

Proof. Since the n^{th} row of D is $n\mathbf{1}'$, it is easy to see that $u'D = n\mathbf{1}'$. Now

$$(-L + \frac{1}{n}uu')D = I - u\mathbf{1}' + \frac{1}{n}uu'D = I.$$

Thus, D is invertible and

$$D^{-1} = -L + \frac{1}{n}uu'.$$

The proof is complete. \square

3 Caterpillar graphs

In this section, we first introduce caterpillar graphs and observe the structure of its 2–Steiner distance matrix. Next, we compute the rank of its 2–Steiner distance matrix by finding an invertible submatrix of maximum size. Let \mathcal{C} be a caterpillar graph and let P_n be a central path of maximum length in \mathcal{C} (see Figure 4). Without

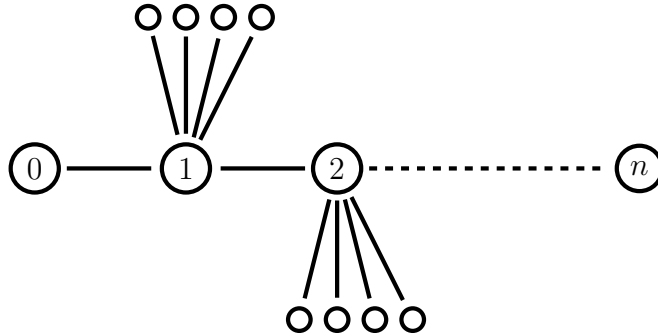

Figure 4: \mathcal{C}

loss of generality, we label the vertices of \mathcal{C} in the following way:

1. The vertices of P_n are labeled from 0 to n .
2. The vertices adjacent to 1 other than that of P_n are labeled from $n+1, \dots, n+i_1$.
3. The vertices adjacent to 2 other than that of P_n are labeled from $n+i_1+1, \dots, n+i_1+i_2$.
4. Continuing like this, the vertices adjacent to $n-1$ other than that of P_n are labeled from $n+\sum_{j=1}^{n-2} i_j+1, \dots, n+\sum_{j=1}^{n-1} i_j$.

In the rest of the paper, we follow the above labelling for caterpillar graphs. We now illustrate the 2–Steiner distance matrix of a caterpillar graph with an example.

Example 2. Consider the caterpillar graph given in Figure 2. Suppose $D_2(\mathcal{C})$ denotes its 2–Steiner distance matrix and let

$$X = \{\{0, 1\}, \{0, 2\}, \{0, 3\}, \{0, 4\}, \{1, 4\}, \{2, 4\}, \{3, 4\}, \{0, 5\}, \{0, 6\}, \{0, 7\}\}.$$

Then

$$D_2(\mathcal{C})[X, X] = \begin{bmatrix} 1 & 2 & 3 & 4 & 4 & 4 & 4 & 2 & 3 & 3 \\ 2 & 2 & 3 & 4 & 4 & 4 & 4 & 3 & 3 & 3 \\ 3 & 3 & 3 & 4 & 4 & 4 & 4 & 4 & 4 & 4 \\ 4 & 4 & 4 & 4 & 4 & 4 & 4 & 5 & 5 & 5 \\ 4 & 4 & 4 & 4 & 3 & 3 & 3 & 5 & 5 & 5 \\ 4 & 4 & 4 & 4 & 3 & 2 & 2 & 5 & 5 & 5 \\ 4 & 4 & 4 & 4 & 3 & 2 & 1 & 5 & 5 & 5 \\ 2 & 3 & 4 & 5 & 5 & 5 & 5 & 2 & 4 & 4 \\ 3 & 3 & 4 & 5 & 5 & 5 & 5 & 4 & 3 & 4 \\ 3 & 3 & 4 & 5 & 5 & 5 & 5 & 4 & 4 & 3 \end{bmatrix}.$$

We observe that the submatrix of $D_2(\mathcal{C})[X, X]$ corresponding to the first 7 rows and columns is equal to the submatrix corresponding to the same rows and columns of the matrix $D_2(T)$ given in Example 1 .

3.1 Block form for $D_2(\mathcal{C})[X, X]$

We recall that $X = \{\{0, j\} \mid j \neq 0\} \cup \{\{j, n\} \mid \deg(j) \neq 1\}$. If we write elements of X in the following order

$$X = \{\{0, 1\}, \dots, \{0, n\}, \{1, n\}, \dots, \{n-1, n\}, \{0, n+1\}, \{0, n+2\}, \dots, \{0, n+\sum_{j=1}^{n-1} i_j\}\},$$

then

- (a) If D is the matrix given in Theorem 1, then D is a principal submatrix of $D_2(\mathcal{C})[X, X]$. In fact, D is the principal submatrix of $D_2(\mathcal{C})[X, X]$ corresponding to the first $2n - 1$ rows and columns.
- (b) Let $X_1 = \{0, \alpha_1\}$ and $X_2 = \{0, \alpha_2\}$ be set of vertices of \mathcal{C} , where $1 \leq \alpha_1 \leq n$ and $\alpha_2 > n$ is adjacent to the vertex α of P_n . We note that

$$d_{\mathcal{C}}(X_1 \cup X_2) = \max\{\alpha_1, \alpha\} + 1.$$

Suppose $X_3 = \{\alpha_3, n\}$, where $1 \leq \alpha_3 \leq n - 1$. Then it is easy to see that

$$d_{\mathcal{C}}(X_3 \cup X_2) = n + 1.$$

Now, let $X_4 = \{0, \alpha_4\}$, where $\alpha_4 > n$ is adjacent to the vertex α' of P_n . Then

$$d_{\mathcal{C}}(X_2 \cup X_4) = \begin{cases} \alpha + 1 & \text{if } \alpha_2 = \alpha_4 \\ \alpha + 2 & \text{if } \alpha_2 \neq \alpha_4 \text{ but } \alpha = \alpha' \\ \max\{\alpha, \alpha'\} + 2 & \text{otherwise.} \end{cases}$$

(c) Using observations (a) and (b), the submatrix $D_2(\mathcal{C})[X, X]$ of $D_2(\mathcal{C})$ can be written in the block form

$$D_2(\mathcal{C})[X, X] = \begin{bmatrix} D & M \\ M' & N \end{bmatrix}, \quad (3)$$

where the matrix M of order $(2n - 1) \times \sum_{j=1}^{n-1} i_j$ and the matrix N of order $\sum_{j=1}^{n-1} i_j \times \sum_{j=1}^{n-1} i_j$ are defined as follows: For $1 \leq m \leq n - 1$

$$M[m] := (m + 1, \dots, m + 1, \underbrace{m + 2, \dots, m + 2}_{i_{m+1}}, \dots, \underbrace{n, \dots, n}_{i_{n-1}}), \quad (4)$$

and for $n \leq m \leq 2n - 1$

$$M[m] := (n + 1)\mathbf{1}'. \quad (5)$$

Before defining N , we note that any column of N consist of the distance between the set $\{0, \alpha\}$, $\alpha > n$ and the sets

$$\{0, n + 1\}, \{0, n + 2\}, \dots, \{0, n + \sum_{j=1}^{n-1} i_j\}.$$

Now, let $1 \leq m \leq \sum_{j=1}^{n-1} i_j$. For convenience, we assume $i_0 = 0$. Then there exists k , $1 \leq k \leq n - 1$ such that $\sum_{j=0}^{k-1} i_j < m \leq \sum_{j=1}^k i_j$. Thus, the matrix N is defined as follows:

$$\begin{aligned} m^{\text{th}} \text{ column of } N &:= (k + 2, \dots, k + 2, \underbrace{k + 1}_{m^{\text{th}}}, k + 2, \dots, k + 2, \underbrace{k + 3, \dots, k + 3}_{i_{k+1}}, \\ &\dots, \underbrace{n + 1, \dots, n + 1}_{i_{n-1}})'. \end{aligned} \quad (6)$$

3.2 Invertibility of $D_2(\mathcal{C})[X, X]$

In this subsection, we show that $D_2(\mathcal{C})[X, X]$ is invertible. This implies $\text{rank}(D_2(\mathcal{C})) \geq |X|$. By Theorem 1, we know that D is invertible and

$$D^{-1} = -L + \frac{1}{n}uu',$$

where L is the Laplacian matrix of a path graph on $2n - 1$ vertices and $u = (0, \dots, 0, \underbrace{1}_n, 0, \dots, 0) \in \mathbb{R}^{2n-1}$. Suppose P denotes the schur complement of D in $D_2(\mathcal{C})[X, X]$. We know that

$$\begin{aligned} P &= N - M'D^{-1}M \\ &= N - M'(-L + \frac{1}{n}uu')M \\ &= N + M'LM - \frac{1}{n}M'uu'M. \end{aligned}$$

Since n^{th} row of M is $(n+1)\mathbf{1}'$, we conclude that

$$u'M = (n+1)\mathbf{1}'.$$

Thus

$$P = N + M'LM - \frac{(n+1)^2}{n}\mathbf{1}\mathbf{1}'. \quad (7)$$

We claim that $D_2(\mathcal{C})[X, X]$ is invertible. Since D is invertible, it is enough to show that P is invertible. In the subsequent lemmas, we compute an exact expression for P .

Lemma 2. *Suppose M is the matrix given in the block form (3) of $D_2(\mathcal{C})[X, X]$ and L is the Laplacian matrix of a path graph on $2n-1$ vertices. Then*

$$(LM)[m] = \begin{cases} (0, \dots, 0, \underbrace{-1, \dots, -1}_{i_m}, 0, \dots, 0) & \text{if } 1 \leq m \leq n-1 \\ (1, \dots, 1) & \text{if } m = n \\ (0, \dots, 0) & \text{otherwise.} \end{cases}$$

Proof. We recall that L is a tridiagonal matrix with its main diagonal determined by the vector $(1, 2, \dots, 2, 1)$ and its first diagonal above and below the main diagonal have all the entries equal to -1 . Using this observation, it is easy to deduce that

$$(LM)[1] = M[1] - M[2],$$

$$(LM)[m] = 2M[m] - M[m-1] - M[m+1], \text{ for } 2 \leq m \leq 2n-2$$

and

$$(LM)[2n-1] = M[2n-1] - [2n-2].$$

Now, we compute LM by repeatedly using (4) and (5) in the following cases.

(i) It is easy to see that

$$(LM)[1] = M[1] - M[2] = \underbrace{(-1, \dots, -1, 0, \dots, 0)}_{i_1}.$$

(ii) Suppose $2 \leq m \leq n-2$. Then

$$\begin{aligned} (LM)[m] &= 2M[m] - M[m-1] - M[m+1] \\ &= 2(m+1, \dots, m+1, \underbrace{m+2, \dots, m+2}_{i_{m+1}}, \dots, \underbrace{n, \dots, n}_{i_{n-1}}) \\ &\quad - (m, \dots, m, \underbrace{m+1, \dots, m+1}_{i_m}, \dots, \underbrace{n, \dots, n}_{i_{n-1}}) \\ &\quad - (m+2, \dots, m+2, \underbrace{m+3, \dots, m+3}_{i_{m+2}}, \dots, \underbrace{n, \dots, n}_{i_{n-1}}) \\ &= (0, \dots, 0, \underbrace{-1, \dots, -1}_{i_m}, 0, \dots, 0). \end{aligned}$$

(iii) Next,

$$\begin{aligned}
(LM)[n-1] &= 2M[n-1] - M[n-2] - M[n] \\
&= 2n\mathbf{1}' - (n-1, \dots, n-1, \underbrace{n, \dots, n}_{i_{n-1}}) - (n+1)\mathbf{1}' \\
&= (0, \dots, 0, \underbrace{-1, \dots, -1}_{i_{n-1}}),
\end{aligned}$$

and

$$\begin{aligned}
(LM)[n] &= 2M[n] - M[n-1] - M[n+1] \\
&= 2(n+1)\mathbf{1}' - n\mathbf{1}' - (n+1)\mathbf{1}' \\
&= \mathbf{1}'.
\end{aligned}$$

(iv) Suppose $n+1 \leq m \leq 2n-2$. Since $M[m] = (n+1)\mathbf{1}'$, we have

$$(LM)[m] = 2M[m] - M[m-1] - M[m+1] = (0, \dots, 0).$$

(v) Finally,

$$(LM)[2n-1] = M[2n-1] - [2n-2] = (0, \dots, 0).$$

From (i), (ii), (iii), (iv) and (v), we deduce

$$(LM)[m] = \begin{cases} (0, \dots, 0, \underbrace{-1, \dots, -1}_{i_m}, 0, \dots, 0) & \text{if } 1 \leq m \leq n-1 \\ (1, \dots, 1) & \text{if } m = n \\ (0, \dots, 0) & \text{otherwise} \end{cases}$$

The proof is complete. \square

Lemma 3. Suppose M is the matrix given in the block form (3) of $D_2(\mathcal{C})[X, X]$ and L is the Laplacian matrix of a path graph on $2n-1$ vertices. If $1 \leq m \leq \sum_{j=1}^{n-1} i_j$ such that $\sum_{j=0}^{k-1} i_j < m \leq \sum_{j=1}^k i_j$, for some $1 \leq k \leq n-1$, then

$$m^{\text{th}} \text{ column of } M'LM = (n-k, \dots, n-k, \underbrace{n-k-1, \dots, n-k-1}_{i_{k+1}}, \dots, \underbrace{1, \dots, 1}_{i_{n-1}})'$$

Proof. Let $1 \leq m \leq \sum_{j=1}^{n-1} i_j$. Then there exists k , $1 \leq k \leq n-1$ such that $\sum_{j=0}^{k-1} i_j < m \leq \sum_{j=1}^k i_j$. Using Lemma 2, (4) and (5), we have

$$\begin{aligned}
m^{\text{th}} \text{ column of } M'LM &= -k^{\text{th}} \text{ column of } M' + n^{\text{th}} \text{ column of } M' \\
&= -M[k]' + M[n]' \\
&= -(k+1, \dots, k+1, \underbrace{k+2, \dots, k+2}_{i_{k+1}}, \dots, \underbrace{n, \dots, n}_{i_{n-1}})' + (n+1)\mathbf{1} \\
&= (n-k, \dots, n-k, \underbrace{n-k-1, \dots, n-k-1}_{i_{k+1}}, \dots, \underbrace{1, \dots, 1}_{i_{n-1}})'.
\end{aligned}$$

This completes the proof. \square

Lemma 4. *Suppose M and N are the matrices given in the block form (3) of $D_2(\mathcal{C})[X, X]$ and L is the Laplacian matrix of a path graph on $2n - 1$ vertices. Then*

$$N + M'LM = (n + 2)J - I.$$

Proof. Let $1 \leq m \leq \sum_{j=1}^{n-1} i_j$. Then there exists k , $1 \leq k \leq n - 1$ such that $\sum_{j=0}^{k-1} i_j < m \leq \sum_{j=1}^k i_j$. Using Lemma 3 and (6), we have

$$\begin{aligned} m^{\text{th}} \text{ column of } (N + M'LM) &= (k + 2, \dots, k + 2, \underbrace{k + 1}_{m^{\text{th}}}, k + 2, \dots, k + 2, \underbrace{k + 3, \dots, k + 3}_{i_{k+1}}, \\ &\quad \dots, \underbrace{n + 1, \dots, n + 1}_{i_{n-1}})' \\ &\quad + (n - k, \dots, n - k, \underbrace{n - k - 1, \dots, n - k - 1}_{i_{k+1}}, \dots, \underbrace{1, \dots, 1}_{i_{n-1}})' \\ &= (n + 2, \dots, n + 2, \underbrace{n + 1}_{m^{\text{th}}}, n + 2, \dots, n + 2)' \\ &= (n + 2)\mathbf{1} - e_m. \end{aligned}$$

Here, $e_m \in \mathbb{R}^{\sum_{j=1}^{n-1} i_j}$ with 1 at its m^{th} position and 0 elsewhere. Thus

$$N + M'LM = (n + 2)J - I,$$

and the proof is complete. \square

In the next theorem, we will prove the main result of this subsection.

Theorem 2. *The matrix $D_2(\mathcal{C})[X, X]$ is invertible.*

Proof. Using Lemma 4 in (7), we have

$$\begin{aligned} P &= (n + 2)J - I - \frac{1}{n}(n + 1)^2J \\ &= -\frac{1}{n}J - I. \end{aligned}$$

Thus P is invertible. Since

$$\det(D_2(\mathcal{C})[X, X]) = \det(D)\det(P),$$

we conclude that $D_2(\mathcal{C})[X, X]$ is invertible. The proof is complete. \square

3.3 Rank of $D_2(\mathcal{C})$

For a distinct pair of vertices $\{k, j\}$, $D_2(\mathcal{C})'[\{k, j\}]$ is the column of $D_2(\mathcal{C})$ which is indexed by $\{k, j\}$. We recall that

$$X = \{\{0, 1\}, \dots, \{0, n\}, \{1, n\}, \dots, \{n-1, n\}, \{0, n+1\}, \{0, n+2\}, \dots, \{0, n + \sum_{j=1}^{n-1} i_j\}\}.$$

We claim that each column of $D_2(\mathcal{C})$ corresponding to sets in X^c is a linear combination of columns of $D_2(\mathcal{C})$ corresponding to the sets in X . This along with Theorem 2 proves that rank of $D_2(\mathcal{C})$ is $|X|$. Before, we begin the proof, we observe the following. Suppose $\{k, j\} \in X^c$. Then, exactly one of the following holds.

- (i) $0 < k, j < n$,
- (ii) $0 < k \leq n$ and $j > n$, or
- (iii) $k, j > n$.

In the subsequent lemmas, we discuss the above cases separately and prove that $D_2(\mathcal{C})'[\{k, j\}]$ is a linear combination of columns of $D_2(\mathcal{C})$ corresponding to the sets in X .

Lemma 5. *Let $\{k, j\} \in X^c$. If $0 < k, j < n$, then*

$$D_2(\mathcal{C})'[\{k, j\}] = D_2(\mathcal{C})'[\{0, j\}] - D_2(\mathcal{C})'[\{0, n\}] + D_2(\mathcal{C})'[(k, n)].$$

Proof. Without loss of generality, we assume $k < j$. Let $\{p, q\}$ be a set of distinct vertices of \mathcal{C} . We discuss the cases $\{p, q\} \in X$ and $\{p, q\} \in X^c$, separately. In the following tables, the entries in each column describes the entry in the $\{p, q\}^{\text{th}}$ row of $D_2(\mathcal{C})'[\{\alpha, \alpha'\}]$, for different α and α' .

1. For $\{p, q\} \in X$, we have the following.

$\{p, q\}$	$D_2(\mathcal{C})'[\{0, j\}]$	$D_2(\mathcal{C})'[\{0, n\}]$	$D_2(\mathcal{C})'[(k, n)]$	$D_2(\mathcal{C})'[\{k, j\}]$
$\{0, l\}, 0 < l \leq n$ (Fig 5)	$\max\{l, j\}$	n	n	$\max\{l, j\}$
$\{l, n\}, 0 < l < n$ (Fig 5)	n	n	$n - \min\{l, k\}$	$n - \min\{l, k\}$
$\{0, l\}, l > n$ (Fig 6)	$\max\{i, j\} + 1$	$n + 1$	$n + 1$	$\max\{i, j\} + 1$



Figure 5

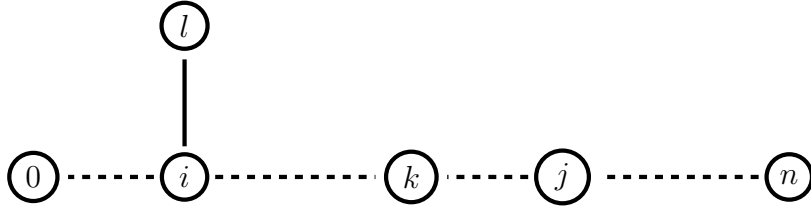

Figure 6

2. Suppose $\{p, q\} \in X^c$. Without loss of generality, we assume $p < q$. Now, the following holds.

$\{p, q\}$	$D_2(\mathcal{C})'[\{0, j\}]$	$D_2(\mathcal{C})'[\{0, n\}]$	$D_2(\mathcal{C})'[(k, n)]$	$D_2(\mathcal{C})'[\{k, j\}]$
$0 < p, q < n$ (Fig 7)	$\max\{q, j\}$	n	$n - \min\{p, k\}$	$\max\{q, j\} - \min\{p, k\}$
$0 < p \leq n, q > n$ (Fig 8)	$\max\{p, i, j\} + 1$	$n + 1$	$n - \min\{p, i, k\} + 1$	$\max\{p, i, j\} - \min\{p, i, k\} + 1$
$p, q > n$ (Fig 9)	$\max\{i, j\} + 2$	$n + 2$	$n - \min\{i', k\} + 2$	$\max\{i, j\} - \min\{i', k\} + 2$



Figure 7

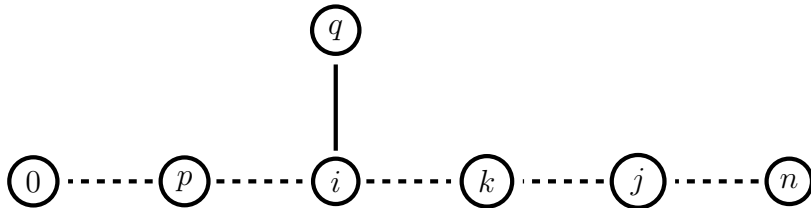

Figure 8

From Case 1 and 2, we conclude that

$$D_2(\mathcal{C})'[\{k, j\}] = D_2(\mathcal{C})'[\{0, j\}] - D_2(\mathcal{C})'[\{0, n\}] + D_2(\mathcal{C})'[(k, n)].$$

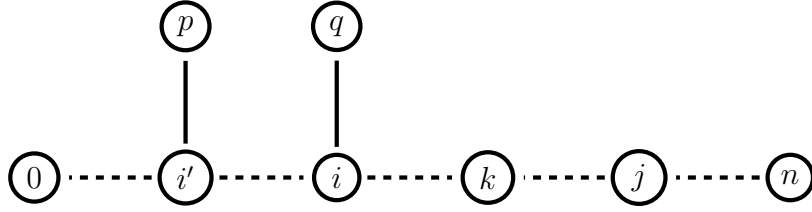

Figure 9

The proof is complete. □

Lemma 6. Let $\{k, j\} \in X^c$. Suppose $0 < k \leq n$, $j > n$ and j is adjacent to vertex i of P_n . If $k < i$, then

$$D_2(\mathcal{C})'[\{k, j\}] = D_2(\mathcal{C})'[\{0, j\}] - D_2(\mathcal{C})'[\{0, n\}] + D_2(\mathcal{C})'[(k, n)].$$

Proof. Without loss of generality we assume $k < j$. We consider the following two cases.

1. Suppose $\{p, q\} \in X$. Then

$\{p, q\}$	$D_2(\mathcal{C})'[\{0, j\}]$	$D_2(\mathcal{C})'[\{0, n\}]$	$D_2(\mathcal{C})'[(k, n)]$	$D_2(\mathcal{C})'[\{k, j\}]$
$\{0, l\}, 0 < l \leq n$ (Fig 10)	$\max\{l, i\} + 1$	n	n	$\max\{l, i\} + 1$
$\{l, n\}, 0 < l < n$ (Fig 10)	$n + 1$	n	$n - \min\{l, k\}$	$n - \min\{l, k\} + 1$
$\{0, l\}, l > n$ (Fig 11)	$\max\{l', i\} + \{l, j\} $	$n + 1$	$n + 1$	$\max\{l', i\} + \{l, j\} $

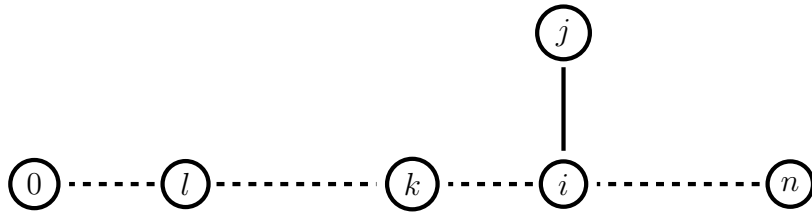

Figure 10

2. Suppose $\{p, q\} \in X^c$. Without loss of generality we assume $p < q$. Now,

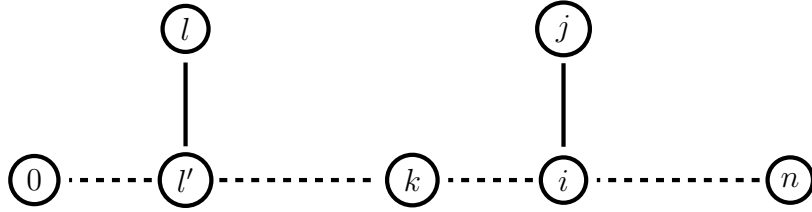

Figure 11

$\{p, q\}$	$D_2(\mathcal{C}')[\{0, j\}]$	$D_2(\mathcal{C}')[\{0, n\}]$	$D_2(\mathcal{C}')[(k, n)]$	$D_2(\mathcal{C}')[\{k, j\}]$
$0 < p, q < n$ (Fig 12)	$\max\{q, i\} + 1$	n	$n - \min\{p, k\}$	$\max\{q, i\} - \min\{p, k\} + 1$
$0 < p \leq n, q > n$ (Fig 13)	$\max\{p, q', i\} + \{q, j\} $	$n + 1$	$n - \min\{p, q', k\} + 1$	$\max\{p, q', i\} - \min\{p, q', k\} + \{q, j\} $
$p, q > n$ (Fig 14)	$\max\{q', i\} + \{p, q, j\} $	$n + 2$	$n - \min\{p', k\} + 2$	$\max\{q', i\} - \min\{p', k\} + \{p, q, j\} $

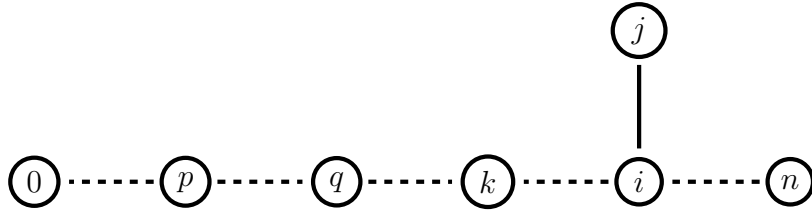

Figure 12

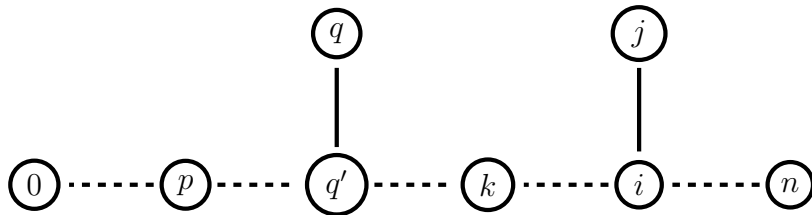

Figure 13

From Case 1 and 2, we conclude that

$$D_2(\mathcal{C}')[\{k, j\}] = D_2(\mathcal{C}')[\{0, j\}] - D_2(\mathcal{C}')[\{0, n\}] + D_2(\mathcal{C}')[(k, n)].$$

This completes the proof. □

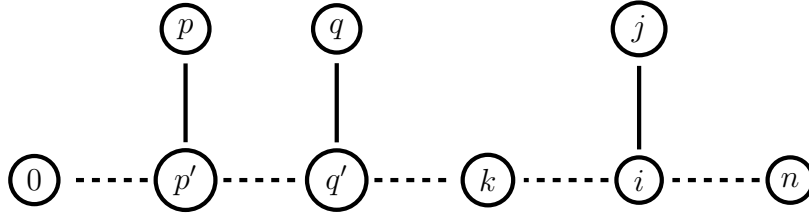

Figure 14

Lemma 7. Let $\{k, j\} \in X^c$. Suppose $0 < k \leq n$, $j > n$ and j is adjacent to vertex i of P_n . If $k \geq i$, then

$$D_2(\mathcal{C})'[\{k, j\}] = D_2(\mathcal{C})'[\{0, j\}] - D_2(\mathcal{C})'[\{0, n\}] + D_2(\mathcal{C})'[\{i, n\}] \\ + D_2(\mathcal{C})'[\{0, k\}] - D_2(\mathcal{C})'[\{0, i\}].$$

Proof. Without loss of generality, we assume $k < j$. We consider the following two cases.

1. Suppose $\{p, q\} \in X$. We compute the following.

$\{p, q\}$	$D_2(\mathcal{C})'[\{0, j\}]$	$D_2(\mathcal{C})'[\{0, n\}]$	$D_2(\mathcal{C})'[\{i, n\}]$	$D_2(\mathcal{C})'[\{0, k\}]$
$\{0, l\}$, $0 < l \leq n$ (Fig 15)	$\max\{l, i\} + 1$	n	n	$\max\{l, k\}$
$\{l, n\}$, $0 < l < n$ (Fig 15)	$n + 1$	n	$n - \min\{l, i\}$	n
$\{0, l\}$, $l > n$ (Fig 16)	$\max\{l', i\} + \{l, j\} $	$n + 1$	$n + 1$	$\max\{l', k\} + 1$

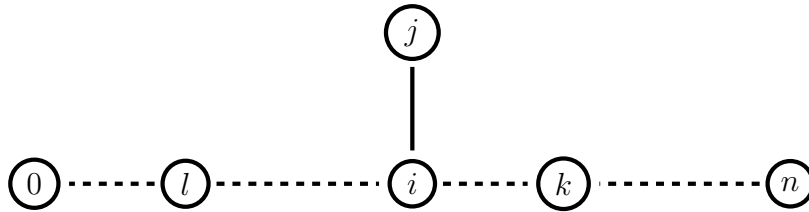

Figure 15

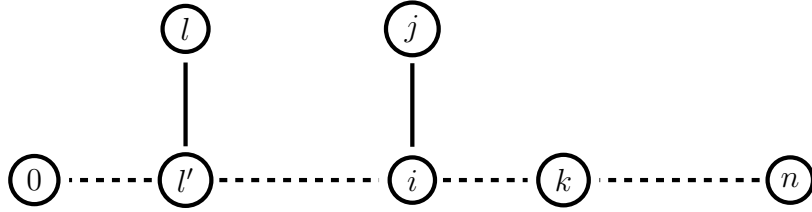

Figure 16

$\{p, q\}$	$D_2(\mathcal{C})'[\{0, i\}]$	$D_2(\mathcal{C})'[\{k, j\}]$
$\{0, l\}, 0 < l \leq n$ (Fig 15)	$\max\{l, i\}$	$\max\{l, k\} + 1$
$\{l, n\}, 0 < l < n$ (Fig 15)	n	$n - \min\{l, i\} + 1$
$\{0, l\}, l > n$ (Fig 16)	$\max\{l', i\} + 1$	$\max\{l', k\} + \{l, j\} $

2. Suppose $\{p, q\} \in X^c$. Without loss of generality, we assume $p < q$. So, we have

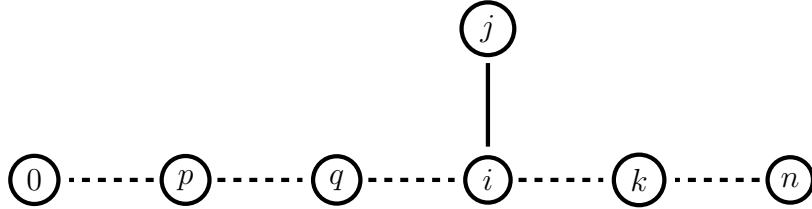

Figure 17

$\{p, q\}$	$D_2(\mathcal{C})'[\{0, j\}]$	$D_2(\mathcal{C})'[\{0, n\}]$	$D_2(\mathcal{C})'[\{i, n\}]$	$D_2(\mathcal{C})'[\{0, k\}]$
$0 < p, q < n$ (Fig 17)	$\max\{q, i\} + 1$	n	$n - \min\{p, i\}$	$\max\{q, k\}$
$0 < p \leq n, q > n$ (Fig 18)	$\max\{p, q', i\} + \{q, j\} $	$n + 1$	$n - \min\{p, q', i\} + 1$	$\max\{p, q', k\} + 1$
$p, q > n$ (Fig 19)	$\max\{q', i\} + \{p, q, j\} $	$n + 2$	$n - \min\{p', i\} + 2$	$\max\{q', k\} + 2$

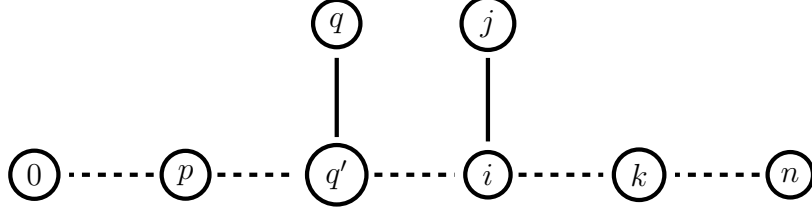

Figure 18

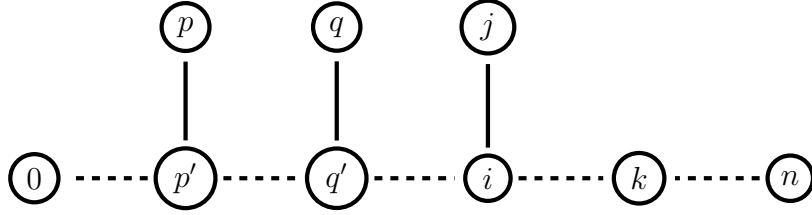

Figure 19

$\{p, q\}$	$D_2(\mathcal{C})'[\{0, i\}]$	$D_2(\mathcal{C})'[\{k, j\}]$
$0 < p, q < n$ (Fig 17)	$\max\{q, i\}$	$\max\{q, k\} - \min\{p, i\} + 1$
$0 < p \leq n, q > n$ (Fig 18)	$\max\{p, q', i\} + 1$	$\max\{p, q', k\} - \min\{p, q', i\} + \{q, j\} $
$p, q > n$ (Fig 19)	$\max\{q', i\} + 2$	$\max\{q', k\} - \min\{p', i\} + \{p, q, j\} $

From Case 1 and 2, we conclude that

$$D_2(\mathcal{C})'[\{k, j\}] = D_2(\mathcal{C})'[\{0, j\}] - D_2(\mathcal{C})'[\{0, n\}] + D_2(\mathcal{C})'[\{i, n\}] \\ + D_2(\mathcal{C})'[\{0, k\}] - D_2(\mathcal{C})'[\{0, i\}].$$

The proof is complete. \square

Lemma 8. Let $\{k, j\} \in X^c$. Suppose $k, j > n$. If j is adjacent to vertex i of P_n and k is adjacent to vertex k' of P_n , then

$$D_2(\mathcal{C})'[\{k, j\}] = D_2(\mathcal{C})'[\{0, j\}] - D_2(\mathcal{C})'[\{0, n\}] + D_2(\mathcal{C})'[\{k', n\}] \\ + D_2(\mathcal{C})'[\{0, k\}] - D_2(\mathcal{C})'[\{0, k'\}].$$

Proof. Without loss of generality, we assume $k < j$. We consider the following two cases.

1. If $\{p, q\} \in X$, then

$\{p, q\}$	$D_2(\mathcal{C})'[\{0, j\}]$	$D_2(\mathcal{C})'[\{0, n\}]$	$D_2(\mathcal{C})'[\{k', n\}]$	$D_2(\mathcal{C})'[\{0, k\}]$
$\{0, l\}, 0 < l \leq n$ (Fig 20)	$\max\{l, i\} + 1$	n	n	$\max\{l, k'\} + 1$
$\{l, n\}, 0 < l < n$ (Fig 20)	$n + 1$	n	$n - \min\{l, k'\}$	$n + 1$
$\{0, l\}, l > n$ (Fig 21)	$\max\{l', i\} + \{l, j\} $	$n + 1$	$n + 1$	$\max\{l', k'\} + \{l, k\} $

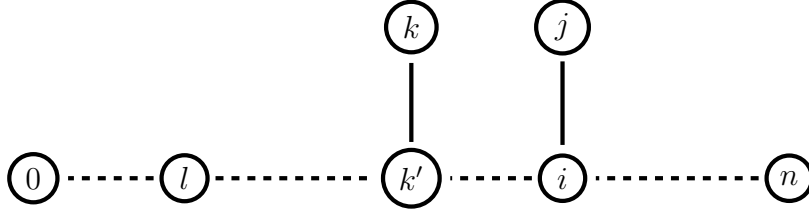

Figure 20

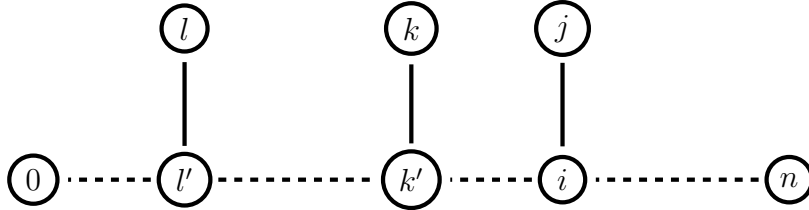

Figure 21

$\{p, q\}$	$D_2(\mathcal{C})'[(0, k')]$	$D_2(\mathcal{C})'[\{k, j\}]$
$\{0, l\}, 0 < l \leq n$ (Fig 20)	$\max\{l, k'\}$	$\max\{l, i\} + 2$
$\{l, n\}, 0 < l < n$ (Fig 20)	n	$n - \min\{l, k'\} + 2$
$\{0, l\}, l > n$ (Fig 21)	$\max\{l', k'\} + 1$	$\max\{l', i\} + \{l, j, k\} $

Here, we observe the fact that $|\{l, j\}| + |\{l, k\}| - 1 = |\{l, j, k\}|$.

- Suppose $\{p, q\} \in X^c$. Without loss of generality, we assume $p < q$. Now, we have

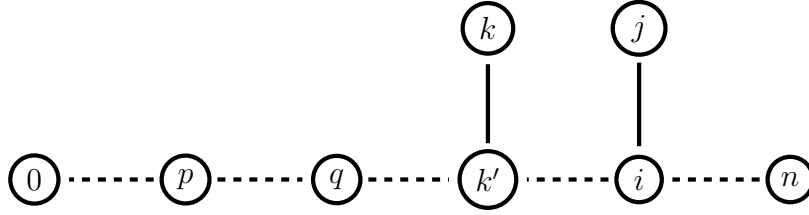

Figure 22

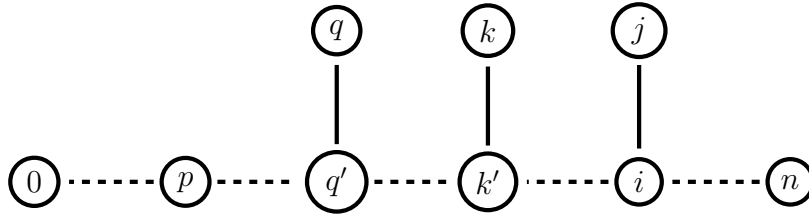

Figure 23

$\{p, q\}$	$D_2(\mathcal{C})'[\{0, j\}]$	$D_2(\mathcal{C})'[\{0, n\}]$	$D_2(\mathcal{C})'[\{k', n\}]$	$D_2(\mathcal{C})'[\{0, k\}]$
$0 < p, q < n$ (Fig 22)	$\max\{q, i\} + 1$	n	$n - \min\{p, k'\}$	$\max\{q, k'\} + 1$
$0 < p \leq n, q > n$ (Fig 23)	$\max\{p, q', i\} + \{q, j\} $	$n + 1$	$n - \min\{p, q', k'\} + 1$	$\max\{p, q', k'\} + \{q, k\} $
$p, q > n$ (Fig 24)	$\max\{q', i\} + \{p, q, j\} $	$n + 2$	$n - \min\{p', k'\} + 2$	$\max\{q', k'\} + \{p, q, k\} $

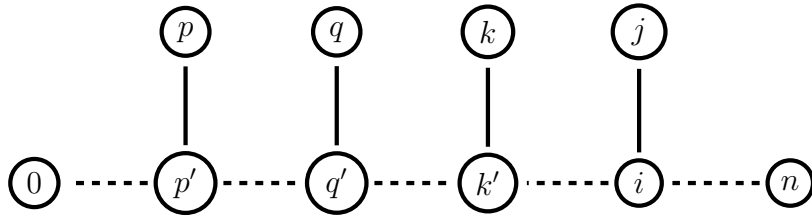

Figure 24

$\{p, q\}$	$D_2(\mathcal{C})'[(0, k')]$	$D_2(\mathcal{C})'[\{k, j\}]$
$0 < p, q < n$ (Fig 22)	$\max\{q, k'\}$	$\max\{q, i\} - \min\{p, k'\} + 2$
$0 < p \leq n, q > n$ (Fig 23)	$\max\{p, q', k'\} + 1$	$\max\{p, q', i\} - \min\{p, q', k'\} + \{q, j, k\} $
$p, q > n$ (Fig 24)	$\max\{q', k'\} + 2$	$\max\{q', i\} - \min\{p', k'\} + \{p, q, j, k\} $

Here, we note that $|\{q, j\}| + |\{q, k\}| - 1 = |\{q, j, k\}|$ and $|\{p, q, j\}| + |\{p, q, k\}| - 2 = |\{p, q, j, k\}|$.

From Case 1 and 2, we conclude that

$$D_2(\mathcal{C})'[\{k, j\}] = D_2(\mathcal{C})'[\{0, j\}] - D_2(\mathcal{C})'[\{0, n\}] + D_2(\mathcal{C})'[\{k', n\}] + D_2(\mathcal{C})'[\{0, k\}] - D_2(\mathcal{C})'[(0, k')].$$

The proof is complete. \square

Now, we state and prove the main result of this paper.

Theorem 3. *Let \mathcal{C} be a caterpillar graph on N vertices and let $D_2(\mathcal{C})$ be its 2-Steiner distance matrix. Then*

$$\text{rank}(D_2(\mathcal{C})) = 2N - p - 1,$$

where p denotes the number of pendant vertices of \mathcal{C} .

Proof. Suppose \mathcal{C} is labelled as described in Figure 4. Using Lemma 5-8, we conclude that

$$\text{rank}(D_2(\mathcal{C})) = 2n - 1 + \sum_{j=1}^{n-1} i_j,$$

Since

$$\begin{aligned} 2N - p - 1 &= 2(n + 1 + \sum_{j=1}^{n-1} i_j) - (\sum_{j=1}^{n-1} i_j + 2) - 1 \\ &= 2n - 1 + \sum_{j=1}^{n-1} i_j, \end{aligned}$$

the proof is complete. □

We conclude this paper with the following open problem.

Open Problem: If T is a general tree on n vertices, find $\text{rank}(D_2(T))$.

Acknowledgement

The second author acknowledges the support of the Indian National Science Academy under the INSA Senior Scientist scheme.

References

- [1] Y. Mao, Steiner distance in graphs—a survey (2017). [arXiv:1708.05779](https://arxiv.org/abs/1708.05779).
- [2] R. Graham, L. Lovász, Distance matrix polynomials of trees, *Advances in Mathematics* 29 (1) (1978) 60–88. [doi:10.1016/0001-8708\(78\)90005-1](https://doi.org/10.1016/0001-8708(78)90005-1).
- [3] R. Bapat, S. Kirkland, M. Neumann, On distance matrices and laplacians, *Linear Algebra and its Applications* 401 (2005) 193–209. [doi:10.1016/j.laa.2004.05.011](https://doi.org/10.1016/j.laa.2004.05.011).
- [4] R. Bapat, S. Sivasubramanian, Inverse of the distance matrix of a block graph, *Linear and Multilinear Algebra* 59 (12) (2011) 1393–1397. [doi:10.1080/03081087.2011.557374](https://doi.org/10.1080/03081087.2011.557374).

- [5] R. Balaji, R. Bapat, S. Goel, An inverse formula for the distance matrix of a wheel graph with an even number of vertices, *Linear Algebra and its Applications* 610 (2021) 274 – 292. doi:<https://doi.org/10.1016/j.laa.2020.10.003>.
- [6] R. Balaji, R. B. Bapat, S. Goel, On distance matrices of wheel graphs with an odd number of vertices, *Linear and Multilinear Algebra* (2020) 1–32doi:10.1080/03081087.2020.1840499.
- [7] S. Goel, On distance matrices of helm graphs obtained from wheel graphs with an even number of vertices, *Linear Algebra and its Applications* 621 (2021) 86–104. doi:<https://doi.org/10.1016/j.laa.2021.03.008>.

Ali Azimi

Department of Mathematics, University of Neyshabur, Neyshabur, Iran
E-mail address: ali.azimi61@gmail.com

R.B. Bapat

Theoretical Statistics and Mathematics Unit, Indian Statistical Institute, Delhi, India
E-mail address: rbb@isid.ac.in

Shivani Goel

Department of Mathematics, IISc Bangalore, Bangalore, India.
E-mail address: shivani.goel.maths@gmail.com