

Critical Droplets and sharp asymptotics for Kawasaki dynamics with strongly anisotropic interactions

Simone Baldassarri ^{1,a} and Francesca R. Nardi ^{2,a,b}

^aDipartimento di Matematica e Informatica “Ulisse Dini”, Università degli Studi di Firenze, Firenze, Italy.

^bDepartment of Mathematics and Computer Science, Eindhoven University of Technology, Eindhoven, the Netherlands.

¹simone.baldassarri@unifi.it, ²francescaromana.nardi@unifi.it,

Abstract

In this paper we analyze metastability and nucleation in the context of the Kawasaki dynamics for the two-dimensional Ising lattice gas at very low temperature with periodic boundary conditions. Let $\beta > 0$ be the inverse temperature and let $\Lambda \subset \Lambda^\beta \subset \mathbb{Z}^2$ be two boxes. We consider the asymptotic regime corresponding to the limit as $\beta \rightarrow \infty$ for finite volume Λ and $\lim_{\beta \rightarrow \infty} \frac{1}{\beta} \log |\Lambda^\beta| = \infty$. We study the simplified model, in which particles perform independent random walks on $\Lambda^\beta \setminus \Lambda$ and inside Λ particles perform simple exclusion, but when they occupy neighboring sites they feel a binding energy $-U_1 < 0$ in the horizontal direction and $-U_2 < 0$ in the vertical one. Thus the Kawasaki dynamics is conservative inside the volume Λ^β . The initial configuration is chosen such that Λ is empty and $\rho|\Lambda^\beta|$ particles are distributed randomly over $\Lambda^\beta \setminus \Lambda$. Our results will use a deep analysis of a local model, i.e., particles perform Kawasaki dynamics inside Λ and along each bond touching the boundary of Λ from the outside to the inside, particles are created with rate $\rho = e^{-\Delta\beta}$, while along each bond from the inside to the outside, particles are annihilated with rate 1, where $\Delta > 0$ is an activity parameter. Thus, in the local model the boundary of Λ plays the role of an infinite gas reservoir with density ρ . We take $\Delta \in (U_1, U_1 + U_2)$, so that the empty (respectively full) configuration is a metastable (respectively stable) configuration. We investigate how the transition from empty to full takes place in the local model with particular attention to the critical configurations that asymptotically have to be crossed with probability 1. The derivation of some geometrical properties of the saddles allows us to identify the full geometry of the minimal gates and their boundaries for the nucleation in the strongly anisotropic case ($U_1 > 2U_2$). We observe very different behaviors for this case with respect to the isotropic ($U_1 = U_2$) and weakly anisotropic ($U_1 < 2U_2$) ones. Moreover, we derive mixing time, spectral gap and sharp estimates for the asymptotic transition time for the strongly anisotropic case.

AMS 2020 subject classifications. 60J10; 60K35; 82C20; 82C22; 82C26

Key words and phrases. Lattice gas, Kawasaki dynamics, metastability, critical droplet, large deviations, pathwise approach, potential theory.

Acknowledgment. F.R.N. was partially supported by the Netherlands Organisation for Scientific Research (NWO) [Gravitation Grant number 024.002.003–NETWORKS]. This work was supported by the “Gruppo Nazionale per l’Analisi Matematica e le loro Applicazioni” (GNAMPA-INdAM).

Contents

1	Introduction	2
2	Definition of the model	7
2.1	The model with open boundary conditions	7
2.2	Local Kawasaki dynamics	7
2.3	The model with periodic boundary conditions and its simplified version	8
3	Model-independent definitions and notations	10
4	Main results: the gates for the local model	12
4.1	Geometric definitions for Kawasaki dynamics	12
4.2	Gate for strongly anisotropic interactions	16
4.3	Main results: sharp asymptotics for strongly anisotropic interactions	19
5	Main results for the simplified model	21
6	Useful model-dependent definitions and tools	21
6.1	Geometric description of the protocritical droplets	22
6.2	Definitions	26
6.3	Useful lemmas for the gates	27
6.4	Model-dependent strategy	28
6.4.1	Main Propositions	29
6.4.2	Useful Lemmas for the model-dependent strategy	30
6.4.3	Proof of Propositions	31
6.4.4	Proof of Lemmas	32
7	Proof of the main results: strongly anisotropic case	34
7.1	Proof of the main Theorem 4.8	34
7.2	Proof of the main Theorem 4.10	37
8	Proof of the sharp asymptotics	41
8.1	Application of the potential theory to the strongly anisotropic case	41
8.2	Proof of Theorem 4.11	42
8.2.1	Lower bound	42
8.2.2	Upper bound	45
8.3	Proof of Theorem 4.14	47
9	Proof of the main results for the simplified model	48

1 Introduction

Metastability is a dynamical phenomenon that occurs when a thermodynamic system is close to a first order phase transition, that takes place when some physical parameter such as the temperature, pressure or magnetic field abruptly changes. The phenomenon of metastability is characterized by the tendency of the system to remain for a long time in a state (the metastable state m) different from the stable states \mathcal{X}^s . Moreover, the system leaves this apparent equilibrium at some random time performing a sudden transition to the stable state. This transition

is called *metastability* or *metastable behavior*. In the study of metastability there are three main issues that are typically investigated. The first one is the study of the *typical transition time* from the metastable to the stable state. The second and third issues, that are physically more interesting, concern the geometrical description of the *gate configurations* (also called *critical configurations*) and the *tube of typical trajectories*, that we will discuss in the sequel. A central role in these descriptions is played by the *optimal paths*, i.e., the set of paths realizing the minimal value among all the paths going from m to \mathcal{X}^s of the maximal energy reached in a single path. A basic notion for the second issue is the set of *saddles* $\mathcal{S}(m, \mathcal{X}^s)$ defined as the set of all maxima in the optimal paths between m and \mathcal{X}^s . Since we want to focus on the subsets of saddles that are typically visited during the last excursion from m to \mathcal{X}^s , we introduce the *gates* $\mathcal{W}(m, \mathcal{X}^s)$ from m to \mathcal{X}^s , defined as the subsets of $\mathcal{S}(m, \mathcal{X}^s)$ that are visited by all the optimal paths. The process, while performing the transition, is likely (with probability that tends to 1 in the chosen asymptotic regime) to follow a subset of the optimal paths. Therefore, gates are subsets of $\mathcal{S}(m, \mathcal{X}^s)$ that are typically visited during the transition. A *minimal gate* has the physical meaning of “critical configurations” and it is defined as a gate such that removing any configuration from it, the new set has not the gate property. In [45, Theorem 5.1] there is a characterization of the set $\mathcal{G}(m, \mathcal{X}^s) \subset \mathcal{S}(m, \mathcal{X}^s)$, defined as the union of minimal gates (see (3.13)), in terms of *essential saddles* (see Section 3 point 4 for the definition of essential saddle). These are defined as the configurations in $\mathcal{S}(m, \mathcal{X}^s)$ that cannot be avoided with a short-cut of an optimal path (where a short-cut of a path ω is a path ω' whose set of maxima is a subset of the set of maxima in ω). The third issue, the so-called tube of typical trajectories, is the set of typical paths followed by the system during the transition from the metastable to the stable state. We note that the hypotheses needed to discuss the gates are weaker than the ones necessary to completely characterize the tube of typical paths. The geometrical characterization of the union of minimal gates $\mathcal{G}(m, \mathcal{X}^s)$ is a central issue both from a probabilistic and from a physical point of view and it is a crucial point in the description of the typical trajectories. Metastability is an ubiquitous phenomenon with many examples from physical systems such as supersaturated vapour, superheated and supercooled water, magnetic hysteresis loop, and from wireless networks. We remark that in several models proposed to describe ferromagnetic systems and analyze in the literature in the context of F-W Markov chains evolving under Glauber dynamics, the minimal gate was unique but, in general, there may exist many minimal sets with the gate property, either distinct or overlapping. To model mathematically phenomena such as superheated or supercooled water is often proposed the use of lattice gas models evolving according to Kawasaki dynamics since the dynamics conserves the number of particles.

In this paper we consider the metastable behavior of the two-dimensional Ising lattice gas with strongly anisotropic interactions at very low temperature and low density that evolves under Kawasaki dynamics, i.e., a discrete time Markov chain defined by the Metropolis algorithm with transition probabilities given in (2.9). Let $\beta > 0$ be the inverse temperature and let $\Lambda \subset \Lambda^\beta \subset \mathbb{Z}^2$ be two boxes. We consider periodic boundary conditions and we fix the density ρ of particles in Λ^β such that $\lim_{\beta \rightarrow \infty} \frac{1}{\beta} \log |\Lambda^\beta| = \infty$. Particles live and evolve in a conservative way in Λ^β , but when they occupy neighboring sites they feel a binding energy $-U_1 < 0$ in the horizontal direction and $-U_2 < 0$ in the vertical one. Without loss of generality we may assume $U_1 \geq U_2$. Unfortunately, we are unable to handle this model. Thus we consider a simplified model (see Section 2.3 for more details) obtained by removing the interactions outside $\Lambda \setminus \partial^- \Lambda$ and the exclusion outside Λ , i.e., the dynamics of the gas in $\Lambda^\beta \setminus \Lambda$ is that of independent random walks.

For this simplified model, our goal is to identify the full geometry of the union of the minimal gates for the strongly anisotropic case together with the characterization of a gate, the estimate in probability of the transition time from the metastable to the stable state and the

description of the subcritical and supercritical rectangles (see Theorem 5.1). In order to obtain these results, we rely on the study of the local version of the model inside the box Λ with open boundary conditions (see Section 2.1 for more details). In particular, along each bond touching the boundary of Λ from the outside to the inside, particles are created with rate $\rho = e^{-\Delta\beta}$, while along each bond from the inside to the outside, particles are annihilated with rate 1, where $\Delta > 0$ is an activity parameter. Thus, in the local model the boundary of Λ plays the role of an infinite gas reservoir with density ρ . We fix the parameters U_1, U_2 and Δ such that $U_1 > 2U_2$ in what we call the strongly anisotropic case. We take $\Delta \in (U_1, U_1 + U_2)$, so that the empty (respectively full) configuration can be naturally related to metastability (respectively stability). We consider the asymptotic regime corresponding to finite volume Λ in the limit of large inverse temperature β . We investigate how the system *nucleates*, i.e., how it reaches \blacksquare (box full of particles) starting from \square (empty box).

For this local model, one of the main goals of the paper is to investigate this two-dimensional model in the strongly anisotropic case giving the geometrical description of the set $\mathcal{G}(\square, \blacksquare)$ in Theorem 4.10. We will prove that there are many distinct minimal gates that we will geometrically characterize together with their union. Let us explain the strategy we adopt in our paper. Thanks to the equivalence given in [45, Theorem 5.1], we reduce our study to the identification of the set of all the essential saddles that has to be crossed during the transition between the metastable state \square and the stable state \blacksquare . We apply the model-independent strategy carried out in [2, Section 3.2] to the strongly anisotropic two-dimensional case, where $m = \square$ and $\mathcal{X}^s = \{\blacksquare\}$, in order to eliminate some unessential saddles, i.e., those that are not essential. Thus we need to verify that the required model-dependent inputs are valid in our case. This study together with the characterization of the essential saddles rely on a detailed analysis of the motion of particles along the border of the droplet. On the one hand this is a typical feature of the Kawasaki dynamics, on the other hand this is peculiar in the strongly anisotropic case. Indeed in the metastable regime, particles move along the border of a droplet more rapidly than they arrive from the boundary of the box. More precisely, before the arrival of the next particle, we have that single particles attached to one side of a droplet typically detach (because $e^{U_1\beta} \ll e^{\Delta\beta}$ and $e^{U_2\beta} \ll e^{\Delta\beta}$), while bars of two or more particles typically do not detach (because $e^{\Delta\beta} \ll e^{(U_1+U_2)\beta}$). Roughly speaking, we will investigate the saddles that are crossed “just before visiting” and “just after visiting” the gate of the transition $\mathcal{G}(\square, \blacksquare)$. For the isotropic case, in [13, Theorem 1.4.3(ii)] the authors give a description of a gate and the geometrical characterization of the set $\mathcal{G}(\square, \blacksquare)$ is given in [2, Theorem 4.8]. For the weakly anisotropic case, these descriptions are given in [2, Theorems 4.11, 4.12]. This suggests that an analogue detailed description for the strongly anisotropic case is needed and we give it in Theorems 4.8 and 4.10. Additionally, we prove sharp asymptotics for the transition time in Theorem 4.11. Moreover, in Theorem 4.14 we investigate the spectral gap and mixing time.

The corresponding analysis for the isotropic and weakly anisotropic cases, i.e., $U_1 = U_2$ and $U_1 < 2U_2 - 2\varepsilon$ respectively, with $\varepsilon := U_1 + U_2 - \Delta$, is given in [2] and we discuss the differences and similarities below. Despite the structure of the gate is similar for the three cases, we emphasize that the entrance in them is very different. In particular, for the strongly anisotropic case there are two different mechanisms to enter the gate (see Lemma 6.17), while for the other two cases there is a unique one (see [2, Lemma 7.16]). On the other hand, it is clear that the properties that are strictly related to the horizontal and vertical interactions are the same for both weakly and strongly anisotropic cases. While some properties that involve the motion of particles along the border of the droplet are very different. Intuitively, we can think of the weakly anisotropic case as a “sort of interpolation” between the isotropic and strongly anisotropic ones, indeed it has some properties similar to the first, others to the latter. This specific difference between

these cases motivates together with applications the rigorous investigation of the anisotropic cases. Moreover, we highlight this difference in the description of the set $\mathcal{G}(\square, \blacksquare)$, indeed for the isotropic case more motions along the border are allowed and thus a totally explicit geometric description of the set is more difficult (see [2, Theorem 4.18]), but for the anisotropic cases we fully obtain it, since the condition $U_1 \neq U_2$ makes more difficult the sliding of particles along the border of the droplet. Among the anisotropic cases, by [2, Theorem 4.12] and Theorem 4.10 it is clear that the structure of the set $\mathcal{G}(\square, \blacksquare)$ “strongly” depends on “how large” is U_1 with respect to U_2 , indeed in the case $U_1 > 2U_2$ less slidings along the border are allowed and thus the structure of the union of minimal gates is less rich than the weak anisotropic case.

Some properties of the metastable behavior for these three cases have been already derived in the literature. In particular, for the isotropic interactions in [40] the authors investigated the simplified and local models. In particular, they studied the asymptotic properties of the transition time together with an intrinsic description of a gate (see Section 3 point 4 for the precise definition). This paper initiated the study of the local model that we describe in the following discussion. In [13] a geometric characterization of a subset of $\mathcal{G}(\square, \blacksquare)$ is given and this result is improved in [2, Theorem 4.8] with the identification of the minimal gates and their union $\mathcal{G}(\square, \blacksquare)$. For the three-dimensional lattice gas we refer to [36], where the authors investigated the asymptotic properties of the transition time and an intrinsic description of a gate. Moreover, for both two and three-dimensional isotropic case, using the *potential theoretic approach* the authors investigated in [13] the sharp asymptotics of the mean transition time, the so-called *pre-factor*. They proved that it is a constant that asymptotically depends only on the size of the box and the cardinality of the gate that they identified, but not on the parameter β . In the framework of the *pathwise approach* it is natural to study the third issue of metastability, namely the tube of typical trajectories realizing the transition between \square and \blacksquare . This has been analyzed only in [34] for two dimensions, indeed actually there are no known results about the tube for the three-dimensional isotropic case and for the anisotropic one. Concerning the anisotropic case, the asymptotic behavior of the transition time in probability, law and expectation has been derived for the weakly anisotropic interactions (see [49]) and for the strongly anisotropic interactions (see [3]). In those papers there is also the geometric description of a gate, but with less control over the geometry of the minimal gates, their union and the entrance in it, with respect to what we give in Theorems 4.8 and 4.10 for the strongly anisotropic case.

State of the art. The first dynamical approach, known as *pathwise approach*, was initiated in 1984 in [16], developed in [53, 54] and summerized in the monograph [55]. For Metropolis chains associated with statistical mechanics systems, metastability has been described by this approach in an elegant way in terms of the energy landscape associated to the Hamiltonian of the system. This approach focuses on the *dynamics* of the transition from metastable to stable states and it is so flexible that has been later developed to treat the tunnelling, namely the transition from a stable state to another stable state or stable states. Independently, a graphical approach was introduced in [17] and later used for Ising-like models [18]. Using the pathwise approach it is possible to obtain a detailed description of metastable behavior of the system and it made possible to answer all the three questions of metastability. A modern version of the pathwise approach can be found in [45, 22, 23, 51]. In particular, in [45], for the Metropolis markov chains, there are model-independent results concerning the transition time in probability, expectation and distribution, and concerning minimal gates and their union disentangled with respect to the tube of typical trajectories. In [45] the results on hitting times are obtained with minimal model-dependent knowledge, i.e., find all the metastable states and the minimal energy barrier which separates them from the stable states. In [22, Sections 2-3] the authors prove model-independent results to treat systems with multiple metastable states and give a sufficient

condition to identify them. In [23] the authors extend the results of [45] to general Markov chains (reversible and non reversible) with rare transitions setup, also called Freidlin-Wentzel Markov chains. These results are a useful tool to approach metastability for non-Metropolis systems such as Probabilistic Cellular Automata. In [51, Section 3] the authors extended the model-independent framework of [45] to study the first hitting times from any starting configuration (not necessarily metastable) to any target subset of configurations (not necessarily the set of stable configurations). This approach developed over the years has been extensively applied to study metastability in Statistical Mechanics lattice models. In this context, this approach and the one that follows ([11, 45, 55]) have been developed with the aim of finding answers valid with maximal generality and to reduce as much as possible the number of model dependent inputs necessary to describe the metastable behavior of any given system.

Another approach is the *potential-theoretic approach*, initiated in [11]. We refer to [12] for an extensive discussion and applications to different models. In this approach, the metastability phenomenon is interpreted as a sequence of visits of the path to different metastable sets. This method focuses on a precise analysis of hitting times of these sets with the help of *potential theory*. In the potential-theoretic approach the mean transition time is given in terms of the so-called *capacities* between two sets. Crucially capacities can be estimated by exploiting powerful variational principles. This means that the estimates of the average crossover time that can be derived are much sharper than those obtained via the pathwise approach. The quantitative success of the potential-theoretic approach is however limited to the case of reversible Markov processes.

These mathematical approaches, however, are not equivalent as they rely on different definitions of metastable states (see [22, Section 3] for a comparison) and thus involve different properties of hitting and transition times. The situation is particularly delicate for evolutions of infinite-volume systems, for irreversible systems, and degenerate systems, i.e., systems where the energy landscape has configurations with the same energy (as discussed in [22, 23, 27]). More recent approaches are developed in [4, 6, 10].

Statistical mechanical models for magnets deal with dynamics that do not conserve the total number of particles or the total magnetization. They include single spin-flip Glauber dynamics and many probabilistic cellular automata (PCA), that is a parallel dynamics. The pathwise approach was applied in finite volume at low temperature in [16, 52, 18, 42, 43, 28, 48, 20, 1, 7, 8] for single-spin-flip Glauber dynamics and in [21, 24, 25, 26] for parallel dynamics. The potential theoretic approach was applied to models at finite volume and at low temperature in [15, 13, 39, 38, 50, 37, 9]. The more involved infinite volume limit at low temperature or vanishing magnetic field was studied in [29, 30, 56, 57, 46, 47, 40, 31, 33, 14, 19, 32] for Ising-like models under single-spin-flip Glauber and Kawasaki dynamics.

The outline of the paper is as follows. In Section 2 we define the simplified model with periodic boundary conditions and the local model with open boundary conditions, and the Kawasaki dynamics. In Section 3 we give some model-independent definitions and in Section 4 we give some geometric definitions valid for Kawasaki dynamics (see Section 4.1). We state our main results for the local model concerning the gates in Section 4.2 and about the sharp asymptotics in Section 4.3. The results for the simplified model are given in Section 5. Sections 6, 7 and 8 are devoted to the local model. In particular, in Section 6 we apply the model-independent strategy carried out in [2, Section 3.2]. In Section 6.2 we give some model-dependent definitions, in Section 6.3 some tools that are useful in Section 6.4 for our model-dependent strategy. In Section 7 we give the proof of the main results for the strongly anisotropic case regarding the description of the gate (see Theorem 4.8) and the geometric characterization of the union of all the minimal gates (see Theorem 4.10). In Section 8 we give the proof of the main theorems

about the sharp asymptotics (see Theorems 4.11 and 4.14). In Section 9 we give the proof of the results for the simplified model (see Theorem 5.1).

2 Definition of the model

2.1 The model with open boundary conditions

Let $\Lambda = \{0, \dots, L\}^2 \subset \mathbb{Z}^2$ be a finite box centered at the origin. The side length L is fixed, but arbitrary, and later we will require L to be sufficiently large. Let

$$\partial^- \Lambda := \{x \in \Lambda : \exists y \notin \Lambda \mid |y - x| = 1\}, \quad (2.1)$$

be the interior boundary of Λ and let $\Lambda_0 := \Lambda \setminus \partial^- \Lambda$ be the interior of Λ . With each $x \in \Lambda$ we associate an occupation variable $\eta(x)$, assuming values 0 or 1. A lattice configuration is denoted by $\eta \in \mathcal{X} = \{0, 1\}^\Lambda$. Each configuration $\eta \in \mathcal{X}$ has an energy given by the following Hamiltonian:

$$H(\eta) := -U_1 \sum_{(x,y) \in \Lambda_{0,h}^*} \eta(x)\eta(y) - U_2 \sum_{(x,y) \in \Lambda_{0,v}^*} \eta(x)\eta(y) + \Delta \sum_{x \in \Lambda} \eta(x), \quad (2.2)$$

where $\Lambda_{0,h}^*$ (resp. $\Lambda_{0,v}^*$) is the set of the horizontal (resp. vertical) unoriented bonds joining nearest-neighbors points in Λ_0 . Thus the interaction is acting only inside Λ_0 ; the binding energy associated to a horizontal (resp. vertical) bond is $-U_1 < 0$ (resp. $-U_2 < 0$). We may assume without loss of generality that $U_1 \geq U_2$.

The grand-canonical Gibbs measure associated with H is

$$\mu(\eta) := \frac{e^{-\beta H(\eta)}}{Z} \quad \eta \in \mathcal{X}, \quad (2.3)$$

where

$$Z := \sum_{\eta \in \mathcal{X}} e^{-\beta H(\eta)} \quad (2.4)$$

is the so-called *partition function*.

2.2 Local Kawasaki dynamics

Next we define Kawasaki dynamics on Λ with boundary conditions that mimic the effect of an infinite gas reservoir outside Λ with density $\rho = e^{-\Delta\beta}$. Let $b = (x \rightarrow y)$ be an oriented bond, i.e., an *ordered* pair of nearest neighbour sites, and define

$$\begin{aligned} \partial^* \Lambda^{out} &:= \{b = (x \rightarrow y) : x \in \partial^- \Lambda, y \notin \Lambda\}, \\ \partial^* \Lambda^{in} &:= \{b = (x \rightarrow y) : x \notin \Lambda, y \in \partial^- \Lambda\}, \\ \Lambda^{*,orie} &:= \{b = (x \rightarrow y) : x, y \in \Lambda\}, \end{aligned} \quad (2.5)$$

and put $\bar{\Lambda}^{*,orie} := \partial^* \Lambda^{out} \cup \partial^* \Lambda^{in} \cup \Lambda^{*,orie}$. Two configurations $\eta, \eta' \in \mathcal{X}$ with $\eta \neq \eta'$ are said to be *communicating states* if there exists a bond $b \in \bar{\Lambda}^{*,orie}$ such that $\eta' = T_b \eta$, where $T_b \eta$ is the configuration obtained from η in any of these ways:

- for $b = (x \rightarrow y) \in \Lambda^{*,orie}$, $T_b \eta$ denotes the configuration obtained from η by interchanging particles along b :

$$T_b \eta(z) = \begin{cases} \eta(z) & \text{if } z \neq x, y, \\ \eta(x) & \text{if } z = y, \\ \eta(y) & \text{if } z = x. \end{cases} \quad (2.6)$$

- For $b = (x \rightarrow y) \in \partial^* \Lambda^{out}$ we set:

$$T_b \eta(z) = \begin{cases} \eta(z) & \text{if } z \neq x, \\ 0 & \text{if } z = x. \end{cases} \quad (2.7)$$

This describes the annihilation of a particle along the border;

- for $b = (x \rightarrow y) \in \partial^* \Lambda^{in}$ we set:

$$T_b \eta(z) = \begin{cases} \eta(z) & \text{if } z \neq y, \\ 1 & \text{if } z = y. \end{cases} \quad (2.8)$$

This describes the creation of a particle along the border.

The Kawasaki dynamics is the discrete time Markov chain $(\eta_t)_{t \in \mathbb{N}}$ on state space \mathcal{X} given by the following transition probabilities: for $\eta \neq \eta'$:

$$P(\eta, \eta') := \begin{cases} |\bar{\Lambda}^{*, orie}|^{-1} e^{-\beta[H(\eta') - H(\eta)]_+} & \text{if } \exists b \in \bar{\Lambda}^{*, orie} : \eta' = T_b \eta \\ 0 & \text{otherwise} \end{cases} \quad (2.9)$$

where $[a]_+ = \max\{a, 0\}$ and $P(\eta, \eta) := 1 - \sum_{\eta' \neq \eta} P(\eta, \eta')$. This describes a standard Metropolis dynamics with open boundary conditions: along each bond touching $\partial^- \Lambda$ from the outside, particles are created with rate $\rho = e^{-\Delta\beta}$ and are annihilated with rate 1, while inside Λ_0 particles are conserved. Note that an exchange of occupation numbers $\eta(x)$ for any x inside the ring $\Lambda \setminus \Lambda_0$ does not involve any change in energy.

Remark 2.1 *The stochastic dynamics defined by (2.9) is reversible w.r.t. Gibbs measure (2.3) corresponding to H .*

2.3 The model with periodic boundary conditions and its simplified version

In this Section we consider a lattice gas model to study the metastable behavior of conservative systems. Let $\Lambda^\beta \subset \mathbb{Z}^2$ be a large finite box centered at the origin, with periodic boundary conditions. With each $x \in \Lambda^\beta$ we associate an occupation variable $\eta^\beta(x)$, assuming the values 0 and 1. A lattice gas configuration is denoted by $\eta^\beta \in \mathcal{X}^\beta = \{0, 1\}^{\Lambda^\beta}$. We consider the interaction defined by the following Hamiltonian

$$H(\eta^\beta) := -U_1 \sum_{(x,y) \in \Lambda_{\beta,h}^*} \eta^\beta(x) \eta^\beta(y) - U_2 \sum_{(x,y) \in \Lambda_{\beta,v}^*} \eta^\beta(x) \eta^\beta(y) + \Delta \sum_{x \in \Lambda^\beta} \eta^\beta(x), \quad (2.10)$$

where $\Lambda_{\beta,h}^*$ (resp. $\Lambda_{\beta,v}^*$) is the set of the horizontal (resp. vertical) unoriented bonds joining nearest-neighbors points in Λ^β . Thus the binding energy associated to a horizontal (resp. vertical) bond is $-U_1 < 0$ (resp. $-U_2 < 0$). We may assume without loss of generality that $U_1 \geq U_2$. We fix the particle density in Λ_β at

$$\frac{1}{|\Lambda^\beta|} \sum_{x \in \Lambda^\beta} \eta^\beta(x) = \rho = e^{-\Delta\beta}, \quad (2.11)$$

where $\Delta > 0$ is an activity parameter. This corresponds to a total number of particles in Λ^β equal to $N = \rho |\Lambda^\beta|$. From (2.11) we see that in order to have particles at all we must pick $|\Lambda^\beta|$

at least exponentially large in β . This means that the regime where Λ^β is fixed, as in the non conservative case considered in Section 2.2, has no relevance here. We will in fact be interested in the regime

$$\Delta \in (U_1, U_1 + U_2), \quad \beta \rightarrow \infty, \quad \lim_{\beta \rightarrow \infty} \frac{1}{\beta} \log |\Lambda^\beta| = \infty. \quad (2.12)$$

We can not define the dynamics in Λ^β as in Section 2.2 due to the presence of periodic boundary conditions, but if we change the open boundary conditions the model is too difficult to treat due to the behavior of the gas in $\Lambda^\beta \setminus \Lambda$. Indeed in this conservative case the dynamics is not really local: particles must arrive from or return to the gas, which acts as a reservoir. It is therefore not possible to decouple the dynamics of the particles inside Λ from the dynamics of the gas in $\Lambda^\beta \setminus \Lambda$. For this reason we consider a *simplified model*, in which we remove the interactions outside the box $\Lambda_0 = \Lambda \setminus \partial^- \Lambda$, where $\partial^- \Lambda$ is defined in (2.1). Moreover, we also remove the exclusion outside Λ , thus the dynamics of the gas in $\Lambda^\beta \setminus \Lambda$ is that of independent random walks. Thus we replace the Hamiltonian defined in (2.12) with

$$H'(\eta^\beta) := -U_1 \sum_{(x,y) \in \Lambda_{0,h}^*} \eta(x)\eta(y) - U_2 \sum_{(x,y) \in \Lambda_{0,v}^*} \eta(x)\eta(y) + \Delta \sum_{x \in \Lambda^\beta} \eta^\beta(x). \quad (2.13)$$

We will use the results for the local model that concern the Hamiltonian defined in (2.2) to derive results for the simplified model as it will be clear in Section 9. In this setting, we can view the model described in Section 2.1 as the local version of the one described in this Section, where the effect on Λ of the gas in $\Lambda^\beta \setminus \Lambda$ may be described in terms of the creation of new particles with rate $\rho = e^{-\Delta\beta}$ at sites on the interior boundary of Λ and the annihilation of particles with rate 1 at sites on the exterior boundary of Λ .

Let $\mathcal{V}_N = \{\eta^\beta \in \mathcal{X}^\beta : N_{\Lambda^\beta} = N\}$ the set of configurations with N particles. For $\eta \in \mathcal{X} = \{0, 1\}^\Lambda$, let ν_η denote the canonical Gibbs measure conditioned on the configuration inside Λ being η , i.e.,

$$\nu_\eta(\eta^\beta) = \frac{\nu_N(\eta^\beta) \mathbb{1}_{\mathcal{J}_\beta(\eta)}(\eta^\beta)}{\nu_N(\mathcal{J}_\beta(\eta))}, \quad \eta^\beta \in \mathcal{X}^\beta, \quad (2.14)$$

where $\mathcal{J}_\beta(\eta) = \{\eta^\beta \in \mathcal{X}^\beta : \eta^\beta|_\Lambda = \eta\}$, with $\eta^\beta|_\Lambda$ the restriction of η^β to Λ , and ν_N is the canonical Gibbs measure defined as

$$\nu_N(\eta^\beta) = \frac{e^{-\beta H(\eta^\beta)} \mathbb{1}_{\mathcal{V}_N}(\eta^\beta)}{Z_N}, \quad \eta^\beta \in \mathcal{X}^\beta, \quad (2.15)$$

where

$$Z_N = \sum_{\eta^\beta \in \mathcal{V}_N} e^{-\beta H(\eta^\beta)} \quad (2.16)$$

For $\eta \in \mathcal{X}$, write \mathbb{P}_{ν_η} and \mathbb{E}_{ν_η} to denote respectively the probability law and expectation for the Markov process $(\eta_t)_{t \geq 0}$ on \mathcal{X}^β following the Kawasaki dynamics with Hamiltonian

$$H''(\eta^\beta) = -U_1 \sum_{(x,y) \in \Lambda_{0,h}^*} \eta(x)\eta(y) - U_2 \sum_{(x,y) \in \Lambda_{0,v}^*} \eta(x)\eta(y), \quad (2.17)$$

given that η_0 is chosen according to ν_η . Write \square to denote the empty configuration in Λ , i.e., $\square^\beta = \mathcal{J}_\beta(\square)$.

3 Model-independent definitions and notations

We will use italic capital letters for subsets of Λ , script capital letters for subsets of \mathcal{X} , and boldface capital letters for events under the Kawasaki dynamics. We use this convention in order to keep the various notations apart. We will denote by \mathbb{P}_{η_0} the probability law of the Markov process $(\eta_t)_{t \geq 0}$ starting at η_0 and by \mathbb{E}_{η_0} the corresponding expectation.

1. Paths and hitting times.

- A *path* ω is a sequence $\omega = (\omega_1, \dots, \omega_k)$, with $k \in \mathbb{N}$, $\omega_i \in \mathcal{X}$ and $P(\omega_i, \omega_{i+1}) > 0$ for $i = 1, \dots, k-1$. We write $\omega: \eta \rightarrow \eta'$ to denote a path from η to η' , namely with $\omega_1 = \eta$, $\omega_k = \eta'$. A set $\mathcal{A} \subset \mathcal{X}$ with $|\mathcal{A}| > 1$ is *connected* if and only if for all $\eta, \eta' \in \mathcal{A}$ there exists a path $\omega: \eta \rightarrow \eta'$ such that $\omega_i \in \mathcal{A}$ for all i . We indicate with $\omega_1 \circ \omega_2$ the composition of two paths ω_1 and ω_2 .
- Given a non-empty set $\mathcal{A} \subset \mathcal{X}$, define the *first-hitting time of \mathcal{A}* as

$$\tau_{\mathcal{A}} := \min\{t \geq 0 : \eta_t \in \mathcal{A}\}. \quad (3.1)$$

2. Min-max and communication height

- Given a function $f: \mathcal{X} \rightarrow \mathbb{R}$ and a subset $\mathcal{A} \subseteq \mathcal{X}$, we denote by

$$\arg \max_{\mathcal{A}} f := \{\eta \in \mathcal{A} : f(\eta) = \max_{\zeta \in \mathcal{A}} f(\zeta)\} \quad (3.2)$$

the set of points where the maximum of f in \mathcal{A} is reached. If $\omega = (\omega_1, \dots, \omega_k)$ is a path, in the sequel we will write $\arg \max_{\omega} H$ to indicate $\arg \max_{\mathcal{A}} H$, with $\mathcal{A} = \{\omega_1, \dots, \omega_k\}$ e H the Hamiltonian.

- The *bottom* $\mathcal{F}(\mathcal{A})$ of a non-empty set $\mathcal{A} \subset \mathcal{X}$ is the set of *global minima* of the Hamiltonian H in \mathcal{A} :

$$\mathcal{F}(\mathcal{A}) := \{\eta \in \mathcal{A} : H(\eta) = \min_{\zeta \in \mathcal{A}} H(\zeta)\}. \quad (3.3)$$

For a set $\mathcal{A} \subset \mathcal{X}$ such that all the configurations have the same energy, with an abuse of notation we denote this energy by $H(\mathcal{A})$.

- The *communication height* between a pair $\eta, \eta' \in \mathcal{X}$ is

$$\Phi(\eta, \eta') := \min_{\omega: \eta \rightarrow \eta'} \max_{\zeta \in \omega} H(\zeta). \quad (3.4)$$

Given $\mathcal{A} \subset \mathcal{X}$, we define the *restricted communication height* between $\eta, \eta' \in \mathcal{A}$ as

$$\Phi_{|\mathcal{A}}(\eta, \eta') := \min_{\substack{\omega: \eta \rightarrow \eta' \\ \omega \subseteq \mathcal{A}}} \max_{\zeta \in \omega} H(\zeta). \quad (3.5)$$

3. Stability level, stable and metastable states

- We call *stability level* of a state $\zeta \in \mathcal{X}$ the energy barrier

$$V_{\zeta} := \Phi(\zeta, \mathcal{I}_{\zeta}) - H(\zeta), \quad (3.6)$$

where \mathcal{I}_{ζ} is the set of states with energy below $H(\zeta)$:

$$\mathcal{I}_{\zeta} := \{\eta \in \mathcal{X} : H(\eta) < H(\zeta)\}. \quad (3.7)$$

We set $V_{\zeta} := \infty$ if \mathcal{I}_{ζ} is empty.

- We call *V-irreducible states* the set of all states with stability level larger than V :

$$\mathcal{X}_V := \{\eta \in \mathcal{X} : V_\eta > V\}. \quad (3.8)$$

- The set of *stable states* is the set of the global minima of the Hamiltonian:

$$\mathcal{X}^s := \mathcal{F}(\mathcal{X}). \quad (3.9)$$

- The set of *metastable states* is given by

$$\mathcal{X}^m := \{\eta \in \mathcal{X} : V_\eta = \max_{\zeta \in \mathcal{X} \setminus \mathcal{X}^s} V_\zeta\}. \quad (3.10)$$

We denote by Γ_m the stability level of the states in \mathcal{X}^m .

4. Optimal paths, saddles and gates

- We denote by $(\eta \rightarrow \eta')_{opt}$ the *set of optimal paths* as the set of all paths from η to η' realizing the min-max in \mathcal{X} , i.e.,

$$(\eta \rightarrow \eta')_{opt} := \{\omega : \eta \rightarrow \eta' \text{ such that } \max_{\xi \in \omega} H(\xi) = \Phi(\eta, \eta')\}. \quad (3.11)$$

- The set of *minimal saddles* between $\eta, \eta' \in \mathcal{X}$ is defined as

$$\mathcal{S}(\eta, \eta') := \{\zeta \in \mathcal{X} : \exists \omega \in (\eta \rightarrow \eta')_{opt}, \omega \ni \zeta \text{ such that } \max_{\xi \in \omega} H(\xi) = H(\zeta)\}. \quad (3.12)$$

- A saddle $\xi \in \mathcal{S}(\eta, \eta')$ is called *unessential* if for any $\omega \in (\eta \rightarrow \eta')_{opt}$ such that $\omega \cap \xi \neq \emptyset$ we have $\{\arg \max_\omega H\} \setminus \{\xi\} \neq \emptyset$ and there exists $\omega' \in (\eta \rightarrow \eta')_{opt}$ such that $\{\arg \max_{\omega'} H\} \subseteq \{\arg \max_\omega H\} \setminus \{\xi\}$.
- A saddle $\xi \in \mathcal{S}(\eta, \eta')$ is called *essential* if it is not unessential, i.e., if either

- (i) there exists $\omega \in (\eta \rightarrow \eta')_{opt}$ such that $\{\arg \max_\omega H\} = \{\xi\}$ or
- (ii) there exists $\omega \in (\eta \rightarrow \eta')_{opt}$ such that $\{\arg \max_\omega H\} \supset \{\xi\}$ and $\{\arg \max_{\omega'} H\} \not\subseteq \{\arg \max_\omega H\} \setminus \{\xi\}$ for all $\omega' \in (\eta \rightarrow \eta')_{opt}$.

- Given a pair $\eta, \eta' \in \mathcal{X}$, we say that $\mathcal{W} \equiv \mathcal{W}(\eta, \eta')$ is a *gate* for the transition $\eta \rightarrow \eta'$ if $\mathcal{W}(\eta, \eta') \subseteq \mathcal{S}(\eta, \eta')$ and $\omega \cap \mathcal{W} \neq \emptyset$ for all $\omega \in (\eta \rightarrow \eta')_{opt}$. In words, a gate is a subset of $\mathcal{S}(\eta, \eta')$ that is visited by all optimal paths.
- We say that $\mathcal{W}(\eta, \eta')$ is a *minimal gate* for the transition $\eta \rightarrow \eta'$ if it is a gate and for any $\mathcal{W}' \subsetneq \mathcal{W}(\eta, \eta')$ there exists $\omega' \in (\eta \rightarrow \eta')_{opt}$ such that $\omega' \cap \mathcal{W}' = \emptyset$. In words, a minimal gate is a minimal subset of $\mathcal{S}(\eta, \eta')$ by inclusion that is visited by all optimal paths.
- For a given pair of configurations η, η' , we denote by $\mathcal{G}(\eta, \eta')$ the union of all minimal gates:

$$\mathcal{G}(\eta, \eta') := \bigcup_{\mathcal{W}(\eta, \eta') \text{ minimal gate}} \mathcal{W}(\eta, \eta') \quad (3.13)$$

4 Main results: the gates for the local model

In this Section we state our main results: in Section 4.2 we obtain the geometrical characterization of the union of all minimal gates for the strongly anisotropic case. In order to do this we need some model-dependent definitions for the Kawasaki dynamics (see Section 4.1) and some specific ones for the strongly anisotropic case (see Section 4.2). In Section 4.3 we derive sharp estimates for the asymptotic transition time. Moreover, we derive the mixing time and spectral gap. For the corresponding results obtained in the isotropic and weakly anisotropic cases, i.e., in the parameter regime $U_1 = U_2$ and $U_1 < 2U_2 - 2\varepsilon$ respectively, where ε is defined in (4.8), we refer to [2, Sections 4.2,4.3] for the results concerning the gates and union of minimal gates and to [2, Section 4.4] for the results concerning the asymptotic transition time, mixing time and spectral gap.

4.1 Geometric definitions for Kawasaki dynamics

We give some model-dependent definitions and notations in order to state our main theorems.

1. Free particles and clusters

- For $x \in \Lambda_0$, let $\text{nn}(x) := \{y \in \Lambda_0 : d(y, x) = 1\}$ be the set of nearest-neighbor sites of x in Λ_0 , where d in the entire paper denotes the lattice distance.
- A *free particle* in $\eta \in \mathcal{X}$ is a site x , with $\eta(x) = 1$, such that either $x \in \eta \cap \partial^- \Lambda$, or $x \in \eta \cap \Lambda_0$ and $\sum_{y \in \text{nn}(x) \cap \Lambda_0} \eta(y) = 0$. We denote by η_{fp} the union of free particles in $\partial^- \Lambda$ and free particles in Λ_0 . We denote by $n(\eta)$ the number of free particles in η .

We denote by η_{cl} the clusterized part of the occupied sites of η :

$$\eta_{cl} := \{x \in \Lambda_0 : \eta(x) = 1\} \setminus \eta_{fp}. \quad (4.1)$$

- We denote by η^{fp} the addition of a free particle anywhere in Λ to the configuration η .
- Given a configuration $\eta \in \mathcal{X}$, consider the subset $C(\eta_{cl})$ of \mathbb{R}^2 defined as the union of the 1×1 closed squares centered at the occupied sites of η_{cl} in Λ_0 and call the maximal connected components of this set the clusters of η_{cl} .
- Given a set $A \subset \mathbb{R}^2$, we define the number of 1×1 closed occupied squares in A as

$$|A| := |A \cap C(\eta_{cl})| \quad (4.2)$$

and as $\|A\|$ the numbers of 1×1 closed squares in A . Note that $\|\cdot\|$ takes into account the possibility that the squares are occupied or not.

2. Projections, semi-perimeter and vacancies

- For $\eta \in \mathcal{X}$, we denote by $g_1(\eta)$ (resp. $g_2(\eta)$) one half of the horizontal (resp. vertical) length of the Euclidean boundary of $C(\eta_{cl})$. Then the energy associated with η is given by

$$H(\eta) = -(U_1 + U_2 - \Delta)|C(\eta_{cl})| + U_1 g_2(\eta) + U_2 g_1(\eta) + \Delta n(\eta). \quad (4.3)$$

- Let $p_1(\eta)$ and $p_2(\eta)$ be the total lengths of horizontal and vertical projections of $C(\eta_{cl})$ respectively. More precisely, let $r_{j,1} = \{x \in \mathbb{Z}^2 : (x)_1 = j\}$ be the j -th column and $r_{j,2} = \{x \in \mathbb{Z}^2 : (x)_2 = j\}$ be the j -th row, where $(x)_1$ or $(x)_2$ denote the first or second component of x . Let

$$\pi_1(\eta) := \{j \in \mathbb{Z} : r_{j,1} \cap C(\eta_{cl}) \neq \emptyset\} \quad (4.4)$$

and $p_1(\eta) := |\pi_1(\eta)|$. In a similar way we define the vertical projection $\pi_2(\eta)$ and $p_2(\eta)$.

- We define $g'_i(\eta) := g_i(\eta) - p_i(\eta) \geq 0$; we call *monotone* a configuration such that $g_i(\eta) = p_i(\eta)$ for $i = 1, 2$.
- We define the *semi-perimeter* $s(\eta)$ and the *vacancies* $v(\eta)$ as

$$\begin{aligned} s(\eta) &:= p_1(\eta) + p_2(\eta), \\ v(\eta) &:= p_1(\eta)p_2(\eta) - |C(\eta_{cl})|. \end{aligned} \quad (4.5)$$

3. n -manifold, rectangles and corners

- The configuration space \mathcal{X} can be partitioned as

$$\mathcal{X} = \bigcup_n \mathcal{V}_n, \quad (4.6)$$

where $\mathcal{V}_n := \{\eta \in \mathcal{X} : |C(\eta_{cl})| + n(\eta) = n\}$ is the set of configurations with n particles, called the *n -manifold*.

- We denote by $\mathcal{R}(l_1, l_2)$ the set of configurations that have no free particle and a single cluster such that $C(\eta_{cl})$ is a rectangle $R(l_1, l_2)$, with $l_1, l_2 \in \mathbb{N}$. For any $\eta, \eta' \in \mathcal{R}(l_1, l_2)$ we have immediately:

$$H(\eta) = H(\eta') = H(\mathcal{R}(l_1, l_2)) = U_1 l_2 + U_2 l_1 - \varepsilon l_1 l_2, \quad (4.7)$$

where

$$\varepsilon := U_1 + U_2 - \Delta. \quad (4.8)$$

- A *corner* in $\eta \in \mathcal{X}$ is a closed 1×1 square centered in an occupied site $x \in \Lambda_0$ such that, if we order clockwise its four nearest neighbors x_1, x_2, x_3, x_4 , then $\sum_{y \in \text{nn}(x)} \eta(y) = 2$, with $\eta(x_i) = \eta(x_{i+1}) = 1$, with $i = 1, \dots, 4$ and the convention that $x_5 = x_1$ (see Figure 1 on the right-hand side).

4. Circumscribed rectangle, frames and bars

- If η is a configuration with a single cluster then we denote by $\text{CR}(\eta)$ the rectangle *circumscribing* $C(\eta_{cl})$, i.e., the smallest rectangle containing η .

We denote $\partial^+ \text{CR}(\eta)$ the *external frame* of $\text{CR}(\eta)$ as the union of squares 1×1 centered at sites that are not contained in $\text{CR}(\eta)$ such that those sites have Euclidean distance with sites in $\text{CR}(\eta)$ less or equal than $\sqrt{2}$ (see Figure 1 on the right-hand side). Note that the external frame of $\text{CR}(\eta)$ contains only non occupied sites.

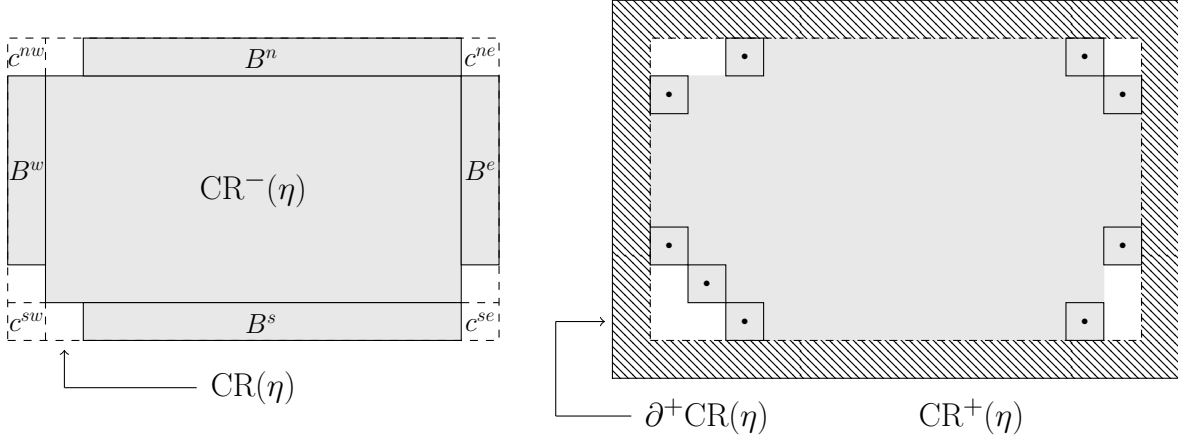

Figure 1: Here we depict the same configuration η on the left and on the right to emphasize different geometrical definitions. The grey area in both pictures represents $C(\eta_{cl})$. In particular, on the left-hand side we stress the frame-angles $c^{\alpha\alpha'}(\eta)$, the bars $B^\alpha(\eta)$, $CR^-(\eta)$ and the circumscribing rectangle $CR(\eta)$ (represented with a dashed line). While on the right-hand side we stress the sites that are in a corner (represented with a dot), $CR^+(\eta)$ and the external frame $\partial^+CR(\eta)$ (the dashed area).

We denote $\partial^-CR(\eta)$ the *internal frame* of $CR(\eta)$ as the union of squares 1×1 centered at sites that are contained in $CR(\eta)$ such that those sites have Euclidean distance with sites not in $CR(\eta)$ less or equal than $\sqrt{2}$. If this distance is equal to $\sqrt{2}$, we say that the unit square is a *frame-angle* $c^{\alpha\alpha'}(\eta)$ in $\partial^-CR(\eta)$, where $\alpha\alpha' \in \{ne, nw, se, sw\}$, with $n = \text{north}$, $s = \text{south}$, etc. Note that the internal frame of $CR(\eta)$ is a geometrical object contained in \mathbb{R}^2 that can contain both occupied and non occupied sites (see Figure 1 on the left-hand side). We partition the set $\partial^-CR(\eta)$ without frame-angles in *two horizontal and two vertical rows* $r^\alpha(\eta)$, with $\alpha \in \{n, w, e, s\}$.

Moreover, we set

$$\begin{aligned} CR^-(\eta) &= CR(\eta) \setminus \partial^-CR(\eta), \\ CR^+(\eta) &= CR(\eta) \cup \partial^+CR(\eta). \end{aligned} \quad (4.9)$$

See Figure 1 for an example.

Remark 4.1 Note that, for example, the frame-angles $c^{ne}(\eta)$ and $c^{en}(\eta)$ are the same, but this distinction will be useful in Definitions 4.4 and 4.5.

- A *vertical* (respectively *horizontal*) bar $B^\alpha(\eta)$ of a single cluster of η with length k is a $1 \times k$ (respectively $k \times 1$) rectangle contained in $C(\eta_{cl})$, with $\alpha \in \{n, w, e, s\}$, $k \geq 1$, such that each square 1×1 of the bar is attached only to one square of $C(\eta_{cl}) \setminus B^\alpha(\eta)$ (see Figure 1 on the left-hand side). In the cases in which it is not specified if the bar is vertical or horizontal we call it simply *bar*. If $k = 1$ we say that the bar is a *protuberance*.

Remark 4.2 Note that two bars $B^\alpha(\eta)$ and $B^{\alpha'}(\eta)$, with $\alpha, \alpha' \in \{n, s, w, e\}$, can possibly intersect in the frame-angle $c^{\alpha\alpha'}(\eta)$. If this is the case, we get $|B^\alpha(\eta) \cup B^{\alpha'}(\eta)| = |B^\alpha(\eta)| + |B^{\alpha'}(\eta)| - 1$.

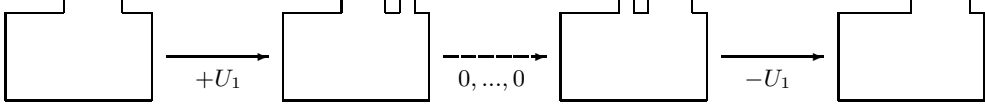

Figure 2: 1-translation of the horizontal bar $B^n(\eta)$ at cost U_1 .

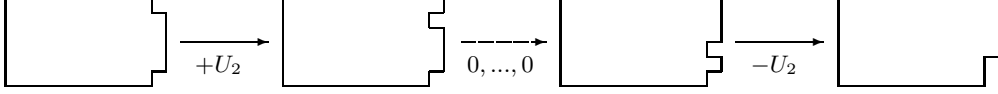

Figure 3: 1-translation of the vertical bar $B^e(\eta)$ at cost U_2 .

5. Motions along the border

Recall definitions of $|\cdot|$ and $\|\cdot\|$ in (4.2) and below. In the following, we give the precise notion of translation by 1 of a bar, for example to the left or to the right, while keeping all the squares of the bar attached to the cluster below.

Definition 4.3 *Given η and a bar $B^\alpha(\eta)$ of length k , with $\alpha \in \{n, s, e, w\}$, we say that it is possible to translate the bar $B^\alpha(\eta)$ if*

$$k = |B^\alpha(\eta)| < |\partial^+ B^\alpha(\eta)|. \quad (4.10)$$

We define the 1-translation of a bar $B^\alpha(\eta)$ of length k as a sequence of configurations (η_1, \dots, η_k) such that $\eta_1 = \eta$ and η_i is obtained from η_{i-1} translating by 1 a unit square along the rectangle $\partial^+ B^\alpha(\eta) \cap C(\eta_{cl})$ for any $2 \leq i \leq k$.

In Figure 2 (resp. Figure 3) we depict a 1-translation of a horizontal (resp. vertical) bar at cost U_1 (resp. U_2).

In the following, we give the precise notion of sliding a unit square from row $r^\alpha(\eta)$ to $r^{\alpha'}(\eta)$ passing through the frame angle $c^{\alpha\alpha'}(\eta)$.

Definition 4.4 *Given η , let $\alpha\alpha'$ such that $c^{\alpha\alpha'}(\eta)$ is a frame-angle. We say that it is possible to slide a unit square around a frame-angle $c^{\alpha\alpha'}(\eta) \subseteq \partial^- CR(\eta)$ from a row $r^\alpha(\eta) \subseteq \partial^- CR(\eta)$ to a row $r^{\alpha'}(\eta) \subseteq \partial^- CR(\eta)$ via a frame-angle $c^{\alpha\alpha'}(\eta)$ if*

$$|c^{\alpha\alpha'}(\eta)| = 0, \quad |r^\alpha(\eta)| \geq 1, \quad 1 \leq |r^{\alpha'}(\eta)| < \|r^{\alpha'}(\eta)\| + 1. \quad (4.11)$$

Let $\alpha'' \neq \alpha'$ such that $c^{\alpha\alpha''}(\eta)$ is a frame-angle. See Figure 4 for an example. We define a sliding of a unit square around a frame-angle $c^{\alpha\alpha'}(\eta) \subseteq \partial^- CR(\eta)$ as the composition of a sequence of 1-translations of the bar $B^\alpha(\eta)$ from $r^\alpha(\eta) \cup c^{\alpha\alpha''}(\eta)$ to $r^\alpha(\eta) \cup c^{\alpha\alpha'}(\eta)$, namely (η^1, \dots, η^k) , and the 1-translation of a bar $B^{\alpha'}(\eta) = C(\eta_{cl}^k) \cap (r^{\alpha'}(\eta) \cup c^{\alpha\alpha'}(\eta))$ from $r^{\alpha'}(\eta) \cup c^{\alpha\alpha'}(\eta)$ to $r^{\alpha'}(\eta) \cup c^{\alpha'\alpha''}(\eta)$, where $\alpha'' \neq \alpha$ is such that $c^{\alpha'\alpha''}(\eta)$ is a frame-angle.

The definition above is used only to define the following sliding of a bar from row $r^\alpha(\eta)$ to $r^{\alpha'}(\eta)$ passing through the frame angle $c^{\alpha\alpha'}(\eta)$, that corresponds to iteratively apply the sliding of a unit square around a frame-angle.

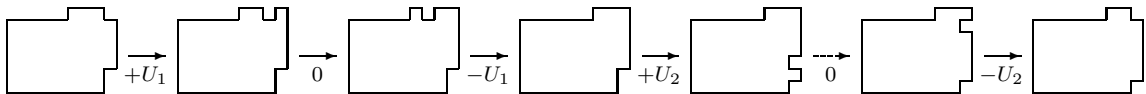

Figure 4: Sliding of a unit square around the frame angle $c^{ne}(\eta)$ at cost U_1 . In this case $\alpha = n$, $\alpha' = e$, $\alpha'' = w$ and $\alpha''' = s$.

Definition 4.5 Given η , let α' such that $c^{\alpha'}(\eta)$ is a frame-angle. Before sliding a bar around a frame-angle, we translate the bars $B^\alpha(\eta)$ and $B^{\alpha'}(\eta)$ at distance 1 to the frame-angle $c^{\alpha'}(\eta)$ obtaining a configuration η' . We say that it is possible to slide a bar $B^\alpha(\eta')$ around a frame-angle $c^{\alpha'}(\eta') \subseteq \partial^- \text{CR}(\eta')$ if it is possible to move all the unit squares in $B^\alpha(\eta')$ around a frame-angle $c^{\alpha'}(\eta')$ from a row $r^\alpha(\eta') \cup c^{\alpha''}(\eta')$ to a row $r^{\alpha'}(\eta') \cup c^{\alpha'\alpha''}(\eta')$, where $\alpha'' \neq \alpha'$ and $\alpha''' \neq \alpha$ are such that $c^{\alpha''}(\eta')$ and $c^{\alpha'\alpha''}(\eta')$ are frame-angles. Namely,

$$|B^\alpha(\eta')| + |r^{\alpha'}(\eta')| \leq \|r^{\alpha'}(\eta')\| + 1. \quad (4.12)$$

Moreover, we define a sliding of a bar $B^\alpha(\eta')$ around a frame-angle $c^{\alpha'}(\eta')$ as the sequence of $|B^\alpha(\eta')|$ slidings of unit squares around a frame-angle $c^{\alpha'}(\eta')$.

See the path described in Figure 7, that connects the configuration η to the configuration (12) for an example of sliding of the bar $B^e(\eta)$ around the frame-angle $c^{en}(\eta)$, with η as the configuration (3).

4.2 Gate for strongly anisotropic interactions

In this Section we impose $U_1 \neq U_2$ and $U_1 > 2U_2$ in (2.2), i.e., we consider strongly anisotropic interactions between nearest neighboring sites. We will consider $0 < \varepsilon \ll U_2$, where \ll means sufficiently smaller; for instance $\varepsilon \leq \frac{U_2}{100}$ is enough. Many interesting quantities that follow have lower index sa to remind that they refer to strongly anisotropic interactions. In order to state our main results for the gates in the strongly anisotropic regime we need the following definitions. We define the critical vertical length l_2^* as

$$l_2^* := \left\lceil \frac{U_2}{U_1 + U_2 - \Delta} \right\rceil, \quad (4.13)$$

where $\lceil \cdot \rceil$ denotes the integer part plus 1. We set the critical value of s_{sa} as

$$s_{sa}^* := 3l_2^* - 1. \quad (4.14)$$

Now we need the following definitions.

Definition 4.6 (a) We define $\bar{\mathcal{Q}}_{sa}$ as the set of configurations having one cluster anywhere in Λ_0 consisting of a $(2l_2^* - 3) \times l_2^*$ rectangle with a single protuberance attached to one of the shortest sides. Similarly, we define $\tilde{\mathcal{Q}}_{sa}$ as the set of configurations having one cluster anywhere in Λ_0 consisting of a $(2l_2^* - 3) \times l_2^*$ rectangle with a single protuberance attached to one of the longest sides.

(b) We define

$$\Gamma_{sa}^* := U_1 l_2^* + 2U_2 l_2^* + U_1 - U_2 - 2\varepsilon(l_2^*)^2 + 3\varepsilon l_2^* - 2\varepsilon. \quad (4.15)$$

(c) We define the volume of the clusters in $\bar{\mathcal{Q}}_{sa}$ as

$$n_{sa}^c := l_2^*(2l_2^* - 3) + 1, \quad (4.16)$$

and

$$\begin{aligned} \bar{\mathcal{D}}_{sa} &:= \{\eta' \in \mathcal{V}_{n_{sa}^c} \mid \exists \eta \in \bar{\mathcal{Q}}_{sa} : H(\eta) = H(\eta') \text{ and } \Phi_{|\mathcal{V}_{n_{sa}^c}}(\eta, \eta') \leq H(\eta) + U_1\}, \\ \tilde{\mathcal{D}}_{sa} &:= \{\eta' \in \mathcal{V}_{n_{sa}^c} \mid \exists \eta \in \tilde{\mathcal{Q}}_{sa} : H(\eta) = H(\eta') \text{ and } \Phi_{|\mathcal{V}_{n_{sa}^c}}(\eta, \eta') \leq H(\eta) + U_1\}. \end{aligned} \quad (4.17)$$

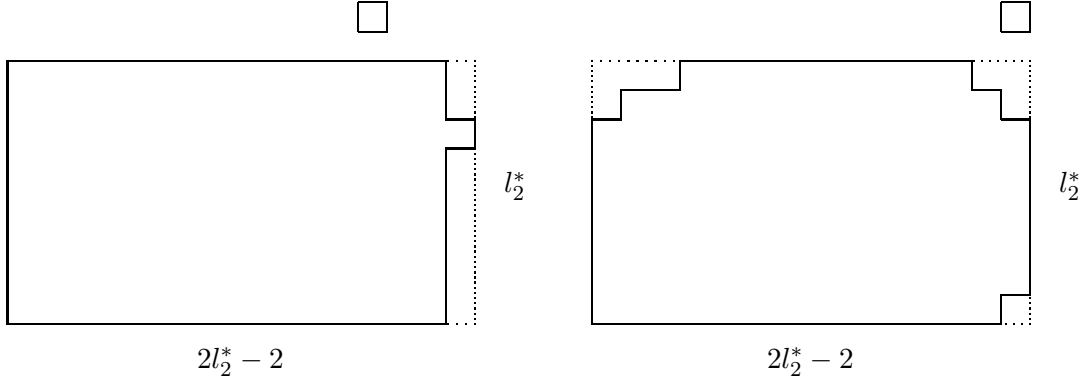

Figure 5: Critical configurations in \mathcal{C}_{sa}^* in the strongly anisotropic case. Moreover, if we remove the free particle we obtain on the left a configuration in $\bar{\mathcal{Q}}_{sa}$ and on the right a configuration in $\bar{\mathcal{D}}_{sa} \setminus \bar{\mathcal{Q}}_{sa}$.

Note that the last condition in (4.17) is the same as requiring that $\Phi_{|\mathcal{V}_{n_{sa}^*}}(\eta, \eta') < \Gamma_{sa}^* + H(\square) = \Gamma_{sa}^*$. We encourage the reader to consult Proposition 6.1, where we give the geometrical description of the set $\bar{\mathcal{D}}_{sa}$ and $\tilde{\mathcal{D}}_{sa}$. Roughly speaking, one can think of $\bar{\mathcal{D}}_{sa}$ as the set of configurations consisting of a rectangular cluster with four bars attached to its four sides, whose lengths satisfy precise conditions.

(d) We define

$$\mathcal{C}_{sa}^* := \bar{\mathcal{D}}_{sa}^{fp}. \quad (4.18)$$

The reason why only the set $\bar{\mathcal{D}}_{sa}$ is relevant for the set \mathcal{C}_{sa}^* will be clarified later (see Lemma 6.9). Note that

$$\begin{aligned} H(\mathcal{C}_{sa}^*) &= H(\bar{\mathcal{D}}_{sa}^{fp}) = H(\bar{\mathcal{D}}_{sa}) + \Delta = H(\mathcal{Q}_{sa}) + \Delta \\ &= U_1 l_2^* + 2U_2 l_2^* - U_1 - 3U_2 - \varepsilon l_2^* (2l_2^* - 3) + 2\Delta \\ &= U_1 l_2^* + 2U_2 l_2^* + U_1 - U_2 - 2\varepsilon (l_2^*)^2 + 3\varepsilon l_2^* - 2\varepsilon \\ &= \Gamma_{sa}^*. \end{aligned} \quad (4.19)$$

See Figure 5 for an example of configurations in \mathcal{C}_{sa}^* .

Remark 4.7 Note that $H(\bar{\mathcal{Q}}_{sa}) < H(\tilde{\mathcal{Q}}_{sa})$, indeed

$$\begin{aligned} H(\bar{\mathcal{Q}}_{sa}) &= \Gamma_{sa}^* - \Delta, \\ H(\tilde{\mathcal{Q}}_{sa}) &= \Gamma_{sa}^* - \Delta + U_1 - U_2. \end{aligned} \quad (4.20)$$

The first main result of Section 4.2 is the following.

Theorem 4.8 (Gate for strongly anisotropic interactions). *The set \mathcal{C}_{sa}^* is a gate for the transition from \square to \blacksquare .*

We refer to Section 7.1 for the proof of the Theorem 4.8.

Remark 4.9 *Theorem 4.8 sharpen the previous results obtained in [3, Theorem 2.4], indeed we prove that \mathcal{C}_{sa}^* is a gate instead of $\mathcal{P}_1 \cup \mathcal{P}_2$ (see (4.21) and (7.1) for the definitions of $\mathcal{P}_{sa,0} = \mathcal{P}_1$ and \mathcal{P}_2 respectively).*

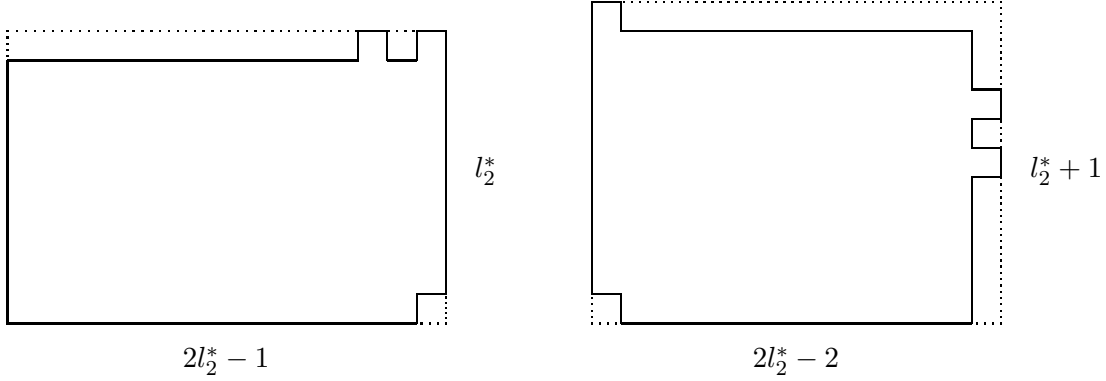

Figure 6: Critical configurations in the strongly anisotropic case: on the left hand-side is represented a configuration in $\mathcal{P}_{sa,0}$ and on the right hand-side a configuration in $\mathcal{P}_{sa,1}$.

In order to give the result regarding the geometric characterization of $\mathcal{G}_{sa}(\square, \blacksquare)$, we need some definitions. For any $i = 0, 1$ we define $\mathcal{P}_{sa,i} \subseteq \mathcal{S}_{sa}(\square, \blacksquare)$ that consists of configurations with a single cluster and no free particle, a fixed number of vacancies, that is not monotone with circumscribed rectangles obtained from the one of the configurations in $\bar{\mathcal{D}}_{sa}$ via increasing by one the horizontal or vertical length. More precisely,

$$\mathcal{P}_{sa,i} := \{ \eta : n(\eta) = 0, v(\eta) = 2l_2^* + il_2^* - i(i+1) - 2, g_1'(\eta) = i, g_2'(\eta) = 1 - i, \eta_{cl} \text{ is connected, with circumscribed rectangle in } \mathcal{R}(2l_2^* - i - 1, l_2^* + i) \}, \quad i = 0, 1. \quad (4.21)$$

See Figure 6 for an example of configurations in $\mathcal{P}_{sa,0}$ (on the left-hand side) and in $\mathcal{P}_{sa,1}$ (on the right-hand side).

The set $\mathcal{G}_{sa}(\square, \blacksquare)$ contains all the configurations that are in the sets defined in (4.21) with the following further conditions. First, we define the subsets $\mathcal{A}_0^{\alpha'}$ (resp. \mathcal{A}_1^α) of the saddles in $\mathcal{P}_{sa,0}$ (resp. $\mathcal{P}_{sa,1}$) that contains only one occupied unit square in either a vertical (resp. horizontal) row or in one of its two adjacent frame-angles. More precisely,

$$\mathcal{A}_0^{\alpha'} := \{ \eta \in \mathcal{P}_{sa,0} : |r^{\alpha'}(\eta) \cup c^{\alpha'\bar{\alpha}}(\eta) \cup c^{\alpha'\tilde{\alpha}}(\eta)| = 1 \}, \quad (4.22)$$

for any $\alpha' \in \{w, e\}$ and $\bar{\alpha}, \tilde{\alpha} \in \{n, s\}$ such that $\bar{\alpha} \neq \tilde{\alpha}$, and

$$\mathcal{A}_1^\alpha := \{ \eta \in \mathcal{P}_{sa,1} : |r^\alpha(\eta) \cup c^{\alpha\alpha''}(\eta) \cup c^{\alpha\alpha'''}(\eta)| = 1 \}, \quad (4.23)$$

for any $\alpha \in \{n, s\}$ and $\alpha'', \alpha''' \in \{n, s\}$ such that $\alpha' \neq \alpha'''$. Note that in Figure 6 the configuration on the right-hand side is in \mathcal{A}_1^n .

Next, we define the subsets $\mathcal{A}_k^{\alpha, \alpha'}$ of the saddles in $\mathcal{P}_{sa,0}$ that are obtained from $\eta \in \mathcal{P}_{sa,0}$ during the sliding of the bar $B^{\alpha'}(\eta)$ around the frame-angle $c^{\alpha'\alpha}(\eta)$. More precisely,

$$\mathcal{A}_k^{\alpha, \alpha'} := \{ \eta \in \mathcal{P}_{sa,0} : |r^\alpha(\eta)| = k - 1, |r^{\alpha'}(\eta)| = l_2^* - k, |c^{\alpha'\alpha}(\eta)| = 1, (r^\alpha(\eta) \cup c^{\alpha'\alpha}(\eta)) \cap \eta_{cl} = r_{cl}^{\alpha,1} \dot{\cup} r_{cl}^{\alpha,2} \text{ with } d(r_{cl}^{\alpha,1}, r_{cl}^{\alpha,2}) = 2 \}, \quad (4.24)$$

where $\alpha \in \{n, s\}$, $\alpha' \in \{w, e\}$, $r_{cl}^{\alpha,1}, r_{cl}^{\alpha,2}$ are two disjoint connected components in $r^\alpha(\eta) \cup c^{\alpha'\alpha}(\eta)$ and $k = 2, \dots, l_2^*$. Note that the conditions in (4.24) guarantee that these configurations are obtained during a sliding of a bar around a frame-angle, that is identified by the indices α and α' . Note that in this case there is not the index k' as in [2, eq. (4.19)] and [2, eq. (4.37)] for the isotropic and weakly anisotropic cases respectively, because in the strongly anisotropic case less

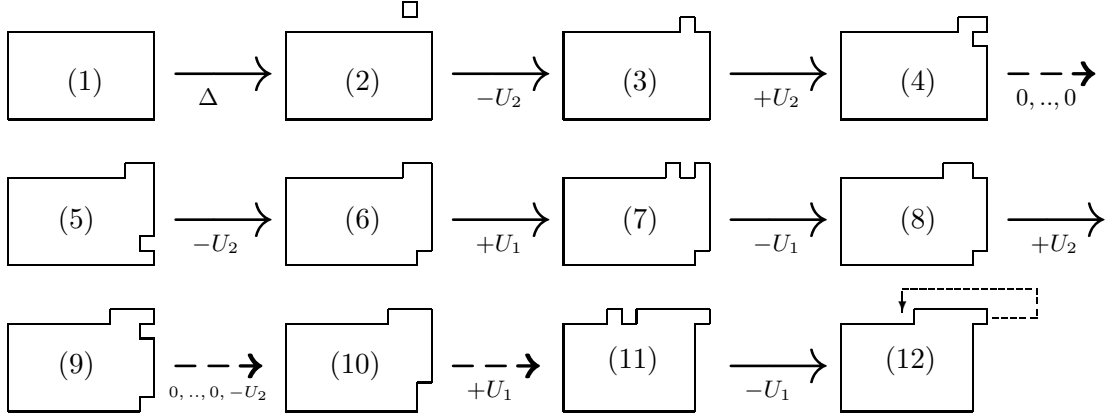

Figure 7: Transition column to row for $\mathcal{R}(2l_2^* - 1, l_2^* - 1)$ in the strongly anisotropic regime: the configuration (1) has energy equal to $\Gamma_{sa}^* - \Delta + U_2 - U_1$ and thus the configurations (7) and (11) have energy equal to Γ_{sa}^* . In (12) we indicate with a dashed arrow the detachment of the protuberance at cost U_1 and afterwards movement of the free particle until it connects to the cluster that decreases the energy by $U_1 + U_2$.

sliding on the border of the droplet are allowed. Indeed, in this case $l_2^* - 1$ denotes the length of the bar that we are sliding and thus we can consider $k' = l_2^* - 1$ fixed. The index k counts the number of particles that are in $r^\alpha(\eta) \cup c^{\alpha'\alpha}(\eta)$ during the sliding and can be less or equal than l_2^* . Referring to Figure 7, configuration (7) (resp. (11)) is an example of configuration that belongs to $\mathcal{A}_2^{n,e}$ (resp. $\mathcal{A}_{l_2^*}^{n,e}$). Note that the set $\mathcal{A}_k^{\alpha,\alpha'}$ contains $k - 1$ configurations for any α, α' and k , indeed these configurations are crossed during the sliding of the bar $B^{\alpha'}(\eta)$ around the frame-angle $c^{\alpha'\alpha}(\eta)$, with η the configuration obtained by $\mathcal{R}(2l_2^* - 1, l_2^* - 1)$ adding a protuberance to one of its longest sides (in Figure 7 η corresponds to the configuration (3) and $\alpha = n, \alpha' = e$). Thus we set

$$\mathcal{A}_k^{\alpha,\alpha'} = \{\xi_1^{\alpha,\alpha'}, \dots, \xi_{k-1}^{\alpha,\alpha'}\}. \quad (4.25)$$

Now we are able to give the second main result of Section 4.2.

Theorem 4.10 (Union of minimal gates for strongly anisotropic interactions). *We obtain the following description for $\mathcal{G}_{sa}(\square, \blacksquare)$:*

$$\mathcal{G}_{sa}(\square, \blacksquare) = \mathcal{C}_{sa}^* \cup \bigcup_{\alpha} \bigcup_{\alpha'} \bigcup_{k=2}^{l_2^*} \mathcal{A}_k^{\alpha,\alpha'} \cup \bigcup_{\alpha'} \mathcal{A}_0^{\alpha'} \cup \bigcup_{\alpha} \mathcal{A}_1^{\alpha} \quad (4.26)$$

We refer to Section 7.2 for the proof of Theorem 4.10.

4.3 Main results: sharp asymptotics for strongly anisotropic interactions

If the reader is interested in the sharp asymptotics below can find the proofs in Section 8. For a model-independent discussion concerning the prefactor we refer to [2, Section 10.1]. Theorem 4.11 investigates the prefactor for the strongly anisotropic case. This analysis for the isotropic case is given in [13, Theorem 1.4.4], while for the weakly anisotropic case is given in [2, Theorem 4.13].

Theorem 4.11 *There exists a constant $K_{sa} = K_{sa}(\Lambda, l_2^*)$ such that*

$$\mathbb{E}_{\square}(\tau_{\blacksquare}) = K_{sa} e^{\Gamma_{sa}^* \beta} [1 + o(1)], \quad \beta \rightarrow \infty, \quad (4.27)$$

with

$$\frac{1}{\Theta_1^{sa}} \leq K_{sa} \leq \frac{1}{\Theta_2^{sa}}, \quad (4.28)$$

where Θ_1^{sa} and Θ_2^{sa} are defined in (8.18) and (8.29) respectively. Moreover, as $\Lambda \rightarrow \mathbb{Z}^2$,

$$K_{sa}(\Lambda, l_2^*) \rightarrow \frac{1}{4\pi N_{sa}} \frac{\log |\Lambda|}{|\Lambda|} \quad (4.29)$$

with

$$N_{sa} = \sum_{k=1}^4 \binom{4}{k} \binom{l_2^* + k - 2}{2k - 1} \quad (4.30)$$

the cardinality of $\bar{\mathcal{D}}_{sa} = \bar{\mathcal{D}}_{sa}(\Lambda, l_2^*)$ modulo shifts.

Remark 4.12 *For the strongly anisotropic case we obtain a sharp estimate of K_{sa} in (4.28). Nevertheless, the asymptotic behavior of the prefactor K_{sa} as $\Lambda \rightarrow \mathbb{Z}^2$ (see (4.29)) is the same as K_{wa} (see [2, eq. (4.40)]) and K_{is} (see [13, eq. (1.4.9)]).*

Remark 4.13 *Note that [13, Theorem 1.4.3(iii)] and [2, Theorem 4.14] concerning the uniform entrance distribution in the gate does not hold for the strongly anisotropic case due to the two possible entrance mechanisms in \mathcal{C}_{sa}^* (see Lemma 6.17).*

We define the *mixing time* as

$$t_{\beta}^{mix}(\varepsilon) := \min\{n \geq 0 : \max_{x \in \mathcal{X}} \|P_{\beta}^n(x, \cdot) - \mu_{\beta}(\cdot)\|_{TV} \leq \varepsilon\}, \quad (4.31)$$

where $\|\nu - \nu'\|_{TV} := \frac{1}{2} \sum_{x \in \mathcal{X}} |\nu(x) - \nu'(x)|$ for any two probability distributions ν, ν' on \mathcal{X} . The *spectral gap* of the Markov chain is defined as

$$\rho_{\beta} := a_{\beta}^{(2)} \quad (4.32)$$

where $1 = a_{\beta}^{(1)} > a_{\beta}^{(2)} \geq \dots \geq a_{\beta}^{(|\mathcal{X}|)} \geq -1$ are the eigenvalues of the matrix $(P(x, y))_{x, y \in \mathcal{X}}$ defined in (2.9).

Theorem 4.14 *For any $\varepsilon \in (0, 1)$*

$$\lim_{\beta \rightarrow \infty} \frac{1}{\beta} \log t_{\beta}^{mix}(\varepsilon) = \Gamma_{sa}^* = \lim_{\beta \rightarrow \infty} -\frac{1}{\beta} \log \rho_{\beta} \quad (4.33)$$

Furthermore, there exist two constants $0 < c_1 \leq c_2 < \infty$ independent of β such that for every $\beta > 0$

$$c_1 e^{-\beta \Gamma_{sa}^*} \leq \rho_{\beta} \leq c_2 e^{-\beta \Gamma_{sa}^*} \quad (4.34)$$

Theorem 4.14 holds also for the isotropic and weakly anisotropic cases (see [2, Theorem 4.15]).

5 Main results for the simplified model

In this Section we focus on the simplified model described in Section 2.3 for $int = sa$. The case $int = is$ has been already studied in [40], see [40, Theorem 1.53] and [2, Theorem 5.1] for the main results, while for the case $int = wa$ see [2, Theorem 5.2]. In this paper we extend the result obtained in [40] for $int = sa$ (see Theorem 5.1(a)-(c)) and we derive a further result concerning the union of the minimal gates for $int = sa$ (see Theorem 5.1(d)). In this Section we set τ_A as the first hitting time of the dynamics in A for $A \subseteq \mathcal{X}^\beta$.

Theorem 5.1 *Let $int = sa$. Fix $\Delta \in (U_1 + \frac{U_2}{2}, U_1 + U_2)$, with $U_2/(U_1 + U_2 - \Delta)$ not integer, and $U_1 > 2U_2$. Suppose that $\lim_{\beta \rightarrow \infty} \frac{1}{\beta} \log |\Lambda_\beta| = \infty$.*

(a) *Let $\mathcal{R}^{\leq(l_1, l_2)}$ (resp. $\mathcal{R}^{\geq(l_1, l_2)}$) be the set of configurations whose single contour is a rectangle contained in (resp. containing) a rectangle with sides l_1 and l_2 . Then*

$$\begin{aligned} \text{if } \eta \in \mathcal{J}^\beta(\mathcal{R}^{\leq(2l_2^*-3, l_2^*)}) \text{ or } \eta \in \mathcal{J}^\beta(\mathcal{R}^{\leq(2l_2^*-1, l_2^*-1)}) &\implies \lim_{\beta \rightarrow \infty} \mathbb{P}_{\nu_\eta}(\tau_{\square^\beta} < \tau_{\blacksquare^\beta}) = 1, \\ \text{if } \eta \in \mathcal{J}^\beta(\mathcal{R}^{\geq(2l_2^*-2, l_2^*)}) &\implies \lim_{\beta \rightarrow \infty} \mathbb{P}_{\nu_\eta}(\tau_{\blacksquare^\beta} < \tau_{\square^\beta}) = 1. \end{aligned} \quad (5.1)$$

(b) *The set of configurations $\mathcal{J}^\beta(\mathcal{C}_{sa}^*)$, with \mathcal{C}_{sa}^* defined in (4.18), is a gate for the transition from \square^β to \blacksquare^β and there exists $c > 0$ such that, for sufficiently large β ,*

$$\mathbb{P}_{\nu_{\square}}(\tau_{\mathcal{J}^\beta(\mathcal{C}_{sa}^*)} > \tau_{\blacksquare^\beta}) \leq e^{-\beta c}. \quad (5.2)$$

(c) *For any $\delta > 0$,*

$$\lim_{\beta \rightarrow \infty} \mathbb{P}_{\nu_{\square}}(e^{\beta(\Gamma_{sa}^* - \delta)} < \tau_{\blacksquare^\beta} < e^{\beta(\Gamma_{sa}^* + \delta)}) = 1. \quad (5.3)$$

(d) *The union of minimal gates $\mathcal{G}_{sa}(\square^\beta, \blacksquare^\beta)$ for the transition from \square^β to \blacksquare^β is*

$$\mathcal{G}_{sa}(\square^\beta, \blacksquare^\beta) = \mathcal{J}^\beta(\mathcal{C}_{sa}^*) \cup \bigcup_{\alpha} \bigcup_{\alpha'} \bigcup_{k=2}^{l_2^*} \mathcal{J}^\beta(\mathcal{A}_k^{\alpha, \alpha'}) \cup \bigcup_{\alpha'} \mathcal{J}^\beta(\mathcal{A}_0^{\alpha'}) \cup \bigcup_{\alpha} \mathcal{J}^\beta(\mathcal{A}_1^{\alpha}), \quad (5.4)$$

where the sets $\mathcal{A}_0^{\alpha'}$, \mathcal{A}_1^{α} and $\mathcal{A}_k^{\alpha, \alpha'}$ are defined in (4.22), (4.23) and (4.24) respectively.

We refer to Section 9 for the proof of the Theorem.

6 Useful model-dependent definitions and tools

In this Section (and only here) we set

$$\mathcal{Q}_{sa} = \bar{\mathcal{Q}}_{sa}, \quad \mathcal{D}_{sa} = \bar{\mathcal{D}}_{sa}, \quad (6.1)$$

to show the similarities between the results with the isotropic model.

6.1 Geometric description of the protocritical droplets

In [13, Theorem 1.4.1] the authors obtain the geometric description of the set \mathcal{D}_{is} as $\mathcal{D}_{is} = \bar{\mathcal{D}}_{is} \cup \tilde{\mathcal{D}}_{is}$. In this Section we derive the geometric description of the analogous sets for the strongly anisotropic models $\bar{\mathcal{D}}_{sa}$ and $\tilde{\mathcal{D}}_{sa}$ following the argument proposed in [13]. The geometric description of the sets $\bar{\mathcal{D}}_{wa}$ and $\tilde{\mathcal{D}}_{wa}$ is given in [2, Proposition 7.1]. Recall definition (4.17).

Proposition 6.1 (Geometric description of $\tilde{\mathcal{D}}_{sa}$ and $\bar{\mathcal{D}}_{sa}$). *We obtain the following geometric description of $\tilde{\mathcal{D}}_{sa}$ and $\bar{\mathcal{D}}_{sa}$:*

- (a) $\tilde{\mathcal{D}}_{sa} = \{\eta \in \mathcal{X} : n(\eta) = 0, v(\eta) = 2l_2^* - 4, \eta_{cl} \text{ is connected and monotone,}$
 $1 \leq |r^\alpha(\eta) \cup c^{\alpha\alpha'}(\eta)| \leq 2, |r^\alpha(\eta)| \leq 1, \text{ with } \alpha \in \{n, s\}, \alpha' \in \{w, e\}, \text{ and}$
 $\text{circumscribed rectangle in } \mathcal{R}(2l_2^* - 3, l_2^* + 1)\},$
- (b) $\bar{\mathcal{D}}_{sa}$ is the set of configurations having one cluster η anywhere in Λ_0 consisting of a $(2l_2^* - 4) \times (l_2^* - 2)$ rectangle with four bars $B^\alpha(\eta)$, with $\alpha \in \{n, w, e, s\}$, attached to its four sides satisfying

$$1 \leq |B^w(\eta)|, |B^e(\eta)| \leq l_2^*, \quad l_2^* - 1 \leq |B^n(\eta)|, |B^s(\eta)| \leq 2l_2^* - 2, \quad (6.2)$$

and

$$\sum_{\alpha} |B^\alpha(\eta)| - \sum_{\alpha\alpha' \in \{nw, ne, sw, se\}} |c^{\alpha\alpha'}(\eta)| = 5l_2^* - 7. \quad (6.3)$$

Remark 6.2 Let $\eta \in \bar{\mathcal{D}}_{sa}$.

(i) Note that (6.3) takes into account the number of occupied unit squares in $\partial^- CR(\eta)$ due to Remark 4.2. We deduce that at most three frame-angles of $CR(\eta)$ can be occupied, otherwise $|\partial^- CR(\eta)| = 6l_2^* - 8 > 5l_2^* - 7$, which is absurd.

(ii) Since $|B^s(\eta)| + |B^e(\eta)| \leq 3l_2^* - 6 + k - |c^{nw}(\eta)|$, we get

$$|B^n(\eta)| + |B^w(\eta)| = 5l_2^* - 7 - (|B^s(\eta)| + |B^e(\eta)|) + k \geq 2l_2^* - 1 + |c^{nw}(\eta)|. \quad (6.4)$$

By symmetry, we generalize the inequality above for any $\alpha \in \{n, s\}$ and $\alpha' \in \{w, e\}$: we get $|B^\alpha(\eta)| + |B^{\alpha'}(\eta)| \geq 2l_2^* - 1 + |c^{\alpha\alpha'}(\eta)|$.

Proof of Proposition 6.1 (a) We introduce only in the proof of this result the following geometrical definition to make the argument more clear

$$\tilde{\mathcal{D}}_{sa}^{geo} := \{\eta \in \mathcal{X} : n(\eta) = 0, v(\eta) = 2l_2^* - 4, \eta_{cl} \text{ is connected and monotone,}$$

 $1 \leq |r^\alpha(\eta) \cup c^{\alpha\alpha'}(\eta)| \leq 2, |r^\alpha(\eta)| \leq 1, \text{ with } \alpha \in \{n, s\}, \alpha' \in \{w, e\}, \text{ and}$
 $\text{circumscribed rectangle in } \mathcal{R}(2l_2^* - 3, l_2^* + 1)\}. \quad (6.5)$

The proof will be given in two steps:

- (i) $\tilde{\mathcal{D}}_{sa}^{geo} \subseteq \tilde{\mathcal{D}}_{sa}$;
(ii) $\tilde{\mathcal{D}}_{sa}^{geo} \supseteq \tilde{\mathcal{D}}_{sa}$.

Proof of (i). To prove (i) we must show that for all $\eta \in \tilde{\mathcal{D}}_{sa}^{geo}$,

- (i1) $H(\eta) = H(\tilde{\mathcal{Q}}_{sa})$;

(i2) $\exists \omega : \tilde{\mathcal{Q}}_{sa} \rightarrow \eta$, i.e., $\omega = (\omega_1, \dots, \omega_k = \eta)$ such that $\max_i H(\omega_i) \leq H(\tilde{\mathcal{Q}}_{sa}) + U_1$, with $|\omega_i| = n_{sa}^c$ for all $i = 1, \dots, k$ (see (4.16) for the definition of n_{sa}^c).

Proof of (i1). Any $\eta \in \tilde{\mathcal{D}}_{sa}^{geo}$ satisfies $n(\eta) = 0$, $|C(\eta)| = (2l_2^* - 3)(l_2^* + 1) - v(\eta) = n_{sa}^c$, and $g_1(\eta) = 2l_2^* - 3$ and $g_2(\eta) = l_2^* + 1$ since the configuration is monotone. Thus by (4.3) we deduce that H is constant on $\tilde{\mathcal{D}}_{sa}^{geo}$. Since $\tilde{\mathcal{Q}}_{sa} \subseteq \tilde{\mathcal{D}}_{sa}^{geo}$, this completes the proof of (i1).

Proof of (i2). Consider $\zeta \in \tilde{\mathcal{Q}}_{sa}$ and $\eta \in \tilde{\mathcal{D}}_{sa}^{geo}$. If $\eta \in \tilde{\mathcal{Q}}_{sa} \cap \tilde{\mathcal{D}}_{sa}^{geo}$, i.e., $|r^\alpha(\eta) \cup c^{\alpha\alpha'}(\eta)| = 1$ for some $\alpha \in \{n, s\}$ and $\alpha' \in \{w, e\}$, then η can be obtained from ζ by moving the protuberance at zero cost along the side which is attached to if the protuberance in ζ is on the same side as the protuberance in η , otherwise η can be obtained detaching the protuberance at cost U_2 and reattaching it to the other side at cost $-U_2$. If $\eta \in \tilde{\mathcal{D}}_{sa}^{geo} \setminus \tilde{\mathcal{Q}}_{sa}$, i.e., $|r^\alpha(\eta) \cup c^{\alpha\alpha'}(\eta)| = 2$ with $|r^\alpha(\eta)| = 1$ for some $\alpha \in \{n, s\}$ and $\alpha' \in \{w, e\}$, again we have two cases. If the protuberance in ζ is contained in $r^\alpha(\eta)$ (is in the same side of the rectangle), we deduce that η can be obtained from ζ by moving the protuberance at zero cost until it arrives at distance one from $c^{\alpha\alpha'}(\zeta)$ and then translate the bar $B^{\alpha'}(\zeta)$ towards the frame-angle $c^{\alpha\alpha'}(\zeta)$ at cost U_2 . Otherwise, if the protuberance in ζ is contained in $r^{\alpha''}(\eta)$ with $\alpha'' \in \{n, s\} \setminus \{\alpha\}$ (is in the opposite side of the rectangle), the path is constructed as before, provided that first the protuberance is detached at cost U_2 and reattached to the other side at cost $-U_2$. This concludes the proof of (i2).

Proof of (ii). By (i2), we know that all the configurations in $\tilde{\mathcal{D}}_{sa}^{geo}$ are connected via U_1 -path to $\tilde{\mathcal{Q}}_{sa}$. Since $\tilde{\mathcal{Q}}_{sa} \subseteq \tilde{\mathcal{D}}_{sa} \cap \tilde{\mathcal{D}}_{sa}^{geo}$, in order to prove (ii) it suffices to show that following U_1 -paths it is not possible to exit $\tilde{\mathcal{D}}_{sa}^{geo}$. Let $\eta' \in \tilde{\mathcal{D}}_{sa}^{geo}$, thus by (i1) and (4.20) we get $H(\eta') = \Gamma_{sa}^* - \Delta + U_1 - U_2$. Note that no particle can arrive because we impose that the number of particles is constant to n_{sa}^c thus, if $\eta' \in \tilde{\mathcal{D}}_{sa}^{geo} \setminus \tilde{\mathcal{Q}}_{sa}$, the unique possibility is to translate the bar $B^{\alpha'}(\eta')$, with $\alpha' \in \{w, e\}$, at cost U_2 giving rise to a configuration that is in $\tilde{\mathcal{D}}_{sa}^{geo} \cap \tilde{\mathcal{Q}}_{sa}$. Then it is possible either yo move the protuberance at zero cost, or to detach the protuberance at cost U_2 and then necessarily reattach it at cost $-U_2$, giving rise to a configuration that is still in $\tilde{\mathcal{D}}_{sa}^{geo} \cap \tilde{\mathcal{Q}}_{sa}$. Note that no other moves are allowed, since it is not possible to complete the sliding of a vertical bar around a frame-angle because the 1-translation of a horizontal bar costs U_1 . Indeed the latter implies that the energy reaches the value $\Gamma_{sa}^* - \Delta + 2U_1 - U_2 > \Gamma_{sa}^*$, thus the path described is not a U_1 -path. If $\eta' \in \tilde{\mathcal{D}}_{sa}^{geo} \cap \tilde{\mathcal{Q}}_{sa}$, with paths similar to the ones described above (possibly in different order), we can conclude case (a).

(b) We denote by $\bar{\mathcal{D}}_{sa}^{geo}$ the geometric set with the properties specified in point (b) that we introduce to make the argument more clear. The proof will be given in two steps:

(i) $\bar{\mathcal{D}}_{sa}^{geo} \subseteq \bar{\mathcal{D}}_{sa}$;

(ii) $\bar{\mathcal{D}}_{sa}^{geo} \supseteq \bar{\mathcal{D}}_{sa}$.

Proof of (i). To prove (i) we must show that for all $\eta \in \bar{\mathcal{D}}_{sa}^{geo}$,

(i1) $H(\eta) = H(\bar{\mathcal{Q}}_{sa})$;

(i2) $\exists \omega : \bar{\mathcal{Q}}_{sa} \rightarrow \eta$, i.e., $\omega = (\omega_1, \dots, \omega_k = \eta)$ such that $\max_i H(\omega_i) \leq H(\bar{\mathcal{Q}}_{sa}) + U_1$, with $|\omega_i| = n_{sa}^c$ for all $i = 1, \dots, k$ and $\omega_1 \in \bar{\mathcal{Q}}_{sa}$.

Proof of (i1). Any $\eta \in \bar{\mathcal{D}}_{sa}^{geo}$ satisfies $n(\eta) = 0$, $|C(\eta)| = (2l_2^* - 2)(l_2^* - 2) + 5l_2^* - 7 = n_{sa}^c$, and $g_1(\eta) = 2l_2^* - 2$ and $g_2(\eta) = l_2^*$ since the configuration is monotone. Thus by (4.3) we deduce that H is constant on $\bar{\mathcal{D}}_{sa}^{geo}$. Since $\bar{\mathcal{Q}}_{sa} \subseteq \bar{\mathcal{D}}_{sa}^{geo}$, this completes the proof of (i1).

Proof of (i2). Consider $\zeta \in \bar{\mathcal{Q}}_{sa}$ and $\eta \in \bar{\mathcal{D}}_{sa}^{geo}$. Here, without loss of generality, we assume that the protuberance is in $r^w(\zeta)$. Then we have

- $|B^w(\zeta)| = 1$;
- $|B^n(\zeta)| = |B^s(\zeta)| = 2l_2^* - 3$;
- $|B^e(\zeta)| = l_2^*$;
- $|c^{ne}(\zeta)| = |c^{se}(\zeta)| = 1$.

Using the sliding of a unit square around a frame-angle described in Figure 4 (see Definition 4.4), we move, one by one, $|B^n(\zeta)| - |B^n(\eta)|$ particles around the frame-angle $c^{nw}(\zeta)$. After that we move $|B^e(\zeta)| - |B^e(\eta)| + |B^s(\zeta)| - |B^s(\eta)|$ particles around the frame-angle $c^{sw}(\zeta)$. Finally, we move $|B^e(\zeta)| - |B^e(\eta)|$ particles around the frame-angle $c^{es}(\zeta)$. The result is the configuration $\eta \in \bar{\mathcal{D}}_{sa}^{geo}$. This concludes the proof of (i2).

Proof of (ii). By (i2), we know that all configurations in $\bar{\mathcal{D}}_{sa}^{geo}$ are connected via U_1 -path to $\bar{\mathcal{Q}}_{sa}$. Since $\bar{\mathcal{Q}}_{sa} \subseteq \bar{\mathcal{D}}_{sa} \cap \bar{\mathcal{D}}_{sa}^{geo}$, in order to prove (ii) it suffices to show that following U_1 -paths it is not possible to exit $\bar{\mathcal{D}}_{sa}^{geo}$. We call a path *clustering* if all the configurations in the path consist of a single cluster and no free particles. Below we will prove that for any $\eta \in \bar{\mathcal{D}}_{sa}^{geo}$ and any η' connected to η by a clustering U_1 -path, the following conditions hold:

- (A) $\text{CR}(\eta') = \text{CR}(\eta)$;
- (B) $\eta' \supseteq \text{CR}^-(\eta)$.

Proof of (A). Starting from any $\eta \in \mathcal{X}$, it is geometrically impossible to modify $\text{CR}(\eta)$ without detaching a particle, that contradicts the hypotheses of clustering U_1 -path.

Proof of (B). Fix $\eta \in \bar{\mathcal{D}}_{sa}^{geo}$. The proof is done in two steps.

1. First, we consider clustering U_1 -paths along which we do not move a particle from $\text{CR}^-(\eta)$. Along such paths we only encounter configurations in $\bar{\mathcal{D}}_{sa}^{geo}$ or configurations obtained from $\bar{\mathcal{D}}_{sa}^{geo}$ by breaking one of the bars in $\partial^- \text{CR}(\eta)$ into two pieces at cost U_1 (resp. U_2) if the bar is horizontal (resp. vertical). This holds because there is no particle outside $\text{CR}(\eta)$ that can lower the cost.

If the broken bar is horizontal, then only moves at zero cost are admissible, so any particle can be detached. This implies that the unique way to regain U_1 and complete the U_1 -path is to restore the bar.

If the broken bar is vertical, then the admissible moves in a U_1 -path are those with cost less or equal than $U_1 - U_2$. Again any particle can not be detached, indeed its cost is at least U_1 . The moves at cost U_2 are possible, thus it is possible to break another vertical bar. From now on, depending on $U_1 - 2U_2 > 0$, it is possible to break other vertical bars. More precisely, let $U_1 = nU_2 + \delta$, with $n \geq 2$ and $0 < \delta < U_2$ fixed, thus it is possible to break other $n - 2$ vertical bars in addition to the previous two. When this sequence of moves is completed, the unique way to complete the U_1 -path is to restore all the broken bars. Thus we have proved that $\eta' \supseteq \text{CR}^-(\eta)$.

2. Consider now a general clustering U_1 -path along which we move a particle from a corner of $\text{CR}^-(\eta)$. It is not allowed to move at cost $U_1 + U_2$, because it exceeds U_1 , thus the overshoot U_2 must be regained by letting the particle slide next to a bar that is attached to a side of $\text{CR}^-(\eta)$ (see Figure 8). If the particle moves vertically (resp. horizontally), we regain U_1 (resp. U_2). Since there are never two bars attached to the same side, we can at most regain U_1 , thus it is not possible to move a particle from $\text{CR}^-(\eta)$ other than from a corner. If the corner particle has

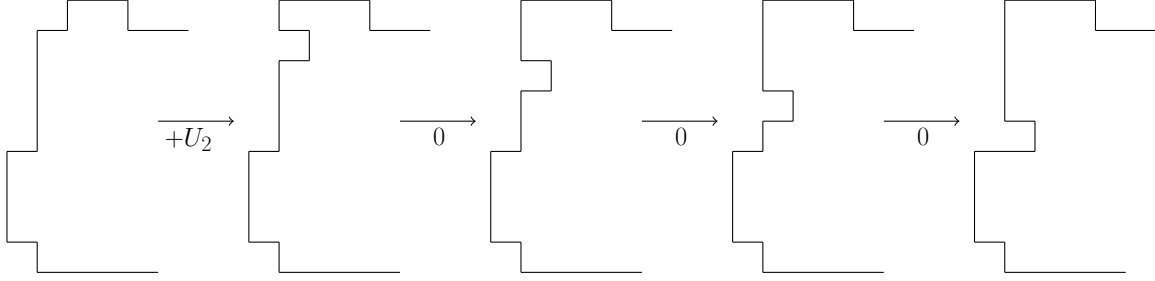

Figure 8: Creation and motion of the recess at cost 0.

been moved vertically (increasing the energy by U_2), the same moves (if possible) are allowed on another corner. Depending on the difference $U_1 - 2U_2 > 0$, it is possible to break some vertical bars. More precisely, let $U_1 = nU_2 + \delta$, with $n \geq 2$ and $0 < \delta < U_2$ fixed, it is possible to break $n - 2$ vertical bars. From now on, only moves at cost at most zero are admissible. There are no protuberances present anymore, because only the configurations in $\bar{\mathcal{Q}}_{sa}$ have a protuberance. Thus no particle outside $\text{CR}^-(\eta)$ can move, except those just detached from $\text{CR}^-(\eta)$. These particles can move back, in which case we return to the same configuration η (see Figure 8). In fact, all possible moves at zero cost consist in moving the recess just created in $\text{CR}^-(\eta)$ along the same side of $\text{CR}^-(\eta)$, until it reaches the top of the bar, after which it cannot advance anymore at zero cost (see Figure 8). All these moves do not change the energy, except the last one that returns the particle to its original position and regains U_1 . This concludes the proof of (B).

From (A), we deduce that $\text{CR}(\eta') = \mathcal{R}(2l_2^* - 2, l_2^*)$. From (A) and (B), we deduce that the number of particles that are in $\partial^- \text{CR}(\eta)$ is equal to the number of particles that are in $\partial^- \text{CR}(\eta')$, thus (6.3), $1 \leq |B^w(\eta')|, |B^e(\eta')| \leq l_2^*$ and $1 \leq |B^n(\eta')|, |B^s(\eta')| \leq 2l_2^* - 2$ hold. In order to prove that following clustering U_1 -paths it is not possible to exit $\bar{\mathcal{D}}_{sa}^{geo}$, we have to prove the lower bound in (6.2) for the lengths $|B^n(\eta')|$ and $|B^s(\eta')|$. We set

$$k = \sum_{\alpha' \in \{nw, ne, sw, se\}} |c^{\alpha'}(\eta')|. \quad (6.6)$$

Since $|B^w(\eta')| + |B^e(\eta')| \leq 2l_2^* - 4 + k$, by (6.3) we get

$$|B^n(\eta')| + |B^s(\eta')| = 5l_2^* - 7 - (|B^w(\eta')| + |B^e(\eta')|) + k \geq 3l_2^* - 3. \quad (6.7)$$

Since $|B^s(\eta')| \leq 2l_2^* - 2$, (6.7) implies

$$|B^n(\eta')| \geq 3l_2^* - 3 - |B^s(\eta')| \geq l_2^* - 1. \quad (6.8)$$

By symmetry we can similarly argue for the length $|B^s(\eta')|$. This implies that following U_1 -paths it is not possible to exit $\bar{\mathcal{D}}_{sa}^{geo}$. The argument goes as follows. Detaching a particle costs at least $U_1 + U_2$ unless the particle is a protuberance, in which case the cost is U_1 . The only configurations in $\bar{\mathcal{D}}_{sa}^{geo}$ having a protuberance are those in $\bar{\mathcal{Q}}_{sa}$. If we detach the protuberance from a configuration in $\bar{\mathcal{Q}}_{sa}$, then we obtain a $(2l_2^* - 3) \times l_2^*$ rectangle with a free particle. Since in the sequel only moves at zero cost are allowed, it is only possible to move the free particle. Since in a U_1 -path the particle number is conserved, the only way to regain U_1 and complete the U_1 -path is to reattach the free particle to a vertical side of the rectangle, thus return to $\bar{\mathcal{Q}}_{sa}$. This implies that for any $\eta \in \bar{\mathcal{D}}_{sa}^{geo}$ and any η' connected to η by a U_1 -path we must have that $\eta' \in \bar{\mathcal{D}}_{sa}^{geo}$. This concludes the proof. \square

6.2 Definitions

Since we are considering the strongly anisotropic model and some properties are in common with the isotropic and weakly anisotropic models, we choose the lower index $int \in \{is, wa, sa\}$ to make clear in the notation which of the three models we are referring to. We set

$$L_{sa}^* := L - l_2^*. \quad (6.9)$$

For $\eta \in \mathcal{C}_{sa}^*$, we associate $(\hat{\eta}, x)$ with $\hat{\eta} \in \mathcal{D}_{sa}$ protocritical droplet and $x \in \Lambda$ the position of the free particle. We denote by $\mathcal{C}_{sa}^G(\hat{\eta})$ (resp. $\mathcal{C}_{sa}^B(\hat{\eta})$) the configurations that can be reached from $(\hat{\eta}, x)$ by a path that moves the free particle towards the cluster and attaches the particle in $\partial^- CR(\hat{\eta})$ (resp. $\partial^+ CR(\hat{\eta})$). In Figure 9 on the left-hand side we depict explicitly the good and bad sites for a specific $\hat{\eta}$, where for $int = sa$ the horizontal and vertical lengths have to be changed to $2l_2^* - 2$ and l_2^* respectively. Let

$$\mathcal{C}_{sa}^G = \bigcup_{\hat{\eta} \in \mathcal{D}_{sa}} \mathcal{C}_{sa}^G(\hat{\eta}), \quad \mathcal{C}_{sa}^B = \bigcup_{\hat{\eta} \in \mathcal{D}_{sa}} \mathcal{C}_{sa}^B(\hat{\eta}). \quad (6.10)$$

For $\eta \in \mathcal{C}_{sa}^*$, let $\hat{\eta} \in \mathcal{D}_{sa}$ be the configuration obtained from η by removing the free particle. For $A \subseteq \Lambda$ and $x \in \Lambda$, recall that $d(x, A)$ denotes the lattice distance between x and A . As in [13, Section 3.5], we need the following definitions.

Definition 6.3 *Let Λ_4 be Λ without its four frame-angles. We define, recursively,*

$$B_1(\hat{\eta}) := \{x \in \Lambda_4 \mid x \notin \hat{\eta}, d(x, \hat{\eta}) = 1\} \quad (6.11)$$

and

$$\begin{aligned} B_2(\hat{\eta}) &:= \{x \in \Lambda_4 \mid x \notin \hat{\eta}, d(x, B_1(\hat{\eta})) = 1\}, \\ \bar{B}_2(\hat{\eta}) &:= B_2(\hat{\eta}), \end{aligned} \quad (6.12)$$

and

$$\begin{aligned} B_3(\hat{\eta}) &:= \{x \in \Lambda_4 \mid x \notin B_1(\hat{\eta}), d(x, B_2(\hat{\eta})) = 1\}, \\ \bar{B}_3(\hat{\eta}) &:= B_3(\hat{\eta}) \cup \{\bar{B}_2(\hat{\eta}) \cap \partial^- \Lambda_4\}, \end{aligned} \quad (6.13)$$

and for $i = 4, 5, \dots, L_{sa}^*$

$$\begin{aligned} B_i(\hat{\eta}) &:= \{x \in \Lambda_4 \mid x \notin B_{i-2}(\hat{\eta}), d(x, B_{i-1}(\hat{\eta})) = 1\}, \\ \bar{B}_i(\hat{\eta}) &:= B_i(\hat{\eta}) \cup \{\bar{B}_{i-1}(\hat{\eta}) \cap \partial^- \Lambda_4\}. \end{aligned} \quad (6.14)$$

In words, $B_1(\hat{\eta})$ is the ring of sites in Λ_4 at distance 1 from $\hat{\eta}$, while $\bar{B}_i(\hat{\eta})$ is the ring of sites in Λ_4 at distance i from $\hat{\eta}$ union all the sites in $\partial^- \Lambda_4$ at distance $1 < j < i$ from $\hat{\eta}$ ($i = 2, 3, \dots, L_{sa}^*$) (see Figure 9 on the right-hand side). Note that, depending on the location of $\hat{\eta}$ in Λ , the $\bar{B}_i(\hat{\eta})$ coincide for large enough i . The maximal number of rings is L_{sa}^* .

Now we need to introduce specific sets that will be crucial later on.

Definition 6.4 *We define*

$$\mathcal{C}_{sa}^*(i) := \{(\hat{\eta}, x) : \hat{\eta} \in \mathcal{D}_{sa}, x \in \bar{B}_i(\hat{\eta})\}, \quad i = 2, 3, \dots, L_{sa}^*. \quad (6.15)$$

First, note that the sets $\mathcal{C}_{sa}^*(i)$ are not disjoint.

Remark 6.5 *From the definitions of the set \mathcal{C}_{sa}^* , we deduce that*

$$\mathcal{C}_{sa}^* = \bigcup_{i=2}^{L_{sa}^*} \mathcal{C}_{sa}^*(i). \quad (6.16)$$

For this discussion in the case $int \in \{is, wa\}$ we refer to [2, Section 7.2].

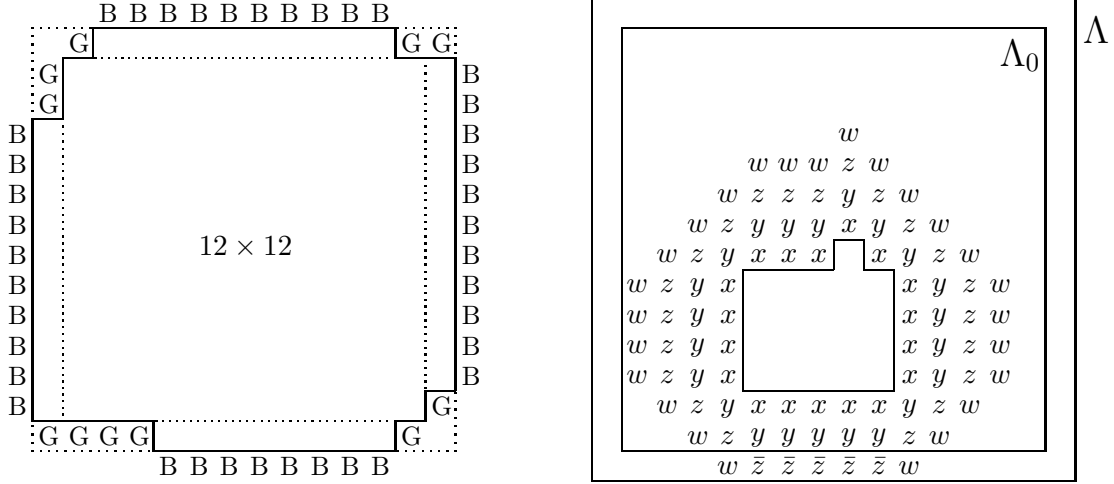

Figure 9: On the left-hand side we represent good sites (G) and bad sites (B) in the isotropic case. On the right-hand side we depict with x the sites in $B_1(\hat{\eta})$, with y the sites in $\bar{B}_2(\hat{\eta})$, with z and \bar{z} the sites in $\bar{B}_3(\hat{\eta})$ and with \bar{z} and w the sites in $\bar{B}_4(\hat{\eta})$.

6.3 Useful lemmas for the gates

In this Section we give some useful Lemmas that help us to characterize the gates. Here we state Lemma 6.6 for the case $int = sa$, but it holds also for the case $int \in \{is, wa\}$ (see [2, Lemma 7.6]). The proof is the same done in [2, Lemma 7.6] for the weakly anisotropic case.

Lemma 6.6 *Starting from $C_{sa}^* \setminus Q_{sa}^{fp}$, if the free particle is attached to a bad site obtaining $\eta^B \in C_{sa}^B$, the only transitions that does not exceed the energy Γ_{sa}^* are either detaching the protuberance, or a sequence of 1-translations of a bar or slidings of a bar around a frame-angle. Moreover, we get:*

- (i) *if it is possible to slide a bar around a frame-angle, then the saddles that are crossed are essential;*
- (ii) *if it is not possible to slide a bar around a frame-angle, then the path must come back to the starting configuration and the saddles that are crossed are unessential.*

Lemmas 6.8 and 6.9 are valid also in the case $int = wa$ (see [2, Lemma 7.8] and [2, Lemma 7.9] respectively), while Lemma 6.7 has a corresponding version for the case $int = wa$ (see [2, Lemma 7.7]).

Lemma 6.7 *Starting from $\eta^B \in C_{sa}^B$, the saddles obtained by a 1-translation of a bar are essential and in $\mathcal{A}_0^{\alpha'} \cup \mathcal{A}_1^{\alpha}$. Moreover, all the saddles in $\mathcal{A}_0^{\alpha'} \cup \mathcal{A}_1^{\alpha}$ can be obtained from this η^B by a 1-translation of a bar.*

Proof. Note that $H(\eta^B) = \Gamma_{sa}^* - U_2$ (resp. $H(\eta^B) = \Gamma_{sa}^* - U_1$) if the free particle has been attached to an horizontal (resp. vertical) bar. In the first case, in order to avoid exceeding the energy value Γ_{sa}^* it is possible to translate only the vertical bars. These saddles are in \mathcal{A}_1^{α} . In the latter case, it is possible to translate both vertical and horizontal bars. If the translated bar is horizontal, the saddles that are crossed are in $\mathcal{A}_0^{\alpha'}$. If the translated bar is vertical, the configurations obtained do not reach the level Γ_{sa}^* , thus they are not saddles. To conclude, all

the configurations in $\mathcal{A}_0^{\alpha'} \cup \mathcal{A}_1^\alpha$ can be obtained from a configuration η^B via a 1-translation of a bar.

It remains to prove that the saddles in $\mathcal{A}_0^{\alpha'} \cup \mathcal{A}_1^\alpha$ are essential. This part of the proof is analogue to the corresponding one done for $int = is$ in [2, Lemma 8.2]. \square

Lemma 6.8 *Starting from a configuration $\eta \in \mathcal{C}_{sa}^*$, it is not possible to slide a vertical bar around a frame-angle without exceeding the energy Γ_{sa}^* .*

With the following Lemma we can justify the definition of \mathcal{C}_{sa}^* given in (4.18).

Lemma 6.9 *Starting from $\tilde{\mathcal{D}}_{sa}$, the dynamics either passes through $\bar{\mathcal{D}}_{sa}$ or it is not possible that a free particle is created without exceeding the energy level Γ_{sa}^* .*

The proof of Lemmas 6.8 and 6.9 are analogue to the ones done for [2, Lemma 7.8] and [2, Lemma 7.9] respectively in the case $int = wa$ by replacing Γ_{wa}^* (resp. $\tilde{\mathcal{D}}_{wa}$) with Γ_{sa}^* (resp. $\tilde{\mathcal{D}}_{sa}$).

6.4 Model-dependent strategy

Our goal is to characterize the union of all the minimal gates for the strongly anisotropic interactions. To this end, due to [45, Theorem 5.1], we will characterize all the essential saddles for the transition from the metastable to the stable state. In this Section we apply the model-independent strategy explained in [2, Section 3.2] in order to identify some unessential saddles. Let $int = sa$. We apply [2, eq. (3.15)] both for $\sigma = \square$, $\mathcal{A} = \{\blacksquare\}$ and $\Gamma = \Gamma_{sa}^*$ defining $\mathcal{C}_{\blacksquare}^{\square}(\Gamma_{sa}^*)$, and for $\sigma = \blacksquare$, $\mathcal{A} = \{\square\}$ and $\Gamma = \Gamma_{sa}^* - H(\blacksquare)$ defining $\mathcal{C}_{\square}^{\blacksquare}(\Gamma_{sa}^* - H(\blacksquare))$. We chose this notation in order to emphasize the dependence on Γ_{sa}^* . First, we prove the required model-dependent inputs (iii)-(a) and (iii)-(b) in [2, Section 3.2] (see Proposition 6.10(i) and Proposition 6.10(ii)). Second, by Theorem 4.8, we know that \mathcal{C}_{sa}^* is a gate for the transition from \square to \blacksquare . Thus we apply the model-independent strategy explained in [2, Section 3.2] to Kawasaki dynamics by taking $m = \square$, $\mathcal{X}^s = \{\blacksquare\}$, $\mathcal{W}(m, \mathcal{X}^s) = \mathcal{C}_{sa}^*$, $\mathcal{L}^B = \mathcal{C}_{sa}^B$ and $\mathcal{L}^G = \mathcal{C}_{sa}^G$. In Proposition 6.11 we prove that $\mathcal{C}_{sa}^* \subseteq \mathcal{G}_{sa}(\square, \blacksquare)$, that allows us to study the essentiality only of the saddles that are not in \mathcal{C}_{sa}^* .

In order to apply [2, Propositions 3.3, 3.5], we need to characterize the sets K_{sa} and \tilde{K}_{sa} (see [2, eq. (3.16)] and [2, eq. (3.17)] respectively for the definitions). This is done in Proposition 6.12. Due to this result, our strategy consists in partitioning the saddles that are not in \mathcal{C}_{sa}^* in three types: the saddles that are in the boundary of $\mathcal{C}_{\blacksquare}^{\square}(\Gamma_{sa}^*)$, i.e., $\sigma \in \partial\mathcal{C}_{\blacksquare}^{\square}(\Gamma_{sa}^*) \cap (\mathcal{S}_{int}(\square, \blacksquare) \setminus \mathcal{C}_{sa}^*)$, the saddles that are in the boundary of $\mathcal{C}_{\square}^{\blacksquare}(\Gamma_{sa}^* - H(\blacksquare))$ and not in \tilde{K}_{sa} , i.e., $\zeta \in \partial\mathcal{C}_{\square}^{\blacksquare}(\Gamma_{sa}^* - H(\blacksquare)) \cap (\mathcal{S}_{sa}(\square, \blacksquare) \setminus (\mathcal{C}_{sa}^* \cup \tilde{K}_{sa}))$, and the remaining saddles $\xi \in \mathcal{S}_{sa}(\square, \blacksquare) \setminus (\partial\mathcal{C}_{\blacksquare}^{\square}(\Gamma_{sa}^*) \cup \partial\mathcal{C}_{\square}^{\blacksquare}(\Gamma_{sa}^* - H(\blacksquare)) \setminus \tilde{K}_{sa}) \cup \mathcal{C}_{int}^*$. By [2, Propositions 3.3, 3.5], we obtain Corollary 6.13 that states that the saddles of the first and second types are respectively unessential. In Proposition 6.14 we highlight some of the saddles of type three that are unessential. We need to distinguish these two cases due to the different entrance in \mathcal{C}_{int}^* for $int \in \{is, wa\}$ and $int = sa$ (see [2, Lemma 7.15] and Lemma 6.17 respectively). Note that in Proposition 6.14 the set $\partial\mathcal{C}_{\square}^{\blacksquare}(\Gamma_{sa}^* - H(\blacksquare)) \setminus \tilde{K}_{sa}$ reduces to $\partial\mathcal{C}_{\square}^{\blacksquare}(\Gamma_{sa}^* - H(\blacksquare))$ due to Proposition 6.12(ii). For the case $int \in \{is, wa\}$ this strategy is presented in [2, Section 7.4]. Finally, we identify the essential saddles of the third type in Proposition 7.3.

6.4.1 Main Propositions

In this Subsection we give the main results for our model-dependent strategy.

The next proposition shows that when the dynamics reaches \mathcal{C}_{sa}^G it has gone “over the hill”, while when it reaches \mathcal{C}_{sa}^B the energy has to increase again to the level Γ_{sa}^* to visit \square or \blacksquare . An analogue version for $int = is$ is proven in [13, Proposition 2.3.9] and for $int = wa$ is proven in [2, Proposition 7.10], while here we extend that result to $int = sa$ following a similar argument.

Proposition 6.10

- (i) If $\eta \in \mathcal{C}_{sa}^G$, then there exists a path $\omega : \eta \rightarrow \blacksquare$ such that $\max_{\zeta \in \omega} H(\zeta) < \Gamma_{sa}^*$.
- (ii) If $\eta \in \mathcal{C}_{sa}^B$, then there are no $\omega : \eta \rightarrow \square$ or $\omega : \eta \rightarrow \blacksquare$ such that $\max_{\zeta \in \omega} H(\zeta) < \Gamma_{sa}^*$.

Proof. The proof is analogue to the one done in [2, Proposition 7.10] for the weakly anisotropic case by using the reference path for the nucleation constructed in [3, Section 3.2]. \square

The next Proposition holds also in the case $int \in \{is, wa\}$ (see [2, Proposition 7.11]). We refer to Subsection 6.4.3 for the proof of Propositions 6.11, 6.12 and 6.14.

Proposition 6.11 $\mathcal{C}_{sa}^* \subseteq \mathcal{G}_{sa}(\square, \blacksquare)$.

For the corresponding result of Proposition 6.11 for $int \in \{is, wa\}$ we refer to [2, Proposition 7.11].

Proposition 6.12 *The following hold:*

- (i) $K_{sa} = \emptyset$;
- (ii) $\tilde{K}_{sa} \cap \partial \mathcal{C}_{\square}^{\blacksquare}(\Gamma_{sa}^* - H(\blacksquare)) = \emptyset$.

For the corresponding result of Proposition 6.12 for $int \in \{is, wa\}$ we refer to [2, Proposition 7.12].

Corollary 6.13 *The following hold:*

- (i) The saddles of the first type $\sigma \in \partial \mathcal{C}_{\blacksquare}^{\square}(\Gamma_{sa}^*) \cap (\mathcal{S}_{sa}(\square, \blacksquare) \setminus \mathcal{C}_{sa}^*)$ are unessential;
- (ii) The saddles of the second type $\zeta \in \partial \mathcal{C}_{\square}^{\blacksquare}(\Gamma_{sa}^* - H(\blacksquare)) \cap (\mathcal{S}_{sa}(\square, \blacksquare) \setminus \mathcal{C}_{sa}^*)$ are unessential.

Proof. Combining [2, Propositions 3.3, 3.5] and 6.12 we get the claim. \square

For the corresponding result of Corollary 6.13 for $int \in \{is, wa\}$ we refer to [2, Corollary 7.13].

Proposition 6.14 *Any saddle ξ that is neither in \mathcal{C}_{sa}^* , nor in $\bigcup_{k, \alpha, \alpha'} \mathcal{A}_k^{\alpha, \alpha'}$, nor in the boundary of the cycles $\mathcal{C}_{\blacksquare}^{\square}(\Gamma_{sa}^*)$ or $\mathcal{C}_{\square}^{\blacksquare}(\Gamma_{sa}^* - H(\blacksquare))$, i.e., $\xi \in \mathcal{S}_{sa}(\square, \blacksquare) \setminus (\partial \mathcal{C}_{\blacksquare}^{\square}(\Gamma_{sa}^*) \cup \partial \mathcal{C}_{\square}^{\blacksquare}(\Gamma_{sa}^* - H(\blacksquare))) \cup \mathcal{C}_{sa}^* \cup \bigcup_{k, \alpha, \alpha'} \mathcal{A}_k^{\alpha, \alpha'}$, such that $\tau_{\xi} < \tau_{\mathcal{C}_{sa}^B}$ is unessential. Therefore it is not in $\mathcal{G}_{sa}(\square, \blacksquare)$.*

For the corresponding result of Proposition 6.14 for $int \in \{is, wa\}$ we refer to [2, Proposition 7.14].

6.4.2 Useful Lemmas for the model-dependent strategy

In this Subsection we give some useful lemmas about the entrance in the gate and some properties of the sets $C_{sa}^*(i)$ with $i = 3, \dots, L_{sa}^*$. We stress that the behavior for $int \in \{is, wa\}$ is very different from that observed for $int = sa$, indeed we note that the weakly anisotropic model has some characteristics similar to the isotropic and some similar to the strongly anisotropic model. For the corresponding results obtained in the case $int \in \{is, wa\}$ we refer to [2, Subsection 7.4.2]. Recall (6.1) and (4.18) for the definitions of Q_{sa} , D_{sa} and C_{sa}^* . The next lemma generalizes [13, Proposition 2.3.8], proved for $int = is$, to the case $int = sa$ following similar arguments. In the case $int = wa$, this result is given in [2, Lemma 7.14]. The proof of Lemma 6.15 is analogue to the one done in [2, Lemma 7.15] for the weakly anisotropic case.

Lemma 6.15 (i) *Starting from $C_{sa}^* \setminus Q_{sa}^{fp}$, the only transitions that do not raise the energy are motions of the free particle in the region where the free particle is at lattice distance ≥ 3 from the protocritical droplet.*

(ii) *Starting from Q_{sa}^{fp} , the only transitions that do not raise the energy are motions of the free particle in the region where the free particle is at lattice distance ≥ 3 from the protocritical droplet and motions of the protuberance along the side of the rectangle where it is attached. When the lattice distance is 2, either the free particle can be attached to the protocritical droplet or the protuberance can be detached from the protocritical droplet and attached to the free particle, to form a rectangle plus a dimer. From the latter configuration the only transition that does not raise the energy is the reverse move.*

(iii) *Starting from C_{sa}^* , the only configurations that can be reached by a path that lowers the energy and does not decrease the particle number, are those where the free particle is attached to the protocritical droplet.*

Lemma 6.16 *The saddles in $C_{sa}^*(2)$ are essential.*

The proof of Lemma 6.16 is analogue to the one done in [2, Lemma 7.19] for the case $int \in \{is, wa\}$. The next Lemma investigates how the entrance in C_{sa}^* occurs. For the corresponding result that holds in the case $int \in \{is, wa\}$ see [2, Lemma 7.16]. We encourage the reader to inspect the difference between Lemma 6.17 and [2, Lemma 7.16], indeed the entrance in the gate in the strongly anisotropic case is peculiar and different with respect the isotropic and weakly anisotropic ones. Recall (4.24) and (4.25).

Lemma 6.17 *Any $\omega \in (\square \rightarrow \blacksquare)_{opt}$ enters C_{sa}^* in one of the following ways:*

- (i) *ω passes first through \bar{Q}_{sa} , then possibly through $\bar{D}_{sa} \setminus \bar{Q}_{sa}$, and finally reaches C_{sa}^* ;*
- (ii) *ω passes through the configuration $\mathcal{R}(2l_2^* - 1, l_2^* - 1)$, then a free particle is created and moved towards the rectangle until it is attached to an horizontal side $\alpha \in \{n, s\}$. Then for some $\alpha' \in \{w, e\}$ the path ω passes through the sets $\mathcal{A}_k^{\alpha, \alpha'}$ for all $k = 2, \dots, l_2^*$, and finally reaches $C_{sa}^*(2)$.*

Since in Lemma 6.17 we have proved that there are two possible ways to reach $C_{sa}^*(2)$, where the possibility (i) is analogue to the cases $int = is$ and $int = wa$, to find the minimal gates for sa for any $i = 3, \dots, L_{sa}^*$ we need to consider $C_{sa}^*(i)$ union some particular saddles belonging to the paths described in (ii).

Lemma 6.18 For any $i = 3, \dots, L_{sa}^*$ and $k = 2, \dots, l_2^*$ the set $\mathcal{C}_{sa}^*(i) \cup \bigcup_{\alpha, \alpha'} \{\xi_{j(k)}^{\alpha, \alpha'}\}$ is a minimal gate for all $1 \leq j(k) \leq k - 1$, where $\{\xi_{j(k)}^{\alpha, \alpha'}\}$ are the elements in $\mathcal{A}_k^{\alpha, \alpha'}$ defined in (4.24) and (4.25).

Remark 6.19 We encourage the reader to inspect the difference between the statement of Lemma 6.18 and [2, Lemma 7.16]: the sets $\mathcal{C}_{int}^*(i)$, with $i = 3, \dots, L_{int}^*$, are minimal gates if $int \in \{is, wa\}$, while $\mathcal{C}_{sa}^*(i)$ are not minimal gates for any $i = 3, \dots, L_{sa}^*$.

Lemma 6.20 For the strongly anisotropic interactions, we have

$$\mathcal{C}_{sa}^* \cup \bigcup_{k=2}^{l_2^*} \bigcup_{\alpha, \alpha'} \mathcal{A}_k^{\alpha, \alpha'} \subseteq \mathcal{G}_{sa}(\square, \blacksquare) \quad (6.17)$$

6.4.3 Proof of Propositions

Proof of Proposition 6.11 The statement of the Proposition follows by Lemma 6.20. \square

Proof of Proposition 6.12 The proof of (i) is analogue to the one done in [2, Proposition 7.12] for $int \in \{is, wa\}$.

Now we prove (ii). Let $\bar{\eta} \in \tilde{K}_{sa} \cap \partial \mathcal{C}_{\square}^{\blacksquare}(\Gamma_{sa}^* - H(\blacksquare))$. By the definition of the set \tilde{K}_{sa} we know that there exist $\eta \in \mathcal{C}_{sa}^*$ and $\omega = \omega_1 \circ \omega_2$ from η to \blacksquare with the properties described in [2, eq. (3.17)]. We know that η is composed by the union of a protocritical droplet $\hat{\eta} \in \mathcal{D}_{sa}$ and a free particle. Since $\omega_1 \cap \mathcal{C}_{sa}^* = \{\eta\}$, we note that $\eta \in \mathcal{C}_{sa}^*(2)$, otherwise the free particle has to cross at least $\bar{B}_2(\hat{\eta})$ and $\bar{B}_3(\hat{\eta})$, the latter in the configuration $\eta' \in \mathcal{C}_{sa}^*$, with $\eta' \neq \eta$, which contradicts the conditions in [2, eq. (3.17)]. Therefore, starting from η , by the optimality of the path we deduce that the unique admissible move is to attach the free particle to the cluster. If $\bar{\eta}$ is obtained from η by attaching the free particle in a good site giving rise to a configuration in $\mathcal{C}_{sa}^G(\hat{\eta})$, by Proposition 6.10(i) we know that $\omega_1 \cap \mathcal{C}_{\square}^{\blacksquare}(\Gamma_{sa}^* - H(\blacksquare)) \neq \emptyset$, that contradicts [2, eq. (3.17)], thus it is not possible to find ω_1 and ω_2 , therefore $\bar{\eta} \notin \tilde{K}_{sa}$, which is in contradiction with the assumption.

Assume now that $\bar{\eta}$ is obtained from η by attaching the free particle in a bad site giving rise to a configuration in $\mathcal{C}_{sa}^B(\hat{\eta})$. If $\eta \in \mathcal{Q}_{sa}^{fp}$, then by Lemma 6.15(ii) the unique admissible move is the reverse one, thus we may assume that $\eta \in \mathcal{C}_{sa}^* \setminus \mathcal{Q}_{sa}^{fp}$ and that the path does not go back to η , otherwise we can iterate this argument for a finite number of steps since the path has to reach \blacksquare . Starting from η , by Lemma 6.6 we know that $\bar{\eta}$ is obtained either via a sequence of 1-translations of a bar or via a sliding of a bar around a frame-angle. If a sequence of 1-translations takes place, by the optimality of the path we deduce that the unique possibility is either detaching the protuberance or sliding a bar around a frame-angle. In the first case the configuration that is obtained is in \mathcal{C}_{sa}^* and thus $\bar{\eta} \notin \tilde{K}_{sa}$, which contradicts the assumption. by (4.12), Proposition 6.1(b) (in particular conditions in (6.2)) and Lemma 6.8 we deduce that the only possibility to slide a bar around a frame-angle is that the bar is horizontal and it has length exactly $l_2^* - 1$. Thus the configurations visited by the path ω during this sliding are $\bar{\eta}_1, \dots, \bar{\eta}_m \in \mathcal{A}_k^{\alpha, \alpha'}$ for some $\alpha \in \{n, s\}$, $\alpha' \in \{w, e\}$ and $k = 2, \dots, l_2^* - 1$, while the last configuration $\bar{\eta}$ obtained when the last particle of the bar is detached is composed by the union of $\mathcal{R}(2l_2^* - 1, l_2^* - 1)$ and a free particle (see the time-reversal of the path described in Figure 7, in particular $\bar{\eta}_m$ is the configuration (7) and $\bar{\eta}$ is the configuration (2)). Therefore $\bar{\eta}$ belongs to the set \mathcal{B} defined in [3, eq. (3.29)] since $s(\bar{\eta}) = s_{sa}^* - 1$ and $p_2(\bar{\eta}) = l_2^* - 1$. Thus by [3, Theorem 3.7] we deduce that $\bar{\eta} \notin \mathcal{C}_{\square}^{\blacksquare}(\Gamma_{sa}^* - H(\blacksquare))$ and therefore $\bar{\eta}_m \notin \partial \mathcal{C}_{\square}^{\blacksquare}(\Gamma_{sa}^* - H(\blacksquare))$, that implies $\tilde{K}_{sa} \cap \partial \mathcal{C}_{\square}^{\blacksquare}(\Gamma_{sa}^* - H(\blacksquare)) = \emptyset$. \square

Proof of Proposition 6.14 The proof is analogue to the one done for [2, Proposition 7.13] in the case $int \in \{is, wa\}$, but in this case we use Lemmas 6.15(ii) and 6.17 and η is the union of a cluster $\hat{\eta} \in \mathcal{Q}_{sa}$ and a free particle at distance 2 from the cluster. Moreover, ξ_i is the union of a rectangle $(2l_2^* - 3) \times l_2^*$ with an horizontal dimer. \square

6.4.4 Proof of Lemmas

Proof of Lemma 6.17 By Theorem 4.8 we know that any $\omega \in (\square \rightarrow \blacksquare)_{opt}$ passes through \mathcal{C}_{sa}^* . We denote by η this configuration, that is composed by the union of a protocritical droplet $\hat{\eta} \in \bar{\mathcal{D}}_{sa}$ and a free particle in the site x . Note that there exists $i = 2, \dots, L_{sa}^*$ such that either $x \in B_i(\hat{\eta})$ if $d(\partial^- \Lambda_4, \hat{\eta}) > i$ or $x \in \bar{B}_i(\hat{\eta})$ if $d(\partial^- \Lambda_4, \hat{\eta}) \leq i$. We set $\omega = (\square, \omega_1, \dots, \omega_k, \eta) \circ \bar{\omega}$, where $\bar{\omega}$ is a path that connects η to \blacksquare such that $\max_{\sigma \in \omega} H(\sigma) \leq \Gamma_{sa}^*$. In order to analyze the entrance in \mathcal{C}_{sa}^* we consider the time-reversal of the path ω . Since $H(\eta) = \Gamma_{sa}^*$, the move from η to ω_k must have a non-positive cost and thus the unique admissible moves are:

- (i) either moving the free particle at zero cost;
- (ii) or removing a free particle at cost $-\Delta$;
- (iii) or attaching the free particle at cost $-U_1$ (resp. $-U_2$) or $-U_1 - U_2$.

Case (i). In this case we obtain that the configuration ω_k is still in \mathcal{C}_{sa}^* , thus it is analogue to η and therefore we can iterate the argument by taking this configuration as η .

Case (ii). In this case $H(\omega_k) = \Gamma_{sa}^* - \Delta$ and $\omega_k \in \bar{\mathcal{D}}_{sa}$. If $\omega_k \in \bar{\mathcal{Q}}_{sa}$ we get the claim, thus in the sequel we assume that $\omega_k \in \bar{\mathcal{D}}_{sa} \setminus \bar{\mathcal{Q}}_{sa}$. Since the path ω starts from \square , there exist $k_1 < k_2 < k$ such that $|\omega_{k_1}| = |\omega_k| - 1$ and there is a free particle in ω_{k_2} , i.e., $n(\omega_{k_2}) = 1$. Starting from ω_k and considering the time-reversal of the path ω , in order to obtain a free particle in ω_{k_2} we note that the minimal cost for detaching a particle is $U_1 + U_2$ giving rise to the energy value greater or equal than $\Gamma_{sa}^* - \Delta + U_1 + U_2 > \Gamma_{sa}^*$, which is in contradiction with the optimality of the path. Thus the unique possibility is detaching the protuberance from a configuration in $\bar{\mathcal{Q}}_{sa}$ at cost U_1 . This implies that ω_k is obtained via a U_1 -path starting from a configuration in $\bar{\mathcal{Q}}_{sa}$.

Case (iii). First, we consider the case where from η , again considering the time-reversal, we attach a particle at cost $-U_1$ giving rise to the configuration ω_k , i.e., $H(\omega_k) = \Gamma_{sa}^* - U_1$. Since the path ω starts from \square , there exists $k_1 < k$ such that $|\omega_{k_1}| = |\omega_k| - 1$, that implies that there exists a configuration $\omega_{\bar{k}}$ with a free particle during the transition from ω_{k_1} to ω_k (see Figure 7 where ω_k is configuration (12) and $\omega_{\bar{k}}$ is configuration (2)). If $\omega_{\bar{k}} \in \mathcal{C}_{sa}^*$, we can iterate the argument by taking this configuration as η . Otherwise if $\omega_{\bar{k}} \notin \mathcal{C}_{sa}^*$, we deduce that $(\omega_{\bar{k}})_{cl} \notin \bar{\mathcal{D}}_{sa}$. Starting from $\omega_{\bar{k}}$, since the activation of a sequence of 1-translations of bars of configurations in $\bar{\mathcal{D}}_{sa}$ gives rise to configurations that are in $\bar{\mathcal{D}}_{sa}$, the unique possibility in order not to exceed Γ_{sa}^* is that ω_k is obtained from $\omega_{\bar{k}}$ via a sliding of a bar, say $B^{\alpha'}(\omega_{\bar{k}})$, around a frame-angle, say $c^{\alpha'\alpha}(\omega_{\bar{k}})$. In order to do that, by (4.12) and Proposition 6.1(b), we deduce that the unique possibility to match the two conditions in (6.2) is that during the transition the path ω crosses $\mathcal{S}_{sa}(\square, \blacksquare)$ through the sets $\mathcal{A}_k^{\alpha, \alpha'}$ for any $k = 2, \dots, l_2^*$, with $\alpha \in \{n, s\}$, $\alpha' \in \{w, e\}$. In Figure 7 we represent this transition with $\alpha = n$, $\alpha' = e$ and the configurations (11)-(3) for the sliding. At the end of this sliding we obtain the configuration $\mathcal{R}(2l_2^* - 1, l_2^* - 1)$ union a free particle. This configuration must be obtained from $\mathcal{R}(2l_2^* - 1, l_2^* - 1)$ via adding a free particle, otherwise the path ω is not optimal.

Second, we consider the case where from η we attach a particle at cost $-U_2$ giving rise to the configuration ω_k , i.e., $H(\omega_k) = \Gamma_{sa}^* - U_2$. We argue in a similar way as above, but the difference is that in this case the sliding of a bar around a frame-angle at cost U_2 is not allowed by Lemma 6.8.

Third, we consider the case where from η we attach a particle at cost $-U_1 - U_2$ giving rise to the configuration ω_k , i.e., $H(\omega_k) = \Gamma_{sa}^* - U_1 - U_2$. Since $\eta_{cl} \in \bar{\mathcal{D}}_{sa}$, the unique possibility is that $\omega_k \in \mathcal{C}_{sa}^G(\hat{\eta})$, therefore by Lemma 6.10(i) we get $\omega_k \in \mathcal{C}_{\square}^{\blacksquare}(\Gamma_{sa}^* - H(\blacksquare))$. Since by Theorem 4.8 we know that \mathcal{C}_{sa}^* is a gate for the transition, we deduce that there exists $k_1 < k$ such that $\omega_{k_1} \in \mathcal{C}_{sa}^*$. Thus we can iterate the argument by taking this configuration as η . \square

Proof of Lemma 6.18 Let $i \in \{3, \dots, L_{sa}^*\}$, $k \in \{1, \dots, n\}$ and $1 \leq j(k) \leq k - 1$.

First, we prove that $\mathcal{C}_{sa}^*(i) \cup \bigcup_{\alpha, \alpha'} \{\xi_{j(k)}^{\alpha, \alpha'}\}$ is a gate. By Theorem 4.8 we know that any $\omega \in (\square \rightarrow \blacksquare)_{opt}$ crosses \mathcal{C}_{sa}^* . If the path ω enters \mathcal{C}_{sa}^* without crossing the set $\mathcal{P}_{sa,0}$, then by Lemma 6.17(i) we know that ω has to pass through $\mathcal{C}_{sa}^*(i)$. If the path ω enters \mathcal{C}_{sa}^* after crossing the set $\mathcal{P}_{sa,0}$, then by Lemma 6.17(ii) we know that $\omega \cap \bigcup_{\alpha, \alpha'} \{\xi_{j(k)}^{\alpha, \alpha'}\} \neq \emptyset$.

Now we prove that $\mathcal{C}_{sa}^*(i) \cup \bigcup_{\alpha, \alpha'} \{\xi_{j(k)}^{\alpha, \alpha'}\}$ is a minimal gate by showing that for any $\eta \in \mathcal{C}_{sa}^*(i) \cup \bigcup_{\alpha, \alpha'} \{\xi_{j(k)}^{\alpha, \alpha'}\}$ the set $(\mathcal{C}_{sa}^*(i) \cup \bigcup_{\alpha, \alpha'} \{\xi_{j(k)}^{\alpha, \alpha'}\}) \setminus \{\eta\}$ is not a gate: there exists $\omega \in (\square \rightarrow \blacksquare)_{opt}$ such that $\omega \cap ((\mathcal{C}_{sa}^*(i) \cup \bigcup_{\alpha, \alpha'} \{\xi_{j(k)}^{\alpha, \alpha'}\}) \setminus \{\eta\}) = \emptyset$. We consider separately the cases $\eta \in \bigcup_{\alpha, \alpha'} \{\xi_{j(k)}^{\alpha, \alpha'}\}$ and $\eta \in \mathcal{C}_{sa}^*(i)$.

Case 1. Let $\eta \in \bigcup_{\alpha, \alpha'} \{\xi_{j(k)}^{\alpha, \alpha'}\}$, thus $\eta = \xi_{j(k)}^{\bar{\alpha}, \bar{\alpha}'}$ for some $\bar{\alpha} \in \{n, s\}$ and $\bar{\alpha}' \in \{w, e\}$. We can define ω as the reference path defined in [3, Section 3.2] that crosses the configurations $\xi_1^{\bar{\alpha}, \bar{\alpha}'}, \dots, \xi_{k-1}^{\bar{\alpha}, \bar{\alpha}'}$, then it enters $\mathcal{C}_{sa}^*(2)$ and finally the free particle is attached in a good site without passing through $\mathcal{C}_{sa}^*(i)$ with $i = 3, \dots, L_{sa}^*$ (see Figure 7). From this configuration, the path proceeds towards \blacksquare as the one in Proposition 6.10(i). The constructed ω is optimal and $\omega \cap \bigcup_{\alpha, \alpha'} \{\xi_{j(k)}^{\alpha, \alpha'}\} = \{\xi_{j(k)}^{\bar{\alpha}, \bar{\alpha}'}\}$, thus this case is concluded.

Case 2. Let $\eta \in \mathcal{C}_{sa}^*(i)$. We take an arbitrary path starting from \square and that enters $\mathcal{C}_{sa}^*(i)$ in $\eta = (\hat{\eta}, z)$, where $\hat{\eta} \in \bar{\mathcal{D}}_{sa}$ is the protocritical droplet and z is the position of the free particle at distance i from the cluster. Then the path proceeds by moving the free particle from z to $\hat{\eta}$ such that, the distance between the free particle and $\hat{\eta}$ at the first step is strictly decreasing, and at the later steps is not increasing. Finally the free particle is attached in a good site $x \in \partial^- CR(\hat{\eta})$ giving rise to a configuration in $\mathcal{C}_{sa}^G(\hat{\eta})$. From this configuration, the path proceeds towards \blacksquare as the one in Proposition 6.10(i). Since the constructed $\omega \in (\square \rightarrow \blacksquare)_{opt}$ and $\omega \cap \mathcal{C}_{sa}^*(i) = \{\eta\}$, the proof is completed. \square

Proof of Lemma 6.20 By Lemma 6.16 we know that the saddles in $\mathcal{C}_{sa}^*(2)$ are essential and thus are in the set $\mathcal{G}_{sa}(\square, \blacksquare)$ due to [45, Theorem 5.1]. Furthermore, by Lemma 6.18 we know that $\mathcal{C}_{sa}^*(i) \cup \bigcup_{\alpha, \alpha'} \{\xi_{j(k)}^{\alpha, \alpha'}\}$ is a minimal gate for any $i = 3, \dots, L_{sa}^*$ and $j(k) = 1, \dots, k - 1$, with $k = 2, \dots, l_2^*$. Therefore we get

$$\mathcal{G}_{sa}(\square, \blacksquare) \supseteq \mathcal{C}_{sa}^*(2) \cup \bigcup_{i=3}^{L_{sa}^*} \bigcup_{k=2}^{l_2^*} \bigcup_{j(k), \alpha, \alpha'} (\mathcal{C}_{sa}^*(i) \cup \{\xi_{j(k)}^{\alpha, \alpha'}\}) = \mathcal{C}_{sa}^* \cup \bigcup_{k=2}^{l_2^*} \bigcup_{\alpha, \alpha'} \mathcal{A}_k^{\alpha, \alpha'} \quad (6.18)$$

\square

7 Proof of the main results: strongly anisotropic case

In this Section we give the proof of the main Theorems 4.8 and 4.10 (see Sections 7.1 and 7.2 respectively).

7.1 Proof of the main Theorem 4.8

In this Section we give the proof of the main Theorem 4.8. Now we recall the definition of the set \mathcal{P}_2 given in [3] as

$$\mathcal{P}_2 := \{\eta : n(\eta) = 1, v(\eta) = l_2^* - 1, \eta_{cl} \text{ is connected, monotone, with circumscribed rectangle in } \mathcal{R}(2l_2^* - 2, l_2^*)\}. \quad (7.1)$$

In particular, in order to state that the set \mathcal{C}_{sa}^* is a gate for the transition from \square to \blacksquare , we need the following

Lemma 7.1 *If $\omega \in (\square \rightarrow \blacksquare)_{opt}$ is such that $\omega \cap \mathcal{P}_2$, then $\omega \cap \mathcal{C}_{sa}^* \neq \emptyset$.*

We postpone the proof of Lemma 7.1 after the proof of the main Theorem 4.8.

Proposition 7.2 *If $\omega \in (\square \rightarrow \blacksquare)_{opt}$ is such that $\omega \cap \mathcal{P}_{sa,0} \neq \emptyset$, then $\omega \cap \mathcal{C}_{sa}^* \neq \emptyset$.*

We postpone the proof of Proposition 7.2 after the proof of Lemma 7.1.

Proof of the main Theorem 4.8 By [3, Theorem 2.4] taking $\mathcal{P}_1 = \mathcal{P}_{sa,0}$, we know that the set $\mathcal{P}_{sa,0} \cup \mathcal{P}_2$ is a gate for the transition from \square to \blacksquare . By Lemma 7.1 we know that every $\omega \in (\square \rightarrow \blacksquare)_{opt}$ that crosses \mathcal{P}_2 then crosses \mathcal{C}_{sa}^* , thus we deduce that the set $\mathcal{P}_{sa,0} \cup \mathcal{C}_{sa}^*$ is a gate. Furthermore, by Proposition 7.2 we obtain that every path $\omega \in (\square \rightarrow \blacksquare)_{opt}$ that crosses $\mathcal{P}_{sa,0}$ then crosses also \mathcal{C}_{sa}^* . This implies that every optimal path ω from \square to \blacksquare is such that $\omega \cap \mathcal{C}_{sa}^* \neq \emptyset$, thus \mathcal{C}_{sa}^* is a gate. \square

Proof of Lemma 7.1 Consider $\omega \in (\square \rightarrow \blacksquare)_{opt}$. If $\omega \cap \mathcal{C}_{sa}^* \neq \emptyset$, we get the claim. Thus we can reduce our analysis to the case in which the path ω reaches the set \mathcal{P}_2 in a configuration $\eta \in \mathcal{P}_2 \setminus \mathcal{C}_{sa}^*$. We set $\omega = (\square, \omega_1, \dots, \omega_k, \eta) \circ \bar{\omega}$, where $\bar{\omega}$ is a path that connects η to \blacksquare such that $\max_{\sigma \in \omega} H(\sigma) \leq \Gamma_{sa}^*$. We are interested in the time-reversal of the path. Since $\eta \in \mathcal{P}_2 \setminus \mathcal{C}_{sa}^*$, we know that it is composed by the union of a cluster $\text{CR}^-(\eta) = \mathcal{R}(2l_2^* - 4, l_2^* - 2)$, such that at least one frame-angle of $\text{CR}^-(\eta)$ is empty, a free particle and four bars attached to the four sides of $\text{CR}^-(\eta)$ in such a way that η contains $n_{sa}^c + 1$ particles (see (4.16) for the definition of n_{sa}^c). Suppose that $\text{CR}^-(\eta)$ contains x empty frame-angles, with $1 \leq x \leq 4$. See Figure 10(a) to visualize the configuration η in the case $x = 1$. Since $H(\eta) = \Gamma_{sa}^*$, the move from η to ω_k must have a non-positive cost and thus the unique admissible moves are:

- (i) either moving the free particle at zero cost;
- (ii) or removing the free particle;
- (iii) or attaching the free particle at cost $-U_1$ (see Figure 10(b)) or $-U_2$, or $-U_1 - U_2$.

Case (i). In this case the configuration ω_k is analogue to η and therefore we can iterate this argument by taking this configuration as η .

Case (ii). In this case $H(\omega_k) = \Gamma_{sa}^* - \Delta$. We may assume that the configuration ω_{k-1} is not obtained by ω_k via adding a free particle, otherwise ω_{k-1} is analogue to η and thus we can

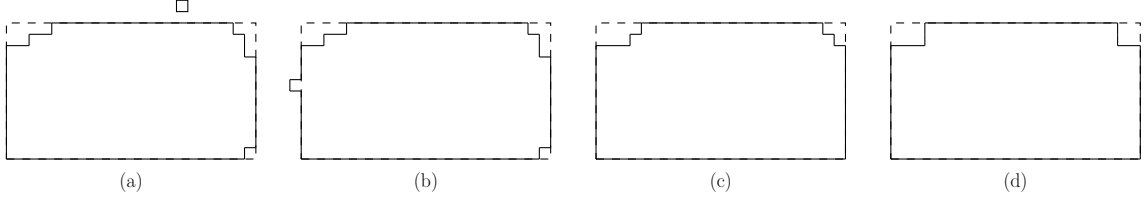

Figure 10: Here we depict in (a) the configuration η ; in (b) the configuration obtained by η by attaching the free particle at cost $-U_1$ to $B^w(\eta)$; in (c) the configuration η' obtained from η by attaching the free particle to $c^{se}(\eta)$ and then detaching the particle in $c^{nw}(\text{CR}^-(\eta))$ and attach it to $B^e(\eta)$, and in (d) the configuration η'' obtained from η' by detaching the particle in $c^{ne}(\text{CR}^-(\eta'))$ attach it to $B^n(\eta')$.

iterate the argument by taking this configuration as η . By the optimality of the path, again considering the time-reversal, we deduce that the unique admissible move to obtain ω_{k-1} from ω_k is breaking a horizontal (resp. vertical) bar at cost U_1 (resp. U_2). Thus it is possible that either a sequence of 1-translations of a bar or a sliding of a bar around a frame-angle takes place. In the first case, we obtain a configuration that is analogue to ω_{k-1} and thus we can iterate the argument for a finite number of steps, since the path has to reach \square . In the latter case, by Remark 6.2(ii) we deduce that the condition (4.12) is not satisfied and therefore it is not possible to complete any sliding of a bar around a frame-angle. This implies that the unique admissible moves are the reverse ones, thus we obtain a configuration that is analogue to ω_{k-1} and therefore we can iterate the argument for a finite number of steps, since the path has to reach \square . In this way we can reduce ourselves to consider the case (iii).

Case (iii). (a) We consider the case where from η , again considering the time-reversal, we attach a particle at cost $-U_1$ in $\partial^+\text{CR}(\eta)$ giving rise to the configuration ω_k , i.e., $H(\omega_k) = \Gamma_{sa}^* - U_1$ (see Figure 10(b)). Thus it is possible that either a sequence of 1-translations of a bar or a sliding of a bar around a frame-angle takes place. In the first case, we obtain a configuration that is analogue to ω_k and thus we can iterate the argument for a finite number of steps, since the path has to reach \square . In the latter case, by Remark 6.2(ii) we deduce that the condition (4.12) is not satisfied and therefore it is not possible to complete any sliding of a bar around a frame-angle. This implies that the unique admissible moves are the reverse ones, thus we obtain a configuration that is analogue to ω_k and therefore we can iterate the argument for a finite number of steps, since the path has to reach \square .

(b) We consider the case where from η , again considering the time-reversal, we attach a particle at cost $-U_2$ in $\partial^+\text{CR}(\eta)$ giving rise to the configuration ω_k , i.e., $H(\omega_k) = \Gamma_{sa}^* - U_2$. We argue in a similar way as above.

(c) We consider the case where from η , again considering the time-reversal, we attach a particle at cost $-U_1 - U_2$ in $\partial^-\text{CR}(\eta)$ giving rise to the configuration ω_k , i.e., $H(\omega_k) = \Gamma_{sa}^* - U_1 - U_2$. Thus it is possible either to have a sequence of 1-translations of a bar, or to have a sliding of a bar around a frame-angle, or to detach a particle at cost $U_1 + U_2$. In the first two possibilities, analogously to what has been discussed previously in (a) and (b), the unique admissible moves are the reverse ones and therefore we conclude as above. In the latter possibility, we have that either ω_{k-1} is obtained from ω_k by detaching a particle from a bar at cost $U_1 + U_2$ or from a corner of η that is in $\text{CR}^-(\eta)$. In the first case, the particle can be attached to an empty frame-angle of $\text{CR}^-(\eta)$ and we can repeat these steps at most $x - 1$ times (if $x \geq 2$), that implies that there exists $\bar{k} < k - 1$ such that $\omega_{\bar{k}}$ is composed by the union of a free particle and a rectangle $\mathcal{R}(2l_2^* - 4, l_2^* - 2)$ with four bars attached to its four sides in such a way that $\omega_{\bar{k}}$ contains $n_{sa}^c + 1$

particles, namely $\omega_k^- \in \mathcal{C}_{sa}^*$. In the second case, we may assume that the detached particle is attached to a bar in $\partial^- \text{CR}(\eta)$ giving rise to a configuration η' (see Figure 10(c)), otherwise we obtain a configuration that is analogue to η . Starting from η' , similarly we obtain η'' (see Figure 10(d)) if η' has a corner in $\text{CR}^-(\eta')$. If this is the case, we can proceed in a similar way until we obtain a configuration η''' that has no corner in $\text{CR}^-(\eta''')$. Starting from η''' , by the optimality of the path we deduce that the unique admissible moves are the reverse ones and therefore the path goes back to η . This concludes the proof. \square

Proof of Proposition 7.2 Consider any $\omega \in (\square \rightarrow \blacksquare)_{opt}$ such that $\omega \cap \mathcal{P}_{sa,0} \neq \emptyset$. We consider separately the following three cases.

Case (i). Assume that the path ω crosses the set $\mathcal{A} := \bigcup_{\alpha, \alpha', k} \mathcal{A}_k^{\alpha, \alpha'}$, with $\alpha \in \{n, s\}$, $\alpha' \in \{w, e\}$ and $k = 2, \dots, l_2^*$, in the configuration η . Since $H(\eta) = \Gamma_{sa}^*$, as long as the energy does not exceed Γ_{sa}^* , it is impossible to create a free particle before further lowering the energy by a quantity greater or equal than $U_1 + U_2$. Since $g_2'(\eta) = 1$, it is possible to connect at cost $-U_1$ the two protuberances or a bar and a protuberance. Moreover, there is no admissible move that costs $-U_2$, since $g_1'(\eta) = 0$ and there is no free particle that could be attached to an horizontal side of the cluster. Thus the only admissible moves are starting a sliding of a bar around a frame-angle $c^{\alpha\alpha'}(\eta)$ or $c^{\alpha'\alpha}(\eta)$, with $\alpha \in \{n, s\}$, $\alpha' \in \{w, e\}$, at cost less or equal than U_1 . We consider separately these two possibilities, that correspond to the two different directions to cross the path described in Figure 7 starting from the configuration η . More precisely, one of these possibilities (that we will analyze in (iA)), gives rise to the configuration (12), while the other (that will be treated in (iB)) corresponds to the time-reversal of the path described in Figure 7 starting from the configuration η .

(iA). In this situation it is possible to obtain one or more saddles ξ_1, \dots, ξ_{n-1} such that $\xi_i \in \mathcal{A}$ for all $i = 1, \dots, n-1$ and for the last configuration we have $|r^{\alpha'}(\xi_{n-1}) \cup c^{\alpha\alpha'}(\xi_{n-1})| = 1$, with $\alpha \in \{n, s\}$, $\alpha' \in \{w, e\}$ and $g_2'(\xi_{n-1}) = 1$ (see configuration (12) in Figure 7). From this configuration, since $H(\xi_{n-1}) = \Gamma_{sa}^*$, by the optimality of the path ω it is impossible to detach the protuberance before lowering the energy. Thus the unique admissible moves are either the reverse move or connect the protuberance and the bar at cost $-U_1$ and then detach the protuberance at cost U_1 (see the move starting from the configuration (12) in Figure 7 that is described with a dashed arrow). In the latter situation the path reaches a configuration $\xi_n \in \mathcal{C}_{sa}^*$. Thus we have to consider the possibilities that ω visits ξ_n and ω does not visit ξ_n . In the first possibility, since ω passes through $\xi_n \in \mathcal{C}_{sa}^*$ we get the claim. In the latter possibility, the path ω does not pass through the configuration ξ_n , but assume that the path ω visits the saddles ξ_i, \dots, ξ_j for some $1 \leq i \leq j \leq n-1$. We set $\omega = (\square, \omega_1, \dots, \omega_k, \xi_i, \zeta_i, \dots, \zeta_h, \xi_{i+1}, \zeta_{h+1}, \dots, \zeta_{h+m}, \dots, \xi_j) \circ \bar{\omega}$, where ζ_i, \dots, ζ_h are not saddles, but are crossed during the sliding of a bar around a frame-angle connecting ξ_i to ξ_{i+1} and so on. Moreover, $\bar{\omega}$ is a path that connects ξ_j to \blacksquare such that $\max_{\sigma \in \bar{\omega}} H(\sigma) \leq \Gamma_{sa}^*$. Note that the configuration ξ_j coincides with ξ_{i+1} in the case $j = i+1$. If $i = j$, we set $\omega = (\square, \omega_1, \dots, \omega_k, \xi_i) \circ \bar{\omega}$, where $\bar{\omega}$ is a path that connects ξ_i to \blacksquare such that $\max_{\sigma \in \bar{\omega}} H(\sigma) \leq \Gamma_{sa}^*$. To prove our statement we investigate the structure of the path ω before entering \mathcal{A} , namely we consider the time-reversal of the path. Since $\xi_i \in \mathcal{A}$ that implies $H(\xi_i) = \Gamma_{sa}^*$, we note that the move from ξ_i to ω_k must have a non-positive cost. Thus the admissible transitions from ξ_i to ω_k are either moving the particle at zero cost or moving a particle at cost $-U_1$. In the first case, we obtain a configuration that is analogue to ξ_i and therefore we can iterate for a finite number of steps this argument until we get the situation described in the latter case. In the latter case $H(\omega_k) = \Gamma_{sa}^* - U_1$, thus ω_{k-1} can be obtained from ω_k by breaking a bar at cost U_1 or U_2 , since it is not possible to detach any particle because its cost is at least $U_1 + U_2$. If the cost is U_1 , we deduce that ω_{k-1} is analogue to the initial

configuration ξ_i and thus we can iterate this argument for a finite number of steps, because the path has to reach \square . If the cost is U_2 , we can iterate this argument to deduce that starting from ω_k a sliding of a bar around a frame-angle takes place (see the time-reversal of the path described in Figure 7, where ω_{k-1} can be, for example, the configuration (9)). Since the path has to reach \square , this implies that there exists $k_1 < k$ such that ω_{k_1} is composed by the union of a rectangle $\mathcal{R}(2l_2^* - 1, l_2^* - 1)$ and a protuberance attached to one of the longest sides. Note that $H(\omega_{k_1}) = \Gamma_{sa}^* - U_1$. Furthermore, since either moving the protuberance along the side or detaching it from the cluster are the only admissible moves with $\max_{\sigma \in \omega} H(\sigma) \leq \Gamma_{sa}^*$, we note that there exists $k_2 < k_1$ such that the configuration ω_{k_2} is composed by the union of $\mathcal{R}(2l_2^* - 1, l_2^* - 1)$ and a free particle. Note that ω_{k_2} belongs to the set \mathcal{B} defined in [3, Definition 3.5] because $p_2(\omega_{k_2}) = l_2^* - 1$. Thus by [3, Theorem 3.7] we know that ω reaches a configuration in \mathcal{P}_2 . We get the claim by using Lemma 7.1.

(iB). Note that this situation can be treated as in (iA) for the case in which ω does not visit ξ_n , indeed without loss of generality we may assume that $\eta = \xi_i$ and then we proceed as above.

Case (ii). Assume that ω crosses the set $\mathcal{A}_0^{\alpha'} \cup \mathcal{A}_1^\alpha$ in the configuration η , with $\alpha \in \{n, s\}$ and $\alpha' \in \{w, e\}$. By Lemma 6.7 we know that η has been obtained from a configuration $\eta^B \in \mathcal{C}_{sa}^B$, thus there exists a configuration $\bar{\eta} \in \mathcal{C}_{sa}^*$ such that ω passes through $\bar{\eta}$ before crossing η^B .

Case (iii). Assume that ω crosses the set $\mathcal{P}_{sa,0} \setminus (\bigcup_{\alpha, \alpha', k} \mathcal{A}_k^{\alpha, \alpha'} \cup \bigcup_{\alpha'} \mathcal{A}_0^{\alpha'} \cup \bigcup_{\alpha} \mathcal{A}_1^\alpha)$ in the configuration η , thus the path ω crosses either $\eta^B \in \mathcal{C}_{sa}^B$ or $\eta^G \in \mathcal{C}_{sa}^G$ before passing through η . In the first case, η is obtained either via a 1-translation of a bar or via a sliding of a bar around a frame-angle that in both cases can not be completed because η is not in $\bigcup_{\alpha, \alpha', k} \mathcal{A}_k^{\alpha, \alpha'} \cup \bigcup_{\alpha'} \mathcal{A}_0^{\alpha'} \cup \bigcup_{\alpha} \mathcal{A}_1^\alpha$. Therefore the path ω , before crossing η^B , passes through a configuration $\bar{\eta} \in \mathcal{C}_{sa}^*$. In the latter case, we argue similarly. This concludes the proof. \square

7.2 Proof of the main Theorem 4.10

In this Section we analyze the geometry of the set $\mathcal{G}_{sa}(\square, \blacksquare)$ (recall (3.13)). In particular, we give the proof of the main Theorem 4.10 by giving in Proposition 7.3 the geometric characterization of the essential saddles of the third type that are not in \mathcal{C}_{sa}^* and that are visited after crossing the set \mathcal{C}_{sa}^B .

Proposition 7.3 *Any saddle ξ that is neither in \mathcal{C}_{sa}^* , nor in the boundary of the cycles $\mathcal{C}_{\blacksquare}^{\square}(\Gamma_{sa}^*)$ nor $\mathcal{C}_{\square}^{\blacksquare}(\Gamma_{sa}^* - H(\blacksquare))$ such that $\tau_\xi \geq \tau_{\mathcal{C}_{sa}^B}$ can be essential or not. For those essential we obtain the following description:*

$$\mathcal{G}_{sa}(\square, \blacksquare) \cap (\mathcal{S}_{sa}(\square, \blacksquare) \setminus (\partial \mathcal{C}_{\blacksquare}^{\square}(\Gamma_{sa}^*) \cup \partial \mathcal{C}_{\square}^{\blacksquare}(\Gamma_{sa}^* - H(\blacksquare)) \cup \mathcal{C}_{sa}^*)) = \bigcup_{\alpha} \bigcup_{\alpha'} \bigcup_{k=2}^{l_2^*} \mathcal{A}_k^{\alpha, \alpha'} \cup \bigcup_{\alpha'} \mathcal{A}_0^{\alpha'} \cup \bigcup_{\alpha} \mathcal{A}_1^\alpha \quad (7.2)$$

Remark 7.4 *In Proposition 6.14 we have proved that the saddles ξ of type three in Section 6.4 that are not in $\bigcup_{k, \alpha, \alpha'} \mathcal{A}_k^{\alpha, \alpha'}$ and such that $\tau_\xi < \tau_{\mathcal{C}_{sa}^B}$ are unessential. Note that we have not to study separately the essentiality of the saddles $\xi \in \bigcup_{k, \alpha, \alpha'} \mathcal{A}_k^{\alpha, \alpha'}$, since $\bigcup_{k, \alpha, \alpha'} \mathcal{A}_k^{\alpha, \alpha'}$ is included in the essential saddles ξ of type three such that $\tau_\xi \geq \tau_{\mathcal{C}_{sa}^B}$, analyzed in Proposition 7.3.*

We postpone the proof of Proposition 7.3 after the proof of the main Theorem 4.10.

Proof of Theorem 4.10 By Corollary 6.13 we know that the saddles of the first and second type, defined in [2, Definition 3.2] and [2, Definition 3.4] respectively, are unessential. By

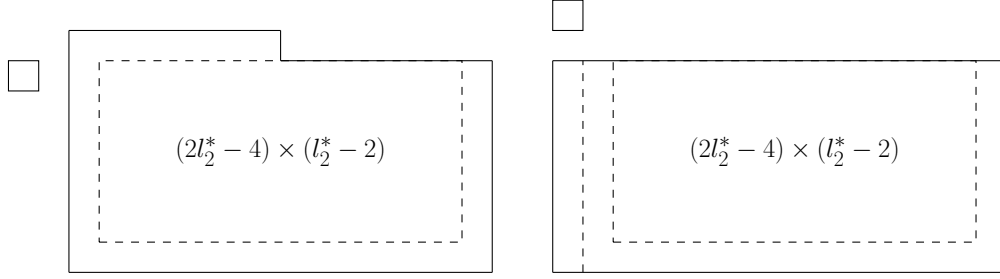

Figure 11: Case A: on the left-hand side we represent a possible starting configuration $\eta \in \mathcal{C}_{sa}^*$ and on the right-hand side the configuration η' obtained from η after the sliding of the bar $B^n(\eta)$ around the frame-angle $c^{nw}(\eta')$.

Propositions 6.14 and 7.3 we have the characterization of the essential saddles of the third type in Section 6.4. We use Proposition 6.11 to get the claim. \square

Proof Proposition 7.3 Consider a configuration $\eta \in \mathcal{C}_{sa}^*(2)$ such that $\eta = (\hat{\eta}, x)$, with $\hat{\eta} \in \bar{\mathcal{D}}_{sa}$ and $d(\hat{\eta}, x) = 2$. By Proposition 6.1(b), note that $\hat{\eta}$ consists of an $(2l_2^* - 4) \times (l_2^* - 2)$ rectangle with four bars $B^\alpha(\eta)$, with $\alpha \in \{n, s, w, e\}$, attached to its four sides satisfying

$$1 \leq |B^w(\eta)|, |B^e(\eta)| \leq l_2^*, \quad l_2^* - 1 \leq |B^n(\eta)|, |B^s(\eta)| \leq 2l_2^* - 2, \quad (7.3)$$

and

$$\sum_{\alpha} |B^\alpha(\eta)| - k = 5l_2^* - 7, \quad (7.4)$$

with $k = \sum_{\alpha\alpha' \in \{nw, ne, sw, se\}} |c^{\alpha\alpha'}(\eta)|$. Assume that the free particle is attached in a bad site obtaining a configuration $\eta' \in \mathcal{C}_{sa}^B$. Due to [45, Theorem 5.1], our strategy consists in characterizing the essential saddles that could be visited after attaching the free particle in a bad site. By Remark 6.2(i) we consider separately the following cases:

- A. three frame-angles of $\text{CR}(\hat{\eta})$ are occupied;
- B. two frame-angles of $\text{CR}(\hat{\eta})$ are occupied;
- C. one frame-angle of $\text{CR}(\hat{\eta})$ is occupied;
- D. no frame-angle of $\text{CR}(\hat{\eta})$ is occupied.

Note that from case A one can go to the other cases and viceversa, but since the path has to reach \blacksquare this back and forth must end in a finite number of steps.

Case A. Without loss of generality we consider η as in Figure 11 on the left-hand side. If we are considering the case in which a sequence of 1-translations of a bar is possible and takes place, then by Lemma 6.7 the saddles that are crossed are essential and in $\mathcal{A}_0^\alpha \cup \mathcal{A}_1^\alpha$. If a sequence of 1-translations of a bar takes place in such a way that the last configuration has at most two occupied frame-angles, then the saddles that are visited starting from it will be analyzed in cases B, C and D. Thus we are left to analyze the case in which there is the activation of a sliding of a bar around a frame-angle. In the following we quickly exclude the cases in which the particles is attached to $B^n(\eta)$, $B^s(\eta)$ or $B^e(\eta)$ and then explain the more interesting case in which it is attached to $B^w(\eta)$ giving rise to Figure 11 on the right-hand side. If the free particle is attached to the bar $B^n(\eta)$ (resp. $B^s(\eta)$), by Lemma 6.8 we know that it is not possible to complete the

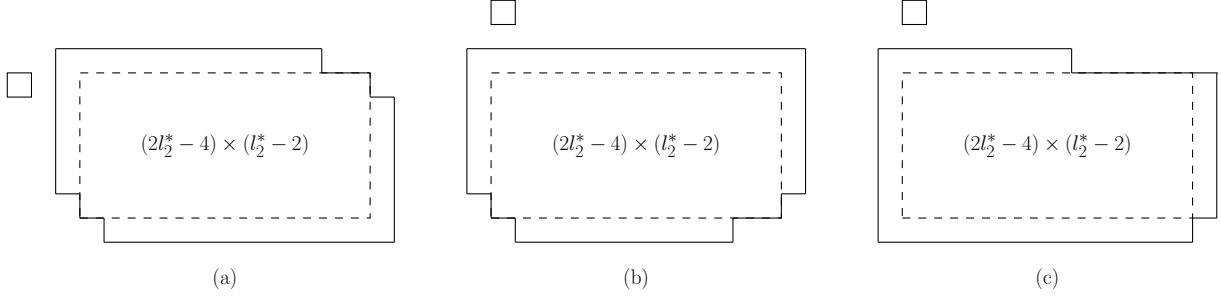

Figure 12: Case B(i): in (a) we depict a possible starting configuration $\eta \in \mathcal{C}_{sa}^*$. Case B(ii): in (b) we depict a possible starting configuration $\eta \in \mathcal{C}_{sa}^*$. Case B(iii): in (c) we depict a possible starting configuration $\eta \in \mathcal{C}_{sa}^*$.

sliding of the bar $B^w(\eta)$ (resp. $B^e(\eta)$) around the frame-angle $c^{wn}(\eta')$ (resp. $c^{es}(\eta')$). If the free particle is attached to the bar $B^e(\eta)$ or $B^w(\eta)$, then it is not possible to slide the bar $B^s(\eta)$ around the frame-angle $c^{se}(\eta')$ or $c^{sw}(\eta')$ respectively, since (4.12) is not satisfied. In the last two cases by Lemma 6.6(ii) we know that the saddles that are visited are unessential. This implies that the unique possibility to activate and complete a sliding of a bar around a frame-angle is attaching the free particle to the bar $B^w(\eta)$, then sliding the bar $B^n(\eta)$ around the frame-angle $c^{nw}(\eta')$ when $|B^n(\eta)| = l_2^* - 1$ and $|B^w(\eta)| = l_2^*$, otherwise (4.12) is not satisfied. The saddles that are possibly visited by the path we described are in $\mathcal{A}_{k,k'}^{\alpha,\alpha'}$ except the last one, thus by Lemma 6.6(i) they are essential. The last configuration visited during this sliding of a bar is depicted in Figure 11 on the right-hand side. This configuration has energy $\Gamma_{sa}^* - U_1 + U_2$ and therefore it is not a saddle. Starting from this configuration, by Lemma 6.17 we know that the saddles that could be visited are in \mathcal{C}_{sa}^* or again in $\mathcal{A}_{k,k'}^{\alpha,\alpha'}$. This concludes case A.

Case B. If we are considering the case in which a sequence of 1-translations of a bar is possible and takes place, then by Lemma 6.7 the saddles that are crossed are essential and in $\mathcal{A}_0^{\alpha'} \cup \mathcal{A}_1^{\alpha}$. We consider separately the following subcases:

- (i) The two occupied frame-angles are $c^{\alpha\alpha'}(\eta)$ and $c^{\alpha''\alpha'''}(\eta)$, with all the indices $\alpha, \alpha', \alpha'', \alpha'''$ different between each other (see Figure 12(a));
- (ii) The two occupied frame-angles are $c^{\alpha\alpha'}(\eta)$ and $c^{\alpha'\alpha''}(\eta)$, with $\alpha' \in \{n, s\}$ and $\alpha \neq \alpha''$ (see Figure 12(b));
- (iii) The two occupied frame-angles are $c^{\alpha\alpha'}(\eta)$ and $c^{\alpha'\alpha''}(\eta)$, with $\alpha' \in \{e, w\}$ and $\alpha \neq \alpha''$ (see Figure 12(c)).

Case B(i). Without loss of generality we consider η as in Figure 12(a). We can reduce our proof to the case in which there is no translation of a bar and therefore there is the activation of a sliding of a bar around a frame-angle. If the free particle is attached to the bar $B^n(\eta)$ (resp. $B^s(\eta)$), by Lemma 6.8 we know that it is not possible to complete the sliding of the bar $B^w(\eta)$ (resp. $B^e(\eta)$) around the frame-angle $c^{wn}(\eta')$ (resp. $c^{es}(\eta')$). By Lemma 6.6(ii), this implies that the saddles that could be crossed are unessential. If the free particle is attached to the bar $B^w(\eta)$ (resp. $B^e(\eta)$), it is possible to slide the bar $B^n(\eta)$ (resp. $B^s(\eta)$) around the frame-angle $c^{nw}(\eta')$ (resp. $c^{se}(\eta')$) when $|B^n(\eta)| < |B^w(\eta)|$ (resp. $|B^s(\eta)| < |B^e(\eta)|$), otherwise (4.12) is not satisfied. By (7.3) and (7.4) we note that $|B^n(\eta)| < |B^w(\eta)|$ (resp. $|B^s(\eta)| < |B^e(\eta)|$) is not possible and the case B(i) is concluded.

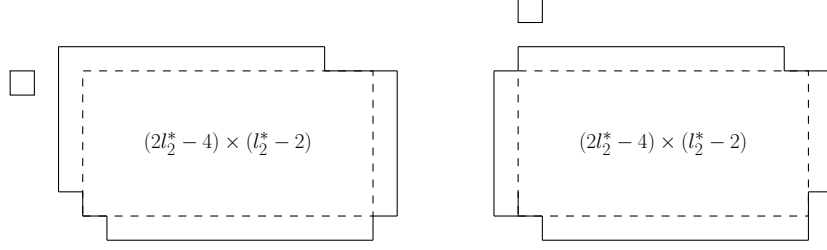

Figure 13: Case C: on the left-hand side we depict a possible starting configuration $\eta \in \mathcal{C}_{sa}^*$. Case D: on the right-hand side we depict a possible starting configuration $\eta \in \mathcal{C}_{sa}^*$.

Case B(ii). Without loss of generality we consider η as in Figure 12(b). If one bar among $B^w(\eta)$ and $B^e(\eta)$ is full, it is possible to translate $B^s(\eta)$ in order to have three occupied frame-angles. This situation has already been analyzed in case A. Thus we can reduce our proof to the case in which there is no translation of a bar and therefore there is the activation of a sliding of a bar around a frame-angle. If the free particle is attached to the bar $B^n(\eta)$ (or $B^s(\eta)$), by Lemma 6.8 we know that it is not possible to complete the sliding of a vertical bar around any frame-angle. If the free particle is attached to the bar $B^w(\eta)$ or $B^e(\eta)$, since the bar $B^n(\eta)$ is full, we deduce that (4.12) is not satisfied. This implies that it is not possible to slide the bar $B^n(\eta)$ around the frame-angle $c^{nw}(\eta')$ and $c^{ne}(\eta')$. In the last two cases by Lemma 6.6(ii) we know that the saddles that could be visited are unessential. This concludes case B(ii).

Case B(iii). Without loss of generality we consider η as in Figure 12(c). If the bar $B^n(\eta)$ (or $B^s(\eta)$) is full, it is possible to translate $B^e(\eta)$ to occupy the frame-angle $c^{ne}(\eta')$ (or $c^{se}(\eta')$). This situation has already been analyzed in case A. Otherwise, it is possible to translate a bar with one occupied frame-angle in order to have two occupied frame-angles in such a way that they have no bar in common. This situation has already been analyzed in case B(i). Thus we can reduce our proof to the case in which there is no translation of a bar and therefore we can consider only the activation of a sliding of a bar around a frame-angle. If the free particle is attached to the bar $B^n(\eta)$ (resp. $B^s(\eta)$), by Lemma 6.8 we know that it is not possible to complete the sliding of the bar $B^w(\eta)$ around the frame-angle $c^{wn}(\eta')$ (resp. $c^{ws}(\eta')$). If the free particle is attached to the bar $B^e(\eta)$, we deduce that (4.11) is not satisfied. In the last two cases by Lemma 6.6(ii) we know that the saddles that are visited are unessential. If the free particle is attached to the bar $B^w(\eta)$, it is possible to slide the bar $B^n(\eta)$ (resp. $B^s(\eta)$) around the frame-angle $c^{nw}(\eta')$ (resp. $c^{sw}(\eta')$) when $|B^n(\eta)| < |B^w(\eta)|$ (resp. $|B^s(\eta)| < |B^w(\eta)|$), otherwise (4.12) is not satisfied. By (7.3) and (7.4) we note that $|B^n(\eta)| < |B^w(\eta)|$ (resp. $|B^s(\eta)| < |B^w(\eta)|$) is not possible and the case B(iii) is concluded.

Case C. Without loss of generality we consider η as in Figure 13 on the left-hand side. If we are considering the case in which a sequence of 1-translations of a bar is possible and takes place, then by Lemma 6.7 the saddles that are crossed are essential and in $\mathcal{A}_0^{\alpha'} \cup \mathcal{A}_1^\alpha$. Starting from this configuration it is possible to obtain two occupied frame-angles, that it has been already analyzed in Case B. Thus we can reduce our proof to the case in which there is no translation of a bar and therefore there is the activation of a sliding of a bar around a frame-angle. If the free particle is attached to the bar $B^n(\eta)$ (resp. $B^s(\eta)$), by Lemma 6.8 we know that it is not possible to complete the sliding of the bar $B^w(\eta)$ around the frame-angle $c^{wn}(\eta')$ (resp. $c^{ws}(\eta')$). If the free particle is attached to the bar $B^e(\eta)$, we deduce that (4.12) is not satisfied. In the last two cases by Lemma 6.6(ii) we know that the saddles that are visited are unessential. If the free particle is attached to the bar $B^w(\eta)$, it is possible to slide the bar $B^n(\eta)$ around the frame-angle $c^{nw}(\eta')$ when $|B^n(\eta)| < |B^w(\eta)|$, otherwise (4.12) is not satisfied. By (7.3) and (7.4)

we note that $|B^n(\eta)| < |B^w(\eta)|$ is not possible and the case C is concluded.

Case D. Without loss of generality we consider η as in Figure 13 on the right-hand side. If we are considering the case in which a sequence of 1-translations of a bar is possible and takes place, then by Lemma 6.7 the saddles that are crossed are essential and in $\mathcal{A}_0^{\alpha'} \cup \mathcal{A}_1^\alpha$. Starting from this configuration, it is possible to obtain one or two occupied frame-angles: these situations have been already analyzed in cases C and B respectively. Thus we can reduce our proof to the case in which there is no translation of a bar and therefore there is the activation of a sliding of a bar around a frame-angle. If the free particle is attached to the bar $B^n(\eta)$ (resp. $B^s(\eta)$), by Lemma 6.8 we know that it is not possible to complete the sliding of the bar $B^w(\eta)$ around the frame-angle $c^{wn}(\eta')$ (resp. $c^{ws}(\eta')$). If the free particle is attached to the bar $B^w(\eta)$ or $B^e(\eta)$, we deduce that (4.11) is not satisfied. In the last two cases by Lemma 6.6(ii) we know that the saddles that are visited are unessential. This concludes case D. \square

8 Proof of the sharp asymptotics

For the model-independent discussion we refer to [2, Section 10.1]. Following the strategy given in [13] for the isotropic case, here we apply this argument for the strongly anisotropic one. For the corresponding strategy in the isotropic and weakly anisotropic cases we refer to [2, Section 10.2].

8.1 Application of the potential theory to the strongly anisotropic case

In [12] the authors let the protocritical and critical sets as $\mathcal{P}^*(m, s)$ and $\mathcal{C}^*(m, s)$ respectively (see [12, Definition 16.3] for the definition of $\mathcal{P}^*(m, s)$ and $\mathcal{C}^*(m, s)$). Since they differ from our notation, we refer to them as $\mathcal{P}_{PTA}^*(m, s)$ and $\mathcal{C}_{PTA}^*(m, s)$. In [12] the authors proved [12, Theorem 16.4] and [12, Theorem 16.5] subject to the two hypotheses

(H1) $\mathcal{X}^m = \{m\}$ and $\mathcal{X}^s = \{s\}$;

(H2) $\xi' \rightarrow |\{\xi \in \mathcal{P}_{PTA}^*(m, s) : \xi \sim \xi'\}|$ is constant on $\mathcal{C}_{PTA}^*(m, s)$.

For our model $\mathcal{X}_{sa}^m = \{\square\}$ and $\mathcal{X}_{sa}^s = \{\blacksquare\}$, thus (H1) holds and $\Gamma^* = \Phi(\square, \blacksquare) - H(\square) = \Gamma_{sa}^*$. Now we abbreviate $\mathcal{P}_{PTA}^* = \mathcal{P}_{PTA}^*(\square, \blacksquare)$ and $\mathcal{C}_{PTA}^* = \mathcal{C}_{PTA}^*(\square, \blacksquare)$. Moreover, we prove that geometrically $\mathcal{P}_{PTA}^* = \mathcal{D}_{sa} \cup \bigcup_{\alpha, \alpha'} \bar{\mathcal{A}}_2^{\alpha, \alpha'}$ (see (8.6) for the definition of $\bar{\mathcal{A}}_2^{\alpha, \alpha'}$) and $\mathcal{C}_{PTA}^* = \mathcal{C}_{sa}^*(L_{sa}^*) \cup \bigcup_{\alpha, \alpha'} \mathcal{A}_2^{\alpha, \alpha'}$ (recall (4.24) for the definition of $\mathcal{A}_2^{\alpha, \alpha'}$) with $\alpha \in \{n, s\}$ and $\alpha' \in \{e, w\}$. Therefore it is clear that $\mathcal{C}_{sa}^* \neq \mathcal{C}_{PTA}^*$. Note that (H2) follows from Lemma 6.17, indeed each configuration in \mathcal{C}_{PTA}^* has exactly one configuration in \mathcal{P}_{PTA}^* from which it can be reached via an allowed move. In particular, the configurations in $\mathcal{C}_{sa}^*(L_{sa}^*)$ and $\bar{\mathcal{D}}_{sa}$ are connected by removing the free particle in $\partial^- \Lambda$, while those in $\mathcal{A}_2^{\alpha, \alpha'}$ and $\bar{\mathcal{A}}_2^{\alpha, \alpha'}$ are connected between each other by attaching the two particles separated by an empty site at cost $-U_1$. Since (H1) and (H2) hold, [12, Theorem 16.4] and [12, Theorem 16.5] should hold, but for the strongly anisotropic case this is not true. On the one hand, [12, Theorem 16.4(a)] and [12, Theorem 16.5] are valid, but on the other hand [12, Theorem 16.4(b)] does not hold, since the entrance in \mathcal{C}_{PTA}^* can not be uniform due to the two possible different entrance mechanisms, as claimed in Lemma 6.17. This depends on the hypothesis (H2), that takes into account only the map from \mathcal{C}_{PTA}^* to \mathcal{P}_{PTA}^* and not the reverse one. Therefore we propose to replace the hypothesis (H2) with

(H2') $\xi' \rightarrow |\{\xi \in \mathcal{P}_{PTA}^*(m, s) : \xi \sim \xi'\}|$ is constant on $\mathcal{C}_{PTA}^*(m, s)$ and $\xi \rightarrow |\{\xi' \in \mathcal{C}_{PTA}^*(m, s) : \xi' \sim \xi\}|$ is constant on $\mathcal{P}_{PTA}^*(m, s)$.

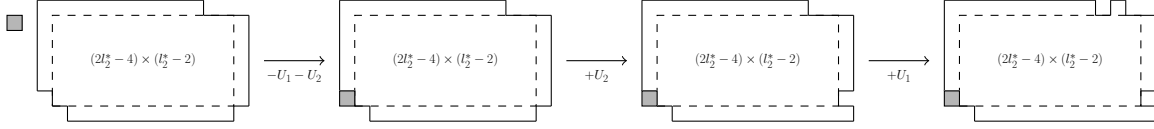

Figure 14: We depict the transition that, starting from a configuration in \mathcal{C}_{sa}^* , passes through \mathcal{C}_{sa}^G and after two moves reaches an unessential saddle ζ_{sa} .

Now it is clear that (H2') is not satisfied, indeed each configuration in $\bar{\mathcal{D}}_{sa}$ has exactly $4L - 4$ configurations in \mathcal{C}_{sa}^* from which it can be reached via an allowed move, while each configuration in $\bar{\mathcal{A}}_2^{\alpha, \alpha'}$ has only one configuration in $\mathcal{A}_2^{\alpha, \alpha'}$ with this property.

Recall [2, Definition 10.4] for the definition of the wells $\mathcal{Z}_{sa,j}^\square$ and $\mathcal{Z}_{sa,j}^\blacksquare$, and [2, Definition 3.2] and [2, Definition 3.4] for the definition of the saddles $\sigma_{sa,j}$ of the first type and $\zeta_{sa,j}$ of the second type respectively. Concerning [12, Theorem 16.5], by [12, Lemma 16.16] for the case $int = sa$, we know that h is constant on each well. Thanks to the model-independent discussion given in [2, Section 10.1] and [2, Lemma 10.7], [2, eq. (10.17)] becomes

$$h = \begin{cases} 1 & \text{on } \mathcal{C}_{\blacksquare}^\square(\Gamma_{sa}^*) \cup \bigcup_{j=1}^{J_\square} (\{\sigma_{sa,j}\} \cup \mathcal{Z}_{sa,j}^\square), \\ 0 & \text{on } \mathcal{C}_{\square}^\blacksquare(\Gamma_{sa}^* - H(\blacksquare)) \cup \bigcup_{j=1}^{J_\blacksquare} (\{\zeta_{sa,j}\} \cup \mathcal{Z}_{sa,j}^\blacksquare), \\ c_i & \text{on } \mathcal{X}_{sa}(i), i = 1, \dots, \bar{I}, \end{cases} \quad (8.1)$$

where $\mathcal{X}_{sa}(i)$, $i = 1, \dots, \bar{I}$, are all the wells of the transition except $\bigcup_{j=1}^{J_\square} \mathcal{Z}_{sa,j}^\square$ and $\bigcup_{j=1}^{J_\blacksquare} \mathcal{Z}_{sa,j}^\blacksquare$. This implies that the unessential saddles can not be neglected in the study of the prefactor. The variational formula for Θ in [2, eq. (10.11)] is non-trivial because it depends on the geometry of all the wells and on the form of the function h on the configurations in $\mathcal{X}_{sa}^* \setminus \mathcal{X}_{sa}^{**}$, namely the saddle configurations.

Remark 8.1 In Figure 14 we depict a transition that, starting from a configuration in \mathcal{C}_{sa}^* , gives an unessential saddle ζ_{sa} of the third type.

8.2 Proof of Theorem 4.11

Using [2, Lemma 10.7], in order to prove Theorem 4.11 it remains to analyze in detail the number of possible transitions inside the gates and in-between their boundaries. Finally, we need to count the cardinality of $\bar{\mathcal{D}}_{sa}$ modulo shifts. We denote by N_{sa} that quantity.

8.2.1 Lower bound

Recall [2, Definition 10.4] for the definition of the wells $\mathcal{Z}_{sa,j}^\square$ and $\mathcal{Z}_{sa,j}^\blacksquare$ and [2, Definition 3.2] and [2, Definition 3.4] for the definition of the saddles $\sigma_{sa,j}$ of the first type and $\zeta_{sa,j}$ of the second type respectively. Thus we consider the following sets:

$$\mathcal{X}_{sa}^\square := \mathcal{C}_{\blacksquare}^\square(\Gamma_{sa}^*) \cup \bigcup_{j=1}^{J_\square} (\{\sigma_{sa,j}\} \cup \mathcal{Z}_{sa,j}^\square) \quad (8.2)$$

$$\mathcal{X}_{sa}^{\blacksquare} := \mathcal{C}_{\blacksquare}^{\blacksquare}(\Gamma_{sa}^* - H(\blacksquare)) \cup \bigcup_{j=1}^{J_{\blacksquare}} (\{\zeta_{sa,j}\} \cup \mathcal{Z}_{sa,j}^{\blacksquare}) \quad (8.3)$$

The lower bound $\Theta_{sa} \geq \Theta_1^{sa}$ is obtained by removing all the transitions that do not involve either a protocritical droplet and a free particle that moves or the path described in Figure 7. The first type of transitions gives a contribute that can be treated in a similar way as in the lower bound in [13, Proposition 3.3.4]. Indeed we obtain:

$$\begin{aligned} & \sum_{\hat{\eta} \in \bar{\mathcal{D}}_{sa}} \min_{c_j(\hat{\eta}), j=1,2,3,4} \min_{\substack{g: \Lambda^* \rightarrow [0,1] \\ g|_{\partial^G \hat{\eta}} \equiv 0, g|_{\partial^B \hat{\eta}} \equiv c_j, j=1,2,3,4, g|_{\partial^+ \Lambda} \equiv 1}} \frac{1}{2} \sum_{\substack{x, x' \in \Lambda^+ \\ x \sim x'}} [g(x) - g(x')]^2 \\ & \geq \sum_{\hat{\eta} \in \bar{\mathcal{D}}_{sa}} \text{CAP}^{\Lambda^+}(\partial^+ \Lambda, \text{CR}(\hat{\eta})) \end{aligned} \quad (8.4)$$

where $g(x) := h(\hat{\eta}, x) = h(\eta)$ for $\hat{\eta} \in \bar{\mathcal{D}}_{sa}$ and $x \in \Lambda \setminus \text{CR}^{++}(\hat{\eta})$, and $\partial^G \hat{\eta}$ denotes the set of good sites in $\partial^- \text{CR}(\hat{\eta})$, $\partial_j^B \hat{\eta}$, $j = 1, 2, 3, 4$, denote the four bars of bad sites in $\partial^+ \text{CR}(\hat{\eta})$ and

$$\text{CAP}^{\Lambda^+}(\partial^+ \Lambda, F) = \min_{\substack{g: \Lambda^+ \rightarrow [0,1] \\ g|_{\partial^+ \Lambda} \equiv 1, g|_F \equiv 0}} \frac{1}{2} \sum_{\substack{x, x' \in \Lambda^+ \\ x \sim x'}} [g(x) - g(x')]^2, \quad \text{for any } F \subseteq \Lambda^+. \quad (8.5)$$

For $\alpha \in \{n, s\}$, $\alpha' \in \{w, e\}$ and $k = 2, \dots, l_2^*$, we define

$$\bar{\mathcal{A}}_k^{\alpha, \alpha'} := \{\eta : n(\eta) = 0, v(\eta) = 2l_2^* - 2, |r^\alpha(\eta)| = k - 1, |r^{\alpha'}(\eta)| = l_2^* - k, |c^{\alpha\alpha'}(\eta)| = 1, \eta_{cl} \text{ is connected, monotone, with circumscribed rectangle in } \mathcal{R}(2l_2^* - 1, l_2^*)\} \quad (8.6)$$

and

$$\tilde{\mathcal{A}}_k^{\alpha, \alpha'} := \{\eta : n(\eta) = 0, v(\eta) = 2l_2^* - 2, |r^\alpha(\eta)| = k, |r^{\alpha'}(\eta)| = l_2^* - k, |c^{\alpha\alpha'}(\eta)| = 0, \eta_{cl} \text{ is connected, monotone, with circumscribed rectangle in } \mathcal{R}(2l_2^* - 1, l_2^*)\} \quad (8.7)$$

Referring to Figure 7, note that the configuration (6) is in $\bar{\mathcal{A}}_2^{n,e}$ and the configuration (10) is in $\bar{\mathcal{A}}_3^{n,e}$, while the configuration (8) is in $\tilde{\mathcal{A}}_2^{n,e}$.

Now we analyze the transitions described in Figure 7. The configuration (6) is in $\bar{\mathcal{A}}_2^{n,e} \subseteq \mathcal{C}_{\blacksquare}^{\blacksquare}(\Gamma_{sa}^*) \subseteq \mathcal{X}_{sa}^{\blacksquare}$ and therefore $h(\bigcup_{\alpha, \alpha'} \bar{\mathcal{A}}_2^{n,e}) = 1$. Thanks to [13, Lemma 3.3.2], we know that h is constant on the wells and thus we analyze the transitions to and from each wells. In particular, note that during the transition from $\tilde{\mathcal{A}}_k^{\alpha, \alpha'}$ and $\bar{\mathcal{A}}_{k+1}^{\alpha, \alpha'}$ only configurations with energy strictly smaller than Γ_{sa}^* are crossed, thus they belong to the same well and therefore we can set h constant on these configurations. We set $h(\bigcup_{\alpha, \alpha'} \bar{\mathcal{A}}_2^{\alpha, \alpha'}) = c_1$, $h \equiv c_2$ on $\bigcup_{\alpha, \alpha'} \tilde{\mathcal{A}}_2^{\alpha, \alpha'}$ and on its wells, and so on until the last set $h(\bigcup_{\alpha, \alpha'} \bar{\mathcal{A}}_{l_2^*}^{\alpha, \alpha'}) = c_{2l_2^*-2}$ and $h(\eta) = c_{2l_2^*-1}$ for any $\eta \in \mathcal{C}_{sa}^*(2)$. Thus we have to minimize w.r.t. $c_1, c_2, \dots, c_{2l_2^*-1}$ the following term:

$$(1 - c_1)^2 + (c_1 - c_2)^2 + \dots + (c_{2l_2^*-3} - c_{2l_2^*-2})^2 + (c_{2l_2^*-2} - c_{2l_2^*-1})^2 + kc_{2l_2^*-1}^2 \quad (8.8)$$

where $k = l_2^* - 1$ is the number of good sites of the configuration (12) in Figure 7. We prove by induction over n that

$$c_n = \frac{1 + K_n c_{n+1}}{K_n + 1}, \quad 1 \leq n \leq 2l_2^* - 2, \quad (8.9)$$

where K_n satisfies the following recurrence relation

$$\begin{cases} K_n = (K_{n-1} + 1)^2, & 2 \leq n \leq 2l_2^* - 2, \\ K_1 = 1. \end{cases} \quad (8.10)$$

$n = 1$ We have to prove that $c_1 = \frac{1+c_2}{2}$. This can be easily checked by minimizing the function $f(c_1, c_2) = (1 - c_1)^2 + (c_1 - c_2)^2$ with respect to c_1 . Indeed we get:

$$\frac{\partial f}{\partial c_1} = 4c_1 - 2c_2 - 2 = 0 \Leftrightarrow c_1 = \frac{1 + c_2}{2} \quad (8.11)$$

$2 \leq n \leq 2l_2^* - 2$ Assume now that (8.9) holds for $n - 1$ and we prove that it holds also for n . We consider the function $f(c_{n-1}, c_n, c_{n+1}) = (c_{n-1} - c_n)^2 + (c_n - c_{n+1})^2$ and we replace the expression of c_{n-1} in terms of c_n . Thus we get

$$f(c_n, c_{n+1}) = \left(\frac{1 + K_{n-1}c_n}{K_{n-1} + 1} - c_n \right)^2 + (c_n - c_{n+1})^2 \quad (8.12)$$

and therefore

$$\frac{\partial f}{\partial c_n} = 2 \left(\frac{K_{n-1}}{K_{n-1} + 1} - 1 \right) \left(\frac{1 + K_{n-1}c_n}{K_{n-1} + 1} - c_n \right) + 2(c_n - c_{n+1}) \quad (8.13)$$

The equation $\frac{\partial f}{\partial c_n} = 0$ gives

$$\frac{c_n - 1}{(K_{n-1} + 1)^2} = c_{n+1} - c_n \quad (8.14)$$

that implies (8.9) by using (8.10). Thus we get the claim.

Now we have to find the value of the constant $c_{2l_2^*-1}$ that minimizes (8.8). By considering the function $f(c_{2l_2^*-2}, c_{2l_2^*-1}) = (c_{2l_2^*-2} - c_{2l_2^*-1})^2 + (l_2^* - 1)c_{2l_2^*-1}^2$ and proceeding in a similar way as above, we deduce that

$$c_{2l_2^*-1} = \frac{1}{(l_2^* - 1)(K_{2l_2^*-2} + 1)^2 + 1} \quad (8.15)$$

Finally, by (8.9) and (8.15) we get

$$1 - c_1 = \frac{1 - c_2}{2} \quad \text{and} \quad c_{n-1} - c_n = \frac{1 - c_n}{K_{n-1} + 1} \quad (8.16)$$

Finally, by (8.16) we deduce that the minimizer of the quantity in (8.8) is given by

$$\left(\frac{1 - c_2}{2} \right)^2 + \sum_{n=2}^{2l_2^*-1} \left(\frac{1 - c_n}{K_{n-1} + 1} \right)^2 + \frac{l_2^* - 1}{((l_2^* - 1)(K_{2l_2^*-2} + 1)^2 + 1)^2} \quad (8.17)$$

where the coefficients $c_2, \dots, c_{2l_2^*-1}$ can be explicitly derived from (8.9) e (8.15). Combining (8.4) and (8.17), we get

$$\begin{aligned} \Theta_{sa} &\geq \sum_{\hat{\eta} \in \bar{\mathcal{D}}_{sa}} \text{CAP}^{\Lambda^+}(\partial^+ \Lambda, \text{CR}(\hat{\eta})) + 4 \left[\left(\frac{1 - c_2}{2} \right)^2 + \sum_{n=2}^{2l_2^*-1} \left(\frac{1 - c_n}{K_{n-1} + 1} \right)^2 \right. \\ &\quad \left. + \frac{l_2^* - 1}{[(l_2^* - 1)(K_{2l_2^*-2} + 1)^2 + 1]^2} \right] := \Theta_1^{sa} \end{aligned} \quad (8.18)$$

The first term in the r.h.s. of (8.18) can be treated in a similar way as [13, Lemma 3.4.1] for $\Lambda \rightarrow \mathbb{Z}^2$. Since the remaining part of the r.h.s. of (8.18) does not depend on the size of the box, that implies that we can neglect its contribute as $\Lambda \rightarrow \mathbb{Z}^2$, we deduce that

$$\Theta_1^{sa} \rightarrow 4\pi N_{sa} \frac{|\Lambda|}{\log |\Lambda|} \quad \text{as} \quad \Lambda \rightarrow \mathbb{Z}^2, \quad (8.19)$$

where N_{sa} is computed in Proposition 8.2.

8.2.2 Upper bound

We define

$$\mathcal{C}_{sa}^{++} := \{\eta = (\hat{\eta}, x) : \hat{\eta} \in \bar{\mathcal{D}}_{sa}, x \in \Lambda \setminus \text{CR}^{++}(\hat{\eta})\}. \quad (8.20)$$

and we consider the following test function

$$h(\eta) := \begin{cases} 1 & \text{if } \eta \in \mathcal{X}_{sa}^{\square}, \\ c_i & \text{if } \eta \in \mathcal{X}_{sa}(i), i = 1, \dots, \bar{I} \\ g(x) & \text{if } \eta \in \mathcal{C}_{sa}^{++}, \\ 0 & \text{if } \eta \in \mathcal{X}_{sa}^{\blacksquare}, \end{cases} \quad (8.21)$$

where $g(x) := h(\hat{\eta}, x) = h(\eta)$ for $\hat{\eta} \in \bar{\mathcal{D}}_{sa}$ and $x \in \Lambda \setminus \text{CR}^{++}(\hat{\eta})$, i.e., $\eta \in \mathcal{C}_{sa}^{++}$. Thus by [2, eq. (10.11)] we get

$$\begin{aligned} \text{CAP}(\square, \blacksquare) &\leq (1 + o(1)) \left(\sum_{\hat{\eta} \in \bar{\mathcal{D}}_{sa}} \text{CAP}^{\Lambda^+}(\partial^+ \Lambda, \text{CR}^{++}(\hat{\eta})) \right. \\ &\quad \left. + \min_{c_1, \dots, c_I} \min_{\substack{h: \mathcal{X}_{sa}^* \rightarrow [0,1] \\ h|_{\mathcal{X}_{sa}^{\square}} = 1, h|_{\mathcal{X}_{sa}^{\blacksquare}} = 0, h|_{\mathcal{X}_{sa}(i)} = c_i, i=1, \dots, \bar{I}}} \frac{1}{2} \sum_{\eta, \eta' \in \mathcal{X}^*} \mu_{\beta}(\eta, \eta') c_{\beta}(\eta, \eta') [h(\eta) - h(\eta')]^2 \right) \end{aligned} \quad (8.22)$$

where $\text{CAP}^{\Lambda^+}(\partial^+ \Lambda, F)$ is defined in (8.5). We have to analyze the possible transitions between $\mathcal{X}_{sa}^{\blacksquare}$ and $\mathcal{X}_{sa}(i) \cup \bigcup_j \{\xi_{sa,j}\}$, between $\mathcal{X}_{sa}(i)$ and $\mathcal{X}_{sa}(j)$ with $i \neq j$ and between $\mathcal{X}_{sa}(i) \cup \bigcup_j \{\xi_{sa,j}\}$ and $\mathcal{X}_{sa}^{\square}$, where the saddles $\xi_{sa,j}$ are neither saddles of the first type nor saddles of the second type (recall [2, Definitions 3.2, 3.4]). We set $\mathcal{X}_{sa}(1) = \bigcup_{\alpha \in \{n,s\}} \bigcup_{\alpha' \in \{w,e\}} \mathcal{A}_2^{\alpha, \alpha'}$ (an example is given in Figure 7 by the configuration (7)). We set $\mathcal{X}_{sa}(2)$ as the union of $\tilde{\mathcal{A}}_2^{\alpha, \alpha'}$, $\bar{\mathcal{A}}_3^{\alpha, \alpha'}$ and the configurations connecting these sets in the path described in Figure 7 that are in the same well. We iterate this construction until the last set $\mathcal{X}_{sa}(2l_2^* - 1)$ as we did for the lower bound. Furthermore, we set

$$\mathcal{X}_{sa}(2l_2^*) = \mathcal{C}_{sa}^B, \quad \mathcal{X}_{sa}(2l_2^* + 1) = \bigcup_{\alpha' \in \{e,w\}} \mathcal{A}_0^{\alpha'}, \quad \mathcal{X}_{sa}(2l_2^* + 2) = \bigcup_{\alpha' \in \{e,w\}} \mathcal{A}_1^{\alpha'} \quad (8.23)$$

Now we analyze all the transitions that give a non-trivial contribute to (8.22).

Transitions between $\mathcal{X}_{sa}^{\square}$ and $\mathcal{X}_{sa}(i) \cup \bigcup_j \{\xi_{sa,j}\}$. The transition via one step of the dynamics from $\eta \in \mathcal{X}_{sa}^{\square}$ and $\eta' \in \mathcal{X}_{sa}(i) \cup \bigcup_j \{\xi_{sa,j}\}$ is possible only if either $\eta \in \bar{\mathcal{D}}_{sa}$ and $\eta' \in \mathcal{C}_{sa}^*$ or $\eta \in \bar{\mathcal{A}}_2^{\alpha, \alpha'}$ and $\eta' \in \mathcal{A}_2^{\alpha, \alpha'}$ for some $\alpha \in \{n, s\}$ and $\alpha' \in \{w, e\}$. The latter transition contributes 4 times to the quantity in (8.22) depending on which frame-angle is involved in the transition.

Transitions between $\mathcal{X}_{sa}(i)$ and $\mathcal{X}_{sa}(j)$. We consider the sequence of transitions that forms the path described in Figure 7, the transitions between $\mathcal{C}_{sa}^*(2)$ and \mathcal{C}_{sa}^B , between \mathcal{C}_{sa}^B and $\mathcal{X}_{sa}(2l_2^* + 1)$ and between \mathcal{C}_{sa}^B and $\mathcal{X}_{sa}(2l_2^* + 2)$.

Transitions between $\mathcal{X}_{sa}(i)$ and $\mathcal{X}_{sa}^{\blacksquare}$. The transition via one step of the dynamics from $\eta \in \mathcal{X}_{sa}(i)$ and $\eta' \in \mathcal{X}_{sa}^{\blacksquare}$ is possible only if $\eta \in \mathcal{C}_{sa}^*(2)$ and $\eta' \in \mathcal{C}_{sa}^G$.

Collecting all these transitions, by (8.21) and (8.22) we get

$$\begin{aligned}
\text{CAP}(\square, \blacksquare) &\leq \frac{e^{-\beta\Gamma_{sa}^*}}{Z_\beta} (1 + o(1)) \min_{\bar{c}, c_1, \dots, c_{2l_2^*+2}} 4 \left[(1 - c_1)^2 + (c_1 - c_2)^2 + \dots + (c_{2l_2^*-2} - c_{2l_2^*-1})^2 \right. \\
&\quad \left. + (l_2^* - 1)c_{2l_2^*-1}^2 \right] + \sum_{\substack{\eta \in \mathcal{C}_{sa}^*(2) \\ \eta' \in \mathcal{C}_{sa}^G}} \bar{c}^2 + \sum_{\substack{\eta \in \mathcal{C}_{sa}^*(2) \\ \eta' \in \mathcal{X}_{sa}(2l_2^*)}} (\bar{c}^2 - c_{2l_2^*})^2 \\
&\quad + 2 \sum_{\substack{\eta \in \mathcal{X}_{sa}(2l_2^*) \\ \eta' \in \mathcal{X}_{sa}(2l_2^*+1)}} (c_{2l_2^*} - c_{2l_2^*+1})^2 + 2 \sum_{\substack{\eta \in \mathcal{X}_{sa}(2l_2^*) \\ \eta' \in \mathcal{X}_{sa}(2l_2^*+2)}} (c_{2l_2^*} - c_{2l_2^*+2})^2 \\
&\quad + \sum_{\hat{\eta} \in \bar{\mathcal{D}}_{sa}} \text{CAP}^{\Lambda^+}(\partial^+ \Lambda, \text{CR}^{++}(\hat{\eta}))
\end{aligned} \tag{8.24}$$

Rearraging the term, we get

$$\begin{aligned}
\text{CAP}(\square, \blacksquare) &\leq \frac{e^{-\beta\Gamma_{sa}^*}}{Z_\beta} (1 + o(1)) \left(\min_{c_1, \dots, c_{2l_2^*-1}} 4 \left[(1 - c_1)^2 + (c_1 - c_2)^2 \right. \right. \\
&\quad \left. \left. + \dots + (c_{2l_2^*-2} - c_{2l_2^*-1})^2 + (l_2^* - 1)c_{2l_2^*-1}^2 \right] + \min_{\bar{c}, c_{2l_2^*}, \dots, c_{2l_2^*+2}} \sum_{\substack{\eta \in \mathcal{C}_{sa}^*(2) \\ \eta' \in \mathcal{C}_{sa}^G}} \bar{c}^2 \right. \\
&\quad + \sum_{\substack{\eta \in \mathcal{C}_{sa}^*(2) \\ \eta' \in \mathcal{X}_{sa}(2l_2^*)}} (\bar{c} - c_{2l_2^*})^2 + 2 \sum_{\substack{\eta \in \mathcal{X}_{sa}(2l_2^*) \\ \eta' \in \mathcal{X}_{sa}(2l_2^*+1)}} (c_{2l_2^*} - c_{2l_2^*+1})^2 \\
&\quad \left. + 2 \sum_{\substack{\eta \in \mathcal{X}_{sa}(2l_2^*) \\ \eta' \in \mathcal{X}_{sa}(2l_2^*+2)}} (c_{2l_2^*} - c_{2l_2^*+2})^2 + \sum_{\hat{\eta} \in \bar{\mathcal{D}}_{sa}} \text{CAP}^{\Lambda^+}(\partial^+ \Lambda, \text{CR}^{++}(\hat{\eta})) \right)
\end{aligned} \tag{8.25}$$

Now we analyze separately the two following terms:

$$\bar{\Theta}_{sa} = \min_{c_1, \dots, c_{2l_2^*-1}} 4 \left[(1 - c_1)^2 + (c_1 - c_2)^2 + \dots + (c_{2l_2^*-2} - c_{2l_2^*-1})^2 + (l_2^* - 1)c_{2l_2^*-1}^2 \right] \tag{8.26}$$

and

$$\begin{aligned}
\tilde{\Theta}_{sa} &= \min_{\bar{c}, c_{2l_2^*}, \dots, c_{2l_2^*+2}} \sum_{\substack{\eta \in \mathcal{C}_{sa}^*(2) \\ \eta' \in \mathcal{C}_{sa}^G}} \bar{c}^2 + \sum_{\substack{\eta \in \mathcal{C}_{sa}^*(2) \\ \eta' \in \mathcal{X}_{sa}(2l_2^*)}} (\bar{c} - c_{2l_2^*})^2 + 2 \sum_{\substack{\eta \in \mathcal{X}_{sa}(2l_2^*) \\ \eta' \in \mathcal{X}_{sa}(2l_2^*+1)}} (c_{2l_2^*} - c_{2l_2^*+1})^2 \\
&\quad + 2 \sum_{\substack{\eta \in \mathcal{X}_{sa}(2l_2^*) \\ \eta' \in \mathcal{X}_{sa}(2l_2^*+2)}} (c_{2l_2^*} - c_{2l_2^*+2})^2 + \sum_{\hat{\eta} \in \bar{\mathcal{D}}_{sa}} \text{CAP}^{\Lambda^+}(\partial^+ \Lambda, \text{CR}^{++}(\hat{\eta}))
\end{aligned} \tag{8.27}$$

Note that the minimum of (8.26) coincides with 4 times the minimum of (8.8) and therefore $\bar{\Theta}_{sa}$ can be computed in the same way as in the lower bound (see (8.9), (8.15) and (8.17)). It is easy to check that the minimum of (8.27) w.r.t. $\bar{c}, c_{2l_2^*}, \dots, c_{2l_2^*+2}$ is obtained for $\bar{c} = c_{2l_2^*} = c_{2l_2^*+1} = c_{2l_2^*+2} = 0$. Thus the term $\tilde{\Theta}_{sa}$ becomes

$$\tilde{\Theta}_{sa} = \sum_{\hat{\eta} \in \bar{\mathcal{D}}_{sa}} \text{CAP}^{\Lambda^+}(\partial^+ \Lambda, \text{CR}^{++}(\hat{\eta})) \tag{8.28}$$

and therefore

$$\begin{aligned}
\Theta_{sa} &\leq \frac{e^{-\beta\Gamma_{sa}^*}}{Z_\beta}(1+o(1))(\bar{\Theta} + \tilde{\Theta}) \\
&= \frac{e^{-\beta\Gamma_{sa}^*}}{Z_\beta}(1+o(1)) \left[4 \left(\left(\frac{1-c_2}{2} \right)^2 + \sum_{n=2}^{2l_2^*-1} \left(\frac{1-c_n}{K_{n-1}+1} \right)^2 \right. \right. \\
&\quad \left. \left. + \frac{l_2^*-1}{[(l_2^*-1)(K_{2l_2^*-2}+1)^2+1]^2} \right) + \sum_{\hat{\eta} \in \bar{\mathcal{D}}_{sa}} \text{CAP}^{\Lambda^+}(\partial^+\Lambda, \text{CR}^{++}(\hat{\eta})) \right] := \Theta_2^{sa}
\end{aligned} \tag{8.29}$$

where the coefficients $c_2, \dots, c_{2l_2^*-2}, c_{2l_2^*-1}$ can be explicitly derived from (8.9) and (8.15), where the sequence K_n is defined in (8.10). The first term in the r.h.s. of (8.29) does not depend on the size of the box, thus we can neglect its contribution as $\Lambda \rightarrow \mathbb{Z}^2$. Since the remaining part of the r.h.s. of (8.29) can be treated in a similar way as [13, Lemma 3.4.1] for $\Lambda \rightarrow \mathbb{Z}^2$, we deduce that

$$\Theta_2^{sa} \rightarrow 4\pi N_{sa} \frac{|\Lambda|}{\log |\Lambda|} \quad \text{as} \quad \Lambda \rightarrow \mathbb{Z}^2, \tag{8.30}$$

where N_{sa} is computed in Proposition 8.2.

Proposition 8.2

$$N_{sa} = \sum_{k=1}^4 \binom{4}{k} \binom{l_2^* + k - 2}{2k - 1}.$$

Proof. We have to count the number of different shapes of the clusters in $\bar{\mathcal{D}}_{sa}$. We do this by counting in how many ways $l_2^* - 1$ particles can be removed from the four bars of a $(2l_2^* - 2) \times l_2^*$ rectangle starting from the corners. We split the counting according to the number $k = 1, 2, 3, 4$ of corners from which particles are removed. The number of ways in which we can choose k corners is $\binom{4}{k}$. After we have removed the particles at these corners, we need to remove $l_2^* - 1 - k$ more particles from either side of each corner. The number of ways in which this can be done is

$$\begin{aligned}
&|\{(m_1, \dots, m_{2k}) \in \mathbb{N}_0^{2k} : m_1 + \dots + m_{2k} = l_2^* - 1 - k\}| \\
&= |\{(m_1, \dots, m_{2k}) \in \mathbb{N}^{2k} : m_1 + \dots + m_{2k} = l_2^* - 1 + k\}| \\
&= \binom{l_2^* + k - 2}{2k - 1}.
\end{aligned} \tag{8.31}$$

Thus we get the claim. □

8.3 Proof of Theorem 4.14

Thanks to [51, Lemma 3.6], we deduce that for our model the quantity $\tilde{\Gamma}(B)$, with $B \subsetneq \mathcal{X}$, defined in [51, eq. (21)] is such that $\tilde{\Gamma}(\mathcal{X} \setminus \{\blacksquare\}) = \Gamma_{sa}^*$. Thus Theorem 4.14 follows by the following proposition.

Proposition 8.3 [51, Proposition 3.24] *For any $\varepsilon \in (0, 1)$ and any $s \in \mathcal{X}^s$*

$$\lim_{\beta \rightarrow \infty} \frac{1}{\beta} \log t_\beta^{mix}(\varepsilon) = \tilde{\Gamma}(\mathcal{X} \setminus \{s\}) = \lim_{\beta \rightarrow \infty} -\frac{1}{\beta} \log \rho_\beta \tag{8.32}$$

Furthermore, there exist two constants $0 < c_1 \leq c_2 < \infty$ independent of β such that for every $\beta > 0$

$$c_1 e^{-\beta \tilde{\Gamma}(\mathcal{X} \setminus \{s\})} \leq \rho_\beta \leq c_2 e^{-\beta \tilde{\Gamma}(\mathcal{X} \setminus \{s\})} \tag{8.33}$$

9 Proof of the main results for the simplified model

In this Section we provide the proof of results in Section 5 that are extensions to the simplified model (described in Section 2.3) of the local model. Now we consider $int = sa$ and we follow the strategy proposed in [40] for $int = is$. In [40, Section 2] the authors give several large deviation estimates concerning exponential clocks, that hold also for the anisotropic cases. In [40, Section 3] the authors give several large deviation estimates concerning random walks. All these results are valid for the cases $int \in \{wa, sa\}$ without changes except for [40, Proposition 3.13], in which we have to replace U with U_1 . The recurrence property for the anisotropic simplified model is obtained with similar arguments carried out in [40, Section 6]. To this end, we modify the definition of the set $\bar{\mathcal{X}}_2$ given in [40, eq. (5.8)] by replacing U with U_1 . Therefore also the definition of the set \mathcal{X}_2 given in [40, eq. (6.1)] should be modified accordingly. Thus, if we define for the anisotropic model $T_1 = e^{0\beta}$, $T_2 = e^{U_1\beta}$ and $T_3 = e^{\Delta\beta}$, [40, Proposition 6.2] holds also for the anisotropic cases. Concerning the reduction, we follow the strategy proposed in [40, Section 7]. In particular, we have to study the behavior of the gas and its interaction with the dynamics in the box Λ . There are two classes of gas particles with different behavior: particles that have been in $\Lambda_\beta \setminus \Lambda$ for a long time (say of order T_3), which we call green particles; and particles that exit from Λ and afterwards return to Λ in a short time (say of order 1), which we call red particles. The effect of green (resp. red) particles is studied in [40, Section 7.6] (resp. [40, Section 7.7]) and can be extended to the cases $int \in \{wa, sa\}$ by modifying the times T_1 , T_2 and T_3 , and the sets \mathcal{X}_2 and $\bar{\mathcal{X}}_2$ as above. In the case $int = sa$, from this discussion and [3, Theorem 2.5] (resp. Theorem 4.8) for the local model, Theorem 5.1(a) (resp. 5.1(b)) follows. Analogously, using [3, Theorem 2.3] (resp. Theorem 4.10) for the local model, Theorem 5.1(c) (resp. Theorem 5.1(d)) holds.

References

- [1] V. Apollonio, V. Jacquier, F.R. Nardi, and A. Troiani, “Metastability for the Ising model on the hexagonal lattice”, arXiv preprint, arXiv:2101.11894 (2021).
- [2] S. Baldassarri, and F.R. Nardi, “Critical Droplets and sharp asymptotics for Kawasaki dynamics with weakly anisotropic interactions”, arXiv preprint, arXiv:2108.02017 (2021).
- [3] S. Baldassarri, and F.R. Nardi, “Metastability in a lattice gas with strong anisotropic interactions under Kawasaki dynamics”, arXiv preprint, arXiv:2007.04063 (2020).
- [4] J. Beltrán, and C. Landim, “Tunneling and metastability of continuous time Markov chains”, *J. Stat. Phys.*, **140:6**, 1065–1114, (2010).
- [5] J. Beltrán, and C. Landim, “Tunneling of the Kawasaki dynamics at low temperatures in two dimensions”, *Annales de l’Institut Henri Poincaré-Probabilités et Statistiques*, **51:1**, 59–88, (2015).
- [6] J. Beltrán, and C. Landim, “A Martingale approach to metastability”, *Prob. Theory Relat. Fields*, **161**, 267–307, (2015).
- [7] G. Bet, A. Gallo, and F.R. Nardi, “Metastability for the degenerate Potts Model with positive external magnetic field under Glauber dynamics”, arXiv preprint, arXiv:2108.04011 (2021).

- [8] G. Bet, A. Gallo, and F.R. Nardi, “Metastability for the degenerate Potts Model with negative external magnetic field under Glauber dynamics”, arXiv preprint, arXiv:2105.14335 (2021).
- [9] G. Bet, V. Jacquier, and F.R. Nardi, “Effect of energy degeneracy on the transition time for a series of metastable states: application to probabilistic cellular automata”, in press on *J. Stat. Phys.*, arXiv:2007.08342 (2020).
- [10] A. Bianchi, and A. Gaudillière, “Metastable states, quasi-stationary distributions and soft measures”, *Stoch. Proc. Appl.*, **126:6**, 1622–1680, (2016).
- [11] A. Bovier, M. Eckhoff, V. Gayrard, and M. Klein, “Metastability and low lying spectra in reversible Markov chains”, *Commun. Math. Phys.*, **228**, 219–255, (2002).
- [12] A. Bovier, and F. den Hollander, *Metastability: A Potential-Theoretic Approach*, Springer, Cham, 2015.
- [13] A. Bovier, F. den Hollander, and F.R. Nardi, “Sharp asymptotics for Kawasaki dynamics on a finite box with open boundary”, *Prob. Theory Relat. Fields*, **135**, 265–310 (2006).
- [14] A. Bovier, F. den Hollander, and C. Spitoni, “Homogeneous nucleation for Glauber and Kawasaki dynamics in large volumes at low temperature”, *Ann. Probab.*, **38:2**, 661–713, (2010), available online.
- [15] A. Bovier, and F. Manzo, “Metastability in Glauber dynamics in the low temperature limit: beyond exponential asymptotics”, *J. Stat. Phys.*, **107**, 757–779, (2002).
- [16] M. Cassandro, A. Galves, E. Olivieri, and M.E. Vares, “Metastable behaviour of stochastic dynamics: a pathwise approach”, *J. Stat. Phys.* **35**, 603–634, (1984).
- [17] O. Catoni, and R. Cerf, “The exit path of a Markov chain with rare transitions”, *ESAIM-Probab. Stat.*, **1**, 95–144, (1997).
- [18] O. Catoni, and A. Trouvé, “Parallel annealing by multiple trials: a mathematical study”, *Simulated annealing*, 129–143, Wiley-Intersci. Ser. Discrete Math., (1992).
- [19] R. Cerf, and F. Manzo, “Nucleation and growth for the Ising model in d dimensions at very low temperatures” *Ann. Probab.*, **41:6**, 3697-3785, (2013).
- [20] E.N.M. Cirillo, and J.L. Lebowitz, “Metastability in the two-dimensional Ising model with free boundary conditions”, *J. Stat. Phys.*, **90**, 211–226, (1998).
- [21] E.N.M. Cirillo, and F.R. Nardi, “Metastability for a stochastic dynamics with parallel heat bath updating rule”, *J. Stat. Phys.* **110**, 183–217, (2003).
- [22] E.N.M. Cirillo, and F.R. Nardi, “Relaxation Height in Energy Landscapes: An Application to Multiple Metastable States”, *J. Stat. Phys.* **150**, 1080–1114, (2013).
- [23] E.N.M. Cirillo, F.R. Nardi, and J. Sohler, “Metastability for General Dynamics with Rare Transitions: Escape Time and Critical Configurations”, *J. Stat. Phys.*, **161**, 365–403, (2015).
- [24] E.N.M. Cirillo, F.R. Nardi, and C. Spitoni, “Metastability for reversible probabilistic cellular automata with self-interaction”, *J. Stat. Phys.* **132**, 431–471, (2008).

- [25] E.N.M. Cirillo, F.R. Nardi, and C. Spitoni, “Competitive nucleation in reversible Probabilistic Cellular Automata”, *Physical Review E*, **78**, 040601(R), (2008).
- [26] E.N.M. Cirillo, F.R. Nardi, and C. Spitoni, “Sum of Exit Times in Series of Metastable States in Probabilistic Cellular Automata”, *Lecture Notes in Computer Science Cellular Automata and Discrete Complex Systems*, **9664**, 105–119, (2016).
- [27] E.N.M. Cirillo, F.R. Nardi, and C. Spitoni, “Sum of exit times in a series of two metastable states”, *European Physical Journal Special Topics*, **226:10**, 2421–2438, (2017).
- [28] E.N.M. Cirillo, and E. Olivieri, “Metastability and nucleation for the Blume-Capel model: Different mechanism of transition”, *J. Stat. Phys.*, **83**, 473–554, (1996).
- [29] P. Dehghanpour, and R. Schonmann, “A nucleation and growth model”, *Prob. Theory Rel. Fields*, **107**, 123–135, (1997).
- [30] P. Dehghanpour, and R. Schonmann, “Metropolis dynamics relaxation via nucleation and growth”, *Commun. Math. Phys.*, **188**, 89–119, (1997).
- [31] A. Gaudillière, F. den Hollander, F.R. Nardi, E. Olivieri, and E. Scoppola, “Ideal gas approximation for a two-dimensional rarefied gas under Kawasaki dynamics”, *Stoch. Proc. Appl*, **119**, 737–774, (2009).
- [32] A. Gaudillière, P. Milanesi, and M.E. Vares, “Asymptotic exponential law for the transition time to equilibrium of the metastable kinetic Ising model with vanishing magnetic field”, *J. Stat. Phys.*, **179**, 263–308, (2020).
- [33] A. Gaudillière, and F.R. Nardi, “An upper bound for front propagation velocities inside moving populations”, *Braz. J. Probab. Stat.*, **24**, 256–278, (2010).
- [34] A. Gaudillière, E. Olivieri, and E. Scoppola, “Nucleation pattern at low temperature for local Kawasaki dynamics in two dimensions”, *Markov Process. Relat. Fields*, **14**, 1741–1765, (2004).
- [35] B. Gois, and C. Landim, “Zero-Temperature limit of the Kawasaki dynamics for the Ising lattice gas in a large two-dimensional torus”, *Ann. Probab.*, **43:4**, 2151–2203, (2015).
- [36] F. den Hollander, F.R. Nardi, E. Olivieri, and E. Scoppola, “Droplet growth for three-dimensional Kawasaki dynamics”, *Prob. Theory Rel. Fields*, **125**, 153–194, (2003).
- [37] F. den Hollander, F.R. Nardi, and S. Taati, “Metastability of hard-core dynamics on bipartite graphs”, *Electron. J. Probab.*, Vol. **23**, paper no. **97**, 1–65, (2018).
- [38] F. den Hollander, F.R. Nardi, and A. Troiani, “Kawasaki Dynamics with Two Types of Particles: Stable/Metastable Configurations and Communication Heights”, *J. Stat. Phys.*, **145**, 1423–1457, (2011).
- [39] F. den Hollander, F.R. Nardi, and A. Troiani, “Metastability for Kawasaki dynamics at low temperature with two types of particles”, *Electron. J. Probab.*, **17**, 1–26, (2012).
- [40] F. den Hollander, E. Olivieri, and E. Scoppola, “Metastability and nucleation for conservative dynamics”, *J. Math. Phys*, **41**, 1424–1498, (2000).

- [41] M. Kac, G. Uhlenbeck, and P. Hemmer, “On the van der Waals theory of the vapor–liquid equilibrium. I. Discussion of a one-dimensional model”, *J. Math. Phys.*, **4**, 216–228, (1963).
- [42] R. Kotecký, and E. Olivieri, “Droplet dynamics for asymmetric Ising model”, *J. Stat. Phys.*, **70**, 1121–1148, (1993).
- [43] R. Kotecký, and E. Olivieri, “Shape of growing droplets- A model of escape from a metastable phase”, *J. Stat. Phys.*, **75**, 409–507, (1994).
- [44] J.L. Lebowitz, and O. Penrose, “Rigorous treatment of metastable states in the van der Waals-Maxwell theory”, *J. Stat. Phys.*, **3**, 211–236, (1971).
- [45] F. Manzo, F.R. Nardi, E. Olivieri, and E. Scoppola, “On the essential features of metastability: tunnelling time and critical configurations”, *J. Stat. Phys.* **115**, 591–642 (2004).
- [46] F. Manzo, and E. Olivieri, “Relaxation patterns for competing metastable states a nucleation and growth model”, *Markov Process. Relat. Fields*, **4**, 549–570, (1998).
- [47] F. Manzo, and E. Olivieri, “Dynamical Blume-Capel model: competing metastable states at infinite volume”, *J. Stat. Phys.*, **115**, 591–641, (2001).
- [48] F.R. Nardi, and E. Olivieri, “Low temperature stochastic dynamics for an Ising model with alternating field”, *Markov Process. Relat. Fields*, **2**, 117–166, (1996).
- [49] F.R. Nardi, E. Olivieri, and E. Scoppola, “Anisotropy effects in nucleation for conservative dynamics”, *J. Stat. Phys.* **119**, 539–595 (2005).
- [50] F.R. Nardi, and C. Spitoni, “Sharp Asymptotics for Stochastic Dynamics with Parallel Updating Rule with self-interaction”, *J. Stat. Phys.*, **146:4**, 701–718, (2012).
- [51] F.R. Nardi, A. Zocca, and S.C. Borst, “Hitting Time Asymptotics for Hard-Core Interactions on Grids”, *J. Stat. Phys.* **162**, 522–576, (2016).
- [52] E.J. Neves, and R.H. Schonmann, “Behavior of droplets for a class of Glauber dynamics at very low temperature”, *Prob. Theory Rel. Fields*, **91**, 331–354, (1992).
- [53] E. Olivieri, and E. Scoppola, “Markov chains with exponentially small transition probabilities: First exit problem from a general domain. I. The reversible case”, *J. Stat. Phys.*, **79**, 613–647, (1995).
- [54] E. Olivieri, and E. Scoppola, “Markov chains with exponentially small transition probabilities: First exit problem from a general domain. II. The reversible case”, *J. Stat. Phys.*, **84**, 987–1041, (1996).
- [55] E. Olivieri, and M.E. Vares, *Large deviations and Metastability*, Cambridge University Press, 2005.
- [56] R.H. Schonmann, “Slow droplets driven relaxation of stochastic Ising models in the vicinity of phase coexistence region”, *Commun. Math. Phys.*, **161**, 1–49, (1994).
- [57] R.H. Schonmann, and S. Shlosman, “Wulff droplets and metastable relaxation of Kinetic Ising models”, *Commun. Math. Phys.*, **194**, 389–462, (1998).