

# Two-Chains: High Performance Framework for Function Injection and Execution

Megan Grodowitz  
Arm Research  
Austin, TX  
megan.grodowitz@arm.com

Luis E. Peña  
Arm Research  
Austin, TX  
luis.epena@arm.com

Curtis Dunham  
Arm Research  
Austin, TX  
curtis.dunham@arm.com

Dong Zhong  
The University of Tennessee  
Knoxville, TN  
dzhong@vols.utk.edu

Pavel Shamis  
Arm Research  
Austin, TX  
pavel.shamis@arm.com

Steve Poole  
Los Alamos National Laboratory  
Los Alamos, NM  
swpoole@lanl.gov

**Abstract**—Some important problems, such as semantic graph analysis, require large-scale irregular applications composed of many coordinating tasks that operate on a shared data set so big it has to be stored on many physical devices. In these cases, it may be more efficient to dynamically choose where code runs as the applications progresses. Many programming environments provide task migration or remote function calls, but they have sharp trade-offs between flexible composition, portability, performance, and code complexity.

We developed *Two-Chains*, a high performance framework inspired by active message communication semantics. We use the GNU Binutils, the ELF binary format, and the RDMA network protocol to provide ultra-low granularity distributed function composition at runtime in user space at HPC performance levels using C libraries. Our framework allows the direct injection of function binaries and data to a remote machine cache using the RDMA network. It interoperates seamlessly with existing C libraries using standard dynamic linking and load symbol resolution. We analyze function delivery and execution on cache stashing-enabled hardware and show that stashing decreases latency, increases message rates, and improves noise tolerance. This demonstrates one way this method is suited to increasingly network-oriented hardware architectures.

## I. INTRODUCTION

The basis of all current mass-produced computing technology is the RAM-stored program model. To execute instructions, processors fetch code as stored data from addressable memory. Executing instructions induces the system to pull in data and use other resources. In distributed systems, many processors are spread out among vast memory and resources. So, it is sometimes more efficient to reverse the pull modality and instead push the instructions where there are better resources or better data locality. When a system is heterogeneous, some processors can do some operations more efficiently than others. Therefore, it is sometimes more efficient to put instructions on a processor with different capabilities.

Execution placement to increase efficiency has many potential solutions up and down the hardware/software stack. Active messages [1], message-driven distributed objects [2],

remote procedure calls [3], processing-in-memory [4], lambda functions [5], and more will provide various ways for a programmer or runtime to physically move computation around hardware localities of a distributed system.

In this work, we use remote dynamic linking in combination with RDMA and cache stashing to flexibly compose and inject function binaries and data, around a distributed system. We use the standard capabilities of the Linux kernel, the GNU Binutils, static ELF binary modification, and a high-performance user space runtime library to handle remote linking and loading.

Our method uses compile time code modifications to compose portable external name references, then uses standard (POSIX.1-2001) symbol extraction to bind those references at runtime. The resulting remote linking capability enables an active message [6] programming model consisting of a C language API to enforce canonical symbolic naming suitable for runtime introspection. A build toolchain processes C source files, then statically modifies the assembly to insert a few hooks needed by the runtime.

The runtime is implemented as a plugin to the UCX communication framework [7] that packages and injects active messages over RDMA using one-sided remote memory operations that trigger execution upon arrival. The programming model uses *Two* types of *Cooperatively Handled Actively Integrated Natively Shared-objects*, so we called it the *Two-Chains* framework and this is how it is referenced in the rest of the paper.

### A. Contributions of the Work

This work contributes an active message framework design and implementation that is high-performant and interoperable with other libraries. We designed this as a library extension with the bottom up goal of being able to do one-sided-put with an encapsulated C function over an RDMA network and have it trigger execution on the receiver.

We have also designed and implemented the unique feature of embedding code binaries (functions) within an active

arXiv:2108.02253v1 [cs.DC] 4 Aug 2021

message to take advantage of hardware that stashes data and instructions directly into processor caches.

To make the framework usable, we developed an active messaging interface and runtime design for a remote linking active message programming environment. The *Two-Chains* framework presents a unique division of objects into 1) heavyweight shared libraries used to setup interfaces and synchronize namespaces between processes and 2) lightweight encapsulated active messages used to push and run code on-demand over the network. Due to space constraints we do not include the API description in the paper. We are in process of open sourcing our code under the UCX GitHub repository [8].

Unlike other task frameworks, *Two-Chains* does not come with much extra baggage like schedulers or name registries. It packages, transfers, and executes C functions between processes really fast and clean. It depends only on the UCX communication library. This is why it is so interoperable with other languages and runtimes.

To demonstrate the benefits, we implemented several benchmarks using the *Two-Chains* framework and analyzed the performance in several scenarios: *Two-Chains* framework performance overhead, performance comparison with and without code binaries included in messages, comparison of performance improvements with hardware that provides cache stashing, evaluation of tail-latency performance, and the evaluation of hardware assistance to improve CPU-cycle efficiency in spin waits.

There are definitely security implications of writing programs that use disaggregated namespaces, runtime symbol resolution, and code movement. A complete exploration of securing this implementation is outside the scope of this work. For now, we provide a number of design options to improve security and discuss issues specific to the motivating application environments where *Two-Chains* is designed to work well.

The rest of the paper organized as follows. Section II discusses the existing state of the art in the area of dynamic computation movement and how *Two-Chains* provides unique capabilities. Section III presents the software architecture design for remote linking and messaging. Section IV presents the *Two-Chains* programming model, build toolchain, and a UCX library extension to use *Two-Chains* in distributed applications. Section V discusses the security implications, opportunities and potential solutions. Section VI describes our testbed design and active message benchmark programs. Section VII presents and analyses the performance characteristics of *Two-Chains*.

## II. MOTIVATIONS & BACKGROUND

In general, compute and data migration may help in cases where one process provides a better resource than another: faster data access, specialized acceleration, less contention, lower power, etc. Nevertheless, compute and data migration introduces overheads in the way of task movement [9] or management [10].

In particular, we are motivated by data-intensive irregular applications, where compute migration is more likely to help if:

- There are unordered concurrent shared writes to arbitrary locations throughout a large data set, so bottlenecks result from data sharing across memory zones [11] or between servers [12].
- The computation is highly decomposed into small tasks and displays dynamic levels of parallelism, so task movement is cheap and load balance is tenuous [13].
- The results of unordered concurrent writes to shared data during computation determine code execution paths and runtime levels of parallelism and therefore behavior is determined by data races making the application be sensitive to long tail latencies.

Serving the needs of large-scale distributed applications through computation movement is a problem that motivates simultaneous innovation in hardware, runtimes, algorithms, and programming models, since these have all been co-designed for decades with the exact opposite assumption of stationary computation with moving data. Because of this, solutions to this problem tend to be overloaded in terms of innovating contributions, making a steep adoption curve.

### A. Runtimes & Programming Models

Active messages [6] combine a data payload with executable code on a receiver, which is what we do here. The novel feature of *Two-Chains* is the ability to move the code in messages, and then execute it on arrival without any virtual environment. The GasNET [1] system provides an API for registering and invoking active messages. Unlike GasNET and other similar systems, *Two-Chains* uses name binding instead of function registration and incorporates the execution code into the message itself. Another downside of GasNET compared to *Two-Chains* is that GasNET implements a full PGAS model, which comes with an added overhead of the memory footprint for a global shared heap.

The Snap Microkernel [14] project provides a platform for remote procedure calls in the context of network functionality distribution. Like many of the other computation placement and migration frameworks, it is a heavyweight multifunction entity. Our solution could be used as a building block as part of such a system. In the datacenter setting, lightweight container launch for Lambda functions is implemented with Firecracker [15]. Another work from Fouladi et al. provides very fast container launch to create highly granular lambda function execution [5]. None of these projects addresses issues like heterogeneity of hardware, since containerization is meant to abstract this. *Two-Chains* can be used as a shim between hardware and higher level libraries.

Charm++ [2] implements distributed shared objects with the ability to remotely call methods on those objects. The concepts are similar to *Two-Chains*, but Charm++ is built on top of other, leaner libraries similar to *Two-Chains* and UCX, which operate at lower levels of the stack.

The CHAMELEON [13] framework by Klinkenberg et al. uses `#pragmas` and runtime APIs to encapsulate OpenMP tasks as migratable entities in a reactive workload balancer for irregular applications written in MPI. Unlike that work, *Two-Chains* does not depend on OpenMP or MPI, does not require using C++, nor requires explicit task progress if the UCX library uses progress threads. Further, its remote VA resolution process to move tasks between address spaces is a heavyweight exchange of references via MPI Send/Recv for each migration event. Our work could potentially be used as a lower runtime layer to greatly simplify and speed up CHAMELEON, especially since they found in the course of their work that push-oriented compute movement (as we have implemented here) is a better mechanism than work stealing for load balancing since it allows computation-communication overlap.

The FaRM [16] project implements a shared address space programming model that uses the RDMA network for remote object manipulation. Our work also uses RDMA, but, in addition, provides the flexibility of moving user-defined functions and data to remote machines.

### B. Network Driven Computing

Our active message framework shares features with the common practice of computational offload (e.g. code migration) from mobile to cloud/edge devices [17]–[19] to speed up mobile devices. Unlike the active message work presented here, mobile code offload does *not* use the code movement itself as communication. Code offload typically extracts tasks and moves compute to a heavily virtualized mirror of the mobile device that is just much faster.

This work also resembles user space code patching [20] which modifies the in-memory process image to replace individual functions [21] or the whole code of a running application [22] to do software update with no downtime. The key difference here is that code patching is not fast nor expressive enough to be a programmable communication and data access model.

*Two-Chains* relies on remote linking for symbol resolution across multiple processes, like the global namespaces implemented in distributed computing environments such as Plan 9 [23], Spring [24], and Graphene [25]. But this toolchain works without needing to bind names through some namespace manager; it uses ELF library loading as a per-process name resolution mechanism.

### C. Hardware for Moving Compute

Hardware thread co-scheduling to reduce cache line contention is an old concept [26], [27] and largely orthogonal to this work. Recent work of note by Wang et al. modified the NOVA NVM filesystem to allocate memory mapped file data to specific NUMA nodes and migrate threads based on memory-as-file accesses [28]. Our work could interact nicely with such a kernel space modification by putting active messages payloads into NVM memory-as-files to be picked up by their scheduler.

On the grand scale, the EMU architecture [29] provides hardware support to transparently move threads between processors in response to remote access. *Two-Chains* does not do any automatic function relocation, because that introduces a very complex scheduling and data layout problem into the programmer’s design space [30]. However, since *Two-Chains* can inject functions from process to process with minimal overhead, it would be an ideal model in which to construct complex, low overhead function movement policies in userland software.

## III. REMOTE LINKING & MESSAGE MECHANICS

Dynamic linking and loading has been in standard use since systems became complex enough to have separately maintained software libraries [31]. It allows system updates to many programs at once (without re-linking the program) by replacing a library at some fixed location or name. Remote runtime linking extends that concept to allow distributed application updates to sub-processes of the application that alter subsequent active message behavior (without re-starting the process) by loading a library into a process to change the resolution of objects or functions with fixed symbolic names. This way, applications can implement dynamic control and compute with library loading and active message linking.

One-sided operations over RDMA networks enable fast, delivery on-demand execution of active messages. The runtime sets up a receiver thread waiting to call a function with minimal latency when a message payload arrives, possibly carrying the function code in the message. For code to travel in the message, the active message function code has been statically modified to allow runtime linking against symbols on an arbitrary host by redirecting all *global offset table* (GOT) accesses to an indirection stored in the message.

### A. Reactive Mailboxes

On-demand active message execution requires 1) a process context for the incoming message, 2) a destination for messages to arrive, and 3) a mechanism to execute messages as they arrive asynchronously. Using RDMA operations, we implement a one-sided mailbox trigger mechanism as shown in Fig. 1. Memory is pinned for one-sided remote access by an InfiniBand host adapter and a thread is spawned to wait then wake up and act when signal values are written to specific mailbox locations. The thread provides an execution context; pinned memory provides a destination for data and instruction; triggered wake-up arrival provides an on-demand execution mechanism.

We do not use interrupts for wake-ups because that would increase latency with Linux kernel scheduler activity and extra bus transactions. We are targeting latency sensitive operations with the active message model, so this is not acceptable. Polling is faster, which is why high-performance communication libraries like MPI, DPDK, and OVS are moving away from interrupts to use polling. The downside of polling is that it uses more energy than interrupts. In order to mitigate polling inefficiency while preserving its performance we use

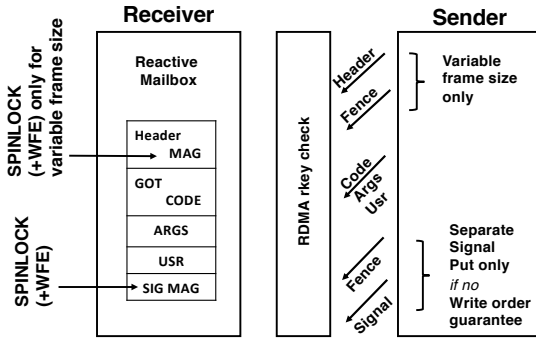

Fig. 1. Message mailbox for on-demand active message

hardware-supported sleep operations such as the Arm *Wait For Event* (WFE) instruction that is set to trigger a wakeup when a mailbox signal location is altered.

The mailbox expects a specific message format, shown in the left side of Fig. 1. The *Two-Chains* library provides message packing routines that call user-provided functions in the active message definition to setup the data payload. In the current implementation, the message includes a header, preamble, GOT indirection, code, arguments, and data payload. For the most compact representation as shown here, we place all code and data together (USR) and mark all mailbox pages with read, write, and execute permissions. The runtime can be reconfigured in various ways to separate code and data into separate locations, make all data read-only, or send no code in messages at all.

RDMA operations for on-demand execution are shown in Fig. 1, with several different system-dependent options. If messages use variable-sized frames, the library must be configured to wait on the final byte of the header (MAG), then retrieve the size, then wait on the final byte of the message (SIG MAG). If the ordering constraints on RDMA put operations are not enforced between hosts, then each signal put has to follow a fence operation and be sent in a separate put from the preceding data put. Modern servers like the one we use as a testbed for this study enforce ordering. We also use fixed-size frames for this study, so we can send the entire message in one put operation.

### B. Remote Linking Mechanism

For code to arrive in messages from the sender process space, we need to resolve virtual addresses (VAs) for external symbols on the receiver. Linking on message arrival is far too slow and would require sending a whole library, when we just want to send a bit of code. At compile time, the binary is modified so that all references to the *global offset table* (GOT) will redirect through a pointer stored a fixed PC-relative location that we choose.

This is all supported with standard position-independent library compilation using `-fPIC` or `-fpic` flags and the `-shared` flag. The code will be produced with PC-relative addressing modes for accessing data within the library. Any symbols outside the library are unresolved at compile time

and use indirection through addresses resolved during library load. The compiler expects the indirection table itself to be loaded a fixed PC-relative location. To be able to place small code sections at any location on a receiver, we replace the fixed PC-relative table offsets with indexed access through a pointer stored at a PC-relative location.

To do this transformation, we force all external symbols to use the GOT by passing the `-fnoplt` flag to `gcc`. Then we find all GOT indirections in the code and replace them with indirections through a pointer at a PC-relative location that we choose.

For our test configuration, the GOT redirect is located just before the code in the message, and is set by the sender after an exchange with the receiver. For other configurations, the receiver could set a GOT pointer somewhere relative to the mailbox. The constraint is that the relative location of GOT indirection to start of code in mailbox must be known at active message compile time.

## IV. THE *Two-Chains* TOOLCHAIN

Over the past year, we have built up the *Two-Chains* toolchain to provide active messages with functions injected over RDMA. The framework has gone through several phases, with the current status being close to release as a subcomponent of the UCX library. *Two-Chains* measures up to the competition with a framework that:

- Is not exotic to anyone familiar with C programs.
- Does not follow an SPMD model for distributed programming, e.g. MPI. A program can easily define different functions with the same symbolic name for different processes, so that when a message arrives it will call a function specific to that process, much like function overloading.
- Encourages single source file active message definitions.
- Automates source directory-based packaging of active messages.
- Is interoperable with existing C libraries just as they are, i.e., no re-compilation, no re-linking, no wrappers, etc.
- Implicitly pulls in read-only data to messages to support functions like `printf`.

This environment specifically does not enforce library version dependency any more than a Linux system enforces what happens when an ELF executable is dependent on a shared library path and that shared library gets replaced. This is not a virtual environment; it is subject to the system environment. Since most applications run under several types of virtualization already – containers, VMs, hypervisors, etc – we do not add another layer without strong, specific reasons.

### A. Rieds and Jams

The *Two-Chains* model defines two types of cooperatively handled actively integrated natively shared-objects. **Relocatable interface distributions** (rieds) are shared libraries that one process drives over to some remote process to dynamically setup interfaces and data objects as needed. Jams are **just a mobile segment**. In the current work, jams are C functions

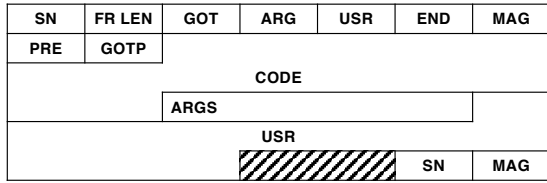

Fig. 2. *Injected Function* GOT patched from receiver

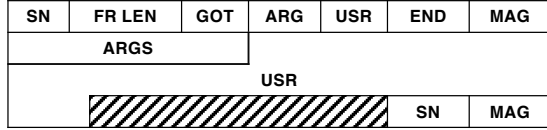

Fig. 3. *Local Function* code in loaded library on receiver

with payload and fast relocation updates that a process packs into active message for injections to another process. In this work, we focus on engineering and performance of jams. We use rieds only as dynamic libraries that are loaded and auto-initialized in *Two-Chains* packages to support our benchmarks. Ongoing development will further improve our rieds for future work.

The *Two-Chains* are organized into packages. Each package has a package name that is set when the package is built. A package contains elements; each has a unique element ID and element name within the package. The current build tools take a list of jams and rieds with source files located in a subdirectory tree. For now, the build tools expect each element to be defined in one canonically named source file, e.g. `jam_append.amc` or `ried_array.rdc`.

The build process generates a package header file and shared libraries in the package install directory. At this time, the build process requires an installation path to enable simpler runtime APIs for loading package elements. Once the package is installed, a program includes the generated package header and the *Two-Chains* runtime headers.

### B. Active message invocation methods

*Two-Chains* supports two types of invocation methods: local function invocation based on receiver ID (*Local Function*) and function invocation based on binary code in the message itself (*Injected Function*). Fig. 2 represents the *Injected Function* message layout in memory and Fig. 3 represents the *Local Function* message layout. Since *Injected Function* has to update the GOT table and invoke code communication over the network, the layout in Fig. 2 includes a patched GOT (GOTP) section and a code section (CODE), in addition to data payload (USR). Otherwise, the *Local Function* method uses the same message formats, headers, source code files, header generation, and internal APIs as the *Injected Function* mechanism with the difference that it invokes the local function representation from the library instead of the function code coming over the network.

The *Local Function* procedure was originally designed as a benchmark to provide a comparison of the overheads of

moving code over network versus sending payload data and a function ID over network. After implementing it, it was surprisingly straightforward to provide this option as a core library function.

The toolchain generates a shared library of the same set of active messages compiled without any modification for GOT patching. The *Local Function* shared library is loaded on the receiver and provides a vector of function pointers that are called by using the ID included in the active message header.

By providing both in the same package from the same source, the same code could be ported between systems where different types provide better performance. It may also be beneficial to mix message types so that some active messages contain code and others do not. We are continuing to investigate these types of tradeoffs between remote linked and locally invoked active message types.

## V. SECURITY IMPLICATIONS AND MITIGATIONS

A full security model design and implementation is well beyond the scope of this paper. This section provides an overview of security challenges and directions for security improvements.

For our *Two-Chains* framework implementation, we have relied on the built-in security mechanisms defined by the UCX framework and IBTA standard [32], which underpins RDMA interconnects. Specifically, we are using a remote access key (RKEY) to register and control remote memory accesses. For IBTA interconnects, the RKEY is defined as a 32-bit value. When the memory is registered for remote memory access, the underlying interconnect generates the RKEY based on a virtual memory address and the permissions (remote read, write, or atomic access). In order to access the memory region over the RDMA interconnect, the target process has to provide the RKEY to the RDMA initiator through an out-of-band channel. Then, the remote memory access initiator uses the RKEY to remotely read and write to the target process memory. If the process accesses the memory with an invalid RKEY, the request gets rejected at the hardware level.

There are a number of security concerns [33] regarding the strength of RKEY protection as defined by the IBTA standard. Improvements to the IBTA security model are out of scope for this work. However, since we have constructed this as a module of the UCX framework, the implementation is not as strictly tied to the IBTA network implementation.

For our primary target use case of massive analytics computations on a large dataset, the attack surface can be greatly reduced by encasing the entire application. For sensitive data analysis in government, finance, oil and gas, etc, this is already done with physically isolated on-site clusters, air-gapping, etc. Recent work by Zhu et al. [34] describes a way to create an enclave for an analytics computation at the rack level, which has a similar effect.

Aside from isolating the entire application and data, we have already mentioned several reconfigurations for active messages that improve security. The following measures can be employed with straightforward modifications to the runtime.

- Separate the user data payload area from the rest of the message and make the function arguments read-only so that the code can be placed on a different memory page than writable data, and writable data will not reside on executable pages.
- Do not accept GOT pointer indirection in the message from a sender. Have the receiver insert the GOT pointer on message arrival from a secure read-only location [35].
- Keep ried interfaces and/or jam libraries in secure enclaves.
- Extend the IBTA standard to support executable permissions in addition to read, write and atomic.

The performance impact of these options is a subject for future study, but none of these would necessarily incur large performance penalties.

The feasibility of maintaining libraries in enclaves is discussed by Wang et al. [36] in a presentation of their real world experience porting Rust libraries into enclaves. In terms of large corporate settings, we would generally expect *Two-Chains* to be used by a platform team, and not the product teams. In such a setting, a platform group would work with product groups to curate a secure, minimal set of rieds and jams to support a variety of products.

## VI. EXPERIMENTAL DESIGN

*Two-Chains* was designed from the ground up to make active message delivery and execution as close to an RDMA put operation as possible in performance and programming effort, even when instructions are delivered in the message. This fills a niche for general purpose, high performance one-sided active messaging with few external dependencies. To verify that *Two-Chains* meets the performance goals we set, we designed and implemented set of jam benchmarks and integrated them into the existing performance testing tool in the UCX library.

### A. Benchmark Shapes

The performance tool for UCX connects two hosts over a network, and runs a number of iterations of a particular operation to determine bandwidth, message rates, and latency of the operation.

1) *Ping Pong*: The ping pong benchmark shape sends one message at a time between hosts. Each host has one message mailbox. It waits on the message signal (*ping*), executes the active message on arrival, then sends a response (*pong*) message to the initiator of the message, which also executes the active message on *pong* arrival. This shape of the benchmark is used for measuring the half round-trip (one-way) active message latency.

2) *Injection Rate*: The injection rate benchmark is used to test the rate at which active messages can be processed when a sender puts messages on the receiver as fast as possible. The UCX communication library has mechanisms and buffers for flow control, but, since the *Two-Chains* runtime already waits on mailbox data to arrive, we used our own flow control to avoid adding extra overhead to the reactive mailbox. In

injection rate benchmarks, the receiver has  $M$  banks, where each bank has  $N$  mailboxes. The sender keeps one signal flag per bank, which is reset after sending  $N$  messages to the matching bank on the receiver. Every time the receiver empties a bank, it sets the flag for that bank on the sender. The sender will not send new messages to a bank until the flag for that bank is set.

### B. Benchmark Functions

Each of the new benchmark shapes can run any active message in the *Two-Chains* test package that is generated and installed with the UCX performance tester. The following jams were used for benchmarking the implementation.

1) *Server-Side Sum*: The simplest active message here is the *Server-Side Sum*. *Server-Side Sum* loops over all of its payload in order to accumulate a sum. Then, it stores the result at the next spot in an array in the server.

2) *Indirect Put*: The indirect put benchmark models a common distributed use case where a program wants to access and modify some data structure where every access goes through a level of indirection. Graph structures and index tables are a prime example. In [14] one-sided indirected put is presented as an extension of RDMA semantics. In the work by Xie et al. [12], an RDMA caching system is designed to move hash keys and values around at runtime in response to changing graph requirements.

Using our indirect put operation, as shown in Fig. 4, a client can put an element (`array[]`) into the server's memory. Each element is indexed by an arbitrary key chosen by the client that the server then uses to probe the index/offset (hash value) and store the data. Once the unique key is selected, the client issues an active message to the server with the indirect put request. The active message takes three major steps: (1) It pushes the key into the hash table, using the key to probe the hash table. (2) It chooses a proper offset and stores it in the hash table associated with this particular key, which means the client has full control over the indirect distribution of the data and the lookup function itself. (3) Finally, the server issues a memory copy to store the payload data into its memory by copying the payload data into the `put_count * type size bytes` starting at `base address + offset`.

### C. Testbed Platform

The development and evaluation testbed for this work consisted of two servers, each with a 4-core, Arm-based modern superscalar processor with a 1MB dedicated L2 cache per core, a 1MB shared L3 cache per 2-core cluster, and a 8MB shared last level cache (LLC). The core clock is 2.6GHz and the on-chip interconnect clock is 1.6GHz. Each server has 16GB of DDR4-2666 main memory. For the interconnect feeding RDMA writes from the network to the test systems, we used two Mellanox/Nvidia ConnectX-6 200Gb/s InfiniBand dual-port HCAs. On each machine, the HCA was plugged into a PCIe Gen4 slot. The two systems were connected back-to-back (no InfiniBand switch) using the first port on each ConnectX-6 HCA. The second port of each HCA was not used.

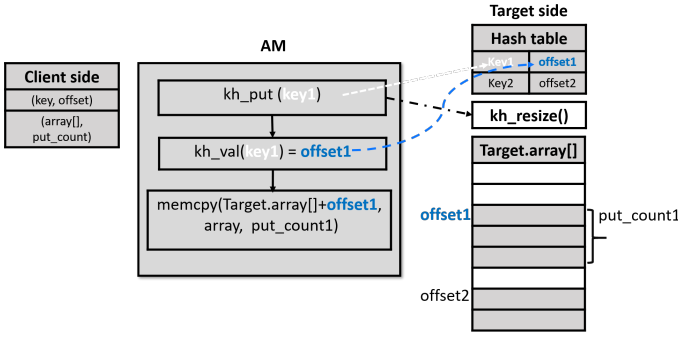

Fig. 4. Indirect Put active message (AM) function. The function calculates an offset (`offset1`) based on the key (`key1`) and copies the data (`array[]`) to the offset location.

LLC-stashing is supported in these systems. The PCIe root complex controlling the ConnecX-6 HCA is connected into the on-chip interconnect. Traffic arriving from the network is stashed into the LLC and, eventually, written back to the main memory.

We are interested in cache stashing because it is a technique to minimize cache misses when data are arriving from the network. Since *Two-Chains* injects data and instructions over the network into remote machines, we expect stashing to provide better network performance characteristics.

To enable hardware-feature comparisons, each server’s firmware was configured to allow toggling of the LLC-stashing and the prefetching mechanisms. The servers used Fedora 30, running a custom Linux 5.4 kernel, modified to allow user space control of the CPU prefetching mechanisms. We used the RDMA and InfiniBand drivers that came with the kernel, versioned 20.1-3.fc30.

## VII. PERFORMANCE RESULTS AND ANALYSIS

Rather than targeting another active message implementation as a performance baseline, we compared *Two-Chains* against RDMA puts. We are interested in maximizing the benefits of low-latency, high-bandwidth one-sided communication from the reactive mailbox design. There are no other stand-alone active message frameworks that we know of that deliver and execute active messages in this way.

First, we verified that the *Two-Chains* framework and its reactive mailbox were not introducing any performance penalties compared to UCX’s put operation. Fig. 5 and Fig. 6 compare the latency and bandwidth characteristics of UCX put with those of the active message put when running in the without-execution configuration. Running in the without-execution configuration uses *Two-Chains* to inject active messages, deliver them to the mailboxes and trigger their arrival, but skips the actual function invocation. From Fig. 5 and Fig. 6, we see no significant drop in latency, 1.5% at worst, for messages going to the *Two-Chains* reactive mailboxes. In fact, we see bandwidth improvement across all message sizes tested when running in the *Two-Chains* without-execution configuration, ranging from a 1.79× speedup up to a 4.48×

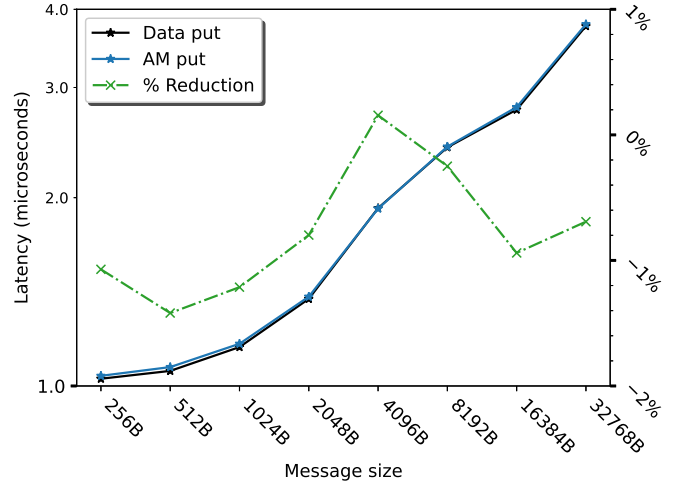

Fig. 5. *Server-Side Sum: Two-Chains* active message (AM) put without-execution latency overhead

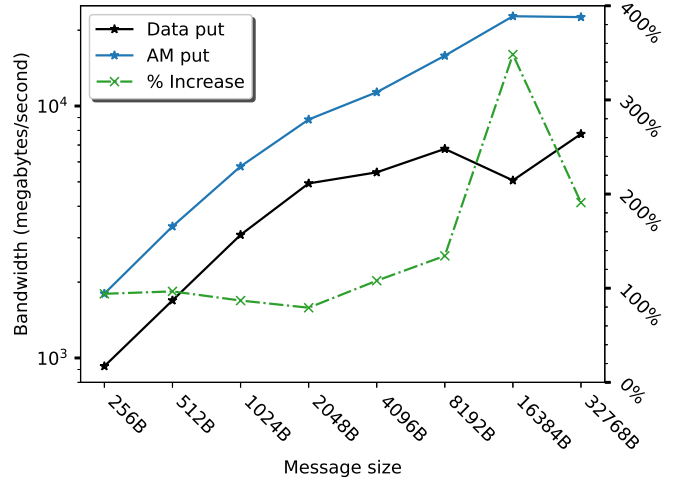

Fig. 6. *Server-Side Sum: Two-Chains* active message (AM) put without-execution bandwidth overhead

speedup. Our mailbox flow control and memory actually see improvement because the standard UCX put operation has more library overhead for flow control and detecting message completion.

### A. Comparison of Local versus Injected Function Invocations

The goal of this experiment is to evaluate the trade-offs of *Local Function* versus *Injected Function* invocation for various message sizes. Since *Two-Chains* lets code reside on the sender or receiver, we can measure the overhead of *Injected Function* execution relative to *Local Function* execution. Fig. 7 and Fig. 8 contrast the latencies and message rates for *Injected Function* and *Local Function*. Note that the comparison is between equivalent payload, but not equal message size. The code for *Indirect Put* is 1408 bytes when shipped, and messages are sized to the nearest 64B: the

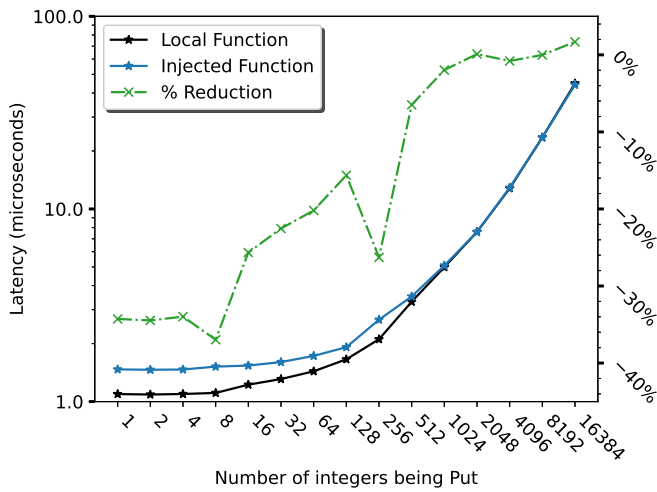

Fig. 7. *Indirect Put*: Latency comparison between injected and local function invocation

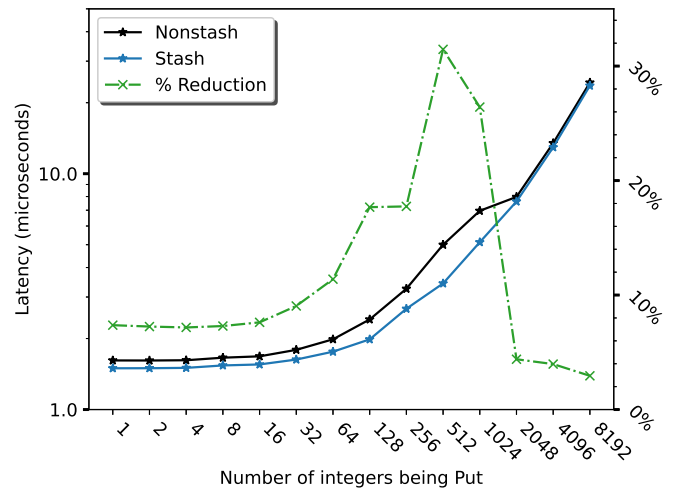

Fig. 9. *Indirect Put*: Latency reduction with LLC stashing enabled (Stash) versus LLC stashing disabled (Nonstash)

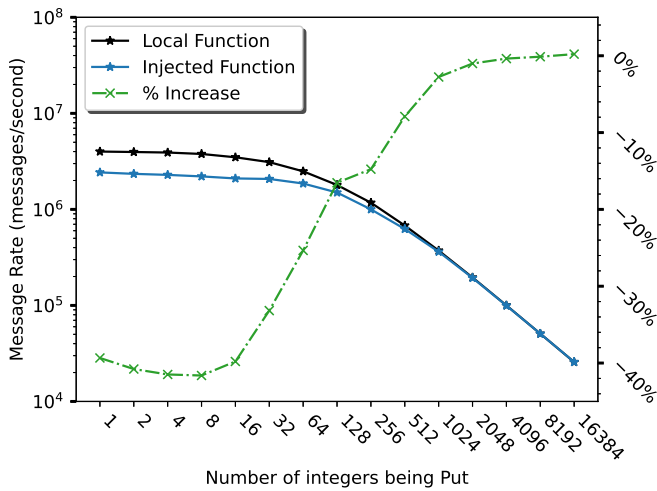

Fig. 8. *Indirect Put*: Message rate comparison between injected and local function invocation

1-integer message size is 64B for *Local Function* versus 1472B for *Injected Function*. The approximately 40% losses in latency and bandwidth correspond to sending much more data per *Injected Function* message for small payloads. Once the payload is large enough, the overhead of moving code becomes negligible, as expected.

The irregularities in the latency difference at 8 and 256-integer payload sizes are an interesting and relevant artifact from using the UCX framework. For efficient performance, the UCX library will change the protocols used for sending a message based on its size. When a message is just over the threshold size to move into a new code path, there will be a slight performance degradation since the message size is just within the acceptable range. For each of the 8 and 256-integer payloads, the *Injected Function* message has just crossed a new code path threshold since it is larger, which is slightly

less performant at that message size. *Server-Side Sum* results are similar to *Indirect Put*, except that the code is smaller so the convergence to 0% performance loss happens sooner, with *Server-Side Sum* around the 64-integer scenario while *Indirect Put* goes all the way to 1024 integers.

#### B. Latency & Message Rate Improvement with Cache Stashing

As we mentioned earlier, in our implementation of the active message protocol we take advantage of cache stashing capabilities available in the system. In order to disable or enable stashing to LLC we use low-level controls that let us explicitly disable or enable stashing for the ConnectX-6 device. Fig. 9 shows a decrease in latency for the *Indirect Put* benchmark when cache stashing is enabled. Stashing the message code and data to LLC improves latency by up to 31%. However, once the message size is large enough to trigger the prefetcher to start pulling the message data on arrival, the difference in latency for messages going to DRAM versus LLC starts narrowing, as prefetches are issued ahead enough to mask the larger DRAM access latency. The trends for latency improvements are similar for the *Server-Side Sum* benchmark, which we omit for space.

The benefits of LLC stashing for *Indirect Put* message rates (Fig. 10) are clear. For *Indirect Put*, there is a 92% (1.9 $\times$ ) message rate increase for small put counts, with this advantage reducing as message sizes get large enough to benefit from the prefetcher. The small code footprint and easy-to-prefetch linear access pattern displayed by *Server-Side Sum* result in up to 28% improvement for message rates at any size (plot omitted for space).

These results are limited in scope due to the test harness that we have employed. But they do make the larger point that the stashing or RDMA'ing of functions involves the entire cache hierarchy. Applications that would benefit the most from being able to stash encapsulated functions would be those that are to prefetch or those that have large reuse distance within the



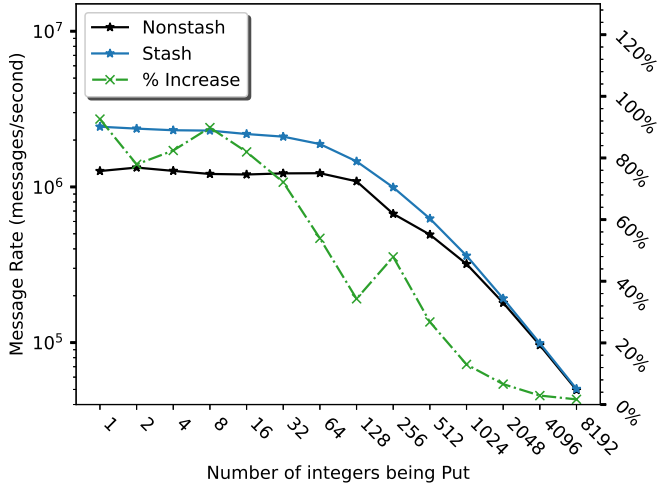

Fig. 10. *Indirect Put*: Message rate increase with LLC stashing enabled (Stash) versus LLC stashing disabled (Nonstash)

application and are likely to be cold in the memory hierarchy when invoked.

### C. Tail Latency with Stashing

Our active message runtime does not take over the entire system; in a realistic scenario, it would run alongside other applications to minimize resource underutilization, the system would be run as close to capacity as possible. To quantify the adverse effects of running at-capacity systems, we measured the tail latency of *Two-Chains* active messages.

To test the characteristics of LLC stashing *Two-Chains* active messages on overloaded systems, we ran `taskset -c 0-3 stress-ng --class vm --all 1` along with the benchmark to generate stressful work for the paging and memory systems. One way to detect service degradation is to measure the tail latency of the active messages, so, along with 50<sup>th</sup> percentile (typical or median) latency, we collected the 99.9<sup>th</sup> percentile (tail) latency. We also calculated what we call *tail latency spread* which is how much larger the tail latency is than the median and is show in (1).

$$Latency_{tail\ spread} = \frac{Latency_{tail} - Latency_{typical}}{Latency_{typical}} \quad (1)$$

The smaller tail latency spread is, the narrower the latency distribution is. A narrower latency distribution leads to a more predictable and less erratic latency. The tail latency spread can be thought of as a sort of latency *variance*. We plotted tail latency, typical latency and tail latency spread below.

Fig. 11 and Fig. 12 show the latencies and tail latency spread of executing the *Indirect Put* and *Server-Side Sum* benchmarks on an overloaded system. The *Indirect Put* (Fig. 11) tail latency is up to 2.4× better when LLC stashing is enabled. With stashing, the tail latency spread peaks at 182%, while non-stashing has an erratic behavior. This erratic behavior is likely due to interference by the stress workload competing

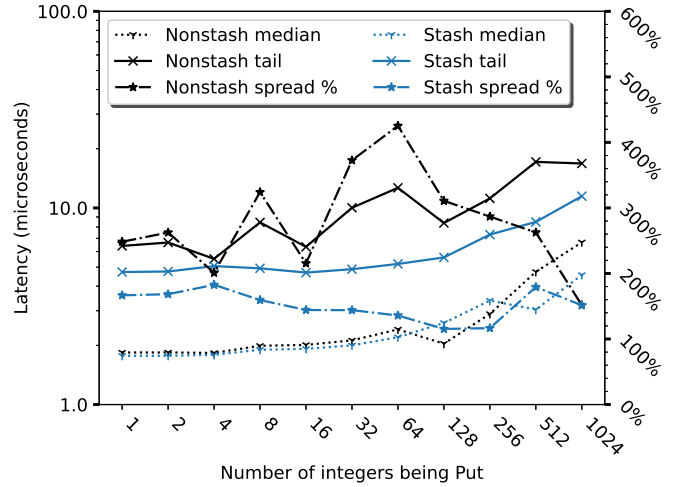

Fig. 11. *Indirect Put*: LLC stashing enabled (Stash) and disabled (Nonstash) latency on fully-loaded system

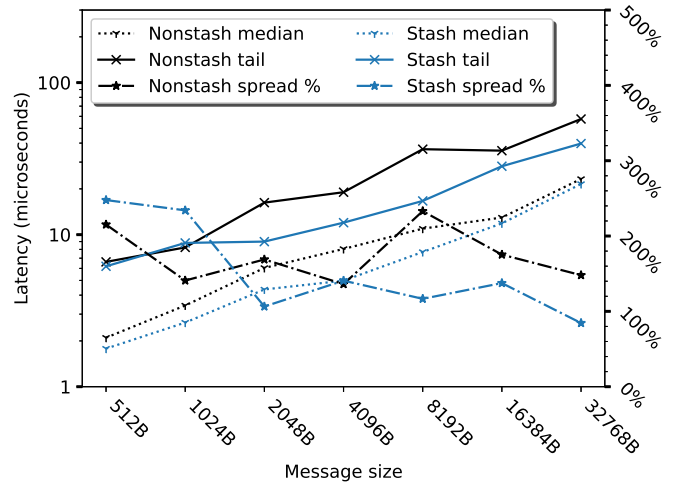

Fig. 12. *Server-Side Sum*: LLC stashing enabled (Stash) and disabled (Nonstash) latency on fully-loaded system

for memory access. By writing directly to the LLC, stashing reduces active message memory bandwidth utilization.

As shown in Fig. 12, the *Server-Side Sum* LLC stashing 99.9<sup>th</sup> tail latency is generally better than that of the non-stashing scenario, in some cases performing twice as fast. Starting with the 2KB message size, stashing provides a tighter latency distribution compared to the non-stashing case, with a tail latency no larger than 137% of the median latency. These results highlight the benefits of stashing even on at-capacity systems.

### D. Efficient Spin Polling

In section III, we described the *Two-Chains* implementation of efficient message polling. We use Arm’s *WFE* instruction to reduce the number of CPU cycles the framework spends on spin-poll waiting on an active message arrival signal. To see

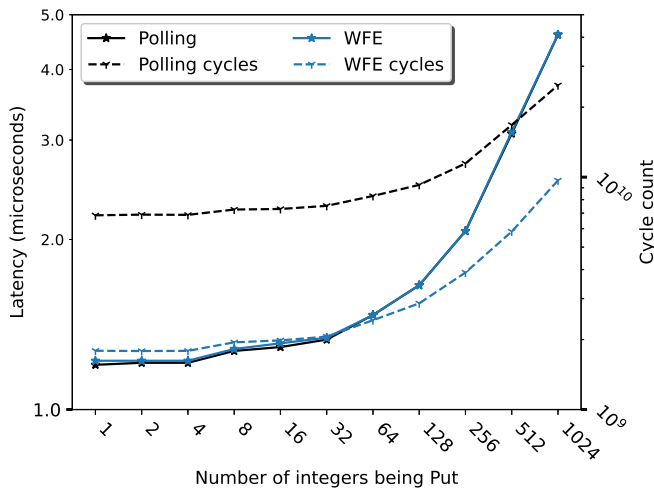

Fig. 13. *Indirect Put*: Effects of using WFE on *Two-Chains* active messages

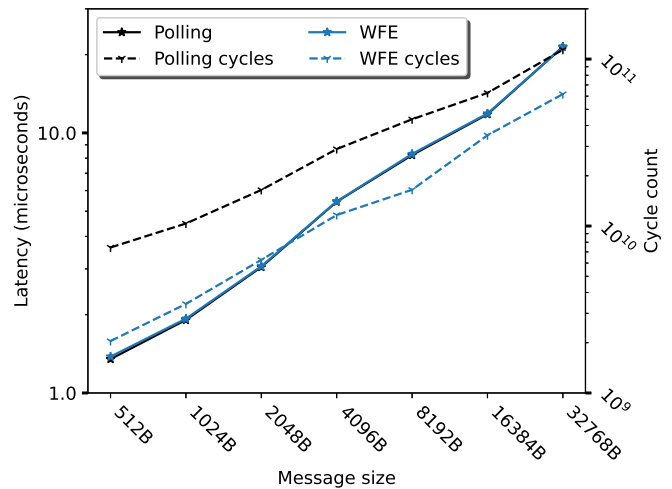

Fig. 14. *Server-Side Sum*: Effects of using WFE on *Two-Chains* active messages

the effects on cycles, we gathered the CPU cycles counters for the full benchmark run, including 10,000 warm up iterations and 1,000,000 latency-measuring iterations.

Fig. 13 shows the active message latency and the full-runtime CPU cycle counters for our *Indirect Put* benchmark. The latency remains the same for most payload sizes tested when *WFE* is inserted in the wait loop. Compared to busy-waiting (*Polling*), see up to 1.5% latency penalty, at the 64B data payload size. When *WFE* is used, we see between a 3.8 $\times$  and 2.5 $\times$  CPU cycle reduction. The cycle-count reduction comes solely from the waiting-for-active message portion of the code.

When running the *Server-Side Sum* active message (Fig. 14), there is virtually no latency difference between busy-waiting (*Polling*) and using *WFE*. There is a significant difference in cycle count between *Polling* and *WFE*. When using the 512B message size, the *WFE* benchmark uses only 27% of the cycles required by the *Polling* benchmark, a 3.6 $\times$  reduction. For the 32KB message size, the difference contracts to 1.84 $\times$ .

## VIII. CONCLUSION AND FUTURE WORK

In this work, we presented the *Two-Chains* active message framework that implements a new class of active message semantics where data and binary functions are delivered over the RDMA network. We demonstrated how these semantics can be used to implement advanced communication functions such as *Server-Side Sum* and *Indirect Put*. The framework uses remote dynamic linking and loading to resolve active messages to external symbolic references for functions arriving over the network. *Two-Chains* injects binary functions and data to a remote system’s last level cache over the RDMA network. We demonstrated that this optimization reduces the *Indirect Put* active message latency by up to 31% and increases its injection rate by up to 92%. In addition, this optimization reduces the tail latency by x2.4 for fully loaded systems. To address efficiency concerns typically associated with busy

polling on message arrival, we used the *WFE* instruction to reduce the number of cycles spent on polling by up to 3.8 $\times$  without sacrificing latency.

In future research we plan to extend *Two-Chains* function injection logic to detect reoccurring functions that have been injected and auto-switch to local function execution while reducing the size of the active message. In addition, we plan to integrate the *Two-Chains* framework with the Charm++ UCX conduit [37] for further framework evaluation. On the security front, we will explore how efforts in the confidential compute domain [38] can be used to improve the security of function injection over an RDMA network.

## IX. ACKNOWLEDGMENTS

The authors would like to thank the Los Alamos National Laboratory for their continued support of this project. We thank Gilad Shainer from Nvidia for providing us with the latest generation of Nvidia InfiniBand hardware. In addition, we would like thank Jamshed Jalal, Eric Van Hensbergen, James Yang, Ashwin Matta, and Anitha Kona from Arm for their support of this project.

## REFERENCES

- [1] D. Bonachea and P. H. Hargrove, “Gasnet-ex: A high-performance, portable communication library for exascale,” in *International Workshop on Languages and Compilers for Parallel Computing*. Springer, 2018, pp. 138–158. Available: <https://bytebucket.org/berkeleylab/upcxx/wiki/pubs/gasnet-ex-lcpc18-6da6911-tech.pdf>
- [2] B. Acun *et al.*, “Parallel programming with migratable objects: Charm++ in practice,” in *SC’14: Proceedings of the International Conference for High Performance Computing, Networking, Storage and Analysis*. IEEE, 2014, pp. 647–658. Available: <http://charm.cs.illinois.edu/newPapers/14-07/paper.pdf>
- [3] P. Braam, “The lustre storage architecture,” *arXiv preprint arXiv:1903.01955*, 2019.

- [4] J. Ahn, S. Hong, S. Yoo, O. Mutlu, and K. Choi, "A scalable processing-in-memory accelerator for parallel graph processing," in *Proceedings of the 42nd Annual International Symposium on Computer Architecture*, ser. ISCA '15. New York, NY, USA: Association for Computing Machinery, 2015, p. 105–117. Available: <https://doi.org/10.1145/2749469.2750386>
- [5] S. Fouladi *et al.*, "From laptop to lambda: Outsourcing everyday jobs to thousands of transient functional containers," in *2019 USENIX Annual Technical Conference (USENIX ATC 19)*. Renton, WA: USENIX Association, Jul. 2019, pp. 475–488. Available: <https://www.usenix.org/conference/atc19/presentation/fouladi>
- [6] T. Von Eicken, D. E. Culler, S. C. Goldstein, and K. E. Schauer, "Active messages: a mechanism for integrated communication and computation," *ACM SIGARCH Computer Architecture News*, vol. 20, no. 2, pp. 256–266, 1992.
- [7] P. Shamis *et al.*, "Ucx: an open source framework for hpc network apis and beyond," in *2015 IEEE 23rd Annual Symposium on High-Performance Interconnects*. IEEE, 2015, pp. 40–43.
- [8] "The unified communication x library." Available: <http://www.openucx.org>
- [9] T. Landsberg, "Analyzing and optimizing tlb-induced thread migration costs on linux/arm," Ph.D. dissertation, Leibniz Universität Hannover, 2018. Available: [https://www.sra.uni-hannover.de/People/landsberg/tlb\\_migration.pdf](https://www.sra.uni-hannover.de/People/landsberg/tlb_migration.pdf)
- [10] J. Schwarzrock, M. G. Jordan, G. Korol, C. C. de Oliveira, A. F. Lorenzon, and A. C. S. Beck, "On the influence of data migration in dynamic thread management of parallel applications," in *2019 IX Brazilian Symposium on Computing Systems Engineering (SBESC)*, 2019, pp. 1–8. Available: <https://ieeexplore.ieee.org/abstract/document/9046096>
- [11] P. S. Sahneh, A. Sarihi, B. Warburton, and A. Patooghy, "Racer: A thread mapping algorithm for race reduction in multi-level shared caches," in *2019 27th Euromicro International Conference on Parallel, Distributed and Network-Based Processing (PDP)*, 2019, pp. 228–232.
- [12] X. Xie, X. Wei, R. Chen, and H. Chen, "Pragh: Locality-preserving graph traversal with split live migration," in *2019 USENIX Annual Technical Conference (USENIX ATC 19)*. Renton, WA: USENIX Association, Jul. 2019, pp. 723–738. Available: <https://www.usenix.org/conference/atc19/presentation/xie>
- [13] J. Klinkenberg, P. Samfass, M. Bader, C. Terboven, and M. S. Müller, "Chameleon: Reactive load balancing for hybrid mpi+openmp task-parallel applications," *Journal of Parallel and Distributed Computing*, vol. 138, pp. 55 – 64, 2020. Available: <http://www.sciencedirect.com/science/article/pii/S0743731519305180>
- [14] M. Marty *et al.*, "Snap: A microkernel approach to host networking," in *Proceedings of the 27th ACM Symposium on Operating Systems Principles*, ser. SOSP '19. New York, NY, USA: Association for Computing Machinery, 2019, p. 399–413. Available: <https://doi.org/10.1145/3341301.3359657>
- [15] A. Agache *et al.*, "Firecracker: Lightweight virtualization for serverless applications," in *17th USENIX Symposium on Networked Systems Design and Implementation (NSDI 20)*. Santa Clara, CA: USENIX Association, Feb. 2020, pp. 419–434. Available: <https://www.usenix.org/conference/nsdi20/presentation/agache>
- [16] A. Dragojević, D. Narayanan, M. Castro, and O. Hodson, "Farm: Fast remote memory," in *11th {USENIX} Symposium on Networked Systems Design and Implementation ({NSDI} 14)*, 2014, pp. 401–414.
- [17] A. Yousafzai, I. Yaqoob, M. Imran, A. Gani, and R. Md Noor, "Process migration-based computational offloading framework for iot-supported mobile edge/cloud computing," *IEEE Internet of Things Journal*, vol. 7, no. 5, pp. 4171–4182, 2020. Available: <https://arxiv.org/pdf/1909.11058.pdf>
- [18] J. L. D. Neto, S. Yu, D. F. Macedo, J. M. S. Nogueira, R. Langar, and S. Secci, "Uloof: A user level online offloading framework for mobile edge computing," *IEEE Transactions on Mobile Computing*, vol. 17, no. 11, pp. 2660–2674, 2018. Available: <https://www-phare.lip6.fr/~secci/papers/NeYuMaNoLaSe-TMC18.pdf>
- [19] M. S. Gordon, D. A. Jamshidi, S. Mahlke, Z. M. Mao, and X. Chen, "COMET: Code offload by migrating execution transparently," in *10th USENIX Symposium on Operating Systems Design and Implementation (OSDI 12)*. Hollywood, CA: USENIX Association, Oct. 2012, pp. 93–106. Available: <https://www.usenix.org/conference/osdi12/technical-sessions/presentation/gordon>
- [20] F. Rommel *et al.*, "From global to local quiescence: Wait-free code patching of multi-threaded processes," in *14th USENIX Symposium on Operating Systems Design and Implementation (OSDI 20)*. USENIX Association, Nov. 2020, pp. 651–666. Available: <https://www.usenix.org/conference/osdi20/presentation/rommel>
- [21] I. Neamtiu, M. Hicks, G. Stoyle, and M. Oriol, "Practical dynamic software updating for c," in *Proceedings of the 27th ACM SIGPLAN Conference on Programming Language Design and Implementation*, ser. PLDI '06. New York, NY, USA: Association for Computing Machinery, 2006, p. 72–83. Available: <https://doi.org/10.1145/1133981.1133991>
- [22] C. M. Hayden, K. Saur, E. K. Smith, M. Hicks, and J. S. Foster, "Kitsune: Efficient, general-purpose dynamic software updating for c," *ACM Trans. Program. Lang. Syst.*, vol. 36, no. 4, Oct. 2014. Available: <https://doi.org/10.1145/2629460>
- [23] R. Pike *et al.*, "Plan 9 from bell labs," *Computing systems*, vol. 8, no. 3, pp. 221–254, 1995. Available: <https://pdos.csail.mit.edu/archive/6.824-2012/papers/plan9.pdf>
- [24] M. N. Nelson and S. R. Radia, "A uniform name service for spring's unix environment," in *USENIX Winter*, 1994, pp. 201–209. Available: [https://www.usenix.org/legacy/publications/library/proceedings/sf94/full\\_papers/nelson.pdf](https://www.usenix.org/legacy/publications/library/proceedings/sf94/full_papers/nelson.pdf)
- [25] C.-C. Tsai *et al.*, "Cooperation and security isolation of library oses for multi-process applications," in *Proceedings of the Ninth European Conference on Computer Systems*, ser. EuroSys '14. New York, NY, USA: Association for Computing Machinery, 2014. Available: <https://doi.org/10.1145/2592798.2592812>
- [26] J. K. Ousterhout *et al.*, "Scheduling techniques for concurrent systems," in *ICDSC*, vol. 82, 1982, pp. 22–30.
- [27] J.-P. Lozi, F. David, G. Thomas, J. Lawall, and G. Muller, "Remote core locking: Migrating critical-section execution to improve the performance of multithreaded applications," in *2012 USENIX Annual Technical Conference (USENIX ATC 12)*. Boston, MA: USENIX Association, Jun. 2012, pp. 65–76. Available: <https://www.usenix.org/conference/atc12/technical-sessions/presentation/lozi>
- [28] Y. Wang, D. Jiang, and J. Xiong, "Numa-aware thread migration for high performance nvmm file systems," in *36th International Conference on Massive Storage Systems and Technology (MSST 2020)*, 2020. Available: <https://storageconference.us/2020/Papers/16.NUMAaware.pdf>
- [29] T. Dysart *et al.*, "Highly scalable near memory processing with migrating threads on the emu system architecture," in *2016 6th Workshop on Irregular Applications: Architecture and Algorithms (IA3)*. IEEE, 2016, pp. 2–9.
- [30] T. Rolinger, C. Krieger, and A. Sussman, "Optimizing data layouts for irregular applications on a migratory thread architecture," in *2019 IEEE/ACM Workshop on Memory Centric High Performance Computing (MCHPC)*, 2019, pp. 7–15.
- [31] C. Boyer, "The 360 revolution." Available: [http://archive.computerhistory.org/resources/text/IBM/ibm\\_%20360\\_revolution\\_story\\_102634496.pdf](http://archive.computerhistory.org/resources/text/IBM/ibm_%20360_revolution_story_102634496.pdf)
- [32] "Infiniband trade association specification." Available: <https://www.infinibandta.org>
- [33] B. Rothenberger, K. Taranov, A. Perrig, and T. Hoefler, "ReDMARK: Bypassing RDMA Security Mechanisms," in *Software for Exascale Computing - SPPEXA 2016-2019*. USENIX, 2021.
- [34] J. Zhu *et al.*, "Enabling rack-scale confidential computing using heterogeneous trusted execution environment," in *2020 IEEE Symposium on Security and Privacy (SP)*, 2020, pp. 1450–1465. Available: <https://heartever.github.io/files/hetee.pdf>
- [35] S. Jeong, J. Hwang, H. Kwon, and D. Shin, "A cfi countermeasure against got overwrite attacks," *IEEE Access*, vol. 8, pp. 36267–36280, 2020.
- [36] P. Wang *et al.*, "Building and maintaining a third-party library supply chain for productive and secure sgx enclave development," in *Proceedings of the ACM/IEEE 42nd International Conference on Software Engineering: Software Engineering in Practice*, ser. ICSE-SEIP '20. New York, NY, USA: Association for Computing Machinery, 2020, p. 100–109. Available: <https://doi.org/10.1145/3377813.3381348>
- [37] J. Choi, Z. Fink, S. White, N. Bhat, D. F. Richards, and L. V. Kale, "Gpu-aware communication with ucx in parallel programming models: Charm++, mpi, and python."
- [38] "Confidential computing consortium." Available: <https://confidentialcomputing.io>