

The complexity of the Bondage problem in planar graphs

V. Bouquet*

July 26, 2021

Abstract

A set $S \subseteq V(G)$ of a graph G is a dominating set if each vertex has a neighbor in S or belongs to S . Let $\gamma(G)$ be the cardinality of a minimum dominating set in G . The bondage number $b(G)$ of a graph G is the smallest number of edges $A \subseteq E(G)$, such that $\gamma(G - A) = \gamma(G) + 1$. The problem of finding $b(G)$ for a graph G is known to be NP-hard even for bipartite graphs. In this paper, we show that deciding if $b(G) = 1$ is NP-hard, while deciding if $b(G) = 2$ is coNP-hard, even when G is restricted to one of the following classes: planar 3-regular graphs, planar claw-free graphs with maximum degree 3, planar bipartite graphs of maximum degree 3 with girth k , for any fixed $k \geq 3$.

Keywords: Bondage number, domination, NP-hard, planar graph, cubic graph.

1 Introduction

Given a graph $G = (V, E)$, a set $S \subseteq V(G)$ is called a dominating set if every vertex $v \in V(G)$ is an element of S or is adjacent to an element of S . When S is a dominating set of G we say that S dominates G . The minimum cardinality of a dominating set in G is called the domination number and is denoted by $\gamma(G)$. A dominating set $S \subseteq V(G)$ with $|S| = \gamma(G)$ is called a minimum dominating set, for short a γ -set. For an overview of the topics in graph domination, we refer to the book of Haynes et al. [9]. The bondage number has been introduced by Fink et al. [5] has a parameter to measure the criticality of a graph, in respect to the domination number. The bondage number $b(G)$ of a graph G is the minimum number of edges whose removal from G increases the domination number, that is, $\gamma(G - E') = \gamma(G) + 1$, where $E' \subseteq E(G)$. We say that an edge e of a graph $G = (V, E)$ is γ -critical if $\gamma(G - e) = \gamma(G) + 1$. Therefore a graph G has a γ -critical edge if and only if $b(G) = 1$. The Bondage problem is defined as follows:

BONDAGE

Instance: a graph $G = (V, E)$ and a positive integer k .

Question: is $b(G) \leq k$?

*Conservatoire National des Arts et Métiers, CEDRIC laboratory, Paris (France). Email: valentin.bouquet@cnam.fr

In a similar fashion the k -Bondage is the problem of deciding if $b(G) = k$, for a graph G and a fixed integer $k \geq 1$. The 1-Bondage problem has been shown to be NP-hard in [11]. Recently, it has been shown in [10] that the 1-Bondage problem remains NP-hard for bipartite graphs. To this date, the bondage number and related properties have been extensively studied. For more details we refer to the survey of Xu in [12].

Our aim in this paper is to determine the computational complexity of the 1-Bondage and 2-Bondage problems for class of subcubic planar graphs and for some of its subclasses.

2 Notations and preliminaries

The graphs considered in this paper are finite and simple, that is, without directed edges or loops or parallel edges. The reader is referred to [1] for definitions and notations in graph theory, and to [8] for definitions and terminology concerning complexity theory.

Let $G = (V, E)$ be a graph with vertex set $V = V(G)$ and edge set $E = E(G)$. Let $v \in V(G)$ and $xy \in E(G)$. We say that x and y are the endpoints of the edge. Let $\delta(G)$ and $\Delta(G)$ denote its minimum degree and its maximum degree, respectively. The degree of v in G is $d_G(v)$ or simply $d(v)$ when the referred graph is obvious. A k -vertex is a vertex of degree k . The graph G is k -regular whenever all its vertices have the same degree, that is, $d(u) = k$ for each $u \in V(G)$. We say that a graph is cubic if it is 3-regular, and it is subcubic if $\Delta(G) \leq 3$. We denote by $N_G(v)$ the open neighborhood of a vertex v in G , and $N_G[v] = N_G(v) \cup \{v\}$ its closed neighborhood in G . When it is clear from context, we note $N(v)$ and $N[v]$. For a subset $U \subseteq V(G)$, let $G[U]$ denote the subgraph of G induced by U , which has vertex set U and edge set $\{uv \in E \mid u, v \in U\}$. We often refer to U as an induced subgraph of G when it is clear from the context. If a graph G has no induced subgraph isomorphic to a fixed graph H , we say that G is H -free. Let H be an induced subgraph of G . We refer to the outside neighbors of H in G as the set of neighbors that does not belong to vertices of H , that is, $\{x \mid x \in N_G(h), x \notin V(H), h \in V(H)\}$. Let $g(G)$ denote the girth of G , that is the minimum length of a cycle. By convention, $g(G) = \infty$ when G is acyclic.

For a vertex $v \in V$, we write $G - v = (V \setminus \{v\}, E \setminus E')$, where $E' = \{uv \mid u \in N(v)\}$, and for a subset $V' \subseteq V$, we write $G - V' = (V \setminus V', E \setminus E')$, where $E' = \{uv \mid v \in V', u \in N(v)\}$. For an edge $e \in E$, we write $G - e = (V, E \setminus \{e\})$, and for a subset $E' \subseteq E$, we write $G - E' = (V, E \setminus E')$. For $n \geq 1$, the graph $P_n = u_1 - u_2 - \dots - u_n$ denotes the cordless path on n vertices, that is, $V(P_n) = \{u_1, \dots, u_n\}$ and $E(P_n) = \{u_i u_{i+1} \mid 1 \leq i \leq n - 1\}$. For a path P_n , we say that P_n is an even path if n is even, else it is an odd path. For $n \geq 3$, the graph C_n denotes the cordless cycle on n vertices, that is, $V(C_n) = \{u_1, \dots, u_n\}$ and $E(C_n) = \{u_i u_{i+1} \mid 1 \leq i \leq n - 1\} \cup \{u_n u_1\}$. For $n \geq 4$, C_n is called a hole. The triangle graph is $C_3 = K_3$. The claw $K_{1,3}$ is the 4-vertex star, that is, the graph with vertices u, v_1, v_2, v_3 and edges uv_1, uv_2, uv_3 . The paw is the graph with four vertices u_1, u_2, u_3, v_1 and edges $u_1 u_2, u_2 u_3, u_1 u_3, u_1 v_1$.

For two vertex disjoint induced subgraphs A, B of G : A is complete to B if ab is an edge for any $a \in V(A)$ and $b \in V(B)$, and A is anti-complete to B if ab is not an edge for any $a \in V(A)$ and $b \in V(B)$. A set $U \subseteq V(G)$ is called a clique if any pairwise distinct vertices $u, v \in U$ are adjacent. When G is a clique then G is a complete graph. A set $U \subseteq V(G)$ is called a stable set or an independent set if any pairwise distinct vertices $u, v \in U$ are non adjacent. A set $U \subseteq V(G)$ is called a vertex cover if every edge e of G has an endpoint in U . We denote by $\tau(G)$ the size of a minimum vertex cover of G and by $\alpha(G)$ the size of a maximum independent set of G . A τ -set of G is a minimum vertex cover of G and an α -set of G is a maximum independent set of G . We denote by α -core(G) and τ -core(G) the set of vertices that belongs to every α -set and every τ -set, respectively. The set of vertices that belongs to no α -set and no τ -set is named α -anticore(G), τ -anticore(G), respectively. We say that a graph G has X -cores or X -anticores when X -core(G) $\neq \emptyset$ or X -anticore(G) $\neq \emptyset$, where $X \in \{\alpha, \gamma, \tau\}$. Note that given an α -set S of G , the set of vertices $V \setminus S$ is a τ -set of G , and vice-versa. Hence α -core(G) = τ -anticore(G) and α -anticore(G) = τ -core(G).

3 Cores and anticores

Before giving hardness results for the Bondage problem in planar graphs, we need to introduce several intermediate problems. We show that these problems belong to the class of NP-hard problems.

Boros et al. studied α -cores in [2]. They claimed that deciding if a given graph G is such that $|\alpha$ -core(G) $> k$ is NP-complete. To this end, they use Cook Reducibility from the Minimum Independent Set Problem. It states that $\alpha(G)$ could be computed using only an oracle for the question $|\alpha$ -core(G) $> k$. Yet we found some flaws in this proof. Unless $P=NP$, we can say that there does not exist a polynomial algorithm to decide if a graph G is such that $|\alpha$ -core(G) $> k$. But to show that a problem is NP-hard, one must give a polynomial reduction (Karp reduction) from an NP-hard problem. Moreover, unless $P=NP$, this problem is clearly not in NP since it seems impossible to verify in polynomial time that a set of vertices of size k belongs to α -cores. Hence we decided to propose a polynomial reduction to the two following problem:

α -CORE
Instance: a graph $G = (V, E)$.
Question: is there a vertex $v \in V(G)$ such that v belongs to every maximum independent set of G ?

α -ANTICORE
Instance: a graph $G = (V, E)$.
Question: is there a vertex $v \in V(G)$ such that v belongs to no minimum vertex cover of G ?

Similarly, to the α -core problem corresponds the τ -anticore problem, and to the α -anticore problem corresponds the τ -core problem. We prove that the problems α -core and α -anticore are both NP-hard using a reduction from 3-SAT with exactly three variables per clause. Cook in [3] has shown that 3-SAT is NP-complete.

Theorem 3.1 *The α -core problem and the α -anticore problem are NP-hard.*

Proof: Let Φ be an instance of 3-SAT with variable n variables and m clauses with exactly three variables per clause. Let U be the set of variables and C be the set of clauses. From this instance we construct a graph $G = (V, E)$ such that Φ is satisfiable if and only if $\alpha\text{-anticore}(G) \neq \emptyset$ and $\alpha\text{-core}(G) \neq \emptyset$.

Each clause $c = \{x, y, z\}$ of C is associated with a triangle $T = \{x, y, z\}$, where each of the three vertices represent one literal of c . Then we make a copy $T' = \{x', y', z'\}$ such that T is complete to T' , and remove the edges xx', yy' and zz' . Hence we have a partition of the triangles into (A, B) such that $|A| = |B| = m$ and each clause is represented exactly once by a triangle in each set.

Let u, \bar{u} be a pair of opposite literals in two distinct clauses of C , with x, \bar{x} be its pair of corresponding vertices in G , that is, x corresponds to u and \bar{x} correspond to \bar{u} , such that x belongs to a triangle of A and \bar{x} belongs to a triangle of B . Then we add an edge $x\bar{x}$. We repeat this operation for every pair of opposite literals.

We create two independent sets I_A and I_B of order m , and so that I_A is complete to I_B . Then we add edges to make I_A, I_B complete to the triangles of A, B , respectively. Last we add the vertices a, b, c that form the path $P_3 = a - c - b$, and such that I_A, I_B are complete to a, b , respectively. At this point, our graph G is fully constructed.

From our construction, we highlight the following two ways to construct an independent set of order $2m + 1$:

- Select a vertex in each triangle T of A then pick all vertices of I_B and either a or c ;
- Select a vertex in each triangle T' of B then pick all vertices of I_A and either b or c .

Note that from the given constructions, if $\alpha(G) = 2m + 1$ then $\alpha\text{-core}(G) = \emptyset$ and $\alpha\text{-anticore}(G) = \emptyset$.

We claim that $\alpha(G) \leq 2m + 2$. From our construction, there is no independent set of G that contains vertices of I_A and I_B ; nor A and I_A ; and neither B and I_B . Moreover, if S is an independent set that contains some vertices of either I_A or I_B then $|P_3 \cap S| \leq 1$. Hence any independent set of G that contains some vertices of either I_A or I_B is at most of order $2m + 1$. So if there is an independent set of order $2m + 2$, it is composed of one vertex of each triangle of A , one vertex of each triangle of B , and the vertices a and b . Hence if $\alpha(G) = 2m + 2$ then $\{a, b\} \subseteq \alpha\text{-core}(G)$ and $\{c\} \cup I_A \cup I_B \subseteq \alpha\text{-anticore}(G)$.

It remains to prove that $\alpha(G) = 2m + 2$ if and only if C is satisfiable. We construct an α -set S of order $2m + 2$ from a satisfying assignment D of Φ . For each clause c , select one literal u in D that satisfies c . Then pick the vertices x and x' that correspond to the literal u , and where x belongs to a triangle of A and x' belongs to a triangle of B . Note that no vertices corresponding to the opposite literal are

taken. Hence from our construction S is an independent set of G . Then $S \cup \{a, b\}$ is an α -set of G of order $2m + 2$.

Conversely, we construct an assignment D of Φ , from a α -set S of order $2m + 2$. From previous arguments, S is composed of one vertex of A , one vertex of each triangle of B , and the vertices a, b . Let x, x' be a pair of vertices such that $x \in T \cap S$ and $x' \in T' \cap S$, where T is a triangle of A and T' is a triangle of B . If x, x' correspond to the same variable u , then they do not correspond to opposite literals. Hence we can construct a satisfying assignment D as follows: for each vertex $x \in T \cap S$, where $T \in A$, add the associated literal of x to D . At this point, D satisfies Φ . This completes the proof. \square

Since for a graph G , we have $\alpha\text{-core}(G) = \tau\text{-anticore}(G)$ and $\alpha\text{-anticore}(G) = \tau\text{-core}(G)$, it follows:

Corollary 3.2 *The problems τ -core and τ -anticore are both NP-hard.*

We describe one operation that will be of use in next theorem's proof. Given a graph $G = (V, E)$ and $v \in V(G)$, we define the graph $G_v + u = (V', E')$, where $u \notin V(G)$ as follows: $V' = V \cup \{u\}$ and $E' = E \cup \{uv\}$.

Property 3.3 *Let v be a vertex of a graph $G = (V, E)$, then $v \in \tau\text{-anticore}(G)$ iff $\tau(G_v + u) = \tau(G) + 1$.*

Proof: Let v be a vertex of a graph G . Any τ -set of $G_v + u$ contains either u or v to cover the edge uv . Therefore if $v \in \tau\text{-anticore}(G)$ then $\tau(G_v + u) = \tau(G) + 1$. Else there exists a τ -set S of G containing v that is also a τ -set of $G_v + u$. \square

We show that the τ -anticore problem remains NP-hard for planar graphs.

Theorem 3.4 *The τ -anticore problem is NP-hard when restricted to planar graphs.*

Proof: Garey, Johnson and Stockmeyer in [7] proved that Vertex Cover (referenced as Node Cover) is NP-complete when restricted to planar graphs. To that end, they gave a polynomial reduction from the Vertex Cover with no restrictions on the graph. We claim that the graph $G' = (V', E')$ constructed from $G = (V, E)$ has the following property: $\tau\text{-anticore}(G') \neq \emptyset$ if and only if $\tau\text{-anticore}(G) \neq \emptyset$. First we give an overview of their proof.

Given a graph $G = (V, E)$, we construct a graph $G' = (V', E')$. Embed G in the plane, allowing edges to cross but so that no more than two edges meet at any point, and no edge cross a vertex other than its own endpoint. Then replace each crossing by a copy of H as shown in Figure 1 to build G' . For each i, j , where $0 \leq i, j \leq 2$, let $c[i, j]$ be the cardinality of a minimal vertex cover C of H such that $|\{v_1, v'_1\} \cap C| = i$ and $|\{v_2, v'_2\} \cap C| = j$. Note that v_1, v'_1, v_2, v'_2 are the four corners of H , see Figure 2. The following properties hold:

j \ i	0	1	2
0	13	14	15
1	13	13	14
2	14	14	15

Table 1: The values of $c[i, j]$.

Hence $\tau(H) = 13$ and for every vertex cover S of G' , $|S \cap H| \geq 13$. From a τ -set S of G , you can build a τ -set S' of G' by taking all corresponding vertices of S in G' and exactly 13 vertices for each copy of H . So if $\tau(G) = k$ then $\tau(G') = k + 13d$, where d is the number of copy of H (i.e. the number of crossings). This completes the overview of the proof of Garey et al.

We show that if $\tau\text{-anticore}(G) \neq \emptyset$ then $\tau\text{-anticore}(G') \neq \emptyset$. Let v be a vertex in $\tau\text{-anticore}(G)$. From Property 3.3 we know that $\tau(G) = \tau(G_v + u) + 1$. Since $G'_v + u$ can be constructed from $G_v + u$, we have $\tau(G'_v + u) = \tau(G_v + u) + 13$ and therefore $v \in \tau\text{-anticore}(G')$. Hence if a vertex v belongs to $\tau\text{-anticore}(G)$, then v also belongs to $\tau\text{-anticore}(G')$.

Conversely, we show that if $\tau\text{-anticore}(G) = \emptyset$ then $\tau\text{-anticore}(G') = \emptyset$. Suppose that $\tau\text{-anticore}(G) = \emptyset$. Let ab, cd be two edges of G that are crossing. We construct the graph G_H , a copy of G with the crossing point replaced by the graph H as described above. W.l.o.g. we can assume that there exists two minimum vertex cover S_1, S_2 of G such that $a, c \in S_1$ and $b, d \in S_2$. Let S'_2 be the set of black vertices represented in Figure 2. Note that $|S'_2| = 13$ and that S'_2 is a minimum vertex cover of H . Also S'_2 is covering the edges av_1 and cv_2 while S_2 is covering the edges bv'_1 and dv'_2 . Hence $S_2 \cup S'_2$ is a vertex cover of G_H and since $\tau(G_H) = \tau(G) + 13$, it is minimum. Now consider the 180 degree rotational symmetry of Figure 2. Let S'_1 be the set of black vertices of this symmetry. Note that S'_1 is covering the edges bv'_1 and dv'_2 while S_1 is covering the edges av_1 and cv_2 . Hence $S_1 \cup S'_1$ is a vertex cover of G_H and since $\tau(G_H) = \tau(G) + 13$, it is minimum. From these two τ -sets of G_H , we have $\tau\text{-anticore}(G_H) = \emptyset$.

By iterating until there is no more edge crossing, we obtain G' such that $\tau\text{-anticore}(G') = \emptyset$. From previous arguments, it follows that if a vertex v of G belongs to some minimum vertex cover of G , then v belongs to some minimum vertex of G' . This completes the proof. \square

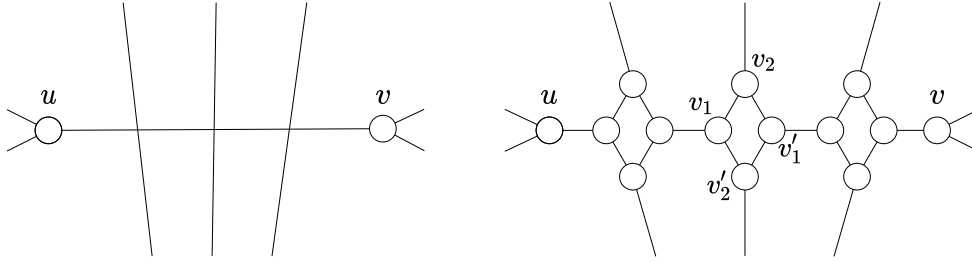

Figure 1: Removal of crossing edges of G to construct G' where each C_4 represent a copy of the graph H of Figure 2.

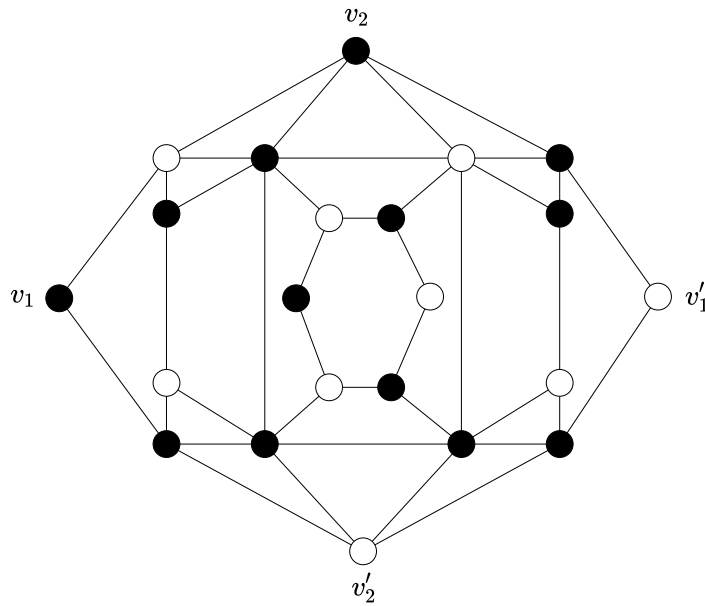

Figure 2: The planar graph H with a minimum vertex cover represented by the black vertices.

Since for a graph G , τ -anticore(G) = α -core(G), it follows:

Corollary 3.5 *The α -core problem is NP-hard for planar graphs.*

4 Bondage in planar graphs

In this section, we show that the 1-Bondage and the 2-Bondage problem are NP-hard and coNP-hard, respectively, in planar graphs with maximum degree 3. The two following remarks will be extensively used in the proofs below.

Remark 4.1 *Let uv be an edge of a graph $G = (V, E)$. If there exists a minimum dominating set S of G such that $u, v \notin S$ or $u, v \in S$, then uv is not a γ -critical edge.*

Remark 4.2 *Let v be a vertex of a graph $G = (V, E)$. If there exists a minimum dominating set S of G such that $v \notin S$ and $|S \cap N(v)| \geq 2$, then every edge incident with v is not γ -critical.*

Using Theorem 3.4, we show the NP-hardness of the 1-bondage problem in planar graphs.

Theorem 4.3 *The 1-Bondage problem is NP-hard when restricted to planar graphs of maximum degree 3.*

Proof: We give a polynomial reduction from the τ -anticore problem which has been shown to be NP-hard for planar graphs in Theorem 3.4. From a connected planar graph $G = (V, E)$, we build a connected planar graph $G' = (V', E')$ with maximum degree 3. Let $n = |V(G)|$ and $m = |E(G)|$.

For each vertex v of G we associate the connected component G_v . The component G_v is composed as follows:

- An induced cycle C_v of length $3l + 3$, where $l = d_G(v)$, that is,
 $C_v = v_0 - \bar{v}_0 - v'_0 - v_1 - \bar{v}_1 - v'_1 - \dots - v_l - \bar{v}_l - v'_l - v_0$;
- An induced path $P_v = a - b - c - d$ that is connected to C_v by the edge av_0 ;
- To each pair v_i, v'_i of C_v , where $i = 1, \dots, d_G(v) - 1$, is associated an induced paw $P^i = \{a_i, b_i, c_i, d_i\}$ where $\{b_i, c_i, d_i\}$ is a triangle, $a_i b_i$ is an edge, and P^i is connected to C_v by the edges $a_i v_i$ and $a_i v'_i$.

For each edge uv of G , we pick a copy of the graph H_{uv} depicted in Figure 3. Note that each component G_v and H_{uv} is planar with degree maximum 3. Moreover each \bar{v}_i of G_v , where $i = 1, \dots, d_G(v)$, has degree 2. We show how the components connect to each other so that the graph is planar. Consider a planar representation of G . Each component G_v is assigned the same position on the plane as its associated vertex v of G . We do similarly with each component H_{uv} and its associated edge uv of G so that no components overlap. Embed each induced cycle C_v in the plane as a circle so that the path P_v and the paws P^i , where $i = 1, \dots, d_G(v) - 1$, are inside. Then, for each vertex v of G , iterate counterclockwise on the edges incident to v from $i = 1$ to $i = d_G(v)$. At each step, let uv be the considered edge incident to v , add the edge $\bar{v}_i h_v$ where h_v belongs to the component H_{uv} . Hence G' is planar with $\Delta(G') \leq 3$. This completes the construction.

In the first part we will prove that $\gamma(G') = 8m + n + \tau(G)$. In the last part we will prove that $b(G') = 1$ if and only if $\tau\text{-anticore}(G) = \emptyset$.

Let H_{uv} be the associated component of an edge uv of G , and \bar{u}, \bar{v} be the only outside neighbors of H_{uv} in G' . Recall that $\bar{u} \in G_u$, $\bar{v} \in G_v$ and that $h_u \bar{u}$ and $h_v \bar{v}$ are two edges. Let S be a minimum dominating set of G' . One can check the following:

- If $\bar{u}, \bar{v} \notin S$ then $|S \cap H_{uv}| = 5$;

- If $\bar{u} \in S$ and $\bar{v} \notin S$ then $|S \cap H_{uv}| = 4$. The case $\bar{u} \notin S$ and $\bar{v} \in S$ is symmetric;
- Else $|S \cap H_{uv}| = 4$.

From now, we say that H_{uv} is covered if $|S \cap H_{uv}| = 4$.

Let G_v be the associated component of a vertex v of G . We claim that any dominating set S' of G' is such that $|S' \cap G_v| \geq 2d_G(v) + 1$. Let $l = d_G(v)$. Let S be a dominating set of $G' \setminus G_v$. Since we intend to prove a lower bound, we assume that all outside neighbors of G_v in G' are in S , that is, $N(G_v) \setminus G_v \subset S$. From S we construct S' , a dominating set of G' . Let $S = S'$. Note that the set of vertices $\{\bar{v}_i \mid i = 1, \dots, l\}$ of G_v is dominated by S' . Since $v_0 - a - b - c - d$ is an induced path in G' where v_0 is the only vertex with neighbors outside P_v , we add $\{c, v_0\}$ to S' . With similar arguments, for each paw $P^i = \{a_i, b_i, c_i, d_i\}$, where $i = 1, \dots, l - 1$, we add b_i to S' . At this step $|S' \cap G_v| = l + 1$, and it remains to dominate $I = \{v'_{i-1}, v_i \mid i = 1, \dots, l\}$. Note that I is the disjoint unions of l induced paths of size 2. Let $U \in V(G)$ such that $S \cup U$ is dominating G' . From our construction, one can check the following: $|U| \geq l$, and if $|U| = l$ then $|U \cap I| = l$.

Let S be a dominating set of G' . We denote by S_v, S_{uv} the set of vertices of $S \cap G_v, S \cap H_{uv}$, respectively. We would like to point out the following:

- If $|S_v| = 2d_G(v) + 1$ then from above, we have $S_v \cap \{\bar{v}_i \mid i = 0, \dots, d_G(v)\} = \emptyset$. In this case we say that S_v is a *non-dominating configuration* of G_v . An example of such a configuration is $S_v = \{c, v_0, v_l\} \cup \{b_i, v_i \mid i = 1, \dots, l - 1\}$, where $l = d_G(v)$.
- If $\{\bar{v}_i \mid i = 1, \dots, d_G(v)\} \subset S_v$ and $|S_v| = 2d_G(v) + 2$, then we say that S_v is a *dominating configuration* of G_v . In this case G_v covers each component H_{uv} , where $uv \in E(G)$. An example of a dominating configuration is $S_v = \{c, v_0, v'_0, \bar{v}_l\} \cup \{b_i, \bar{v}_i \mid i = 1, \dots, l - 1\}$, where $l = d_G(v)$.
- We say that S_{uv} is a *covered configuration* if G_v or G_u is covering H_{uv} and $|S_{uv}| = 4$. Examples of covered configurations where G_u or G_v cover H_{uv} are displayed in Figure 4a, 4c and 4b.

Let S be a dominating set of G' . We define as S_G the set of G_v that correspond to a dominating configuration in S , and S_H the set of H_{uv} that are not covered in S . From previous arguments, we have the following lower bound:

$$\begin{aligned}
|S| &\geq 4m + \sum_{v \in V(G)} (2d_G(v) + 1) + |S_G| + |S_H| \\
&\geq 8m + n + |S_G| + |S_H|
\end{aligned} \tag{4.1}$$

Let $k = \tau(G)$ and S be a minimum vertex cover of G . Let S' be a dominating set of G' . If S' can be obtained from S as described below, we say that S' is the dominating set associated to S . To each vertex $v \in S$ corresponds a dominating configuration of G_v . To each vertex $v \notin S$ corresponds a non-dominating configuration of G_v . At this point, for each edge $uv \in E(G)$, the associated H_{uv} is covered by

S' . Therefore we associate a covered configuration of each H_{uv} , depending on which of G_u or G_v is covering H_{uv} . Hence S' dominates G' with $|S'_G| = k$ and $|S'_H| = 0$. So we have $|S'| = 8m + n + k$.

Let $p = 8m + n + k$. We show that $\gamma(G') \geq p$. By contradiction, suppose there exists a dominating set D of G' such that $|D| < p$. From 4.1 we have $|D_G| + |D_H| < k$. From D we construct a vertex cover C of G . For each component G_v of D_G , we add its vertex v to C . Now it remains to cover the edges associated with the components of D_H . For each component H_{uv} of D_H , let uv be its associated edge in G : we add one of its endpoints, say u , to C . Thus C is a vertex cover of G such that $|C| < k$, a contradiction.

In the last part, we show that if $\tau\text{-anticore}(G) = \emptyset$ then G' has no γ -critical edge.

First, we show that no edge with an endpoint in a component H_{uv} is γ -critical in G' . Let S be a minimum vertex cover of G and S' be an associated dominating set in G' . If $u, v \in S$ then consider the vertices of $S' \cap H_{uv}$ highlighted in Figure 4b. From Remark 4.1 and 4.2, no bold edge is γ -critical. From this symmetric covered configuration, no edge with an endpoint in H_{uv} is γ -critical in G' . Second, w.l.o.g. $u \in S$ and $v \notin S$. Then G_u covers H_{uv} and therefore we consider the highlighted vertices of $S \cap H_{uv}$ of Figure 4a. From Remark 4.1 and 4.2, no bold edge is γ -critical. The case $u \notin S$ and $v \in S$ is symmetric. Hence no edge with an endpoint in H_{uv} is γ -critical in G' .

Now we show that no edge of a component G_v is γ -critical in G' . Let $l = d_G(v)$. First suppose that $v \notin \tau\text{-core}(G)$. Since $\tau\text{-anticore}(G) = \emptyset$, there exists A and B , two τ -sets of G , such that $v \notin A$ and $v \in B$. Let A', B' be two associated dominating sets of A, B , respectively. Since each H_{uv} is covered by G_u in A' , we can assume that $A' \cap H_{uv}$ is as depicted in Figure 4c. Note that A'_v corresponds to a non-dominating configuration while B'_v corresponds to a dominating configuration of G_v . We give a non-dominating configuration for A'_v and a dominating configuration for B'_v :

1. $A'_v = Z \cup \{c, v_0\} \cup \{w_i \mid w_i \in \{b_i, c_i, d_i\}, i = 1, \dots, l-1\}$ where $Z = \{v_i \mid i = 1, \dots, l\}$ or $Z = \{v'_i \mid i = 0, \dots, l-1\}$;
2. $B'_v = W \cup \{\bar{v}_l\} \cup \{b_i, \bar{v}_i \mid i = 1, \dots, l-1\}$ where $W = \{c, v_0, v'_0\}$ or $W = \{d, b, \bar{v}_0\}$ or $W = \{c, v_0, \bar{v}_0\}$.

Hence we can take any previous configurations of A'_v, B'_v in A', B' , respectively, such that A' and B' are still γ -sets of G' . Then from Remark 4.1 and 4.2, one can check that no edge of G_v is γ -critical in G' .

Now $v \in \tau\text{-core}(G)$. Since $\tau\text{-anticore}(G) = \emptyset$, we can assume that for each edge uv of G , there exists S a minimum vertex cover of G such that $u, v \in S$. Let S' be an associated dominating set in G' . Note that S_u, S_v correspond to a dominating configuration of G_u, G_v , respectively, and therefore H_{uv} is covered by both G_u and G_v . Hence we replace the vertices of $S' \cap H_{uv}$ by the dominating black vertices of H_{uv} depicted in Figure 4c. Thus the vertex h_v dominates the vertex \bar{v}_j of G_v , where $j \in \{1, \dots, l\}$. We exposed some dominating sets of G_v to replace S'_v in S . Item 3.

represents some dominating configuration of G_v , while item 4., 5. are configurations that cover every component $H_{u'v}$, where $u' \neq u$.

3. $S'_v = W \cup \{\bar{v}_l\} \cup \{b_i, \bar{v}_i \mid i = 1, \dots, l-1\}$ where $W = \{c, v_0, v'_0\}$ or $W = \{d, b, \bar{v}_0\}$ or $W = \{c, v_0, \bar{v}_0\}$;
4. $S'_v = \{a_j, w_j\} \cup \{c, v_0, v'_0\} \cup \{b_i, \bar{v}_i \mid i = 1, \dots, l-1, i \neq j\}$, if $j \neq l$, where $w_j \in \{b_j, c_j, d_j\}$;
5. $S'_v = \{v_j\} \cup \{c, v_0, v'_0\} \cup \{b_i, \bar{v}_i \mid i = 1, \dots, l-1, i \neq j\}$, if $j = l$.

Hence we can take any exposed configurations of S'_v in S' such that S' is still a γ -set of G' . Then from Remark 4.1 and 4.2, one can check the following: from 3. no edge incident to a vertex $\{a, b, c, d, v_0, \bar{v}_0, v'_0\}$ is γ -critical in G' ; from 4. no edge incident to $\{a_j, b_j, c_j, d_j, v_j, \bar{v}_j, v'_j\}$ is γ -critical in G' ; from 5. no edge incident to $\{v_j, \bar{v}_j, v'_j\}$ is γ -critical in G' . These configurations can be applied to any $j \in \{1, \dots, l\}$ and therefore G_v has no γ -critical edge in G' .

Last we claim that if $\tau\text{-anticore}(G) \neq \emptyset$ then G' has a γ -critical edge. Let $v \in \tau\text{-anticore}(G)$. We show that there is no γ -set of G' such that G_v has a dominating configuration. By contradiction, let S' be a γ -set of G' such that S'_v is a dominating configuration of G_v . From S' we construct a minimum vertex cover S of G . For each component G_u of S'_G , the vertex u is in G to S . For each component H_{xy} of S'_H , one of its endpoints, say x , is in S . From previous arguments, we have $|S'_G \cup S'_H| = \tau(G)$ and thus $|S| = \tau(G)$. Yet S is a minimum vertex cover of G where $v \in S$ a contradiction. Hence there is no γ -set of G' where G_v has a dominating configuration. Let S' be a γ -set of G' . From previous arguments we have only two possible configurations of G_v in S'_v , that are:

1. $S'_v = \{c, v_0, v_l\} \cup \{v_i, w_i \mid w_i \in \{b_i, c_i, d_i\}, i = 1, \dots, d_G(v) - 1\}$;
2. $S'_v = \{c, v_0, v'_0\} \cup \{v'_i, w_i \mid w_i \in \{b_i, c_i, d_i\}, i = 1, \dots, d_G(v) - 1\}$.

Then in every γ -set of G' , the vertex d is dominated by c . Hence the edge cd is γ -critical in G' . So we can conclude that $b(G') = 1$ if and only if $\tau\text{-anticore}(G) \neq \emptyset$. This completes the proof. \square

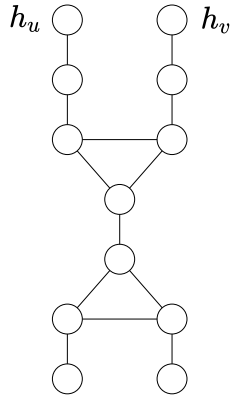

Figure 3: The component H_{uv} associated with an edge uv of G .

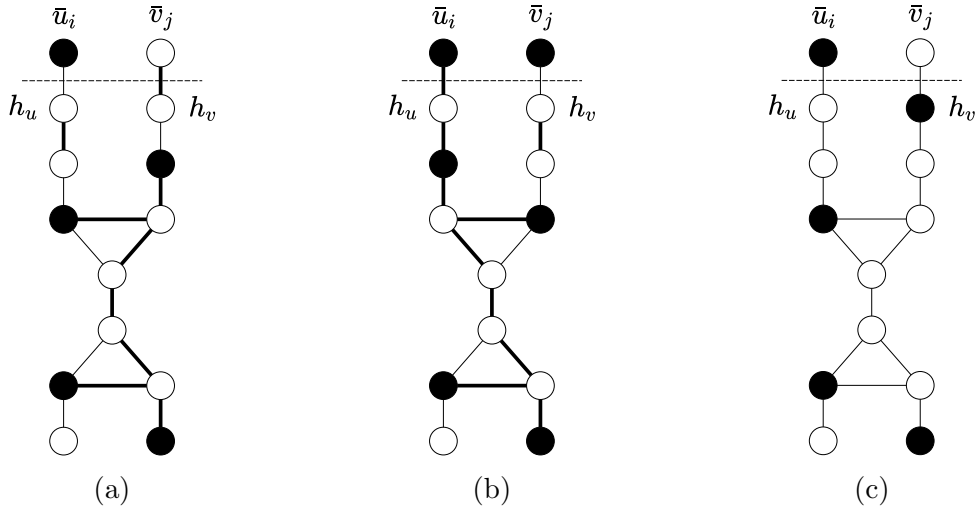

Figure 4: (a) A covered configuration of H_{uv} when G_u is covering; (b) a covered configuration of H_{uv} when G_u and G_v are covering; (c) a covered configuration of H_{uv} when G_u is covering and such that h_v dominates \bar{v}_j .

Corollary 4.4 *The 2-Bondage problem is coNP-hard when restricted to planar graphs of maximum degree 3.*

Proof: In the preceding proof, the graph G' has no γ -set S such that $\{c, d\} \subset S$. Since c, d are isolated in $G' \setminus \{bc, cd\}$, we have $\gamma(G') < \gamma(G' \setminus \{bc, cd\})$ and therefore $b(G') \leq 2$. Thus deciding if G' has not a bondage number two is equivalent to deciding if it has a bondage number one. \square

5 Bondage in restricted planar graphs

Extending the arguments of the proof of Theorem 4.3, we obtain the following.

Theorem 5.1 *The 1-Bondage problem is NP-hard when restricted to planar claw-free graphs of maximum degree 3.*

Proof: The graph G' constructed in the proof of Theorem 4.3 contains the following claws: $G'[a, v_0, v_k, \bar{v}_0]$, $G'[a_i, b_i, v_i, v'_i]$, $G'[h_v, v_i, \bar{v}_i, v'_i]$, $G'[h_v, v_k, \bar{v}_k, v'_k]$ for every vertex v of G , where $k = d_G(v)$ and $i = 1, \dots, k-1$.

We describe the operation O_c . Let v be a vertex at the center of a claw in G' . We replace v by a component H_v as depicted in the right of Figure 5. Let H be the graph obtained from this operation. Note that H is planar and $\Delta(H) \leq 3$. The component H_v satisfies the following properties. We have $\gamma(H_v) = 3$ and $\{a, b, c\}$ is a γ -set. The graphs $H_v - a$, $H_v - b$, $H_v - c$ have a unique γ -set of size three, that are, $\{v_3, v_6\}$, $\{v_2, v_5\}$, $\{v_1, v_4\}$, respectively. With one vertex it is not possible to dominate $H_v - \{a, b, c\}$.

First we show that $\gamma(H) = \gamma(G') + 2$. Let S be a minimum dominating set of G' . From S we construct a dominating set S' of H . Let $S = S'$. Suppose that $v \notin S$. If $u_1 \in S$ then add v_3, v_6 to S' so that S' dominates H . The case $u_2 \in S$ and $u_3 \in S$ are symmetric. Now $v \in S$. Then remove v from S' and add the vertices a, b, c . Clearly S' is dominating set of H . So $\gamma(H) \leq \gamma(G') + 2$.

Conversely, let S' be a minimum dominating set of H . Suppose that $|S'| < \gamma(G') + 2$. From previous arguments $|S' \cap H_v| \geq 2$. If $|S' \cap H_v| = 2$, then $a, b, c \notin S'$ and therefore $S' \cap V(G')$ is a γ -set of G' , a contradiction. Else $|S' \cap H_v| \geq 3$ and then $\{v\} \cup S' \cap V(G')$ is a γ -set of G' another contradiction. Hence $\gamma(H) = \gamma(G) + 2$.

Let S and S' be two minimum dominating sets of G' . We show that no edge incident with a vertex of H_v in H is γ -critical, when S and S' are as describe below.

1. $u_i, v \in S$ and $u_i \in S'$, $v \notin S'$, where $i \in \{1, 2, 3\}$. Suppose that $u_1 = u_i$. From S, S' we build \bar{S}, \bar{S}' , respectively, as follows. Let $S = \bar{S}$ and $S' = \bar{S}'$. We replace v in \bar{S} by the set of vertices $\{w, b, c\}$, where $w \in \{a, v_1, v_2\}$, and we add v_3, v_6 to \bar{S}' . From previous arguments we can see that \bar{S} and \bar{S}' are two γ -set of H . From Remark 4.1 and 4.2, no edge with an endpoint in H_v is γ -critical. The cases $u_2 = u_i$ and $u_3 = u_i$ are symmetric.
2. $u_i, u_j \in S$, $u_i, u_l \in S'$, and $v \notin S \cup S'$, where $i, j, l \in \{1, 2, 3\}$, $i \neq j \neq l$. Suppose that $u_i = u_1$, $u_j = u_2$ and $u_l = u_3$. From S, S' we build \bar{S}, \bar{S}' , respectively, as follows. Let $S = \bar{S}$ and $S' = \bar{S}'$. We add $\{v_2, v_5\}$ or $\{v_3, v_6\}$ to \bar{S} and the vertices v_1, v_4 to \bar{S}' . From previous arguments, \bar{S} and \bar{S}' are two γ -sets of H . From Remark 4.1 and 4.2, no edge with an endpoint in H_v is γ -critical. The remaining cases are symmetric.

We show that $b(G') = b(H)$. Suppose that $b(G') = 1$. We know that cd is γ -critical in G' . Hence $\gamma(G' - cd) = \gamma(H - cd) + 2$, and therefore cd is γ -critical in H . Now $b(G') = 2$. By contradiction, suppose that $b(H) = 1$. Let xy be a γ -critical edge in H . We refer to the seven enumerated minimum dominating sets of G' at the end of the preceding proof. From these γ -sets, one can check that each center of a claw admits one of the two exposed configurations. Hence no edge incident to an induced H_v of H is γ -critical and therefore $xy \in E(G')$. Yet $\gamma(H - xy) = \gamma(G' - xy) + 2$, a contradiction. So $b(H) \geq 2$. We know that $\gamma(G') < \gamma(G' \setminus \{bc, cd\})$. Thus $\gamma(H \setminus \{bc, cd\}) = \gamma(G' \setminus \{bc, cd\})$, and therefore $b(G') = b(G)$.

By applying the operation O_c iteratively until there is no more claw, we obtain a claw-free graph H' such that $b(G') = b(H')$. \square

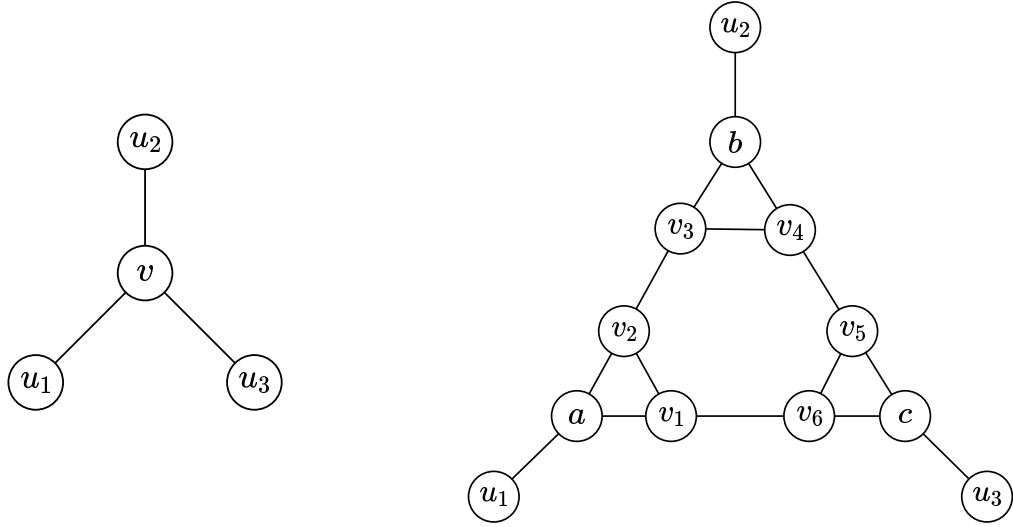

Figure 5: On the left, an induced claw in G' , on the right, the corresponding component H_v .

Using the arguments of the proof of Corollary 4.4, it follows:

Corollary 5.2 *The 2-Bondage problem is coNP-hard when restricted to planar claw-free graphs of maximum degree 3.*

Theorem 5.3 *The 1-Bondage problem is NP-hard when restricted to 3-regular planar graphs.*

Proof: We give a polynomial reduction from the 1-Bondage problem which was shown in Theorem 4.3 to be NP-hard when restricted to subcubic planar graphs with bondage number at most 2. Let $G = (V, E)$ be a planar graph of maximum degree 3 such that $b(G) \leq 2$. From G we construct a 3-regular planar graph $G' = (V', E')$. Let H_1 and H_2 be the graph depicted in Figure 6a and 6b. One can check that the following statements are true:

- $\gamma(H_1) = \gamma(H_2) = 2$;
- $b(H_1 \setminus \{u_1, u_2\}) = b(H_2) = 2$;
- $u_1, u_2 \in \gamma\text{-anticore}(H_1)$ and $u \in \gamma\text{-anticore}(H_2)$;
- $\gamma(H_1 \setminus \{u_1, u_2\}) = \gamma(H_2 - u) = 2$.

We describe the operation O_1 to increase the degree of a 1-vertex to three. Let v be a vertex of degree 1 in G . Take a copy of H_1 and connect v to v_1 and v_2 . In the obtained graph H , we have $d_H(v) = 3$ and each vertex of H_1 in H is of degree three.

We describe the operation O_2 to increase the degree of a 2-vertex to three. Let v be a vertex of degree 2 in G . Take a copy of H_2 and connect v to u_1 and u_2 . In the obtained graph H , we have $d_H(v) = 3$ and exactly two vertices of H_2 in H are 1-vertices while the other are 3-vertices.

Let H be a graph obtained from O_1 or O_2 . Let H_i be the added induced subgraph, $i \in \{1, 2\}$. We show that $\gamma(H) = \gamma(G) + 2$. Since $\gamma(H_i) = 2$, we have $\gamma(H) \leq \gamma(G) + 2$. Let S be a minimum dominating set of H . Suppose that $|S| < \gamma(G) + 2$. From previous statements, we have $|S \cap H_i| \geq 2$ and therefore $S \setminus H_i$ is not dominating G . If $|S \cap H_i| = 2$ then $S \setminus H_i$ is a γ -set of G , a contradiction. Else $|S \cap H_i| \geq 3$ and $\{v\} \cup S \setminus H_i$ is a γ -set of G , a contradiction. So $\gamma(H) = \gamma(G) + 2$.

We show that $b(H) = b(G)$. Let $A \subset E(G)$ such that $\gamma(G - A) = \gamma(G) + 1$. Since $\gamma(H - A) = \gamma(G - A) + 2$, we have $b(H) \leq b(G) \leq 2$. Suppose $b(H) = 1$. Let uv be a γ -critical edge of H . Assume to the contrary that $b(G) = 2$. Let $H_i = H_1$. There exists S a γ -set of G where $v \in S$ or the edge incident with v in G is γ -critical. With previous statements, one can check that no edge incident with H_1 is γ -critical in H . Yet $\gamma(H - uv) = \gamma(G - uv) + 2$, a contradiction. Now let $H_i = H_2$. Let S, S' be two γ -sets of G, H_2 , respectively. Since $S \cup S'$ is a γ -set of H and that $b(H_2) = 2$, then uv has no endpoint in H_2 . Hence $\gamma(H - uv) = \gamma(G - uv) + 2$, a contradiction.

Applying O_1 or O_2 until there exists a vertex of degree one or two, we obtain a planar 3-regular graph G' such that $b(G') = b(G)$. \square

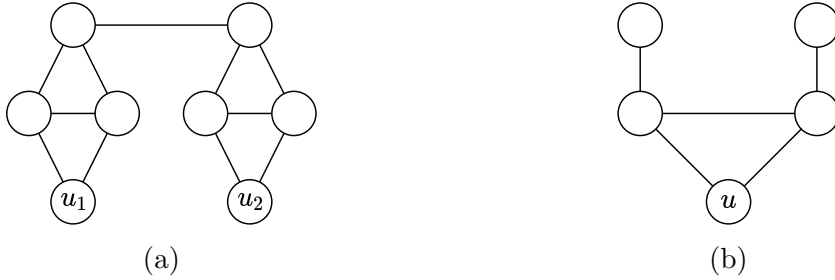

Figure 6: (a) the graph H_1 to replace a 1-vertex; (b) the graph H_2 to replace a 2-vertex.

Using the arguments of the proof of Corollary 4.4, it follows:

Corollary 5.4 *The 2-Bondage problem is coNP-hard when restricted to 3-regular planar graphs.*

Theorem 5.5 *For any fixed $k \geq 3$, the 1-Bondage problem is NP-hard for bipartite planar graphs with degrees 2 or 3 and girth at least k .*

Proof: We give a polynomial reduction from the 1-Bondage problem which was shown in Theorem 5.3 to be NP-hard for planar cubic graphs with bondage number at most 2. From a cubic planar graph $G = (V, E)$ such that $b(G) \leq 2$, and an integer k , we construct a planar bipartite graph $G' = (V', E')$ with $\Delta(G') \leq 3$ and $g(G') \geq k$.

Let H_e be the graph represented in Figure 7a. We leave to the reader the task of verifying that $\gamma(H_e) = 8$ and $\gamma(H_e \setminus U) = 8$ where $U \subseteq \{x, y\}$. We highlight six minimum dominating set of H_e , that are,

- $A = \{a_1, a_3, b_1, b_4, d_2, e_2, f_2, g_2\}$;
- $B = \{a_1, a_3, b_1, b_4, d_3, e_3, f_3, g_3\}$;
- $C = \{a_1, a_3, b_2, c_3, d_3, e_1, f_1, g_2\}$;
- $D = \{a_2, b_1, b_4, c_1, d_4, e_3, f_2, g_4\}$;
- $E = \{a_1, a_3, b_3, c_4, d_3, e_2, f_4, g_1\}$;
- $F = \{a_1, b_2, b_4, c_2, d_1, e_4, f_3, g_4\}$.

From the γ -sets A, B, C, D, E and Remark 4.1 and 4.2, the graph H_e admits no edge that is γ -critical and therefore $b(H_e) \geq 2$. Note that every vertex of $H_e \setminus \{x, y\}$ belongs to at least one γ -set. Then one can check that $x, y \in \gamma\text{-anticore}(H_e)$.

We describe the operation O_e . Select an edge uv of G . Replace the edge uv by the gadget H_e such that ux and vy are two edges. Let H be the graph obtained from this operation. Note that H is planar with vertex of degree 2 or 3.

We claim that $\gamma(H) = \gamma(G) + 8$. Let S be a γ -set of G . From S we construct S' a dominating set of H . Copy all vertices of S in S' . If $u, v \notin S$ or $u, v \in S$, then add the vertices of the A to S' . Clearly S' dominates H . If $u \in S$ and $v \notin S$ then add the vertices $a_1, b_2, c_3, d_2, e_1, f_1, g_2, y$ to S' . Note that u dominates x and y dominates v . Therefore S' is a dominating set of H . The case $u \notin S$ and $v \in S$ is symmetric. Hence $\gamma(H) \leq \gamma(G) + 8$. Now let S' be a γ -set of H . We define $S = S' \cap V(G)$. Since $\gamma(H_e \setminus U) = 8$, where $U \subseteq \{x, y\}$, then $|S' \cap H_e| \geq 8$. Hence $|S| \leq \gamma(G)$. If $|S| \leq \gamma(G) - 2$ then $S \cup \{u\}$ is a γ -set of G , a contradiction. Suppose that $|S| = \gamma(G) - 1$. If $N[u] \cap S \neq \emptyset$ and $N[v] \cap S \neq \emptyset$ then S is a γ -set of G , a contradiction. So $u, v \notin S$. Hence S does not dominate $H_e \cup U$, where $U \subseteq \{u, v\}$. Since $x, y \in \gamma\text{-anticore}(H_e)$ and $\gamma(H_e) = 8$, we have $|S' \cap H_e| \geq 9$. So $\gamma(H) = \gamma(G) + 8$.

We claim that $b(H) = b(G)$. First let $b(G) = 1$. Let $st, st \neq uv$, be a γ -critical edge of G . From previous arguments $\gamma(H - st) = \gamma(G - st) + 8$ and therefore st is γ -critical in H . Suppose now that uv is the unique γ -critical edge of G . Then from Remark 4.1 and 4.2, for every γ -set S of G either u is the unique vertex dominating v or v is the unique vertex dominating u . Hence in H , x is needed to dominate u or y is needed to dominate v . So ux and vy are two γ -critical edges in H .

Now $b(G) = 2$. Suppose that $b(H) = 1$. Let st be a γ -critical edge in H . Let S be a γ -set of $G - uv$. Note that $S' = S \cup A$ is a γ -set of $H - ux - vy$. Since H_e is an isolated component in $H - ux - vy$ and that $b(H_e) \geq 2$, then st is not an edge with an endpoint in H_e . Thus $\gamma(H - st) = \gamma(G - st) + 8$, a contradiction. So $b(H) \geq 2$. Let st and $s't'$ be two edges such that $\gamma(G - st - s't') = \gamma(G) + 1$. If $uv \notin \{st, s't'\}$, then $\gamma(H - st - s't') = \gamma(G - st - s't') + 8$, a contradiction. Hence we can suppose

that $st = uv$. Yet $\gamma(H - s't') = \gamma(G - s't') + 8$. Since $b(G - s't') = 1$, the previous arguments apply and thus $b(H - s't') = 1$. So $b(H) = b(G)$.

The 3-subdivision of an edge uv is obtained by subdividing uv into four edges by inserting three new vertices. Hence uv is replaced by a path of length five, that is, $P_5 = u - u' - w - v' - v$. The 3-subdivision has been used in [13] (see Corollary 3) to prove the NP-completeness of the Minimum Dominating Set problem for graphs of large girth. It is proved that $\gamma(H) = \gamma(G) + 1$ where H is the graph obtained from a 3-subdivision. Unfortunately this operation does not always maintain the bondage number. Hence we introduced the operation O_e so that we could isolate small induced cycle. Fortunately the 3-subdivision of an edge uv maintains the bondage number when $u, v \notin \gamma\text{-anticore}(G)$.

Let H be the graph obtained from a 3-subdivision of an edge uv of G such that $u, v \notin \gamma\text{-anticore}(G)$. We claim that $b(H) = b(G)$. Suppose that $b(G) = 1$. Let st be a γ -critical edge of G . If $st \neq uv$ then $\gamma(H - st) = \gamma(G - st) + 1$. Hence st is γ -critical in H . Else, from Remark 4.1 and 4.2, for every γ -set of G , either u is the unique vertex dominating v or v is the unique vertex dominating u . Hence in H , u' is the unique vertex dominating u or v' is the unique vertex dominating v . So uu' and vv' are γ -critical in H .

Now $b(G) = 2$. Suppose that $b(H) = 1$. Let st be a γ -critical edge in H . If st is an edge of G then $\gamma(H - st) = \gamma(G - st) + 1$, a contradiction. Hence $st \in \{uu', vv', u'w, v'w\}$. From S , a γ -set of $G - uv$, we obtain $S' = S \cup \{w\}$ a γ -set of H . Then from Remark 4.1, uu' and vv' are not γ -critical in H . Moreover, there exists S_1 and S_2 , two γ -sets of G such that $u \in S_1$ and $v \in S_2$. Note that $S_1 = S_2$ is possible. Then $S'_1 = S \cup \{v'\}$ and $S'_2 = S \cup \{u'\}$ are two γ -sets of H . Yet from Remark 4.1, $u'w$ and $v'w$ are not γ -critical in H . So $b(H) \geq 2$. Let $st, s't'$ be two edges of G such that $\gamma(G - st - s't') = \gamma(G) + 1$. If $st \neq uv$ and $s't' \neq uv$, then $\gamma(H - st - s't') = \gamma(G - st - s't') + 1$. Hence we can suppose that $st = uv$. Then we can construct $H - s't'$ from $G - s't'$. Since $b(G - s't') = 1$, the previous arguments apply and thus $b(H - s't') = 1$. So $b(H) = b(G)$.

Note that the three new vertices u', w, v' , arising from the 3-subdivision of uv , are not γ -anticores in the constructed graph if both u and v are not γ -anticores in G . Hence any new edge can be 3-subdivided without altering the bondage number.

Last, we want to apply the 3-subdivision on the subgraph H_e so that it becomes bipartite, with girth at least k , and such that every induced path between x and y is odd. Let H be a graph obtained from the an operation O_e of an edge uv of the graph G . We show that if uv is not γ -critical in G then no vertices in $H_e \setminus \{x, y\}$ is in $\gamma\text{-anticore}(H)$. Let S be a γ -set of $G - uv$. Then $S \cup X$, where $X \in \{A, B, C, D, E, F\}$, is a γ -set of H . So the vertices of $H_e \setminus \{x, y\}$ are not in $\gamma\text{-anticore}(H)$.

Now we can 3-subdivide the bold and dotted edges of H_e , as represented in Figure 7b. Each bold edge will be 3-subdivided iteratively so that the path between its endpoints is even, while each dotted edge will be 3-subdivided iteratively so that the path between its endpoints is odd. Multiples operations of 3-subdivision will be applied until the modified graph H_e has girth at least k . Then it remains to show

that the arising graph H'_e is bipartite and that there is no even path between x and y . See this 2-coloring of H_e in Figure 7b. Then one can check the following:

- the vertices connected by an edge or an even path (bold edge) have distinct colors;
- the vertices connected by an odd path (dotted edge) have the same color;
- x and y have the same color and the colored paths between x and y alternate.

It follows that H'_e is a planar, subcubic, bipartite, and has girth at least k .

Applying iteratively the operation H_e and the 3-subdivision as done above, we obtain a graph H that is planar, subcubic, bipartite, with girth at least k , and such that $b(H) = b(G)$. \square

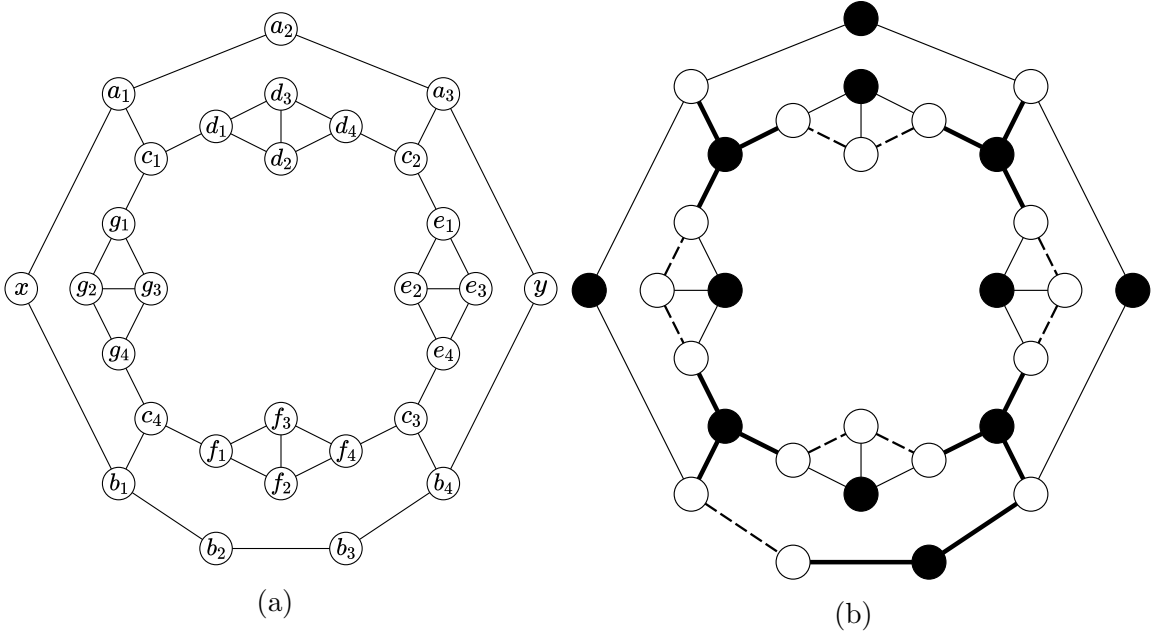

Figure 7: (a) The graph H_e that corresponds to an edge; (b) 3-subdivisions of the dotted and bold edges of the graph H_e , so that the resulting graph is bipartite with girth at least k .

Since the resulting graph H in the preceding proof has bondage number at most 2, we obtain the following.

Corollary 5.6 *For any fixed $k \geq 3$, the 2-Bondage problem is coNP-hard for bipartite planar graphs of degrees 2 or 3 and girth at least k .*

In [6], it is proved that any planar graph of girth at least 8 has bondage number at most 3. Hence it follows:

Corollary 5.7 *Let G be a bipartite, planar graphs, with $\delta(G) = 2$, $\Delta(G) = 3$ and $g(G) \geq 8$. Deciding if $b(G) = 1$ is NP-hard, deciding if $b(G) = 2$ is coNP-hard and deciding if $b(G) \leq 3$ can be done in $O(1)$.*

6 Conclusion and open problems

We proved the NP-hardness and the coNP-hardness of the 1-Bondage problem and the 2-Bondage problem, respectively, for the following classes of graphs:

- planar cubic graphs;
- planar claw-free graphs with maximum degree 3;
- planar bipartite graphs with degrees 2 or 3 and girth at least k , for any fixed $k \geq 3$.

It is natural to ask for the complexity of the Bondage problem for bipartite cubic graphs of girth at least k , for any fixed $k \geq 3$. Yet from our construction, it seems not possible to remove vertices of degree two without introducing small cycles. Hence the study of (C_4, \dots, C_k) -free graphs would be of interest. Also complexity results for H -free graphs, for fixed H , would be of important values.

Another important study concerns the complexity of the k -Bondage problem for fixed $k > 2$. One notable case we would like to highlight is the complexity of the Bondage problem for $k \geq \Delta(G) + 1$. But, first some context and definitions: a graph G is called γ -critical if $\gamma(G - v) = \gamma(G)$, for every vertex $v \in V(G)$. It is easy to check that for a graph G , if $b(G) \geq \Delta(G) + 1$ then G is γ -critical and regular. To our knowledge, very few results have been obtained on the properties of γ -critical graphs. If the Bondage problem was to be NP-hard for $k \geq \Delta(G) + 1$, then this would mean that γ -critical graphs do not admit a nice characterization, in the sense of J. Edmonds, see [4]. In this case, one hope would be to restrict to planar graphs. Also it would be natural to ask if all γ -critical regular graphs have bondage at least $\Delta(G) + 1$.

Acknowledgements: The author express their gratitude to François Delbot, Christophe Picouleau and Stéphane Rovedakis for carefully reading the manuscript, and for providing helpful comments.

References

- [1] J. A. Bondy, U.S.R. Murty, *Graph Theory*, Springer, (2008).
- [2] E. Boros, M. C. Golumbic, V. E. Levit, *On the number of vertices belonging to all maximum stable sets of a graph*, Discret. Appl. Math., 124(1-3) (2002), 17-25.
- [3] S.A. Cook, *The complexity of theorem-proving procedures*, Proc. 3rd Ann. ACM Symp. on Theory of Computing (Assoc. Comput. Mach., New York), (1971), 151-158.
- [4] J. Edmonds, *Minimum partition of a matroid into independent subsets*, J. Res. Nat. Bur. Standards Sect. B, 69 (1965) 67-72.

- [5] J.F. Fink, M.S. Jacobson, L.F. Kinch, and J. Roberts, *The bondage number of a graph*, Discret. Math., 86(1-3) (1990), 47-57.
- [6] M. Fischermann, D. Rautenbach, L. Volkmann, *Remarks on the bondage number of planar graphs*, Discret. Math., 260(1-3) (2003), 57-67.
- [7] M.R. Garey, D.S. Johnson, L. Stockmeyer, *Some simplified NP-complete graph problems*, Theoret. Comput. Sci., 1(3) (1976), 237-267.
- [8] M. R. Garey and D. S. Johnson, *Computers and Intractability: A Guide to the Theory of NP-Completeness*, Freeman, 1979.
- [9] T. W. Haynes, S. T. Hedetniemi, P. J. Slater *Fundamentals of Domination in Graphs*, Marcel Dekker Inc., (1998).
- [10] F-T. Hu, M. Y. Sohn, *The algorithmic complexity of bondage and reinforcement problems in bipartite graphs*, Theoret. Comput. Sci., 535 (2014), 46-53.
- [11] F-T. Hu, J-M Xu *On the complexity of the bondage and reinforcement problems*, J. Complex., 28(2) (2012), 192-201.
- [12] J-M. Xu, *On Bondage Numbers of Graphs: A Survey with Some Comments*, Inter. J. of Comb., 2013 (2013).
- [13] I. E. Zverovich, V. E. Zverovich, *An induced subgraph characterization of domination perfect graphs*, J. Graph Theory, 20(3) (1995), 375-395.