

The chromatic number of signed graphs with bounded maximum average degree*

Fabien Jacques, Alexandre Pinlou

LIRMM, University of Montpellier, CNRS, Montpellier, France
 firstname.lastname@lirmm.fr

Abstract

A signed graph is a simple graph with two types of edges: positive and negative edges. Switching a vertex v of a signed graph corresponds to changing the type of each edge incident to v .

A homomorphism from a signed graph G to another signed graph H is a mapping $\varphi : V(G) \rightarrow V(H)$ such that, after switching some of the vertices of G , φ maps every edge of G to an edge of H of the same type. The chromatic number $\chi_s(G)$ of a signed graph G is the order of a smallest signed graph H such that there is a homomorphism from G to H .

The maximum average degree $\text{mad}(G)$ of a graph G is the maximum of the average degrees of all the subgraphs of G . We denote \mathcal{M}_k the class of signed graphs with maximum average degree less than k and \mathcal{P}_g the class of planar signed graphs of girth at least g .

We prove:

- $\chi_s(\mathcal{P}_7) \leq 5$,
- $\chi_s(\mathcal{M}_{\frac{17}{5}}) \leq 10$ which implies $\chi_s(\mathcal{P}_5) \leq 10$,
- $\chi_s(\mathcal{M}_{4-\frac{8}{q+3}}) \leq q+1$ with q a prime power congruent to 1 modulo 4.

1 Introduction

There exist several notions of colorings of signed graphs which are all natural extensions and generalizations of colorings of simple graphs. It is well-known that a k -coloring of a graph is no more than a homomorphism to the complete graph on k vertices. Using the notion of homomorphism of signed graphs introduced by Guenin [8] in 2005, we can define a corresponding notion of coloring of signed graphs. This has attracted a lot of attention since then and the general question of knowing whether every signed graphs in a family admits a homomorphism to some H has been extensively studied. We can for example cite the expansive papers by Naserasr et al. [11, 12] where they developed many aspects of this notion.

Coloring planar graphs has become an illustrious problem in the middle of the 19th century thanks to the Four Color Theorem, that states that four colors are enough to color any simple planar graph. Various branches of this topic then arose, one of which being devoted to the coloring of *sparse* planar graphs. A way to measure the sparseness of a planar graph is to consider its girth (i.e. the length of a shortest cycle): the higher the girth is, the sparser the graph is. Signed coloring of sparse planar graphs has been considerably studied in the last decade (see e.g. [1, 4, 10, 11, 13, 14]).

A way to get results on sparse planar graphs is to consider graphs (not necessarily planar) with bounded maximum average degree since there exists a well-known relation that links the maximum average degree and the girth of a planar graph (details are given in the next subsection).

*Funding: This work was partially supported by the grant HOSIGRA funded by the French National Research Agency (ANR, Agence Nationale de la Recherche) under the contract number ANR-17-CE40-0022.

In this paper, we consider homomorphisms of signed graphs with bounded maximum average degree.

We will first give some classical definitions, define signed graphs and homomorphisms in the remainder of this section and the list of target graphs we will use. Section 2 introduces the results we obtained and put them in the perspective with the known results. The proof techniques are similar for all our results and we present them in Section 3. Sections 4 to 6 are dedicated to the proofs of our results.

1.1 Definitions and notation

The degree of a vertex v is its number of neighbors and is denoted by $d(v)$. We call a vertex of degree k a k -*vertex*, a vertex of degree at least k a k^+ -*vertex* and a vertex of degree at most k a k^- -*vertex*. We denote by $N(v)$ (resp. $N^-(v)$, $N^+(v)$) the set of vertices that are adjacent (resp. adjacent with a negative edge, adjacent with a positive edge) to a vertex v . Let W be a set of vertices, $N(W) = \bigcup_{v \in W} N(v)$ (we also define $N^-(W)$ and $N^+(W)$ similarly). The *order* of a graph G is the cardinality of its vertex set. The *girth* of a graph is the length of a shortest cycle. The *maximum average degree* $\text{mad}(G)$ of a graph G is the maximum of the average degree of all the subgraphs of G . There exists a well-known relation that links the maximum average degree and the girth of a planar graph:

Claim 1. *Every planar graph G of girth at least g has $\text{mad}(G) < \frac{2g}{g-2}$.*

Let us denote by \mathcal{P}_g (resp. \mathcal{M}_d) the class of planar graphs of girth at least g (resp. the class of graphs with maximum average degree less than d). Therefore, \mathcal{P}_3 corresponds to the class of planar graphs (since 3 is the smallest size of a cycle).

1.2 Signed graphs

A *signed graph* $G = (V, E, s)$ is a simple graph (V, E) with two kinds of edges: positive and negative edges. The signature $s : E(G) \rightarrow \{-1, +1\}$ assigns to each edge its sign (we do not allow parallel edges nor loops). Given a signed graph $G = (V, E, s)$, the *underlying graph* of G is the simple graph (V, E) . *Switching* a vertex v of a signed graph corresponds to reversing the signs of all the edges that are incident to v . Two signed graphs G and G' are *switching equivalent* if it is possible to turn G into G' after some number of switches. The *balance* of a closed walk of a signed graph is the parity of its number of negative edges; a closed walk is said to be *balanced* (resp. *unbalanced*) if it has an even (resp. odd) number of negative edges.

We can note that a switch does not alter the parity of any closed walk since a switch reverses the sign of an even number of edges of a closed walk. Therefore, Zaslavsky [16] showed the following:

Theorem 2 (Zaslavsky [16]). *Two signed graphs are switching equivalent if and only if they have the same underlying graph and the same set of balanced cycles.*

1.3 Homomorphisms of signed graphs

Given two signed graphs G and H , the mapping $\varphi : V(G) \rightarrow V(H)$ is a *homomorphism* if φ preserves adjacencies and the balance of closed walks: an edge uv of G maps to an edge $\varphi(u)\varphi(v)$ of H and a closed walk $v_1v_2 \dots v_k$ of G maps to a closed walk $\varphi(v_1)\varphi(v_2) \dots \varphi(v_k)$ of H of the same balance. This can be seen as coloring the graph G by using the vertices of H as colors. We write $G \rightarrow H$ when there exists an homomorphism from G to H . This notion of homomorphism was introduced by Guenin [8] in 2005 and arises naturally from the fact that the balance of closed walks is central in the field of signed graphs.

Let us introduce the following notion of sign-preserving homomorphisms which is central in studying homomorphisms of signed graphs (see Lemma 4 in the next section to understand why) and allows us to give an alternate definition to homomorphisms of signed graphs. Given two signed graphs G and H , the mapping $\varphi : V(G) \rightarrow V(H)$ is a *sign-preserving homomorphism*

(sp-homomorphism) if φ preserves adjacencies and the signs of edges: if vertices 1 and 2 in H are connected with a positive (resp. negative) edge, then every pair of adjacent vertices in G colored with 1 and 2 must be connected with a positive (resp. negative) edge. We write $G \xrightarrow{sp} H$ when there exists an sp-homomorphism from G to H . Note that an sp-homomorphism is clearly a homomorphism (adjacencies and balances of closed walk are kept). A reader familiar with the notion of homomorphisms of 2-edge-colored graphs will recognize that it coincides with the notion of sign-preserving homomorphisms of signed graphs.

We can then alternatively define homomorphism of signed graph as follows: $G \rightarrow H$ if and only if there exists a signed graph G' switching equivalent to G such that $G' \xrightarrow{sp} H$. See [12] for a proof of that equivalence.

The *chromatic number* $\chi_s(G)$ (resp. *sign-preserving chromatic number* $\chi_{sp}(G)$) of a signed graph G is the order of a smallest graph H such that $G \rightarrow H$ (resp. $G \xrightarrow{sp} H$). The (sign-preserving) chromatic number $\chi_{s/sp}(\mathcal{C})$ of a class of signed graphs \mathcal{C} is the maximum of the (sign-preserving) chromatic numbers of the graphs in the class. If G admits a (sp-)homomorphism φ to H , we say that G is H -(sp-)colorable and that φ is an H -(sp-)coloring of G .

1.4 Target Graphs

We present in this subsection the target graphs that will be used to prove our results.

Let $G = (V, E, s)$ be a signed graph. The graph G is said to be *antiautomorphic* if it is isomorphic to $(V, E, -s)$. The graph G is said to be K_n -*transitive* if for every pair of cliques $\{u_1, u_2, \dots, u_n\}$ and $\{v_1, v_2, \dots, v_n\}$ in G such that $s(u_i u_j) = s(v_i v_j)$ for all $i \neq j$, there exists an automorphism that maps u_i to v_i for all i . For $n = 1, 2$, or 3 , we say that the graph is *vertex-transitive*, *edge-transitive*, or *triangle-transitive*, respectively.

The graph G has *Property* $P_{k,n}$ if for every sequence of k distinct vertices (v_1, v_2, \dots, v_k) that induces a clique in G and for every sign vector $(\alpha_1, \alpha_2, \dots, \alpha_k) \in \{-1, +1\}^k$ there exist at least n distinct vertices $\{u_1, u_2, \dots, u_n\}$ such that $s(v_i u_j) = \alpha_i$ for $1 \leq i \leq k$ and $1 \leq j \leq n$.

Let q be a prime power with $q \equiv 1 \pmod{4}$. Let \mathbb{F}_q be the finite field of order q . The *signed Paley graph* SP_q has vertex set $V(SP_q) = \mathbb{F}_q$. Two vertices u and $v \in V(SP_q)$, $u \neq v$, are connected with a positive edge if $u - v$ is a square in \mathbb{F}_q and with a negative edge otherwise.

Notice that this definition is consistent since $q \equiv 1 \pmod{4}$ ensures that -1 is always a square in \mathbb{F}_q and if $u - v$ is a square then $v - u$ is also a square.

Lemma 3 ([14]). *The signed graph SP_q is vertex-transitive, edge-transitive, antiautomorphic and has properties $P_{1, \frac{q-1}{2}}$ and $P_{2, \frac{q-5}{4}}$.*

Figure 1 gives as an example the signed graph SP_9 which contains nine vertices and is complete (only positive edges are displayed, non-edges are negative edges).

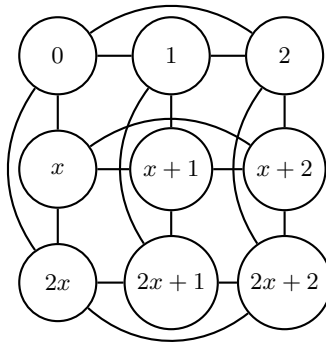

Figure 1: The graph SP_9 , non-edges are negative edges.

Given a signed graph G of signature s_G , we create the *antitwinned graph* of G denoted by $\rho(G)$ as follows:

- We take two copies G^{+1} , G^{-1} of G (the vertex corresponding to $v \in V(G)$ in G^i is denoted by v^i)
- $V(\rho(G)) = V(G^{+1}) \cup V(G^{-1})$
- $E(\rho(G)) = \{u^i v^j : uv \in E(G), i, j \in \{-1, +1\}\}$
- $s_{\rho(G)}(u^i v^j) = i \times j \times s_G(u, v)$

By construction, for every vertex v of G , v^{-1} and v^{+1} are *antitwins*, the positive neighbors of v^{-1} being the negative neighbors of v^{+1} and vice versa. We say that a signed graph is *antitwinned* if every vertex has a unique antitwin. If v is a vertex in an antitwinned graph, we denote its antitwin with \bar{v} .

Antitwinned signed graphs play a central role thanks to the following lemma:

Lemma 4 ([5]). *Let G and H be signed graphs. The two following propositions are equivalent:*

- *The graph G admits a homomorphism to H .*
- *The graph G admits a sp-homomorphism to $\rho(H)$.*

In other words, if a signed graph $G = (V, E, s)$ admits an sp-homomorphism to an antitwinned target graph on n vertices, then it also admits a homomorphism to a target graph on $\frac{n}{2}$ vertices. We therefore have the following inequalities:

Proposition 5 ([11]). *For every signed graph G , we have $\chi_s(G) \leq \chi_{sp}(G) \leq 2 \cdot \chi_s(G)$.*

Graphs $\rho(SP_q)$ have the remarkable structural properties given below:

Lemma 6 ([14]). *The graph $\rho(SP_q)$ is vertex-transitive, antiautomorphic and has properties $P_{1,q-1}$, $P_{2, \frac{q-3}{2}}$ and $P_{3, \max(\frac{q-9}{4}, 0)}$.*

Given a signed graph G which is vertex-transitive, we denote by G^- the graph obtained from G by removing any vertex. Given a signed graph G , we denote by G^+ the graph obtained from G by adding a vertex that is connected with a positive edge to every other vertex.

In the literature, the graph $\rho(SP_q^+)$ is also known as the Tromp-Paley graph $TR(SP_q)$. This construction improves the properties of $\rho(SP_q)$ at the cost of having only two more vertices (indeed, $|V(\rho(SP_q^+))| = |V(\rho(SP_q))| + 2$).

Lemma 7 ([14]). *The graph $\rho(SP_q^+)$ is vertex-transitive, edge-transitive, antiautomorphic and has properties $P_{1,q}$, $P_{2, \frac{q-1}{2}}$ and $P_{3, \frac{q-5}{4}}$.*

2 State of the art and results

As mentioned in the introductory section, the (sign-preserving) chromatic number of signed graphs has been studied extensively. Several papers are devoted to planar graphs, planar graphs with given girth, and graphs with bounded maximum average degree.

In 2000, Nešetřil and Raspaud [13] considered the coloring of (m, n) -mixed-graphs (which is a super-class of signed graphs) and they proved that $\chi_{sp}(\mathcal{P}_3) \leq 80$ by showing that any signed planar graph admits a sp-homomorphism to an antitwinned signed graph on 80 vertices. This implies as a corollary that $\chi_s(\mathcal{P}_3) \leq 40$ by Lemma 4. The same year, Montejano et al. [10] constructed a signed planar graph H such that $\chi_{sp}(H) = 20$, that implies $\chi_{sp}(\mathcal{P}_3) \geq 20$ and thus $\chi_s(\mathcal{P}_3) \geq 10$. The gap between the lower and upper bounds is huge and in 2020, Bensmail et al. [2] conjectured that $\chi_{sp}(\mathcal{P}_3) = 20$. Recently, Bensmail et al. [1] proved that if this conjecture is true, then the target graph is necessarily $\rho(SP_9^+)$. Since this target graph is antitwinned, this would imply that $\chi_s(\mathcal{P}_3) = 10$. This question remains widely open.

Coloring of sparse (planar) graphs have then been considered. In particular, the following results were obtained:

Graph families	χ_s	χ_{sp}	Remarks	Refs.
\mathcal{P}_3	$10 \leq \chi_s \leq 40$	$20 \leq \chi_{sp} \leq 80$		[10, 13]
\mathcal{P}_4	$6 \leq \chi_s \leq 25$	$12 \leq \chi_{sp} \leq 50$		[14]
$\mathcal{M}_{\frac{10}{3}}$	$\chi_s \leq 10$	$\chi_{sp} \leq 20$	$\mathcal{P}_5 \subset \mathcal{M}_{\frac{10}{3}}$	[10]
\mathcal{M}_3	$\chi_s \leq 6$	$\chi_{sp} \leq 12$	$\mathcal{P}_6 \subset \mathcal{M}_3$	[10]
$\mathcal{M}_{\frac{8}{3}}$	$\chi_s \leq 6$	$\chi_{sp} \leq 8$	$\mathcal{P}_8 \subset \mathcal{M}_{\frac{8}{3}}$	[10]
$\mathcal{M}_{\frac{18}{7}}$	$\chi_s = 4$	$\chi_{sp} \leq 8$	$\mathcal{P}_9 \subset \mathcal{M}_{\frac{18}{7}}$	[17]
$\mathcal{P}_{\geq 13}$	$\chi_s = 4$	$\chi_{sp} = 5$		[4]

Table 1: Known results for (sp-)chromatic number of planar graphs with given girth and graphs with bounded maximum average degree.

Girth 4: Ochem et al. [14] proved that signed planar graphs of girth 4 admit a sp-homomorphism to $\rho(SP_{25})$, that is $\chi_{sp}(\mathcal{P}_4) \leq 50$. They also proved that $\chi_{sp}(\mathcal{P}_4) \geq 12$. By Lemma 4, we thus have $6 \leq \chi_s(\mathcal{P}_4) \leq 25$ since $\rho(SP_{25})$ is antitwinned. Note that Bensmail et al. [1] conjectured that $\chi_{sp}(\mathcal{P}_4) = 12$ and proved that if this conjecture is true, then the target graph is necessarily $\rho(SP_5^+)$. Since this target graph is antitwinned, this would imply that $\chi_s(\mathcal{P}_4) = 6$.

Girths 5, 6 and 8 : Montejano et al. [10] proved that signed graphs with maximum average degree less than $\frac{10}{3}$ (resp. $3, \frac{8}{3}$) admit a sp-homomorphism to $\rho(SP_9^+)$ (resp. $\rho(SP_5^+), SP_9^-$), that is $\chi_{sp}(\mathcal{M}_{\frac{10}{3}}) \leq 20$, $\chi_{sp}(\mathcal{M}_3) \leq 12$ and $\chi_{sp}(\mathcal{M}_{\frac{8}{3}}) \leq 8$. By Claim 1, we get that $\chi_{sp}(\mathcal{P}_5) \leq 20$, $\chi_{sp}(\mathcal{P}_6) \leq 12$ and $\chi_{sp}(\mathcal{P}_8) \leq 8$. Moreover, since $\rho(SP_9^+)$ and $\rho(SP_5^+)$ are antitwinned, we get that $\chi_s(\mathcal{M}_{\frac{10}{3}}) \leq 10$, $\chi_s(\mathcal{M}_3) \leq 6$, $\chi_s(\mathcal{P}_5) \leq 10$, and $\chi_s(\mathcal{P}_6) \leq 6$ as a corollary by Lemma 4. Note that since SP_9^- is not antitwinned, Lemma 4 does not apply and thus $\chi_s(\mathcal{M}_{\frac{8}{3}}) \leq 6$ and $\chi_s(\mathcal{P}_8) \leq 6$ are the best known bounds.

Girth 9: Charpentier et al. [17] proved that signed graphs with maximum average degree less than $\frac{18}{7}$ admit a homomorphism to the complete graph on 4 vertices in which every edge is positive except one that is $\chi_s(\mathcal{M}_{\frac{18}{7}}) \geq 4$ and by Claim 1, $\chi_s(\mathcal{P}_9) \geq 4$. Since an unbalanced cycle of even length has chromatic number 4 [7], this bounds are tight. Note that by Lemma 4 these results imply $\chi_s(\mathcal{M}_{\frac{18}{7}}) \geq 8$ and $\chi_s(\mathcal{P}_9) \geq 8$ but we can already infer that from the bounds on $\chi_{sp}(\mathcal{M}_{\frac{8}{3}})$ and $\chi_{sp}(\mathcal{P}_8)$.

Girth $g \geq 13$: Borodin et al. [4] proved that for any $g \geq 13$, $\chi_{sp}(\mathcal{P}_g) = 5$.

See Table 1 for a summary.

In the same vein, the first author [9] recently studied the chromatic number of signed triangular and hexagonal grids, which are subclasses of planar graphs. He respectively proved that 4 (resp. 10) colors are enough for hexagonal (resp. triangular) grids, supporting the conjecture that signed planar graphs have chromatic number at most 10.

In this paper, we try to find, given a target graph T , the highest possible value m such that every graph with maximum average degree less than m admits a homomorphism to T . We prove the following three theorems.

Theorem 8. *If a signed graph has maximum average degree smaller than $\frac{20}{7}$, it admits a homomorphism to SP_5 . That is $\chi_s(\mathcal{M}_{\frac{20}{7}}) \leq 5$.*

As a corollary, this gives that $\chi_s(\mathcal{P}_7) \leq 5$ and $\chi_{sp}(\mathcal{P}_7) \leq 10$, which are new results that contribute to the above-mentioned collection of results.

Theorem 9. *If a signed graph has maximum average degree smaller than $\frac{17}{5}$, it admits a homomorphism to SP_9^+ . That is $\chi_s(\mathcal{M}_{\frac{17}{5}}) \leq 10$*

This improves the result of Montejano et al. [10] saying that $\chi_s(\mathcal{M}_{\frac{10}{3}}) \leq 10$ since $\mathcal{M}_{\frac{10}{3}} \subset \mathcal{M}_{\frac{17}{5}}$. Note that this result contributes to the conjecture that every planar graph admits a homomorphism to SP_9^+ .

It is not hard to see that signed graphs with maximum average degree at least 4 have unbounded chromatic number. Consider a complete graph on n vertices v_1, \dots, v_n , subdivide each edge $v_i v_j$ by adding a new vertex u_{ij} , and for each pair i, j , the 2-path v_i, u_{ij}, v_j will have one positive and one negative edge. It is easy to see that the average degree of this graph tends to 4 when n tends to infinity. Moreover, since each pair of v_i, v_j is linked by a 2-path formed by a negative and a positive edge, the n initial vertices must have n distinct colors. Therefore $\chi_{sp}(\mathcal{M}_4)$ is unbounded and thus $\chi_s(\mathcal{M}_4)$ is also unbounded by Proposition 5. The following last result gives an upper bound of the chromatic number of signed graphs of maximum average degree $4 - \varepsilon$ in function of ε .

Theorem 10. *Let $q > 9$ be a prime power congruent to 1 modulo 4. If a signed graph has maximum average degree smaller than $4 - \frac{8}{q+3}$, it admits a homomorphism to SP_q^+ . That is $\chi_s(\mathcal{M}_{4-\frac{8}{q+3}}) \leq q + 1$.*

3 Proof techniques

Since it is easier to manipulate sp-homomorphisms than homomorphisms, we will prove in the remaining four sections that any graph $G \in \mathcal{M}_{\frac{20}{7}}$ (resp. $\mathcal{M}_{\frac{17}{5}}, \mathcal{M}_{4-\frac{8}{q+3}}$) admits an sp-homomorphism to $\rho(SP_5)$ (resp. $\rho(SP_9^+), \rho(SP_q^+)$). Theorems 8 to 10 will then be obtained as corollaries of Lemma 4.

We prove our theorems by contradiction, by assuming that they have counterexamples. Among all of these counterexamples, we take a graph G with the fewest number of vertices. Our goal is to prove that G satisfies structural properties incompatible with having a maximum average degree smaller than a certain value, hence the conclusion.

For each theorem we start by introducing sets of so-called forbidden configurations, which by minimality G cannot contain. We then strive to reach a contradiction with the bounded maximum average degree. To do so, we use the discharging method. This means that we give some initial weight to vertices of G , then we redistribute those weights, and obtain a contradiction by double counting the total weight. We present appropriate collections of discharging rules, and argue that every vertex of G ends up with non-negative weight while the total initial weight was negative.

Finding a contradiction using a set of forbidden configurations is an application of a well-known tool called the discharging method. This approach was introduced more than a century ago to study the Four-Color Conjecture [15], now a theorem. It is especially well-suited for studying sparse graphs, and leads to many results, as shown in two recent surveys [3, 6]. Note that the discharging method only allows us to reduce the proofs to showing that some configurations are forbidden.

In order to prove that G cannot contain a configuration C_i , we need to find a suitable smaller graph G' and to extend any coloring of G' to G . Since G is a minimum counterexample, we get a contradiction if G contains C_i .

4 Proof of Theorem 8

In this section, we prove that any signed graph of maximum average degree less than $\frac{20}{7}$ and girth 7 admit a $\rho(SP_5)$ -sp-coloring. To do so, we suppose that this theorem is false and we consider in the remainder of this section a minimal counter-example G w.r.t. its order: it is a smallest signed graph with $\text{mad}(G) < \frac{20}{7}$ and girth admitting no $\rho(SP_5)$ -sp-coloring.

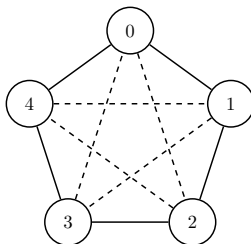

Figure 2: SP_5 , the signed Paley graph on 5 vertices.

We first introduce some notation in order to simplify the statements of configurations and rules.

We say that a 3-vertex v is:

- *3-worse* if it has one 2-neighbor (note that by Configuration C_3 a 3-vertex cannot have more than one 2-neighbor).
- *3-bad* if it has two 3-worse-neighbors (note that by Configuration C_3 a 3-vertex cannot have three 3-worse-neighbors and by configuration C_2 a 3-bad cannot be 3-worse).
- *3-good* otherwise.

We will say that 3-bad-vertices and 2-vertices are *bad vertices*.

4.1 Forbidden configurations

We define several configurations C_0, \dots, C_5 as follows (see Figure 3).

- C_0 is a 0-vertex.
- C_1 is a 1-vertex.
- C_2 is two adjacent bad vertices.
- C_3 is a 3-vertex with two bad neighbors.
- C_4 is a 3-vertex with one bad neighbor adjacent to another 3-vertex with one bad neighbor.
- C_5 is a 4-vertex with three 2-neighbors.

Note that every pair of vertices represented in Figure 3 is distinct since otherwise G would not have girth at least 7.

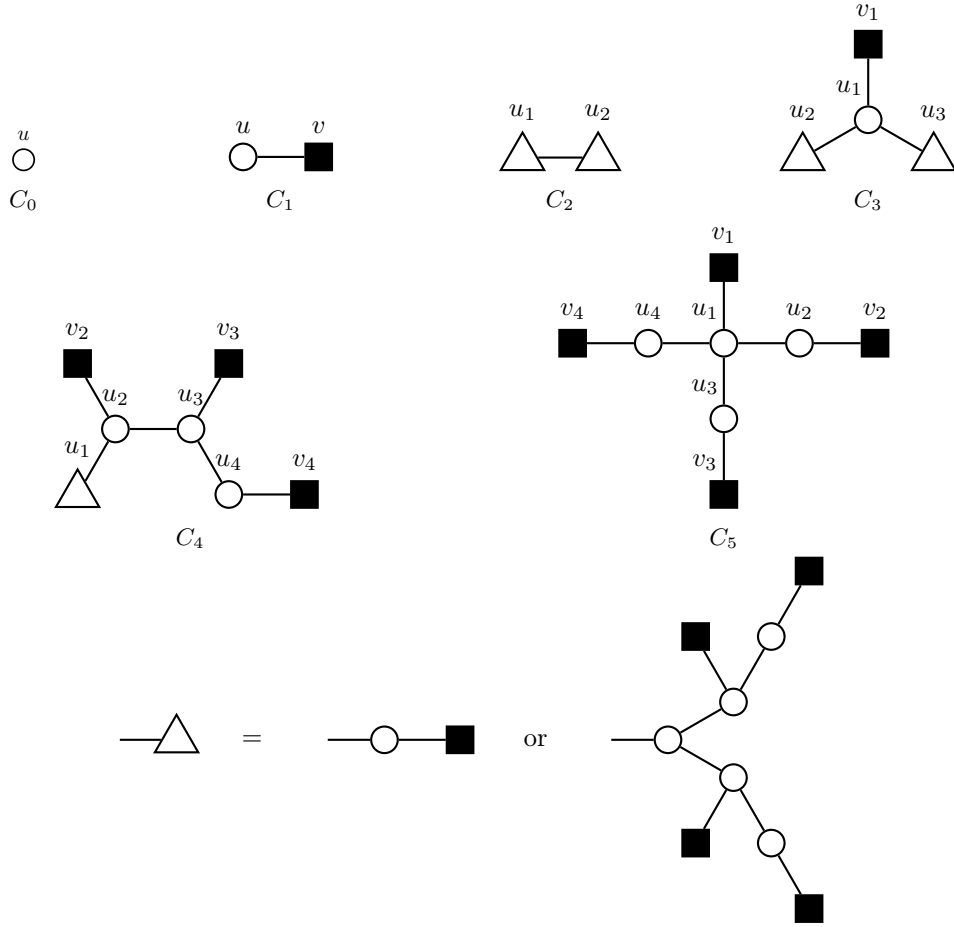

Figure 3: Forbidden configurations. Square vertices can be of any degree. White vertices will be removed while proving the non-existence of the configuration. Triangles are bad vertices: 2-vertices or 3-bad-vertices.

We prove that configurations C_0 to C_5 are forbidden in G . To this end, we first prove some general results we use to prove that the configurations are forbidden. Remember that $\rho(SP_5)$ is vertex-transitive, antiautomorphic and has Properties $P_{1,4}$ and $P_{2,1}$ by Lemma 6.

Consider a signed graph H , a vertex v of H of degree k , its k neighbors u_1, u_2, \dots, u_k . Let $H' = H - v$ and suppose there exists a sp-homomorphism $\varphi' : H' \xrightarrow{sp} \rho(SP_5)$. With the aim of extending φ' to an sp-homomorphism φ of the whole graph H we can compute the number of colors forbidden for v by each of its neighbors u_i . If we are able to prove that at most 9 colors are forbidden for v , then this means that φ' can be extended to an sp-homomorphism φ of the whole graph H . Note that we may need to recolor some vertices already colored by φ' . We denote the signature of H by s_H . We prove the following claims to this end:

Claim 11. *2-neighbors forbid one color.*

Claim 12. *3-worse-neighbors forbid at most two colors.*

Claim 13. *3-bad-neighbors forbid at most one color.*

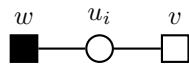

Figure 4: Vertex v is adjacent to a 2-vertex.

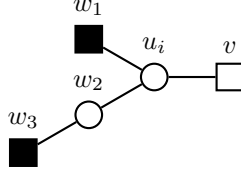

Figure 5: Vertex v is adjacent to a 3-worse-vertex.

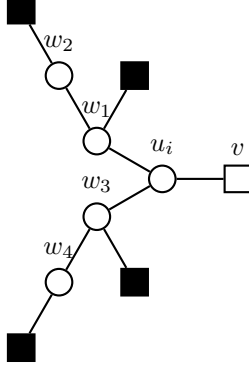

Figure 6: Vertex v is adjacent to a 3-bad-vertex.

Proof of Claim 11. Let u_i be a 2-neighbor of v and let w be the other neighbor of u_i (see Figure 4). First uncolor vertex u_i . Without loss of generality we can suppose that $\varphi'(w) = 0$ since $\rho(SP_5)$ is vertex-transitive. If $\varphi(v) \notin \{0, \bar{0}\}$ it is possible to recolor u_i by Property $P_{2,1}$ of $\rho(SP_5)$. If $s_H(wu_i) = s_H(u_iv)$ and $\varphi(v) = 0$ or $s_H(wu_i) \neq s_H(u_iv)$ and $\varphi(v) = \bar{0}$ then v and w give the same constraints on u_i and we can recolor u_i by Property $P_{1,4}$ of $\rho(SP_5)$. Therefore, depending on the signature of the edges wu_i and u_iv , the 2-vertex u_i forbids exactly one color from v and we say that a 2-neighbor forbids one color. \square

Proof of Claim 12. Let u_i be a 3-worse-neighbor of v (see Figure 5 for vertex naming). First uncolor vertices u_i and w_2 . Without loss of generality we can suppose that $\varphi'(w_1) = 0$ and that w_1u_i is a positive edge since $\rho(SP_5)$ is vertex-transitive and antiautomorphic. Therefore, u_i may take its color in the set $\{1, \bar{2}, \bar{3}, 4\}$ (i.e the positive neighbors of 0 in $\rho(SP_5)$). By Claim 11, the 2-vertex w_2 forbids one color f from u_i .

- If $f = 1$, then it will always be possible to recolor u_i as long as $\varphi(v) \notin \{\bar{0}, 2\}$ (resp. $\varphi(v) \notin \{0, \bar{2}\}$) if u_iv is positive (resp. negative).
- If $f = \bar{2}$, then it will always be possible to recolor u_i as long as $\varphi(v) \notin \{\bar{0}, 4\}$ (resp. $\varphi(v) \notin \{0, \bar{4}\}$) if u_iv is positive (resp. negative).
- If $f = \bar{3}$, then it will always be possible to recolor u_i as long as $\varphi(v) \notin \{\bar{0}, 1\}$ (resp. $\varphi(v) \notin \{0, \bar{1}\}$) if u_iv is positive (resp. negative).
- If $f = 4$, then it will always be possible to recolor u_i as long as $\varphi(v) \notin \{\bar{0}, 3\}$ (resp. $\varphi(v) \notin \{0, \bar{3}\}$) if u_iv is positive (resp. negative).
- If $f \notin \{1, \bar{2}, \bar{3}, 4\}$, then it will always be possible to recolor u_i as long as $\varphi(v) \neq \bar{0}$ (resp. $\varphi(v) \neq 0$) if u_iv is positive (resp. negative).

Therefore, 3-worse-neighbors forbid at most two colors. \square

Proof of Claim 13. Let u_i be a 3-bad-neighbor of v (see Figure 6 for vertex naming). Note that vertices w_1 and w_3 are 3-worse vertices. First uncolor vertices u_i, w_1, \dots, w_4 . By Claim 12, each of w_1 and w_3 forbids at most 2 colors from u_i . Let F be the set of forbidden colors for u_i ; thus $|F| \leq 4$, and let $A = V(\rho(SP_5)) \setminus F$.

- If A contains at least four colors that are in the same copy of SP_5 , it will always be possible to recolor u_i for any color of v .
- If A contains three colors that are in the same copy of SP_5 (by symmetry, there are only two cases to consider, either these three colors are consecutive modulo 5 or they are not), there exists only one color such that it is not possible to recolor u_i .

Therefore, 3-bad-vertices can forbid at most one color from their neighbors. \square

We now use Claims 11 to 13 to prove that configurations C_0 to C_5 cannot appear in G . Recall that G is a smallest signed graph with $\text{mad}(G) < \frac{20}{7}$ that does not admit a sp-homomorphism to $\rho(SP_5)$.

Lemma 14. *The graph G does not contain C_0 .*

Proof. Suppose that G contains C_0 , a vertex u of degree 0. By minimality of G , $G - u$ admits a $\rho(SP_5)$ -sp-coloring φ . Vertex u can be mapped to any vertex of $\rho(SP_5)$ to extend φ to a $\rho(SP_5)$ -sp-coloring of G , a contradiction. \square

Lemma 15. *The graph G does not contain C_1 .*

Proof. Suppose that G contains C_1 , a vertex u of degree 1. By minimality of G , $G - u$ admits a $\rho(SP_5)$ -sp-coloring φ . By Property $P_{1,4}$ of $\rho(SP_5)$, there are at least 4 vertices that u can be mapped to in order to extend φ to a $\rho(SP_5)$ -sp-coloring of G , a contradiction. \square

Lemma 16. *The graph G does not contain C_2 .*

Proof. Suppose that G contains C_2 . By minimality of G , $G - \{u_1, u_2\}$ admits a $\rho(SP_5)$ -sp-coloring φ . Since u_1 is a bad vertex, it forbids at most one color from u_2 by Claims 11 and 13. If u_2 is a 2-vertex, by Property $P_{1,4}$ of $\rho(SP_5)$, it can be colored in at least 3 colors. If u_2 is a 3-bad-vertex, its neighbors (a bad vertex and two 3-worse-neighbors) forbid at most 4 colors from it by Claims 11, 12 and 13 so it can be colored in at least 6 colors. It is always possible to extend φ to a $\rho(SP_5)$ -sp-coloring of G , a contradiction. \square

Lemma 17. *The graph G does not contain C_3 .*

Proof. Suppose that G contains C_3 . By minimality of G , $G - \{u_1, u_2, u_3\}$ admits a $\rho(SP_5)$ -sp-coloring φ . By Claims 11 and 13, u_2 and u_3 each forbids at most 1 color from u_1 and v_1 forbids 6 colors from u_1 by Property $P_{1,4}$ of $\rho(SP_5)$. This means that there are at least 2 available colors for u_1 . It is always possible to extend φ to a $\rho(SP_5)$ -sp-coloring of G , a contradiction. \square

Lemma 18. *The graph G does not contain C_4 .*

Proof. Suppose that G contains C_4 . By minimality of G , $G - \{u_1, u_2, u_3, u_4\}$ admits a $\rho(SP_5)$ -sp-coloring φ . By vertex-transitivity of $\rho(SP_5)$, we can assume w.l.o.g. that $\varphi(v_2) = 0$, and since $\rho(SP_5)$ is antiautomorphic, we can also assume that $s_G(v_2 u_2) = +1$. With respect to v_2 , there are only four available colors for u_2 which are $A = \{1, \bar{2}, \bar{3}, 4\}$. By Claims 11 and 13, u_1 forbids at most 1 color f from u_2 .

It is easy to see that $|N^+(A \setminus f)| = |N^-(A \setminus f)| \geq 8$. Therefore, u_2 forbids at most 2 colors from u_3 . Vertex u_4 forbids at most one color from u_3 by Claim 11, and v_3 forbids 6 colors from u_3 by Property $P_{1,4}$ of $\rho(SP_5)$. Hence u_3 can be colored in at least one color. It is always possible to extend φ to a $\rho(SP_5)$ -sp-coloring of G , a contradiction. \square

Lemma 19. *The graph G does not contain C_5 .*

Proof. Suppose that G contains C_5 . By minimality of G , $G - \{u_1, u_2, u_3, u_4\}$ admits a $\rho(SP_5)$ -sp-coloring φ . By Claims 11, u_2, u_3 and u_4 each forbids at most 1 color from u_1 and v_1 forbids 6 colors from u_2 by Property $P_{1,4}$ of $\rho(SP_5)$. This means that there is at least 1 color available for u_1 . It is always possible to extend φ to a $\rho(SP_5)$ -sp-coloring of G , a contradiction. \square

4.2 Discharging

We start by the definition of the initial weighting ω defined by $\omega(v) = d(v) - \frac{20}{7}$ for each vertex v of degree $d(v)$. By construction, the sum of all the weights $\sum_{v \in V(G)} \omega(v)$ is negative since the maximum average degree of G (and therefore its average degree) is strictly smaller than $\frac{20}{7}$.

We then introduce the following discharging rules:

(R_1) Every 3^+ -vertex gives $\frac{3}{7}$ to each of its 2-neighbors.

(R_2) Every 3-good, 3-bad or 4^+ -vertex gives $\frac{1}{7}$ to each of its 3-worse-neighbors.

(R_3) Every 3-good or 4^+ -vertex gives $\frac{1}{7}$ to each of its 3-bad-neighbors.

This section is devoted to obtaining a contradiction by proving that every vertex of G has non-negative final weight after the discharging procedure. We distinguish several cases for the vertices, depending on their degree. Remember that G cannot contain configurations C_0 to C_5 by Lemmas 14 to 19. Note that since G cannot contain C_0 and C_1 , the minimum degree of G is 2.

2-vertices. Let v be a 2-vertex. Since G cannot contain C_2 , it does not have any 2-neighbors so it has two 3-worse or 4^+ -neighbors and it receives $\frac{3}{7}$ from each by R_1 . Therefore, the final weight of v is $\omega'(v) = 2 - \frac{20}{7} + 2 \cdot \frac{3}{7} = 0$.

3-worse-vertices. Let v be a 3-worse-vertex. Since it is 3-worse, it has one 2-neighbor (but not more since G cannot contain C_3) to which it has to give $\frac{3}{7}$. Its other two neighbors are 3-good or 4^+ -vertices (they cannot be 3-worse or 3-bad since G cannot contain C_3 and C_4) that each gives $\frac{1}{7}$ to it by R_2 . Therefore, the final weight of v is $\omega'(v) = 3 - \frac{20}{7} - \frac{3}{7} + 2 \cdot \frac{1}{7} = 0$.

3-bad-vertices. Let v be a 3-bad-vertex. Since it is 3-bad, it has two 3-worse-neighbors (but not more since G cannot contain C_3) to each of which it has to give $\frac{1}{7}$ by R_2 . Its other neighbor is a 3-good or 4^+ -vertex (it cannot be a 2-vertex or a 3-bad-vertex since G cannot contain C_3 and C_2) that gives $\frac{1}{7}$ to it by R_3 . Therefore, the final weight of v is $\omega'(v) = 3 - \frac{20}{7} - 2 \cdot \frac{1}{7} + \frac{1}{7} = 0$.

3-good-vertices. Let v be a 3-good-vertex. Since it is 3-good, it cannot be 3-bad or 3-worse so it cannot have a 2-neighbor or two 3-worse-neighbor. It can also not have two 3-bad-neighbors since G cannot contain C_3 .

If it has one 3-worse-neighbor, it cannot have a 3-bad-neighbor because G cannot contain C_4 so it only has to give $\frac{1}{7}$ to the 3-worse-neighbor by R_2 . Therefore, the final weight of v is $\omega'(v) = 3 - \frac{20}{7} - \frac{1}{7} = 0$.

If it has one 3-bad-neighbor, it cannot have a 3-worse-neighbor since G cannot contain C_4 so it only has to give $\frac{1}{7}$ to the 3-bad-neighbor by R_3 . Therefore, the final weight of v is $\omega'(v) = 3 - \frac{20}{7} - \frac{1}{7} = 0$.

4-vertices. Let v be a 4-vertex. Since G cannot contain C_5 , it has at most two 2-neighbors.

If it has two 2-neighbors and two 3-worse or 3-bad vertices it has final weight $\omega'(v) = 4 - \frac{20}{7} - 2 \cdot \frac{3}{7} - 2 \cdot \frac{1}{7} = 0$ by R_1, R_2 and R_3 .

If it has one 2-neighbor and three 3-worse or 3-bad vertices it has final weight $\omega'(v) = 4 - \frac{20}{7} - 1 \cdot \frac{3}{7} - 3 \cdot \frac{1}{7} = \frac{2}{7}$ by R_1, R_2 and R_3 .

If it has zero 2-neighbors and four 3-worse or 3-bad vertices it has final weight $\omega'(v) = 4 - \frac{20}{7} - 4 \cdot \frac{1}{7} = \frac{4}{7}$ by R_2 and R_3 .

5⁺-vertices. Let v be an n -vertex with $n \geq 5$. In the worst case, v has n 2-neighbors to each of which he has to give $\frac{3}{7}$ by R_1 . Therefore, v has final weight at least $n - \frac{20}{7} - n \cdot \frac{3}{7}$ which is greater than or equal to 0 for $n \geq 5$.

Every vertex has non-negative weight after discharging so G cannot have maximum average degree smaller than $\frac{20}{7}$. This gives us a contradiction and concludes the proof.

5 Proof of Theorem 9

In this section, we prove that any signed graph of maximum average degree less than $\frac{17}{5}$ admit a $\rho(SP_9^+)$ -sp-coloring. To do so, we suppose that this theorem is false and we consider in the remainder of this section a minimal counter-example G w.r.t its order: it is a smallest signed graph with $\text{mad}(G) < \frac{17}{5}$ admitting no $\rho(SP_9^+)$ -sp-coloring.

We first introduce some notation in order to simplify the statements of configurations and rules.

We say that a vertex v is *bad* if:

- v has degree 4 and has one 2-neighbor.
- v has degree 6 and has four 2-neighbors.

If a 4⁺-vertex is not bad, we say that it is *good*.

5.1 Forbidden configurations

We define several configurations C_0, \dots, C_8 as follows (see Figure 7).

- C_0 is a 0-vertex.
- C_1 is a 1-vertex.
- C_2 is a 2-vertex adjacent to another 2-vertex.
- C_3 is a 2-vertex adjacent to a 3-vertex.
- C_4 is a 2-vertex adjacent to two adjacent vertices.
- C_5 is a 3-vertex.
- C_6 is a vertex u adjacent to t 2-vertices, b bad vertices and no good vertices with $t + 4 \cdot b < 20$ and $b \leq 2$ or $t < 3$ and $b = 3$.
- C_7 is a vertex u adjacent to t 2-vertices, b bad vertices and one good vertex with $t + 4 \cdot b < 9$.
- C_8 is a vertex u adjacent to t 2-vertices, 0 bad vertices and two good vertices with $t < 4$.

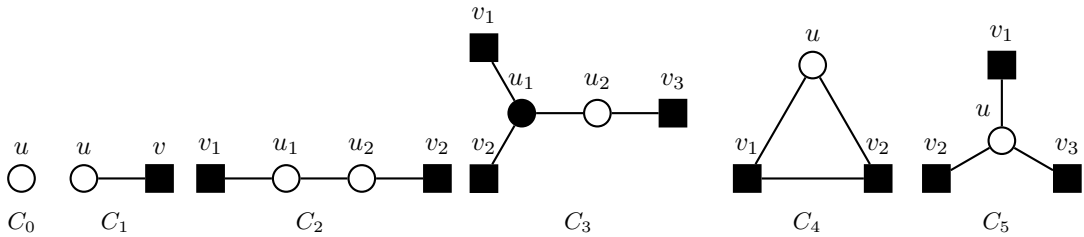

Figure 7: Forbidden configurations C_0 to C_5 . Square vertices can be of any degree. White vertices will be removed to show that the configuration is forbidden.

In this section, we prove that configurations C_0 to C_8 are forbidden. To this end, we first prove some generic results we use to prove that the configurations are forbidden. Remember that $\rho(SP_9^+)$ is vertex-transitive, antiautomorphic and has Properties $P_{1,9}$, $P_{2,4}$ and $P_{3,1}$ by Lemma 6.

We say that G is a minimal counter-example if it has the fewest number of 3^+ -vertices and the fewest number of 2^- -vertices among all the counter-examples that have the same amount of 3^+ -vertices. This will allow us to prove that Configuration C_5 is forbidden.

Given a graph H and a homomorphism from H to $\rho(SP_9^+)$, we say that two vertices of H have the same identity if they are colored with the same color or colors that are antitwins in $\rho(SP_9^+)$. Since SP_9^+ has 10 vertices, there are 10 different identities in $\rho(SP_9^+)$. If a vertex v is adjacent to n colored vertices with pairwise different identities, these n colors form a clique in $\rho(SP_9^+)$. If $2 \leq n \leq 3$ we can use Property $P_{2,4}$ or $P_{3,1}$ to color v by Lemma 7.

Lemma 20. *The graph G does not contain Configuration C_0 .*

Proof. Suppose that G contains C_0 , a vertex u of degree 0. By minimality of G , $G - u$ admits a $\rho(SP_9^+)$ -coloring φ . Vertex u can be mapped to any vertex of $\rho(SP_9^+)$ to extend φ to a $\rho(SP_9^+)$ -coloring of G , a contradiction. \square

Lemma 21. *The graph G does not contain Configuration C_1 .*

Proof. Suppose that G contains C_1 , a vertex u of degree 1. By minimality of G , $G - u$ admits a $\rho(SP_9^+)$ -coloring φ . By Property $P_{1,9}$ of $\rho(SP_9^+)$, there are at least 9 vertices that u can be mapped to in order to extend φ to a $\rho(SP_9^+)$ -coloring of G , a contradiction. \square

Lemma 22. *The graph G does not contain Configuration C_2 .*

Proof. Suppose that G contains C_2 . By minimality of G , $G - \{u_1, u_2\}$ admits a $\rho(SP_9^+)$ -coloring φ . By Property $P_{1,9}$ of $\rho(SP_9^+)$, there are at least 9 vertices that u_1 can be mapped to in order to extend φ to a $\rho(SP_9^+)$ -coloring of $G - u_2$. One of these vertices (in fact, 8 of them) does not have the same identity as $\varphi(v_2)$. We map u_1 to this vertex. By Property $P_{2,4}$ of $\rho(SP_9^+)$ we can then color u_2 since $\varphi(u_1)$ and $\varphi(v_2)$ do not share the same identity. We have extended φ to a $\rho(SP_9^+)$ -coloring of G , a contradiction. \square

Lemma 23. *The graph G does not contain Configuration C_3 .*

Proof. Suppose that G contains C_3 . By minimality of G , $G - \{u_2\}$ admits a $\rho(SP_9^+)$ -coloring φ . By Property $P_{2,4}$ of $\rho(SP_9^+)$, there are at least 4 vertices that u_1 can be remapped to (including the one it is already mapped to in φ). These vertices cannot be antitwins so at least three of them do not have the same identity as $\varphi(v_3)$. We map u_1 to one of these three vertices. By Property $P_{2,4}$ of $\rho(SP_9^+)$ we can then color u_2 since $\varphi(u_1)$ and $\varphi(v_3)$ do not share the same identity. We have extended φ to a $\rho(SP_9^+)$ -coloring of G , a contradiction. \square

Lemma 24. *The graph G does not contain Configuration C_4 .*

Proof. Suppose that G contains C_4 . By minimality of G , $G - \{u\}$ admits a $\rho(SP_9^+)$ -coloring φ . Since v_1 and v_2 are adjacent, $\varphi(v_1)$ and $\varphi(v_2)$ are also adjacent in $\rho(SP_9^+)$. We can therefore use Property $P_{2,4}$ of $\rho(SP_9^+)$ to extend φ to a $\rho(SP_9^+)$ -coloring of G , a contradiction. \square

Lemma 25. *The graph G does not contain Configuration C_5 .*

Proof. Suppose that G contains C_5 . We create a graph G' by removing u from G and adding three 2-vertices u_1 , u_2 and u_3 according to Figure 8 with $s_{G'}(v_1u_2) = s_{G'}(v_1u_3) = s_G(v_1u)$, $s_{G'}(v_2u_1) = s_{G'}(v_2u_3) = s_G(v_2u)$ and $s_{G'}(v_3u_1) = s_{G'}(v_3u_2) = s_G(v_3u)$.

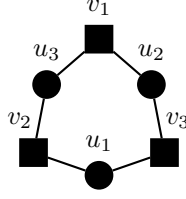

Figure 8: The graph G' of Lemma 25.

We first prove that G' is smaller than G and that $\text{mad}(G') < \frac{17}{5}$ in order to prove that G' admits a $\rho(SP_9^+)$ -coloring. Using this coloring we then show that G can be colored with $\rho(SP_9^+)$, a contradiction.

Vertices v_1 , v_2 and v_3 are 3^+ -vertices in G since Configuration C_3 forbids a 2-vertex adjacent to a 3-vertex. Hence, G' has less 3^+ -vertices than G so G' is smaller than G .

In order to prove that $\text{mad}(G') < \frac{17}{5}$, we need to show that a subgraph of G' of maximal average degree has average degree smaller than $\frac{17}{5}$. We use the fact that every subgraph of G has average degree smaller than $\frac{17}{5}$.

Suppose that a subgraph of maximal average degree does not contain u_1 , u_2 or u_3 . The same subgraph in G has the same average degree which is smaller than $\frac{17}{5}$.

Suppose that a subgraph of maximal average degree contains u_1 but not u_2 or u_3 . The same subgraph in G with u instead of u_1 has the same average degree which is smaller than $\frac{17}{5}$.

Suppose that a subgraph of maximal average degree contains u_1 and u_2 but not u_3 . We call this subgraph H' . We call H the same subgraph in G with u instead of u_1 and u_2 . The three vertices v_1 , v_2 and v_3 must be in this subgraph otherwise we would have at least one vertex of degree 0 or 1 in H' which is not possible since the same subgraph without this vertex would have a greater average degree. Note that we have: $|V(H)| = |V(H')| - 1$ and $|E(H)| = |E(H')| - 1$. The average degree of H' is $\frac{2|E(H')|}{|V(H')|}$. Suppose that this average degree is greater than or equal to $\frac{17}{5}$:

$$\begin{aligned}
\frac{2 \cdot |E(H')|}{|V(H')|} &\geq \frac{17}{5} \\
2 \cdot |E(H')| &\geq \frac{17}{5} \cdot |V(H')| \\
2 \cdot |E(H')| - 2 &\geq \frac{17}{5} \cdot |V(H')| - 2 \geq \frac{17}{5} \cdot |V(H')| - 1 \cdot \frac{17}{5} \\
2 \cdot (|E(H')| - 1) &\geq \frac{17}{5} \cdot (|V(H')| - 1) \\
2 \cdot |E(H)| &\geq \frac{17}{5} \cdot |V(H)| \\
\frac{2 \cdot |E(H)|}{|V(H)|} &\geq \frac{17}{5}
\end{aligned}$$

We have a contradiction.

We proceed in a similar manner for the case in which a subgraph of G' with maximal average degree contains u_1 , u_2 and u_3 .

If $\varphi(v_1)$, $\varphi(v_2)$ and $\varphi(v_3)$ all have different identities, we can find a color for u to extend φ to G by using Property $P_{3,1}$ of $\rho(SP_9^+)$.

If there are two vertices $\varphi(v_i)$ and $\varphi(v_j)$ that share the same identity, they can either be colored with the same color or colors that are antitwins. If they have the same color, we must have $s(v_i u) = s(v_j u)$ (because of the way we constructed G') and v_i and v_j induce the same

constraints on u . If they have colors that are antitwins, we must have $s(v_i u) = -s(v_j u)$ (because of the way we constructed G') and v_i and v_j induce the same constraints on u .

We can always extend φ to a $\rho(SP_9^+)$ -coloring of G , a contradiction. \square

Lemma 26. *The graph G does not contain Configurations C_6 .*

Proof. Suppose that G contains Configuration C_6 . Let $G' = G - u$. By minimality of G , there exists a homomorphism φ from G' to $\rho(SP_9^+)$. We want to show that we can extend φ into a homomorphism φ' from G to $\rho(SP_9^+)$. To do that, we will show that among the 20 colors that are available (i.e. the 20 vertices of $\rho(SP_9^+)$), at most $t + 4 \cdot b$ are forbidden for u by its bad-neighbors and 2-neighbors if $b \leq 2$ or at most $t + 17$ if $b = 3$.

We introduce the following two propositions that were found using a case analysis on a computer.

Proposition 27. *Given a set C of c vertices in $\rho(SP_9^+)$ there are at most f vertices that are not positive neighbors (or alternatively negative neighbors) to any of the vertices in C :*

c	0	1	2	3-4	5-6	7-11	12-20
f	20	11	6	4	2	1	0

In other words, if there are c choices of colors available for a vertex when coloring a graph with $\rho(SP_9^+)$, these c choices forbid at most f colors from a neighboring vertex.

Proposition 28. *Given a set C of 4 vertices in $\rho(SP_9^+)$ such that this set can be the result of Property $P_{2,4}$, there are at most 2 vertices that are not positive neighbors (or alternatively negative neighbors) to any of the vertices in C .*

After removing one of the 4 vertices of C , there are at most 3 vertices that are not positively adjacent (or alternatively negatively adjacent) to any of the 3 remaining vertices in C .

We now need to prove that each 2-neighbor of u forbids at most 1 color from u , each bad-neighbor of u forbids at most 4 colors from u if $b \leq 2$ and three bad neighbors forbid at most 17 colors from u .

2-neighbors: By Property $P_{1,9}$ of $\rho(SP_9^+)$, a 2-neighbor v of u can be colored in 9 colors with respect to the color of its neighbor that is not u . By Proposition 27, since v can be colored in at least 9 colors, v forbids at most 1 color from u . In other words, u can be colored in at least 19 colors such that there is at least one of the 9 colors available for v that is a positive neighbor (or alternatively a negative neighbor) in $\rho(SP_9^+)$ of that color.

bad-neighbors: Note that since Configuration C_4 is forbidden, a 2-neighbor of u cannot be adjacent to a bad-neighbor of u . We consider the following cases:

- u is adjacent to one bad-vertex v :
 - v has degree 4: By Property $P_{2,4}$ of $\rho(SP_9^+)$ and the fact that a 2-neighbor forbids 1 color, we can use Property 28 to show that v forbids at most 3 colors from u .
 - v has degree 6: By Property $P_{1,9}$ of $\rho(SP_9^+)$ and the fact that a 2-neighbor forbids 1 color, there are at least 5 colors available for v . By Property 27, v forbids at most 2 colors from u .
- u is adjacent to two bad-vertices v_1 and v_2 : Note that since Configuration C_4 is forbidden, v_1 and v_2 cannot be both adjacent and adjacent to the same 2-vertex.
 - v_1 and v_2 are neither adjacent nor adjacent to a same 2-vertex: For the same reasons as before we know that v_1 and v_2 each forbid at most 3 colors.
 - v_1 and v_2 are adjacent:

- * v_1 and v_2 are 4-vertices: By Property $P_{1,9}$ of $\rho(SP_9^+)$ and the fact that a 2-neighbor forbids 1 color, there are at least 8 colors available for both v_1 and v_2 . A case study by computer reveals that together v_1 and v_2 forbid at most 2 colors from u .
 - * v_1 and v_2 are 6-vertices: By the fact that a 2-neighbor forbids 1 color, there are at least 16 colors available for both v_1 and v_2 . This gives us less constraints than the case in which v_1 and v_2 are 4-vertices. Therefore, together v_1 and v_2 forbid at most 2 colors from u .
 - * v_1 is a 4-vertex and v_2 is a 6-vertex: By Property $P_{1,9}$ of $\rho(SP_9^+)$ and the fact that a 2-neighbor forbids 1 color, there are at least 8 colors available for v_1 and 16 for v_2 . A case study by computer reveals that together v_1 and v_2 forbid at most 2 colors from u .
- v_1 and v_2 are adjacent to the same 2-vertex:
- * v_1 and v_2 are 4-vertices: Let w be that 2-vertex, $e_1 = uv_1$, $e_2 = wv_1$, $e_3 = uv_2$ and $e_4 = wv_2$. Suppose that cycle (u, v_1, w, v_2) is balanced. By Theorem 2 we can without loss of generality switch a set of vertices such that $s(e_1) = s(e_2)$ and $s(e_3) = s(e_4)$. Therefore, v_1 (resp. v_2) create the same constraints on both u and w and it suffices to give w the same color as u . By Property $P_{2,4}$ of $\rho(SP_9^+)$ and Property 28 v_1 and v_2 each forbid at most 2 colors from u . We can thus assume that (u, v_1, w, v_2) is unbalanced. By Theorem 2 we can without loss of generality switch a set of vertices such that $s(e_2) = -s(e_4)$. Notice that if we give v_1 and v_2 different colors we can color w by Property $P_{2,4}$ of $\rho(SP_9^+)$. Let S_1 (resp. S_2) be the set of possible colors for v_1 (resp. v_2). By Property $P_{2,4}$ of $\rho(SP_9^+)$ we know that $|S_1| = |S_2| = 4$. We consider the following cases:
 - $|S_1 \cap S_2| = 0$: By Property 28, v_1 and v_2 forbid at most 4 colors from u .
 - $|S_1 \cap S_2| = 1$: We remove the common color from S_1 such that we can always apply Property $P_{2,4}$ to color w . By Property 28 v_1 and v_2 forbid at most 5 colors from u .
 - $|S_1 \cap S_2| = 2$: We remove one of the common colors from S_1 and the other from S_2 . By Property 28 v_1 and v_2 forbid at most 6 colors from u .
 - $|S_1 \cap S_2| = 3$: A case study by computer reveals that this case is not possible.
 - $|S_1 \cap S_2| = 4$: A case study by computer reveals that v_1 and v_2 forbid at most 6 colors from u .
 - * v_1 and v_2 are 6-vertices: Suppose that there is only one 2-vertex w adjacent to both v_1 and v_2 . By Property $P_{1,9}$ of $\rho(SP_9^+)$ and the fact that 2-neighbors forbid at most one color we have at least 6 colors available for v_1 and v_2 . Let S_1 and S_2 be the set of available colors for v_1 and v_2 . Notice that it is not possible for two of the colors in S_1 (resp. S_2) to be antitwins (they would need to be adjacent to a vertex in $\rho(SP_9^+)$ with the same kind of edge). Let us keep only 3 colors from S_1 and S_2 such that we do not have two colors $c_1 \in S_1$ and $c_2 \in S_2$ such that $c_1 = c_2$ or c_1 and c_2 are antitwins. Choosing any color for v_1 and v_2 now always allows us to color w by Property $P_{2,4}$. By Property 27, v_1 and v_2 each forbid at most 4 colors from u . If there are more than one 2-vertex that v_1 and v_2 are adjacent to we can still apply the same reasoning (except there will be more colors available for v_1 and v_2).
 - * v_1 is a 4-vertex and v_2 is a 6-vertex: We follow the same reasoning as before and by Property $P_{1,9}$ and $P_{2,4}$ of $\rho(SP_9^+)$ and the fact that 2-neighbors forbid at most one color we have at least 4 colors available for v_1 and 6 for v_2 . We can guarantee at least 3 distinct colors for v_1 and v_2 which means by Property 27 and 28 that they forbid at most 7 colors from u .
- u is adjacent to three bad-vertices v_1, v_2 and v_3 : By computer, we computed the following properties:

Proposition 29. *If a vertex u is adjacent to three pairwise adjacent vertices v_1, v_2 and v_3 such that v_1 can be colored in 19 colors, v_2 in 5 colors and v_3 in 4 colors then these vertices forbid at most 17 colors from u .*

Proposition 30. *If a vertex u is adjacent to two adjacent vertices v_1 and v_2 such that v_1 can be colored in 7 colors and v_2 in 5 colors then these vertices forbid at most 13 colors from u .*

Proposition 31. *If a vertex u is adjacent to adjacent vertices v_1 and v_2 such that v_1 can be colored in 7 colors and v_2 in the same 7 colors then these vertices forbid at most 11 colors from u .*

We have 20 cases to consider since v_1, v_2 and v_3 can be of degree 4 or 6 and each pair can either be adjacent, adjacent to the same 2-vertex (or vertices) or neither of those since Configuration C_4 is forbidden. The following pictures represent these 20 cases. Note that we do not need to consider cases in which a v_i is not adjacent nor adjacent to the same 2-vertex as another of the bad vertices. In such a case we can consider v_i and the other two bad vertices independently using the same reasoning we used when u is adjacent to only one or two bad vertices to show that in total v_1, v_2 and v_3 forbid at most 17 colors from u . In the picture, the number inside the vertex corresponds to its degree and the number above the vertex corresponds to the number of available colors by Property $P_{1,9}$ or $P_{2,4}$ of $\rho(SP_9^+)$ and the fact that 2-neighbors forbid at most one color. Dashed lines represent two vertices that are adjacent to the same 2-vertex. The vertex on the left is v_1 , in the middle v_2 and on the right v_3 . We denote by S_1, S_2 and S_3 the sets of colors available for v_1, v_2 and v_3 respectively.

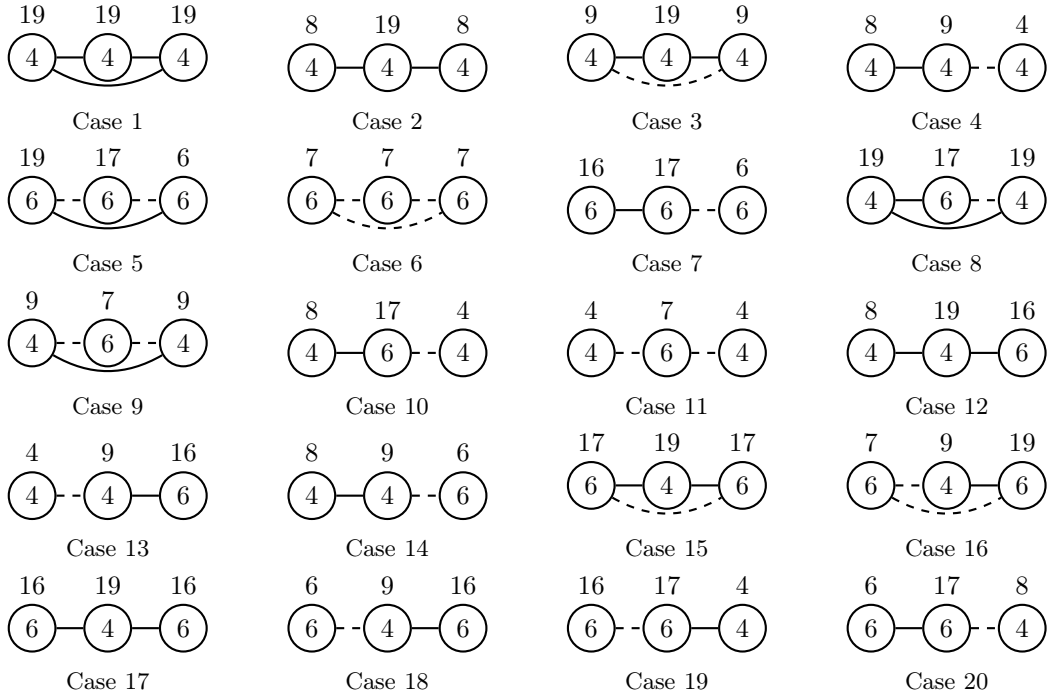

- Case 1: We can use Proposition 29 to show that the three vertices forbid at most 17 colors from u .
- Case 2: We can use Proposition 29 since having one less edge gives us less constraints.
- Case 3: Notice that it is more restrictive for two vertices u and v to be adjacent rather than to be adjacent to the same 2-vertex. This comes from the fact that the 2-vertex

can be colored using Property $P_{2,4}$ as long as u and v get different identities (which is already a requirement when u and v are adjacent). We can therefore use Proposition 29. If there are more than one 2-vertex that u and v are both adjacent to we can still use this technique (and u and v have more available colors). In the following cases we can therefore assume that there is at most one 2-vertex adjacent to a given pair of bad vertices.

- Case 4: Note that the colors in S_2 all have different identities since they are all adjacent to the same vertex in $\rho(SP_9^+)$. By removing at most 4 of the colors from S_2 , we can guarantee that any color chosen for v_2 will not have the same identity as one of the colors available for v_3 . By Proposition 30, v_1 and v_2 forbid at most 13 colors and by Proposition 28 v_3 forbids at most 2 colors.
- Case 5: We use Proposition 29.
- Case 6: By removing at most 4 colors from S_1 and 2 colors from S_2 and S_3 we can guarantee that no colors in these three sets have the same identity. By Proposition 27, the three vertices forbid at most $6 + 6 + 4 = 16$.
- Case 7: We remove 3 colors from S_3 . By removing at most 9 colors from S_2 we can guarantee that no color in S_2 has the same identity as a color in S_3 . By Proposition 30, v_1 and v_2 forbid at most 13 colors and by Proposition 27 v_3 forbids at most 4 colors.
- Case 8: We use Proposition 29.
- Case 9: Suppose that the 7 identities in S_2 are all in S_1 and S_3 . We remove 2 colors from v_1 and v_3 and 5 colors from v_2 such that $S_1 = S_3$ and no color in S_1 has the same identity as a color in S_2 . Vertices v_1 and v_2 forbid at most 11 colors by Proposition 31 and by Proposition 27 v_3 forbids at most 6 colors. We can now assume that there is at least one identity in S_2 that is not in S_1 (or alternatively S_3). Therefore, by removing at most 2 vertices from S_1 , 4 from S_2 and 3 from S_3 we can guarantee that there are no colors in S_2 that have the same identity as a color in S_1 or S_3 . By Proposition 30, v_1 and v_3 forbid at most 13 colors and by Proposition 27 v_2 forbids at most 4 colors.
- Case 10: We proceed similarly to Case 7.
- Case 11: We remove 1 color from S_1 and S_3 and 6 from S_2 such that there are no colors in S_2 that have the same identity as a color in S_1 or S_3 . By Property $P_{1,9}$ of $\rho(SP_9^+)$, v_2 forbids at most 11 colors and by Property 28 v_1 and v_3 each forbid at most 3 colors.
- Case 12: We use Proposition 29.
- Case 13: We proceed similarly to Case 4.
- Case 14: We proceed similarly to Case 4.
- Case 15: We use Proposition 29.
- Case 16: We use Proposition 29.
- Case 17: We use Proposition 29.
- Case 18: We proceed similarly to Case 5.
- Case 19: We proceed similarly to Case 5.
- Case 20: We proceed similarly to Case 5.

□

Lemma 32. *The graph G does not contain Configurations C_7 or C_8 .*

Proof. We proceed in the same way as Configuration C_6 except there are at the start only 9 (resp. 4) colors available for u by Property $P_{1,9}$ (resp. $P_{2,4}$) of $\rho(SP_9^+)$. □

5.2 Discharging

We start by the definition of the initial weighting ω defined by $\omega(v) = d(v) - \frac{17}{5}$ for each vertex v of degree $d(v)$. By construction, the sum of all the weights is negative.

We then introduce two discharging rules:

(R_1) Every 4^+ -vertex gives $\frac{7}{10}$ to each of its 2-neighbors.

(R_2) Every 4^+ good vertex gives $\frac{1}{10}$ to each of its bad neighbors.

This section is devoted to obtaining a contradiction by proving that every vertex of G has non-negative final weights after the discharging procedure. We distinguish several cases for the vertices, depending on their degree. First note that since G cannot contain C_0 and C_1 , the minimum degree of G is 2 and G does not contain 3-vertices by C_5 .

5.2.1 2-vertices

Let v be a 2-vertex. Since C_2 and C_5 are forbidden, v only has 4^+ -neighbors. Thus, by R_1 , each of them gives $\frac{7}{10}$ to v . Therefore, the final weight of v is $\omega'(v) = 2 - \frac{17}{5} + 2 \cdot \frac{7}{10} = 0$.

5.2.2 vertices of degree d , $4 \leq d \leq 11$

We checked on a computer with the following algorithm that for every vertex v with b bad neighbours, t 2-neighbors and n other neighbors then either v is in a forbidden configurations or v has final weight at least 0 after discharging.

```

for  $degree \in \{4, 5, \dots, 11\}$  do
  for  $t, b, n \in \mathbb{N}$  such that  $t + b + n = degree$  do
    if  $n = 0$  and  $e + 4 \cdot b < 20$  and  $b \leq 2$  then
      | continue (forbidden configuration  $C_6$ )
    else if  $n = 0$  and  $t + 17 < 20$  and  $b = 3$  then
      | continue (forbidden configuration  $C_6$ )
    else if  $n = 1$  and  $t + 4 \cdot b < 9$  and  $b \leq 2$  then
      | continue (forbidden configuration  $C_7$ )
    else if  $n = 2$  and  $t < 4$  and  $b = 0$  then
      | continue (forbidden configuration  $C_8$ )
    else if  $v$  is bad then
      | if  $degree - \frac{17}{5} + (n) * \frac{1}{10} - e * \frac{7}{10}$  then
        | | continue (final weight at least 0)
      | else
        | | error (final weight smaller than 0)
      | end
    else
      | if  $degree - \frac{17}{5} - t * \frac{7}{10} - b * \frac{1}{10} \geq 0$  then
        | | continue (final weight at least 0)
      | else
        | | error (final weight smaller than 0)
      | end
    end
  end
end

```

Algorithm: Algorithm used to check that each vertex of degree between 4 and 11 has final weight at least 0 after discharging.

5.2.3 12^+ -vertices

Let v be a vertex of degree d at least 12. In the worse case, v has d 2-neighbors. Therefore, it has weight at least $d - \frac{17}{5} - d \cdot \frac{7}{10}$ which is greater than or equal to 0 for $d \geq 12$.

Every vertex has non-negative weight after discharging so G cannot have maximum average degree smaller than $\frac{17}{5}$. This gives us a contradiction and concludes the proof.

6 Proof of Theorem 10

In this section, for $q \geq 9$, we prove that any signed graph of maximum average degree less than $4 - \frac{8}{q+3}$ admit a $\rho(SP_q^+)$ -sp-coloring. To do so, we suppose that this theorem is false and we consider in the remainder of this section a minimal counter-example G w.r.t its order: it is a smallest signed graph with $\text{mad}(G) < 4 - \frac{8}{q+3}$ admitting no $\rho(SP_q^+)$ -sp-coloring.

6.1 Forbidden configurations

We define several configurations C_1, \dots, C_9 as follows (see Figure 10).

- C_0 is a 0-vertex.
- C_1 is a 1-vertex.
- C_2 is two adjacent 2-vertices.
- C_3 is a 2-vertex with a 3-neighbor.
- C_4 is a 3-vertex.
- C_5 is a d -vertex adjacent to at most d 2-neighbors with $d < 2q + 2$.
- C_6 is a d -vertex adjacent to at most $d - 1$ 2-neighbors with $d < q + 1$.
- C_7 is a d -vertex adjacent to at most $d - 2$ 2-neighbors with $d < \frac{q+3}{2}$.
- C_8 is a d -vertex adjacent to at most $d - 3$ 2-neighbors with $d < \frac{q+7}{4}$.

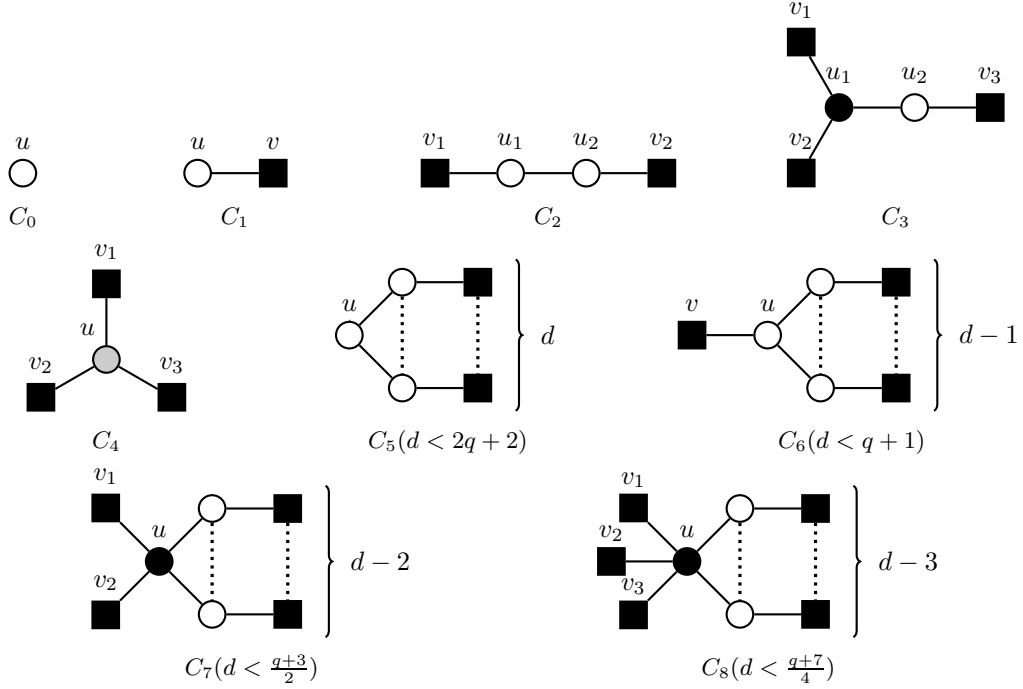

Figure 10: Forbidden configurations. Square vertices can be of any degree. White vertices will be removed. Triangle vertices are 2-, 5-worse or 6-bad-vertices.

We prove that configurations C_0 to C_8 are forbidden. To this end, we first prove some generic results we use to prove that the configurations are forbidden. Remember that $\rho(SP_q^+)$ is vertex-transitive, antiautomorphic and has Properties $P_{1,q}$, $P_{2,\frac{q-1}{2}}$ and $P_{3,\frac{q-5}{4}}$ by Lemma 7.

Lemma 33. *The graph G does not contain Configuration C_0 to C_4 .*

Proof. The target graph $\rho(SP_q^+)$ is vertex-transitive, antiautomorphic and has Properties $P_{1,q}$, $P_{2,\frac{q-1}{2}}$ and $P_{3,\frac{q-5}{4}}$ by Lemma 7. Since $q \geq 9$, it has at least Properties $P_{1,9}$, $P_{2,4}$ and $P_{3,1}$ which are the same properties has $\rho(SP_9^+)$ (see Lemma 6). Therefore, Configurations C_0 to C_4 are forbidden by Lemmas 20, 21, 22, 23, and 25. \square

Since $\rho(SP_q^+)$ has better properties than $\rho(SP_5^+)$ since $q \geq 9$, we will apply Claim 11 in the proofs of this section.

Lemma 34. *The graph G does not contain Configuration C_5 .*

Proof. Suppose that G contains configuration C_5 . By minimality of G , the graph obtained from G by removing u and its 2-neighbors admits a $\rho(SP_q^+)$ -sp-coloring φ . Every 2-neighbor of u forbids at most 1 color from u by Claim 11. Since there are $2q + 2$ colors in G , we can find always find a color for u to extend φ to a $\rho(SP_q^+)$ -sp-coloring of G , a contradiction. \square

Lemma 35. *The graph G does not contain Configuration C_6 .*

Proof. Suppose that G contains configuration C_6 . By minimality of G , the graph obtained from G by removing u and its 2-neighbors admits a $\rho(SP_q^+)$ -sp-coloring φ . By Property $P_{1,q}$, we have q available colors for u . Every 2-neighbor of u forbids at most 1 color from u by Claim 11. We can therefore always find a color for u to extend φ to a $\rho(SP_q^+)$ -sp-coloring of G , a contradiction. \square

Lemma 36. *The graph G does not contain Configuration C_7 .*

Proof. Suppose that G contains configuration C_7 . By minimality of G , the graph obtained from G by removing the 2-neighbors of u admits a $\rho(SP_q^+)$ -sp-coloring φ . By Property $P_{2, \frac{q-1}{2}}$, u can be recolored in $\frac{q-1}{2}$ distinct colors such that there is no conflict with $\varphi(v_1)$ and $\varphi(v_2)$. Every 2-neighbor of u forbids at most 1 color from u by Claim 11. We can therefore always find a color for u to extend φ to a $\rho(SP_q^+)$ -sp-coloring of G , a contradiction. \square

Lemma 37. *The graph G does not contain Configuration C_8 .*

Proof. Suppose that G contains configuration C_8 . By minimality of G , the graph obtained from G by removing the 2-neighbors of u admits a $\rho(SP_q^+)$ -coloring φ . By Property $P_{3, \frac{q-5}{4}}$, u can be recolored in $\frac{q-5}{4}$ colors such that there is no conflict with $\varphi(v_1)$, $\varphi(v_2)$ and $\varphi(v_3)$. Every 2-neighbor of u forbids at most 1 color from u by Claim 11. We can therefore always find a color for u to extend φ to a $\rho(SP_q^+)$ -sp-coloring of G , a contradiction. \square

6.2 Discharging

Let ω be the initial weighting defined by $\omega(v) = d(v) - 4 + \frac{8}{q+3}$ for each vertex v of degree $d(v)$. By construction, the sum of all the weights is negative since $\text{mad}(G) < 4 - \frac{8}{q+3}$.

We introduce the following discharging rule:

(R) Every 4^+ -vertex gives $\frac{q-1}{q+3}$ to each of its neighbors of degree 2.

This section is devoted to obtaining a contradiction by proving that every vertex of G has non-negative final weights after the discharging procedure. We distinguish several cases for the vertices, depending on their degree. First note that since G cannot contain C_0 , C_1 and C_4 , G contains no 0, 1 or 3-vertex.

2-vertices. Let v be a 2-vertex. Since C_2 is forbidden, v only has 4^+ -neighbors. Thus, each of them gives $\frac{q-1}{q+3}$ to v . Therefore, the final weight of v is $2 - \left(4 - \frac{8}{q+3}\right) + 2 \cdot \frac{q-1}{q+3} = 0$.

d -vertices with $4 \leq d < \frac{q+7}{4}$. Let v be such a d -vertex. Since C_8 is forbidden, v has at most $d-4$ 2-neighbors. Therefore, in the worst case, v has final weight at least $d - \left(4 - \frac{8}{q+3}\right) - (d-4) \cdot \frac{q-1}{q+3} \geq 4 - \left(4 - \frac{8}{q+3}\right) > 0$.

d -vertices with $\frac{q+7}{4} \leq d < \frac{q+3}{2}$. Let v be such a d -vertex. Since C_7 is forbidden, v has at most $d-3$ 2-neighbors. Therefore, in the worst case, v has final weight at least $d - \left(4 - \frac{8}{q+3}\right) - (d-3) \cdot \frac{q-1}{q+3} \geq \frac{q+7}{4} - \left(4 - \frac{8}{q+3}\right) - \left(\frac{q+7}{4} - 3\right) \cdot \frac{q-1}{q+3} = 0$.

d -vertices with $\frac{q+3}{2} \leq d < q+1$. Let v be such a d -vertex. Since C_6 is forbidden, v has at most $d-2$ 2-neighbors. Therefore, in the worst case, v has final weight at least $d - \left(4 - \frac{8}{q+3}\right) - (d-2) \cdot \frac{q-1}{q+3} \geq \frac{q+3}{2} - \left(4 - \frac{8}{q+3}\right) - \left(\frac{q+3}{2} - 2\right) \cdot \frac{q-1}{q+3} = 0$.

d -vertices with $q+1 \leq d < 2q+2$. Let v be such a d -vertex. Since C_5 is forbidden, v has at most $d-1$ 2-neighbors. Therefore, in the worst case, v has final weight at least $d - \left(4 - \frac{8}{q+3}\right) - (d-1) \cdot \frac{q-1}{q+3} \geq q+1 - \left(4 - \frac{8}{q+3}\right) - (q+1-1) \cdot \frac{q-1}{q+3} > 0$.

d -vertices with $2q + 2 \leq d$. Let v be such a d -vertex. Vertex v has at most d 2-neighbors. Therefore, in the worst case, v has final weight at least $d - \left(4 - \frac{8}{q+3}\right) - d \cdot \frac{q-1}{q+3} \geq 2q + 2 - \left(4 - \frac{8}{q+3}\right) - (2q + 2) \cdot \frac{q-1}{q+3} > 0$.

Every vertex has non-negative weight after discharging so G cannot have maximum average degree smaller than $4 - \frac{8}{q+3}$. This gives us a contradiction and concludes the proof.

Acknowledgments

The authors would like to thank F. Dross, M. Montassier, T. Pierron, M. Senhaji, A. Raspaud and Z. Wang for fruitful conversations at the 2019 HoSiGra meeting.

References

- [1] J. Bensmail, S. Das, S. Nandi, T. Pierron, S. Sen, and É. Sopena. On the signed chromatic number of some classes of graphs. *arXiv:2009.12059*, 2020.
- [2] Julien Bensmail, Soumen Nandi, Mithun Roy, and Sagnik Sen. Classification of edge-critical underlying absolute planar cliques for signed graphs. *The Australasian Journal of Combinatorics*, 77(1):117–135, 2020.
- [3] O. V. Borodin. Colorings of plane graphs: A survey. *Discrete Mathematics*, 313(4):517 – 539, 2013.
- [4] O. V. Borodin, S. J. Kim, A. V. Kostochka, and D. B. West. Homomorphisms from sparse graphs with large girth. *J. Comb. Theory Ser. B*, 90(1):147–159, 2004.
- [5] R. C. Brewster and T. Graves. Edge-switching homomorphisms of edge-coloured graphs. *Discrete Mathematics*, 309(18):5540 – 5546, 2009.
- [6] D. W. Cranston and D. B. West. An introduction to the discharging method via graph coloring. *Discrete Mathematics*, 340(4):766 – 793, 2017.
- [7] Christopher Duffy, Fabien Jacques, Mickael Montassier, and Alexandre Pinlou. The chromatic number of 2-edge-colored and signed graphs of bounded maximum degree. *arXiv:2009.05439*, 2021.
- [8] B. Guenin. Packing odd circuit covers: a conjecture. Manuscript, 2005.
- [9] Fabien Jacques. On the chromatic numbers of signed triangular and hexagonal grids. *arXiv:2012.09678*, 2020.
- [10] A. Montejano, P. Ochem, A. Pinlou, A. Raspaud, and É. Sopena. Homomorphisms of 2-edge-colored graphs. *Discrete Applied Mathematics*, 158(12):1365–1379, 2010.
- [11] R. Naserasr, E. Rollová, and É. Sopena. Homomorphisms of Signed Graphs. *Journal of Graph Theory*, 79(3):178–212, 2015.
- [12] R. Naserasr, É. Sopena, and T. Zaslavsky. Homomorphisms of signed graphs: An update. *European Journal of Combinatorics*, 91:103222, 2021.
- [13] J. Nešetřil and A. Raspaud. Colored homomorphisms of colored mixed graphs. *J. Comb. Theory Ser. B*, 80(1):147–155, 2000.
- [14] P. Ochem, A. Pinlou, and S. Sen. Homomorphisms of 2-edge-colored triangle-free planar graphs. *Journal of Graph Theory*, 85(1):258–277, 2017.

- [15] P. Wernicke. Über den kartographischen vierfarbensatz. *Mathematische Annalen*, 58(3):413–426, 1904.
- [16] T. Zaslavsky. Signed graphs. *Discrete Applied Mathematics*, 4(1):47 – 74, 1982.
- [17] C. Charpentier, R. Naserasr, É. Sopena Homomorphisms of sparse signed graphs *The Electronic Journal of Combinatorics*, 27(3):P3-6, 2020.