



Implementing Admittance Relaying for Microgrid Protection

Arthur K. Barnes¹  *Member, IEEE* and Adam Mate¹  *Member, IEEE*

Abstract—The rapid increase of distributed energy resources has led to the widespread deployment of microgrids. These flexible and efficient local energy grids are able to operate in both grid-connected mode and islanded mode; they are interfaced to the main power system by a fast semiconductor switch and commonly make use of inverter-interfaced generation. This paper focuses on inverter interfaced microgrids, which present a challenge for protection as they do not provide the high short-circuit current necessary for conventional time-overcurrent protection. The application of admittance relaying for the protection of inverter-interfaced microgrids is investigated as a potential solution. The comparison of analytical and simulated results of performed four experiments prove the suitability of admittance relaying for microgrids protection.

Index Terms—power system operation, admittance relaying, microgrid, distribution network, protection.

I. INTRODUCTION

In their recent paper, McDermott et al. [1] evaluated issues with microgrid protection. They highlighted the underlying difficulties, which include the lack of fault current from inverter-interfaced generation [2], the varying fault current between grid-connected and islanded modes [2], the potential for normally-meshed operation [3] and unbalanced operation due to single-phase loads [3]. A handful of possible solutions (with some severe limitations) have been proposed for these challenges over the years. Dewadasa et al. [3], [4] identified admittance protection for load protection; however, there is a potential for loss of protection selectivity in the case of upstream line-ground faults [1]. Kar et al. [5] identified differential protection based on the discrete S-transform for line protection; however, there is a potential for blinding the protection when fault contribution on either end of the line is similar [1]. Barnes et al. [6] identified dynamic state estimation for the protection of radial portions of microgrids; however, there is a potential for sensitivity to initial conditions, particularly at the delta-connected load models. Nevertheless, it is worth noting that not all microgrid designs present these above discussed challenges; for example, microgrids could choose to omit meshed operation.

This paper investigates the application of admittance relaying for the protection of inverter-interfaced microgrids. Section II describes the relevant background of admittance and pilot protection as solutions for line and load protection, in addition to describing the protection schemes analyzed and

the behavior of inverter-interfaced microgrids under faults. Section III derives sequence networks for the fault cases considered. Section IV presents the transient model constructed to validate the impedances calculated from the sequence networks. Section V compares analytical and simulated results from the sequence networks and transient model. Finally, Section VI summarizes the conclusions of this paper in terms of the suitability of admittance relaying for microgrid protection.

II. BACKGROUND

A. Admittance Protection

For protection, the same quantities are used as that of Dewadasa [3], [4], [7], where line-ground faults are detected by:

$$Z_{lg}^1 = \frac{V_{ar}}{I_{ar} + kI_{ar}^0}$$

and line-line faults are detected by:

$$Z_{ll}^1 = \frac{V_{cr} - V_{br}}{I_{br} - I_{cr}}$$

where Z_{lg}^1 and Z_{ll}^1 are the measured positive-sequence impedances (measured by the phase and ground distance relaying); V_{ar} , V_{br} , and V_{cr} are the measured phase-ground voltages; I_{ar} , I_{br} , and I_{cr} are the measured phase currents; and k is related to the ratio of positive- and negative-sequence line impedance:

$$k = 1 - \frac{Z^0}{Z^1}$$

Both Z_{lg}^1 and Z_{ll}^1 measure the positive-sequence impedance between the relay and the fault, which allows them to accurately measure the distance to the fault for practical lines of sufficient length with mutual impedance between conductors.

Admittance protection on its own is suitable for load bus protection. For line protection, as line lengths are low in microgrids, it may be necessary to use pilot protection. This means that the likelihood of protection erroneously determining if a fault is in- or out-of-zone is high [7].

B. Pilot Protection

The recommended pilot protection scheme is directional comparison blocking (abbr. DCB). Typically in this scheme, a line is protected by two directional distance relays on either end for line-line faults and directional overcurrent relays for line-ground faults [7]–[9]. A schematic for one such relay in oneline diagram from Fig. 1 is illustrated in Fig. 2. For inverter-interfaced microgrid protection, as it is not possible to rely on the presence of fault currents, it is necessary to use ground distance relaying instead of overcurrent relaying [2].

DCB operates with a bidirectional channel along the line by which each relay can send a blocking signal preventing the

Manuscript submitted: December 14, 2020.

¹ The authors are with the Advanced Network Science Initiative at Los Alamos National Laboratory, Los Alamos, NM 87544 USA. Email: {abarnes, amate}@lanl.gov.

Color versions of one or more of the figures in this paper are available online at <https://ieeexplore.ieee.org>.

LANL ANSI LA-UR-20-30128.

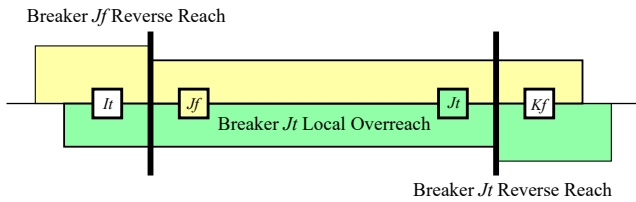

Fig. 1. Oneline diagram for a DCB scheme.

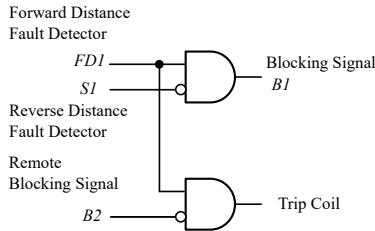

Fig. 2. Schematic for one relay in a DCB scheme.

other from operating. An important feature of this scheme is that the channel is only transmitting if a relay detects a fault and is actively sending the blocking signal. The scheme is therefore biased towards dependability in that the breakers on either end of the line can operate if the communication channel is inoperable. If a relay's directional element detects that the fault is external, it will send a blocking signal to the relay on the other end of the line to prevent it from operating. DCB is therefore suitable for transmission line taps or radial portions of a microgrid where the relay on the receiving end of the line may not experience fault current, causing an unblocking scheme could fail to operate.

C. Inverter-Interfaced Microgrids

Generation with inverter front-ends in microgrids is expected to supply single-phase loads in addition to balanced three-phase loads. Proportional-resonant (abbr. PR) controllers offer better performance during unbalanced operation and in the presence of load harmonics compared to proportional-integral (abbr. PI) controllers in a rotating reference frame (e.g., DQ0) [10], [11]. PR controllers can operate in a stationary reference frame that can either be the raw "A, B, C" coordinates or the " α, β " coordinates produced by the Clarke transformation [10]. In case the inverter supplies a four-wire system, an additional controller for the " γ " coordinate, corresponding to zero-sequence quantities, is necessary [12]; therefore it may be preferable to remain in "A, B, C" coordinates. In this paper, a three-phase inverter with no neutral connection is selected and a delta-grounded wye transformer provides a source for zero-sequence current.

A major distinction between inverter-based generation and rotating machinery is that the thermal time-constants for power electronic semiconductor modules are very low, consequently inverters are unable to supply fault current for the amount of time it takes for conventional protection to clear a fault. Two main options are available for protecting inverters from overheating during faults: instantaneous saturation and latching current limiters [12]. In an inverter with an inner current loop

and outer voltage or power loop, such as that described in [11], the current limiters operate on the output of the voltage loop, which acts as a reference to the current loop. In instantaneous saturation, the current reference is simply bounded within an allowable range; this introduces considerable voltage harmonics into the system, which can complicate protection. Latched current limiters avoid harmonic injection during faults, but can introduce a current discontinuity when switching the current controller reference from the voltage controller output to the limited current signal [12].

III. EQUIVALENT SEQUENCE NETWORKS

The system considered is a two bus microgrid, illustrated in Fig. 3; the system parameters are presented later in Section IV. Six cases are considered for deriving sequence networks:

- 1) Line-ground fault for an ideal voltage source with an upstream relay.
- 2) Line-ground fault for a current-limiting inverter with an upstream relay.
- 3) Line-ground fault with a downstream relay.
- 4) Line-line fault for an ideal voltage source with an upstream relay.
- 5) Line-line fault for a current-limiting inverter with an upstream relay.
- 6) Line-line fault with a downstream relay.

It is shown that the impedance calculations for downstream relays are not affected by choice of an ideal voltage source or a current-limiting inverter.

A. Line-Ground Midpoint Faults

1) Ideal Voltage Source and Upstream Relay

To analyze the behavior of the considered microgrid during faults, it is necessary to create the Thevenin equivalent circuit of the system from the perspective of the protective relaying. The first step is to draw out the relevant portions with all conductors depicted, as seen in Fig. 4; note that the microgrid inverter and the delta winding of the transformer are not illustrated. As mentioned earlier, the microgrid uses an inverter with a three-phase H-bridge connected to a delta-wye transformer with a grounded wye. Rather than using three H-bridges to provide neutral currents (as in [3]), this system relies on the transformer grounding to do so.

Fig. 5 illustrates the equivalent sequence networks of the microgrid for the case of a midpoint line-ground fault and ideal voltage source. The current flowing into the fault is identical for each circuit: $I_f^1 = I_f^2 = I_f^0 = I_f/3$. This means that the sequence equivalent circuits can be linked in series.

For the positive-sequence network, the Thevenin equivalent impedance:

$$Z_{eq1} = Z_{1M}^1 || (Z_{M2}^1 + Z_L)$$

where $||$ denotes the equivalent impedance of parallel circuit elements:

$$Z_x || Z_y = \frac{Z_x Z_y}{Z_x + Z_y}$$

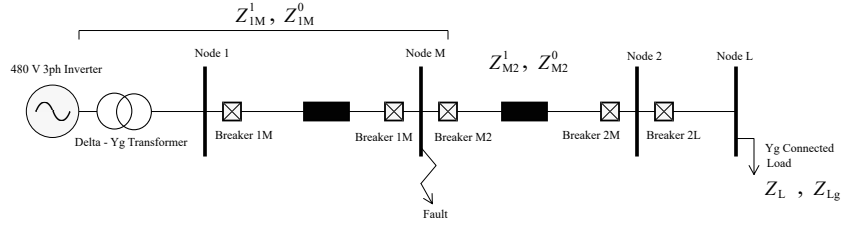

Fig. 3. Oneline diagram for the considered two bus microgrid system.

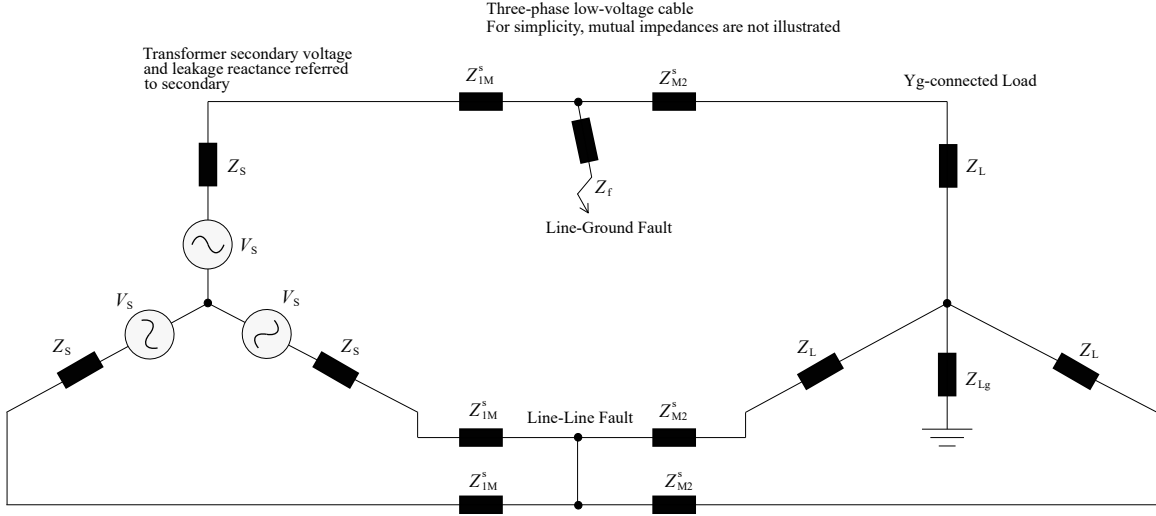
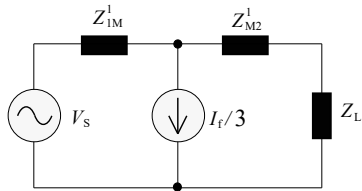
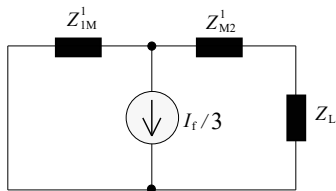

Fig. 4. Thevenin equivalent circuit of the microgrid.



(a) Equivalent positive-sequence network



(b) Equivalent negative-sequence network

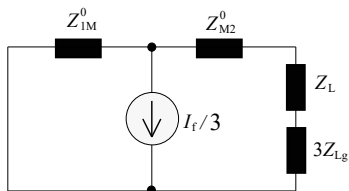

(c) Equivalent zero-sequence network

Fig. 5. Sequence networks for a midpoint line-ground fault with an ideal voltage source.

The Thevenin equivalent voltage:

$$V_{eq1} = V_S \cdot \frac{Z_{M2}^1 + Z_L}{Z_{1M}^1 + (Z_{M2}^1 + Z_L)}$$

For the negative-sequence network, the Thevenin equivalent impedance is the same as Z_{eq1} :

$$Z_{eq2} = Z_{eq1} = Z_{1M}^1 || (Z_{M2}^1 + Z_L).$$

Last, for the zero-sequence network, the Thevenin equivalent impedance:

$$Z_{eq0} = Z_{1M}^0 || (Z_{M2}^0 + Z_L + 3Z_{Lg}).$$

This set of interconnected sequence networks can be simplified, as illustrated in Fig. 6.

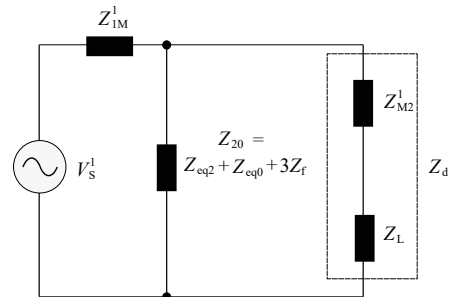

Fig. 6. Simplified sequence network for a midpoint line-ground fault with an ideal voltage source.

Given a protective relay at the load bus, the current flowing through the relay can be determined by calculating the current

flowing through the relay in the positive-, negative-, and zero-sequence networks.

First, the impedance of the positive-sequence network downstream of the relay:

$$Z_d = Z_{M2}^1 + Z_L$$

Next, the equivalent impedance of the negative-sequence network, zero-sequence network, and fault:

$$Z_{20} = Z_{eq2} + Z_{eq0} + 3Z_f$$

therefore the equivalent impedance downstream of the relay:

$$Z_{20d} = Z_{20} || Z_d$$

The measured positive-sequence current at the relay:

$$I_r^1 = \frac{V_s^1}{Z_{1M} + Z_{20d}}$$

To calculate the negative- and zero-sequence currents through the relay, the first step is to calculate the Norton equivalent of the voltage source:

$$I_{sn} = \frac{V_s^1}{Z_{1M}^1}$$

The equivalent impedance of the upstream and downstream portions of the positive-sequence network in parallel:

$$Z_{1d} = Z_{1M}^1 || Z_d$$

which produces the simplified Norton equivalent circuit, illustrated in Fig. 7.

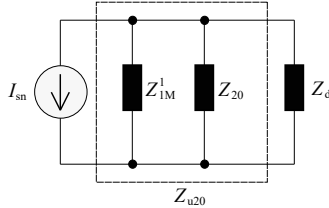

Fig. 7. Norton equivalent circuit for a midpoint line-ground fault with an ideal voltage source.

Using a current divider and assuming that $Z_{1M}^1 \ll Z_L$, the negative- and zero-sequence current flowing through the relay:

$$I_r^2 = I_r^0 = I_{sn} \frac{Z_{1d}}{Z_{20} + Z_{1d}}$$

therefore the measured phase A current at the relay:

$$I_r^a = I_r^1 + I_r^2 + I_r^0$$

and the voltage at the relay:

$$V_r^a = V_s^1 - Z_{1M} I_r^1 + Z_{1M}^1 I_r^2 + Z_{1M}^0 I_r^0$$

finally, the positive-sequence impedance can be calculated as:

$$Z_r^1 = \frac{V_r^{ag}}{I_r^a}$$

The measured positive-sequence impedance at the relay, as fault current varies, is illustrated in Fig. 8 (the fault resistance is varied from 3.68 $[\Omega]$ to 1 $[k\Omega]$ and the lower bound is selected for a fault current twice that of the load current).

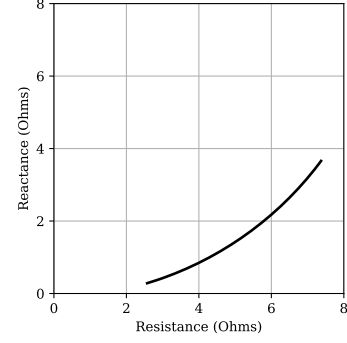

Fig. 8. Measured positive-sequence impedance at an upstream relay for a midpoint line-ground fault with an ideal voltage source.

2) Current-Limiting Inverter and Upstream Relay

The current-limiting inverter is modeled as an unbalanced voltage source for the simplicity of calculation (as opposed to voltage sources on the unfaulted phases and current sources on the faulted phases) [3]. This results in voltage sources present on each of the sequence networks. The values of the inverter negative- and zero-sequence voltages are determined by simulation (described in Section IV) and are calculated to be roughly 60% of the positive-sequence voltage. The simplified sequence network is illustrated in Fig. 9.

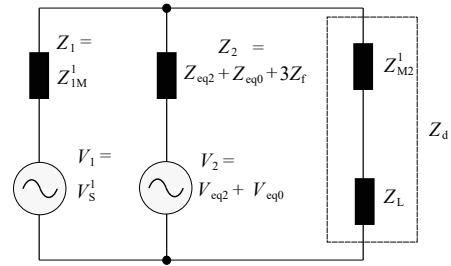

Fig. 9. Simplified sequence network for a midpoint line-ground fault with a current-limiting inverter.

The current through the relay can be calculated given:

$$\begin{aligned} V_1 &= V_s^1 & Z_1 &= Z_{1M}^1 \\ V_2 &= V_{eq2} + V_{eq0} & Z_2 &= Z_{eq2} + Z_{eq0} + 3Z_f \\ & & Z_d &= Z_{M2}^1 + Z_L \end{aligned}$$

Using parallel branch combinations:

$$Z_{1d} = Z_1 || Z_d \quad Z_{2d} = Z_2 || Z_d$$

and Norton equivalent sources:

$$I_{1n} = \frac{V_1}{Z_1} \quad I_{2n} = \frac{V_2}{Z_2}$$

the positive- and negative-sequence currents through the relay are calculated as follows:

First, the negative- and zero-sequence voltage sources are disabled. The positive-sequence current, resulting from the positive-sequence voltage source, measured flowing through the relay:

$$I_{11} = \frac{V_1}{Z_1 + Z_{2d}}$$

Second, the Norton equivalent circuit (illustrated in Fig. 10), with the negative- and zero-sequence voltage sources disabled, is used. The negative-sequence current, resulting from the positive-sequence voltage source, flowing through the relay:

$$I_{21} \approx I_{1n} \frac{Z_{1d}}{Z_2 + Z_{1d}}$$

assuming that $Z_{1M}^1 \ll Z_d$

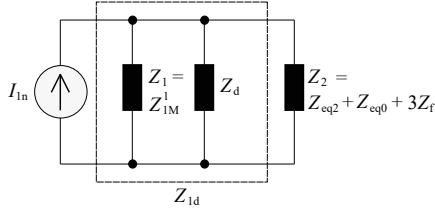

Fig. 10. Norton equivalent circuit for a line-ground fault, supplied by a current-limiting inverter, with the negative-sequence and zero-sequence voltage sources disabled.

Third, the Norton equivalent circuit (illustrated in Fig. 11), with the positive-sequence voltage source disabled, is used. The positive-sequence current, from the contributions of the negative- and zero-sequence voltage sources, flowing through the relay:

$$I_{12} = I_{2n} \frac{Z_{2d}}{Z_1 + Z_{2d}}$$

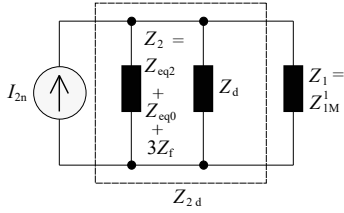

Fig. 11. Norton equivalent circuit for a line-ground fault, supplied by a current-limiting inverter, with positive-sequence voltage source disabled.

Finally, the negative-sequence current contribution from the negative- and zero-sequence sources can be calculated:

$$I_{22} \approx \frac{V_2}{Z_2 + Z_{1d}}$$

again assuming that $Z_{1M}^1 \ll Z_L$

The measured current running through the relay:

$$\begin{aligned} I_r^1 &= I_{11} + I_{12} \\ I_r^2 &= I_{21} + I_{22} \\ I_r^0 &= I_r^2 \\ I_r^a &= I_r^1 + I_r^2 + I_r^0 \end{aligned}$$

The measured positive-sequence impedance:

$$Z_r = \frac{V_r^{ag}}{I_r^a}$$

The measured positive-sequence impedance at the relay, as a function of the fault resistance, is illustrated in Fig. 8.

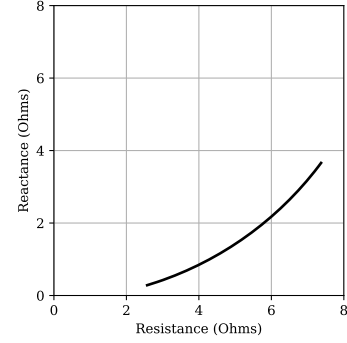

Fig. 12. Measured positive-sequence impedance at an upstream relay for a midpoint line-ground fault with a current-limiting inverter.

3) Downstream Relay

By using the definition of sequence voltages [13] and Fig. 9, the measured voltage across the relay:

$$V_r^{ag} = Z_d^1 I_r^1 + Z_d^1 I_r^1 + Z_d^0 I_r^0$$

where

$$Z_d^1 = Z_{M2}^1 + Z_L \quad Z_d^0 = Z_{M2}^0 + Z_L + 3Z_{Lg}$$

The measured impedance by the relay:

$$\begin{aligned} Z_r^1 &= \frac{V_r^{ag}}{I_r^a + kI_r^0} \\ &= \frac{Z_d^1 [I_r^1 + I_r^2 + (Z_d^0/Z_d^1)I_r^0]}{I_r^a + kI_r^0} \end{aligned}$$

It is therefore apparent that $Z_r = Z_d^1$ and relay is not going to operate for line-ground faults when $k = 1 - Z_d^0/Z_d^1$, unless it experiences load encroachment.

B. Line-Line Midpoint Faults

For line-line midpoint faults, to facilitate expressing the fault quantities analytically, the analysis assumes that the fault impedance is small (but non-zero).

1) Ideal Voltage Source and Upstream Relay

Fig. 13 illustrates the equivalent sequence networks of the microgrid for the case of a midpoint line-line fault across phases B and C. It is apparent from the figure that the currents flowing into the fault are equal in magnitude, but with opposite signs: $I_{bf} = -I_{cf}$. Furthermore, the line-ground voltages at the fault location on phases B and C are equal: $V_{bf} = V_{cf}$.

From the definition of sequence quantities, it can be shown that $V_{af}^1 = V_{af}^2$ and $I_{af}^1 = -I_{af}^2$. This implies that the positive- and negative-sequence networks are connected in parallel via the fault, while the zero-sequence network is isolated from the other two (as shown in Fig. 13). Given that there is no source of zero-sequence voltage, there is no zero-sequence current flowing through the system for this fault type.

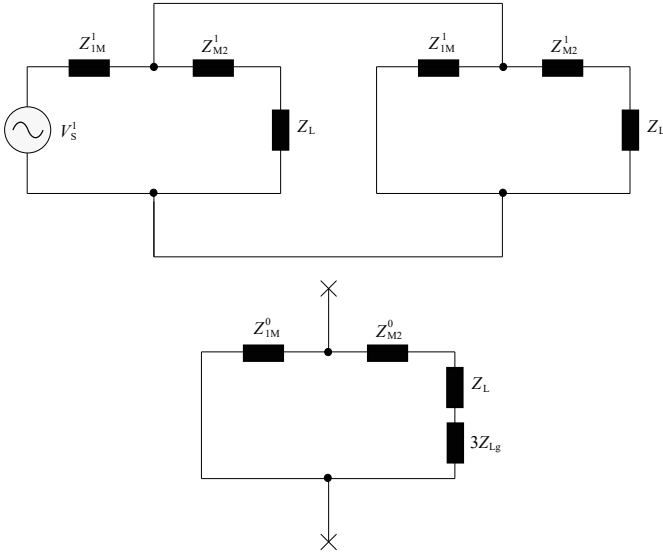

Fig. 13. Sequence networks for a midpoint line-line fault with an ideal voltage source.

The connected positive- and negative-sequence networks can be simplified, as illustrated in Fig. 14. As is the case for the line-ground fault, the upstream impedance is $Z_1 = Z_{1M}^1$, the downstream impedance is $Z_d = Z_{2M}^1 + Z_L$, and the shunt impedance from the negative-sequence network is $Z_2 = Z_{eq2}$, where Z_{eq2} is the same as defined in Section III-A-1.

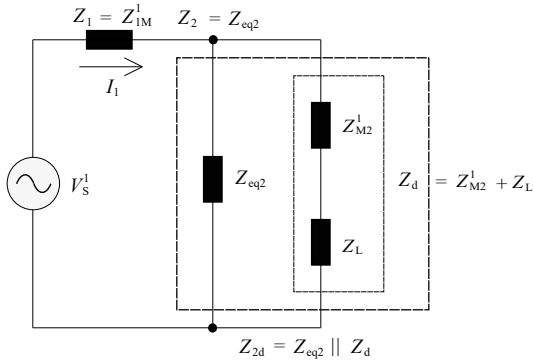

Fig. 14. Simplified sequence network for a midpoint line-line fault with an ideal voltage source.

The equivalent downstream impedance from the relay:

$$Z_{1d} = Z_1 || Z_d \quad Z_{2d} = Z_2 || Z_d$$

The positive-sequence current, as a consequence of a line-line fault, flowing through the relay:

$$I_{ar}^1 = \frac{V_s}{Z_1 + Z_{2d}}$$

The negative-sequence current flowing through the relay is $I_r^2 \approx I_r^1$ for $Z_{1M}^1 \ll Z_L$. The measured impedance by the relay:

$$Z_r = \frac{V_{br} - V_{cr}}{I_{br} - I_{cr}} = \frac{V_{ar}^2 - V_{ar}^1}{I_{ar}^1 + I_{ar}^2}$$

For an upstream relay, where the difference $V_{br} - V_{cr}$ is very small while I_{br} and I_{cr} are not, the measured fault impedance is near zero.

2) Current-Limiting Inverter and Upstream Relay

In case a current-limiting inverter is used, although the zero-sequence network remains isolated, the inverter now provides zero-sequence voltage; consequently, this network can no longer be neglected in the fault analysis. To calculate the measured fault impedance, first the interconnection of sequence networks needs to be simplified (illustrated in Fig. 15).

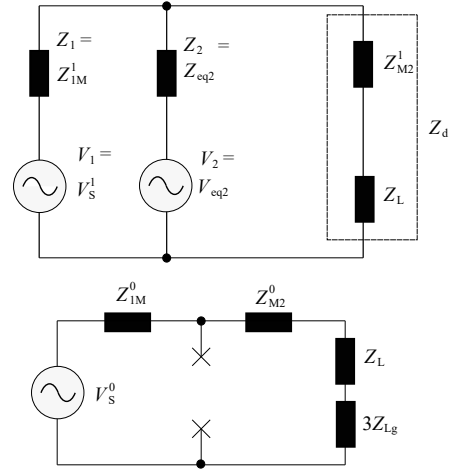

Fig. 15. Simplified sequence network for a midpoint line-line fault with a current-limiting inverter.

First, similarly to Section III-A-2, the negative-sequence voltage source is disabled. The positive-sequence current, resulting from the positive-sequence voltage source, measured through the relay:

$$I_{11} = \frac{V_1}{Z_1 + Z_{2d}}$$

Second, the Norton equivalent circuit (illustrated in Fig. 16), with the negative-sequence voltage source disabled, is used. The negative-sequence current, resulting from the positive-sequence voltage source, flowing through the relay:

$$I_{21} \approx I_{1n} \frac{Z_{1d}}{Z_{1d} + Z_2}$$

assuming that $Z_{1M}^1 \ll Z_L$.

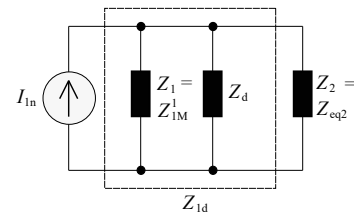

Fig. 16. Norton equivalent circuit for a line-line fault, supplied by a current-limiting inverter, with the negative-sequence voltage source disabled.

Third, the positive-sequence voltage source is disabled. The negative-sequence current flowing through the relay:

$$I_{22} \approx \frac{V_2}{Z_2 + Z_{1d}} \quad (1)$$

assuming $Z_{1M}^1 \ll Z_L$

Finally, the Norton equivalent circuit (illustrated in Fig. 17), with the negative-sequence voltage source disabled, is used. The positive-sequence current, from the negative-sequence voltage source, flowing through the relay:

$$I_{12} \approx I_{2n}$$

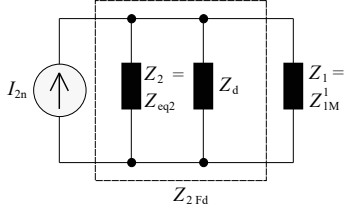

Fig. 17. Norton equivalent circuit for line-line fault, supplied by a current-limiting inverter, with positive-sequence voltage source disabled.

The measured impedance can be calculated similarly to Section III-A-2; as with the ideal voltage source, it is near zero for negligible fault impedance.

3) Downstream Relay

By using the definition of sequence voltages [13] and Fig. 14, the measured impedance by the relay:

$$\begin{aligned} Z_r &= \frac{V_r^b - V_r^c}{I_r^b - I_r^c} = \frac{(\alpha^2 - \alpha)V_{ar^1} + (\alpha - \alpha^2)V_{ar}^2}{(\alpha^2 - \alpha)I_{ar^1} + (\alpha - \alpha^2)I_{ar}^2} \\ &= \frac{(\alpha^2 + \alpha)(V_{ar^1} - V_{ar}^2)}{(\alpha^2 + \alpha)(I_{ar^1} - I_{ar}^2)} = \frac{V_{ar^1} - V_{ar}^2}{I_{ar^1} - I_{ar}^2} \end{aligned}$$

Substituting in the downstream impedances:

$$Z_d^1 = Z_{M2}^1 + Z_L \quad Z_d^0 = Z_{M2}^1 + Z_L + 3Z_{Lg}$$

the measured impedance can be simplified:

$$Z_r = \frac{Z_d^1 I_{ar}^1 - Z_d^1 I_{ar}^2}{I_{ar}^1 - I_{ar}^2} = \frac{Z_d^1 (I_{ar}^1 - I_{ar}^2)}{I_{ar}^1 - I_{ar}^2} = Z_d^1$$

This relies on quantities V_{br} , V_{cr} , I_{br} , and I_{cr} being nonzero, which is the case for a practical fault with nonzero fault impedance.

IV. TRANSIENT MODEL

To validate the above calculated impedances, produced from the equivalent sequence networks, the considered two bus microgrid system is modeled in the MATLAB/Simulink® SimScape multi-physics simulation environment, using the Specialized Power Systems library. This model is based on the design of an inverter using a PR controller [10] presented in [11].

The microgrid is illustrated in Figs. 18 – 20, while the system parameters are listed in Tables I – IV.

TABLE I
GLOBAL PARAMETERS

Name	Symbol	Value	Unit
Grid frequency	f_0	60	Hz
Line-line voltage	V	480	V

TABLE II
SYNCHRONOUS GENERATOR PARAMETERS

Subsystem	Symbol	Value
Voltage loop	kpv	0.35
Voltage loop	krv	400
Voltage loop	kvh5	4
Voltage loop	kvh7	20
Voltage loop	kvh11	11
Current loop	kpi	0.7
Current loop	kri	400
Current loop	kih5	30
Current loop	kih7	30
Current loop	kih11	30

TABLE III
INVERTER CONTROLLER PARAMETERS

Subsystem	Symbol	Value
Voltage loop	kpv	0.35
Voltage loop	krv	400
Voltage loop	kvh5	4
Voltage loop	kvh7	20
Voltage loop	kvh11	11
Current loop	kpi	0.7
Current loop	kri	400
Current loop	kih5	30
Current loop	kih7	30
Current loop	kih11	30

TABLE IV
HARDWARE PARAMETERS

Name	Symbol	Value	Unit
Inverter rated power	P	50	kW
DC-bus voltage	Vdc	1800	V
Output filter inductance	L	18	μ F
Output filter capacitance	C	250	nF
Maximum rms output current	Imax	70	A
Cable resistance	Rc	39	m Ω
Cable inductance	Lc	70.8	μ H
Load real power	Pd	25	kW
Load reactive power	Qd	12.5	kW

V. RESULTS

Fig. 21 presents the simulation results for the four cases considered: (a) line-ground fault with an upstream ground distance relay, (b) line-ground fault with a downstream ground distance relay, (c) line-line fault with an upstream phase distance relay, and (d) line-line fault with a downstream phase distance relay. For these cases, only the current-limiting inverter is considered and the ideal voltage source case is not modeled.

Figs. 21a and 21c illustrate that for both upstream relay cases, the measured impedance varies over time from the load resistance towards the origin, while remaining in the first quadrant. Figs. 12 and 21a highlight the correspondence between the predicted and measured impedances. Fig. 21c confirms that the measured impedance for a relay upstream of a line-line fault is near zero. Figs. 21b and 21d proves that the measured impedance for downstream relays is approximately the load impedance in both cases.

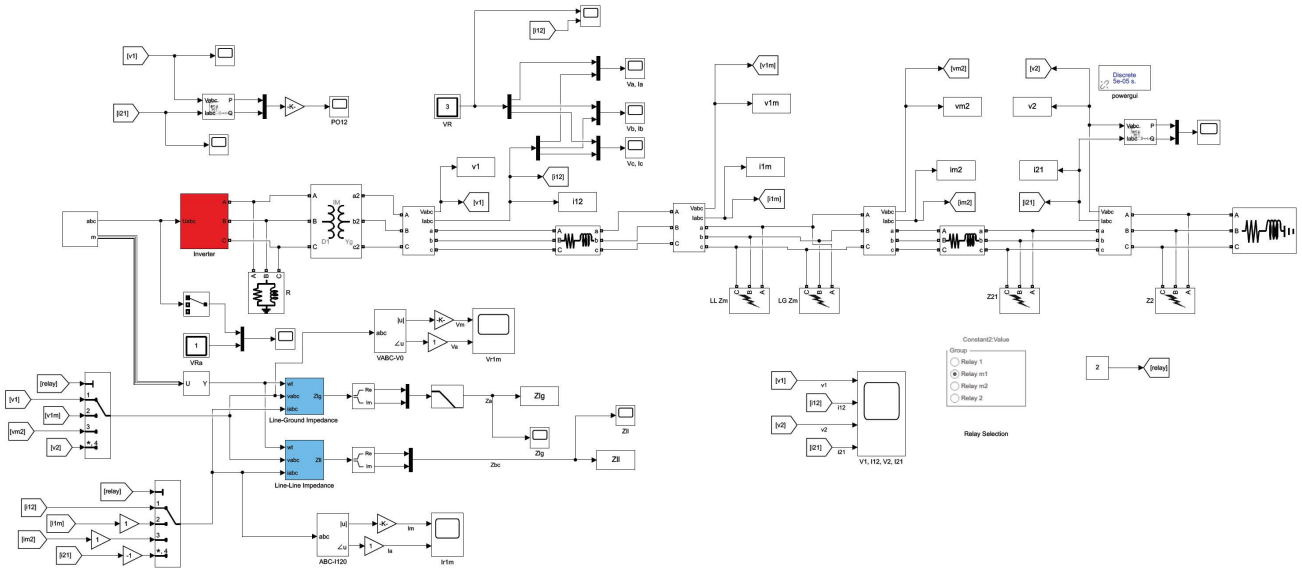

Fig. 18. Transient microgrid model.

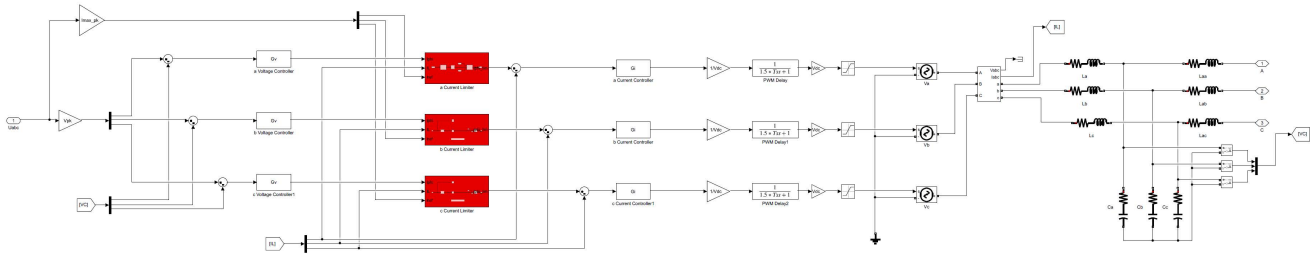

Fig. 19. Transient inverter model.

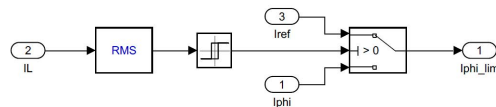

Fig. 20. Transient current limiter model.

VI. CONCLUSIONS

Both the analytical and simulation results suggest that conventional relaying quantities for phase and ground distance protection are suitable for the protection of both lines and load buses in inverter-interfaced microgrids. Although the case studies of this paper used midpoint faults, the measured quantities change only a small amount for load bus faults as $Z_{1M}^1 \ll Z_L$. For the case of line protection, it is likely that pilot protection is necessary rather than relying on zone-based distance protection. The low line impedances of microgrids make it likely that other impedances (e.g., inverter virtual impedance, load impedance, fault impedance) dominate, rendering it difficult to distinguish in- or out-of-zone faults based purely on measured impedance.

The results do not support the observations of Dewadasa et al. [3], [4] on protection misoperations for an upstream line-ground fault when a grounded-wye load is present. While

the performed case studies were not able to determine why Dewadasa observed misoperations, from Fig. 5c it is apparent that an inverter lacking a grounding source, causing Z_{1M}^0 to be open-circuited, could result in downstream ground overcurrent protection without directional relaying to trip. Inspection of Fig.5b confirms the claim of [3] that negative-sequence current is suitable for use as a polarizing quantity for directional relaying in line-ground faults.

REFERENCES

- [1] T. McDermott, B. Vyakaranam, R. Fan, P. T. Mana, T. Smith, Z. Li, J. Hambrick, and A. K. Barnes. Protective Relaying for Distribution and Microgrids Evolving from Radial to Bi-Directional Power Flow. In *Proceedings of the 2018 Western Protective Relay Conference*, Oct. 2018.
- [2] R. M. Tumilty, M. Brucoli, G. M. Burt, and T. C. Green. Approaches to Network Protection for Inverter Dominated Electrical Distribution Systems. In *Proceedings of the 3rd IET International Conference on Power Electronics, Machines and Drives*, 2006, pages 622–626, Apr. 2006.

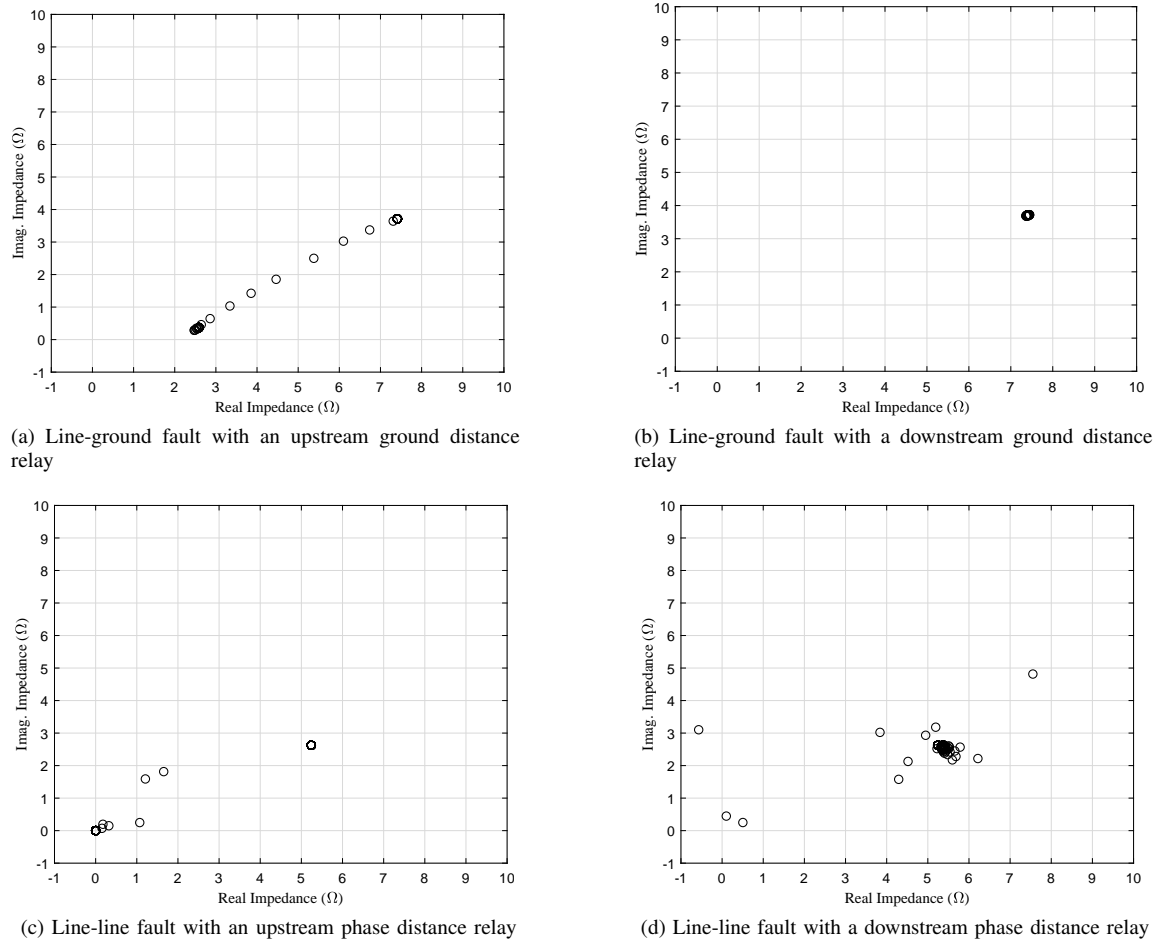

Fig. 21. Measured impedances on different faults with different distance relays for the four cases considered.

- [3] J. M. Dewadasa, A. Ghosh, and G. Ledwich. Line Protection in Inverter Supplied Networks. In *Proceedings of the 2008 Australasian Universities Power Engineering Conference*, pages 1–6, Dec. 2008.
- [4] J. M. Dewadasa, A. Ghosh, and G. Ledwich. Distance Protection Solution for a Converter Controlled Microgrid. In *Proceedings of the 15th National Power Systems Conference*, 2008.
- [5] S. Kar and S. R. Samantaray. Time-Frequency Transform-Based Differential Scheme for Microgrid Protection. *IEEE IET Generation, Transmission & Distribution*, 8(2):310–320, Feb. 2014.
- [6] A. K. Barnes and A. Mate. Dynamic State Estimation for Radial Microgrid Protection. In *Proceedings of the 2021 IEEE/IAS 57th Industrial and Commercial Power Systems Technical Conference*, pages 1–9, Apr. 2021.
- [7] J. L. Blackburn. *Protective Relaying Principles and Applications*. Taylor & Francis, 3rd edition edition, 2007.
- [8] S. Tamronglak. *Analysis of Power System Disturbances due to Relay Hidden Failures*. PhD thesis, Virginia Polytechnic Institute and State University, Apr. 1994.
- [9] D. C. Elizondo. *A Methodology to Assess and Rank the Effects of Hidden Failures in Protection Schemes based on Regions of Vulnerability and Index of Severity*. PhD thesis, Virginia Polytechnic Institute and State University, Apr. 2003.
- [10] R. Teodorescu, F. Blaabjerg, and M. Liserre. Proportional-Resonant Controllers. A New Breed of Controllers Suitable for Grid-Connected Voltage-Source Converters. *Journal of Electrical Engineering*, pages 1–6, 2003.
- [11] J. C. Vasquez, J. M. Guerrero, M. Savaghebi, J. Eloy-Garcia, and R. Teodorescu. Modeling, Analysis, and Design of Stationary-Reference-Frame Droop-Controlled Parallel Three-Phase Voltage Source Inverters. *IEEE Transactions on Industrial Electronics*, 60(4), Apr. 2013.
- [12] N. Bottrell and T. C. Green. Comparison of Current-Limiting Strategies During Fault Ride-Through of Inverters to Prevent Latch-Up and Wind-Up. *IEEE Transactions on Power Electronics*, 29(7):3786–3797, Jul. 2014.
- [13] A. R. Bergen and V. Vittal. *Power Systems Analysis*. Pearson Education India Publishing, 2009.