

Matter representations from geometry: under the spell of Dynkin

Mboyo Esole[◇] and Monica Jinwoo Kang^{◆◆}

[◇] Department of Mathematics, Northeastern University
Boston, MA 02115, U.S.A.

[◆] Walter Burke Institute for Theoretical Physics, California Institute of Technology
Pasadena, CA 91125, U.S.A.

[◆] Department of Physics, Korea Advanced Institute of Science and Technology
Daejeon 34141, Republic of Korea

Abstract

In the traditional Katz–Vafa method, matter representations are determined by decomposing the adjoint representation of a parent simple Lie algebra \mathfrak{m} as the direct sum of irreducible representations of a semisimple subalgebra \mathfrak{g} . The Katz–Vafa method becomes ambiguous as soon as \mathfrak{m} contains several subalgebras isomorphic to \mathfrak{g} but giving different decompositions of the adjoint representation. We propose a selection rule that characterizes the matter representations observed in generic constructions in F-theory and M-theory: the matter representations in generic F-theory compactifications correspond to linear equivalence classes of subalgebras $\mathfrak{g} \subset \mathfrak{m}$ with Dynkin index one along each simple components of \mathfrak{g} . This simple yet elegant selection rule allows us to apply the Katz–Vafa method to a much large class of models. We illustrate on numerous examples how this proposal streamlines the derivation of matter representations in F-theory and resolves previously ambiguous cases.

Contents

1	Introduction	3
1.1	Singleton subalgebras, Dynkin index of embeddings, and the proposal	4
1.2	Application to the birational geometry of elliptic fibrations	6
1.3	Evidence for the proposed selection rule	7
2	Preliminaries	11
2.1	Embeddings, equivalence, linear equivalence, and branching rules	12
2.2	R- and S-subalgebras	13
2.3	Normalized Killing form	13
2.4	Dynkin's index of a representation	13
2.5	Dynkin index of an embedding	15
2.6	Dynkin index of a simple Lie algebra	16
2.7	Conventions and basic data on simple Lie algebras and their representations	17
3	Curating the original Katz–Vafa cases with singleton subalgebras	23
3.1	Singleton sectors of the original Katz–Vafa cases	25
3.2	Non-singleton subalgebras among the original Katz–Vafa's cases	26
3.3	$A_1 \rightarrow A_2$	27
3.4	The $A_1 \oplus A_1 \rightarrow A_3$ case	28
3.5	$A_3 \rightarrow D_4$	28
3.6	$A_1 \oplus A_3 \rightarrow D_5$	28
3.7	$A_3 \oplus A_1 \oplus A_1 \rightarrow D_6$	29
3.8	$A_3 \oplus A_3 \rightarrow D_7$	29
4	Beyond the Katz–Vafa cases: singleton subalgebras	30
4.1	$D_4 \rightarrow E_6$	31
4.2	$A_1 \oplus D_4 \rightarrow E_7$	32
4.3	$E_6 \rightarrow E_8$	32
4.4	$A_3 \oplus D_4 \rightarrow E_8$	32
4.5	$A_1 \oplus A_1 \rightarrow D_4$	32
5	The $SU(5)$-model	33
5.1	$A_4 \rightarrow A_5, D_5$	33
5.2	$A_4 \rightarrow E_6, E_7, E_8$	34
6	G_2 and F_4-models	35
6.1	$G_2 \rightarrow B_3, D_4, D_5, E_6$	36
6.2	$F_4 \rightarrow E_6, E_7, E_8$	37
7	The $Spin(7)$-model	37
7.1	$B_3^1 \rightarrow D_4$	37
7.2	$B_3^1 \rightarrow B_4$ or B_5	37
7.3	$B_3^1 \rightarrow F_4$ or E_6	38

8	The $\mathrm{USp}(4)$-model	38
8.1	$C_2 \rightarrow A_3$	39
8.2	$C_2 \rightarrow B_3$	39
8.3	$C_2 \rightarrow C_3$	39
8.4	$C_2 \rightarrow A_4$	39
8.5	$C_2 \rightarrow D_4$	39
8.6	$C_2 \rightarrow D_5$	39
9	$A_1 \oplus A_1$: the $\mathrm{SU}(2) \times \mathrm{SU}(2)$-models	40
9.1	$A_1 \oplus A_1 \rightarrow A_3$	40
9.2	$A_1 \oplus A_1 \rightarrow C_2$	41
9.3	$A_1 \oplus A_1 \rightarrow G_2$	41
9.4	$A_1 \oplus A_1 \rightarrow B_3$	42
9.5	$A_1 \oplus A_1 \rightarrow D_4$	42
10	$A_1 \oplus A_2$: the $\mathrm{SU}(2) \times \mathrm{SU}(3)$-model	42
10.1	$A_1 \oplus A_2 \rightarrow A_5$	43
10.2	$A_1 \oplus A_2 \rightarrow D_5$	43
10.3	$A_1 \oplus A_2 \rightarrow E_6$	43
10.4	$A_1 \oplus A_2 \rightarrow E_7$	43
11	$A_1 \oplus C_2$: the $\mathrm{SU}(2) \times \mathrm{USp}(4)$-model	47
11.1	$A_1 \oplus C_2 \rightarrow D_4$	47
11.2	$A_1 \oplus C_2 \rightarrow C_3$	47
11.3	$A_1 \oplus C_2 \rightarrow C_4$	47
11.4	$A_1 \oplus C_2 \rightarrow A_5$	47
11.5	$A_1 \oplus C_2 \rightarrow D_5$	47
12	$A_1 \oplus G_2$: the $\mathrm{SU}(2) \times G_2$-model	49
12.1	$A_1 \oplus G_2 \rightarrow D_5$	49
12.2	$A_1 \oplus G_2 \rightarrow B_5$	49
12.3	$A_1 \oplus G_2 \rightarrow D_6$	49
12.4	$A_1 \oplus G_2 \rightarrow E_7$	49
12.5	$A_1 \oplus G_2 \rightarrow E_8$	50
13	$A_1 \oplus B_3$: the $\mathrm{SU}(2) \times \mathrm{Spin}(7)$-model	52
13.1	$A_1 \oplus B_3 \rightarrow E_7$	52
13.2	$A_1 \oplus B_3 \rightarrow E_8$	52
14	$A_1 \oplus D_4$: the $\mathrm{SU}(2) \times \mathrm{Spin}(8)$-model	53
14.1	$A_1 \oplus D_4 \rightarrow E_7$	53
14.2	$A_1 \oplus D_4 \rightarrow E_8$	53
15	The art of channeling	53

1 Introduction

All the known fundamental forces in theoretical physics are modeled by gauge theories. Some of the basic data of a gauge theory are its Lie group G (called the gauge group) and its Lie algebra \mathfrak{g} . A gauge theory describes local forces propagating between particles, where the force is carried by a fundamental particle that interacts with itself when the gauge group is non-Abelian. In a given gauge theory, fundamental particles transform under irreducible representations of the gauge group that we call *matter representations*. Determining matter representations of a given model in theoretical physics is a fundamental aspect of its description. Characterizing matter representations occurring in M-theory and F-theory compactifications will be the focus of this paper.

In string compactifications, matter representations are not arbitrary but are constrained by the geometry of the compactifying space, in particular, its intersection ring, its singularities, and their degenerations [59, 62, 65]. In F-theory [58, 64, 67], the compactifying space is an elliptic fibration [14]. In fact, certain weights of the matter representations are observed geometrically as intersection numbers between fibral divisors and rational curves constituting the irreducible components of singular fibers over particular loci of the discriminant locus of the elliptic fibration [2, 3, 10, 19, 23, 32, 40, 41, 44, 52, 56, 62]. However, when the gauge algebra is not simple or simply-laced, the subsets of geometrically-derived weights do not always uniquely determine a representation of the Lie algebra, as pointed out in [20, 28, 30]. In [48], Katz and Vafa propose to deduce the matter representation by considering the decomposition of the adjoint representation in an embedding $\mathfrak{g} \rightarrow \mathfrak{m}$ as

$$\text{adj } \mathfrak{m} = \text{adj } \mathfrak{g} \oplus \chi,$$

and following Dynkin [13], we call χ the *characteristic representation of \mathfrak{g} in \mathfrak{m}* . The Katz–Vafa method is beloved for its universality and computational ease, but becomes ambiguous when the Lie algebra \mathfrak{g} have distinct embeddings in \mathfrak{m} leading to distinct representations. Moreover, to explain the observed matter representation, the choice of the isomorphic class of \mathfrak{m} is not always consistent with the geometry of the elliptic fibration. This begs for a clear characterization of the matter representations appearing in M-theory or F-theory compactifications without imposing any ad hoc rule and in perfect consistency with the restriction derived from the geometry.

The cases studied in the original Katz–Vafa paper are the following embeddings between ADE Lie algebras¹:

$$\left\{ \begin{array}{lll} A_{n-k} \oplus A_{k-1} \rightarrow A_n, & D_{n-k} \oplus A_{k-1} \rightarrow D_n, & D_{n-1} \rightarrow D_n, \\ A_{n-1} \rightarrow D_n, & D_5 \rightarrow E_6, & A_5 \rightarrow E_6, \\ E_6 \rightarrow E_7, & D_6 \rightarrow E_7, & A_6 \rightarrow E_7, \\ E_7 \rightarrow E_8. \end{array} \right. \quad (1.1)$$

These original cases analyzed by Katz–Vafa have the following properties:

1. *Rank-one enhancement between ADE Lie algebra* : The Lie algebra \mathfrak{m} and $\mathfrak{g} \subset \mathfrak{m}$ are both Lie

¹As we will explain later, in the first four cases, there are subtleties for certain values of n and k that were never scrutinized before.

algebras of type ADE with \mathfrak{m} a simple Lie algebra of one rank higher than \mathfrak{g} .

2. *Levi subalgebras* : the Dynkin diagram of \mathfrak{g} is obtained from that of \mathfrak{m} by removing a single node. However, \mathfrak{g} is not necessarily a maximal subalgebra of \mathfrak{m} .
3. *Minuscule representations*: The non-trivial irreducible components of the characteristic representation χ are all minuscule representations.
4. *regular embedding*: The embedding $\mathfrak{g} \rightarrow \mathfrak{m}$ is always a regular embedding.
5. *Dynkin index one*: The Dynkin index of any irreducible component of \mathfrak{g} in \mathfrak{m} is always one.

There are many models outside of those considered in the original Katz–Vafa method that play a central role in F-theory. The geometry of these models have been studied carefully in the past few years [1, 4, 19–38, 41, 42, 46, 47, 52] and they provide valuable and explicit data that will guide us to extend and improve the Katz–Vafa method on determining matter representations. The previous analysis of these models enlightened us that there is no reason to restrict ourselves to rank one enhancements, Levi subalgebras, (quasi)-minuscule representations, or regular embeddings. For example, higher rank enhancements occur routinely in well-known F-theory constructions such as those with the following enhancements: $A_1 \rightarrow D_4$, $A_1 \oplus G_2 \rightarrow E_7$, and $A_1 \oplus C_2 \rightarrow A_5$ that are individually observed respectively in the $SU(2)$ -model [36], the $SU(2) \times G_2$ -model [28], and the $SU(2) \times USp(4)$ -model [30].

In this paper, we propose a simple (mathematical) selection rule to identify the correct matter representations in generic compactifications of M-theory and F-theory. Our approach is rooted in three fundamental ideas introduced by Dynkin in the middle of the 20th century: the notions of linear equivalence, characteristic representations, and the Dynkin embedding index of a subalgebra [11, 13, 51, 54]. We argue that the overwhelming majority of matter representations in F-theory can be identified as the ones of subalgebras $\mathfrak{g} \rightarrow \mathfrak{m}$ of Dynkin embedding index one (see definitions in Section 2). The physical origin of this restriction will be presented in a companion paper [25].

The organization of the rest of the paper is as follows. In Section 1.1, we explain the notions of singleton subalgebras, Dynkin index of embeddings and announce our selection rule for identifying the correct matter representations of M-theory and F-theory. We also give an overview of our methodology. In Section 1.3, we illustrate through explicit examples the power of this approach. In Section 2, we review basic mathematical definitions and conventions. In Section 3, we describe the relationship between the Katz–Vafa method and Dynkin’s characteristic representation and then revisit the original Katz–Vafa cases with our approach. We separate them into singleton and non-singleton cases and show how all the choices coincide with our selection rule. In the rest of the paper, we carefully analyze several cases that are well understood via crepant resolutions of singularities of Weierstrass models.

1.1 Singleton subalgebras, Dynkin index of embeddings, and the proposal

We take the following point of view inspired by the work of Dynkin [12, 13], Minchenko [54], de Graaf [11], and Lorente–Gruber [51]. A semisimple Lie algebra \mathfrak{g} can be embedded in many different ways as a subalgebra of a simple Lie algebra \mathfrak{m} . Each embedding can lead to a distinct characteristic

representation. Thus, it is important to identify an appropriate notion of equivalence of subalgebras. In his classification of semisimple subalgebras of simple Lie algebras, Dynkin has introduced two notions of equivalence of subalgebras: the equivalence and the linear equivalence. Two subalgebras are said to be conjugate or *equivalent* if they are related by an inner automorphism of the parent Lie algebra. Two subalgebras \mathfrak{g}_1 and \mathfrak{g}_2 of \mathfrak{m} are said to be *linearly equivalent* if every linear representation induces linear conjugate representations of \mathfrak{g}_1 and \mathfrak{g}_2 . Two equivalent subalgebras are always linearly equivalent but the reverse is not always true. Two linearly equivalent embeddings have the same characteristic representation and the same Dynkin index. Since our focus is on branching rules, the coarser notion – the linear equivalence – is the appropriate notion for our purpose. We revisit this in detail in Section 2.1.

Our proposal can be put succinctly as following.

Proposal 1.1 (Matter Representation Selection Rule). In generic configurations in F-theory, up to multiplicities and trivial representations, the matter representations with respect to a Lie algebra \mathfrak{g} are given by the characteristic representations of embeddings $\mathfrak{g} \rightarrow \mathfrak{m}$ having Dynkin index one along each simple components of \mathfrak{g} .

The Dynkin embedding index of a simple subalgebra \mathfrak{g} of a simple Lie algebra \mathfrak{m} was introduced by Dynkin in his classification of semisimple subalgebras of Lie algebras [13]. The Dynkin index naturally extends to the case of semisimple subalgebras of a simple Lie algebra by giving the Dynkin index of each of its simple components. We say that a semisimple Lie algebra $\mathfrak{g} = \bigoplus_i \mathfrak{g}_i$ has *Dynkin embedding index one* if each of its simple components \mathfrak{g}_i have Dynkin embedding index one in \mathfrak{m} .

By “generic configuration,” we mean those appearing from Tate’s algorithm with gauge groups supported on generic divisors. In particular, these divisors are assumed to be smooth. In algebraic geometry, a generic divisor is always smooth. Smooth divisors occur naturally in physics such as in non-Higgsable clusters. In particular, non-singular divisors can occur and produce exotic configurations that do not have to respect the proposed selection rule. We will list specific examples.

This selection rule applies to a broad collection of theories: all generic Tate’s models [5, 39], Miranda models [6, 55], and more general collisions of singularities without further assumptions [20, 28–30], even for non-simply-laced Lie algebras. We work out various examples explicitly and meticulously. This selection rule has a nontrivial predictive power, since the subalgebras of Dynkin index one is typically unique in a given isomorphism class of subalgebras \mathfrak{g} .² It provides a simple way to identify the correct matter representations in many situations that previously were only done case by case using ad hoc rules.

Our strategy can be summarized as follows.

- Subalgebras that are unique up to linear equivalence within their semisimple type are particularly nice, as there is no possible ambiguity for the choice of a matter representation since there is a unique possible reduced matter representation. We call them *singleton subalgebras*.
- The next best situation is when a subalgebra is not a singleton subalgebra, but all the non-linearly equivalent subalgebras of the same isomorphism type give the same characteristic

²There are very rare cases when it is not unique; we analyze all the various.

representation for the adjoint representation. In such a case, the matter representation is still not ambiguous. We call them *adjoint singleton subalgebras*. Any singleton subalgebra is also an adjoint singleton subalgebra, but the reverse is not true.

- When we are outside of the class of adjoint singleton subalgebras, by definition, we have several possible representations to choose from with different branching rules for the adjoint representation. In those cases, we need a criterion to identify which linear equivalent class, within a given semisimple type of subalgebra, gives the characteristic representation we expect in F-theory. We argue that in the generic case, F-theory chooses the branching rule that corresponds to a subalgebra of Dynkin index one along each of its simple factor.

With very rare exceptions listed in [15], adjoint singleton subalgebras are of Dynkin index one. A naturally question is then if there exists any situation in which adjoint singleton subalgebras of higher Dynkin index appear naturally in F-theory or string theory. It would also be interesting to know if the subalgebras of index one that are not yet used in F-theory could give rise to a special class of matter representations that might be relevant for models of which we are unaware yet. In that case, it would be important to classify all of them systematically.

We note that some subalgebras that are not of Dynkin index one do appear in exotic configurations in F-theory when the divisor supporting the gauge group has singularities [49]. In fact, they also appear in some aspects of string theory. For example, we also notice that the bosonic string compactified on the self-dual circle has a gauge enhancement with Lie algebra $A_1 \oplus A_1$ and matter in the representation $(\mathbf{3}, \mathbf{3})$ corresponding to the branching rule $A_1^2 \oplus A_1^2 \rightarrow A_3$, which we explain in Section 3.4. The characteristic representation of the subalgebra $A_1^1 \oplus A_1^2$ of D_4 matches (up to multiplicity) the matter content of the $A_1 \oplus A_1$ theory discussed in [60, Appendix A]. Moreover, in a footnote of [45, §3.3], Intriligator and Seiberg point out that in the study of spontaneous symmetry breaking in supersymmetric gauge theories, a higher Dynkin embedding index introduces subtleties in dealing with instantons. We will come back to this important point in some detail in a companion paper [25].

1.2 Application to the birational geometry of elliptic fibrations

Matter representations also have a natural application in purely geometric constructions [17, 18, 36, 37, 40, 44]. A given Weierstrass model can have several distinct crepant resolutions connected by flops. Using hints from M-theory compactifications to 5d theories [40, 44], the network of these flops can be modeled by a hyperplane arrangement $I(\mathfrak{g}, \chi)$ [17, 18, 36, 37], whose open chambers are defined by the connected components of the fundamental Weyl chamber of \mathfrak{g} after removing the hyperplanes defined by the weights of the characteristic representation χ . The coincidence graph of the chambers of the hyperplane arrangement $I(\mathfrak{g}, \chi)$ is expected to be isomorphic to the graph of crepant resolutions connected by flops. When the elliptic fibrations has several distinct matter representations in different locations, we take the direct sum of all the corresponding characteristic representations. The weights observed from the geometry by intersection numbers of curves and divisors over codimension-two points in the base are those responsible for the wall between distinct chambers. We refer to [10, 16–38, 40, 44] for explicit examples and applications.

This brings up an interesting fundamental question: given a simple Lie algebra \mathfrak{g} , which are

the subalgebras \mathfrak{m} up to linear equivalence, is it possible to determine the associated hyperplane arrangement $I(\mathfrak{g}, \chi)$ matching the flop diagram of an elliptic fibration with dual fibers corresponding to the simple components of \mathfrak{g} ? For example, as we will review in the next subsection, in the study of the G_2 -model [19], one would expect an embedding $G_2 \rightarrow E_6$. There are two subalgebras isomorphic to G_2 in E_6 , one would give $\chi = \mathbf{7}$ and the other $\chi = \mathbf{64}$. We know that the G_2 -model does not flop, which is consistent with the fact that $I(G_2, \mathbf{7})$ has only one chamber. In contrast, $I(G_2, \mathbf{64})$ has two distinct chambers and is therefore not consistent with the geometry of the G_2 -model even though all the weights observed geometrically are both weights of $\mathbf{7}$ and $\mathbf{64}$.

1.3 Evidence for the proposed selection rule

In this section, we illustrate that the evidences for the selection rule presented in Proposal 1.1 are overwhelming. Interestingly, this selection rule is useful even in cases that might sound at first non-ambiguous such as the matter content obtained when A_2 is reduced to A_1 . Our aim here is not to exhaust all possible cases but to present the main ideas through key examples. We will give a more exhaustive approach in [15].

1. The ambiguity in choosing the correct branching rule is already apparent in the original Katz–Vafa cases when we focus on boundary cases that give non-singleton subalgebras. Namely,

$$A_1 \rightarrow A_2, \quad A_1 \oplus A_1 \rightarrow A_3, \quad A_3 \oplus A_1 \rightarrow D_5, \quad A_3 \oplus A_1 \oplus A_1 \rightarrow D_6, \quad A_3 \oplus A_3 \rightarrow D_7. \quad (1.2)$$

In each case, there are multiple possible embeddings giving distinct matter representations and the one chosen in F-theory always corresponds to the one of Dynkin index one. The elliptic fibrations for the $SU(2)$ -model and the $SU(2) \times SU(2)$ -model are respectively studied in [35, 36] and [29]. The characteristic representations for these cases are treated in detail in Section 3.2.

In the original Katz–Vafa’s list, we have the following case

$$A_{n-1} \rightarrow D_n. \quad (1.3)$$

This embedding is ambiguous for $n = 3$ as already mentioned. We should also distinguish the cases when $n = 4$, $n = 2k + 1$ ($k \geq 2$) and the case $n = 2k$ with $k \geq 3$. Putting them together, we have to consider four distinct cases

$$A_2 \rightarrow A_3, \quad A_3 \rightarrow D_4, \quad A_{2k-1} \rightarrow D_{2k}, \quad A_{2k} \rightarrow D_{2k+1}.$$

- (a) A_2 is a singleton subalgebra of A_3 discussed in Section 3.5.
- (b) A_3 has three distinct non-maximal embeddings in D_4 connected by triality, all three have Dynkin index one.
- (c) A_{2k-1} has two distinct maximal embeddings in D_{2k} , both have index one and give the same characteristic representation, the same branching rule for the vector representation, but different branching for the half-spin representations. They are related by the outer automorphism of D_{2k} that permutes the two half-spin representations. Thus, these subalgebras are different but give the same characteristic representation. They are adjoint

singleton subalgebras.

- (d) A_{2k} a singleton subalgebra of D_{2k+1} and has Dynkin index one. It gives a unique possible characteristic representation.
2. (a) In the original Katz–Vafa cases, the embedding $A_7 \rightarrow E_8$ is absent in the considered embeddings, while $A_6 \rightarrow E_7$ and $A_5 \rightarrow E_6$ are explicitly discussed. From the perspective and methodology in this paper, this can be understood as follows. While A_6 and A_5 are singleton subalgebra respectively of E_7 and E_6 , there are two distinct subalgebras of type A_7 in E_8 up to linear equivalence. Moreover, they both have Dynkin index one and yield distinct matter representations. It follows that identifying the branching rule for the adjoint of E_8 along A_7 is ambiguous without further requirement.
- (b) The existence of multiple isomorphic subalgebras that are not linearly equivalent but all of embedding index one is expected when one thinks of the possibility that they can be Lie algebras of distinct groups sharing the same simply connected cover. In that case, they differ by taking different discrete quotients of the same underlying connected group. Thus, they might also have distinct characteristic representations. We illustrate this point with the two A_7 subalgebras in E_8 . Their characteristic representations are:

$$A_7^1 \rightarrow E_8 : \quad \chi = \mathbf{8} \oplus \bar{\mathbf{8}} \oplus \mathbf{28} \oplus \bar{\mathbf{28}} \oplus \mathbf{56} \oplus \bar{\mathbf{56}} \oplus \mathbf{1}, \quad (1.4)$$

$$A_7^2 \rightarrow E_8 : \quad \chi = \mathbf{28}^{\oplus 2} \oplus \bar{\mathbf{28}}^{\oplus 2} \oplus \mathbf{70} \oplus \mathbf{1}^{\oplus 3}, \quad (1.5)$$

where $\mathbf{8} = V_{A_7}$ is the first fundamental representation, $\mathbf{28} = \Lambda_{A_7}^2$, $\mathbf{56} = \Lambda_{A_7}^3$, and $\mathbf{70} = \Lambda_{A_7}^4$. The first one factors via A_7^1 and the second one factors via E_7^1 . Both are subalgebras of the maximal subalgebra D_8 of E_8 . The existence of these two options can be understood by the existence of distinct compact group with Lie algebra A_7 in E_8 . Using Borel–Siebenthal techniques, we can show that the first A_7^1 is the Lie algebra of a simply-connected group $SU(8)$ while the second is the Lie algebra of the quotient group $SU(8)/(\pm 1)$. The maximal A_8 subalgebra of E_8 corresponds to the group $SU(9)$ mod by its \mathbb{Z}_3 subgroup while $A_1 \oplus E_7$ corresponds to the subgroup $(SU(2) \otimes E_7)/\pm(1, 1)$. The presence of the non-trivial center suggests that in F-theory, we will be dealing with an elliptic fibration with a non-trivial torsion sector in the Mordell–Weil group.

3. A poster child for our selection rule appears in the specialization of the $SU(2) \times SU(3)$ -model where there is an enhancement to an (incomplete) fiber of type III* or II*. $SU(2) \times SU(3)$ models in which all the matter content are on the same points are characterized by an enhancement $A_1^1 \oplus A_2^1 \rightarrow E_7$ or $A_1^1 \oplus A_2^1 \rightarrow E_8$. They are given by collisions of the type III+IV^s and their crepant resolutions are studied in [20].

- (a) There are 25 distinct $A_1 \oplus A_2$ subalgebra inside E_7 , but only one of them gives the matter content we expect, which corresponds to the one having Dynkin index $(1, 1)$:

$$A_1^1 \oplus A_2^1 \rightarrow E_7 : \quad \chi = (\mathbf{2}, \mathbf{3})^{\oplus 4} \oplus (\mathbf{2}, \bar{\mathbf{3}})^{\oplus 4} \oplus (\mathbf{1}, \mathbf{3})^{\oplus 7} \oplus (\mathbf{1}, \bar{\mathbf{3}})^{\oplus 7} \oplus (\mathbf{2}, \mathbf{1})^{\oplus 8} \oplus (\mathbf{1}, \mathbf{1})^{\oplus 16}. \quad (1.6)$$

Thus, the proposed selection rule successfully identifies the correct matter representations without referring to any additional analysis, such as D-brane techniques or anomaly cancellation conditions.

- (b) Up to linear equivalence, there are 55 distinct subalgebras of type $A_1 \oplus A_2$ in E_8 . However, only one of them have Dynkin embedding index $(1,1)$ and it gives the following characteristic representation:

$$A_1^1 \oplus A_2^1 \rightarrow E_8 : \quad \chi = (\mathbf{2}, \mathbf{3})^{\oplus 6} \oplus (\mathbf{2}, \bar{\mathbf{3}})^{\oplus 6} \oplus (\mathbf{1}, \mathbf{3})^{\oplus 15} \oplus (\mathbf{1}, \bar{\mathbf{3}})^{\oplus 15} \oplus (\mathbf{2}, \mathbf{1})^{\oplus 20} \oplus (\mathbf{1}, \mathbf{1})^{\oplus 35}. \quad (1.7)$$

- (c) As discussed in Section 5.2, the Lie algebra A_4 is a singleton subalgebra of index one for both E_6 and E_7 . In the study of the $SU(5)$ -model, one may also consider specializations in which all the matter appear at points of E_8 enhancements. There are exactly two subalgebras of type A_4 in E_8 up to linear equivalence. One has Dynkin index 1 and the other one has Dynkin index 2. Only the one with Dynkin index one gives the correct matter expected in F-theory and in $SU(5)$ Grand Unified theories:

$$A_4^1 \rightarrow E_8 : \quad \chi = \mathbf{5}^{\oplus 10} \oplus \bar{\mathbf{5}}^{\oplus 10} \oplus \mathbf{10}^{\oplus 5} \oplus \bar{\mathbf{10}}^{\oplus 5} \oplus \mathbf{1}^{\oplus 24}, \quad (1.8)$$

$$A_4^2 \rightarrow E_8 : \quad \chi = \mathbf{24} \oplus \mathbf{5} \oplus \bar{\mathbf{5}} \oplus \mathbf{10} \oplus \bar{\mathbf{10}} \oplus \mathbf{40} \oplus \bar{\mathbf{40}} \oplus \mathbf{45} \oplus \bar{\mathbf{45}}. \quad (1.9)$$

The subalgebra A_4^2 factors through the maximal semisimple algebra $A_4^1 \oplus A_4^1$.

4. The study of crepant resolutions of Tate's models [5, 6, 39?] provides a rich playground to test our selection rule. We add the following interesting list of subalgebras appearing in F-theory:

$$\left\{ \begin{array}{l} A_1 \rightarrow G_2, \quad A_1 \rightarrow B_3, \quad A_1 \rightarrow D_4, \\ A_2 \rightarrow G_2, \quad A_2 \rightarrow B_3, \quad A_2 \rightarrow D_4, \\ G_2 \rightarrow B_3, \quad G_2 \rightarrow D_4, \quad G_2 \rightarrow D_5, \\ G_2 \rightarrow F_4, \quad G_2 \rightarrow B_4, \quad G_2 \rightarrow E_6, \\ C_2 \rightarrow A_3, \quad C_2 \rightarrow B_3, \quad C_2 \rightarrow C_3, \quad C_2 \rightarrow A_4, \quad C_2 \rightarrow D_4, \quad C_2 \rightarrow D_5, \\ B_3 \rightarrow D_4, \quad B_3 \rightarrow B_4, \quad B_3 \rightarrow D_5, \quad B_3 \rightarrow F_4, \quad B_3 \rightarrow E_6, \\ D_4 \rightarrow F_4, \quad D_4 \rightarrow E_6, \\ F_4 \rightarrow E_6, \quad F_4 \rightarrow E_7, \quad F_4 \rightarrow E_8, \\ E_6 \rightarrow E_7, \quad E_6 \rightarrow E_8, \\ E_7 \rightarrow E_8, \\ A_1 \oplus A_1 \rightarrow C_2, \quad A_1 \oplus A_1 \rightarrow G_2, \quad A_1 \oplus A_1 \rightarrow B_3, \\ A_1 \oplus A_1 \rightarrow D_4, \quad A_1 \oplus A_1 \rightarrow B_4, \quad A_1 \oplus A_1 \rightarrow D_5. \end{array} \right. \quad (1.10)$$

5. In particular, one of the key examples that motivated this paper is the treatment of non-simply-laced cases. We effectively answer a problem that was raised in the papers [19, 23].

The crepant resolutions of the F_4 and G_2 -model suggest the following embeddings:

$$F_4 \rightarrow E_6, E_7, E_8, \quad (1.11)$$

$$G_2 \rightarrow B_3, D_4, D_5, D_6, \quad (1.12)$$

$$B_3 \rightarrow D_4, F_4, E_6, \quad (1.13)$$

$$C_2 \rightarrow A_3, A_4, B_3, C_3, D_4, D_5. \quad (1.14)$$

- (a) Since F_4 is a singleton subalgebra of E_6 , E_7 , and E_8 , there is no ambiguity in determining the matter content of an F_4 -model. In each case, we end up with the matter in the representation **26**.
 - (b) For the G_2 -model, the enhancement $G_2 \rightarrow E_6$ can be realized in two distinct ways leading to two distinct characteristic representations, namely, the representation **7** and the representation **64**. The one with Dynkin index one gives the representation **7** as expected.
 - (c) In the case of the B_3 -model [19], there are two possible enhancements to fibers of type F_4 and E_6 . B_3 is a singleton subalgebra of Dynkin embedding 1 in both F_4 and E_6 . In both cases, the reduced characteristic representation is $\mathbf{7} \oplus \mathbf{8}$. There are three distinct subalgebras of type B_3 in D_4 , they all have Dynkin embedding index one and give the same reduced characteristic representation, namely the representation **7**. Thus B_3 in D_4 is an example of an adjoint singleton subalgebra as there are several isomorphic but nonlinearly equivalent subalgebras giving the same reduced characteristic representation.
 - (d) The C_2 -model is particularly intriguing because it has various types of fiber enhancements allowed and there are two possible group structures, $SO(5)$ and $USp(4)$ [21]. In most of the cases, there is no need to refer to the selection rule, as C_2 is a singleton subalgebra of A_3 , B_3 , C_3 , and D_4 . However, in the case $C_2 \rightarrow A_4$, there are two possible isomorphic subalgebras C_3 : the one with Dynkin index one gives the correct matter representation (namely, the representation $\mathbf{4} \oplus \mathbf{5}$), while the other one gives the representation **14**. In the case $C_2 \rightarrow D_5$, there are two distinct C_4 subalgebras up to linear equivalence and they both have Dynkin index one. Interestingly, one of them gives the matter content of an $SO(5)$ theory, while the other one corresponds to a $Spin(5) \cong USp(4)$ theory.
6. Non-Higgsable models are particularly important models in 5d and 6d theories [43, 57]. They correspond to the simple Lie algebras of the Deligne exceptional series:

$$A_1 \rightarrow A_2 \rightarrow G_2 \rightarrow F_4 \rightarrow D_4 \rightarrow E_6 \rightarrow E_7 \rightarrow E_8, \quad (1.15)$$

together with the semisimple algebras $A_1 \oplus B_3$ and $A_1 \oplus G_2$. describing local collisions between two rational curves supporting non-trivial matter representations. At the collision of $A_1 \oplus G_2$, we find E_7 or E_8 models for which we get the branching rules of Dynkin index one to give rise to the expected matter representations from F-theory models $\mathbf{R} = (\mathbf{2}, \mathbf{7}) \oplus (\mathbf{2}, \mathbf{1}) \oplus (\mathbf{1}, \mathbf{7})$, where the matter representations $(\mathbf{2}, \mathbf{1})$ and $(\mathbf{1}, \mathbf{7})$ are also produced away from the collision [28]. We further explore in detail all the relevant branching rules:

- (a) $E_7 \rightarrow E_8$ from the original Katz–Vafa as a singleton model in Section 3.1,

(b) $A_1 \oplus G_2 \rightarrow D_5, B_5, D_6, E_7, E_8$ in Section 12,

(c) $A_1 \oplus B_3 \rightarrow E_7, E_8$ in Section 13,

(d) $A_1 \oplus D_4 \rightarrow E_7, E_8$ in Section 14.

7. The proposed selection rule 1.1 can also be used to identify those models that do not have an F-theory origin. A simple example is given by the gauge theory with Lie algebra $\mathfrak{g} = A_1 \oplus D_4$ and reduced matter in the representation

$$\mathbf{R} = (\mathbf{2}, \mathbf{8}_v) \oplus (\mathbf{1}, \mathbf{8}_s), (\mathbf{1}, \mathbf{8}_c) \quad (1.16)$$

discussed in [43, §3.3]. A quick scan of possibilities show that there is no simple Lie algebra \mathfrak{m} in E_8 containing \mathfrak{g} and giving the expected matter content up to multiplicities of the individual irreducible representations. In F-theory, this Lie algebra will be produced by a collision of type III+ I_0^* which is a Miranda model giving a fiber of type III* or II*. That means, the corresponding subalgebra would be of the type $A_1 \oplus D_4$ in E_7 . The embedding could also be in E_8 for a specialization of the elliptic fibration. There are three subalgebras of type $A_1 \oplus D_4$ up to linear equivalence in E_7 . Their characteristic representations and Dynkin index are

$$A_1^1 \oplus D_4^1 \rightarrow E_7: \quad \chi = (\mathbf{2}, \mathbf{8}_v)^{\otimes 2} \oplus (\mathbf{2}, \mathbf{8}_s)^{\otimes 2} \oplus (\mathbf{1}, \mathbf{8}_c)^{\otimes 4} \oplus (\mathbf{1}, \mathbf{1})^{\otimes 6}, \quad (1.17)$$

$$A_1^2 \oplus D_4^1 \rightarrow E_7: \quad \chi = (\mathbf{3}, \mathbf{1}) \oplus (\mathbf{1}, \mathbf{8}_v) \oplus (\mathbf{3}, \mathbf{8}_v) \oplus (\mathbf{2}, \mathbf{8}_s)^{\oplus 2} \oplus (\mathbf{2}, \mathbf{8}_c)^{\oplus 2} \oplus (\mathbf{1}, \mathbf{1})^{\oplus 3}, \quad (1.18)$$

$$A_1^3 \oplus D_4^1 \rightarrow E_7: \quad \chi = (\mathbf{3}, \mathbf{8}_v) \oplus (\mathbf{3}, \mathbf{8}_s) \oplus (\mathbf{3}, \mathbf{8}_c) \oplus (\mathbf{1}, \mathbf{8}_v) \oplus (\mathbf{1}, \mathbf{8}_s) \oplus (\mathbf{1}, \mathbf{8}_c) \oplus (\mathbf{3}, \mathbf{1})^{\oplus 2}. \quad (1.19)$$

The first has Dynkin index one and is therefore the one expected in F-theory. In particular, we see that the representation $\mathbf{R} = (\mathbf{2}, \mathbf{8}_v) \oplus (\mathbf{1}, \mathbf{8}_s), (\mathbf{1}, \mathbf{8}_c)$ is never realized by the Katz–Vafa decomposition of E_7 .

There are eight linearly nonequivalent subalgebras of type $A_1 \oplus D_4$ in E_8 . These eight embeddings can be distinguished by their Dynkin index. None of them matches the representation \mathbf{R} . However, we note that the unique one of Dynkin index (1, 1) contains \mathbf{R} in a triality-invariant way:

$$A_1^1 \oplus D_4^1 \rightarrow E_8: \quad \chi = (\mathbf{2}, \mathbf{8}_v)^{\oplus 2} \oplus (\mathbf{2}, \mathbf{8}_s)^{\oplus 2} \oplus (\mathbf{2}, \mathbf{8}_c)^{\oplus 2} \oplus (\mathbf{1}, \mathbf{8}_v)^{\oplus 4} \oplus (\mathbf{1}, \mathbf{8}_s)^{\oplus 4} \\ \oplus (\mathbf{1}, \mathbf{8}_c)^{\oplus 4} \oplus (\mathbf{2}, \mathbf{1})^{\oplus 8} \oplus (\mathbf{1}, \mathbf{1})^{\oplus 9}. \quad (1.20)$$

We also note that the matter discussed in [43, Section 3.3] is not compatible with any branching of the adjoint of E_8 along $A_1 \oplus D_4$, as any other embedding of $A_1 \oplus D_4 \rightarrow E_8$ involves representations of A_1 of higher spin or the irreducible representations of D_4 of dimension 35.

2 Preliminaries

Classifying semisimple subalgebras of a complex semisimple Lie algebra is a fundamental problem arising in many different contexts in mathematics and physics [7, 11–13, 51, 54]. The solution to this classical problem was beautifully addressed by Dynkin’s seminal papers, which also introduced several key ideas such as the projective and affine Dynkin’s diagrams, the equivalence and linear

equivalence of subalgebras and embeddings, the notion of R-subalgebras and S-subalgebras, the Dynkin index of a representation, and the Dynkin index of an embedding of Lie algebras.

In this section, we review basic notions that will play a central role in our approach. Our description follows Dynkin [13], Minchenko [54], de Graaf [11], McKay–Patera [53], and Lorente–Gruber [51]. We use the conventions of Bourbaki [8].

In 1950s, Dynkin classified the maximal semisimple subalgebras of exceptional Lie algebras up to equivalence and simple subalgebras only up to linear equivalence [13]. Dynkin also introduced an algorithm to classify regular subalgebras of semisimple classical Lie algebras up to equivalence and provided an explicit classification (up to linear equivalence) of S-subalgebras and simple subalgebras of exceptional Lie algebras. Dynkin focused especially on exceptional Lie algebras, since the classical cases can be described by the work of Cartan, Weyl, and Malcev.³ Dynkin’s result has some inaccuracies that are corrected by Minchenko, who further provided a classification of embeddings of semisimple subalgebras of simple Lie algebras of exceptional types up to equivalence rather than just linear equivalence, thereby completing the description of embeddings of semisimple subalgebras of simple Lie algebras [54]. Using Dynkin’s algorithm, Lorente and Gruber obtained the detailed classification of subalgebras of simple Lie algebras of classical types up to rank six [51]. Motivated from problems in physics, de Graaf describes algorithms that give a classification of the semisimple subalgebras of all simple Lie algebra or rank eight or lower together with the inclusion relations between all these semisimple Lie algebras [11]. de Graaf also correct few inaccuracies in the classification of Lorente and Gruber (in D_4 , D_6 , and D_8).

2.1 Embeddings, equivalence, linear equivalence, and branching rules

Definition 2.1 (Embeddings). An embedding $f : \mathfrak{g} \rightarrow \mathfrak{m}$ between two Lie algebras \mathfrak{g} and \mathfrak{m} is an injective homomorphism from \mathfrak{g} to \mathfrak{m} .

Definition 2.2 (Induced representations and branching rules). Given an embedding $f : \mathfrak{g} \rightarrow \mathfrak{m}$, any irreducible linear representation φ of \mathfrak{m} induces a linear representation $\varphi \circ f$ of \mathfrak{g} . The representation $\varphi \circ f$ is in general reducible and its decomposition into irreducible representations of \mathfrak{g} is called *the branching rule of φ* .

The classification of subalgebras starts with a choice of a notion of equivalence. There are two different notions of equivalence that are typically considered, where both are introduced by Dynkin. One is simply called equivalence, which is more natural, and the other is called linear equivalence, which is coarser but more computationally friendly. We give definitions for these two notions as follows.

Definition 2.3 (Equivalent of Lie subalgebras). Two subalgebras \mathfrak{g}_1 and \mathfrak{g}_2 of a Lie algebra \mathfrak{m} are said to be *equivalent* if they are conjugate by an inner automorphism of the parent Lie algebra \mathfrak{m} .

Definition 2.4 (Linear equivalent of Lie subalgebras). Two subalgebras are *linearly equivalent* if for any linear representation $f : \mathfrak{m} \rightarrow \mathfrak{gl}(n)$ of the parent Lie algebra induces representations of the

³The case of A_n was studied by Cartan and Weyl, while the cases of B_n , C_n , and D_n were analyzed by Malcev who also investigated representations of G_2 and F_4 . Borel and de Siebenthal studied the maximal semisimple subalgebras of simple Lie algebras [7].

two subalgebras that are conjugated by a linear inner automorphism of $\mathfrak{gl}(n)$.

When discussing branching rules, linear equivalence is the appropriate notion of equivalence to consider, as two linearly equivalent subalgebras give the same branching rules. Two equivalent subalgebras are always linearly equivalent. The reverse is often (but not necessarily) true. There are known examples of embeddings that are linearly equivalent but not equivalent. Linear equivalence and equivalence coincide for A_n , B_n , C_n , G_2 , and F_4 . Subtleties appears for E_6 , E_7 , E_8 , and D_n ($n \geq 4$) Lie algebras. For example, E_8 has 1183 equivalent subalgebras organized into 155 linear equivalence classes [11].

2.2 R- and S-subalgebras

In his classification of subalgebras of simple Lie algebras, Dynkin introduced the notions of a regular subalgebras, R-subalgebras, and S-subalgebras. We present them as follows.

Definition 2.5 (Regular, R-, and S-algebras). A subalgebra \mathfrak{g} is said to be a *regular subalgebra* of a parent Lie algebra \mathfrak{m} when the Dynkin diagram of \mathfrak{g} can be obtained by removing nodes of the extended Dynkin diagram of \mathfrak{m} . An *R-subalgebra* is a subalgebra that is contained in a proper regular subalgebra, whereas an *S-subalgebra* is a proper subalgebra that is not an R-subalgebra.

Tables listing maximal R- and S-subalgebras of simple Lie algebras can be found in [53, 63, 66].

2.3 Normalized Killing form

Consider a simple Lie algebra \mathfrak{g} of rank n with a choice of simple roots. We denote the set of positive roots as Φ^+ . The Killing form

$$\kappa(x, y) := \text{Tr}(\text{ad } x, \text{ad } y) \tag{2.1}$$

defines an invariant bilinear symmetric form on \mathfrak{g} . Up to a multiplicative factor, there exists a unique non-degenerate invariant symmetry bilinear form on \mathfrak{g} . We denote by (\cdot, \cdot) the invariant scalar product in the root space to be normalized such that a root of the longest length has its length squared equals to two. In particular, if we denote by θ the highest root (which is always a long root), we have

$$(\theta, \theta) = 2. \tag{2.2}$$

The Lie algebra is semisimple if and only if the Killing form is negative-definite. Given any invariant bilinear symmetric form $B(\cdot, \cdot)$ on \mathfrak{g} , the normalized Killing form is given by

$$(x, y) := \frac{2B(x, y)}{B(\theta, \theta)}. \tag{2.3}$$

2.4 Dynkin's index of a representation

The notion of an index of a subalgebra was introduced by Dynkin in his classification of semisimple subalgebras of exceptional simple Lie algebra and requires first introducing the notion of the Dynkin index of a representation. The index of a simple subalgebra in a simple Lie algebra is always a non-negative integer. Two linearly equivalent subalgebras have the same index. Thus, two subalgebras with a different index are necessarily non-equivalent. However, the index is not a complete

characterization of a subalgebra as two subalgebras with the same index are not necessarily linearly equivalent, even if they are isomorphic as abstract algebras.

Given a linear representation of \mathfrak{g} in a vector space V

$$f : \mathfrak{g} \rightarrow \mathfrak{gl}(V), \quad (2.4)$$

we define the invariant symmetric bilinear form in \mathfrak{g} induced by f as follows

$$(x, y)_f := \text{Tr}(f(x)f(y)), \quad (2.5)$$

where for a square $n \times n$ matrix M , $\text{Tr}(M) = \sum_{i=1}^n M_{ii}$ is the trace of M . Since the invariant bilinear symmetric form is unique up to a multiplicative constant, $(x, y)_f$ should be proportional to the normalized Killing form (x, y) that takes value 2 on the longest root. The multiplicative constant is independent of x and y and characterizes the representation f . Then, it is by definition the Dynkin index of the representation f .

Definition 2.6. Given a representation $f : \mathfrak{g} \rightarrow \mathfrak{gl}(V)$, the *Dynkin index of the representation f* is the multiplicative constant ℓ_f defined by the identity:

$$(x, y)_f = \ell_f \cdot (x, y). \quad (2.6)$$

If we take $x = y = \theta$, we can express the Dynkin index of a representation as half the length squared of the highest root (or any long root) with respect to the invariant bilinear form induced by the representation f :

$$\ell_f = \frac{1}{2}(\theta, \theta)_f. \quad (2.7)$$

In particular, the index of the adjoint representation is the *dual Coxeter number* of the Lie algebra.

Cartan's theorem states that a weight is the highest weight of an irreducible representation of a simple Lie algebra if and only if its Dynkin indices are all non-negative integers. The following formula allows to compute the index of a representation f in terms of its highest weight Λ_f :

$$\ell_f = (\Lambda_f, \Lambda_f + 2\rho) \frac{\dim f}{\dim \mathfrak{g}}, \quad (2.8)$$

where Λ_d is the highest weight of the representation f , $\dim f$ is the dimension of the representation f (that is, of the vector space V), $\dim \mathfrak{g}$ is the dimension of the simple Lie algebra \mathfrak{g} , and the Weyl vector ρ is half the sum of all positive roots Φ^+ of \mathfrak{g} .

$$\rho = \frac{1}{2} \sum_{\alpha \in \Phi^+} \alpha. \quad (2.9)$$

The number $(\Lambda, \Lambda + 2\rho)$ is the eigenvalue of the second-order Casimir operator. The formula (2.8) is reminiscent of Weyl's formula for the dimension d_Λ of a representation with the highest weight Λ :

$$d_\Lambda = \sum_{\alpha \in \Phi^+} \frac{(\alpha, \Lambda + \rho)}{(\alpha, \alpha)}. \quad (2.10)$$

The dual Coxeter number of a simple Lie algebra is the Dynkin's index of its adjoint representation:

$$h^\vee = \ell_{\text{ad}} = (\theta, \theta + 2\rho) = \text{Tr}(\text{ad}\theta, \text{ad}\theta). \quad (2.11)$$

The Dynkin index of a representation satisfies the following two identities

$$\ell_{f_1 \oplus f_m} = \ell_{f_1} + \ell_{f_m}. \quad (2.12)$$

$$\ell_{f_1 \otimes f_2} = (\dim f_2)\ell_{f_1} + (\dim f_1)\ell_{f_2}. \quad (2.13)$$

2.5 Dynkin index of an embedding

An embedding between two simple Lie algebras \mathfrak{g} and \mathfrak{m} is an isomorphism

$$\varphi : \mathfrak{g} \rightarrow \mathfrak{m} \quad (2.14)$$

that maps \mathfrak{g} onto its image in \mathfrak{m} . Then, we can think of the embedding φ as a representation of \mathfrak{g} in \mathfrak{m} . Analogous to the case of a linear representation, it is natural that we define the Dynkin index of an embedding φ . We assume that both Lie algebras \mathfrak{g} and \mathfrak{m} have their bilinear form to be normalized such that the norm squared of each of their root of highest length is two. We can define an invariant bilinear form in \mathfrak{m} via the embeddings φ . Because such an invariant bilinear form is unique upto a multiplicative constant, we have a number j_φ such that

$$(\varphi x, \varphi y)_{\mathfrak{g}} = j_\varphi \cdot (x, y)_{\mathfrak{m}}. \quad (2.15)$$

The number j_φ is called the *Dynkin index of the embedding* φ . The index of a subalgebra is invariant with respect to automorphisms of \mathfrak{m} .

The Dynkin index of an embedding can be computed as the ratio between the Dynkin index of an induced representation and its parent representation. For any representation $f : \mathfrak{m} \rightarrow \mathfrak{gl}(V)$, we have $f \circ \varphi : \mathfrak{g} \rightarrow \mathfrak{gl}(V)$ defining an induced representation of the subalgebra \mathfrak{g} . We can therefore compute the index of the embedding φ in terms of the index of a representation f of \mathfrak{m} and the induced representation on \mathfrak{g} as

$$j_\varphi = \frac{\ell_{f \circ \varphi}}{\ell_f}. \quad (2.16)$$

The Dynkin index of an embedding is multiplicative in the following sense. If \mathfrak{g}_1 , \mathfrak{g}_2 , and \mathfrak{g}_3 are three simple algebras and φ_i is an embedding of \mathfrak{g}_i into \mathfrak{g}_{i+1} $i = 1, 2$, then

$$j_{\varphi_2 \circ \varphi_1} = j_{\varphi_2} \cdot j_{\varphi_1}. \quad (2.17)$$

If under the embedding $\varphi : \mathfrak{g} \rightarrow \mathfrak{m}$ a representation \mathbf{R} of \mathfrak{m} has a decomposition

$$R = R_1^{\oplus m_1} \oplus \dots \oplus R_n^{\oplus m_n}, \quad (2.18)$$

where R_i is an irreducible representations of \mathfrak{g} with multiplicity m_i . Then, the Dynkin index of the

embedding φ is simply given by the formula

$$j_\varphi = \frac{1}{\ell_{\mathbf{R}}}(m_1\ell_{R_1} + \cdots + m_n\ell_{R_n}). \quad (2.19)$$

The following is a key theorem on the Dynkin index.

Theorem 2.7. *The Dynkin index of an injective homomorphism between simple Lie algebras is a positive integer.*

When the Dynkin index of a representation f is one, the representation f transforms the longest root of \mathfrak{g} into the longest root of \mathfrak{m} , and transforms the corresponding root vectors of \mathfrak{g} into root vectors of \mathfrak{m} . In the language of embedded subalgebras, we can characterize subalgebras of index one by the following theorem.

Theorem 2.8 ([13, Theorem 2.4]). *Let \mathfrak{g} be a simple subalgebra of the simple algebra \mathfrak{m} . If the index of \mathfrak{g} in \mathfrak{m} is equal to 1, then the root of maximal length and the corresponding root vectors in \mathfrak{g} are respectively the roots and the root vectors in the algebra \mathfrak{m} .*

A fundamental representation of a Lie algebra is one for which the highest weight is a simple root. The defining (or the standard) representation of a simple Lie algebra is the fundamental representation of the smallest dimension. In physics, it is often called *the fundamental representation* of the simple Lie algebra. The Dynkin indices of all fundamental representations of all simple Lie algebras are listed in Table 2.

We denote a simple subalgebra with its index as a superscript. When the indices are the same for not linearly equivalent subalgebras, we use (one, two, or three) primes additionally following the notation of Dynkin in [13, Table 25].

2.6 Dynkin index of a simple Lie algebra

The Dynkin index of a simple Lie algebra \mathfrak{g} , denoted $\ell_{\mathfrak{g}}$ is by definition the greatest common divisor of the Dynkin indices $\ell_{\mathbf{R}}$ where \mathbf{R} runs over all linear representations of \mathfrak{g} . It is enough to take the greatest common divisor among all fundamental representations of \mathfrak{g} since the Dynkin index of any other representation is a linear combination of them with non-negative integral coefficients. We list the Dynkin index of fundamental representations of all simple Lie groups on Table 2 while the Dynkin index of simple Lie algebras are listed on Table 1.

\mathfrak{g}	$A_n (n \geq 1)$	$B_n (n \geq 3)$	$C_n (n \geq 2)$	$D_n (n \geq 4)$	G_2	F_4	E_6	E_7	E_8
h	$n + 1$	$2n$	$2n$	$2n - 2$	6	12	12	18	30
h^\vee	$n + 1$	$2n - 1$	$n + 1$	$2n - 2$	4	9	12	18	30
$\lambda_{\mathfrak{g}}$	1	2	1	2	2	6	6	12	60
ϖ	ϖ_1, ϖ_n	ϖ_1	ϖ_1	ϖ_1	ϖ_1	ϖ_1	ϖ_1, ϖ_6	ϖ_7	ϖ_8

Table 1: The Dynkin index of simple Lie algebras. The *Dynkin index* $\lambda_{\mathfrak{g}}$ of a simple Lie algebra \mathfrak{g} is the greatest common divisor $\lambda_{\mathfrak{g}}$ of the Dynkin indexes of its fundamental representations. The numbers h and h^\vee are the Coxeter and the dual Coxeter number. On the last row, we list the fundamental weights (in the conventions of Bourbaki) whose corresponding representation has Dynkin index $\lambda_{\mathfrak{g}}$. See also [50, Proposition 2.6].

2.7 Conventions and basic data on simple Lie algebras and their representations

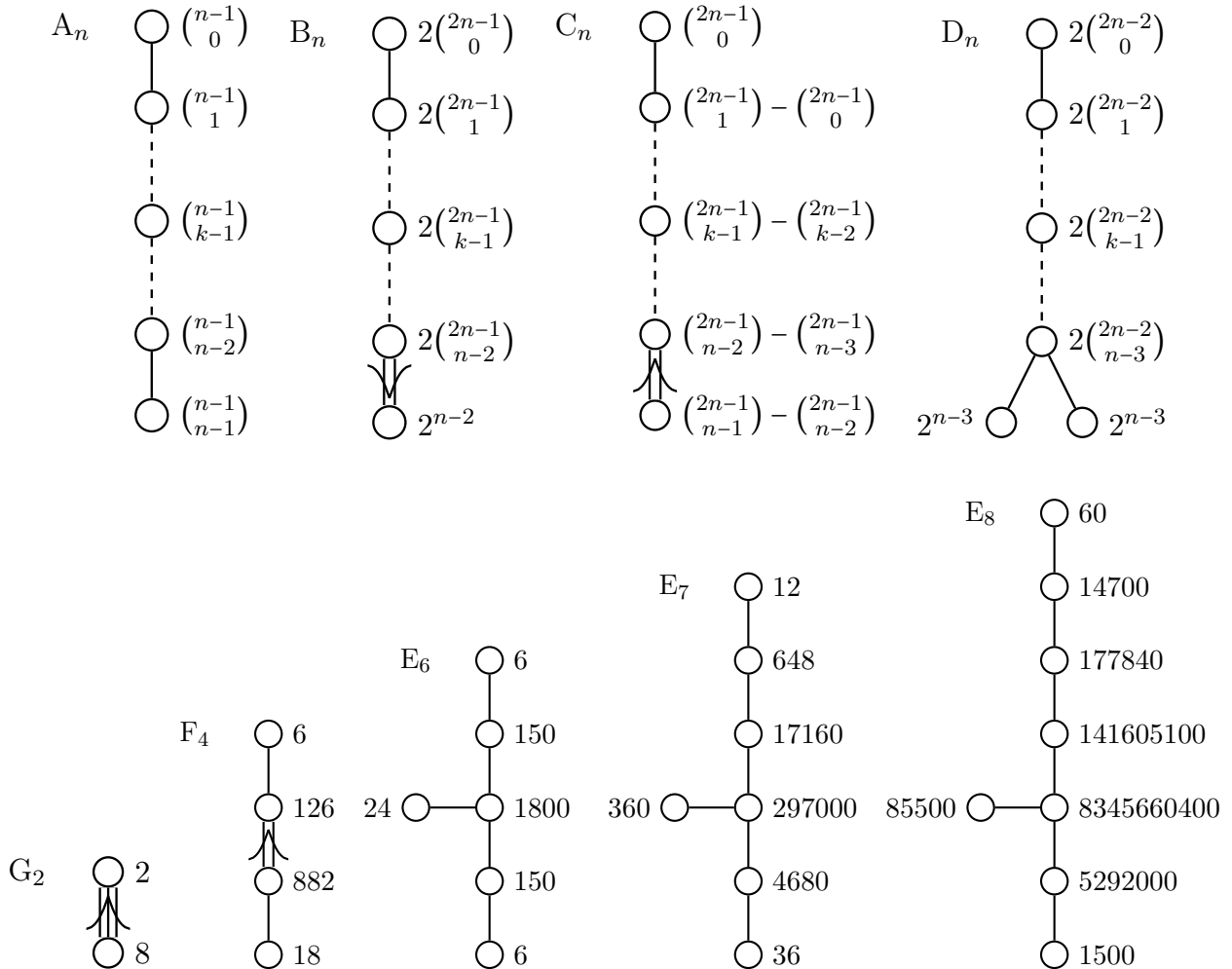

Table 2: Dynkin indices of the fundamental representations of simple Lie algebras. This table is obtained from [13, Table 5] after fixing some typos and inaccuracies (index of ϖ_{n-1} for B_n and C_n ; and the index of ϖ_i of E_8 for $i = 3, 4, 5, 6$).

Algebra(\mathfrak{g})	Cartan	Dynkin	Condition	Representation
A_n $n = 0, 2, 3 \pmod{4}$	$\begin{pmatrix} 2 & -1 & 0 & \cdots & 0 & 0 & 0 \\ -1 & 2 & -1 & \cdots & 0 & 0 & 0 \\ \vdots & \vdots & \vdots & \ddots & \vdots & \vdots & \vdots \\ 0 & 0 & 0 & \cdots & 2 & -1 & 0 \\ 0 & 0 & 0 & \cdots & -1 & 2 & -1 \\ 0 & 0 & 0 & \cdots & 0 & -1 & 2 \end{pmatrix}$		$(a_1, \dots, a_n) \neq (a_n, \dots, a_1)$ $(a_1, \dots, a_n) = (a_n, \dots, a_1)$	Complex Real
A_n $n = 1 \pmod{4}$			$(a_1, \dots, a_n) \neq (a_n, \dots, a_1)$ $\{(a_1, \dots, a_n) = (a_n, \dots, a_1)\}$ $\{a_{(n+1)/2} = 0 \pmod{2}\}$ $\{(a_1 \cdots a_n) = (a_n \cdots a_1)\}$ $\{a_{(n+1)/2} = 1 \pmod{2}\}$	Complex Real Pseudo-real
B_n $n = 0, 3 \pmod{4}$	$\begin{pmatrix} 2 & -1 & 0 & \cdots & 0 & 0 & 0 \\ -1 & 2 & -1 & \cdots & 0 & 0 & 0 \\ \vdots & \vdots & \vdots & \ddots & \vdots & \vdots & \vdots \\ 0 & 0 & 0 & \cdots & 2 & -1 & 0 \\ 0 & 0 & 0 & \cdots & -1 & 2 & -2 \\ 0 & 0 & 0 & \cdots & 0 & -1 & 2 \end{pmatrix}$		None	Real
B_n $n = 1, 2 \pmod{4}$			$a_n = 0 \pmod{2}$ $a_n = 1 \pmod{2}$	Real Pseudo-real
C_n	$\begin{pmatrix} 2 & -1 & 0 & \cdots & 0 & 0 & 0 \\ -1 & 2 & -1 & \cdots & 0 & 0 & 0 \\ \vdots & \vdots & \vdots & \ddots & \vdots & \vdots & \vdots \\ 0 & 0 & 0 & \cdots & 2 & -1 & 0 \\ 0 & 0 & 0 & \cdots & -1 & 2 & -1 \\ 0 & 0 & 0 & \cdots & 0 & -2 & 2 \end{pmatrix}$		$a_1 + \cdots + a_n = 0 \pmod{2}$	Real
			$a_1 + \cdots + a_n = 1 \pmod{2}$	Pseudo-real
D_n $n = 1 \pmod{2}$	$\begin{pmatrix} 2 & -1 & 0 & \cdots & 0 & 0 & 0 \\ -1 & 2 & -1 & \cdots & 0 & 0 & 0 \\ \vdots & \vdots & \vdots & \ddots & \vdots & \vdots & \vdots \\ 0 & 0 & 0 & \cdots & 2 & -1 & -1 \\ 0 & 0 & 0 & \cdots & -1 & 2 & 0 \\ 0 & 0 & 0 & \cdots & -1 & 0 & 2 \end{pmatrix}$		$a_{n-1} \neq a_n$ $a_{n-1} = a_n$	Complex Real
D_n $n = 0 \pmod{4}$			None	Real
D_n $n = 2 \pmod{4}$			$a_{n-1} + a_n = 0 \pmod{2}$ $a_{n-1} + a_n = 1 \pmod{2}$	Real Pseudo-real

Table 3: Cartan matrices, Dynkin diagrams, and reality conditions of representations of classical simple Lie algebras.

\mathfrak{g}	Cartan	Dynkin	Condition	Representation
E_6	$\begin{pmatrix} 2 & -1 & 0 & 0 & 0 & 0 \\ -1 & 2 & -1 & 0 & 0 & 0 \\ 0 & -1 & 2 & -1 & 0 & -1 \\ 0 & 0 & -1 & 2 & -1 & 0 \\ 0 & 0 & 0 & -1 & 2 & 0 \\ 0 & 0 & -1 & 0 & 0 & 2 \end{pmatrix}$		$(a_1, a_2, a_3, a_4, a_5, a_6)$ $\neq (a_5, a_4, a_3, a_2, a_1, a_6)$	Complex
			$(a_1, a_2, a_3, a_4, a_5, a_6)$ $= (a_5, a_4, a_3, a_2, a_1, a_6)$	Real
E_7	$\begin{pmatrix} 2 & -1 & 0 & 0 & 0 & 0 & 0 \\ -1 & 2 & -1 & 0 & 0 & 0 & 0 \\ 0 & -1 & 2 & -1 & 0 & 0 & -1 \\ 0 & 0 & -1 & 2 & -1 & 0 & 0 \\ 0 & 0 & 0 & -1 & 2 & -1 & 0 \\ 0 & 0 & 0 & 0 & -1 & 2 & 0 \\ 0 & 0 & -1 & 0 & 0 & 0 & 2 \end{pmatrix}$		$a_4 + a_6 + a_7 = 0 \pmod{2}$	Real
			$a_4 + a_6 + a_7 = 1 \pmod{2}$	Pseudo-real
E_8	$\begin{pmatrix} 2 & -1 & 0 & 0 & 0 & 0 & 0 & 0 \\ -1 & 2 & -1 & 0 & 0 & 0 & 0 & 0 \\ 0 & -1 & 2 & -1 & 0 & 0 & 0 & -1 \\ 0 & 0 & -1 & 2 & -1 & 0 & 0 & 0 \\ 0 & 0 & 0 & -1 & 2 & -1 & 0 & 0 \\ 0 & 0 & 0 & 0 & -1 & 2 & -1 & 0 \\ 0 & 0 & 0 & 0 & 0 & -1 & 2 & 0 \\ 0 & 0 & -1 & 0 & 0 & 0 & 0 & 2 \end{pmatrix}$		None	Real
F_4	$\begin{pmatrix} 2 & -1 & 0 & 0 \\ -1 & 2 & -2 & 0 \\ 0 & -1 & 2 & -1 \\ 0 & 0 & -1 & 2 \end{pmatrix}$		None	Real
G_2	$\begin{pmatrix} 2 & -3 \\ -1 & 2 \end{pmatrix}$		None	Real

Table 4: Cartan matrices, Dynkin diagrams, and reality conditions of representations of exceptional Lie algebras.



Algebra	Highest weight	Name	Comment
A_1	2	3	adjoint
	1	2	defining (fundamental) rep., pseudo-real
$A_{n \geq 2}$	$[1, 0, \dots, 0, 1]$	$\mathbf{n(n+2)}$	adjoint
	$[1, 0, \dots, 0]$	$\frac{\mathbf{n+1}}{\mathbf{n+1}}$	defining (fundamental) rep., complex
	$[0, \dots, 0, 1]$		
$B_{n \geq 2}$	$[0, 1, \dots, 0]$	$\mathbf{n(2n+1)}$	adjoint
	$[1, 0, \dots, 0]$	$\mathbf{2n+1}$	defining (vector) representation, real
	$[0, \dots, 0, 1]$	$\mathbf{2^n}$	spin representation
$C_{n \geq 2}$	$[2, 0, \dots, 0]$	$\mathbf{n(2n+1)}$	adjoint
	$[1, 0, \dots, 0]$	$\mathbf{2n}$	defining (fundamental) rep., pseudo-real
	$[0, 1, 0, \dots, 0]$	$\mathbf{(n-1)(2n+1)}$	traceless antisymmetric rep., pseudo-real
$D_{n \geq 4}$	$[0, 1, 0, \dots, 0]$	$\mathbf{n(2n-1)}$	adjoint
	$[1, 0, 0, \dots, 0]$	$\mathbf{2n}$	defining (vector) rep., real
	$[0, \dots, 0, 1, 0]$	$\mathbf{2^{n-1}}$	half-spin
	$[0, \dots, 0, 0, 1]$	$\frac{\mathbf{2^{n-1}}}{\mathbf{2^{n-1}}}$	
G_2	$[0, 1]$ 	14	adjoint
	$[1, 0]$ 	7	defining (vector) representation, real
F_4	$[1, 0, 0, 0]$ 	52	adjoint
	$[0, 0, 0, 1]$ 	26	defining representation, real
E_6	$[0, 1, 0, 0, 0, 0]$ 	78	adjoint
	$[1, 0, 0, 0, 0, 0]$ 	27	defining representation, complex.
	$[0, 0, 0, 0, 0, 1]$ 	$\overline{\mathbf{27}}$	
E_7	$[1, 0, 0, 0, 0, 0, 0, 0]$ 	133	adjoint
	$[0, 0, 0, 0, 0, 0, 0, 1]$ 	56	defining representation, pseudo-real.
E_8	$[0, 0, 0, 0, 0, 0, 0, 1]$ 	248	adjoint

Table 5: Highest weights and names of the most common representations of simple Lie algebras. The highest weights are given in the basis of fundamental weights and the labeling follows the conventions of Bourbaki [8]. The defining representation is always the shortest. For D_4 , there are three representations that are of equal dimension: $[1, 0, 0, 0] = \mathfrak{8}_v$, $[0, 0, 0, 1] = \mathfrak{8}_s$, and $[0, 0, 1, 0] = \mathfrak{8}_s$. For E_8 , the shortest representation is the adjoint representation. For ADE algebras, the adjoint representation is quasi-minuscule. For B_n , G_2 , and F_4 algebras, the vector representation is quasi-minuscule. For C_n , the traceless antisymmetric representation is quasi-minuscule. The half-spin representations of D_n are complex conjugate of each other if $n = \pm 1 \pmod 4$, they are independent of each other and self-dual otherwise. More precisely, they are real when $n = 0 \pmod 4$ and pseudo-real if $n = 2 \pmod 4$.

Algebras	Minuscule representations	Quasi-minuscule representations
A_n	$\binom{\mathbf{n} + \mathbf{1}}{\mathbf{k}}$ ($0 \leq k \leq n$)	$\mathbf{n}^2 + 2\mathbf{n}$ (adjoint)
B_n ($n \geq 2$)	$\mathbf{1}$ (trivial), $2^{\mathbf{n}}$ (spin)	$2\mathbf{n} + \mathbf{1}$ (vector)
C_n ($n \geq 3$)	$\mathbf{1}$ (trivial), $2\mathbf{n}$ (vector)	$(\mathbf{n} - \mathbf{1})(2\mathbf{n} + \mathbf{1})$ (traceless antisymmetric)
D_n ($n \geq 4$)	$\mathbf{1}$ (trivial), $2\mathbf{n}$ (vector) $2^{\mathbf{n}-1}$ (half-spin) $\overline{2^{\mathbf{n}-1}}$ (half-spin)	$2\mathbf{n}^2 - \mathbf{n}$ (adjoint)
G_2	$\mathbf{1}$ (trivial)	$\mathbf{7}$
F_4	$\mathbf{1}$ (trivial)	$\mathbf{26}$
E_6	$\mathbf{1}$ (trivial), $\mathbf{27}$, $\overline{\mathbf{27}}$	$\mathbf{78}$ (adjoint)
E_7	$\mathbf{1}$ (trivial), $\mathbf{56}$	$\mathbf{133}$ (adjoint)
E_8	$\mathbf{1}$	$\mathbf{248}$ (adjoint)

Table 6: Minuscule and quasi-minuscule representations of the simple Lie algebras. A minuscule representation is one for which all the weights are in the same orbit of the Weyl group. A quasi-minuscule representation is one for which all the non-zero weights are in the same orbit of the Weyl group.

Exceptional Lie algebras	Maximal S-subalgebras
G_2	A_1^{28}
F_4	$A_1^{156}, A_1^8 \oplus G_2^1$
E_6	$A_1^9, G_2^3, C_4^1, A_2^{2''} \oplus G_2^1, F_4^1$
E_7	$A_1^{231}, A_1^{399}, A_2^{21}, A_1^{15} \oplus A_1^{24}, A_1^7 \oplus G_2^2, G_2^1 \oplus C_3^{1''}, A_1^{3''} \oplus F_4^1$
E_8	$A_1^{1240}, A_1^{760}, A_1^{520}, A_2^{6'} \oplus A_1^{16}, B_2^{12}, G_2^1 \oplus F_4^1$

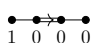
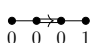
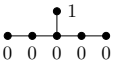
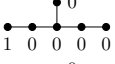
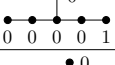
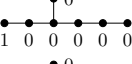
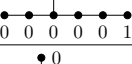
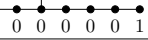
Table 7: The maximal S-subalgebras of the simple exceptional Lie algebras up to linear equivalence. The superscript gives the Dynkin index of the subalgebra. See [12, Theorem 4.2].

Rank	Algebra \mathfrak{m}	Maximal R-subalgebras \mathfrak{g}	Maximal S-subalgebras \mathfrak{g}
1	A_1	\mathfrak{u}_1	
2	A_2 C_2 G_2	$A_1 \oplus \mathfrak{u}_1$ $A_1 \oplus A_1, A_1 \oplus \mathfrak{u}_1$ $A_2, A_1 \oplus A_1$	A_1 A_1 A_1
3	A_3 B_3 C_3	$A_2 \oplus \mathfrak{u}_1, A_1 \oplus A_1 \oplus \mathfrak{u}_1,$ $A_3, A_1 \oplus A_1 \oplus A_1, C_2 \oplus \mathfrak{u}_1$ $A_2 \oplus \mathfrak{u}_1, A_1 \oplus C_2$	$C_2, A_1 \oplus A_1$ G_2 $A_1, A_1 \oplus A_1$
4	A_4 D_4 B_4 C_4 F_4	$A_3 \oplus \mathfrak{u}_1, A_2 \oplus A_1 \oplus \mathfrak{u}_1$ $A_3 \oplus \mathfrak{u}_1, A_1 \oplus A_1 \oplus A_1 \oplus A_1$ $D_4, A_1 \oplus A_1 \oplus C_2, A_3 \oplus A_1, B_3 \oplus \mathfrak{u}_1$ $A_3 \oplus \mathfrak{u}_1, A_1 \oplus C_3, C_2 \oplus C_2$ $B_4, A_2 \oplus A_2, A_1 \oplus C_3$	C_2 $A_2, B_3, A_1 \oplus C_2$ $A_1, A_1 \oplus A_1$ $A_1, A_1 \oplus A_1 \oplus A_1$ $A_1, A_1 \oplus G_2$
5	A_5 D_5 B_5 C_5	$A_4 \oplus \mathfrak{u}_1, A_3 \oplus A_1 \oplus \mathfrak{u}_1, A_2 \oplus A_2 \oplus \mathfrak{u}_1$ $A_4 \oplus \mathfrak{u}_1, A_1 \oplus A_1 \oplus A_3, D_4 \oplus \mathfrak{u}_1$ $D_5, D_4 \oplus A_1, A_3 \oplus C_2,$ $A_1 \oplus A_1 \oplus B_3, B_4 \oplus \mathfrak{u}_1$ $A_4 \oplus \mathfrak{u}_1, A_1 \oplus C_4, C_2 \oplus C_3$	$A_2, A_3, C_3, A_2 \oplus A_1$ $C_2, B_4, A_1 \oplus B_3, C_2 \oplus C_2$ A_1 $A_1, A_1 \oplus C_2$
6	A_6 D_6 B_6 C_6 E_6	$A_5 \oplus \mathfrak{u}_1, A_4 \oplus A_1 \oplus \mathfrak{u}_1, A_3 \oplus A_2 \oplus \mathfrak{u}_1$ $A_5 \oplus \mathfrak{u}_1, A_1 \oplus A_1 \oplus D_4, D_5 \oplus \mathfrak{u}_1$ $A_3 \oplus A_3$ $D_6, D_5 \oplus A_1, D_4 \oplus C_2,$ $A_3 \oplus B_3, A_1 \oplus A_1 \oplus B_4, B_5 \oplus \mathfrak{u}_1$ $A_5 \oplus \mathfrak{u}_1, A_1 \oplus C_5, C_2 \oplus C_4,$ $C_3 \oplus C_3$ $D_5 \oplus \mathfrak{u}_1, A_5 \oplus A_1, A_2 \oplus A_2 \oplus A_2$	B_3 $C_2, B_5, A_1 \oplus B_4, C_2 \oplus B_3,$ $A_1 \oplus C_3$ A_1 $A_1, A_1 \oplus A_3, A_1 \oplus C_2$ $C_4, F_4, G_2, A_2, A_2 \oplus G_2$
7	A_7 D_7 B_7 C_7 E_7	$A_6 \oplus \mathfrak{u}_1, A_5 \oplus A_1 \oplus \mathfrak{u}_1, A_4 \oplus A_2 \oplus \mathfrak{u}_1,$ $A_3 \oplus A_3 \oplus \mathfrak{u}_1$ $A_6 \oplus \mathfrak{u}_1, A_1 \oplus A_1 \oplus D_5, D_6 \oplus \mathfrak{u}_1$ $A_3 \oplus D_4$ $D_7, B_6 \oplus \mathfrak{u}_1, D_6 \oplus A_1, D_5 \oplus C_2,$ $D_4 \oplus B_3, A_3 \oplus B_4, A_1 \oplus A_1 \oplus B_5$ $A_6 \oplus \mathfrak{u}_1, A_1 \oplus C_6, C_2 \oplus C_5,$ $C_3 \oplus C_4$ $A_7, E_6 \oplus \mathfrak{u}_1, A_5 \oplus A_2, D_6 \oplus A_1$	$D_4, C_4, A_3 \oplus A_1$ $G_2, C_2, C_3, B_6, C_2 \oplus B_4,$ $A_1 \oplus B_5, B_3 \oplus B_3$ $A_1, A_3, A_1 \oplus C_2$ $A_1, A_1 \oplus B_3, C_3$ $A_2, A_1, A_1 \oplus F_4, G_2 \oplus C_3,$ $A_1 \oplus G_2, A_1 \oplus A_1$
8	A_8 D_8 B_8 C_8 E_8	$A_7 \oplus \mathfrak{u}_1, A_6 \oplus A_1 \oplus \mathfrak{u}_1, A_5 \oplus A_2 \oplus \mathfrak{u}_1,$ $A_4 \oplus A_3 \oplus \mathfrak{u}_1$ $A_7 \oplus \mathfrak{u}_1, A_1 \oplus A_1 \oplus D_6, D_7 \oplus \mathfrak{u}_1$ $A_3 \oplus D_5, D_4 \oplus D_4$ $D_8, B_7 \oplus \mathfrak{u}_1, D_7 \oplus A_1, D_6 \oplus C_2,$ $D_5 \oplus B_3, A_3 \oplus B_5, D_4 \oplus B_4,$ $A_1 \oplus A_1 \oplus B_6$ $A_7 \oplus \mathfrak{u}_1, A_1 \oplus C_7, C_2 \oplus C_6$ $C_3 \oplus C_5, C_4 \oplus C_4$ $A_8, D_8, E_7 \oplus A_1, E_6 \oplus A_2, A_4 \oplus A_4$	$B_4, A_2 \oplus A_2$ $B_4, B_7, C_2 \oplus C_2, A_1 \oplus C_4$ $C_2 \oplus B_5, A_1 \oplus B_6, B_3 \oplus B_4$ A_1 $A_1, C_2, A_1 \oplus D_4$ $A_1, C_2, A_1 \oplus A_2, G_2 \oplus F_4$

Table 8: Maximal subalgebras of the simple Lie algebras upto rank 8.[66]

3 Curating the original Katz–Vafa cases with singleton subalgebras

During the second string revolution, Katz and Vafa proposed a new method for determining matter representations without relying on a duality argument between F-theory and the Heterotic string theory. Historically, the Katz–Vafa method was defined for rank-one enhancements between Lie algebras of type ADE [48]. The Katz–Vafa method is intuitive and user-friendly to most physicists, as it is rooted in the concept of Higgsing and utilizes the method of branching rules familiar from the techniques of Grand Unified Theories since the 1960s. One of the appeals of the Katz–Vafa method is its simplicity and versatility: it relies on relatively simple data and can be applied to M-theory, Type IIA theory, and F-theory compactifications.

The Katz–Vafa method determines the matter representation via the branching rule for the decomposition of the adjoint representation of a parent Lie algebra \mathfrak{m} along one of its proper subalgebras \mathfrak{g} . Given an embedding $\mathfrak{g} \rightarrow \mathfrak{m}$ between two Lie algebras \mathfrak{m} and \mathfrak{g} , we define the *characteristic representation* χ as

$$\text{adj } \mathfrak{m} = \text{adj } \mathfrak{g} \oplus \chi, \quad (3.1)$$

and the characteristic representation can be written as a sum of irreducible linear representations \mathbf{r}_i with multiplicities m_i and \mathbf{r}_0 is the trivial representation:

$$\chi = \sum_{i \geq 0} \mathbf{r}_i^{\oplus m_i}. \quad (3.2)$$

Since an adjoint representation is always real, the characteristic representation χ is also a real representation and necessarily takes the form

$$\chi = \chi_r \oplus \chi_q^{\oplus 2} \oplus \chi_c \oplus \bar{\chi}_c, \quad (3.3)$$

where χ_r is a real representation, χ_q is a pseudo-real representation, χ_c is a complex representation, and $\bar{\chi}_c$ is the complex conjugate of χ_c .

The characteristic representation χ associated to an embedding was introduced by Dynkin in his classification of semisimple subalgebras of simple Lie algebras [13, Chap 1 §1 No 6]. If we pass to Lie groups, the characteristic representation χ corresponds to the isotropic group of the homogeneous space M/G such that $\mathfrak{g} = \text{Lie}(G)$ and $\mathfrak{m} = \text{Lie}(M)$. We introduce the notion of the *reduced characteristic representation* as the representation obtained from χ by removing the trivial representations and all the multiplicities.

This characteristic representation is meaningful both in physical and in mathematical sense. Physically, the characteristic representation χ corresponds to the matter representation \mathbf{R} up to trivial representations and multiplicities. Mathematically, χ is more informative than \mathbf{R} : for example, when \mathfrak{m} is a simple Lie algebra, we can compute the Dynkin index of \mathfrak{g} in \mathfrak{m} from the representation χ . The multiplicities of each irreducible representation is not physical, so we introduce the notion of the *reduced characteristic representation*

$$\chi_{\text{red}} = \sum_{i > 0} \mathbf{r}_i, \quad (3.4)$$

which is the sum of the non-trivial component of χ without any multiplicity. The Lie algebra \mathfrak{g} is the Lie algebra determined by the gauge algebra, while \mathfrak{m} is an “enhancement” characterizing certain codimension-two loci in the base of the elliptic fibration and responsible for the matter. Then it is natural to think that two distinct branching rules that give different characteristic representations might give the same reduced characteristic representation.

The original Katz–Vafa method considers rank one enhancements between simply-laced Lie algebras, listed in Table 9.⁴ It is important to note that, in the cases analyzed in the original Katz–Vafa paper, the branching rules were not explicitly computed but inferred using intersecting branes techniques and the results were checked against explicit Heterotic string theory constructions. We note that the irreducible components of χ are (quasi)-minuscule representations.

$\mathfrak{g} \longrightarrow \mathfrak{m}$	Matter representation \mathbf{R}
$A_{n-k} \oplus A_{k-1} \longrightarrow A_n$	$\mathbf{R} = (\mathbf{n-k+1}, \bar{\mathbf{k}}) \oplus (\overline{\mathbf{n-k+1}}, \mathbf{k})$
$D_{n-2} \oplus A_1 \longrightarrow D_n$	$\mathbf{R} = (2(\mathbf{n-2}), 2)$
$D_{n-4} \oplus A_3 \longrightarrow D_n$	$\mathbf{R} = (2(\mathbf{n-4}), 4) \oplus (2(\mathbf{n-4}), \bar{4}) \oplus (1, 6)$
$D_{n-k} \oplus A_{k-1} \longrightarrow D_n$	$\mathbf{R} = (2(\mathbf{n-k}), \mathbf{k}) \oplus (2(\mathbf{n-k}), \bar{\mathbf{k}}) \oplus (1, \frac{1}{2}\mathbf{k}(\mathbf{k-1})) \oplus (1, \overline{\frac{1}{2}\mathbf{k}(\mathbf{k-1})})$
$D_{n-1} \longrightarrow D_n$	$\mathbf{R} = 2(\mathbf{n-1})$
$A_{n-1} \longrightarrow D_n$	$\mathbf{R} = \frac{1}{2}\mathbf{n}(\mathbf{n-1}) \oplus \overline{\frac{1}{2}\mathbf{n}(\mathbf{n-1})}$
$D_5 \longrightarrow E_6$	$\mathbf{R} = 16 \oplus \bar{16}$
$A_5 \longrightarrow E_6$	$\mathbf{R} = 20$
$E_6 \longrightarrow E_7$	$\mathbf{R} = 27 \oplus \bar{27}$
$D_6 \longrightarrow E_7$	$\mathbf{R} = 32$
$A_6 \longrightarrow E_7$	$\mathbf{R} = 35 \oplus \bar{35} \oplus 7 \oplus \bar{7}$
$E_7 \longrightarrow E_8$	$\mathbf{R} = 56$

Table 9: Matter representations from gauge enhancements of type ADE considered in the original Katz–Vafa’s paper [48].

When \mathfrak{g} is the only subalgebra in its isomorphic class in \mathfrak{m} up to linear equivalence, there is only one possible branching rule and the Katz–Vafa method is perfectly well defined. In such cases, we say that \mathfrak{g} is a *singleton subalgebra* of \mathfrak{m} . However, singleton subalgebras are a minority of subalgebras in a given simple Lie algebra \mathfrak{m} .

In particular, we emphasize that we find non-singleton subalgebras even at the boundary of the cases initially studied in the Katz–Vafa’s paper. For example, the Lie subalgebra $A_1 \oplus A_1$ has two distinct embeddings in A_3 , leading to two distinct branching rules for the adjoint representation of A_3 . These two embeddings also have different Dynkin indices, and the one that produces the

⁴In geometric configurations, both Lie algebras \mathfrak{g} and \mathfrak{m} are associated with some singularities and their degenerations.

representation expected in F-theory has Dynkin embedding index $(1, 1)$. This is a manifestation of what we think is a key data on the Katz–Vafa method: even when multiple choices are possible, it always selects the branching rule corresponding to an embedding $\mathfrak{g} \rightarrow \mathfrak{m}$ with Dynkin index one along all the simple components of \mathfrak{g} . With a slight abuse of nomenclature, we will simply call them *subalgebras of Dynkin (embedding) index one*.

This section aims to curate the original Katz–Vafa cases to shed light on how the Dynkin index clearly shows a preference for index one subalgebras whenever there is an ambiguity. We will separate the Katz–Vafa cases into two sectors: singleton and non-singleton subalgebras. The singleton sector has no ambiguities for determining the matter representations and consists of subalgebras of Dynkin embedding index one. For non-singleton subalgebras, we will list all the possible matter content that could be derived from isomorphic but non-linearly equivalent subalgebras. We then observe that the choice consistent with F-theory and M-theory construction is always the ones corresponding to subalgebras of Dynkin’s embedding index one.

3.1 Singleton sectors of the original Katz–Vafa cases

In this section, we give a more detailed description of the cases that are originally studied by Katz and Vafa and listed them in Table 10 after screening to allow parameters such that the branching is consistent with a singleton subalgebra. For each embedding $\mathfrak{g} \rightarrow \mathfrak{m}$, we give explicitly the Dynkin indices of the irreducible components of the subalgebra \mathfrak{g} and the characteristic representation χ such that

$$[\mathbf{adj} \mathfrak{m}] = [\mathbf{adj} \mathfrak{g}] \oplus \chi. \tag{3.5}$$

In Table 10, we used the traditional physics notations to identify representations. We explain these notations below following the order of the entries in Table 10.

1. The defining representation of A_{n-1} is denoted as \mathbf{n} and its complex conjugate is denoted as $\overline{\mathbf{n}}$. Both are minuscule representations. The minuscule and quasi-minuscule representations of the simple Lie algebras are summarized in Table 6.
2. The second antisymmetric representation of A_n is denoted as $\frac{1}{2}\mathbf{n}(\mathbf{n}-1)$ and its complex conjugate is denoted as $\overline{\frac{1}{2}\mathbf{n}(\mathbf{n}-1)}$; both are minuscule representations. In the case of A_3 , the second antisymmetric representation of A_3 is real and denoted as $\mathbf{6}$. Thus, in that case, $\overline{\mathbf{6}} = \mathbf{6}$.
3. The defining representation of D_n is minuscule, real, and denoted as $\mathbf{2n}$.
4. The spinor representation of D_5 of the highest weight $[0, 0, 0, 1, 0]$ is complex and denoted as $\mathbf{16}$, its complex conjugate has the highest weight $[0, 0, 0, 0, 1]$ and is denoted as $\overline{\mathbf{16}}$. Both representations $\mathbf{16}$ and $\overline{\mathbf{16}}$ are minuscule and half-spinor representations of D_5 .
5. The triple antisymmetric representation of A_5 (the highest weight $[0, 0, 1, 0, 0]$) is minuscule, pseudo-real, and denoted as $\mathbf{20}$.
6. The defining representation of E_6 is complex and denoted as $\mathbf{27}$ and its complex conjugate is $\overline{\mathbf{27}}$. Both representations $\mathbf{27}$ and $\overline{\mathbf{27}}$ of E_6 are minuscule representations.

7. The spinor representation of D_6 of the highest weight $[0, 0, 0, 0, 1, 0]$ (resp. $[0, 0, 0, 0, 0, 1]$) is pseudo-real and denoted as **32** (resp. $\overline{\mathbf{32}}$); both are minuscule representations.
8. The triple antisymmetric representation of A_6 is the complex representation **35** of the highest weight $[0, 0, 1, 0, 0, 0]$. Its complex conjugate is the representation $\overline{\mathbf{35}}$ of the highest weight $[0, 0, 0, 1, 0, 0]$. The representations **35** and $\overline{\mathbf{35}}$ of A_6 are both minuscule.
9. The defining representation of E_7 is pseudoreal, quasi-minuscule, and denoted as **56**.

$\mathfrak{g} \rightarrow \mathfrak{m}$	Characteristic representation χ	Index
$A_{n-k} \oplus A_{k-1} \rightarrow A_n$ ($n > k > 1, n \geq 4$)	$\chi = (\mathbf{n} - \mathbf{k} + \mathbf{1}, \overline{\mathbf{k}}) \oplus (\overline{\mathbf{n} - \mathbf{k} + \mathbf{1}}, \mathbf{k}) \oplus (\mathbf{1}, \mathbf{1})$	(1, 1)
$D_{n-2} \oplus A_1 \rightarrow D_n$ ($n \geq 6$)	$\chi = (\mathbf{2n} - \mathbf{4}, \mathbf{2})^{\oplus 2} \oplus (\mathbf{1}, \mathbf{1})^{\oplus 3}$	(1, 1)
$D_{n-4} \oplus A_3 \rightarrow D_n$ ($n \geq 8$)	$\chi = (\mathbf{2n} - \mathbf{8}, \mathbf{1})^{\oplus 2} \oplus (\mathbf{1}, \mathbf{6})^{\oplus 2} \oplus (\mathbf{2n} - \mathbf{8}, \mathbf{6}) \oplus (\mathbf{1}, \mathbf{1})$	(1, 1)
$D_{n-k} \oplus A_{k-1} \rightarrow D_n$ ($k \geq 3, n - k \geq 4$)	$\chi = (\mathbf{2n} - \mathbf{2k}, \mathbf{k}) \oplus (\mathbf{2n} - \mathbf{2k}, \overline{\mathbf{k}}) \oplus (\mathbf{1}, \frac{1}{2}\mathbf{k}(\mathbf{k} - \mathbf{1})) \oplus (\mathbf{1}, \overline{\frac{1}{2}\mathbf{k}(\mathbf{k} - \mathbf{1})}) \oplus (\mathbf{1}, \mathbf{1})$	(1, 1)
$A_{n-1} \rightarrow A_n$ ($n \geq 4$)	$\chi = \mathbf{n} \oplus \overline{\mathbf{n}} \oplus \mathbf{1}$	1
$A_{n-1} \rightarrow D_n$ ($n \geq 5$)	$\chi = \frac{1}{2}\mathbf{n}(\mathbf{n} - \mathbf{1}) \oplus \overline{\frac{1}{2}\mathbf{n}(\mathbf{n} - \mathbf{1})} \oplus \mathbf{1}$	1
$D_{n-1} \rightarrow D_n$ ($n \geq 5$)	$\chi = (\mathbf{2n} - \mathbf{2})^{\oplus 2} \oplus \mathbf{1}$	1
$D_5 \rightarrow E_6$	$\chi = \mathbf{16} \oplus \overline{\mathbf{16}} \oplus \mathbf{1}$	1
$A_5 \rightarrow E_6$	$\chi = \mathbf{20}^{\oplus 2} \oplus \mathbf{1}^{\oplus 3}$	1
$E_6 \rightarrow E_7$	$\chi = \mathbf{27} \oplus \overline{\mathbf{27}} \oplus \mathbf{1}$	1
$D_6 \rightarrow E_7$	$\chi = \mathbf{32}^{\oplus 2} \oplus \mathbf{1}^{\oplus 3}$	1
$A_6 \rightarrow E_7$	$\chi = \mathbf{35} \oplus \overline{\mathbf{35}} \oplus \mathbf{7} \oplus \overline{\mathbf{7}}$	1
$E_7 \rightarrow E_8$	$\chi = \mathbf{56}^{\oplus 2} \oplus \mathbf{1}^{\oplus 3}$	1

Table 10: Complete branching rules of the embeddings $\mathfrak{g} \rightarrow \mathfrak{m}$ described in the Katz–Vafa’s paper. By definition $[\mathbf{adj} \mathfrak{m}] = [\mathbf{adj} \mathfrak{g}] \oplus \chi$. In the last column, we indicate the Dynkin index of the embedding $\mathfrak{g} \rightarrow \mathfrak{m}$. We restrict the values of k and n to ensure that the Lie subalgebra \mathfrak{g} is unique in its isomorphic class up to linear equivalence in \mathfrak{m} .

3.2 Non-singleton subalgebras among the original Katz–Vafa’s cases

In this section, we scrutinize Katz–Vafa cases in which the subalgebra \mathfrak{g} is not unique up to linear equivalence in its isomorphic class inside the parent subalgebra \mathfrak{m} . These are the *non-singleton subalgebras*. They are all boundary cases of the generic singleton cases of the Katz–Vafa cases. First

we show that such subalgebras do exist. Two of the Katz–Vafa’s cases, namely

$$D_{n-4}^1 \oplus A_3^1 \rightarrow D_n \quad \text{and} \quad D_{n-k} \oplus A_{k-1} \rightarrow D_n, \quad (3.6)$$

share an intersection, which has not been studied in the literature. When $k = 4$ (or $k = n - 3$), they both give an embedding $D_{n-4}^1 \oplus A_3^1 \rightarrow D_n$. However, they give distinct characteristic representations, namely:

$$[\mathbf{adj}_{\mathfrak{so}_{2n}}] = [(\mathbf{adj}_{\mathfrak{so}_{2n-8}}, \mathbf{1}) \oplus (\mathbf{1}, \mathbf{15})] \oplus (\mathbf{1}, \mathbf{6})^{\oplus 2} \oplus (\mathbf{1}, \mathbf{1}) \oplus (\mathbf{2n} - \mathbf{8}, \mathbf{6}) \oplus (\mathbf{2n} - \mathbf{8}, \mathbf{1})^{\oplus 2}, \quad (3.7)$$

$$[\mathbf{adj}_{\mathfrak{so}_{2n}}] = [(\mathbf{adj}_{\mathfrak{so}_{2n-8}}, \mathbf{1}) \oplus (\mathbf{1}, \mathbf{15})] \oplus (\mathbf{1}, \mathbf{6})^{\oplus 2} \oplus (\mathbf{1}, \mathbf{1}) \oplus (\mathbf{2n} - \mathbf{8}, \bar{\mathbf{4}}) \oplus (\mathbf{2n} - \mathbf{8}, \mathbf{4}). \quad (3.8)$$

The first one uses the representation $\mathbf{6}$ of A_3 and does not use the spin representation of A_3 , while the second one explicitly uses the spin representation $\mathbf{4}$ of A_3 . Using the small rank isomorphism $\text{Spin}(6) \cong \text{SU}(4)$, we determine that the first branching rule given in the equation (3.7) is compatible with a gauge group $\text{SO}(2n-8) \times \text{SO}(6)$, while the second one given by the equation (3.8) is compatible with a gauge group $\text{SO}(2n-8) \times \text{SU}(4)$.

All the other cases are related to one of the following rank isomorphisms involving D_n :

$$D_1 \cong A_1, \quad D_2 \cong A_1 \oplus A_1, \quad D_3 \cong A_3. \quad (3.9)$$

Utilizing these isomorphisms, we get the following boundary cases:

$$A_1 \rightarrow A_2 \quad (3.10)$$

$$A_1 \oplus A_1 \rightarrow A_3, \quad (3.11)$$

$$A_3 \rightarrow D_4, \quad (3.12)$$

$$A_3 \oplus A_1 \rightarrow D_5, \quad (3.13)$$

$$A_3 \oplus A_1 \oplus A_1 \rightarrow D_6, \quad (3.14)$$

$$A_3 \oplus A_3 \rightarrow D_7. \quad (3.15)$$

In each case, the subalgebra is not unique up to linear equivalence. We will scrutinize each case in the rest of this section.

3.3 $A_1 \rightarrow A_2$

Despite the simple appearance, the case of $A_1 \rightarrow A_2$ gives rise to two distinct embeddings:

$$A_1^1 \rightarrow A_2: \quad [\mathbf{8}] = [\mathbf{3}] \oplus \chi, \quad \chi = \mathbf{2}^{\oplus 2} \oplus \mathbf{1}, \quad (3.16)$$

$$A_1^2 \rightarrow A_2: \quad [\mathbf{8}] = [\mathbf{3}] \oplus \chi, \quad \chi = \mathbf{5}. \quad (3.17)$$

The first one give rise to an embedding of Dynkin index one, however, the other one corresponds to an embedding with a Dynkin index two. The matter representation from the geometric perspective corresponds to the first one, which demonstrates the effectiveness of our proposal as a selection rule. Having two distinct matter contents are not surprising since these corresponds to the gauge groups $\text{SU}(2)$ and $\text{SO}(3)$ respectively that are both subgroups of $\text{SU}(3)$.

3.4 The $A_1 \oplus A_1 \rightarrow A_3$ case

Up to linear equivalence, there are two classes of embeddings of type $A_1 \oplus A_1 \rightarrow A_3$:

$$A_1^1 \oplus A_1^1 \rightarrow A_3 : \quad [\mathbf{15}] = [(\mathbf{3}, \mathbf{1}) \oplus (\mathbf{1}, \mathbf{3})] \oplus (\mathbf{2}, \mathbf{2})^{\oplus 2} \oplus (\mathbf{1}, \mathbf{1}), \quad (3.18)$$

$$A_1^2 \oplus A_1^2 \rightarrow A_3 : \quad [\mathbf{15}] = [(\mathbf{3}, \mathbf{1}) \oplus (\mathbf{1}, \mathbf{3})] \oplus (\mathbf{3}, \mathbf{3}). \quad (3.19)$$

They have distinct Dynkin indices and characteristic representations. The embedding of index one, namely $A_1^1 \oplus A_1^1 \rightarrow A_3$, gives the matter content that we expect at the collision of two branes carrying each an $SU(2)$ gauge group with the bifundamental matter $(\mathbf{2}, \mathbf{2})$. In F-theory, this representation is observed for the $Spin(4)$ and $SO(4)$ -model studied in [29].

We note that this is exactly the case considered in the original Katz–Vafa for the A-series where the Levi rule is used to rule out equation (3.19) and remain the equation (3.18) solely as the correct matter representation listed in Table 10.

However, despite that the embedding of equation (3.19) does not produce the bifundamental representation one would expect from D-brane construction, it does correspond to a representation familiar in string theory compactification. In fact, the matter transforming in the representation $(\mathbf{3}, \mathbf{3})$ appears naturally when the bosonic string is compactified on a circle of self-dual radius as discussed in [61, Section 8.3].

3.5 $A_3 \rightarrow D_4$

There are three nonequivalent subalgebras of type A_3 in D_4 . They are connected by triality as each copy of A_3 corresponds to removing one of the legs of D_4 . They all have Dynkin index one and give the same branching rule for the adjoint representation of D_4 :

$$A_3^1 \rightarrow D_4 : \quad [\mathbf{28}] = [\mathbf{15}] \oplus \chi, \quad \chi = \mathbf{6} \oplus \mathbf{1}. \quad (3.20)$$

Unlike the adjoint representation, they have different branchings for the vector and spinor representations of D_4 :

$$A_3^1 \rightarrow D_4 : \quad [\mathbf{28}] = [\mathbf{15}] \oplus \mathbf{6} \oplus \mathbf{1}, \quad \mathbf{8}_v = \mathbf{4} \oplus \bar{\mathbf{4}}, \quad \mathbf{8}_s = \mathbf{4} \oplus \bar{\mathbf{4}}, \quad \mathbf{8}_c = \mathbf{6} \oplus \mathbf{1}^{\otimes 2}, \quad (3.21)$$

$$A_3^1 \rightarrow D_4 : \quad [\mathbf{28}] = [\mathbf{15}] \oplus \mathbf{6} \oplus \mathbf{1}, \quad \mathbf{8}_v = \mathbf{4} \oplus \bar{\mathbf{4}}, \quad \mathbf{8}_s = \mathbf{6} \oplus \mathbf{1}^{\otimes 2}, \quad \mathbf{8}_c = \mathbf{4} \oplus \bar{\mathbf{4}}, \quad (3.22)$$

$$A_3^1 \rightarrow D_4 : \quad [\mathbf{28}] = [\mathbf{15}] \oplus \mathbf{6} \oplus \mathbf{1}, \quad \mathbf{8}_v = \mathbf{6} \oplus \mathbf{1}^{\otimes 2}, \quad \mathbf{8}_s = \mathbf{4} \oplus \bar{\mathbf{4}}, \quad \mathbf{8}_c = \mathbf{4} \oplus \bar{\mathbf{4}}. \quad (3.23)$$

These three enhancements are familiar from the antisymmetric representation of the $SU(4)$ -model [36] and the full matter representation of the $SO(6)$ -model [22].

3.6 $A_1 \oplus A_3 \rightarrow D_5$

There are two linearly inequivalent subalgebras isomorphic to $A_1 \oplus A_3$ in D_5 and they differ by their Dynkin indices and their characteristic representations:

$$A_1^1 \oplus A_3^1 \rightarrow D_5 : \quad [\mathbf{45}] = [(\mathbf{3}, \mathbf{1}) \oplus (\mathbf{1}, \mathbf{15})] \oplus (\mathbf{2}, \mathbf{6})^{\oplus 2} \oplus (\mathbf{1}, \mathbf{1})^{\oplus 3}, \quad (3.24)$$

$$A_1^2 \oplus A_3^1 \rightarrow D_5 : \quad [\mathbf{45}] = [(\mathbf{3}, \mathbf{1}) \oplus (\mathbf{1}, \mathbf{15})] \oplus (\mathbf{3}, \mathbf{6}) \oplus (\mathbf{3}, \mathbf{1}) \oplus (\mathbf{1}, \mathbf{6}). \quad (3.25)$$

The branching rule in equation (3.24) has Dynkin index one and has bifundamental representation as expected for a generic model $SU(2) \times SU(4)/\mathbb{Z}_2$, which is derived geometrically in [30]. We do not know any model satisfying the branching rule given in equation (3.25), however, it is compatible with the matter content of an $SO(3) \times SO(6)$ -model since there is no appearance of the spin representation $\mathbf{2}$ of $SU(2)$.

3.7 $A_3 \oplus A_1 \oplus A_1 \rightarrow D_6$

There are three distinct embeddings of the Lie algebra $A_3 \oplus A_1 \oplus A_1$ as a subalgebra of D_6 . They have the following Dynkin indices and branching rule for the adjoint representation:

$$A_3^1 \oplus A_1^1 \oplus A_1^1 \rightarrow D_6 : \quad [\mathbf{66}] = [(\mathbf{15}, \mathbf{1}, \mathbf{1}) \oplus (\mathbf{3}, \mathbf{1}, \mathbf{1}) \oplus (\mathbf{1}, \mathbf{3}, \mathbf{1})] \oplus \chi, \quad (3.26)$$

$$\chi = (\mathbf{4}, \mathbf{2}, \mathbf{2}) \oplus (\bar{\mathbf{4}}, \mathbf{2}, \mathbf{2}) \oplus (\mathbf{6}, \mathbf{1}, \mathbf{1})^{\oplus 2} \oplus (\mathbf{1}, \mathbf{1}, \mathbf{1}),$$

$$A_3^1 \oplus A_1^1 \oplus A_1^1 \rightarrow D_6 : \quad [\mathbf{66}] = [(\mathbf{15}, \mathbf{1}, \mathbf{1}) \oplus (\mathbf{3}, \mathbf{1}, \mathbf{1}) \oplus (\mathbf{1}, \mathbf{3}, \mathbf{1})] \oplus \chi, \quad (3.27)$$

$$\chi = (\mathbf{1}, \mathbf{2}, \mathbf{2})^{\oplus 2} \oplus (\mathbf{6}, \mathbf{2}, \mathbf{2}) \oplus (\mathbf{6}, \mathbf{1}, \mathbf{1})^{\oplus 2} \oplus (\mathbf{1}, \mathbf{1}, \mathbf{1}),$$

$$A_3^1 \oplus A_1^2 \oplus A_1^2 \rightarrow D_6 : \quad [\mathbf{66}] = [(\mathbf{15}, \mathbf{1}, \mathbf{1}) \oplus (\mathbf{3}, \mathbf{1}, \mathbf{1}) \oplus (\mathbf{1}, \mathbf{3}, \mathbf{1})] \oplus \chi, \quad (3.28)$$

$$\chi = (\mathbf{1}, \mathbf{3}, \mathbf{3}) \oplus (\mathbf{6}, \mathbf{3}, \mathbf{1}) \oplus (\mathbf{6}, \mathbf{1}, \mathbf{3}).$$

In the equations (3.26) and (3.27), we have two subalgebras $A_3 \oplus A_1 \oplus A_1$ of index one in D_6 but with different characteristic representations. Such situations are to be expected as A_3 is the Lie algebra of both $SU(4)$ and $SO(6)$ and the resulting representations in a gauge theory will be different. This is easy to be witnessed as the equation (3.26) yields the representations $\mathbf{4}$ and $\bar{\mathbf{4}}$ corresponding to the gauge algebra $SU(4)$ whereas the equation (3.27) yields the representation $\mathbf{6}$ corresponding to the gauge algebra $SO(6)$.

3.8 $A_3 \oplus A_3 \rightarrow D_7$

There are two linearly nonequivalent subalgebras $A_3 \oplus A_3$ in D_7 and they both have Dynkin index one for each of their simple components. But they have distinct characteristic representations:

$$A_3^1 \oplus A_3^1 \rightarrow D_7 : \quad [\mathbf{91}] = [(\mathbf{15}, \mathbf{1}) \oplus (\mathbf{1}, \mathbf{15})] \oplus (\mathbf{4}, \mathbf{6}) \oplus (\bar{\mathbf{4}}, \mathbf{6}) \oplus (\mathbf{6}, \mathbf{1})^{\oplus 2} \oplus (\mathbf{1}, \mathbf{1}), \quad (3.29)$$

$$A_3^1 \oplus A_3^1 \rightarrow D_7 : \quad [\mathbf{91}] = [(\mathbf{15}, \mathbf{1}) \oplus (\mathbf{1}, \mathbf{15})] \oplus (\mathbf{6}, \mathbf{6}) \oplus (\mathbf{1}, \mathbf{6})^{\oplus 2} \oplus (\mathbf{6}, \mathbf{1})^{\oplus 2} \oplus (\mathbf{1}, \mathbf{1}). \quad (3.30)$$

This shows that in a given isomorphism class, the subalgebra of embedding index one is not necessarily unique. Such cases are rare but do exist. When the parent Lie algebra has a nontrivial center, the global structure of the Lie group can help select one embedding over another. For example, in the current case, the first branching rule given in equation (3.29) involves the spin representations $\mathbf{4}$ and $\bar{\mathbf{4}}$ of D_3 while the other one given in equation (3.30) does not.

4 Beyond the Katz–Vafa cases: singleton subalgebras

In this section, we explore branching rules from the embeddings $\mathfrak{g} \rightarrow \mathfrak{m}$ of type ADE that are not in the original cases of Katz–Vafa. To ensure that the Katz–Vafa method is not ambiguous, we consider subalgebras $\mathfrak{g} \subset \mathfrak{m}$ that admit a unique embedding $\mathfrak{g} \rightarrow \mathfrak{m}$. More precisely, we consider singleton embeddings, which is defined as following.

Definition 4.1. An embedding $\mathfrak{g} \subset \mathfrak{m}$ is said to be a *singleton embedding* if there is no other embedding $\mathfrak{s} \rightarrow \mathfrak{m}$ such that \mathfrak{g} is isomorphic to \mathfrak{s} , while \mathfrak{g} and \mathfrak{s} are not linearly equivalent.

All the singleton subalgebras of simple Lie algebras up to rank eight are classified in [15]. In the context of this section, we will only consider those that are ADE semisimple Lie subalgebras inside E_6 , E_7 , and E_8 . They are listed in Table 11.

We focus on exploring the branching rules for the embeddings $\mathfrak{g} \rightarrow \mathfrak{m}$ given by Miranda’s models. Miranda’s models have seven types of collisions of Kodaira fibers that we consider here as ADE cases [6?]. These embeddings are a natural extension of the cases considered by Katz–Vafa and are inspired by the geometry of elliptic threefolds defined by Weierstrass models:

$$\left\{ \begin{array}{l} I_n + I_m \rightarrow \text{“}I_{n+m}\text{”}, \quad (n, m > 0), \\ I_n + I_m^* \rightarrow \text{“}I_{n+m}^*\text{”}, \quad (n > 0, m > 0) \\ II + IV \rightarrow \text{“}I_0^*\text{”} \\ II + I_0^* \rightarrow \text{“}IV^*\text{”}, \\ III + I_0^* \rightarrow \text{“}III^*\text{”}, \\ II + IV^* \rightarrow \text{“}II^*\text{”}, \\ IV + I_0^* \rightarrow \text{“}II^*\text{”}. \end{array} \right. \quad (4.1)$$

These collisions of singularities often appear in F-theory models [6, 28]. In contrast to those of Katz–Vafa, they are not always rank-one enhancements. The dual graphs of these fibers suggest the following embeddings when all Kodaira fibers are understood to be of split types:

$$\left\{ \begin{array}{l} A_{n-1} \oplus A_{m-1} \rightarrow A_{n+m-1}, \quad (n, m > 0), \\ A_{n-1} \oplus D_{4+m} \rightarrow D_{n+m+4}, \quad (n, m > 0), \\ A_2 \rightarrow D_4, \\ D_4 \rightarrow E_6, \\ A_1 \oplus D_4 \rightarrow E_7, \\ E_6 \rightarrow E_8, \\ A_2 \oplus D_4 \rightarrow E_8, \\ A_1 \oplus D_4 \rightarrow E_8. \end{array} \right. \quad (4.2)$$

We have already studied the three embeddings in Section 3 as a part of the original Katz–Vafa’s

cases. We consider the rest of the new embeddings that corresponds to the following five cases:

$$D_4 \rightarrow E_6, \quad A_1 \oplus D_4 \rightarrow E_7, \quad E_6 \rightarrow E_8, \quad A_2 \oplus D_4 \rightarrow E_8, \quad A_1 \oplus D_4 \rightarrow E_8. \quad (4.3)$$

They are rank-two enhancements. We can use our understanding of the geography of semisimple Lie subalgebras of exceptional Lie algebras to streamline the analysis [15]. There is no possible ambiguity for applying the Katz–Vafa method to these five cases as they are all singleton embeddings (the singleton embeddings are embeddings of the type $\mathfrak{g} \rightarrow \mathfrak{m}$ where \mathfrak{g} is unique in \mathfrak{m} up to linear equivalence, see Definition 4.1). Moreover, each case has Dynkin index one.

\mathfrak{g}	ADE semisimple singleton subalgebras $\mathfrak{g} \subset \mathfrak{m}$
A_2	none
A_3	A_2
A_4	$A_2, A_3, A_1 \oplus A_2$
D_4	$A_1^{\oplus 4}$
A_5	$A_1 \oplus A_3, A_2^{\oplus 2}, A_4$
D_5	$A_1^{\oplus 2} \oplus A_2, A_1^{\oplus 2} \oplus A_3, A_4, D_4$
E_6	$A_1 \oplus A_1 \oplus A_3, A_1 \oplus A_4, A_1 \oplus A_5, A_2^{\oplus 3}, A_4, A_5, D_4, D_5$
E_7	$A_1^{\oplus 7}, A_1^{\oplus 3} \oplus D_4, A_1 \oplus A_2 \oplus A_3, A_1 \oplus A_3^{\oplus 2}, A_1 \oplus D_5, A_1 \oplus D_6, A_2^{\oplus 3}, A_2 \oplus A_4, A_2 \oplus A_5, A_3^{\oplus 2}, A_4, A_6, A_7, D_5, D_6, E_6$
E_8	$A_1^{\oplus 8}, A_1^{\oplus 4} \oplus D_4, A_1^{\oplus 2} \oplus A_2 \oplus A_3, A_1^{\oplus 2} \oplus A_3^{\oplus 2}, A_1^{\oplus 2} \oplus D_6, A_1 \oplus A_2 \oplus A_4, A_1 \oplus A_2 \oplus A_5, A_1 \oplus A_6, A_1 \oplus A_7, A_1 \oplus E_7, A_2^{\oplus 4}, A_2 \oplus A_4, A_2 \oplus A_5, A_2 \oplus D_5, A_2 \oplus E_6, A_3 \oplus A_4, A_3 \oplus D_4, A_3 \oplus D_5, A_4^{\oplus 2}, D_4 \oplus D_4, A_5, A_6, A_8, D_5, D_6, D_7, D_8, E_6, E_7$

Table 11: Singleton ADE semisimple subalgebras of $A_5, D_5, E_6, E_7,$ and E_8 . Each subalgebra is the only subalgebra (up to linear equivalence) in its isomorphism class. See [15] for the full list of all singleton semisimple subalgebras of simple Lie algebras of rank up to eight.

4.1 $D_4 \rightarrow E_6$

The algebra E_6 has 118 proper Lie subalgebras up to linear equivalence, among whom only one subalgebra is isomorphic to D_4 . It follows that D_4 is a singleton subalgebra of E_6 . Moreover, it has Dynkin index one and gives the following branching rule for the adjoint representation:

$$D_4^1 \rightarrow E_6: \quad [\mathbf{78}] = [\mathbf{28}] \oplus \chi, \quad \chi = \mathbf{8}_v^{\oplus 2} \oplus \mathbf{8}_s^{\oplus 2} \oplus \mathbf{8}_c^{\oplus 2} \oplus \mathbf{1}^{\oplus 2}. \quad (4.4)$$

The Spin(8)-model is studied in [19].

4.2 $\mathbf{A}_1 \oplus \mathbf{D}_4 \rightarrow \mathbf{E}_7$

$$\begin{aligned} \mathbf{A}_1^1 \oplus \mathbf{D}_4^1 \rightarrow \mathbf{E}_7 : \quad [\mathbf{133}] &= [(\mathbf{3}, \mathbf{1}) \oplus (\mathbf{1}, \mathbf{28})] \oplus \chi, \\ \chi &= (\mathbf{1}, \mathbf{8}_v)^{\oplus 4} \oplus (\mathbf{2}, \mathbf{8}_s)^{\oplus 2} \oplus (\mathbf{2}, \mathbf{8}_c)^{\oplus 2} \oplus (\mathbf{1}, \mathbf{1})^{\oplus 6}, \end{aligned} \quad (4.5)$$

$$\begin{aligned} \mathbf{A}_1^1 \oplus \mathbf{D}_4^1 \rightarrow \mathbf{E}_7 : \quad [\mathbf{133}] &= [(\mathbf{3}, \mathbf{1}) \oplus (\mathbf{1}, \mathbf{28})] \oplus \chi, \\ \chi &= (\mathbf{2}, \mathbf{8}_v)^{\oplus 2} \oplus (\mathbf{1}, \mathbf{8}_s)^{\oplus 4} \oplus (\mathbf{2}, \mathbf{8}_c)^{\oplus 2} \oplus (\mathbf{1}, \mathbf{1})^{\oplus 6}, \end{aligned} \quad (4.6)$$

$$\begin{aligned} \mathbf{A}_1^1 \oplus \mathbf{D}_4^1 \rightarrow \mathbf{E}_7 : \quad [\mathbf{133}] &= [(\mathbf{3}, \mathbf{1}) \oplus (\mathbf{1}, \mathbf{28})] \oplus \chi, \\ \chi &= (\mathbf{2}, \mathbf{8}_v)^{\oplus 2} \oplus (\mathbf{2}, \mathbf{8}_s)^{\oplus 2} \oplus (\mathbf{1}, \mathbf{8}_c)^{\oplus 4} \oplus (\mathbf{1}, \mathbf{1})^{\oplus 6}. \end{aligned} \quad (4.7)$$

All the branching rules do not respect the triality with three representations $\mathbf{8}_v$, $\mathbf{8}_c$, and $\mathbf{8}_s$. In fact, the natural branching rule to respect the triality to have $\chi = (\mathbf{2}, \mathbf{8}_v)^{\oplus 2} \oplus (\mathbf{2}, \mathbf{8}_s)^{\oplus 2} \oplus (\mathbf{2}, \mathbf{8}_c)^{\oplus 2} \oplus (\mathbf{1}, \mathbf{1})^{\oplus 6}$ does not exist as a branching rule; this is consistent with that this will yield a fractional Dynkin index.

4.3 $\mathbf{E}_6 \rightarrow \mathbf{E}_8$

The subalgebra \mathbf{E}_6 is a singleton subalgebra of \mathbf{E}_8 of Dynkin index one, and its characteristic representation χ is

$$\mathbf{E}_6^1 \rightarrow \mathbf{E}_8 : \quad [\mathbf{248}] = [\mathbf{78}] \oplus \chi, \quad \chi = \mathbf{27}^{\oplus 3} \oplus \overline{\mathbf{27}}^{\oplus 3} \oplus \mathbf{1}^{\oplus 8}. \quad (4.8)$$

4.4 $\mathbf{A}_3 \oplus \mathbf{D}_4 \rightarrow \mathbf{E}_8$

The subalgebra $\mathbf{A}_3 \oplus \mathbf{D}_4$ is a singleton subalgebra of \mathbf{E}_8 . Its characteristic representation χ is:

$$\begin{aligned} \mathbf{A}_3^1 \oplus \mathbf{D}_4^1 \rightarrow \mathbf{E}_8 : \quad [\mathbf{248}] &= [(\mathbf{15}, \mathbf{1}) \oplus (\mathbf{1}, \mathbf{28})] \oplus \chi, \\ \chi &= (\mathbf{6}, \mathbf{8}_v) \oplus (\mathbf{1}, \mathbf{8}_v)^{\oplus 2} \oplus (\mathbf{6}, \mathbf{1})^{\oplus 2} \oplus (\overline{\mathbf{4}}, \mathbf{8}_c) \oplus (\overline{\mathbf{4}}, \mathbf{8}_s) \oplus (\mathbf{4}, \mathbf{8}_s) \oplus (\mathbf{4}, \mathbf{8}_c) \oplus (\mathbf{1}, \mathbf{1}). \end{aligned} \quad (4.9)$$

The branching rules do not respect the triality with three representations $\mathbf{8}_v$, $\mathbf{8}_c$, and $\mathbf{8}_s$. We note that this is compatible with an $\mathrm{SU}(4) \times \mathrm{Spin}(8)$ -model since we have spinors representations $(\mathbf{4}, \mathbf{8}_s)$ and $(\mathbf{4}, \mathbf{8}_c)$.

4.5 $\mathbf{A}_1 \oplus \mathbf{A}_1 \rightarrow \mathbf{D}_4$

There is a unique subalgebra of the type $\mathbf{A}_1 \oplus \mathbf{A}_1$ in \mathbf{D}_4 [15] and it has Dynkin index $(1, 1)$ and characteristic representation χ given as follows:

$$\mathbf{A}_1^1 \oplus \mathbf{A}_1^1 \rightarrow \mathbf{D}_4 : \quad [\mathbf{28}] = (\mathbf{3}, \mathbf{1}) \oplus (\mathbf{1}, \mathbf{3}) \oplus \chi, \quad \chi = (\mathbf{2}, \mathbf{2})^{\oplus 4} \oplus (\mathbf{1}, \mathbf{1})^{\oplus 6}. \quad (4.10)$$

These representations occur in the $\mathrm{SO}(4)$ -models and $\mathrm{Spin}(4)$ -models [29].

5 The SU(5)-model

There are models from F-theory that give rise to non-singleton subalgebras. We illustrate this point in this section with geometrically well-understood models such as SU(5)-models [36–38] and SO(6)-models [22].

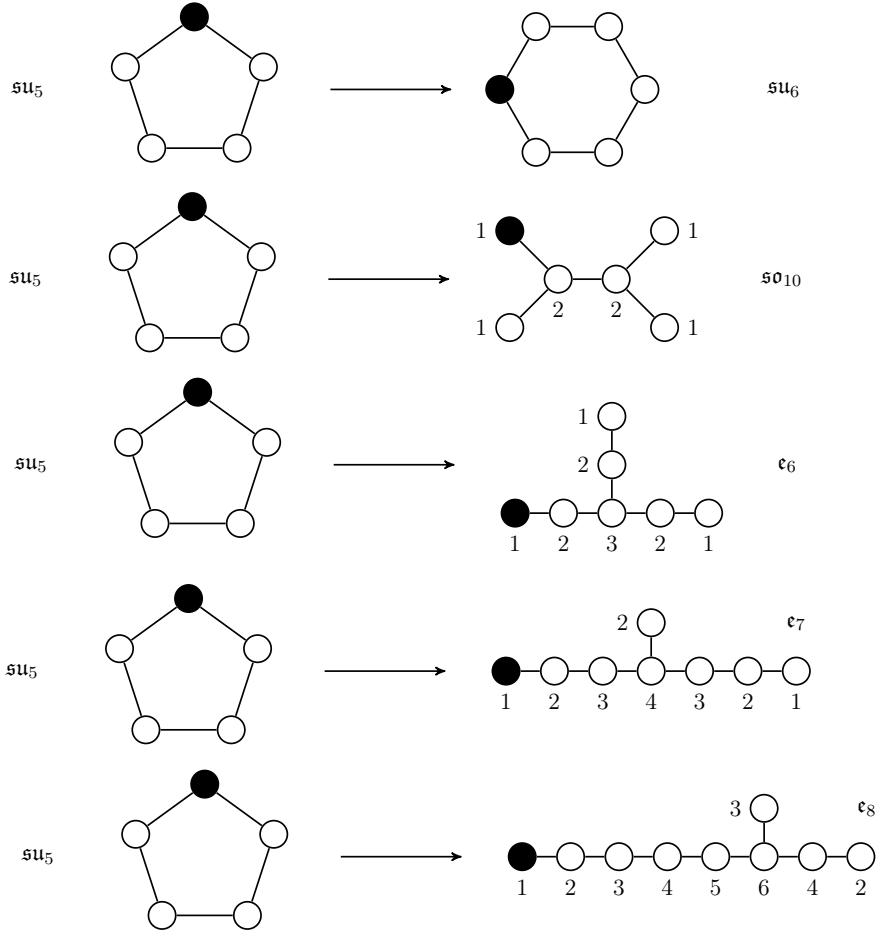

Figure 1: The expected gauge group enhancement of SU(5).

5.1 $A_4 \rightarrow A_5, D_5$

In this section, we study the branching rule of the Lie algebra A_4 in A_5 , E_6 , E_7 , and E_8 , as represented in Figure 1. In this way, we will reproduce the known result of the SU(5)-model with respect to its enhancement to E_6 and E_7 . We will also illustrate how the Dynkin index helps identify the “generic” configuration expected in F-theory when SU(5) enhances to E_8 .

The geometry of the SU(5)-model proposes the following enhancement over codimension two loci, as represented as the first and second rows of Figure 1:

$$\begin{cases} I_5^s \rightarrow I_6^s, \\ I_5^s \rightarrow \text{“}I_1^{*s}\text{”}. \end{cases} \quad (5.1)$$

These fiber enhancements indicate that the matter representations will be induced by the following embeddings.

$$A_4 \rightarrow A_5, \quad (5.2)$$

$$A_4 \rightarrow D_5. \quad (5.3)$$

As we can see from Table 11, A_4 is a singleton subalgebra of both A_5 and D_5 . Thus, the isomorphism class of the subalgebra is enough to completely determine the embedding and the characteristic representation. They are already treated in Table 10 to yield the characteristic representations as

$$A_4 \rightarrow A_5 : \quad \chi = \mathbf{5} \oplus \bar{\mathbf{5}} \oplus \mathbf{1}, \quad (5.4)$$

$$A_4 \rightarrow D_5 : \quad \chi = \mathbf{10} \oplus \bar{\mathbf{10}} \oplus \mathbf{1}. \quad (5.5)$$

5.2 $A_4 \rightarrow E_6, E_7, E_8$

It is also possible to have both representations $\mathbf{5}$ and $\mathbf{10}$ and their complex conjugates by requiring an enhancement of the type

$$I_5^s \rightarrow IV^{*s}, \quad III^*, \quad \text{or} \quad II^*. \quad (5.6)$$

In terms of corresponding algebras, this represents an enhancement from A_4 to E_6 , E_7 , or E_8 , which are represented as the third to fifth rows of Figure 1. There is a unique subalgebra of type A_4 inside E_6 and the same is true inside E_7 . In both cases, the A_4 subalgebra has Dynkin index one. For the case of the enhancement to E_8 , the situation is a bit more complicated. There are two nonlinearly equivalent subalgebras of type A_4 inside E_8 : one subalgebra has Dynkin index one and the other subalgebra has Dynkin index two.

The characteristic representations for the subalgebras of index one are

$$A_4^1 \rightarrow E_6 : \quad [\mathbf{78}] = [\mathbf{24}] \oplus \chi, \quad \chi = \mathbf{5} \oplus \bar{\mathbf{5}} \oplus \mathbf{10}^{\oplus 2} \oplus \bar{\mathbf{10}}^{\oplus 2} \oplus \mathbf{1}^{\oplus 4}, \quad (5.7)$$

$$A_4^1 \rightarrow E_7 : \quad [\mathbf{133}] = [\mathbf{24}] \oplus \chi, \quad \chi = \mathbf{5}^{\oplus 4} \oplus \bar{\mathbf{5}}^{\oplus 4} \oplus \mathbf{10}^{\oplus 3} \oplus \bar{\mathbf{10}}^{\oplus 3} \oplus \mathbf{1}^{\oplus 9}, \quad (5.8)$$

$$A_4^1 \rightarrow E_8 : \quad [\mathbf{248}] = [\mathbf{24}] \oplus \chi, \quad \chi = \mathbf{5}^{\oplus 10} \oplus \bar{\mathbf{5}}^{\oplus 10} \oplus \mathbf{10}^{\oplus 5} \oplus \bar{\mathbf{10}}^{\oplus 5} \oplus \mathbf{1}^{\oplus 24}. \quad (5.9)$$

They all give rise to the same matter representations $\mathbf{5}$, $\mathbf{10}$, and $\mathbf{24}$.

The subalgebra A_4^2 in E_8 is unique up to linear equivalence and has the following branching rule and characteristic representation:

$$A_4^2 \rightarrow E_8 : \quad [\mathbf{248}] = [\mathbf{24}] \oplus \chi, \quad \chi = \mathbf{24} \oplus \mathbf{5} \oplus \bar{\mathbf{5}} \oplus \mathbf{10} \oplus \bar{\mathbf{10}} \oplus \mathbf{40} \oplus \bar{\mathbf{40}} \oplus \mathbf{45} \oplus \bar{\mathbf{45}}. \quad (5.10)$$

We can also distinguish A_4^1 and A_4^2 in E_8 by the fact that A_4^2 is a semisimple subalgebra of $A_4^1 \oplus A_4^1$, while A_4^1 is a subalgebra of E_7 :

$$A_4^2 \rightarrow A_4^1 \oplus A_4^1 \rightarrow E_8, \quad (5.11)$$

$$A_4^1 \rightarrow A_5^1 \rightarrow D_5^1 \rightarrow E_6^1 \rightarrow E_7^1 \rightarrow E_8. \quad (5.12)$$

6 G_2 and F_4 -models

In [39], the following branching rules are listed to explain the appearance of the fundamental matters for G_2 and F_4 -models:

$$G_2 \rightarrow D_4 \quad : \quad \mathbf{28} = \mathbf{14} \oplus \mathbf{7}^{\oplus 2}, \quad F_4 \rightarrow E_6 \quad : \quad \mathbf{78} = \mathbf{52} \oplus \mathbf{26}. \quad (6.1)$$

While these branching rules give the correct matter content observed in F-theory (namely, the representation $\mathbf{7}$ for G_2 [19] and the representation $\mathbf{26}$ for F_4 [23]), they are incompatible with the geometry of the localized enhancements of the fibers of these geometries. For the F_4 -model, the fiber IV^{*ns} has localized enhancements not to an incomplete E_6 but rather to an incomplete E_7 (whose fiber is III^*) or an incomplete E_8 (whose fiber is II^*) depending on the valuations of the Weierstrass coefficients.

This choice is also not minimal as we can get the representation $\mathbf{7}$ from the unique embedding of G_2 in B_3 where G_2 is a maximal subalgebra.

The crepant resolution of the Weierstrass models of G_2 and F_4 -models are studied in detail respectively in [19] and [23]. The geometry of these fibrations suggests that the matter content derived by the Katz–Vafa algorithm should be based on the branching rules for the following embeddings:

$$G_2 \rightarrow D_5, \quad G_2 \rightarrow E_6, \quad F_4 \rightarrow E_7, \quad F_4 \rightarrow E_8. \quad (6.2)$$

Our discussion will rely on the geography of the subalgebras of D_5 , E_6 , E_7 , and E_8 [15]. It would be desirable to identify branching rules that explain the observed matter representation using the Katz–Vafa picture while being consistent with the geometry.

- The Lie algebra G_2 is a singleton subalgebra of B_3 , D_4 , and D_5 , and has Dynkin index one in all of them. Thus, the embedding of G_2 in these Lie groups give a unique characteristic representation in each case.
- The Lie algebra G_2 has two non-linearly equivalent embeddings in E_6 : One is an R-subalgebra of Dynkin index one and the other one is a maximal S-subalgebra of E_6 with Dynkin index three.
- The Lie subalgebra F_4 is a singleton subalgebra of Dynkin index one of E_6 , E_7 , and E_8 . It follows that the characteristic representation for F_4 in all the exceptional subalgebras is unique.

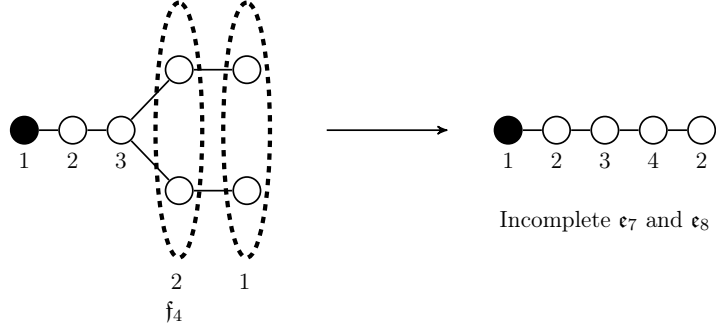

Figure 2: Degeneration of the F_4 fiber at the non-transverse collision $IV^{*ns} + I_1$.

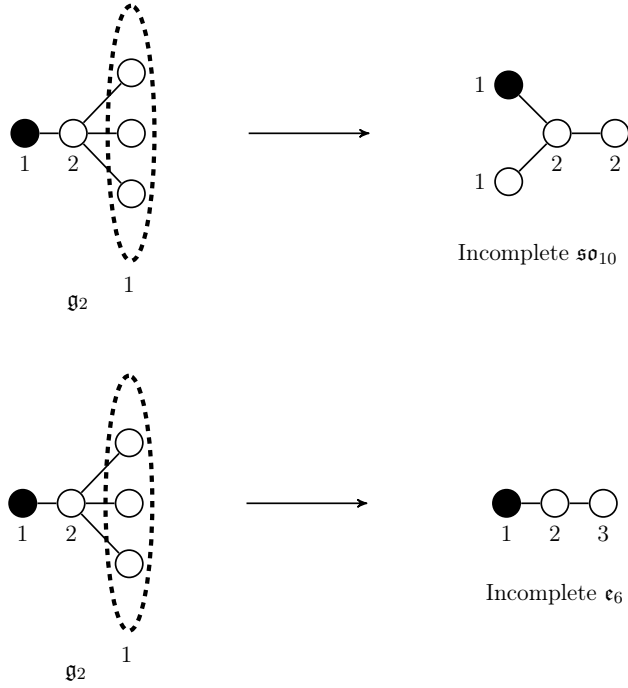

Figure 3: Degeneration of the G_2 fiber.

6.1 $G_2 \rightarrow B_3, D_4, D_5, E_6$

The list of all possible branching rules are

$$G_2^1 \rightarrow B_3 : \quad [21] = [14] \oplus \chi, \quad \chi = \mathbf{7}, \quad (6.3)$$

$$G_2^1 \rightarrow D_4 : \quad [28] = [14] \oplus \chi, \quad \chi = \mathbf{7}^{\oplus 2}, \quad (6.4)$$

$$G_2^1 \rightarrow D_5 : \quad [45] = [14] \oplus \chi, \quad \chi = \mathbf{7}^{\oplus 4} \oplus \mathbf{1}^3, \quad (6.5)$$

$$G_2^1 \rightarrow E_6 : \quad [78] = [14] \oplus \chi, \quad \chi = \mathbf{7}^8 \oplus \mathbf{1}^8, \quad (6.6)$$

$$G_2^3 \rightarrow E_6 : \quad [78] = [14] \oplus \chi, \quad \chi = \mathbf{64}. \quad (6.7)$$

All the embeddings of G_2 in B_3 , D_4 , and D_5 have Dynkin index one and the same reduced characteristic representation, namely the representation **7**. However, there are two linearly inequivalent representations of G_2 in E_6 with Dynkin index one and two. The one with Dynkin index one gives again the representation **7**. However, the one of Dynkin index two gives the isotropic characteristic representation **64**.

6.2 $F_4 \rightarrow E_6, E_7, E_8$

$$F_4^1 \rightarrow E_6 : \quad [\mathbf{78}] = [\mathbf{52}] \oplus \chi, \quad \chi = \mathbf{26}, \quad (6.8)$$

$$F_4^1 \rightarrow E_7 : \quad [\mathbf{133}] = [\mathbf{52}] \oplus \chi, \quad \chi = \mathbf{26}^{\oplus 3} \oplus \mathbf{1}^{\oplus 3}, \quad (6.9)$$

$$F_4^1 \rightarrow E_8 : \quad [\mathbf{248}] = [\mathbf{52}] \oplus \chi, \quad \chi = \mathbf{26}^{\oplus 7} \oplus \mathbf{1}^{\oplus 14}. \quad (6.10)$$

In contrast to the case of G_2 , for F_4 -models, there is no room for ambiguity: all the embeddings of F_4 in E_n ($n = 6, 7, 8$) have Dynkin index one and give the same reduced characteristic representations, namely the representation **26**.

7 The Spin(7)-model

The geometry of the Spin(7)-model is studied in [19]. The possible degenerations of the generic fiber I_0^{*ss} suggest the following embeddings:

$$B_3 \rightarrow D_4, \quad B_3 \rightarrow B_4, \quad B_3 \rightarrow D_5, \quad B_3 \rightarrow F_4, \quad B_3 \rightarrow E_6. \quad (7.1)$$

We will rely on the geography of semisimple subalgebras of D_4 , B_4 , D_5 , F_4 , and E_6 to quickly explain these embeddings [15]. We will number the embeddings according to how they appear in de Graaf's database. There is a particular implication to these cases: the triality and its breaking by an uplift. We will also see that F_4 and E_6 contains Spin(7) as a subgroup as they clearly require the presence of the spin representation of Spin(7).

7.1 $B_3^1 \rightarrow D_4$

The subalgebra B_3 is embedded in D_4 in three distinct ways corresponding to three maximal S-subalgebra of Dynkin index one connected by triality. The embedding of B_3 in D_4 is an example of an adjoint singleton subalgebra: the embeddings are not linearly equivalent but they give the same characteristic representation, namely the representation **7** of B_3 :

$$B_3^1 \rightarrow D_4 : \quad [\mathbf{28}] = [\mathbf{21}] \oplus \chi, \quad \chi = \mathbf{7}. \quad (7.2)$$

We note that we get an isotropic characteristic representation (χ is irreducible).

7.2 $B_3^1 \rightarrow B_4$ or B_5

When D_4 is embedded in B_4 , we see the breaking of triality in two different ways, which gives two different groups compatible whose algebra is B_3 . Two of the three non-linearly equivalent subalgebra

B_3 of D_4 becomes linearly equivalent in B_4 . It follows that B_3 can be embedded in two different ways in B_4 , both have Dynkin index one and are contained in D_4 :

$$B_3^1 \rightarrow B_4: \quad [\mathbf{36}] = [\mathbf{21}] \oplus \chi, \quad \chi = \mathbf{7} \oplus \mathbf{8}, \quad (7.3)$$

$$B_3^1 \rightarrow B_4: \quad [\mathbf{36}] = [\mathbf{21}] \oplus \chi, \quad \chi = \mathbf{7}^{\oplus 2} \oplus \mathbf{1}. \quad (7.4)$$

The distinction between the two cases is clear when we consider the possible global structure of a compact group with Lie algebra B_3 . The first embedding is compatible with the group $\text{Spin}(7)$ as it involves the spin representation $\mathbf{8}$ of B_3 , while the second embedding is only compatible with $\text{SO}(7)$ since it involves only the vector and trivial representation of B_3 .

There are two distinct embeddings of B_3 in D_5 , whose Dynkin index is one but can be differentiated from each other by the presence of the spin representation $\mathbf{8}$:

$$B_3^1 \rightarrow D_5: \quad [\mathbf{45}] = [\mathbf{21}] \oplus \chi, \quad \chi = \mathbf{7} \oplus \mathbf{8}^{\oplus 2} \oplus \mathbf{1}, \quad (7.5)$$

$$B_3^1 \rightarrow D_5: \quad [\mathbf{45}] = [\mathbf{21}] \oplus \chi, \quad \chi = \mathbf{7}^{\oplus 3} \oplus \mathbf{1}^{\oplus 3}. \quad (7.6)$$

7.3 $B_3^1 \rightarrow F_4$ or E_6

The Lie algebra B_3 is a singleton subalgebra of both F_4 and E_6 and it has index one in both of them. In both cases, we get both vector, spin, and trivial representations of B_3 :

$$B_3^1 \rightarrow F_4: \quad [\mathbf{52}] = [\mathbf{21}] \oplus \chi, \quad \chi = \mathbf{7}^{\oplus 2} \oplus \mathbf{8}^{\oplus 2} \oplus \mathbf{1}, \quad (7.7)$$

$$B_3^1 \rightarrow E_6: \quad [\mathbf{78}] = [\mathbf{21}] \oplus \chi, \quad \chi = \mathbf{7}^{\oplus 3} \oplus \mathbf{8}^{\oplus 4} \oplus \mathbf{1}^{\oplus 4}. \quad (7.8)$$

8 The $\text{USp}(4)$ -model

The $\text{USp}(4)$ -model is interesting in many ways [21]. We recall that $\text{USp}(4)$ is isomorphic to $\text{Spin}(5)$ and is the universal cover of $\text{SO}(5)$. This is related to the isomorphism between C_2 and B_2 . The analysis of the fibers of $\text{USp}(4)$ -model shows that the localized matter contains representations $\mathbf{5}$ and $\mathbf{4}$ of C_2 . The $\text{SO}(5)$ -model contains matter only in the representation $\mathbf{5}$. The fiber appearing geometrically are of type I_5 , I_0^* , and I_1^* . The generic fiber is itself I_4^{ns} with an I_4 as a geometric fiber. It is therefore natural to investigate the embedding of C_2 in A_3 , C_3 , B_3 , A_4 , D_4 , D_5 .

The geographies of all these simple Lie algebras are studied in [15]. The key points are the following:

- C_2 is a singleton subalgebra of A_3 , B_3 , and C_3 .
- There are two subalgebras of A_4 of type C_2 with distinct Dynkin 1 and 2.
- There are three subalgebras of D_4 of type C_2 and they are related by triality and are adjoint singletons.
- There are four subalgebras of D_5 of type C_2 , two have index one, one has index 2, and the last has index 3.

8.1 $C_2 \rightarrow A_3$

There is a unique embedding of C_2 in A_3 up to linear equivalence. Moreover, this embedding has Dynkin embedding index one and its characteristic representation is isotropic:

$$C_2^1 \rightarrow A_3: \quad [\mathbf{15}] = [\mathbf{10}] \oplus \chi, \quad \chi = \mathbf{5}, \quad (8.1)$$

8.2 $C_2 \rightarrow B_3$

There is a unique embedding of C_2 in B_3 up to linear equivalence and its Dynkin embedding index is one:

$$C_2^1 \rightarrow B_3: \quad [\mathbf{21}] = [\mathbf{10}] \oplus \chi, \quad \chi = \mathbf{5}^{\oplus 2} \oplus \mathbf{1}, \quad (8.2)$$

8.3 $C_2 \rightarrow C_3$

There is a unique embedding of C_2 in C_3 up to linear equivalence and its Dynkin embedding index is one:

$$C_2^1 \rightarrow C_3: \quad [\mathbf{21}] = [\mathbf{10}] \oplus \chi, \quad \chi = \mathbf{4}^{\oplus 2} \oplus \mathbf{1}^{\oplus 3}, \quad (8.3)$$

8.4 $C_2 \rightarrow A_4$

There are two embeddings of C_2 in A_4 up to linear equivalence, including one with Dynkin embedding index one:

$$C_2^1 \rightarrow A_4: \quad [\mathbf{24}] = [\mathbf{10}] \oplus \chi, \quad \chi = \mathbf{5} \oplus \mathbf{4}^{\oplus 2} \oplus \mathbf{1}, \quad (8.4)$$

$$C_2^2 \rightarrow A_4: \quad [\mathbf{24}] = [\mathbf{10}] \oplus \chi, \quad \chi = \mathbf{14}, \quad (8.5)$$

8.5 $C_2 \rightarrow D_4$

There is a unique embedding of C_2 in D_4 up to linear equivalence and its Dynkin embedding index is one:

$$C_2^1 \rightarrow D_4: \quad [\mathbf{28}] = [\mathbf{10}] \oplus \chi, \quad \chi = \mathbf{5}^{\oplus 3} \oplus \mathbf{1}^{\oplus 3}, \quad (8.6)$$

8.6 $C_2 \rightarrow D_5$

There are four embeddings of C_2 in D_5 up to linear equivalence, one of them has Dynkin index one:

$$C_2^1 \rightarrow D_5: \quad [\mathbf{45}] = [\mathbf{10}] \oplus \chi, \quad \chi = \mathbf{5}^{\oplus 3} \oplus \mathbf{4}^{\oplus 4} \oplus \mathbf{1}^{\oplus 4}, \quad (8.7)$$

$$C_2^1 \rightarrow D_5: \quad [\mathbf{45}] = [\mathbf{10}] \oplus \chi, \quad \chi = \mathbf{5}^{\oplus 5} \oplus \mathbf{1}^{\oplus 10}, \quad (8.8)$$

$$C_2^2 \rightarrow D_5: \quad [\mathbf{45}] = [\mathbf{10}] \oplus \chi, \quad \chi = \mathbf{14} \oplus \mathbf{10}^{\oplus 2} \oplus \mathbf{1}, \quad (8.9)$$

$$C_2^3 \rightarrow D_5: \quad [\mathbf{45}] = [\mathbf{10}] \oplus \chi, \quad \chi = \mathbf{35}. \quad (8.10)$$

We see that the two $C_2^1 \rightarrow D_5$ have different characteristic representations. They also correspond to different sets of compatible groups. The first one need the group to be $USp(4)$ while the second could have an $SO(5)$ as well since the $\mathbf{4}$ of C_2 does not appear.

9 $A_1 \oplus A_1$: the $SU(2) \times SU(2)$ -models

In this section, we consider the collisions

$$I_2 + I_2 \rightarrow I_4, \quad (9.1)$$

$$I_2 + I_2 \rightarrow I_0^*. \quad (9.2)$$

They correspond to $SO(4)$ - or $Spin(4)$ -models where their geometry is studied in [29], where the degenerations of the fibers are presented in Figure 4. Taking into account all the possible split, non-split, and semi-split options for the Kodaira fibers of type I_4 and I_0^* , we get the following types of embeddings:

$$A_1 \oplus A_1 \rightarrow A_3, \quad (9.3)$$

$$A_1 \oplus A_1 \rightarrow C_2, \quad (9.4)$$

$$A_1 \oplus A_1 \rightarrow G_2, \quad (9.5)$$

$$A_1 \oplus A_1 \rightarrow B_3, \quad (9.6)$$

$$A_1 \oplus A_1 \rightarrow D_4. \quad (9.7)$$

We will analyze each case using the geography of semisimple subalgebras of A_3 , C_2 , G_2 , B_3 , and D_4 . They will be considered in Section 15 for its links of the channels of maximal subalgebras.

9.1 $A_1 \oplus A_1 \rightarrow A_3$

The A_3 has two distinct embeddings of type $A_1 \oplus A_1$: one is an S-subalgebra of Dynkin index $(1, 1)$ and contained in the S-maximal subalgebra B_2^1 of A_3 , where as the other one is a maximal S-subalgebra of Dynkin index $(2, 2)$.

$$7: \quad A_1^1 \oplus A_1^1 \rightarrow A_3: \quad [\mathbf{15}] = [(\mathbf{3}, \mathbf{1}) \oplus (\mathbf{1}, \mathbf{3})] \oplus \chi, \quad \chi = (\mathbf{2}, \mathbf{2})^{\oplus 2} \oplus (\mathbf{1}, \mathbf{1}), \quad (9.8)$$

$$8: \quad A_1^2 \oplus A_1^2 \rightarrow A_3: \quad [\mathbf{15}] = [(\mathbf{3}, \mathbf{1}) \oplus (\mathbf{1}, \mathbf{3})] \oplus \chi, \quad \chi = (\mathbf{3}, \mathbf{3}). \quad (9.9)$$

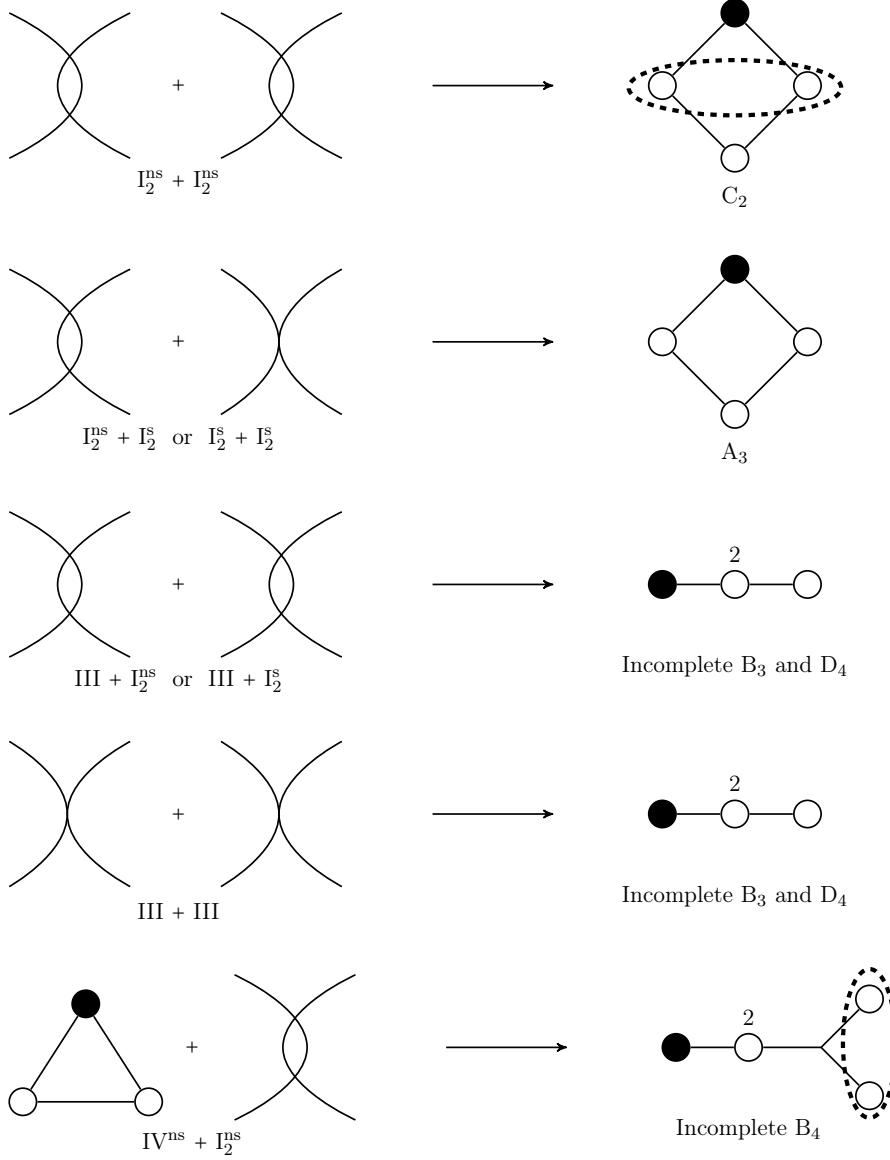

Figure 4: Degeneration of the $SO(4)$ fibers, which is established via $SU(2) \times SU(2)$ fibers with a Mordell-Weil group \mathbb{Z}_2 .

9.2 $A_1 \oplus A_1 \rightarrow C_2$

The $A_1 \oplus A_1$ is a singleton subalgebra of C_2 of Dynkin index (1,1):

$$4: \quad A_1^1 \oplus A_1^1 \rightarrow C_2: \quad [\mathbf{10}] = [(\mathbf{3}, \mathbf{1}) \oplus (\mathbf{1}, \mathbf{3})] \oplus \chi, \quad \chi = (\mathbf{2}, \mathbf{2}). \quad (9.10)$$

9.3 $A_1 \oplus A_1 \rightarrow G_2$

$A_1 \oplus A_1$ is a singleton subalgebra of G_2 of Dynkin index (3,1):

$$6: \quad A_1^3 \oplus A_1^1 \rightarrow G_2: \quad [\mathbf{10}] = [(\mathbf{3}, \mathbf{1}) \oplus (\mathbf{1}, \mathbf{3})] \oplus \chi, \quad \chi = (\mathbf{4}, \mathbf{2}). \quad (9.11)$$

This exotic matter shows that the enhancement to G_2 is not generic for a $A_1 \oplus A_1$ model.

9.4 $A_1 \oplus A_1 \rightarrow B_3$

$A_1 \oplus A_1$ can be embedded in three different ways inside B_3 , each case is distinguished by a different Dynkin index: (1,1), (1,2), or (1,3):

$$10: \quad A_1^1 \oplus A_1^1 \rightarrow B_3: \quad [\mathbf{21}] = [(\mathbf{3}, \mathbf{1}) \oplus (\mathbf{1}, \mathbf{3})] \oplus \chi, \quad \chi = (\mathbf{2}, \mathbf{2})^{\oplus 3} \oplus (\mathbf{1}, \mathbf{1})^{\oplus 3}, \quad (9.12)$$

$$11: \quad A_1^1 \oplus A_1^2 \rightarrow B_3: \quad [\mathbf{21}] = [(\mathbf{3}, \mathbf{1}) \oplus (\mathbf{1}, \mathbf{3})] \oplus \chi, \quad \chi = (\mathbf{2}, \mathbf{3})^{\oplus 2} \oplus (\mathbf{1}, \mathbf{1})^{\oplus 3}, \quad (9.13)$$

$$12: \quad A_1^1 \oplus A_1^2 \rightarrow B_3: \quad [\mathbf{21}] = [(\mathbf{3}, \mathbf{1}) \oplus (\mathbf{1}, \mathbf{3})] \oplus \chi, \quad \chi = (\mathbf{2}, \mathbf{4}) \oplus (\mathbf{1}, \mathbf{3}) \oplus (\mathbf{2}, \mathbf{2}). \quad (9.14)$$

We see that the subalgebra of Dynkin index one gives the matter representations we expect from considering the technique of intersecting branes (the bifundamental representation).

9.5 $A_1 \oplus A_1 \rightarrow D_4$

The $A_1 \oplus A_1$ can be embedded in 13 different ways inside D_4 some of which are related by triality. The embeddings of index one are related by triality and gives the same characteristic representation. The three embeddings of index (1,2) (resp. (2,2), and (2,10)) are also related by triality. The embedding of index (1,3) is a singleton embedding.

$$A_1^1 \oplus A_1^1 \rightarrow D_4: \quad [\mathbf{28}] = [(\mathbf{3}, \mathbf{1}) \oplus (\mathbf{1}, \mathbf{3})] \oplus \chi, \quad \chi = (\mathbf{2}, \mathbf{2})^{\oplus 4} \oplus (\mathbf{1}, \mathbf{1})^{\oplus 6}, \quad (9.15)$$

$$A_1^1 \oplus A_1^2 \rightarrow D_4: \quad [\mathbf{28}] = [(\mathbf{3}, \mathbf{1}) \oplus (\mathbf{1}, \mathbf{3})] \oplus \chi, \quad \chi = (\mathbf{2}, \mathbf{3})^{\oplus 2} \oplus (\mathbf{1}, \mathbf{3}) \oplus (\mathbf{2}, \mathbf{1})^{\oplus 2} \oplus (\mathbf{1}, \mathbf{1})^{\oplus 3}, \quad (9.16)$$

$$A_1^2 \oplus A_1^2 \rightarrow D_4: \quad [\mathbf{28}] = [(\mathbf{3}, \mathbf{1}) \oplus (\mathbf{1}, \mathbf{3})] \oplus \chi, \quad \chi = (\mathbf{3}, \mathbf{3}) \oplus (\mathbf{3}, \mathbf{1})^{\oplus 2} \oplus (\mathbf{1}, \mathbf{3})^{\oplus 2} \oplus (\mathbf{1}, \mathbf{1}), \quad (9.17)$$

$$A_1^2 \oplus A_1^{10} \rightarrow D_4: \quad [\mathbf{28}] = [(\mathbf{3}, \mathbf{1}) \oplus (\mathbf{1}, \mathbf{3})] \oplus \chi, \quad \chi = (\mathbf{1}, \mathbf{7}) \oplus (\mathbf{3}, \mathbf{5}), \quad (9.18)$$

$$A_1^1 \oplus A_1^3 \rightarrow D_4: \quad [\mathbf{28}] = [(\mathbf{3}, \mathbf{1}) \oplus (\mathbf{1}, \mathbf{3})] \oplus \chi, \quad \chi = (\mathbf{2}, \mathbf{4}) \oplus (\mathbf{1}, \mathbf{3})^{\oplus 2} \oplus (\mathbf{2}, \mathbf{2})^{\oplus 2}. \quad (9.19)$$

10 $A_1 \oplus A_2$: the $SU(2) \times SU(3)$ -model

The geometry of the $A_1 \oplus A_2$ -models realized by crepant resolutions of a Weierstrass model indicates that the following embedding are at play:

$$A_1 \oplus A_2 \rightarrow A_4, \quad (10.1)$$

$$A_1 \oplus A_2 \rightarrow A_5, \quad (10.2)$$

$$A_1 \oplus A_2 \rightarrow D_5, \quad (10.3)$$

$$A_1 \oplus A_2 \rightarrow E_6, \quad (10.4)$$

$$A_1 \oplus A_2 \rightarrow E_7. \quad (10.5)$$

There is a unique embedding of $A_1 \oplus A_2$ in A_4 already covered as one of the original Katz–Vafa cases. There are three distinct embeddings of $A_1 \oplus A_2$ in A_5 , two embeddings in D_5 , twelve in E_6 , and twenty-six embedding in E_7 .

$$A_1^{10} \oplus A_2^1 \rightarrow E_7: \quad \chi = (4, 3)^{\oplus 2} \oplus (5, \bar{3}) \oplus (1, \bar{3})^{\oplus 2} \oplus (7, 1) \oplus (5, 1) \oplus (4, 1)^{\oplus 4} \oplus (1, 1)^{\oplus 4} \oplus (4, \bar{3})^{\oplus 2} \oplus (5, 3) \oplus (1, 3)^{\oplus 2}, \quad (10.26)$$

$$A_1^8 \oplus A_2^1 \rightarrow E_7: \quad \chi = (5, 3) \oplus (5, \bar{3}) \oplus (3, \bar{3})^{\oplus 3} \oplus (1, \bar{3}) \oplus (5, 1)^{\oplus 4} \oplus (3, 1)^{\oplus 3} \oplus (1, 1)^{\oplus 3} \oplus (3, 3)^{\oplus 3} \oplus (1, 3), \quad (10.27)$$

$$A_1^{11} \oplus A_2^1 \rightarrow E_7: \quad \chi = (5, 3)^{\oplus 2} \oplus (5, \bar{3})^{\oplus 2} \oplus (3, \bar{3}) \oplus (1, \bar{3})^{\oplus 2} \oplus (7, 1) \oplus (5, 1)^{\oplus 3} \oplus (3, 1)^{\oplus 3} \oplus (1, 1) \oplus (3, 3) \oplus (1, 3)^{\oplus 2}, \quad (10.28)$$

$$A_1^{20} \oplus A_2^1 \rightarrow E_7: \quad \chi = (7, 3) \oplus (5, 3) \oplus (7, \bar{3}) \oplus (5, \bar{3}) \oplus (3, \bar{3}) \oplus (9, 1) \oplus (7, 1) \oplus (5, 1)^{\oplus 3} \oplus (1, 1) \oplus (3, 3), \quad (10.29)$$

$$A_1^{35} \oplus A_2^1 \rightarrow E_7: \quad \chi = (9, 3) \oplus (9, \bar{3}) \oplus (5, \bar{3}) \oplus (1, \bar{3}) \oplus (11, 1) \oplus (9, 1) \oplus (7, 1) \oplus (5, 1) \oplus (5, 3) \oplus (1, 3), \quad (10.30)$$

$$A_1^1 \oplus A_2^2 \rightarrow E_7: \quad \chi = (1, 6) \oplus (1, \bar{6}) \oplus (2, 8)^{\oplus 2} \oplus (1, 8)^3 \oplus (2, 1)^{\oplus 4} \oplus (1, 1)^{\oplus 4} \oplus (1, 3)^{\oplus 3} \oplus (2, \bar{3})^{\oplus 2} \oplus (1, \bar{3})^{\oplus 3} \oplus (2, 3)^{\oplus 2}, \quad (10.31)$$

$$A_1^3 \oplus A_2^2 \rightarrow E_7: \quad \chi = (1, 6) \oplus (1, \bar{6}) \oplus (2, 8)^{\oplus 2} \oplus (4, 1)^{\oplus 2} \oplus (3, 8), \oplus (1, 1)^{\oplus 4} \oplus (3, \bar{3}) \oplus (2, \bar{3})^{\oplus 2} \oplus (3, 3) \oplus (2, 3)^{\oplus 2}, \quad (10.32)$$

$$A_1^4 \oplus A_2^2 \rightarrow E_7: \quad \chi = (1, 6) \oplus (1, \bar{6}) \oplus (3, 8)^{\oplus 2} \oplus (5, 1) \oplus (1, 8) \oplus (3, 1)^{\oplus 2} \oplus (1, 1) \oplus (3, 3)^{\oplus 2} \oplus (1, 3) \oplus (3, \bar{3})^{\oplus 2} \oplus (1, \bar{3}), \quad (10.33)$$

$$A_1^{28} \oplus A_2^2 \rightarrow E_7: \quad \chi = (1, 6) \oplus (1, \bar{6}) \oplus (7, 8) \oplus (11, 1) \oplus (7, \bar{3}) \oplus (7, 3) \oplus (1, 1), \quad (10.34)$$

$$A_1^1 \oplus A_2^2 \rightarrow E_7: \quad \chi = (1, 6) \oplus (1, 8)^{\oplus 3} \oplus (2, \bar{6}) \oplus (2, 3)^{\oplus 3} \oplus (1, 1)^{\oplus 4} \oplus (1, \bar{6}) \oplus (2, 6) \oplus (2, \bar{3})^{\oplus 3} \oplus (1, 3)^{\oplus 3} \oplus (2, 1)^{\oplus 2} \oplus (1, \bar{3})^{\oplus 3}, \quad (10.35)$$

$$A_1^3 \oplus A_2^2 \rightarrow E_7: \quad \chi = (1, 6)^{\oplus 3} \oplus (3, 8) \oplus (3, 3)^{\oplus 3} \oplus (1, \bar{6})^{\oplus 3} \oplus (3, \bar{3})^{\oplus 3} \oplus (1, 1)^{\oplus 8}, \quad (10.36)$$

$$A_1^4 \oplus A_2^2 \rightarrow E_7: \quad \chi = (3, 6) \oplus (1, 8)^{\oplus 3} \oplus (3, \bar{6}) \oplus (3, 3)^{\oplus 3} \oplus (5, 1) \oplus (1, 1)^{\oplus 3} \oplus (3, \bar{3})^{\oplus 3}, \quad (10.37)$$

$$A_1^4 \oplus A_2^2 \rightarrow E_7: \quad \chi = (2, 6) \oplus (3, 8) \oplus (4, 3) \oplus (2, \bar{6}) \oplus (2, 3) \oplus (3, 3) \oplus (1, \bar{6}) \oplus (3, 1) \oplus (4, \bar{3}) \oplus (2, \bar{3}) \oplus (3, \bar{3}) \oplus (1, 6) \oplus (2, 1)^{\oplus 2} \oplus (1, 1), \quad (10.38)$$

$$A_1^7 \oplus A_2^2 \rightarrow E_7: \quad \chi = (3, 6) \oplus (3, 8) \oplus (3, \bar{6}) \oplus (5, 3) \oplus (3, 3) \oplus (1, 3) \oplus (5, 1) \oplus (3, 1) \oplus (5, \bar{3}) \oplus (3, \bar{3}) \oplus (1, \bar{3}), \quad (10.39)$$

$$A_1^3 \oplus A_2^3 \rightarrow E_7: \quad \chi = (3, \bar{6}) \oplus (3, 3) \oplus (1, 15) \oplus (1, 3) \oplus (3, 6) \oplus (3, \bar{3}) \oplus (1, \bar{15}) \oplus (1, \bar{3}) \oplus (3, 8) \oplus (1, 8), \quad (10.40)$$

$$A_1^1 \oplus A_2^5 \rightarrow E_7: \quad \chi = (1, 27) \oplus (2, \bar{15}) \oplus (1, \bar{15}) \oplus (2, 1)^{\oplus 2} \oplus (1, 15) \oplus (2, 15) \oplus (1, 1), \quad (10.41)$$

$$A_1^4 \oplus A_2^5 \rightarrow E_7: \quad \chi = (1, 27) \oplus (3, \bar{15}) \oplus (5, 1) \oplus (3, 15), \quad (10.42)$$

$$A_1^1 \oplus A_2^5 \rightarrow E_7: \quad \chi = (2, 10) \oplus (2, \bar{6}) \oplus (1, 15) \oplus (1, 27) \oplus (1, \bar{15}) \oplus (2, \bar{10}) \oplus (2, 6) \oplus (1, 1), \quad (10.43)$$

$$A_1^1 \oplus A_2^3 \rightarrow E_7: \quad \chi = (1, 10) \oplus (2, 8)^{\oplus 4} \oplus (1, \bar{10}) \oplus (1, 8)^{\oplus 4} \oplus (1, 1)^{\oplus 6}, \quad (10.44)$$

$$A_1^2 \oplus A_2^3 \rightarrow E_7: \quad \chi = (1, 10) \oplus (3, 8) \oplus (2, 8)^{\oplus 4} \oplus (1, \bar{10}) \oplus (1, 8) \oplus (3, 1) \oplus (1, 1)^{\oplus 3}, \quad (10.45)$$

$$A_1^3 \oplus A_2^3 \rightarrow E_7: \quad \chi = (1, 10) \oplus (3, 8)^{\oplus 3} \oplus (1, \bar{10}) \oplus (1, 8)^{\oplus 3} \oplus (3, 1)^{\oplus 2}. \quad (10.46)$$

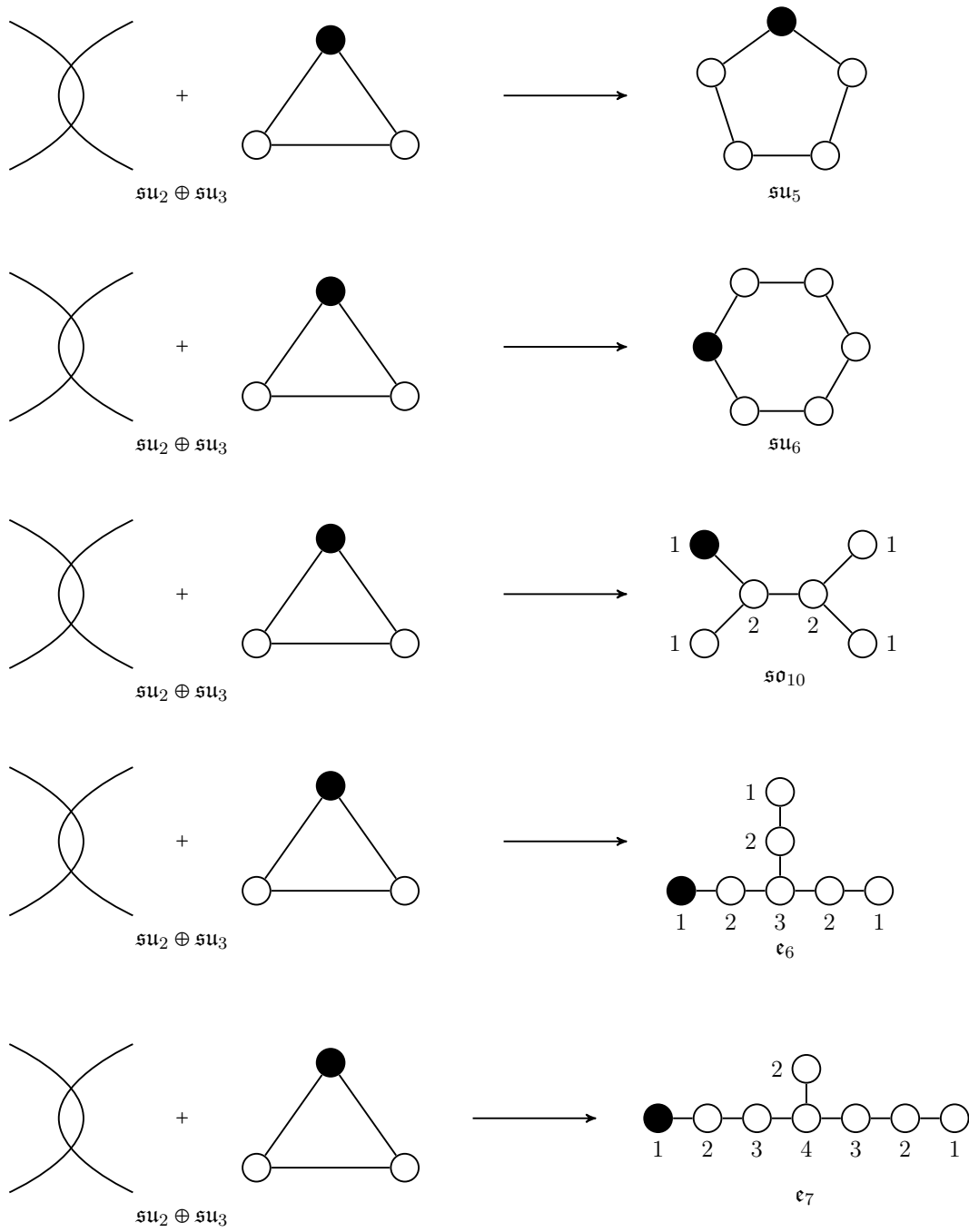

Figure 5: The expected gauge group enhancement of $\text{SU}(2) \times \text{SU}(3)$.

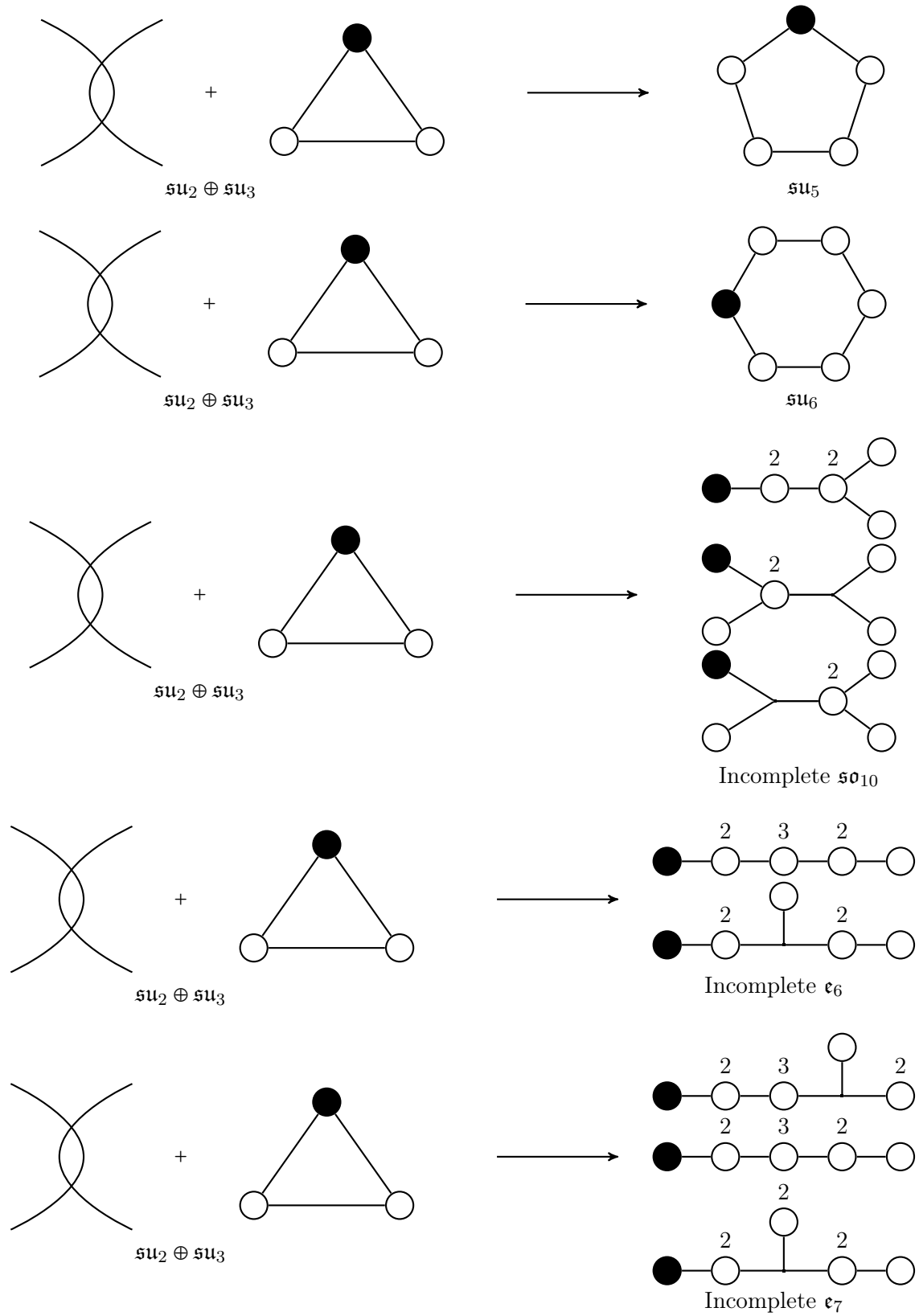

Figure 6: Degeneration of the $\text{SU}(2) \times \text{SU}(3)$ fibers.

11 $A_1 \oplus C_2$: the $SU(2) \times USp(4)$ -model

11.1 $A_1 \oplus C_2 \rightarrow D_4$

Up to linear equivalence, there are three embeddings of $A_1 \oplus C_2$ in D_4 . They are connected by triality and have Dynkin index $(2, 1)$ and the same characteristic representation:

$$A_1^2 \oplus C_2^1: \quad \chi = (\mathbf{3}, \mathbf{5}). \quad (11.1)$$

11.2 $A_1 \oplus C_2 \rightarrow C_3$

Up to linear equivalence, there is a unique embeddings of $A_1 \oplus C_2$ in C_3 . It has Dynkin index $(1, 1)$ and the characteristic representation is isotropic:

$$A_1^1 \oplus C_2^1: \quad \chi = (\mathbf{2}, \mathbf{4}). \quad (11.2)$$

11.3 $A_1 \oplus C_2 \rightarrow C_4$

Up to linear equivalence, there are three embeddings of $A_1 \oplus C_2$ in C_4 :

$$A_1^1 \oplus C_2^1: \quad \chi = (\mathbf{1}, \mathbf{4})^{\oplus 2} \oplus (\mathbf{2}, \mathbf{1})^{\oplus 2} \oplus (\mathbf{2}, \mathbf{4}) \oplus (\mathbf{1}, \mathbf{1})^{\oplus 3}, \quad (11.3)$$

$$A_1^2 \oplus C_2^1: \quad \chi = (\mathbf{3}, \mathbf{1})^{\oplus 2} \oplus (\mathbf{2}, \mathbf{4})^{\oplus 2} \oplus (\mathbf{1}, \mathbf{1}), \quad (11.4)$$

$$A_1^1 \oplus C_2^2: \quad \chi = (\mathbf{7}, \mathbf{1}) \oplus (\mathbf{4}, \mathbf{4}). \quad (11.5)$$

The embedding of Dynkin index $(1, 1)$ gives the matter expected in F-theory.

11.4 $A_1 \oplus C_2 \rightarrow A_5$

Up to linear equivalence, there is a unique embedding of $A_1 \oplus C_2$ into A_5 . It has Dynkin index $(1, 1)$:

$$A_1^1 \oplus C_2^1 \rightarrow A_5: \quad \chi = (\mathbf{1}, \mathbf{5}) \oplus (\mathbf{2}, \mathbf{4})^{\oplus 2} \oplus (\mathbf{1}, \mathbf{1}). \quad (11.6)$$

11.5 $A_1 \oplus C_2 \rightarrow D_5$

Up to linear equivalence, there are three embeddings of $A_1 \oplus C_2$ in D_5 that are distinguishable by their Dynkin index:

$$A_1^2 \oplus C_2^1 \rightarrow D_5: \quad \chi = (\mathbf{2}, \mathbf{4})^{\oplus 2} \oplus (\mathbf{3}, \mathbf{5}) \oplus (\mathbf{1}, \mathbf{1}), \quad (11.7)$$

$$A_1^1 \oplus C_2^1 \rightarrow D_5: \quad \chi = (\mathbf{2}, \mathbf{5})^{\oplus 2} \oplus (\mathbf{2}, \mathbf{1})^{\oplus 2} \oplus (\mathbf{1}, \mathbf{5}) \oplus (\mathbf{1}, \mathbf{1})^{\oplus 3}, \quad (11.8)$$

$$A_1^2 \oplus C_2^1 \rightarrow D_5: \quad \chi = (\mathbf{3}, \mathbf{5}) \oplus (\mathbf{1}, \mathbf{5})^{\oplus 2} \oplus (\mathbf{3}, \mathbf{1})^{\oplus 2} \oplus (\mathbf{1}, \mathbf{1}), \quad (11.9)$$

$$A_1^{10} \oplus C_2^1 \rightarrow D_5: \quad \chi = (\mathbf{5}, \mathbf{5}) \oplus (\mathbf{7}, \mathbf{1}). \quad (11.10)$$

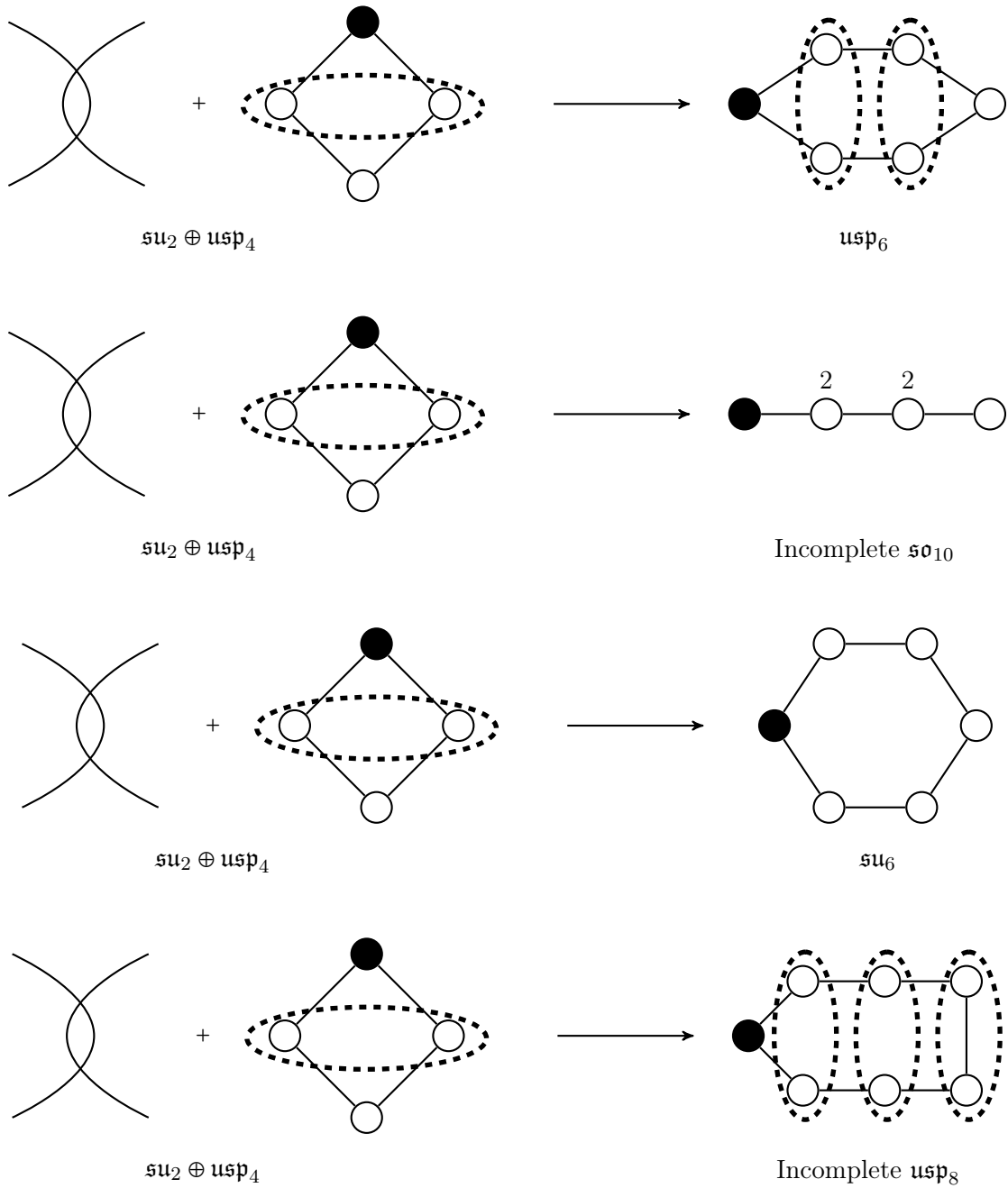

Figure 7: Degeneration of the $SU(2) \times USp(4)$ and $SU(2) \times USp(4)/\mathbb{Z}_2$ fibers.

12 $A_1 \oplus G_2$: the $SU(2) \times G_2$ -model

12.1 $A_1 \oplus G_2 \rightarrow D_5$

$A_1 \oplus G_2$ is a singleton subalgebra of D_5 , it has Dynkin index (2,1) and characteristic representation:

$$A_1^2 \oplus G_2^1: \quad \chi = (\mathbf{3}, \mathbf{7}) \oplus (\mathbf{1}, \mathbf{7}). \quad (12.1)$$

This is a particularly interesting example, since there is no embedding of $A_1 \oplus G_2 \rightarrow D_5$ with Dynkin index (1,1). This is consistent with the fact that in F-theory there is no enhancement of types $I_2 + I_0^* \rightarrow I_1^*$, $III + I_1^* \rightarrow I_1^*$, or $IV^{ns} + I_0^* \rightarrow I_1^*$. This is because if such an enhancement exist, the discriminant must vanish at least at orders 2, 6, 7, respectively for A_1 , G_2 , and D_5 , but this is not plausible as $7 < 2 + 6$.

12.2 $A_1 \oplus G_2 \rightarrow B_5$

There are two subalgebras of type $A_1 \oplus G_2$ in B_5 : one has Dynkin index (1,1) and the other has Dynkin index (2,1). Their characteristic representations are:

$$A_1^1 \oplus G_2^1 \rightarrow B_5: \quad \chi = (\mathbf{2}, \mathbf{7})^{\oplus 2} \oplus (\mathbf{1}, \mathbf{7}) \oplus (\mathbf{1}, \mathbf{1})^{\oplus 3}, \quad (12.2)$$

$$A_1^2 \oplus G_2^1 \rightarrow B_5: \quad \chi = (\mathbf{3}, \mathbf{7}) \oplus (\mathbf{1}, \mathbf{7})^{\oplus 2} \oplus (\mathbf{3}, \mathbf{1}). \quad (12.3)$$

12.3 $A_1 \oplus G_2 \rightarrow D_6$

The enhancement that happens in F-theory is $A_1 \oplus G_2 \rightarrow D_6$, for example with $I_2 + I_0^{*ns}$. There are three subalgebras of type $A_1 \oplus G_2$ and one of them has Dynkin index (1,1):

$$A_1^1 \oplus G_2^1 \rightarrow D_6: \quad \chi = (\mathbf{2}, \mathbf{7})^{\oplus 2} \oplus (\mathbf{1}, \mathbf{7})^{\oplus 2} \oplus (\mathbf{2}, \mathbf{1})^{\oplus 2} \oplus (\mathbf{1}, \mathbf{1})^{\oplus 3}, \quad (12.4)$$

$$A_1^2 \oplus G_2^1 \rightarrow D_6: \quad \chi = (\mathbf{3}, \mathbf{7}) \oplus (\mathbf{1}, \mathbf{7})^{\oplus 3} \oplus (\mathbf{3}, \mathbf{1})^{\oplus 2} \oplus (\mathbf{1}, \mathbf{1}), \quad (12.5)$$

$$A_1^{10} \oplus G_2^1 \rightarrow D_6: \quad \chi = (\mathbf{5}, \mathbf{7}) \oplus (\mathbf{7}, \mathbf{1}) \oplus (\mathbf{1}, \mathbf{7}). \quad (12.6)$$

12.4 $A_1 \oplus G_2 \rightarrow E_7$

There are eight embeddings of $A_1 \oplus G_2$ inside E_7 up to linear equivalence and they each have a distinct Dynkin index

$$A_1^1 \oplus G_2^1 \rightarrow E_7: \quad \chi = (\mathbf{2}, \mathbf{7})^{\oplus 4} \oplus (\mathbf{1}, \mathbf{7})^{\oplus 6} \oplus (\mathbf{2}, \mathbf{1})^{\oplus 4} \oplus (\mathbf{1}, \mathbf{1})^{\oplus 10}, \quad (12.7)$$

$$A_1^2 \oplus G_2^1 \rightarrow E_7: \quad \chi = (\mathbf{3}, \mathbf{7}) \oplus (\mathbf{2}, \mathbf{7})^{\oplus 4} \oplus (\mathbf{1}, \mathbf{7})^{\oplus 3} \oplus (\mathbf{3}, \mathbf{1})^{\oplus 2} \oplus (\mathbf{2}, \mathbf{1})^{\oplus 4} \oplus (\mathbf{1}, \mathbf{1})^{\oplus 4}, \quad (12.8)$$

$$A_1^3 \oplus G_2^1 \rightarrow E_7: \quad \chi = (\mathbf{3}, \mathbf{7})^{\oplus 3} \oplus (\mathbf{1}, \mathbf{7})^{\oplus 5} \oplus (\mathbf{3}, \mathbf{1})^{\oplus 5} \oplus (\mathbf{1}, \mathbf{1})^{\oplus 3}, \quad (12.9)$$

$$A_1^8 \oplus G_2^1 \rightarrow E_7: \quad \chi = (\mathbf{5}, \mathbf{7}) \oplus (\mathbf{3}, \mathbf{7})^{\oplus 3} \oplus (\mathbf{5}, \mathbf{1})^{\oplus 3} \oplus (\mathbf{1}, \mathbf{1})^{\oplus 3}, \quad (12.10)$$

$$A_1^{10} \oplus G_2^1 \rightarrow E_7: \quad \chi = (\mathbf{4}, \mathbf{7})^{\oplus 2} \oplus (\mathbf{5}, \mathbf{7}) \oplus (\mathbf{1}, \mathbf{7}) \oplus (\mathbf{7}, \mathbf{1}) \oplus (\mathbf{4}, \mathbf{1})^{\oplus 2} \oplus (\mathbf{1}, \mathbf{1})^{\oplus 3}, \quad (12.11)$$

$$A_1^{11} \oplus G_2^1 \rightarrow E_7: \quad \chi = (\mathbf{5}, \mathbf{7})^{\oplus 2} \oplus (\mathbf{3}, \mathbf{7}) \oplus (\mathbf{1}, \mathbf{7}) \oplus (\mathbf{7}, \mathbf{1}) \oplus (\mathbf{5}, \mathbf{1}) \oplus (\mathbf{3}, \mathbf{1})^{\oplus 2}, \quad (12.12)$$

$$A_1^{35} \oplus G_2^1 \rightarrow E_7: \quad \chi = (\mathbf{9}, \mathbf{7}) \oplus (\mathbf{5}, \mathbf{7}) \oplus (\mathbf{11}, \mathbf{1}) \oplus (\mathbf{7}, \mathbf{1}), \quad (12.13)$$

$$A_1^7 \oplus G_2^2 \rightarrow E_7: \quad \chi = (\mathbf{3}, \mathbf{27}) \oplus (\mathbf{5}, \mathbf{7}). \quad (12.14)$$

The first one with Dynkin index (1,1) corresponds to the matter content observed at the collision of the two divisors of an $SU(2) \times G_2$ -model realize by the collision $III+I_0^{*ns}$. The last one with Dynkin index (7,1) is the only one that is a maximal embedding.

12.5 $A_1 \oplus G_2 \rightarrow E_8$

Up to linear equivalence, there are twenty different embeddings of $A_1 \oplus G_2$ in E_8 and they all have a different Dynkin embedding index. The unique one with Dynkin embedding index (1,1) has the reduced matter representation that we see in F-theory, namely the fundamental representations $(\mathbf{2}, \mathbf{1})$, $(\mathbf{1}, \mathbf{7})$, and the bifundamental representation $(\mathbf{2}, \mathbf{7})$. The branching of the adjoint of E_8 along representations of $A_1 \oplus G_2$ is

$$[\mathbf{248}] = [(\mathbf{3}, \mathbf{1}) \oplus (\mathbf{1}, \mathbf{14})] \oplus \chi,$$

where χ is as follows for each of the twenty possible embeddings:

$$A_1^1 \oplus G_2^1: \quad \chi = (\mathbf{2}, \mathbf{1})^{\oplus 14} \oplus (\mathbf{1}, \mathbf{7})^{\oplus 14} \oplus (\mathbf{2}, \mathbf{7})^{\oplus 6} \oplus (\mathbf{1}, \mathbf{1})^{\oplus 21} \quad (12.15)$$

$$A_1^2 \oplus G_2^1: \quad \chi = (\mathbf{3}, \mathbf{7}) \oplus (\mathbf{1}, \mathbf{7})^{\oplus 7} \oplus (\mathbf{2}, \mathbf{7})^{\oplus 8} \oplus (\mathbf{2}, \mathbf{1})^{\oplus 8} \oplus (\mathbf{3}, \mathbf{1})^{\oplus 6} \oplus (\mathbf{1}, \mathbf{1})^{\oplus 15} \quad (12.16)$$

$$A_1^3 \oplus G_2^1: \quad \chi = (\mathbf{3}, \mathbf{7})^{\oplus 3} \oplus (\mathbf{1}, \mathbf{7})^{\oplus 5} \oplus (\mathbf{3}, \mathbf{1})^{\oplus 5} \oplus (\mathbf{1}, \mathbf{1})^{\oplus 6} \oplus (\mathbf{2}, \mathbf{7})^{\oplus 6} \oplus (\mathbf{4}, \mathbf{1})^{\oplus 2} \oplus (\mathbf{2}, \mathbf{1})^{\oplus 10} \quad (12.17)$$

$$A_1^4 \oplus G_2^1: \quad \chi = (\mathbf{3}, \mathbf{7})^{\oplus 6} \oplus (\mathbf{1}, \mathbf{7})^{\oplus 8} \oplus (\mathbf{5}, \mathbf{1}) \oplus (\mathbf{3}, \mathbf{1})^{\oplus 12} \oplus (\mathbf{1}, \mathbf{1})^{\oplus 8} \quad (12.18)$$

$$A_1^6 \oplus G_2^1: \quad \chi = (\mathbf{4}, \mathbf{7})^{\oplus 2} \oplus (\mathbf{2}, \mathbf{7})^{\oplus 4} \oplus (\mathbf{5}, \mathbf{1})^{\oplus 3} \oplus (\mathbf{3}, \mathbf{7})^{\oplus 3} \oplus (\mathbf{1}, \mathbf{7}) \oplus (\mathbf{3}, \mathbf{1})^{\oplus 5} \\ \oplus (\mathbf{1}, \mathbf{1})^{\oplus 3} \oplus (\mathbf{4}, \mathbf{1})^{\oplus 2} \oplus (\mathbf{2}, \mathbf{1})^{\oplus 4} \quad (12.19)$$

$$A_1^{10} \oplus G_2^1: \quad \chi = (\mathbf{5}, \mathbf{7}) \oplus (\mathbf{4}, \mathbf{7})^{\oplus 4} \oplus (\mathbf{7}, \mathbf{1}) \oplus (\mathbf{5}, \mathbf{1})^{\oplus 4} \oplus (\mathbf{1}, \mathbf{7})^{\oplus 5} \oplus (\mathbf{1}, \mathbf{1})^{\oplus 6} \oplus (\mathbf{4}, \mathbf{1})^{\oplus 4} \quad (12.20)$$

$$A_1^8 \oplus G_2^1: \quad \chi = (\mathbf{5}, \mathbf{7}) \oplus (\mathbf{3}, \mathbf{7})^{\oplus 7} \oplus (\mathbf{5}, \mathbf{1})^{\oplus 7} \oplus (\mathbf{1}, \mathbf{1})^{\oplus 14} \quad (12.21)$$

$$A_1^9 \oplus G_2^1: \quad \chi = (\mathbf{4}, \mathbf{7})^{\oplus 2} \oplus (\mathbf{5}, \mathbf{7}) \oplus (\mathbf{3}, \mathbf{7})^{\oplus 3} \oplus (\mathbf{5}, \mathbf{1})^{\oplus 3} \oplus (\mathbf{6}, \mathbf{1})^{\oplus 2} \\ \oplus (\mathbf{4}, \mathbf{1})^{\oplus 2} \oplus (\mathbf{2}, \mathbf{7})^{\oplus 2} \oplus (\mathbf{2}, \mathbf{1})^{\oplus 4} \oplus (\mathbf{3}, \mathbf{1}) \oplus (\mathbf{1}, \mathbf{1})^{\oplus 3} \quad (12.22)$$

$$A_1^{11} \oplus G_2^1: \quad \chi = (\mathbf{5}, \mathbf{7})^{\oplus 2} \oplus (\mathbf{3}, \mathbf{7}) \oplus (\mathbf{4}, \mathbf{7})^{\oplus 2} \oplus (\mathbf{2}, \mathbf{7})^{\oplus 2} \oplus (\mathbf{6}, \mathbf{1})^{\oplus 2} \oplus (\mathbf{1}, \mathbf{7}) \\ \oplus (\mathbf{7}, \mathbf{1}) \oplus (\mathbf{5}, \mathbf{1}) \oplus (\mathbf{3}, \mathbf{1})^{\oplus 2} \oplus (\mathbf{1}, \mathbf{1})^{\oplus 3} \oplus (\mathbf{4}, \mathbf{1})^{\oplus 4} \quad (12.23)$$

$$A_1^{12} \oplus G_2^1: \quad \chi = (\mathbf{5}, \mathbf{7})^{\oplus 3} \oplus (\mathbf{3}, \mathbf{7})^{\oplus 3} \oplus (\mathbf{1}, \mathbf{7})^{\oplus 2} \oplus (\mathbf{7}, \mathbf{1})^{\oplus 2} \oplus (\mathbf{5}, \mathbf{1})^{\oplus 4} \oplus (\mathbf{3}, \mathbf{1})^{\oplus 5} \quad (12.24)$$

$$A_1^{28} \oplus G_2^1: \quad \chi = (\mathbf{7}, \mathbf{7})^{\oplus 3} \oplus (\mathbf{11}, \mathbf{1}) \oplus (\mathbf{7}, \mathbf{1})^{\oplus 5} \oplus (\mathbf{1}, \mathbf{7})^{\oplus 5} \oplus (\mathbf{1}, \mathbf{1})^{\oplus 3} \quad (12.25)$$

$$A_1^{35} \oplus G_2^1: \quad \chi = (\mathbf{9}, \mathbf{7}) \oplus (\mathbf{5}, \mathbf{7}) \oplus (\mathbf{11}, \mathbf{1}) \\ \oplus (\mathbf{7}, \mathbf{1}) \oplus (\mathbf{10}, \mathbf{1})^{\oplus 2} \oplus (\mathbf{6}, \mathbf{7})^{\oplus 2} \oplus (\mathbf{4}, \mathbf{1})^{\oplus 2} \oplus (\mathbf{1}, \mathbf{1})^{\oplus 3} \quad (12.26)$$

$$A_1^{36} \oplus G_2^1: \quad \chi = (\mathbf{9}, \mathbf{7}) \oplus (\mathbf{7}, \mathbf{7}) \oplus (\mathbf{5}, \mathbf{7})^{\oplus 2} \oplus (\mathbf{11}, \mathbf{1})^{\oplus 2} \oplus (\mathbf{9}, \mathbf{1}) \oplus (\mathbf{7}, \mathbf{1}) \oplus (\mathbf{5}, \mathbf{1}) \oplus (\mathbf{3}, \mathbf{1})^{\oplus 2} \quad (12.27)$$

$$A_1^{60} \oplus G_2^1: \quad \chi = (\mathbf{11}, \mathbf{7}) \oplus (\mathbf{9}, \mathbf{7}) \oplus (\mathbf{15}, \mathbf{1}) \oplus (\mathbf{11}, \mathbf{1})^{\oplus 2} \oplus (\mathbf{7}, \mathbf{1}) \oplus (\mathbf{5}, \mathbf{7}) \oplus (\mathbf{5}, \mathbf{1}) \oplus (\mathbf{1}, \mathbf{7}) \quad (12.28)$$

$$A_1^{156} \oplus G_2^1: \quad \chi = (\mathbf{17}, \mathbf{7}) \oplus (\mathbf{9}, \mathbf{7}) \oplus (\mathbf{23}, \mathbf{1}) \oplus (\mathbf{15}, \mathbf{1}) \oplus (\mathbf{11}, \mathbf{1}), \quad (12.29)$$

$$A_1^1 \oplus G_2^2: \quad \chi = (\mathbf{1}, \mathbf{27})^{\oplus 3} \oplus (\mathbf{2}, \mathbf{14})^{\oplus 2} \oplus (\mathbf{2}, \mathbf{7})^{\oplus 4} \oplus (\mathbf{1}, \mathbf{7})^{\oplus 5} \oplus (\mathbf{1}, \mathbf{1})^{\oplus 3} \quad (12.30)$$

$$A_1^7 \oplus G_2^2: \quad \chi = (\mathbf{3}, \mathbf{27}) \oplus (\mathbf{5}, \mathbf{7}) \oplus (\mathbf{4}, \mathbf{7})^{\oplus 2} \oplus (\mathbf{2}, \mathbf{14})^{\oplus 2} \oplus (\mathbf{1}, \mathbf{1})^{\oplus 3} \quad (12.31)$$

$$A_1^8 \oplus G_2^2: \quad \chi = (\mathbf{3}, \mathbf{27}) \oplus (\mathbf{5}, \mathbf{7})^{\oplus 2} \oplus (\mathbf{3}, \mathbf{14}) \oplus (\mathbf{3}, \mathbf{7}) \oplus (\mathbf{1}, \mathbf{14}) \oplus (\mathbf{3}, \mathbf{1}) \quad (12.32)$$

$$A_1^1 \oplus G_2^3: \quad \chi = (\mathbf{1}, \mathbf{64}) \oplus (\mathbf{1}, \mathbf{27})^{\oplus 2} \oplus (\mathbf{2}, \mathbf{27})^{\oplus 2} \oplus (\mathbf{2}, \mathbf{1})^{\oplus 2} \oplus (\mathbf{1}, \mathbf{1}) \quad (12.33)$$

$$A_1^4 \oplus G_2^3: \quad \chi = (\mathbf{1}, \mathbf{64}) \oplus (\mathbf{3}, \mathbf{27})^{\oplus 2} \oplus (\mathbf{5}, \mathbf{1}). \quad (12.34)$$

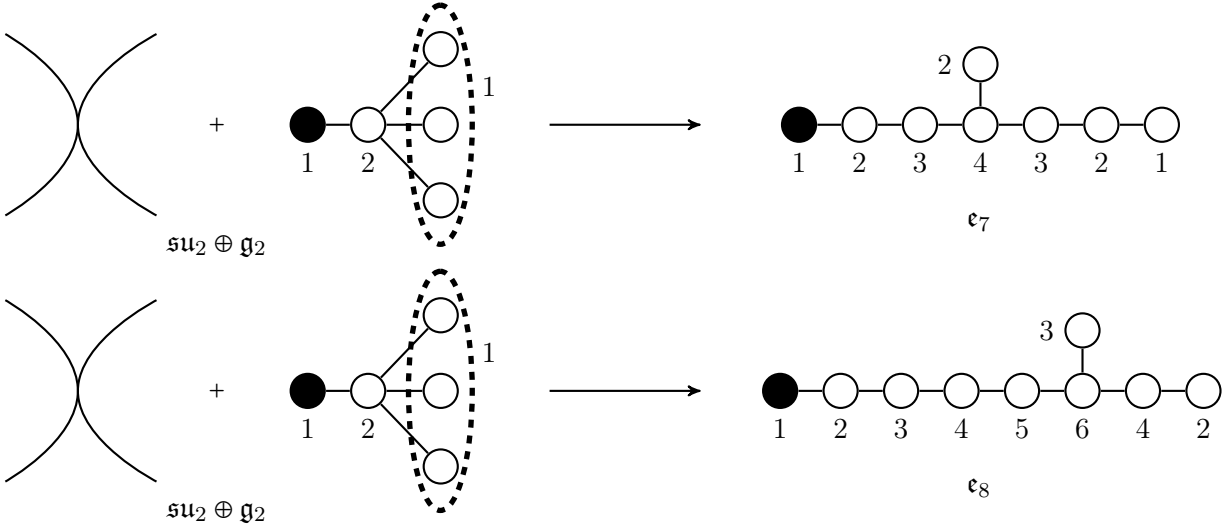

Figure 8: The expected gauge group enhancement of $SU(2) \times G_2$.

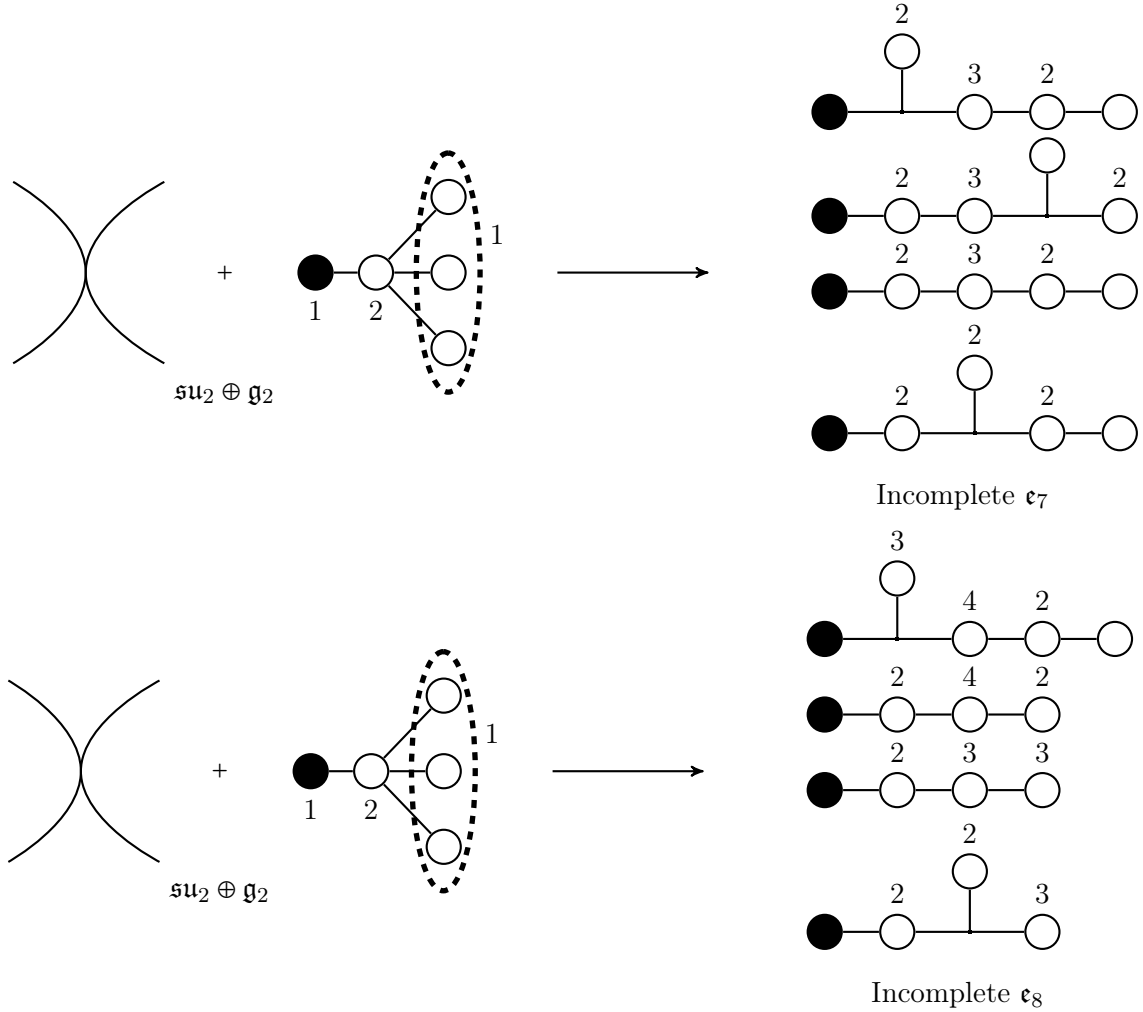

Figure 9: Degeneration of the $SU(2) \times G_2$ fibers at the collision $III + I_0^{ns}$.

13 $A_1 \oplus B_3$: the $SU(2) \times Spin(7)$ -model

13.1 $A_1 \oplus B_3 \rightarrow E_7$

There are seven subalgebras of type $A_1 \oplus B_3$ in E_7 including two with Dynkin embedding index one. The characteristic representations for the two subalgebras of Dynkin embedding index one are:

$$A_1^1 \oplus B_3^1 \rightarrow E_7: \quad \chi = (\mathbf{2}, \mathbf{8})^{\oplus 4} \oplus (\mathbf{1}, \mathbf{7})^{\oplus 5} \oplus (\mathbf{1}, \mathbf{1})^{\oplus 10}, \quad (13.1)$$

$$A_1^1 \oplus B_3^1 \rightarrow E_7: \quad \chi = (\mathbf{2}, \mathbf{8})^{\oplus 2} \oplus (\mathbf{2}, \mathbf{7})^{\oplus 2} \oplus (\mathbf{1}, \mathbf{7}) \oplus (\mathbf{1}, \mathbf{1})^{\oplus 6} \oplus (\mathbf{1}, \mathbf{8})^{\oplus 4} \oplus (\mathbf{2}, \mathbf{1})^{\oplus 2}. \quad (13.2)$$

We can understand the difference between these two subalgebras by the fact that they correspond to distinct groups sharing the same Lie algebra. The characteristic representations for the subalgebras of higher Dynkin embedding index are:

$$\begin{aligned} A_1^2 \oplus B_3^1 \rightarrow E_7: \quad & \chi = (\mathbf{3}, \mathbf{8}) \oplus (\mathbf{2}, \mathbf{7})^{\oplus 2} \oplus (\mathbf{2}, \mathbf{8})^{\oplus 2} \oplus (\mathbf{1}, \mathbf{8}) \oplus (\mathbf{1}, \mathbf{7}) \oplus (\mathbf{3}, \mathbf{1}) \oplus (\mathbf{2}, \mathbf{1})^{\oplus 2} \oplus (\mathbf{1}, \mathbf{1})^{\oplus 3}, \\ A_1^2 \oplus B_3^1 \rightarrow E_7: \quad & \chi = (\mathbf{2}, \mathbf{8})^{\oplus 4} \oplus (\mathbf{3}, \mathbf{7}) \oplus (\mathbf{1}, \mathbf{7})^{\oplus 2} \oplus (\mathbf{3}, \mathbf{1})^{\oplus 2} \oplus (\mathbf{1}, \mathbf{1})^{\oplus 4}, \\ A_1^3 \oplus B_3^1 \rightarrow E_7: \quad & \chi = (\mathbf{3}, \mathbf{8})^{\oplus 2} \oplus (\mathbf{3}, \mathbf{7}) \oplus (\mathbf{1}, \mathbf{8})^{\oplus 2} \oplus (\mathbf{1}, \mathbf{7})^{\oplus 2} \oplus (\mathbf{3}, \mathbf{1})^{\oplus 3} \oplus (\mathbf{1}, \mathbf{1}), \\ A_1^{10} \oplus B_3^1 \rightarrow E_7: \quad & \chi = (\mathbf{4}, \mathbf{8})^{\oplus 2} \oplus (\mathbf{5}, \mathbf{7}) \oplus (\mathbf{7}, \mathbf{1}) \oplus (\mathbf{1}, \mathbf{1})^{\oplus 3}, \\ A_1^{11} \oplus B_3^1 \rightarrow E_7: \quad & \chi = (\mathbf{5}, \mathbf{8}) \oplus (\mathbf{3}, \mathbf{8}) \oplus (\mathbf{5}, \mathbf{7}) \oplus (\mathbf{3}, \mathbf{1}). \end{aligned} \quad (13.3)$$

13.2 $A_1 \oplus B_3 \rightarrow E_8$

$$A_1^1 \oplus B_3^1: \quad \chi = (\mathbf{2}, \mathbf{7})^{\oplus 2} \oplus (\mathbf{1}, \mathbf{7})^{\oplus 5} \oplus (\mathbf{2}, \mathbf{1})^{\oplus 10} \oplus (\mathbf{1}, \mathbf{1})^{\oplus 13} \oplus (\mathbf{1}, \mathbf{8})^{\oplus 8} \oplus (\mathbf{2}, \mathbf{8})^{\oplus 4}, \quad (13.4)$$

$$A_1^2 \oplus B_3^1: \quad \chi = (\mathbf{2}, \mathbf{7})^{\oplus 4} \oplus (\mathbf{3}, \mathbf{1})^{\oplus 5} \oplus (\mathbf{1}, \mathbf{7}) \oplus (\mathbf{1}, \mathbf{1})^{\oplus 10} \oplus (\mathbf{2}, \mathbf{1})^{\oplus 4} \oplus (\mathbf{2}, \mathbf{8})^{\oplus 4} \oplus (\mathbf{3}, \mathbf{8}) \oplus (\mathbf{1}, \mathbf{8})^{\oplus 5}, \quad (13.5)$$

$$A_1^2 \oplus B_3^1: \quad \chi = (\mathbf{3}, \mathbf{7}) \oplus (\mathbf{1}, \mathbf{7})^{\oplus 6} \oplus (\mathbf{3}, \mathbf{1})^{\oplus 6} \oplus (\mathbf{1}, \mathbf{1})^{\oplus 15} \oplus (\mathbf{2}, \mathbf{8})^{\oplus 8}, \quad (13.6)$$

$$A_1^3 \oplus B_3^1: \quad \chi = \oplus (\mathbf{3}, \mathbf{7}) \oplus (\mathbf{4}, \mathbf{1})^{\oplus 2} \oplus (\mathbf{2}, \mathbf{7})^{\oplus 2} \oplus (\mathbf{2}, \mathbf{1})^{\oplus 6} \oplus (\mathbf{3}, \mathbf{1})^{\oplus 3} \oplus (\mathbf{1}, \mathbf{7})^{\oplus 2} \oplus (\mathbf{1}, \mathbf{1})^{\oplus 4} \oplus (\mathbf{2}, \mathbf{8})^{\oplus 4} \oplus (\mathbf{3}, \mathbf{8})^{\oplus 2} \oplus (\mathbf{1}, \mathbf{8})^{\oplus 2}, \quad (13.7)$$

$$A_1^4 \oplus B_3^1: \quad \chi = (\mathbf{3}, \mathbf{7})^{\oplus 2} \oplus (\mathbf{5}, \mathbf{1}) \oplus (\mathbf{1}, \mathbf{7})^{\oplus 3} \oplus (\mathbf{3}, \mathbf{1})^{\oplus 8} \oplus (\mathbf{1}, \mathbf{1})^{\oplus 4} \oplus (\mathbf{3}, \mathbf{8})^{\oplus 4} \oplus (\mathbf{1}, \mathbf{8})^{\oplus 4}, \quad (13.8)$$

$$A_1^6 \oplus B_3^1: \quad \chi = (\mathbf{3}, \mathbf{7})^{\oplus 3} \oplus (\mathbf{5}, \mathbf{1})^{\oplus 3} \oplus (\mathbf{3}, \mathbf{1})^{\oplus 5} \oplus (\mathbf{1}, \mathbf{1})^{\oplus 3} \oplus (\mathbf{4}, \mathbf{8})^{\oplus 2} \oplus (\mathbf{2}, \mathbf{8})^{\oplus 4} \oplus \quad (13.9)$$

$$A_1^{10} \oplus B_3^1: \quad \chi = (\mathbf{5}, \mathbf{7}) \oplus (\mathbf{7}, \mathbf{1}) \oplus (\mathbf{1}, \mathbf{7})^{\oplus 4} \oplus (\mathbf{5}, \mathbf{1})^{\oplus 4} \oplus (\mathbf{1}, \mathbf{1})^{\oplus 6} \oplus (\mathbf{4}, \mathbf{8})^{\oplus 4}, \quad (13.10)$$

$$A_1^{10} \oplus B_3^1: \quad \chi = (\mathbf{4}, \mathbf{7})^{\oplus 2} \oplus (\mathbf{7}, \mathbf{1}) \oplus (\mathbf{5}, \mathbf{1})^{\oplus 3} \oplus (\mathbf{1}, \mathbf{7}) \oplus (\mathbf{1}, \mathbf{1})^{\oplus 3} \oplus (\mathbf{4}, \mathbf{1})^{\oplus 2} \oplus (\mathbf{4}, \mathbf{8})^{\oplus 2} \oplus (\mathbf{5}, \mathbf{8}) \oplus (\mathbf{1}, \mathbf{8})^{\oplus 3}, \quad (13.11)$$

$$A_1^{11} \oplus B_3^1: \quad \chi = (\mathbf{5}, \mathbf{7}) \oplus (\mathbf{6}, \mathbf{1})^{\oplus 2} \oplus (\mathbf{7}, \mathbf{1}) \oplus (\mathbf{3}, \mathbf{1}) \oplus (\mathbf{4}, \mathbf{1})^{\oplus 2} \oplus (\mathbf{2}, \mathbf{7})^{\oplus 2} \oplus (\mathbf{1}, \mathbf{1})^{\oplus 3} \oplus (\mathbf{4}, \mathbf{8})^{\oplus 2} \oplus (\mathbf{5}, \mathbf{8}) \oplus (\mathbf{3}, \mathbf{8}), \quad (13.12)$$

$$A_1^{12} \oplus B_3^1: \quad \chi = (\mathbf{5}, \mathbf{7}) \oplus (\mathbf{7}, \mathbf{1})^{\oplus 2} \oplus (\mathbf{3}, \mathbf{7}) \oplus (\mathbf{5}, \mathbf{1})^{\oplus 2} \oplus (\mathbf{3}, \mathbf{1})^{\oplus 3} \oplus (\mathbf{1}, \mathbf{7}) \oplus (\mathbf{5}, \mathbf{8})^{\oplus 2} \oplus (\mathbf{3}, \mathbf{8})^{\oplus 2}, \quad (13.13)$$

$$A_1^{28} \oplus B_3^1: \quad \chi = (\mathbf{7}, \mathbf{7}) \oplus (\mathbf{11}, \mathbf{1}) \oplus (\mathbf{7}, \mathbf{1})^{\oplus 3} \oplus (\mathbf{1}, \mathbf{7})^{\oplus 2} \oplus (\mathbf{1}, \mathbf{1}) \oplus (\mathbf{7}, \mathbf{8})^{\oplus 2} \oplus (\mathbf{1}, \mathbf{8})^{\oplus 2}, \quad (13.14)$$

$$A_1^{60} \oplus B_3^1: \quad \chi = (\mathbf{9}, \mathbf{7}) \oplus (\mathbf{15}, \mathbf{1}) \oplus (\mathbf{11}, \mathbf{1}) \oplus (\mathbf{7}, \mathbf{1}) \oplus (\mathbf{11}, \mathbf{8}) \oplus (\mathbf{5}, \mathbf{8}), \quad (13.15)$$

$$A_1^1 \oplus B_3^2: \quad \chi = (\mathbf{1}, \mathbf{35})^{\oplus 2} \oplus (\mathbf{1}, \mathbf{27}) \oplus (\mathbf{1}, \mathbf{7})^{\oplus 2} \oplus (\mathbf{1}, \mathbf{1}) \oplus (\mathbf{2}, \mathbf{21})^{\oplus 2} \oplus (\mathbf{2}, \mathbf{7})^{\oplus 2}. \quad (13.16)$$

14 $A_1 \oplus D_4$: the $SU(2) \times Spin(8)$ -model

14.1 $A_1 \oplus D_4 \rightarrow E_7$

Up to linear equivalence, there are three subalgebras of type $A_1 \oplus D_4$ in E_7 with only one having Dynkin index $(1, 1)$. As expected from our proposal, $A_1^1 \oplus D_4^1 \rightarrow B_6$ produces the matter we expect to see in F-theory.

$$A_1^1 \oplus D_4^1 \rightarrow B_6 : \quad \chi = (\mathbf{2}, \mathbf{8}_c)^{\oplus 2} \oplus (\mathbf{2}, \mathbf{8}_v)^{\oplus 2} \oplus (\mathbf{1}, \mathbf{8}_s)^{\oplus 4} \oplus (\mathbf{1}, \mathbf{8}_v) \oplus (\mathbf{1}, \mathbf{1})^{\oplus 6}, \quad (14.1)$$

$$A_1^2 \oplus D_4^1 \rightarrow B_6 : \quad \chi = (\mathbf{2}, \mathbf{8}_c)^{\oplus 2} \oplus (\mathbf{2}, \mathbf{8}_s)^{\oplus 2} \oplus (\mathbf{3}, \mathbf{1}) \oplus (\mathbf{3}, \mathbf{8}_v) \oplus (\mathbf{1}, \mathbf{8}_v) \oplus (\mathbf{1}, \mathbf{1})^{\oplus 3}, \quad (14.2)$$

$$A_1^3 \oplus D_4^1 \rightarrow B_6 : \quad \chi = (\mathbf{2}, \mathbf{1})^{\oplus 2} \oplus (\mathbf{3}, \mathbf{8}_v) \oplus (\mathbf{3}, \mathbf{8}_c) \oplus (\mathbf{3}, \mathbf{8}_s) \oplus (\mathbf{1}, \mathbf{8}_c) \oplus (\mathbf{1}, \mathbf{8}_s). \quad (14.3)$$

14.2 $A_1 \oplus D_4 \rightarrow E_8$

There are 13 distinct subalgebras of type $A_1 \oplus B_3$ in E_7 up to linear equivalence. Only one of them has Dynkin index one along all A_1 and B_3 .

$$A_1^1 \oplus D_4^1 \rightarrow E_8 : \quad \chi = (\mathbf{2}, \mathbf{8}_s)^{\oplus 2} \oplus (\mathbf{1}, \mathbf{8}_s)^{\oplus 4} \oplus (\mathbf{2}, \mathbf{1})^{\oplus 8} \oplus (\mathbf{1}, \mathbf{1})^{\oplus 9} \oplus (\mathbf{2}, \mathbf{8}_v)^{\oplus 2} \oplus (\mathbf{1}, \mathbf{8}_v)^{\oplus 4} \\ \oplus (\mathbf{2}, \mathbf{8}_c)^{\oplus 2} \oplus (\mathbf{1}, \mathbf{8}_c)^{\oplus 4}, \quad (14.4)$$

$$A_1^2 \oplus D_4^1 \rightarrow E_8 : \quad \chi = (\mathbf{2}, \mathbf{8}_s)^{\oplus 4} \oplus (\mathbf{3}, \mathbf{1})^{\oplus 5} \oplus (\mathbf{1}, \mathbf{1})^{\oplus 10} \oplus (\mathbf{2}, \mathbf{8}_v)^{\oplus 4} \oplus (\mathbf{3}, \mathbf{8}_c) \oplus (\mathbf{1}, \mathbf{8}_c)^{\oplus 5}, \quad (14.5)$$

$$A_1^3 \oplus D_4^1 \rightarrow E_8 : \quad \chi = (\mathbf{3}, \mathbf{8}_s) \oplus (\mathbf{4}, \mathbf{1})^{\oplus 2} \oplus (\mathbf{2}, \mathbf{8}_s)^{\oplus 2} \oplus (\mathbf{2}, \mathbf{1})^{\oplus 4} \oplus (\mathbf{3}, \mathbf{1})^{\oplus 2} \oplus (\mathbf{1}, \mathbf{8}_s) \oplus (\mathbf{1}, \mathbf{1})^{\oplus 3} \\ \oplus (\mathbf{2}, \mathbf{8}_v)^{\oplus 2} \oplus (\mathbf{3}, \mathbf{8}_v) \oplus (\mathbf{1}, \mathbf{8}_v) \oplus (\mathbf{2}, \mathbf{8}_c)^{\oplus 2} \oplus (\mathbf{3}, \mathbf{8}_c) \oplus (\mathbf{1}, \mathbf{8}_c), \quad (14.6)$$

$$A_1^4 \oplus D_4^1 \rightarrow E_8 : \quad \chi = (\mathbf{3}, \mathbf{8}_s)^{\oplus 2} \oplus (\mathbf{5}, \mathbf{1}) \oplus (\mathbf{1}, \mathbf{8}_s)^{\oplus 2} \oplus (\mathbf{3}, \mathbf{1})^{\oplus 6} \oplus (\mathbf{1}, \mathbf{1})^{\oplus 2} \oplus (\mathbf{3}, \mathbf{8}_v)^{\oplus 2} \\ \oplus (\mathbf{1}, \mathbf{8}_v)^{\oplus 2} \oplus (\mathbf{3}, \mathbf{8}_c)^{\oplus 2} \oplus (\mathbf{1}, \mathbf{8}_c)^{\oplus 2}, \quad (14.7)$$

$$A_1^{10} \oplus D_4^1 \rightarrow E_8 : \quad \chi = (\mathbf{5}, \mathbf{8}_s) \oplus (\mathbf{7}, \mathbf{1}) \oplus (\mathbf{1}, \mathbf{8}_s)^{\oplus 3} \oplus (\mathbf{5}, \mathbf{1})^{\oplus 3} \oplus (\mathbf{1}, \mathbf{1})^{\oplus 3} \oplus (\mathbf{4}, \mathbf{8}_v)^{\oplus 2} \oplus (\mathbf{4}, \mathbf{8}_c)^{\oplus 2}, \quad (14.8)$$

$$A_1^{12} \oplus D_4^1 \rightarrow E_8 : \quad \chi = (\mathbf{5}, \mathbf{8}_s) \oplus (\mathbf{7}, \mathbf{1})^{\oplus 2} \oplus (\mathbf{3}, \mathbf{8}_s) \oplus (\mathbf{5}, \mathbf{1}) \oplus (\mathbf{3}, \mathbf{1})^{\oplus 2} \oplus (\mathbf{5}, \mathbf{8}_v) \oplus (\mathbf{3}, \mathbf{8}_v) \\ \oplus (\mathbf{5}, \mathbf{8}_c) \oplus (\mathbf{3}, \mathbf{8}_c), \quad (14.9)$$

$$A_1^{28} \oplus D_4^1 \rightarrow E_8 : \quad \chi = (\mathbf{7}, \mathbf{8}_s) \oplus (\mathbf{10}, \mathbf{1}) \oplus (\mathbf{7}, \mathbf{1})^{\oplus 2} \oplus (\mathbf{1}, \mathbf{8}_s) \oplus (\mathbf{7}, \mathbf{8}_v) \oplus (\mathbf{1}, \mathbf{8}_v) \oplus (\mathbf{7}, \mathbf{8}_c) \oplus (\mathbf{1}, \mathbf{8}_c), \quad (14.10)$$

$$A_1^2 \oplus D_4^1 \rightarrow E_8 : \quad \chi = (\mathbf{1}, \mathbf{35}_v) \oplus (\mathbf{1}, \mathbf{35}_c) \oplus (\mathbf{1}, \mathbf{35}_s) \oplus (\mathbf{2}, \mathbf{28})^{\oplus 2}. \quad (14.11)$$

15 The art of channeling

In this paper, we have used the geography of subalgebras of a given simple Lie algebra [11, 13, 15]. This is a luxury we have only for simple Lie algebras up to rank eight thanks to the classification of de Graaf [11]. In more general cases, all we can do is compute characteristic representations and then Dynkin indices by considering all the ways a given subalgebra can be embedded into another by a sequence of successive maximal Lie subalgebras. We call such a sequence a *channel of embeddings*. A channel is comparable to an itinerary as different channels can lead to the same subalgebra. But unlike the approach of Dynkin and de Graaf [11, 13, 15], channels do not track

linear equivalence. But channels do not keep track of linear equivalence. However, if two channels give distinct characteristic representations or Dynkin index, they are clearly not linearly equivalent.

$A_1 \rightarrow G_2$

In this section, we consider the enhancement $A_1 \rightarrow G_2$, which is motivated by the geometry of the SU(2)-model with Kodaira fibers of type IV^{ns} , which is one of the enhancements considered in [20] and portrayed in Figure 10.

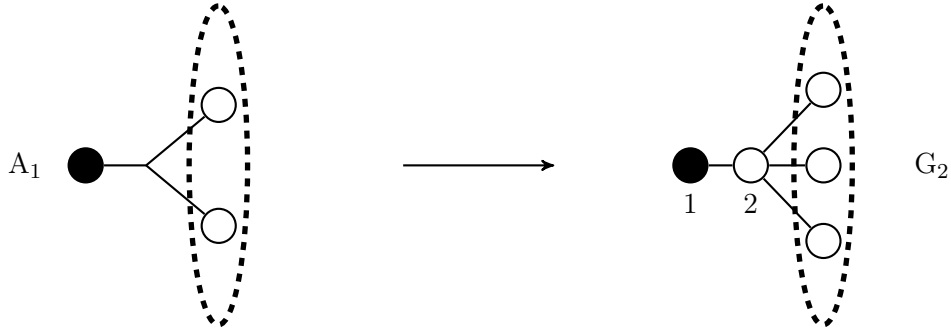

Figure 10: The gauge enhancement $A_1 \rightarrow G_2$ from $IV^{ns} \rightarrow I_0^{*ns}$.

As expected, there are several non-linearly equivalent subalgebras of type A_1 in G_2 . There are six distinct channels to embed A_1 in G_2 by a chain of maximal embeddings and they result in four distinct branching rules as summarized in Table 12. All the embeddings of A_1 factor through one of the three maximal subalgebras of G_2 whose branching rules for the adjoint representation are as follows:

$$G_2 \xleftarrow{(R)} A_2^1 \qquad \mathbf{14} = \mathbf{3} \oplus \bar{\mathbf{3}} \oplus \mathbf{8}, \qquad (15.1)$$

$$G_2 \xleftarrow{(R)} A_1^1 \oplus A_1^3 \qquad \mathbf{14} = (\mathbf{3}, \mathbf{1}) \oplus (\mathbf{2}, \mathbf{4}) \oplus (\mathbf{1}, \mathbf{3}), \qquad (15.2)$$

$$G_2 \xleftarrow{(S)} A_1^{28} \qquad \mathbf{14} = \mathbf{11} \oplus \mathbf{3}. \qquad (15.3)$$

The maximal embedding $A_2 \rightarrow G_2$ leads to two distinct channels, each corresponding to an embedding of A_1 with Dynkin index 1 or 4 respectively.

$$G_2 \xleftarrow{(R)} A_2^1 \xleftarrow{(R)} A_1^1 \oplus U_1 \xleftarrow{} A_1^1, \qquad (15.4)$$

$$G_2 \xleftarrow{(R)} A_2^1 \xleftarrow{(S)} A_1^4. \qquad (15.5)$$

The branching rules corresponding to the first and second channel provide two different decompositions of the adjoint of G_2 via A_2 . The decomposition via the first channel (equation (15.4)) is given by

$$\mathbf{14} = \mathbf{3} \oplus \bar{\mathbf{3}} \oplus \mathbf{8} \qquad \text{along } A_2^1,$$

$$\begin{aligned}
&= (\mathbf{2})(1) \oplus (\mathbf{1})(-2) \oplus (\mathbf{2})(-1) \oplus (\mathbf{1})(2) \oplus (\mathbf{3})(0) \oplus (\mathbf{2})(3) \oplus (\mathbf{2})(-3) \oplus (\mathbf{1})(0) && \text{along } A_1^1 \oplus U_1 \\
&= \mathbf{3} \oplus \mathbf{2}^{\oplus 4} \oplus \mathbf{1}^{\oplus 3} && \text{along } A_1^1,
\end{aligned}$$

where the superindex $\ell = 1$ denotes its Dynkin index, whereas the decomposition via the second channel (equation (15.5)) is

$$\mathbf{14} = \mathbf{3} \oplus \bar{\mathbf{3}} \oplus \mathbf{8} \quad \text{along } A_2^1, \quad (15.6)$$

$$= \mathbf{3}^{\oplus 3} \oplus \mathbf{5} \quad \text{along } A_1^4. \quad (15.7)$$

The third, fourth, and fifth channels utilizes the chain of maximal subalgebras via two copies of A_1

$$G_2 \xleftarrow{(R)} A_1 \oplus \tilde{A}_1 \xleftarrow{(S)} A_1, \tilde{A}_1, \text{ or } (A_1 \oplus \tilde{A}_1)_{diag}, \quad (15.8)$$

where the three difference choices of A_1 yield different chains of maximal subalgebras.⁵ First of all, these two copies of A_1 are non-isomorphic and they yield different decompositions of the adjoint representation of G_2 . By choosing the A_1 , the decomposition is given by

$$\mathbf{14} = \mathbf{3} \oplus \mathbf{2}^{\oplus 4} \oplus \mathbf{1}^{\oplus 3} \quad \text{along } A_1^1, \quad (15.9)$$

which is identical to the decomposition observed from the first channel, whereas by picking the A_1 on the right, we get the following decomposition

$$\mathbf{14} = \mathbf{3} \oplus \mathbf{4}^{\oplus 2} \oplus \mathbf{1}^{\oplus 3} \quad \text{along } \tilde{A}_1^3. \quad (15.10)$$

Now choose the diagonal component residing as $(A_1 \oplus \tilde{A}_1)_{diag}$. The decomposition of this channel yields

$$\begin{aligned}
\mathbf{14} &= (\mathbf{3}, \mathbf{1}) \oplus (\mathbf{2}, \mathbf{4}) \oplus (\mathbf{1}, \mathbf{3}) && \text{along } A_1^1 \oplus \tilde{A}_1^3, \\
&= \mathbf{3}^{\oplus 3} \oplus \mathbf{5} && \text{along } (A_1 \times \tilde{A}_1)_{diag}^4,
\end{aligned}$$

which matches with the result from the second channel in equation (15.7).

All six channels result in four different decompositions of the adjoint of G_2 . Only a single branching rule provides a Dynkin index one and yields the expected matter representation from F-theory models.

$A_1 \oplus A_1$: $SO(4)$ and $Spin(4)$ matter contents

We use chains of maximal subalgebras containing $A_1 \oplus A_1$ to illustrate an alternative way to obtain the matter content of $SO(4)$ and $Spin(4)$ -models studied in [29]. This matches with the matter content found by using the method of geography of subalgebras in Section 9.

The $SO(4)$ and $Spin(4)$ -models share the same semisimple gauge algebra $A_1 \oplus A_1$, which requires a collision of singularities to study its geometry using the Kodaira fibers of type I_2^{ns} , I_2^s , and III. The

⁵For the $A_1 \rightarrow G_2$ embedding, we find them to carry indices as A_1^1 , A_1^3 , and A_1^4 respectively.

\mathfrak{m}	Chains of maximal subalgebras containing $\mathfrak{g} = A_1$	Branching Rule	Index
G_2	$G_2 \xleftarrow{(R)} A_2 \xleftarrow{(R)} A_1 \oplus U_1 \xleftarrow{\quad} A_1$	$\mathbf{14} = \mathbf{3} \oplus \mathbf{2}^{\oplus 4} \oplus \mathbf{1}^{\oplus 3}$	1
	$G_2 \xleftarrow{(R)} A_1 \oplus \tilde{A}_1 \xleftarrow{(S)} A_1$		
	$G_2 \xleftarrow{(R)} A_2 \xleftarrow{(S)} A_1$	$\mathbf{14} = \mathbf{3}^{\oplus 3} \oplus \mathbf{5}$	4
	$G_2 \xleftarrow{(R)} A_1 \oplus \tilde{A}_1 \xleftarrow{(S)} (A_1 \oplus \tilde{A}_1)_{diag}$		
	$G_2 \xleftarrow{(R)} A_1 \oplus \tilde{A}_1 \xleftarrow{(S)} \tilde{A}_1$	$\mathbf{14} = \mathbf{3} \oplus \mathbf{4}^{\oplus 2} \oplus \mathbf{1}^{\oplus 3}$	3
	$G_2 \xleftarrow{(S)} A_1$	$\mathbf{14} = \mathbf{3} \oplus \mathbf{11}$	28

Table 12: All six chains of maximal subalgebras yielding $\mathfrak{g} = A_1$ from its possible gauge enhancement G_2 . We find four distinct branching rules and only a single branching rule corresponds to index 1.

geometric model of these two models are studied in [29] where $SO(4)$ -model has the Mordell–Weil group to be \mathbb{Z}_2 whereas the $Spin(4)$ -model has a trivial Mordell–Weil group. The geometrically allowed enhancements of these models are derived in [29] to be

$$C_2, \quad A_3, \quad \text{incomplete } B_3, \quad \text{incomplete } B_4,$$

as depicted in Figure 4. The enhanced algebras are depending on the choices of the Kodaira fibers for the two copies of A_1 . When we model with the collision of two fibers of type I_2^{ns} , we get the gauge enhancement C_2 . When we have a collision of a fiber I_2^{ns} and I_2^s or a collision of two fibers of type I_2^s , the enhanced gauge algebra is given by A_3 . When we utilize the collision of a fiber of type III and a fiber of either type I_2^{ns} or I_2^s , the enhanced fiber is an incomplete fiber of Kodaira type I_0^* . Similarly, when there is a collision of two fibers of type III, the enhanced fiber is an incomplete fiber of type I_0^* . The Kodaira fiber of type I_0^* can be G_2 , B_3 , or D_4 . However, we can easily conclude that this cannot be a gauge algebra G_2 . However, for completeness, we investigate all possible the branching rules of $A_1 \oplus A_1$ to G_2 , B_3 , and D_4 . Lastly, we can get an enhancement to an incomplete B_4 when we consider a collision of a fiber of type IV^{ns} and a fiber of type I_2^{ns} . Other than the last case which yield many possible branchings, we consider all the rest scenarios in Table 13.

For the three geometrically allowed enhancements considered,

$$\left\{ \begin{array}{l} A_1^1 \oplus A_1^1 \rightarrow C_2, \quad A_1^1 \oplus A_1^3 \rightarrow G_2, \\ A_1^1 \oplus A_1^1 \rightarrow A_3, \quad A_1^2 \oplus A_1^2 \rightarrow A_3, \\ A_1^1 \oplus A_1^1 \rightarrow B_3, \quad A_1^2 \oplus A_1^2 \rightarrow B_3, \quad A_1^1 \oplus A_1^2 \rightarrow B_3, \quad A_1^1 \oplus A_1^3 \rightarrow B_3, \end{array} \right.$$

there are only non-maximal embeddings of $A_1 + A_1$, each yielding one, two, and four distinct branching rules, respectively, which are listed in Table 13. We also compute the Dynkin index of each branching rules.

We note that the unique embedding of $A_1 \oplus A_1$ in G_2 has Dynkin index $(1, 3)$, whereas all the other enhancements of $A_1 \oplus A_1$ considered include at least one branching rule of Dynkin index $(1, 1)$.

The lack of the existence of a branching rule having Dynkin index one for G_2 is expected from the perspective of the geometry: G_2 is related to the fiber of type I_0^* , which never appears geometrically at the collision of two fibers with dual graphs A_1 . This hints that the proposed selection rule 1.1 may be used in reverse to rule out the geometrically impossible gauge enhancements or incorrect branching rules for the matter representations when they are not unique.

\mathfrak{m}	Chains of maximal subalgebras containing $\mathfrak{g} = A_1 \oplus A_1$	Index	
G_2	$\mathbf{14} = (\mathbf{3}, \mathbf{1}) \oplus (\mathbf{1}, \mathbf{3}) \oplus (\mathbf{2}, \mathbf{4})$	(1, 3)	
	$G_2 \xleftarrow{(R)} A_1 \oplus A_1$		
C_2	$\mathbf{10} = (\mathbf{3}, \mathbf{1}) \oplus (\mathbf{1}, \mathbf{3}) \oplus (\mathbf{2}, \mathbf{2})$	(1, 1)	
	$C_2 \xleftarrow{(R)} A_1 \oplus A_1$		
A_3	(1) $\mathbf{15} = (\mathbf{3}, \mathbf{1}) \oplus (\mathbf{1}, \mathbf{3}) \oplus (\mathbf{2}, \mathbf{2})^{\oplus 2} \oplus (\mathbf{1}, \mathbf{1})$	(1, 1)	
	$A_3 \xleftarrow{(R)} A_1 \oplus A_1 \oplus U_1 \xleftarrow{\quad} A_1 \oplus A_1$ $A_3 \xleftarrow{(S)} C_2 \xleftarrow{(R)} A_1 \oplus A_1$		
	(2) $\mathbf{15} = (\mathbf{3}, \mathbf{1}) \oplus (\mathbf{1}, \mathbf{3}) \oplus (\mathbf{3}, \mathbf{3})$	(2, 2)	
	$A_3 \xleftarrow{(S)} A_1 \oplus A_1$		
B_3	(1) $\mathbf{21} = (\mathbf{3}, \mathbf{1}) \oplus (\mathbf{1}, \mathbf{3}) \oplus (\mathbf{2}, \mathbf{2})^{\oplus 3} \oplus (\mathbf{1}, \mathbf{1})^{\oplus 3}$	(1, 1)	
	$B_3 \xleftarrow{(R)} A_3 \xleftarrow{(R)} A_1 \oplus A_1 \oplus U_1 \xleftarrow{\quad} A_1 \oplus A_1$ $B_3 \xleftarrow{(R)} A_3 \xleftarrow{(S)} C_2 \xleftarrow{(R)} A_1 \oplus A_1$ $B_3 \xleftarrow{(R)} A_1 \oplus A_1 \oplus \tilde{A}_1 \xleftarrow{\quad} A_1 \oplus A_1$ $B_3 \xleftarrow{(R)} C_2 \oplus U_1 \xleftarrow{(R)} A_1 \oplus A_1 \oplus U_1 \xleftarrow{\quad} A_1 \oplus A_1$		
	(2) $\mathbf{21} = (\mathbf{3}, \mathbf{1})^{\oplus 2} \oplus (\mathbf{1}, \mathbf{3})^{\oplus 2} \oplus (\mathbf{3}, \mathbf{3})$		(2, 2)
	$B_3 \xleftarrow{(R)} A_3 \xleftarrow{(S)} A_1 \oplus \tilde{A}_1$		
	(3) $\mathbf{21} = (\mathbf{3}, \mathbf{1}) \oplus (\mathbf{1}, \mathbf{3}) \oplus (\mathbf{2}, \mathbf{3})^{\oplus 2} \oplus (\mathbf{1}, \mathbf{1})^{\oplus 3}$	(1, 2)	
	$B_3 \xleftarrow{(R)} A_1 \oplus A_1 \oplus \tilde{A}_1 \xleftarrow{\quad} A_1 \oplus A_1$		
	(4) $\mathbf{21} = (\mathbf{3}, \mathbf{1}) \oplus (\mathbf{1}, \mathbf{3})^{\oplus 2} \oplus (\mathbf{2}, \mathbf{2}) \oplus (\mathbf{2}, \mathbf{4})$	(1, 3)	
	$B_3 \xleftarrow{(S)} G_2 \xleftarrow{(R)} A_1 \oplus A_1$		
	D_4	(1) $\mathbf{28} = (\mathbf{3}, \mathbf{1}) \oplus (\mathbf{1}, \mathbf{3}) \oplus (\mathbf{2}, \mathbf{2})^{\oplus 4} \oplus (\mathbf{1}, \mathbf{1})^{\oplus 6}$	(1, 1)
		$D_4 \xleftarrow{(R)} A_1 \oplus A_1 \oplus A_1 \oplus A_1 \xleftarrow{\quad} A_1 \oplus A_1$	

Table 13: The adjoint branching rule for the subalgebras $A_1 \oplus A_1$ in G_2 , C_2 , A_3 , B_3 , and D_4 .

m	Chains of maximal subalgebras containing $\mathfrak{g} = A_1 \oplus A_1$	Index
	$D_4 \xleftarrow{(R)} A_3 \oplus U_1 \xleftarrow{(R)} A_1 \oplus A_1 \oplus U_1 \oplus U_1 \longleftarrow A_1 \oplus A_1$ $D_4 \xleftarrow{(R)} A_3 \oplus U_1 \xleftarrow{(S)} C_2 \oplus U_1 \xleftarrow{(R)} A_1 \oplus A_1 \oplus U_1 \longleftarrow A_1 \oplus A_1$ $D_4 \xleftarrow{(S)} B_3 \xleftarrow{(R)} A_3 \xleftarrow{(R)} A_1 \oplus A_1 \oplus U_1 \longleftarrow A_1 \oplus A_1$ $D_4 \xleftarrow{(S)} B_3 \xleftarrow{(R)} A_3 \xleftarrow{(S)} C_2 \xleftarrow{(R)} A_1 \oplus A_1$ $D_4 \xleftarrow{(S)} B_3 \xleftarrow{(R)} A_1 \oplus A_1 \oplus \tilde{A}_1 \longleftarrow A_1 \oplus A_1$ $D_4 \xleftarrow{(S)} B_3 \xleftarrow{(R)} C_2 \oplus U_1 \xleftarrow{(R)} A_1 \oplus A_1 \oplus U_1 \longleftarrow A_1 \oplus A_1$ $D_4 \xleftarrow{(S)} B_3 \xleftarrow{(R)} A_1 \oplus A_1 \oplus \tilde{A}_1 \longleftarrow A_1 \oplus A_1$ $D_4 \xleftarrow{(S)} A_1 \oplus C_2 \xleftarrow{(R)} \tilde{A}_1 \oplus A_1 \oplus A_1 \longleftarrow \tilde{A}_1 \oplus A_1$	
	(2) $2\mathbf{8} = (\mathbf{3}, \mathbf{1})^{\oplus 3} \oplus (\mathbf{1}, \mathbf{3})^{\oplus 3} \oplus (\mathbf{3}, \mathbf{3}) \oplus (\mathbf{1}, \mathbf{1})$	(2, 2)
	$D_4 \xleftarrow{(R)} A_3 \oplus U_1 \xleftarrow{(S)} A_1 \oplus A_1 \oplus U_1 \longleftarrow A_1 \oplus A_1$ $D_4 \xleftarrow{(S)} B_3 \xleftarrow{(R)} A_3 \xleftarrow{(S)} A_1 \oplus \tilde{A}_1$ $D_4 \xleftarrow{(S)} A_1 \oplus C_2 \xleftarrow{(R)} A_1 \oplus A_1 \oplus U_1 \longleftarrow A_1 \oplus A_1$	
	(3) $2\mathbf{8} = (\mathbf{3}, \mathbf{1}) \oplus (\mathbf{1}, \mathbf{3})^{\oplus 2} \oplus (\mathbf{2}, \mathbf{3})^{\oplus 2} \oplus (\mathbf{2}, \mathbf{1})^{\oplus 2} \oplus (\mathbf{1}, \mathbf{1})^{\oplus 3}$	(1, 2)
	$D_4 \xleftarrow{(S)} B_3 \xleftarrow{(R)} A_1 \oplus A_1 \oplus \tilde{A}_1 \longleftarrow A_1 \oplus \tilde{A}_1$ $D_4 \xleftarrow{(S)} A_1 \oplus C_2 \xleftarrow{(R)} \tilde{A}_1 \oplus A_1 \oplus A_1 \longleftarrow A_1 \oplus A_1$	
	(4) $2\mathbf{8} = (\mathbf{3}, \mathbf{1}) \oplus (\mathbf{1}, \mathbf{3})^{\oplus 3} \oplus (\mathbf{2}, \mathbf{2})^{\oplus 2} \oplus (\mathbf{2}, \mathbf{4})$	(1, 3)
	$D_4 \xleftarrow{(S)} B_3 \xleftarrow{(S)} G_2 \xleftarrow{(R)} A_1 \oplus A_1$	
	(5) $2\mathbf{8} = (\mathbf{3}, \mathbf{1}) \oplus (\mathbf{1}, \mathbf{3}) \oplus (\mathbf{3}, \mathbf{5}) \oplus (\mathbf{1}, \mathbf{7})$	(2, 10)
	$D_4 \xleftarrow{(S)} A_1 \oplus C_2 \xleftarrow{(S)} A_1 \oplus A_1$	

Table 13 (continued): The adjoint branching rule for the subalgebras $A_1 \oplus A_1 \rightarrow G_2, C_2, A_3, B_3,$ and D_4 .

\mathfrak{g}	Branching Rules	Choice of A_1	Index
G_2	$G_2 \xleftarrow{(R)} A_1 \oplus \tilde{A}_1 \longleftarrow A_1$		
	(1) $1\mathbf{4} = \mathbf{3} \oplus \mathbf{2}^{\oplus 4} \oplus \mathbf{1}^{\oplus 3}$	A_1	1

Table 14: The adjoint branching rule for the subalgebras A_1 in $G_2, C_2, A_3, B_3,$ and D_4 .

\mathfrak{g}	Branching Rules	Choice of A_1	Index
	(2) $14 = 3 \oplus 4^{\oplus 2} \oplus 1^{\oplus 3}$	\tilde{A}_1	3
	(3) $14 = 3^{\oplus 3} \oplus 5$	$A_{1,\text{diag}}$	4
C_2	$C_2 \xleftarrow{(R)} A_1 \oplus \tilde{A}_1 \leftarrow A_1$		
	(1) $10 = 3 \oplus 2^{\oplus 2} \oplus 1^{\oplus 3}$	A_1, \tilde{A}_1	1
	(2) $10 = 3^{\oplus 3} \oplus 1$	$A_{1,\text{diag}}$	2
A_3	$A_3 \xleftarrow{(R)} A_1 \oplus A_1 \oplus U_1 \leftarrow A_1 \oplus \tilde{A}_1 \leftarrow A_1$ $A_3 \xleftarrow{(S)} C_2 \xleftarrow{(R)} A_1 \oplus \tilde{A}_1 \leftarrow A_1$		
	(1) $15 = 3 \oplus 1^{\oplus 4} \oplus 2^{\oplus 4}$	A_1, \tilde{A}_1	1
	(2) $15 = 3^{\oplus 4} \oplus 1^{\oplus 3}$	$A_{1,\text{diag}}$	2
	$A_3 \xleftarrow{(S)} A_1 \oplus \tilde{A}_1 \leftarrow A_1$		
	(2) $15 = 3^{\oplus 4} \oplus 1^{\oplus 3}$	A_1, \tilde{A}_1	2
	(3) $15 = 3^{\oplus 3} \oplus 5 \oplus 1$	$A_{1,\text{diag}}$	4
B_3	$B_3 \xleftarrow{(R)} A_3 \xleftarrow{(R)} A_1 \oplus A_1 \oplus U_1 \leftarrow A_1 \oplus \tilde{A}_1 \leftarrow A_1$ $B_3 \xleftarrow{(R)} A_3 \xleftarrow{(S)} C_2 \xleftarrow{(R)} A_1 \oplus \tilde{A}_1 \leftarrow A_1$ $B_3 \xleftarrow{(R)} A_1 \oplus A_1 \oplus \tilde{A}_1 \leftarrow A_1 \oplus \tilde{A}_1 \leftarrow A_1$ $B_3 \xleftarrow{(R)} C_2 \oplus U_1 \xleftarrow{(R)} A_1 \oplus A_1 \oplus U_1 \leftarrow A_1 \oplus \tilde{A}_1 \leftarrow A_1$		
	(1) $21 = 3 \oplus 2^{\oplus 6} \oplus 1^{\oplus 6}$	A_1, \tilde{A}_1	1
	(2) $21 = 3^{\oplus 5} \oplus 1^{\oplus 6}$	$A_{1,\text{diag}}$	2
	$B_3 \xleftarrow{(R)} A_3 \xleftarrow{(S)} A_1 \oplus \tilde{A}_1$		
	(2) $21 = 3^{\oplus 5} \oplus 1^{\oplus 6}$	A_1, \tilde{A}_1	2
	(4) $21 = 3^{\oplus 5} \oplus 5 \oplus 1$	$A_{1,\text{diag}}$	4
B_3	$B_3 \xleftarrow{(R)} A_1 \oplus A_1 \oplus \tilde{A}_1 \leftarrow A_1 \oplus \tilde{A}_1 \leftarrow A_1$		
	(1) $21 = 3 \oplus 2^{\oplus 6} \oplus 1^{\oplus 6}$	A_1	1
	(2) $21 = 3^{\oplus 5} \oplus 1^{\oplus 6}$	\tilde{A}_1	2
	(3) $21 = 3^{\oplus 2} \oplus 4^{\oplus 2} \oplus 2^{\oplus 2} \oplus 1^{\oplus 3}$	$A_{1,\text{diag}}$	3

Table 14 (continued): The adjoint branching rule for the subalgebras A_1 in G_2 , C_2 , A_3 , B_3 , and D_4 .

\mathfrak{g}	Branching Rules	Choice of A_1	Index
	$B_3 \xleftarrow{(S)} G_2 \xleftarrow{(R)} A_1 \oplus \tilde{A}_1 \longleftarrow A_1$		
	(1) $\mathbf{21} = \mathbf{3} \oplus \mathbf{2}^{\oplus 6} \oplus \mathbf{1}^{\oplus 6}$	A_1	1
	(3) $\mathbf{21} = \mathbf{3}^{\oplus 2} \oplus \mathbf{4}^{\oplus 2} \oplus \mathbf{2}^{\oplus 2} \oplus \mathbf{1}^{\oplus 3}$	\tilde{A}_1	3
	(4) $\mathbf{21} = \mathbf{3}^{\oplus 5} \oplus \mathbf{5} \oplus \mathbf{1}$	$A_{1,\text{diag}}$	4
D_4	$D_4 \xleftarrow{(R)} A_1 \oplus A_1 \oplus A_1 \oplus A_1 \longleftarrow A_1 \oplus \tilde{A}_1 \longleftarrow A_1$ $D_4 \xleftarrow{(R)} A_3 \oplus U_1 \xleftarrow{(R)} A_1 \oplus A_1 \oplus U_1 \oplus U_1 \longleftarrow A_1 \oplus \tilde{A}_1 \longleftarrow A_1$ $D_4 \xleftarrow{(R)} A_3 \oplus U_1 \xleftarrow{(S)} C_2 \oplus U_1 \xleftarrow{(R)} A_1 \oplus A_1 \oplus U_1 \longleftarrow A_1 \oplus \tilde{A}_1 \longleftarrow A_1$ $D_4 \xleftarrow{(S)} B_3 \xleftarrow{(R)} A_3 \xleftarrow{(R)} A_1 \oplus A_1 \oplus U_1 \longleftarrow A_1 \oplus \tilde{A}_1 \longleftarrow A_1$ $D_4 \xleftarrow{(S)} B_3 \xleftarrow{(R)} A_3 \xleftarrow{(S)} C_2 \xleftarrow{(R)} A_1 \oplus \tilde{A}_1 \longleftarrow A_1$ $D_4 \xleftarrow{(S)} B_3 \xleftarrow{(R)} A_1 \oplus A_1 \oplus A'_1 \longleftarrow A_1 \oplus \tilde{A}_1 \longleftarrow A_1$ $D_4 \xleftarrow{(S)} B_3 \xleftarrow{(R)} C_2 \oplus U_1 \xleftarrow{(R)} A_1 \oplus A_1 \oplus U_1 \longleftarrow A_1 \oplus \tilde{A}_1 \longleftarrow A_1$ $D_4 \xleftarrow{(S)} A_1 \oplus C_2 \xleftarrow{(R)} A'_1 \oplus A_1 \oplus A_1 \longleftarrow A'_1 \oplus \tilde{A}_1 \longleftarrow A_1$		
	(1) $\mathbf{28} = \mathbf{3} \oplus \mathbf{1}^{\oplus 9} \oplus \mathbf{2}^{\oplus 8}$	A_1, \tilde{A}_1	1
	(2) $\mathbf{28} = \mathbf{3}^{\oplus 6} \oplus \mathbf{1}^{\oplus 10}$	$A_{1,\text{diag}}$	2
	$D_4 \xleftarrow{(R)} A_3 \oplus U_1 \xleftarrow{(S)} A_1 \oplus A_1 \oplus U_1 \longleftarrow A_1 \oplus \tilde{A}_1 \longleftarrow A_1$ $D_4 \xleftarrow{(S)} B_3 \xleftarrow{(R)} A_3 \xleftarrow{(S)} A_1 \oplus \tilde{A}_1 \longleftarrow A_1$ $D_4 \xleftarrow{(S)} A_1 \oplus C_2 \xleftarrow{(R)} A_1 \oplus A_1 \oplus U_1 \longleftarrow A_1 \oplus \tilde{A}_1 \longleftarrow A_1$		
	(2) $\mathbf{28} = \mathbf{3}^{\oplus 6} \oplus \mathbf{1}^{\oplus 10}$	A_1, \tilde{A}_1	2
	(4) $\mathbf{28} = \mathbf{3}^{\oplus 7} \oplus \mathbf{5} \oplus \mathbf{1}^{\oplus 2}$	$A_{1,\text{diag}}$	4
D_4	$D_4 \xleftarrow{(S)} B_3 \xleftarrow{(R)} A_1 \oplus A_1 \oplus A'_1 \longleftarrow A_1 \oplus A'_1$ $D_4 \xleftarrow{(S)} A_1 \oplus C_2 \xleftarrow{(R)} A'_1 \oplus A_1 \oplus A_1 \longleftarrow A_1 \oplus A_1$		
	(1) $\mathbf{28} = \mathbf{3} \oplus \mathbf{1}^{\oplus 9} \oplus \mathbf{2}^{\oplus 8}$	A_1	1
	(2) $\mathbf{28} = \mathbf{3}^{\oplus 6} \oplus \mathbf{1}^{\oplus 10}$	\tilde{A}_1	2
	(3) $\mathbf{28} = \mathbf{3}^{\oplus 3} \oplus \mathbf{4}^{\oplus 2} \oplus \mathbf{2}^{\oplus 4} \oplus \mathbf{1}^{\oplus 3}$	$A_{1,\text{diag}}$	3
	$D_4 \xleftarrow{(S)} B_3 \xleftarrow{(S)} G_2 \xleftarrow{(R)} A_1 \oplus A_1$		

Table 14 (continued): The adjoint branching rule for the subalgebras A_1 in G_2 , C_2 , A_3 , B_3 , and D_4 .

\mathfrak{g}	Branching Rules	Choice of A_1	Index
	(1) $\mathbf{28} = \mathbf{3} \oplus \mathbf{1}^{\oplus 9} \oplus \mathbf{2}^{\oplus 8}$	A_1	1
	(3) $\mathbf{28} = \mathbf{3}^{\oplus 3} \oplus \mathbf{2}^{\oplus 4} \oplus \mathbf{4}^{\oplus 2} \oplus \mathbf{1}^{\oplus 3}$	\tilde{A}_1	3
	(4) $\mathbf{28} = \mathbf{3}^{\oplus 7} \oplus \mathbf{5} \oplus \mathbf{1}^{\oplus 2}$	$A_{1,\text{diag}}$	4
	$D_4 \xleftarrow{(S)} A_1 \oplus C_2 \xleftarrow{(S)} A_1 \oplus A_1$		
	(2) $\mathbf{28} = \mathbf{3}^{\oplus 6} \oplus \mathbf{1}^{\oplus 10}$	A_1	2
	(5) $\mathbf{28} = \mathbf{3} \oplus \mathbf{5}^{\oplus 3} \oplus \mathbf{7} \oplus \mathbf{1}^{\oplus 3}$	\tilde{A}_1	10
	(6) $\mathbf{28} = \mathbf{3}^{\oplus 3} \oplus \mathbf{5} \oplus \mathbf{7}^{\oplus 2}$	$A_{1,\text{diag}}$	12

Table 14 (continued): The adjoint branching rule for the subalgebras A_1 in G_2 , C_2 , A_3 , B_3 , and D_4 .

Acknowledgements

M.E. is supported in part by the National Science Foundation (NSF) grant DMS-1701635 ‘‘Elliptic Fibrations and String Theory’’. M.J.K. is supported by a Sherman Fairchild Postdoctoral Fellowship and the National Research Foundation of Korea (NRF) grants NRF-2020R1C1C1007591 and NRF-2020R1A4A3079707. This material is based upon work supported by the U.S. Department of Energy, Office of Science, Office of High Energy Physics, under Award Number DE-SC0011632.

References

- [1] L. B. Anderson, M. Esole, L. Fredrickson, and L. P. Schaposnik, Singular Geometry and Higgs Bundles in String Theory, *SIGMA* **14**, 037 (2018)
- [2] P. S. Aspinwall and M. Gross, The $SO(32)$ heterotic string on a K3 surface, *Phys. Lett. B* **387**, 735 (1996)
- [3] P. S. Aspinwall, S. H. Katz and D. R. Morrison, Lie groups, Calabi-Yau threefolds, and F theory, *Adv. Theor. Math. Phys.* **4**, 95 (2000) [hep-th/0002012].
- [4] L. Bhardwaj and P. Jefferson, ‘‘Classifying 5d SCFTs via 6d SCFTs: Rank one,’’ *JHEP* **07** (2019), 178
- [5] M. Bershadsky, K. A. Intriligator, S. Kachru, D. R. Morrison, V. Sadov, and C. Vafa, Geometric singularities and enhanced gauge symmetries. *Nucl. Phys.*, B481:215–252, 1996.
- [6] M. Bershadsky and A. Johansen, Colliding singularities in F theory and phase transitions, *Nucl. Phys. B* **489**, 122 (1997)
- [7] A. Borel, and J. de Siebenthal, ‘‘Les sous-groupes fermés de rang maximum des groupes de Lie clos.’’ *Commentarii mathematici Helvetici* **23** (1949): 200-221.

- [8] N. Bourbaki, *Groups and Lie Algebras. Chap. 7-9.*, Translated from the 1975 and 1982 French originals by A. Pressley. Elements of Mathematics (Berlin). Springer-Verlag, Berlin, 2005.
- [9] M. Del Zotto, J. J. Heckman, A. Tomasiello and C. Vafa, 6d Conformal Matter, JHEP **1502**, 054 (2015) doi:10.1007/JHEP02(2015)054 [arXiv:1407.6359 [hep-th]].
- [10] D. E. Diaconescu and R. Entin, “Calabi-Yau spaces and five-dimensional field theories with exceptional gauge symmetry,” Nucl. Phys. B **538**, 451 (1999).
- [11] W. A. de Graaf, Constructing semisimple subalgebras of semisimple Lie algebras, Journal of Algebra, V325, Issue 1 (2011), pp. 416-430, ISSN 0021-8693.
- [12] E.B. Dynkin Maximal subgroups of the classical groups Tr. Mosk. Mat. Obs., 1 (1952), pp. 39–166 English translation in: Amer. Math. Soc. Transl., 6 (1957), pp. 245–378
- [13] E. B. Dynkin, semisimple subalgebras of semisimple Lie algebras, Mat. Sb. (N.S.), 30 (72) (1952), pp. 349–462; English translation in: Amer. Math. Soc. Transl., 6 (1957), pp. 111–244.
- [14] M. Esole, Introduction to Elliptic Fibrations, Math. Phys. Stud. **9783319654270**, 247 (2017).
- [15] M. Esole, Matter representations and the geography of semisimple Lie subalgebras, to appear.
- [16] M. Esole, J. Fullwood, and S.-T. Yau. D_5 elliptic fibrations: non-Kodaira fibers and new orientifold limits of F-theory. Commun. Num. Theor. Phys. **09**, no. 3, 583 (2015).
- [17] M. Esole, S. G. Jackson, R. Jagadeesan, and A. G. Noël. Incidence Geometry in a Weyl Chamber I: GL_n , arXiv:1508.03038 [math.RT], Advances in Applied Mathematics 119: 102048, 2020.
- [18] M. Esole, S. G. Jackson, R. Jagadeesan and A. G. Noël, Incidence Geometry in a Weyl Chamber II: SL_n , arXiv:1601.05070 [math.RT]. Advances in Applied Mathematics 119: 102049, 2020.
- [19] M. Esole, R. Jagadeesan and M. J. Kang, The Geometry of G_2 , $Spin(7)$, and $Spin(8)$ -models, arXiv:1709.04913 [hep-th].
- [20] M. Esole, R. Jagadeesan, and M. J. Kang, 48 Crepant paths to $SU(2) \times SU(3)$, arXiv:1905.05174 [hep-th].
- [21] M. Esole and P. Jefferson, “ $USp(4)$ -models,” [arXiv:1910.09536 [hep-th]].
- [22] M. Esole and P. Jefferson, “The Geometry of $SO(3)$, $SO(5)$, and $SO(6)$ models, [arXiv:1905.12620 [hep-th]].
- [23] M. Esole, P. Jefferson and M. J. Kang, The Geometry of F_4 -Models, arXiv:1704.08251 [hep-th].
- [24] M. Esole, P. Jefferson and M. J. Kang, Euler Characteristics of Crepant Resolutions of Weierstrass Models, arXiv:1703.00905 [math.AG].
- [25] M. Esole and M. J. Kang, To appear.
- [26] M. Esole and M. J. Kang, Characteristic numbers of elliptic fibrations with non-trivial Mordell–Weil groups, arXiv:1808.07054 [hep-th].

- [27] M. Esole and M. J. Kang, Characteristic numbers of crepant resolutions of Weierstrass models, arXiv:1807.08755 [hep-th].
- [28] M. Esole and M. J. Kang, The Geometry of the $SU(2) \times G_2$ -model, *JHEP* **1902**, 091 (2019)
- [29] M. Esole and M. J. Kang, Flopping and Slicing: $SO(4)$ and $Spin(4)$ -models, *Adv. Theor. Math. Phys.* **23** (2019) no.4, 1003-1066 doi:10.4310/ATMP.2019.v23.n4.a2 [arXiv:1802.04802 [hep-th]].
- [30] M. Esole, M. J. Kang and S. T. Yau, Mordell-Weil Torsion, Anomalies, and Phase Transitions, arXiv:1712.02337 [hep-th].
- [31] M. Esole, M. J. Kang and S. T. Yau, A New Model for Elliptic Fibrations with a rank one Mordell-Weil Group: I. Singular Fibers and Semi-Stable Degenerations, arXiv:1410.0003 [hep-th]
- [32] M. Esole and S. Pasterski, “Flops and Fibrational Geometry of E_7 -models,” [arXiv:2004.06104 [hep-th]].
- [33] M. Esole and S. Pasterski, “The suspended pinch point and $SU(2) \times U(1)$ gauge theories,” [arXiv:1906.07157 [hep-th]].
- [34] M. Esole and S. Pasterski, “ D_4 -flops of the E_7 -model,” [arXiv:1901.00093 [hep-th]].
- [35] M. Esole and S. H. Shao, “M-theory on Elliptic Calabi-Yau Threefolds and 6d Anomalies,” [arXiv:1504.01387 [hep-th]].
- [36] M. Esole, S.-H. Shao, and S.-T. Yau. Singularities and Gauge Theory Phases. *Adv. Theor. Math. Phys.*, 19:1183–1247, 2015.
- [37] M. Esole, S. H. Shao and S. T. Yau, Singularities and Gauge Theory Phases II, *Adv. Theor. Math. Phys.* 20, 683 (2016)
- [38] M. Esole and S. T. Yau, Small resolutions of $SU(5)$ -models in F-theory, *Adv. Theor. Math. Phys.* 17, no. 6, 1195 (2013)
- [39] A. Grassi and D. R. Morrison. Group representations and the Euler characteristic of elliptically fibered Calabi-Yau threefolds. *J. Algebraic Geom.*, 12(2):321–356, 2003.
- [40] H. Hayashi, C. Lawrie, D. R. Morrison, and S. Schäfer-Nameki. Box Graphs and Singular Fibers. *JHEP*, 1405:048, 2014.
- [41] T. W. Grimm, M. Kerstan, E. Palti and T. Weigand, “Massive Abelian Gauge Symmetries and Fluxes in F-theory,” *JHEP* **12** (2011), 004
- [42] J. Gu, B. Haghighat, A. Klemm, K. Sun and X. Wang, “Elliptic Blowup Equations for 6d SCFTs. IV: Matters,” [arXiv:2006.03030 [hep-th]].
- [43] J. J. Heckman and T. Rudelius, Top Down Approach to 6D SCFTs, *J. Phys. A* **52**, no. 9, 093001 (2019)
- [44] K. A. Intriligator, D. R. Morrison, and N. Seiberg. Five-dimensional supersymmetric gauge theories and degenerations of Calabi-Yau spaces. *Nucl.Phys.*, B497:56–100, 1997.

- [45] K. A. Intriligator and N. Seiberg, “Duality, monopoles, dyons, confinement and oblique confinement in supersymmetric $SO(N(c))$ gauge theories,” Nucl. Phys. B **444** (1995), 125-160
- [46] N. Kan, S. Mizoguchi and T. Tani, “Half-hypermultiplets and incomplete/complete resolutions in F-theory,” JHEP **08** (2020), 063 doi:10.1007/JHEP08(2020)063
- [47] R. Kuramochi, S. Mizoguchi and T. Tani, “Magic square and half-hypermultiplets in F-theory,” [arXiv:2008.09272 [hep-th]].
- [48] S. H. Katz and C. Vafa, Matter from geometry, Nucl. Phys. B **497**, 146 (1997)
- [49] D. Klevers, D. R. Morrison, N. Raghuram and W. Taylor, “Exotic matter on singular divisors in F-theory,” JHEP **1711**, 124 (2017)
- [50] Y. Laszlo and C. Sorger, The line bundles on the moduli of parabolic G-bundles over curves and their sections. Ann. scient. École Norm. Sup. 4e series, Vol 30 n 4 (1997), p. 499–525
- [51] Lorente, M., Gruber, B. (1972). Classification of semisimple subalgebras of simple Lie algebras. Journal of Mathematical Physics, 13(10), 1639-1663.
- [52] J. Marsano and S. Schafer-Nameki, “Yukawas, G-flux, and Spectral Covers from Resolved Calabi-Yau’s,” JHEP **11** (2011), 098 doi:10.1007/JHEP11(2011)098
- [53] W. G. McKay and J. Patera. Tables of dimensions, indices, and branching rules for representations of simple Lie algebras. Marcel Dekker Inc., New York, 1981.
- [54] A. N. Minchenko. semisimple subalgebras of exceptional Lie algebras. Tr. Mosk. Mat. Obs., 67:256–293, 2006. English translation in: Trans. Moscow Math. Soc. 2006, 225–259.
- [55] R. Miranda. Smooth models for elliptic threefolds. In *The birational geometry of degenerations (Cambridge, Mass., 1981)*, volume 29 of *Progr. Math.*, pages 85–133. Birkhäuser Boston, Mass., 1983.
- [56] D. R. Morrison and W. Taylor, “Matter and singularities,” JHEP **01** (2012), 022
- [57] D. R. Morrison and W. Taylor, Classifying bases for 6D F-theory models, Central Eur. J. Phys. **10**, 1072 (2012)
- [58] D. R. Morrison and C. Vafa, “Compactifications of F theory on Calabi-Yau threefolds. 1,” Nucl. Phys. B **473** (1996), 74-92 doi:10.1016/0550-3213(96)00242-8 [arXiv:hep-th/9602114 [hep-th]].
- [59] V. Sadov, Generalized Green–Schwarz mechanism in F theory, Phys. Lett. B **388**, 45 (1996).
- [60] K. Ohmori, H. Shimizu, Y. Tachikawa and K. Yonekura, 6d $\mathcal{N} = (1, 0)$ theories on S^1/T^2 and class S theories: part II, JHEP **1512**, 131 (2015)
- [61] J. Polchinski, “String theory. Vol. 1: An introduction to the bosonic string,” doi:10.1017/CBO9780511816079
- [62] A. Sen, “A Note on enhanced gauge symmetries in M and string theory,” JHEP **09** (1997), 001 doi:10.1088/1126-6708/1997/09/001 arXiv:hep-th/9707123 [hep-th].
- [63] R. Slansky, “Group Theory for Unified Model Building,” Phys. Rept. **79**, 1 (1981).

- [64] T. Weigand, “F-theory,” PoS **TASI2017** (2018), 016
- [65] E. Witten, “String theory dynamics in various dimensions,” Nucl. Phys. B **443** (1995), 85-126 doi:10.1016/0550-3213(95)00158-O arXiv:hep-th/9503124 [hep-th].
- [66] N. Yamatsu, Finite-Dimensional Lie Algebras and Their Representations for Unified Model Building, arXiv:1511.08771 [hep-ph].
- [67] C. Vafa, “Evidence for F theory,” Nucl. Phys. B **469** (1996), 403-418 doi:10.1016/0550-3213(96)00172-1