

# Analysing Networks of Networks\*

Johan Koskinen<sup>†</sup>   Pete Jones<sup>‡</sup>   Darkhan Medeuov<sup>§</sup>  
Artem Antonyuk<sup>§</sup>   Kseniia Puzyreva<sup>§</sup>   Nikita Basov<sup>§</sup>

August 11, 2020

## Abstract

We consider data with multiple observations or reports on a network in the case when these networks themselves are connected through some form of network ties. We could take the example of a cognitive social structure where there is another type of tie connecting the actors that provide the reports; or the study of interpersonal spillover effects from one cultural domain to another facilitated by the social ties. Another example is when the individual semantic structures are represented as semantic networks of a group of actors and connected through these actors' social ties to constitute knowledge of a social group. How to jointly represent the two types of networks is not trivial as the layers and not the nodes of the layers of the reported networks are coupled through a network on the reports. We propose to transform the different multiple networks using line graphs, where actors are affiliated with ties represented as nodes, and represent the totality of the different types of ties as a multilevel network. This affords studying the associations between the social network and the reports as well as the alignment of the reports to a criterion graph. We illustrate how the procedure can be applied to studying the social construction of knowledge in local flood management groups. Here we use multilevel exponential random graph models but the representation also lends itself to stochastic actor-oriented models, multilevel blockmodels, and any model capable of handling multilevel networks. **Keywords:** Multiplex, Multilevel networks, Sociosemantic networks, Multigraphs.

---

\*This work was supported by funding from the Russian Science Foundation (project No. 19-18-00394, 'Creation of knowledge on ecological hazards in Russian and European local communities'). The work of Jones was carried out while being an academic visitor to The Social Networks Lab, The University of Melbourne

<sup>†</sup>The Social Networks Lab, The Melbourne School of Psychological Sciences, University of Melbourne johan.koskinen@munimelb.edu.au.

<sup>‡</sup>The Mitchell Centre for Social Network Analysis, pete.jones@unimelb.edu.au

<sup>§</sup>Centre for German and European Studies, St Petersburg University

# 1 Introduction and basic definitions

We consider a set of nodes  $\mathcal{N} = \{1, \dots, N\}$  with a set of possible ties  $\mathcal{E} = \binom{\mathcal{N}}{2}$ ,  $e = |\mathcal{E}|$ . For a realisation  $E \subset \mathcal{E}$  of ties, we let  $\mathbf{X} = (X_{ij})$  be the standard adjacency matrix. Here we assume that for index set  $V = \{1, \dots, n\}$ , we have adjacency matrices  $\mathbf{X}_1, \dots, \mathbf{X}_n$ , representing the networks  $\mathcal{H} = \{\mathcal{H}_1, \dots, \mathcal{H}_n\}$ , on the same node set  $\mathcal{N}$  and set of pairs  $\mathcal{E}$ . In addition, we assume that the nodes of  $V$  are connected through a network  $\mathcal{M}$ . We allow for the existence of a fixed and given criterion graph  $\mathcal{G}(\mathcal{N}, E)$ . We propose to represent the totality of ties as a multilevel network (Lazega et al., 2008) on two node sets, where one node set is  $V$  and the other is  $\mathcal{E}$  treated as a set of nodes. The latter is key to retaining all information, and by recognising that  $\mathcal{E}$ , treated as a set of nodes, means that these nodes are not independently defined but connected through the shared, constituent nodes in  $\mathcal{N}$ . These latter connections are represented through a network  $\mathcal{Q}$  on the node set  $\mathcal{E}$ . The new multilevel network thus represents a *network*  $\mathcal{M}$ , of *networks*  $\mathcal{H}_1, \dots, \mathcal{H}_n$ .

There is a long tradition of analysing multiplex networks (Mitchell, 1974; Davis, 1968; Wasserman and Faust, 1994), with many of the classic network datasets (Sampson, 1969; Kapferer, 1972; Padgett and Ansell, 1993) specifically designed to investigate the interrelation of different types of ties. For a multiplex network,  $\mathcal{H}$  represents different relations on  $\mathcal{N}$ . The networks  $\mathcal{H}$  may also represent repeated observations on the same type of tie through time or by different reporters. An example of the latter is when multiple raters report on the same relation, such as the cognitive social structures (CSS) data collection paradigm (Moreno, 1934; Newcomb, 1961; Krackhardt, 1987). The challenges associated with the joint analysis of multiplex networks are well documented (White 1963; White et al., 1976; Pattison 1993; Lazega and Pattison, 1999; Rivero Ostoic, 2020) as are the issues with analysing multiple raters without having a gold standard network on  $\mathcal{N}$  for reference in CSS (see e.g., Butts, 2003). Nevertheless, a wealth of research has come out of the study of multiple networks in the form of  $\mathcal{H}$ . For multiplex analysis  $n$  is typically small, enabling the researcher to formulate specific hypotheses about how the networks  $\mathcal{H}$  are related (Koehly and Pattison, 2005). Large  $n$  leads to a combinatorial explosion that makes investigating theoretically informed multiplexities difficult but large  $n$  still permits exploration of dimensions of relations (Vörös and Snijders, 2017); relational algebras (Rivero Ostoic, 2017, 2020) and testing of structure using a multigraph representation (Shafie, 2015). For CSS  $n = N$  and the main challenge is typically how to relate  $\mathcal{H}$  to an unobserved consensus structure or criterion graph  $\mathcal{G}(\mathcal{N}, E)$ .

There is a growing number of conceptual frameworks for joint analysis of different types of ties over different types of nodes, such as multilevel networks (Lazega et al., 2008), multilayered networks (Kivelä et al., 2014), sociosemantic

networks (Basov, 2020), socioecological networks (Bodin et al., 2016), etc. Many on them have in common that networks on different types of nodes are connected through two-mode affiliation ties. In particular, a network  $\mathcal{G}$  is connected to a network  $\mathcal{M}$ , through affiliations  $\mathcal{B}$  linking  $V$  to  $\mathcal{N}$ . This affiliation network consequently connects a social network with another type of network, on a different node set  $\mathcal{N}$ . If we have multiple networks on  $\mathcal{N}$ , and that it is these networks that are connected through social ties, the multilevel one-mode by two-mode representation does not apply straightforwardly. For multilevel networks, there are instances where multiple networks on  $\mathcal{N}$  may add insight over and above the representation using affiliations of  $V$  to nodes in  $\mathcal{N}$ . For example, Wang et al. (2015), study consumer preferences among products in a product layer, network of similarities among products, and a social network among consumers in a sociomaterial network (Contractor et al., 2011). In the canonical representation of clans, forestry, and ecology in the socioecological network of Bodin and Tengö (2012), the clans are assumed to act on a universally understood network  $\mathcal{G}$  of forests. This ecological network  $\mathcal{G}$  of forest could be disaggregated and represented as each clan’s perception or understanding  $\mathcal{H}_1, \dots, \mathcal{H}_n$  of how forests are related. In sociosemantic networks (Roth and Cointet, 2010; Hellsten and Leydesdorff, 2017; Basov, Lee, and Antoniuk, 2016; Basov, 2020), the semantic network may be taken as a normative, exogenously given network  $\mathcal{G}$  that social actors relate to through affiliations  $\mathcal{B}$  with concepts. If the semantic network is a local semantic network, aggregated across individual meaning structures (the personal ‘semantic networks’)  $\mathcal{H}_1, \dots, \mathcal{H}_n$ , the local semantic network may be disaggregated into  $n$  versions of how the concepts are related.

Multiplex approaches can handle complex dependencies between and within  $\mathcal{H}$  for small  $n$ . CSS may handle the comparison of  $\mathcal{H}$  and a criterion graph  $\mathcal{G}$  for large  $n$  assuming independence between and within reports  $V$ , conditional on  $\mathcal{G}$ . Accounting for complex dependencies within and between  $\mathcal{H}$  comparing to a criterion graph  $\mathcal{G}$  is thus a considerable challenge. In particular, how do we account for dependence between report, conditionally on  $\mathcal{G}$  if these dependencies are induced by a network  $\mathcal{M}$  on  $V$ ? Here we propose mapping  $\{\mathcal{H}, \mathcal{G}, \mathcal{M}\}$  to a multilevel network (Lazega et al., 2008) on  $V$  and  $\mathcal{E}$  as nodes, with ties defined by  $\mathcal{M}$  and  $\mathcal{H}$ , and  $\mathcal{G}$  represented by node-level covariates. We present how meaningful hypotheses for the original representation of data may be translated into hypotheses expressed in terms of *configurations* (Moreno and Jennings, 1938) in the new, multilevel form. The multilevel representation of the network of networks means that a network of networks lends itself to estimation using any model or statistical package that can model multilevel networks, such as stochastic actor-oriented models (Hollway et al., 2017), exponential random graph models (Wang et al., 2013), and blockmodels (Žibena and Lazega, 2016). We illustrate the application of the representation to test hypotheses about the local production of knowledge

for a dataset on flood management. We find dyadic social network effects on knowledge: People who are socially connected also tend to connect the same concepts via meaningful associations, i.e., to generate knowledge jointly. Moreover, the multilevel representation of network of networks approach allows us to show that alignment with a normative semantic network (here, of expert knowledge) moderates local social production of knowledge. This opens new methodological prospects for studying the dispositional effects on local production of culture (Rawlings and Childress, 2019)

## 2 Multilevel representation

When having one-mode networks among a set of actors that are also affiliated with organisations, that, in turn, are connected amongst themselves, Lazega et al. (2008) propose to represent the totality of ties in a multilevel network. A multilevel network thus has two types of nodes and three types of ties. While the multilevel network could be represented as one one-mode network, where the types of ties were identified by their constituent nodes, Lazega et al. (2008) demonstrate the analytical advantages that can be had from retaining a strict distinction between the networks. In particular, the multilevel representation affords specifying different types of dependencies depending on the combination of the types of ties that are used.

### 2.1 Network of networks

In the original representation of data used here  $\{\mathcal{H}, \mathcal{G}, \mathcal{M}\}$ , there is a clear distinction between the nodes on  $\mathcal{G}$  and the  $\mathcal{H}_i$ 's, on the one hand, and the nodes of  $\mathcal{M}$  on the other. The nodes of  $V$  have ties amongst themselves but they do not have ties to the nodes of  $\mathcal{G}$ , something which makes the joint representation less than trivial. To define a joint representation, consider the representations of the original data  $\mathcal{H}$  and  $\mathcal{G}$  in Figure 1 and  $\mathcal{M}$  in Figure 2.

The networks in Figure 1 could represent a multiplex network where  $i$ ,  $j$ , and  $k$ , are different relations and  $\mathcal{G}$  an additional fourth relation. In the CSS framework the nodeset  $\mathcal{N}$  would be the same as  $V$ , and  $\mathcal{G}$  would represent some consensus graph on the same node set. In the case of multiplex networks and  $n$  small, we could formulate specific hypotheses for how the networks  $\mathcal{H}$  relate pair-wise to each other. For example in the case of generalised exchange, we might ask if a tie  $\{s, v\}$  in  $\mathcal{H}_k$  closes an open triad  $\{\{s, u\}, \{u, v\}\}$  in  $\mathcal{H}_i$ . For CSS, we may introduce dependencies on  $V$  through, for example, asserting that respondents are more accurate when reporting on their own ties (Krackhardt, 1987; Batchelder et al. 1997; Butts, 2003; Koskinen, 2004). If  $i = u$  and  $j = s$ , then affording greater

accuracy for self-reports would mean that we would trust the reports by  $i$  and  $j$  on the tie  $\{u, s\} = \{i, j\}$ , that the tie is present, than the report of  $k$ ,  $k \neq i, j$ , that reports the tie as being absent.

For networks where  $\mathcal{N}$  is not a set of social actors, there are several examples of multiple, ‘parallel’ networks. In the framework of Friedkin et al. (2016),  $i$ ,  $j$ , and  $k$  may represent different systems of belief, where beliefs are represented as connections of concepts in  $\mathcal{N}$ . Friedkin et al. (2016) do not model  $\mathcal{H}$  but take these as a small collection of fixed and known belief systems and assume that people may be influenced to change from endorsing one belief system  $\mathcal{H}_i$  to another  $\mathcal{H}_j$ . A related example is when the networks  $\mathcal{H}$  are semantic networks representing the local meaning structures (Basov, de Nooy, and Nenko, 2019) of respondents in  $V$ .

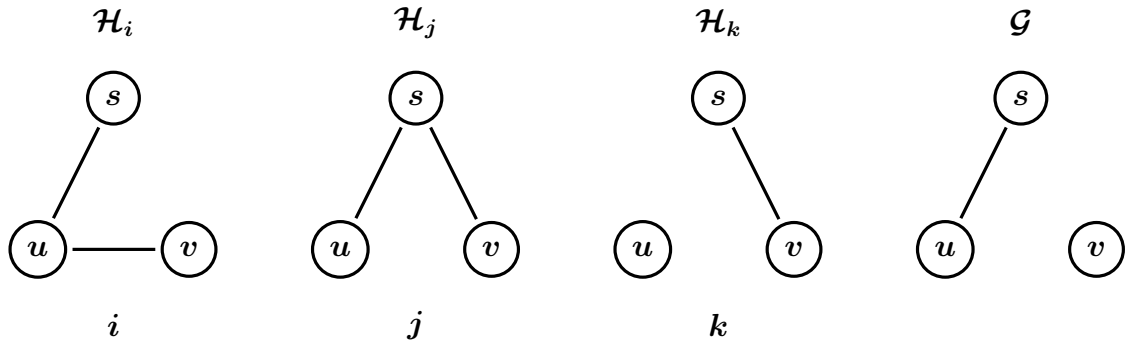

Figure 1: Networks of  $i, j, k \in V$  and criterion network  $\mathcal{G}$

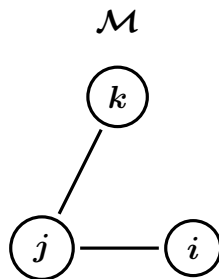

Figure 2: A social network amongst nodes  $i, j$ , and  $k$  in  $\mathcal{M}$

Assuming a network  $\mathcal{M}$  as in Figure 2, means that we have a network amongst the elements of the index set  $V$  of  $\mathcal{H}$ . If  $V = \mathcal{N}$ , that is, we are only dealing with

networks on one type of node, we could represent  $\mathcal{M}$  by  $\mathcal{G}$  but this does not help us specify how the slices in  $\mathcal{H}$  depend on each other. There is nothing in  $\mathcal{G}$  in Figure 1 that, for example, connects, say,  $\mathcal{H}_i$  and  $\mathcal{H}_j$ . The relations between the  $\mathcal{H}_i$ 's as prescribed by  $\mathcal{M}$  is in fact a network of networks (NoNs), as represented in Figure 3. This superficially resembles the representation by Friedkin et al. (2016), that models  $n$  individuals'  $m$  ( $n \neq m$ ) truth statements (a), as a function of a social network (b) among the individuals and a number of belief systems (c). The social network (b) is a weighted version of  $\mathcal{M}$  but here we do not have a structure (a) connecting individuals to belief systems. The belief systems (c) are only superficially similar to the  $\mathcal{H}_i$ 's and are taken to be exogenously defined and not indexed by the actors. The Friedkin et al. (2016) model is not designed to model the network of networks as we conceive of it.

Further examples may include the individual product preferences of consumers linked through social ties (Wang et al., 2015), perceived food webs by fishers (Barnes et al., 2019), intersectional flows in different countries (Leoncini et al., 1996), symptom networks (Borsboom and Cramer, 2013) within individuals, etc, all of which may be connected by a network: consumers through social ties, fishers through communications, countries through trade ties, people through social ties.

## 2.2 Direct modelling of reports, criterion graph, and social network

To motivate the proposed representation of the network of networks as a multilevel graph we briefly consider the challenges associated with modelling  $\mathcal{H}$  directly while incorporating the possible dependence through  $\mathcal{M}$ .

As observed above, we may model  $\mathcal{H}$  directly as a multiplex network, conditional or unconditional on  $\mathcal{G}$ . For example, we can assume that  $\mathbf{X}_1, \dots, \mathbf{X}_n$  follow a multiplex exponential random graph model (Lazega and Pattison, 1999) conditional on  $\mathbf{A}$ , being the adjacency matrix of  $\mathcal{G}$ , with parameters  $\theta$

$$p_\theta(\mathbf{X}_1, \dots, \mathbf{X}_n | \mathbf{A}) = \exp\{\theta^\top z(\mathbf{X}_1, \dots, \mathbf{X}_n; \mathbf{A}) - \psi(\theta)\}$$

for a normalising constant  $\psi(\theta)$ , and where the vector of statistics  $z(\cdot)$  has components

$$z_{k_1, \dots, k_r}(z(\mathbf{X}_1, \dots, \mathbf{X}_n; \mathbf{A})) = z_{k_1, \dots, k_r}(z(\mathbf{X}_{k_1}, \dots, \mathbf{X}_{k_r}; \mathbf{A}))$$

that are functions of subsets

$$\{k_1, \dots, k_r\} \in \binom{V}{r}$$

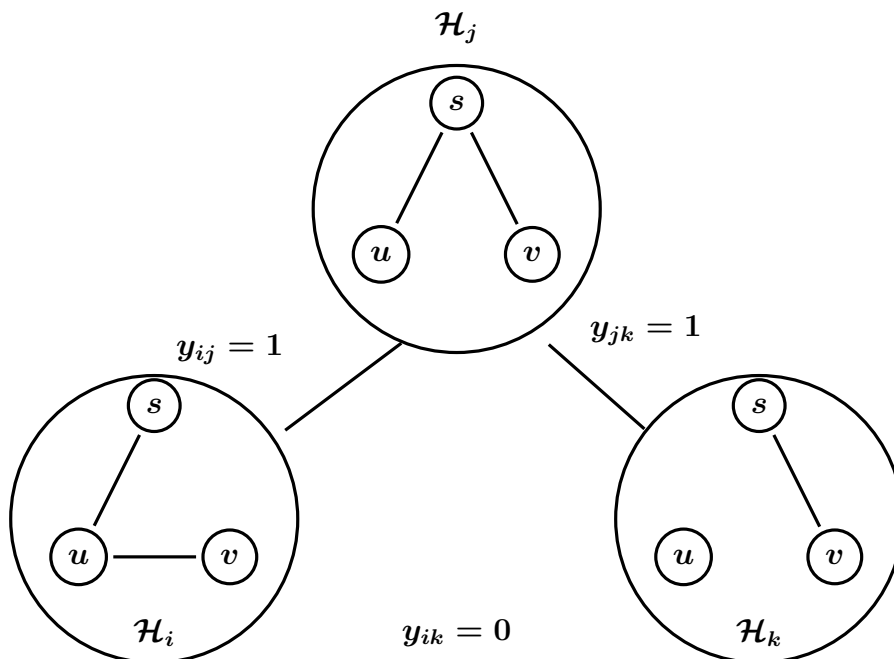

Figure 3: A Network of networks where  $\mathcal{M}$  connects the networks on  $\mathcal{N}$  of  $i, j, k \in V$

For  $r = 2$  we can specify statistics corresponding to entrainment and generalised exchange through terms of the type  $\sum_{k,h} X_{ikh}X_{jkh}$  and  $\sum_{k,h,\ell} X_{ikh}X_{ih\ell}X_{jkl}$ . Dependence on  $\mathcal{M}$  can be introduced through interactions with the variables of  $\mathbf{Y}$ . For example, assume that there is alignment between ties in  $\mathcal{H}_i$  and  $\mathcal{H}_j$  only if  $Y_{ij} = 1$ , in which case the entrainment terms in the multiplex ERGM would be  $y_{ij} \sum_{k,h} X_{ikh}X_{jkh}$ . Note that when  $r = 2$ ,  $Y_{ij}$  is either one or zero, and the interaction  $y_{ij} \sum_{k,h} X_{ikh}X_{jkh}$  is either zero or equal to  $\sum_{k,h} X_{ikh}X_{jkh}$ . The number of possible statistics grows very quickly with  $r$  and the types of statistics we can specify are limited in terms of the types of dependencies we may specify. Additionally, the direct multiplex ERGM does not afford simultaneous modelling of  $\mathcal{H}$  and  $\mathcal{M}$ , at least not easily or in a practical way.

Statistical models for CSS (Batchelder et al., 1997; Butts, 2003; Koskinen, 2004) have typically assumed that the variables  $X_{ikh}$  and  $X_{juv}$  are conditionally independent across  $V$  and  $\mathcal{E}$ , conditional on respondent factors and the criterion graph  $\mathcal{G}$ . Without loss of generality we can assume that

$$p(\mathbf{X}|g, \mathbf{A}) = \prod_{kh} \prod_i \Pr(X_{ikh} = x_{ikh} | A_{kh}, g_i(A_{kh}))$$

where the  $g_i(\cdot)$ 's may incorporate different actor accuracies. This model is eminently tractable and we cannot relax the independence assumption, introducing dependence among reports through  $\mathbf{Y}$ , without losing tractability. Let us consider what happens when we introduce dependence through the ties of  $\mathbf{Y}$ . For example, we may want to allow  $X_{ikh}$  to depend on  $X_{jkh}$  if  $Y_{ij} = 1$ . In a modified model

$$p(\mathbf{X}|g, \mathbf{A}) = \prod_{kh} \Pr(\mathbf{X}_{\cdot kh} = (X_{ikh})_{i \in V} | A_{kh}, g_i(A_{kh}))$$

this can be accommodated, for example, through assuming that conditionally

$$\text{logit} \Pr(X_{ikh} = 1 | (X_{ihk})_{j \neq i}, A_{kh} = 1) = \theta_0 + \theta_1 \sum_{j \neq i} Y_{ij} X_{jkh},$$

an expression that we recognise as the conditional form of the auto-logistic actor attribute model (ALAAM) (Daraganova and Robins, 2013; Koskinen and Daraganova, 2020). In other words, for each  $\{i, j\} \in \mathcal{E}$  we would end up with an ALAAM for the vector of responses  $X_{1kh}, \dots, X_{nkh}$ , in total  $e$  different ALAAMs. ALAAMs might be challenging and would restrict the nature of dependencies we can consider. This framework would for example not allow us to consider dependencies within respondents such as how the responses  $X_{ikh}$  and  $X_{iuv}$  may or may not be dependent.

### 2.3 Representing a network of networks as a multilevel network

We are able to encode the information in  $\mathcal{M}$  and  $\mathcal{H}$ , and  $\mathcal{G}$  in one multilevel network, by representing the dyads  $\mathcal{E}$  of  $\mathcal{H}$  as nodes. Define a mapping from the set of dyads  $\mathcal{E}$  to  $\mathcal{P} = \{1, \dots, e\}$ ,  $\pi : \mathcal{E} \rightarrow \mathcal{P}$ . For nodes  $i \in V$ , we define an affiliation matrix on  $V \times \mathcal{P}$  as an  $n \times e$  affiliation matrix  $\mathbf{W}$  with elements

$$W_{iu} = \begin{cases} 1, & \text{if } X_{i\pi^{-1}(u)} = 1 \\ 0, & \text{otherwise} \end{cases}$$

Thus, if  $i \in V$  has a tie  $\{k, \ell\} \in \mathcal{H}_i$ , and  $\pi(u) = \{k, \ell\}$ , then there is an affiliation tie  $W_{iu} = 1$ . To account for the criterion graph  $\mathcal{G}$ , the vertices  $\mathcal{P}$  are coloured according to whether  $\{k, \ell\} \in \mathcal{G}$  or not, for  $u$  such that  $\pi(\{k, \ell\}) = u$ . The binary colouring of  $\mathcal{P}$  is a vector

$$D_u = \begin{cases} 1, & \text{if } A_{\pi^{-1}(u)} = 1 \\ 0, & \text{otherwise} \end{cases}$$



Denoting the social network on  $V$  by  $\mathbf{Y}$ , as before, and the networks  $\mathbf{X}_1, \dots, \mathbf{X}_n$  expressed as  $\mathbf{W}$ , we can define a multilevel network  $\mathcal{C}$  as a blocked adjacency matrix

$$\mathbf{C}_{(e+n) \times (e+n)} = \begin{pmatrix} \mathbf{0}_{e \times e} & \mathbf{W}^\top \\ \mathbf{W} & \mathbf{Y} \end{pmatrix}$$

where  $\mathbf{0}_{e \times e}$  is a matrix of zeros. The mapping  $\pi$  is arbitrary at this point which means that the structure of the network  $\mathcal{G}$  is only reflected through  $\mathbf{D}$ . The representation  $\mathbf{C}$  is thus agnostic to whether, for example,  $u, v \in \mathcal{P}$  refer to edges  $\pi(u)$  and  $\pi(v)$  that may share a node or not. To relax this independence, we introduce a top-level network by connecting ties that share nodes. Formally, define a graph  $\mathcal{Q}$  as the  $e \times e$  matrix  $\mathbf{Q}$  with elements

$$Q_{uv} = \begin{cases} 1, & \text{if } \pi^{-1}(u) \cap \pi^{-1}(v) \neq \emptyset \\ 0, & \text{otherwise} \end{cases}$$

The graph  $\mathcal{Q}$  is the dependence graph on  $\mathcal{E}$  under the Markov dependence assumption for the ties of  $\mathcal{N}$  (Frank and Strauss, 1987). The graph  $\mathcal{Q}$  is also the complement of the Kneser graph  $KG_{N,2}$ .<sup>1</sup> This gives us the blocked adjacency matrix of a multilevel network

$$\mathbf{C} = \begin{pmatrix} \mathbf{Q} & \mathbf{W}^\top \\ \mathbf{W} & \mathbf{Y} \end{pmatrix}$$

When analysing  $\mathcal{C}$  we need to respect the fact that  $\mathcal{Q}$  is a fixed and exogenous graph that is completely determined by the index set.

We now proceed to describe how network configurations (Moreno and Jennings, 1938) in  $\mathcal{C}$  correspond to meaningful combinations of ties in the network of networks.

### 2.3.1 Basic configurations for $\mathcal{H}$

To capture the overall number of ties reported across  $i \in V$  corresponds to the bipartite density as in Figure 5. The corresponding count, or statistic is simply  $\sum_{i,p} W_{ip}$ . Centralisation of ties in  $\mathcal{E}$  can be further modelled using bipartite 2-stars  $\sum_p \binom{W+p}{2}$  or the equivalent alternating stars (Wang et al., 2009). Similarly we may define 2-stars and alternating stars centered on nodes in  $V$  (Wang et al., 2009). The majority of configurations we discuss in the sequel have been defined or explored for either two-mode networks (Wang et al., 2009) or multilevel networks (Wang

<sup>1</sup>A Kneser (1955) graph  $KG_{n,k}$  has nodes  $V = \binom{n}{k}$ , and edge set  $E = \{(u, v) \in V : u \cap v = \emptyset\}$ . The complement of  $KG_{n,s}$ , is a line-graph where the edge set is  $\bar{E} = \{(u, v) \in V : u \cap v \neq \emptyset\}$ . The graph on  $V$  and  $\bar{E}$  is exactly the dependence graph,  $D$ , of a Markov random graph (Frank and Strauss, 1986; Lusher et al., 2013) on  $V = \{1, \dots, n\}$ .

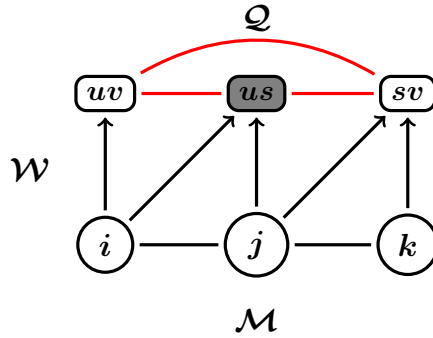

Figure 4: The multilevel network  $\mathcal{C}$  representation of the network of networks in Figure 3, consisting of the networks in Figure 1 connected through the network in Figure 2

et al., 2013) and we refer the reader to the literature for mathematical definitions of these configurations in  $\mathcal{C}$  and focus here on their interpretation in the pre-image of  $\mathcal{H}$ ,  $\mathcal{M}$ , and  $\mathcal{G}$ .

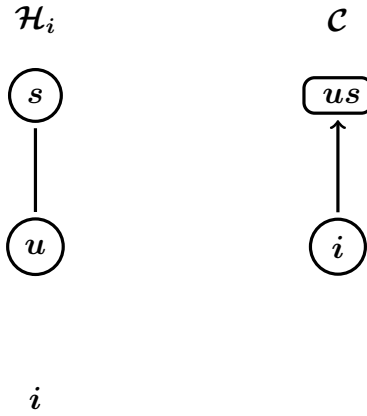

Figure 5: Mapping density in  $\mathcal{H}_i$  to  $\mathcal{C}$

Centrality of nodes in  $\mathcal{N}$  is reflected in multilevel triangles in  $\mathcal{C}$  as in Figure 6. If the network on  $\mathcal{N}$  is a social network, this centralization reflect the typical heterogeneities that we encounter in social networks, such as preferential attachment. If the nodes on  $\mathcal{N}$  are concepts, multilevel closure in  $\mathcal{C}$  of the type Figure 6, could reflect differences in saliency or popularity of concepts but also spill-over (Maki et al., 2019). If individuals associate an energy efficient fridge ( $s$ ) with an energy

efficient washing machine ( $u$ ), they may also associate the energy efficient fridge with electric cars ( $v$ ).

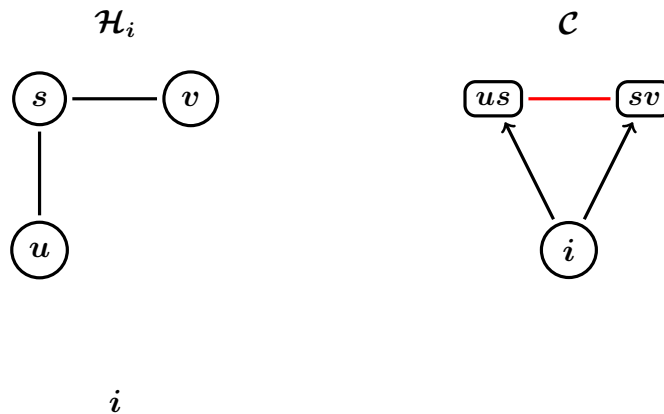

Figure 6: Mapping two-paths in  $\mathcal{H}_i$  to multilevel closure in  $\mathcal{C}$

We could consider a number of ways in which the reports in  $\mathcal{H}$  align with each other. A basic form of entrainment is the agreement on a tie between  $i$  and  $j$  depicted in Figure 7. In a CSS framework we would think of this as relating to the strength of consensus. More generally, this reflects the cultural consensus (Romney et al., 1986; Batchelder and Romney, 1988). While this basic form of entrainment reflects agreement on individual ties in  $\mathcal{E}$ , co-nomination of pairs of ties in  $\mathcal{E}$ , as depicted in Figure 8, reflects a more structural consensus. The four-cycle in Figure 8 represents the most basic form of clustering in a two-mode network (Borgatti and Everett, 1997) and is often taken to represent social processes above simple agreement (Robins and Alexander, 2004; Koskinen and Edling, 2012). Here, in very general terms, the configuration can directly be interpreted as whenever two people  $i$  and  $j$  agree on one thing, they tend to agree on another.

### 2.3.2 Social dependencies in $\mathcal{H}$

Introducing configurations that include the network  $\mathcal{M}$  enable us to investigate social construction and social influence as well as homophily induced by shared beliefs. The agreement in Figure 7 may be the result of social connections, in which case we expect to see high incidence of the social entrainment configuration of Figure 9. For cross-sectional data we cannot tell whether agreement in  $\mathcal{W}$  was the result of a social tie in  $\mathcal{M}$  or the other way around. The nature of the process explaining configurations as in Figure 9 is context dependent and may reflect a multitude of processes, such as learning, information, influence, etc. Heider's

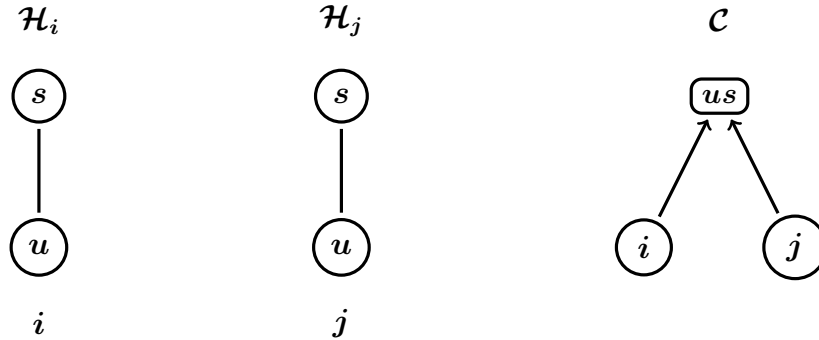

Figure 7: Entrainment of ties of  $\mathcal{H}_i$  and  $\mathcal{H}_j$  expressed as multilevel agreement in  $\mathcal{C}$

(1958) *balance theory* is commonly applied in the networks literature in the triadic form of Cartwright and Harary (1956), where two people with a positive tie are assumed likely to also have a positive tie to the same other. The social alignment of Figure 9, is a direct application of Heider's (1958) *POX* scheme, where person  $P$  (here  $i$ ) seeks to have ties to other  $O$  (here  $j$ ) that like the same object  $X$  (here  $us$ ).

Moving beyond direct alignment, we may consider the interactions of multiple types of ties and how they relate to each other. The multilevel four-cycle in Figure 10, by itself, represents a form of complementarity. Where  $i$  reports that  $u$  is connected to  $s$ ,  $j$  reports that  $u$  is connected to  $v$ . Considered in combination with the alignment of Figure 9 we can think of two ways in which to interpret the tie  $(j, uv)$ . If  $i$  and  $j$  agree on  $\{u, s\}$ , we would expect that they would also agree on  $\{u, v\}$ , and we would expect to see few of the configurations in Figure 10. Similarly, under a social process promoting agreement, we would expect the configuration of Figure 10 to be unstable and tend to be *recombined* to the multilevel triangle of Figure 9.

An example of extra-dyadic dependencies in  $\mathcal{M}$  and their effect on  $\mathcal{H}$  could be that if three nodes  $i$ ,  $j$ , and  $k$  are a clique in  $\mathcal{M}$ , then they are more likely to agree on  $\mathcal{H}$  than what we would see as a result of the dyadic agreement of Figure 9. In Figure 11, three dyads agreeing on  $\{u, s\}$  would be the additive effect of a positive tendency for configuration (b). If there is triadic pressure over and above this additive dyadic pressure, then you would expect that there would be a tendency against  $j$  to in addition nominate  $\{u, v\}$  (Figure 11(a)). Put together, we would expect the tie  $(j, us)$  to be more likely than  $(j, uv)$  in Figure 11(c).

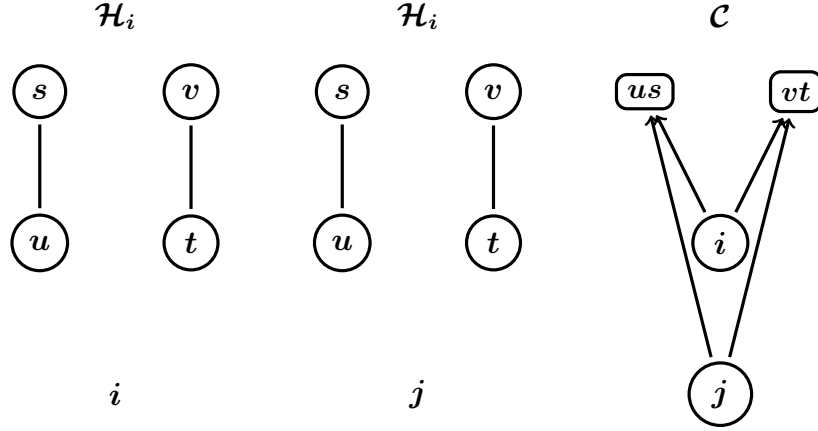

Figure 8: Association of ties in  $\mathcal{E}$  that are not necessarily structurally related

### 2.3.3 Alignment with criterion graph

The representation of  $\mathcal{H}_1, \dots, \mathcal{H}_n$  in terms of a multilevel network  $\mathcal{C}$  is already a representation of a *massively multiplex* network. This multiplex network may also be modelled jointly with the social network  $\mathcal{M}$ . In addition we may consider the alignment of  $\mathcal{H}_1, \dots, \mathcal{H}_n$  with a criterion graph  $\mathcal{G}$ . In the first instance we may consider basic entrainment of  $\mathcal{H}$  and  $\mathcal{G}$ . The simplest form of alignment may be translated as in Figure 12, where the grey node indicates that  $A_{uv} = 1$  for  $\pi(u, v) = p$  means that  $D_p = 1$ .

Other multiplex configurations may be expressed in terms of various combinations of ties in  $\mathcal{C}$  and attributes  $\mathbf{D}$ . If there is a tendency for  $i$  to directly connect  $u$  and  $v$  ( $u, v \in \mathcal{N}$ ) that are indirectly connected in  $\mathcal{G}$ , this is represented as a the triangle-edge configuration in Figure 13. If there is a tendency for  $i$  to indirectly connect  $u$  and  $v$  ( $u, v \in \mathcal{N}$ ) that are directly connected in  $\mathcal{G}$ , this is represented as a the multilevel four-cycle with a cord in Figure 14.

### 2.3.4 Connecting layers

In sociomaterial networks (Contractor et al., 2011), sociosemantic networks (Basov, 2020), and socioecological networks (Bodin et al., 2016), a social network amongst the nodes of  $V$  is connected to a network on  $\mathcal{N}$  through some form of two-mode ties in a multilevel network (Lazega et al., 2008). Some of these two-mode ties may lend themselves more readily to be represented as networks  $\mathcal{H}_i$ , such as for example consumer ( $V$ ) preferences amongst products ( $\mathcal{N}$ ), rather than a consumer by product, two-mode network (Wang et al., 2015). In the multilevel semantic

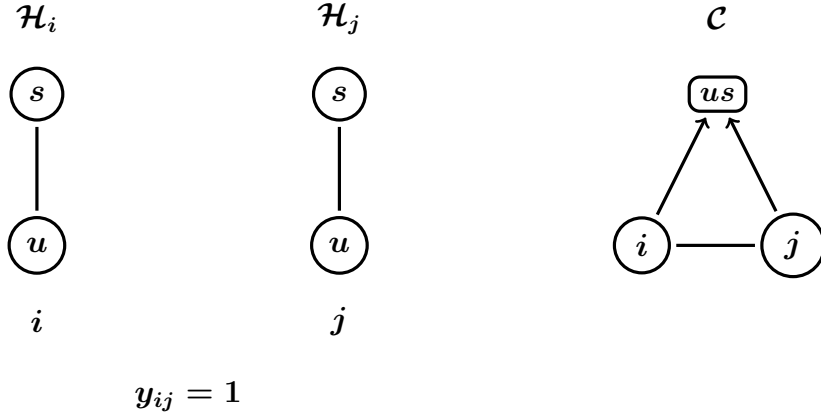

Figure 9: Alignment of ties of  $\mathcal{H}_i$  and  $\mathcal{H}_j$  for  $i$  and  $j$  with  $\{i, j\} \in \mathcal{M}$ , expressed as a multilevel network of networks

network of Basov (2020) people  $V$  are connected to concepts  $\mathcal{N}$  through usage of concepts. The network amongst  $\mathcal{N}$  is however aggregated from the individual semantic networks that are essentially  $\mathcal{H}_1, \dots, \mathcal{H}_n$ .

A two-mode  $V \times \mathcal{N}$  network may formally be included in  $\mathcal{C}$ . Denoting this  $\mathcal{B}_i$  for each  $i \in V$ , we may construct a network  $\mathcal{K}$  on  $V \times \mathcal{P}$ , where  $(i, p) \in \mathcal{K}$  if  $B_{i\pi^{-1}(p)} = 1$ . For each  $i \in V$ , the ties  $(i, p)$  in  $\mathcal{W}$  are a subset of the ties  $(i, p) \in \mathcal{K}$ .

### 2.3.5 Computational considerations

Having translated the original data  $\mathcal{H}$ ,  $\mathcal{G}$ , and  $\mathcal{M}$  to a multilevel network, the dependencies between the different types of ties lend themselves to investigation using for example multilevel ERGM (Peng et al., 2013), assuming that the criterion graph  $\mathcal{G}$  is fixed and treated as an explanatory network. If, as in CSS,  $\mathcal{G}$  is unobserved, the representation applies only either conditionally on an assumed criterion graph or in the absence of an assumed criterion graph. In principle,  $\mathcal{G}$  could be treated as a latent, unobserved attributes (e.g. Koskinen, 2009; Schweinberger, 2019) but this would most likely be practically infeasible.

For more general methods for analysing multilevel networks, Hollway, Lomi, Pallotti, and Stadtfeld (2017) redefine the multilevel networks as a blocked one-mode network with structural zeros preventing ties in layers of the network where some ties are not defined (this is further described in Snijders, 2019). If the aim of the analysis is not to model all types of ties but rather focus on one set of ties,

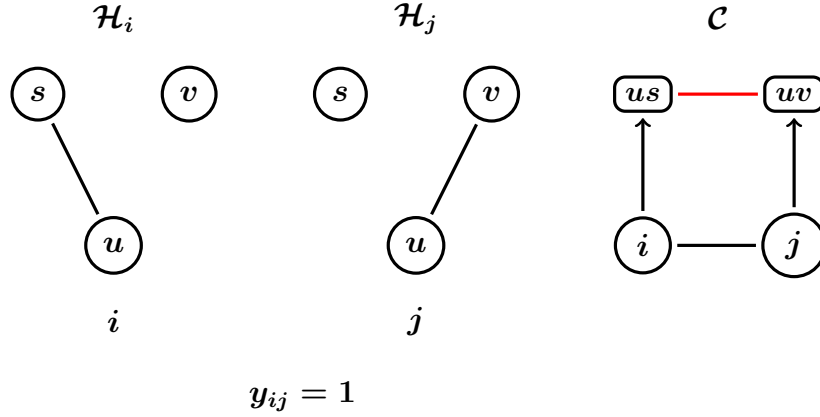

Figure 10: Complementarity of ties of  $\mathcal{H}_i$  and  $\mathcal{H}_j$  for  $i$  and  $j$  with  $\{i, j\} \in \mathcal{M}$ , expressed as a multilevel network of networks

using the others as predictors, multilevel configurations can be projected to dyadic covariates, for example for modelling a social network conditional on affiliations  $\mathcal{W}$  and top-level networks  $\mathcal{Q}$  (Stys et al., 2020).

Assuming that we are using the entirety of  $\mathcal{E}$ , the number  $e$  of ‘top-level’ nodes in the multilevel representation will be too large for the translations to be practically feasible for large  $N$ . Consider for example the size  $e$  for a CSS for a standard size network. Careful consideration therefore has to be given to what defines meaningful subsets of  $\mathcal{E}$ . The subset of  $\mathcal{E}$  used for the top-level does not have to be the induced set of possible relations on a subset of  $\mathcal{N}$ . We may allow for some nodes in  $\mathcal{N}$  to be represented in more pairs than others. We will show an example of this next, in our empirical illustration.

### 3 Illustration of social production of knowledge

#### 3.1 Data

Our data is obtained from a pilot study of a larger project (‘Creation of knowledge on ecological hazards in Russian and European local communities’) that aims at investigating how knowledge in local flood-prone communities conforms to knowledge of experts (i.e. flood management agencies and authorities). The set  $\mathcal{N}$  consists of concepts or *signs*, relevant for flood management.

The signs chosen by experts is a graph  $\mathcal{G}$  on nodes  $\mathcal{N} \subset \Omega$  with edge set

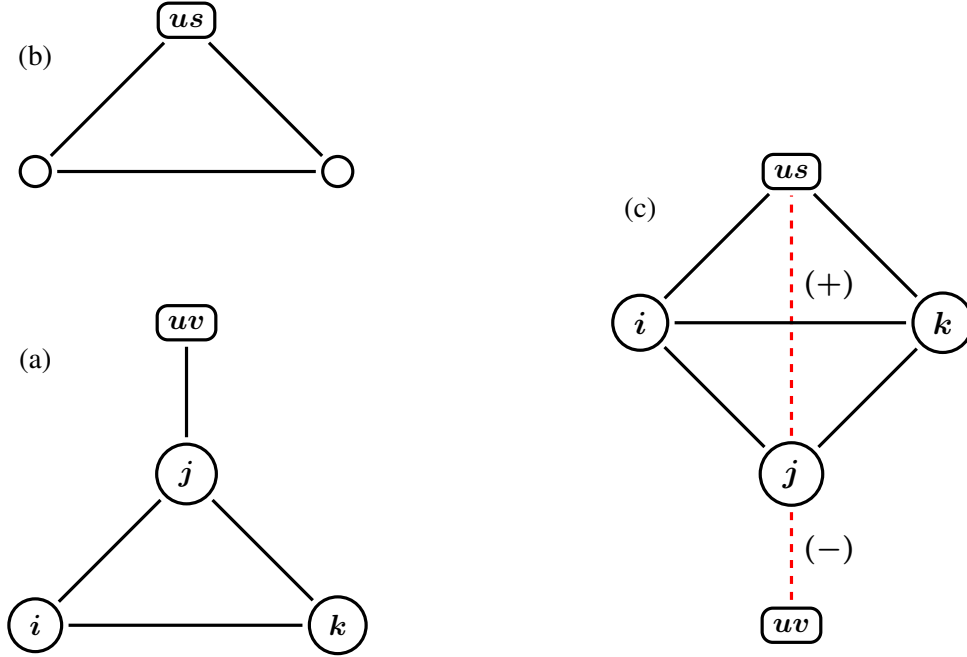

Figure 11: Capturing triadic pressure to conform. If there in addition to the pairwise conformity induced by (b) exists triadic pressure to confirm, we expect (a) to be rare as the combination of (a) and (b) induces extra-dyadic tendency for  $j$  to prefer  $us$  to  $uv$  in (c)

$E \subset \binom{\mathcal{N}}{2}$ . The signs  $\mathcal{N}$  thus constitute the expert vocabulary. We denote the adjacency matrix of  $\mathcal{G}$  by  $\mathbf{A}$ . Throughout we assume that  $\mathbf{A}$  is fixed, exogenous, and unchanging. In terms of elements

$$A_{ik} = \begin{cases} 1, & \text{if sign } i \text{ is connected to sign } k \\ 0, & \text{otherwise} \end{cases}$$

The expert semantic network has been constructed using ‘UDPipe’ (Wijffels et al., 2019) applied to expert texts - flood management-related documents issued by flood risk management agencies and authorities.

In the pilot, fieldwork in a site for local flood management has yielded the social network and the individual semantic networks for  $n = 15$  individuals - members of two local flood groups voluntarily involved in flood management. For each  $i \in V$ , the individual semantic structures (Basov and de Nooy, 2019) were constructed using the same software applied to transcripts of semi-structured interviews with the members, as

$$X_{ijk} = \begin{cases} 1, & \text{if } i \text{ nominates a tie between } j \text{ and } k \\ 0, & \text{if } i \text{ does not nominate a tie between } j \text{ and } k \end{cases}$$



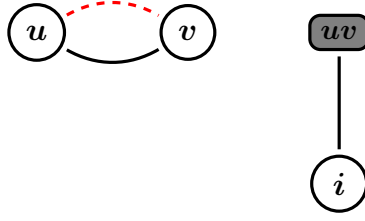

Figure 12: Mapping alignment of  $\mathcal{H}_i$  and  $\mathcal{G}$  to configurations in  $\mathcal{C}$

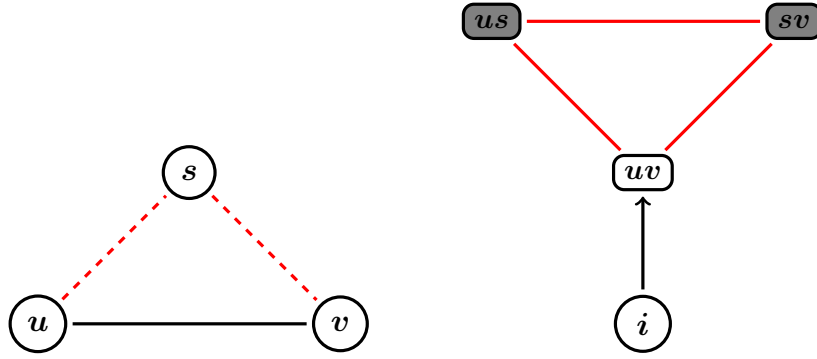

Figure 13: Mapping closure in  $\mathcal{H}_i$  of a two-path in  $\mathcal{G}$  to multilevel configuration in  $\mathcal{C}$

Here we focus the analysis on a subset of  $\mathcal{E}$  with  $e = 634$  motivated by previous work on multilevel socio-semantic networks where the individual semantic structures are aggregated into a local knowledge network wherein ties exist between concepts that are used together by at least two individuals (Basov, 2020). For the model, this means that we only model tie presence between pairs of concepts that are present in the (implicit) local knowledge network, and thus exclude from the analysis those pairs which are never used together in the local context. This vastly reduces the computational cost as the size of the top-level of the network is reduced from being in the region of tens of thousands to a manageable, and interpretable size. Furthermore,  $\mathcal{W}$  does not have any isolate  $\mathcal{P}$  nodes.

The social network is an undirected social network among the actors in  $V$  with the adjacency matrix  $\mathbf{Y}$  defined as having elements

$$Y_{ij} = \begin{cases} 1, & \text{if } i \text{ nominates } j \\ 0, & \text{otherwise} \end{cases}$$

The social network has been derived using visually verified sociometric surveys, triangulated with interview and observational data to guarantee high quality data (for details on the procedure, see Basov, 2020).

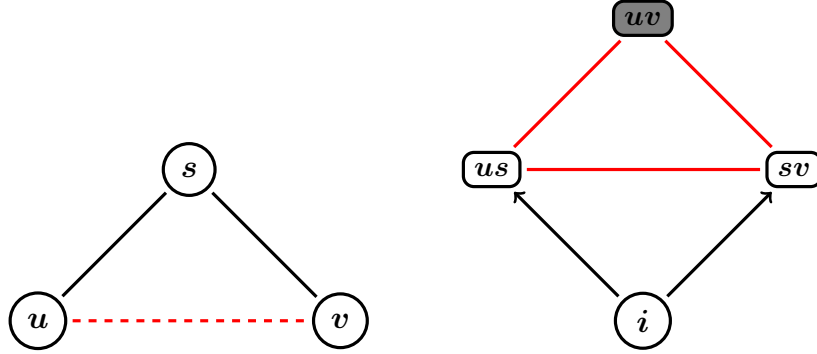

Figure 14: Mapping closure in  $\mathcal{G}$  of a two-path in  $\mathcal{H}_i$  to multilevel configuration in  $\mathcal{C}$

We will analyse the dataset using MPNet and will refer to the corresponding effect names in the description of the configurations we investigate (Wang et al., 2014).

### 3.2 Social construction of knowledge

In the first instance, in the flood management groups studied, we aim to investigate how the actors  $V$  negotiate meaning, irrespective of how flood management signs are related in the ‘normative’ expert network. Symbolic interactionist conception of social behaviour is based on the premise that people collectively construct knowledge about reality rather than passively reproduce images of the world imposed on them: “[h]uman group life on the level of symbolic interaction is a vast process in which people are forming, sustaining, and transforming the objects of their world as they come to give meaning to objects” (Blumer, 1986: 12; Mead, 1934). Interacting ( $\mathcal{M}$ ), individuals use signs and associations of signs ( $\mathcal{H}$ ) that refer to a context where their interaction unfolds and constitute knowledge about reality (Mead, 1934). The interaction context here is flood management in their communities. The act of knowledge creation can be thought of as three interrelated processes that lead to multilevel, social entrainment as in Figure 9 (TriangleXAC). Firstly, to indicate the meaning of an object/action actor A would use signs familiar to B and avoid using signs that are incomprehensible for the group that both A and B belong to (e.g. technical jargon). This entails two levels of entrainment, one is the entrainment in Figure 7 (XASB) and the more structural entrainment in Figure 8 (XACA), neither of which involves defining the interaction in terms of  $\mathcal{M}$ , rather using membership in the group  $V$  as the reference point. Secondly, in interaction between A and B meanings indicated by A are either confirmed or rejected by B. This constitutes the other level of entrainment

presented in Figure 9. The shared signs and meaningful associations between them constitute community knowledge. Thirdly, the confirmation of the indicated meanings by actor B becomes a stimulus for individual A to continue interaction. According to these three processes, actors can reproduce and transform local knowledge. Reproduction of knowledge involves actors restating already shared signs and associations between signs. Transformation involves reconfiguration of associations between signs as a result of interaction between actors. Knowledge reproduction and transformation are carried out through several mechanisms working at dyadic and extra-dyadic levels and summarised by Antonyuk et al (2019). The cross-sectional data, however, do not allow distinguishing between knowledge reproduction and transformation. Similarly, for the social ties, they may be created from various forms of social alignment or they may be reconfigured to reduce breach of social alignment. In what follows we offer examples of such mechanisms and their statistical representations.

### **3.2.1 Knowledge reproduction and transformation at dyadic level: Selection and contagion**

Knowledge reproduction can take place through the mechanism of ‘selection’. This mechanism can be observed in different contexts, for example, when people seek to establish reliable knowledge about an object or an event. In this situation, the identical elements in different indicated meanings are considered reliable, while the divergent parts are dismissed as subjective or inaccurate.

For example, discussing flood relief measures, A and B may disagree on what kind of help, e.g. money or material supplies, needs to be provided to the victims of a recent flood. At the same time, disagreeing on a particular type of aid throughout interaction, they at least agree that some help has to be provided to the victims (both A and B retain links between signs ‘provide’ and ‘victim’). Thus, by dismissing conflicting meanings (i.e. dismissing links ‘victim’ - ‘money’ and ‘victim’ - ‘material supplies’ previously used by A and B, respectively), the mechanism of selection helps reproduce the common ground necessary for collaboration between the actors.

Knowledge transformation can take place through the mechanism of ‘contagion’. Contagion occurs when one group member starts using an association between signs as a result of interacting with another group member using them (Burt 1987; Monge and Contractor 2003; Carley 1986; Coleman 1988). As a result, the association becomes shared and thus becomes part of local group’s knowledge. For example, if A introduces the idea of monitoring water levels at the local river to B, who is unfamiliar with this idea, B may adopt the association between existing signs ‘water-level’ - ‘monitoring’ from A, that as a result becomes part of group knowledge. Knowledge transformation may also happen

when there emerges a new problem not captured by previously existing group knowledge (e.g. flood water cannot be eliminated with a pump) requiring recombination of existing signs (Bolton 1981; Hollander & Gordon 2006; Etzrodt 2008). Reflecting on existing approaches to the problem, actor A can come up with an idea of a better flood protection device combining existing devices in a novel way (e.g., a physical barrier combined with a pump that automatically removes water). The new idea would reveal itself in a recombination of corresponding signs and emergence of a new association ‘barrier’ - ‘pump’. Actor B may support the new idea and adopt the association between signs ‘barrier’- ‘pump’. Structurally this will be represented as an unstable four-cycle in Figure 10. B may adopt the new association and dismiss the old one - between ‘water’ and ‘pump’ (the four-cycle) - in favour of the socially aligned Figure 9. This *recombination* would suggest a positive effect for TriangleXAC and a negative effect for C4AXB.

### 3.2.2 Knowledge reproduction and transformation at extra-dyadic level

At the extra-dyadic level, transformation of knowledge may occur through the mechanism of preferential attachment, when actors ‘frame’ an element of shared knowledge by adopting associations with signs that already have general, often emotionally charged meanings (Schultz et al., 2012; Snow et al., 1986), rather than with signs that denote more specific meanings. Signs used for ‘framing’ usually have many shared associations with other signs because of their generality or abstractness that allows them to enter many different contexts. For instance, actor A may argue that the group should adopt a prevention approach to ‘fluvial’ floods (that is, floods caused by excessive water in a river). The new association between existing signs used by A, e.g., ‘flood prevention’, invokes the ‘prevention’ frame that is known for actors in group  $V$  from other contexts like health or road safety. Therefore, the association ‘flood’- ‘prevention’ is likely to be adopted by another group member, B (and hence, become part of group knowledge), unlike a more specialized association ‘fluvial floods’ that does not involve any frame previously known to member B. A combination of configurations that is consistent with this preferential attachment is not to select isolated ties  $\{s, u\}$  (negative XASB), nor are ties  $\{s, u\}$  selected merely because there are many pairs with  $s$  (negative EXTB). A concept pair  $\{s, u\}$  if other ties of  $s$  are reported, captured through TriangleXBX (positive), and if many socially tied individuals chose the same  $\{s, u\}$  (positive TriangleXAX) not ties  $\{s, v\}$  that also include  $s$  (negative C4AXB).

In relational patterns involving three individuals, knowledge may be reproduced through the mechanism of triadic pressure. A triad embodies supra-individuality (Simmel, 1950: 257) and downplays individuality, diminishing the power of a single actor to determine the outcome of the whole interaction process. Relations in

triads are ‘less free, less independent, more constrained’ than in dyads (Krackhardt, 1999: 185). In addition, actors need ‘social affirmation or reinforcement from multiple sources [...] since contact with a single active neighbour is not enough to trigger adoption’ (Centola and Macy, 2007: 705; see also the elaborate different forms of exposure discussed in e.g. Strang and Tuma, 1993, and related work). Therefore, in triads, reproduction of existing shared knowledge is more efficient than in a dyad (Krackhardt, 1999): if in a triad two interacting individuals A and B share associations between signs e.g., ‘flood’ - ‘management’, the third individual C interacting with both is likely to start sharing these associations as well. This effect is over and above dyadic contagion, so that the propensity of the third individual to share a sign or an association is higher than if he or she was subjected to contagion by two alters who are not socially tied with each other. This triadic pressure translates into the process described in Figure 11)(c) as a positive effect for TriangleXAX (Figure 9) and a negative effect for EXTA Figure 11(a).

### 3.2.3 Entrainment with normative knowledge

The associations between signs in the local knowledge are affected not only by social relationships between actors but also by expert knowledge imposed on the flood management groups by authorities, that is the normative relations between signs indicated by  $\mathcal{G}$ . The influence of expert knowledge on local knowledge occurs through several mechanisms that reflect structural changes in  $\mathcal{Z}$  conditional on the structure of  $\mathcal{G}$ . Basov and Brennecke (2017) perform a multiplex analysis where an aggregate local knowledge network  $\mathcal{Z}$  is compared to the criterion graph  $\mathcal{G}$

There are a number of ways in which we can extend the multiplex dependencies of  $\mathcal{Z}$  on  $\mathcal{G}$ , to dependencies of  $\mathcal{H}$  on  $\mathcal{G}$ , and examine theoretically-derived mechanisms of expert knowledge influence on local knowledge, e.g. such as those that result in alignment in Figure 12 and the two forms of closure in Figure 13 and Figure 14. We include a basic entrainment corresponding to a mechanism we call ‘basic reproduction’. It occurs when a local group starts associating preexisting signs in the same way they are associated by the experts. For example, experts can talk about ‘rivers’ as sources of flood risks while locals may not associate ‘river’ with ‘risk’ at all. Locals may realise that the experts’ way of thinking about the river as a source of risks could be useful for them, e.g., to discuss the problem of flooding with authorities.

Hence, following the experts, they start associating ‘river’ and ‘risk’. The mechanism is modelled using the effect Expert XEdgeB corresponding to the configuration in Figure 12.

To control for the possibility that some concept pairs in  $\mathcal{G}$  may be salient only because they involve signs  $s$  that are part of many other concept pairs, we include

the interaction  $\sum_{i,p} W_{ip} D_p \sum_{r \neq p} Q_{pr}$  which is the statistic Expert Star2BX. This statistic corresponds to a mechanism we call ‘popularity pressure’ that describes a situation when a local group starts associating signs that are part of many other associations in the experts’ knowledge. For example, speaking about flood risk management, experts may pay significant attention to communities’ resilience to flood hazards and highlight the importance of creating flood plans to ensure all stakeholders are prepared for potential floods. Because a local group observes the signs ‘resilience’ and ‘plan’ as focal for experts, they also start associating these two signs when speaking about a local document they produce to be prepared for floods - a local group ‘resilience plan’.

### 3.3 Results

The results for two models are presented in Tables 1. For Model 1, the social network abides by standard social processes judging by the one-mode effects (Snijders et al., 2006; Lusher et al., 2013), with no heterogeneity in popularity (insignificant ASA) but with evidence for triadic closure (positive ATA or GWESP). The bipartite network is modelled using the three terms XEdge, XASA, and XACA. We will interpret these in relation to the multilevel statistics making up the rest of the table.

In terms of reproduction and transformation of knowledge, the effects go largely in the direction of the predictions. The positive TriangleXAC is consistent with basic contagion or selection. The positive effect, in Model1, for TriangleXAC and a negative effect for C4AXB is consistent with recombination of concept pairs.

The combination of negative EXTB, positive TriangleXAX, and negative C4AXB, is consistent with the framing operating through preferential attachment.

Amongst the other effects, XACA and TriangleXBX capture a general coherence of the local knowledge structure, connecting concept pairs that are not socially mediated. XEdge, Star2BX, StarAB1X take into account that not all signs are equally represented in  $\mathcal{E}$ . The statistics Star2BX, L3XBX, and L3AXB also act as lower-order interactions to C4AXB.

Introducing  $\mathcal{G}$ , we see that there is a significant alignment of the individual semantic networks and the expert network (Expert XEdge). We also see that the dependence on  $\mathcal{G}$  completely moderates the effect of C4AXB. This means that some of the recombination and preferential attachment is explained by how concept pairs are related in the expert network. Network-related contagion (TriangleXAX) and local knowledge structure (XACA) are however not affected by the reliance on the expert network.

The effect EXTA necessary for inferring triadic pressure is not estimable from this dataset and while the model predicts more configurations EXTA than ob-













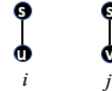

served (see GOF in Tables 2 and 3), this difference is not significant. In general, the goodness-of-fit is overall acceptable considering the complexity of the data. Some expert-related configurations in the goodness-of-fit suggest that there is scope for investigating more elaborate multiplex effects. Furthermore, in the goodness-of-fit there are higher-order interactions with  $\mathcal{Q}$  that could be investigated pursuant theorising in terms of  $\mathcal{H}$ ,  $\mathcal{M}$ , and  $\mathcal{G}$ . Some affiliation configurations are poorly fit by the simple model of Table 1, something which is to be expected for two-mode networks (Wang et al., 2009) and which will be alleviated by incorporating the expert network as a top-level covariate.

Table 1: MERGM results for local meaning structures, social network, and expert semantic network (social and bipartite effects)

Effects	Model 1		Model 2		Representation	
	Parameter	Stderr	Parameter	Stderr	Multilevel	NoNs
EdgeA	-0.748	2.019	2.052	3.245		
ASA	-0.861	0.516	-1.966	1.125		
ATA	<b>1.331</b>	0.48	<b>1.314</b>	0.482		
XEdge	-0.772	0.456	-0.457	0.473		
XASB	<b>-1.075</b>	0.27	<b>-1.298</b>	0.283		
XACA	<b>0.01</b>	0.001	<b>0.009</b>	0.001		
Expert XEdgeB			<b>0.568</b>	0.13		
Star2AX	-0.039	0.039	-0.062	0.042		
TriangleXAX	<b>0.354</b>	0.103	<b>0.352</b>	0.102		

Continued on next page

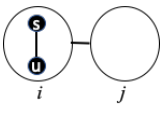
**Table 1 – continued from previous page**

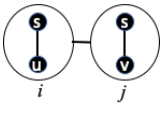
Effects	Model 1		Model 2		Representation	
	Parameter	Stderr	Parameter	Stderr	Multilevel	NoNs
Star2BX	-0.001	0.126	-0.064	0.135		
StarAB1X	0.058	0.064	0.081	0.07		
TriangleXBX	<b>0.065</b>	0.006	<b>0.065</b>	0.006		
L3XBX	-0.024	0.015	-0.027	0.015		
EXTB	<b>-0.001</b>	0.000	<b>-0.001</b>	0.000		
Expert Star2BX			0.001	0.001		
L3AXB	0.001	0.001	-0.008	0.005		
C4AXB	<b>-0.008</b>	0.004	0.017	0.014		

## 4 Summary

We have proposed a conceptual framework for joint analysis of multiple reports on a network, how these relate to a criterion graph, and how a network among reports induces dependencies. The approach rests on transforming the original data into a multilevel network (Lazega et al., 2008) representation. We have discussed the multilevel representation in terms of meaningful, multilevel network configurations that are amenable to empirical investigation using multilevel ERGM (Wang et al., 2013). The representation is however agnostic to the actual analysis method



and in the proposed format, networks of networks are amenable to investigation in any analysis framework for multilevel networks, such as stochastic actor-oriented models (Hollway et al., 2017) and blockmodels (Žibena and Lazega, 2016).

Our analysis of individual semantic structures amongst 15 actors in a local flood management groups provides evidence of a variety of mechanisms for socially constructed local knowledge. Some social mechanisms are moderated by the introduction of an external criterion network representing a semantic network of flood management experts. So, while local actors speak about their reality using their own, partially socially constructed, knowledge, this knowledge is not completely independent of the ‘objective’ knowledge of experts. There is further heterogeneity to explore. This may be addressed by developing more elaborate multiplex associations between the individual semantic networks and the expert network. We may also elaborate individual-level effects, for example using actor attributes. Socially dependent heterogeneity could also be explored. Here the configuration Star2AX captures the association between social popularity and number of concept pairs nominated, but it does not inform us whether people agree with central people. It is not straightforward to see whether a person who is central in the social network tends to be influential. Future research could study the dependence of the overall structure on particular actors, something that would require multilevel elaborations of outlier diagnostics (Koskinen et al., 2018).

The translation of data from the original domain into the multilevel representation is not dependent on the specific content of the network data and we have suggested how the approach might be applied in other contexts. Examples include sociosemantic networks (Basov, 2020), socioecological networks (Bodin et al., 2016), and sociomaterial networks (Contractor et al., 2011; Basov, 2018), all of which are explicitly multilevel. Other examples include data collection paradigms that assume repeated observations on networks such as multiplex networks and cognitive social structures. Yet another class would be networks that could be repeatedly observed for units (e.g. intersectional flows in different countries, Leoncini et al., 1996; and, symptom networks, Borsboom and Cramer, 2013) where work has already been done on analysing the networks of these units (social networks in psychiatry, Moreno, 1934; and, economic ties between countries, Squartini et al., 2011; Koskinen and Lomi, 2013). All of these different contexts present unique challenges in translating data from the original domain into the multilevel network of networks presented here, some of which we have discussed.

## References

Antonyuk, A., Puzyreva, K., & Basov, N. (2019). Principles and patterns of interplay between expert and local communities knowledge. Unpublished

Manuscript, St Petersburg University, 2019.

Barnes, M. L., Bodin, Ö., McClanahan, T. R., Kittinger, J. N., Hoey, A. S., Gaoue, O. G., & Graham, N. A. (2019). Social-ecological alignment and ecological conditions in coral reefs. *Nature communications*, 10(1), 1–10.

Basov, N. (2018). Socio-Material Network Analysis: A Mixed Method Study of Five European Artistic Collectives. *Social Networks*, 54, 179–195.

Basov, N. (2020) The Ambivalence of Cultural Homophily: Field Positions, Semantic Similarities, and Social Network Ties in Creative Collectives, *Poetics*. Vol. 78

Basov N. and J. Brennecke (2017). “Duality beyond Dyads: Multiplex patterning of social ties and cultural meanings” in “Structure, Content and Meaning of Organizational Networks: Extending Network Thinking” ed. by Peter Groenewegen, Julie E. Ferguson, Christine Moser, John W. Mohr, Stephen P. Borgatti. *Research in the sociology of organizations*. Vol. 53.

Basov, N., de Nooy, W., and Nenko, A. (2019) Local Meaning Structures: A Mixed-Method Socio-Semantic Network Analysis, *American Journal of Cultural Sociology*.

Basov, N., Lee, J-S., & Antoniuk, A. (2016). Social Networks and Construction of Culture: A Socio-Semantic Analysis of Art Groups. *Studies in computational intelligence*, 693, 785–796

Batchelder, W. H., & Romney, A. K. (1988). Test theory without an answer key. *Psychometrika*, 53(1), 71–92.

Batchelder, W., Kumbasar, E., and Boyd, J. (1997). Consensus analysis of three-way social network data. *Journal of Mathematical Sociology*, 22, 29–58.

Bodin, Ö., Robins, G., McAllister, R. R., Guerrero, A. M., Crona, B., Tengö, M., & Lubell, M. (2016). Theorizing benefits and constraints in collaborative environmental governance: a transdisciplinary social-ecological network approach for empirical investigations. *Ecology and Society*, 21(1).

Bodin, Ö., & Tengö, M. (2012). Disentangling intangible social–ecological systems. *Global Environmental Change*, 22(2), 430–439.

Bolton, C. D. (1981). Some consequences of the Meadian self. *Symbolic Interaction*, 4(2), 245–259.

- Borgatti, S.P., Everett, M.G. (1997). Network analysis of 2-mode data. *Social Networks* 19, 243–269.
- Borsboom, D., & Cramer, A. O. (2013). Network analysis: an integrative approach to the structure of psychopathology. *Annual review of clinical psychology*, 9, 91–121.
- Blumer, H. (1986). *Symbolic interactionism: Perspective and method*. Univ of California Press.
- Burt, R. (1987). Social Contagion and Innovation: Cohesion versus Structural Equivalence. *American Journal of Sociology* 92:1287–1335.
- Butts, C. T. (2003). Network inference, error, and informant (in)accuracy: a Bayesian approach. *Social Networks*, 25, 103–140.
- Carley, K. (1986). Knowledge acquisition as a social phenomenon. *Instructional Science* 14, 381-438.
- Cartwright, Dorwin, Harary, Frank, 1956. Structural Balance: A Generalization of Heider's Theory. *The Psychological Review* 63, 277–293.
- Centola, D., Macy M. (2007). Complex Contagions and the Weakness of Long Ties. *American Journal of Sociology*, 113:702–34.
- Coleman, J. S. (1988). Social capital in the creation of human capital. *American Journal of Sociology*, 94:95–120.
- Contractor, N., Monge, P., and Leonardi, P. M., (2011). Network Theory| Multidimensional Networks and the Dynamics of Sociomateriality: Bringing Technology inside the Network, *International Journal of Communication*, 5, p. 39
- Daraganova, G., Robins, G. (2013). Autologistic Actor Attribute Model. Pp. 102–114 In Lusher, D., Koskinen, J., Robins, G. (eds.) *Exponential Random Graph Models for Social Networks: Theory, Methods and Applications*, Cambridge University Press, New York.
- Davis, J.A., (1968). Statistical analysis of pair relationships: symmetry, subjective consistency and reciprocity. *Sociometry* 31 (1), 102–119.
- Etzrodt, C. (2008). The foundation of an interpretative sociology: A critical review of the attempts of George H. Mead and Alfred Schutz. *Human Studies*, 31(2), 157–177.

- Frank, O., Strauss, D. (1986). Markov Graphs. *Journal of the American Statistical Association*, 81, 832–842.
- Friedkin, N. E., Proskurnikov, A. V., Tempo, R., & Parsegov, S. E. (2016). Network science on belief system dynamics under logic constraints. *Science*, 354(6310), 321-326.
- Heider, F. (1958). *The psychology of interpersonal relations*. Lawrence Erlbaum.
- Hollander, J. A., & Gordon, H. R. (2006). The processes of social construction in talk. *Symbolic Interaction*, 29(2), 183–212.
- Hollway, James, Alessandro Lomi, Francesca Pallotti, and Christoph Stadtfeld. (2017). Multilevel Social Spaces: The Network Dynamics of Organizational Fields, *Network Science* 5:187–212.
- Kapferer B. (1972). *Strategy and transaction in an African factory*. Manchester: Manchester University Press.
- Kivelä, M., Arenas, A., Barthelemy, M., Gleeson, J.P., Moreno, Y., Porter, M.A.(2014). Multilayer networks. *Journal of Complex Networks* 2(3), 203–271.
- Kneser, M. (1955). Einige bemerkungen über das minkowskische flächenmass. *Archiv der Mathematik*, 6(5), 382–390.
- Koehly, L. M., and Pattison, P., (2005). Random graph models for social networks: Multiple relations or multiple raters. In: P. Carrington, J. Scott, and S. Wasserman (Eds.), *Models and Methods in Social Network Analysis*, Cambridge University Press, New York, NY, pp. 162–191.
- Koskinen, J. (2004). Model selection for Cognitive Social Structures, Research Report 2004:3, Department of Statistics, (Available from ([http://gauss.stat.su.se/site/pdfer/RR2004\\_3.pdf](http://gauss.stat.su.se/site/pdfer/RR2004_3.pdf))).
- Koskinen, J. (2009). Using latent variables to account for heterogeneity in exponential family random graph models. Pp. 845–849 in S.M. Ermakov, V.B. Melas & A.N. Pepelyshev (Eds.), *Proceedings of the 6th St. Petersburg Workshop on Simulation Vol II*.
- Koskinen, J., and Daraganova, G. (2020). Bayesian Analysis of Social Influence. <https://arxiv.org/abs/2006.16464>
- Koskinen, J. & Edling, C. (2012). Modelling the evolution of a bipartite network—Peer referral in interlocking directorates. *Social Networks*, Vol. 34 (3), 309–322.

- Koskinen, J., and Lomi, A. (2013). The Local Structure of Globalization: The Network Dynamics of Foreign Direct Investments in the International Electricity Industry. *Journal of Statistical Physics*. Vol. 151, (3), 523-548.
- Krackhardt, D. (1999). The Ties That Torture: Simmelian Tie Analysis In Organizations. *Research in the Sociology of Organizations*, 16:183–210.
- Lazega, E., & Pattison, P. E. (1999). Multiplexity, generalized exchange and cooperation in organizations: a case study. *Social networks*, 21(1), 67-90.
- Lazega, E., Jourda, M. T., Mounier, L., & Stofer, R. (2008). Catching up with big fish in the big pond? Multilevel network analysis through linked design. *Social Networks*, 30(2), 159–176.
- Leoncini, R., Maggioni, M. A., & Montresor, S. (1996). Intersectoral innovation flows and national technological systems: network analysis for comparing Italy and Germany. *Research Policy*, 25(3), 415–430.
- Lusher, D., Koskinen, J., and Robins, G.L. (2013), *Exponential Random Graph Models for Social Networks: Theory, Methods, and Applications*. Cambridge University Press, Cambridge, UK
- Maki, A., Carrico, A. R., Raimi, K. T., Truelove, H. B., Araujo, B., & Yeung, K. L. (2019). Meta-analysis of pro-environmental behaviour spillover. *Nature Sustainability*, 2(4), 307–315.
- Mead, G.H. (1934). *Mind, Self and Society*. Chicago: University of Chicago Press.
- Mitchell, J. C. (1974). Social networks. *Annual review of anthropology*, 3(1), 279–299.
- Monge, P.R., Contractor, N. (2003). *Theories of Communication Networks*. New York: Oxford University Press.
- Moreno, J. L. (1934). *Who shall survive?: A new approach to the problem of human interrelations*. Washington, DC, US: Nervous and Mental Disease Publishing Co.
- Moreno, J.L., Jennings, H.H., (1938). Statistics of social configurations. *Sociometry* 1, 342.
- Newcomb, T. (1961). *The Acquaintance Process*. New York: Holt, Rinehart and Winston.

- Padgett, J. F., & Ansell, C. K. (1993). Robust Action and the Rise of the Medici, 1400-1434. *American journal of sociology*, 98(6), 1259-1319.
- Pattison, P., (1993). *Algebraic Models for Social Networks*. Cambridge University Press.
- Rawlings, C. M., & Childress, C. (2019). Emergent Meanings: Reconciling Dispositional and Situational Accounts of Meaning-Making from Cultural Objects. *American Journal of Sociology*, 124(6), 1763–1809.
- Rivero Ostoic, J. (2020). Algebraic Analysis of Multiple Social Networks with multiplex. *Journal of Statistical Software*, 92(11), 1–41.
- Rivero Ostoic, J. (2017). Creating context for social influence processes in multiplex networks. *Network Science*, 5(1), 1–29.
- Robins, G.L., Alexander, M. (2004). Small worlds among interlocking directors: network structure and distance in bipartite graphs. *Journal of Computational and Mathematical Organization Theory*, 69–94.
- Romney, A. K., Weller, S. C., & Batchelder, W. H. (1986). Culture as consensus: A theory of culture and informant accuracy. *American anthropologist*, 88(2), 313–338.
- Roth, C., & Cointet, J.-P. (2010). Social and Semantic Coevolution in Knowledge Networks. *Social Networks*, 32, 16–29.
- Sampson, S. (1969). *Crisis in a cloister*. Unpublished doctoral dissertation, Cornell University.
- Schultz, F., Kleinnijenhuis, J., Oegema, D., Utz, S., & Van Atteveldt, W. (2012). Strategic framing in the BP crisis: A semantic network analysis of associative frames. *Public Relations Review*, 38(1), 97–107.
- Schweinberger, M. (2019). Statistical inference for continuous-time Markov processes with block structure based on discrete-time network data. *Statistica Neerlandica*.
- Shafie, T. (2015). A Multigraph Approach to Social Network Analysis. *Journal of Social Structure*, 16.
- Simmel, G. (1950). *The Sociology of Georg Simmel*. Trans. by K. H. Wolff. Glencoe, IL: Free Press.

- Snijders, T.A.B. (2019). Longitudinal Analysis of Multilevel Networks, Teaching material from workshop, ARS 2019, October 2019, Salerno. Available from `stats.ok.ac.uk` as `MultilevelNet_2019_s.pdf`
- Snijders, T.A.B., Pattison, P.E., Robins, G.L., Handcock, M.S. (2006). New specifications for exponential random graph models. *Sociological Methodology* 36, 99–153.
- Snow, D. A., Rochford Jr, E. B., Worden, S. K., & Benford, R. D. (1986). Frame alignment processes, micromobilization, and movement participation. *American Sociological Review*, 464–481
- Squartini, T., Fagiolo, G., Garlaschelli, D. (2011). Randomizing world trade. I. A binary network analysis. *Phys. Rev. E* 84, 046117
- Strang, D. and N. B. Tuma (1993). Spatial and temporal heterogeneity in diffusion. *American Journal of Sociology*, 99(3), 614–639.
- Stys, P., Verweijen, J., Muzuri, P., Muhindo, S., Vogel, C., and Koskinen, J. (2020) Brokering Between (not so) Overt and (not so) Covert Networks in Conflict Zones, *Global Crime* 21(1): 74–110.
- Vörös, A., & Snijders, T. A. (2017). Cluster analysis of multiplex networks: Defining composite network measures. *Social Networks*, 49, 93–112.
- Wang, M., Chen, W., Huang, Y., Contractor, N. S., and Fu, Y., (2015), A Multidimensional Network Approach for Modeling Customer-Product Relations in Engineering Design, *ASME 2015 International Design Engineering Technical Conferences & Computers and Information in Engineering Conference*, Boston, MA.
- Wang, P., Robins, G.L., Pattison, P.E., Lazega, E. (2013). Exponential random graph models for multilevel networks. *Social Networks*, 35: 96–115.
- Wang, P., Sharpe, K., Robins, G. L., & Pattison, P. E. (2009). Exponential random graph ( $p^*$ ) models for affiliation networks. *Social Networks*, 31, 12–25.
- Wang, Robins, Pattison, Koskinen (2014). MPNet, Program for the Simulation and Estimation of ( $p^*$ ) Exponential Random Graph Models for Multilevel Networks: USER MANUAL. Melbourne School of Psychological Sciences The University of Melbourne Australia (available online at [http://sna.unimelb.edu.au/\\_data/assets/pdf\\_file/0004/1185745/MPNetManual.pdf](http://sna.unimelb.edu.au/_data/assets/pdf_file/0004/1185745/MPNetManual.pdf))

Wasserman, S., Faust, K. (1994). *Social Network Analysis: Methods and Applications*. Cambridge University Press.

White, H., (1963). *An Anatomy of Kinship: Mathematical Models for Structures of Cumulated Roles*. Englewood Cliffs, NJ: Prentice-Hall.

White, H.C., Boorman, S.A., Breiger, R.L. (1976). Social Structure from Multiple Networks. I. Blockmodels of Roles and Positions. *The American Journal of Sociology* 81(4), 730–780 (1976)

Wijffels, J., Straka, M., and Straková, J. (2019). Tokenization, Parts of Speech Tagging, Lemmatization and Dependency Parsing with the ‘UDPipe’ ‘NLP’ Toolkit. Version 0.8.3

Žiberna, A., & Lazega, E. (2016). Role sets and division of work at two levels of collective agency: The case of blockmodeling a multilevel (inter-individual and inter-organizational) network. In *Multilevel Network Analysis for the Social Sciences* (pp. 173–209). Springer, Cham.

## **A Goodness of fit**



Table 2: Goodness-of-fit for Model 1

Statistics	Observed	Mean	StdDev	t-ratio
EdgeA	14	15.119	4.352	-0.257
Star2A	27	32.059	21.424	-0.236
Star3A	17	23.294	30.204	-0.208
Star4A	6	13.501	33.548	-0.224
Star5A	1	6.919	31.578	-0.187
TriangleA	5	5.551	3.947	-0.14
Cycle4A	5	5.299	7.802	-0.038
IsolatesA	2	2.366	1.574	-0.233
IsolateEdgesA	1	0.764	0.87	0.271
ASA	19.875	23.0891	12.139	-0.265
ATA	11.25	13.4626	7.878	-0.281
A2PA	22.25	27.26	15.835	-0.316
AETA	20	19.893	19.989	0.005
XEdge	934	937.467	17.057	-0.203
XStar2A	34071	33956.201	2422.932	0.047
XStar2B	1361	1188.361	50.438	3.423
XStar3A	897090	1013834.002	224473.748	-0.52
XStar3B	1821	905.179	81.721	11.207
X3Path	194167	169720.898	12961.535	1.886
X4Cycle	11894	8735.213	1028.4	3.072
XECA	1814656	1463003.616	316605.014	1.111
XECB	89002	38742.874	5298.652	9.485
XASA	1808.0156	1814.934	34.114	-0.203
XASB	830.2759	835.8853	27.296	-0.206
XACA	29078.7461	29889.6492	1990.761	-0.407
XACB	195.2369	206.8379	1.395	-8.318
XAECA	47575.4062	34940.852	4113.602	3.071
XAECB	34082.3115	23951.0315	2965.459	3.416
Star2AX	1742	1910.544	575.855	-0.293
StarAA1X	1302.625	1469.0705	805.719	-0.207
StarAX1A	3372.0156	3700.136	1118.421	-0.293
StarAXAA	1864.0078	1875.41	40.86	-0.279
TriangleXAX	185	205.084	66.178	-0.303
L3XAX	51989	59569.904	19784.367	-0.383
ATXAX	27.5154	30.077	8.665	-0.296
EXTA	935	1065.106	785.434	-0.166
Star2BX	24924	25017.347	460.361	-0.203
StarAB1X	46413.8962	46587.6369	875.177	-0.199
StarAX1B	25128.7515	24606.9828	801.756	0.651
StarAXAB	15412.29	15423.0444	33.081	-0.325
TriangleXBX	3740	3875.745	318.218	-0.427
L3XBX	42069	42389.237	1577.281	-0.203
ATXBX	2899.0625	3209.6011	241.658	-1.285
EXTB	438305	440039.401	9601.51	-0.181
L3AXB	45980	50570.331	15295.115	-0.3
C4AXB	4900	5455.271	1852.387	-0.3
ASAXASB	47716.5212	48056.7074	1231.73	-0.276
AC4AXB	6372.4708	6902.4475	148.779	-3.562
stddev degreeA	1.4573	1.3706	0.382	0.227
skew degreeA	0.6445	0.2692	0.417	0.901
clusteringA	0.5556	0.5144	0.156	0.264
stddev degreeX A	70.2424	70.0838	2.472	0.064
skew degreeX A	-1.103	-0.9459	0.044	-3.588
stddev degreeX B	3.4014	3.238	0.057	2.875
skew degreeX B	-0.9758	-1.1618	0.01	18.911
clusteringX	0.245	0.2053	0.009	4.227
stddev degreeB	20.9149	20.9149	0	-1
skew degreeB	0.7521	0.7521	0	-1
clusteringB	0.8341	0.8341	0	1

Table 3: Goodness-of-fit for Model 2

Statistics	Observed	Mean	StdDev	t-ratio
EdgeA	14	15.552	4.926	-0.315
Star2A	27	34.914	27.413	-0.289
Star3A	17	31.167	50.992	-0.278
Star4A	6	28.788	91.743	-0.248
Star5A	1	28.722	151.577	-0.183
TriangleA	5	5.594	4.37	-0.136
Cycle4A	5	5.46	8.827	-0.052
IsolatesA	2	2.183	1.45	-0.126
IsolateEdgesA	1	0.719	0.868	0.324
ASA	19.875	24.1388	14.163	-0.301
ASA2	19.875	24.1388	14.163	-0.301
ATA	11.25	13.6882	8.792	-0.277
A2PA	22.25	29.9897	20.809	-0.372
AETA	20	20.1698	22.405	-0.008
XEdge	934	937.624	16.823	-0.215
XStar2A	34071	33432.353	2609.927	0.245
XStar2B	1361	1194.897	50.717	3.275
XStar3A	897090	962121.188	234759.128	-0.277
XStar3B	1821	929.591	86.868	10.262
X3Path	194167	168319.628	14393.637	1.796
X4Cycle	11894	8630.116	1170.167	2.789
XECA	1814656	1410244.755	353314.367	1.145
XECB	89002	39200.372	6229.365	7.995
IsolatesXA	0	0	0	NaN
IsolatesXB	0	0	0	NaN
XASA	1808.0156	1815.248	33.646	-0.215
XASB	830.2759	836.58	26.974	-0.234
XACA	29078.7461	29424.9486	2115.042	-0.164
XACB	195.2369	207.2175	1.278	-9.375
XAECA	47575.4062	34520.464	4680.669	2.789
XAEGB	34082.3115	23788.9969	3385.866	3.04
Expert XEdgeA	0	0	0	NaN
Expert XEdgeB	359	361.437	10.688	-0.228
Expert X2StarA010	0	0	0	NaN
Expert X2StarB010	709	560.37	38.883	3.822
Expert X2StarA100	0	0	0	NaN
Expert X2StarB100	21247	21035.368	1660.846	0.127
Expert X2StarA101	0	0	0	NaN
Expert X2StarB101	5084	5115.007	463.06	-0.067
Expert X4CycleA1	0	0	0	NaN
Expert X4CycleB1	8943	6275.175	876.511	3.044
Expert X4CycleA2	0	0	0	NaN
Expert X4CycleB2	2997	1988.218	337.739	2.987
Expert XAlt4CycleA1	0	0	0	NaN
Expert XAlt4CycleB1	21543.7305	22368.1028	1605.882	-0.513
Expert XAlt4CycleA2	0	0	0	NaN
Expert XAlt4CycleB2	3948.6875	4220.5817	329.981	-0.824
Expert XEdgeAB	0	0	0	NaN
Star2AX	1742	1999.047	826.083	-0.311
StarAA1X	1302.625	1666.4692	1244.166	-0.292
StarAX1A	3372.0156	3873.678	1614.366	-0.311
StarAXAA	1864.0078	1877.456	42.567	-0.316
TriangleXAX	185	217.22	104.594	-0.308
L3XAX	51989	63034.626	31728.236	-0.348
ATXAX	27.5154	30.9576	9.829	-0.35
EXTA	935	1144.756	1065.915	-0.197
Star2BX	24924	25079.4	426.565	-0.364
StarAB1X	46413.8962	46709.5707	810.195	-0.365
StarAX1B	25128.7515	24736.3993	751.933	0.522
StarAXAB	15412.29	15423.3979	32.453	-0.342
TriangleXBX	3740	3814.606	353.514	-0.211
L3XBX	42069	42598.521	1462.718	-0.362
ATXBX	2899.0625	3153.7942	265.147	-0.961
EXTB	438305	441502.275	8880.053	-0.36
Expert Star2BX	45980	53366.561	23225.159	-0.318
L3AXB	4900	5874.284	3164.443	-0.308
C4AXB	47716.5212	48376.0399	1509.633	-0.437
stddev degreeA	1.4573	1.3937	0.445	0.143
skew degreeA	0.6445	0.3555	0.538	0.537
clusteringA	0.5556	0.4813	0.15	0.494
stddev degreeX A	70.2424	69.5409	2.663	0.263
skew degreeX A	-1.103	-0.9516	0.04	-3.787
stddev degreeX B	3.4014	3.2445	0.057	2.761
skew degreeX B	-0.9758	-1.1588	0.011	17.01
clusteringX	0.245	0.2043	0.011	3.77
stddev degreeB	20.9149	20.9149	0	-1
skew degreeB	0.7521	0.7521	0	-1
clusteringB	0.8341	0.8341	0	1