

# USp(4)-models

Mboyo Esole<sup>♣</sup> and Patrick Jefferson<sup>◇</sup>

♣ Department of Mathematics, Northeastern University  
Boston, MA 02115, USA

◇ Center for Theoretical Physics, Department of Physics,  
Massachusetts Institute of Technology  
Cambridge, MA 02139, U.S.A

## Abstract:

We study the geometry of elliptic fibrations satisfying the conditions of Step 2 of Tate's algorithm with a discriminant of valuation 4. We call such geometries USp(4)-models, as the dual graph of their special fiber is the twisted affine Dynkin diagram  $\tilde{C}_2^t$ . These geometries are used in string theory to model gauge theories with the non-simply-laced Lie group USp(4) on a smooth divisor  $S$  of the base. Starting with a singular Weierstrass model of a USp(4)-model, we present a crepant resolution of its singularities. We study the fiber structure of this smooth elliptic fibration and identify the fibral divisors up to isomorphism as schemes over  $S$ . These are  $\mathbb{P}^1$ -bundles over  $S$  or double covers of  $\mathbb{P}^1$ -bundles over  $S$ . We compute basic topological invariants such as the triple intersections of the fibral divisors and the Euler characteristic of the USp(4)-model. In the case of Calabi-Yau threefolds, we also compute the Hodge numbers. We study the compactifications of M/F theory on a USp(4)-model Calabi-Yau threefold.

Tuesday 22<sup>nd</sup> October, 2019

Keywords: Anomaly cancellations, Five and Six-dimensional minimal supergravity theories, Elliptic fibrations, Crepant morphism, Resolution of singularities, Weierstrass models.

# Contents

<b>1</b>	<b>Introduction</b>	<b>2</b>
1.1	Definition . . . . .	4
1.2	Matter representations . . . . .	5
1.3	Counting charged hypermultiplets in 5D and 6D . . . . .	5
<b>2</b>	<b>Weierstrass model, crepant resolutions, and fiber degenerations</b>	<b>6</b>
2.1	Weierstrass model . . . . .	6
2.2	Crepant resolution . . . . .	9
2.3	Fiber degenerations and the geometry of the fibral divisors . . . . .	9
<b>3</b>	<b>Intersection numbers, topological and characteristic invariants</b>	<b>10</b>
3.1	Representations from intersection numbers . . . . .	11
3.2	Euler characteristic and Hodge numbers . . . . .	12
3.3	Triple intersection numbers . . . . .	14
<b>4</b>	<b>Compactifications of M-theory to 5D on a <math>\mathrm{USp}(4)</math>-model</b>	<b>15</b>
4.1	5D prepotential and counting charged hypermultiplets . . . . .	16
<b>5</b>	<b>F-theory on a Calabi-Yau threefold and anomaly cancellation</b>	<b>16</b>
5.1	Generalized Green-Schwarz mechanism in F-theory . . . . .	16
5.2	Anomaly cancellation for $\mathrm{USp}(2n)$ with matter in the adjoint, fundamental, and traceless antisymmetric representation . . . . .	18
5.3	Geometry of representation multiplicities . . . . .	19
5.4	An heterotic sanity check . . . . .	20
5.5	Frozen representations . . . . .	21
<b>6</b>	<b>Katz–Vafa method and <math>\mathrm{USp}(4)</math>-models</b>	<b>21</b>
6.1	Branching rules . . . . .	22
6.2	Branching rules in F-theory . . . . .	22
6.3	$\mathrm{USp}(4)$ -models as kryptonite for the Katz–Vafa method . . . . .	23
6.4	$\mathrm{SO}(5)$ -model . . . . .	24
6.5	General $\mathrm{USp}(2n)$ -model . . . . .	24
<b>A</b>	<b>Weierstrass models and Deligne’s formulaire</b>	<b>27</b>
<b>B</b>	<b>Representations of <math>\mathrm{USp}(2n)</math></b>	<b>28</b>

# 1 Introduction

In the heart of F-theory is an algorithm that assigns to a given elliptic fibration a reductive Lie group  $G$  and a representation  $\mathbf{R}$  of  $G$  [8, 40, 48, 49, 58]. An elliptic fibration associated to a group  $G$  via the F-theory algorithm is called a  $G$ -model [18, 21].  $G$ -models provide a beautiful bridge between the geometry of elliptic fibrations and aspects of gauge theories. The Lie algebra  $\mathfrak{g}$  of the group  $G$  is determined by the types of singular fibers over each irreducible component of discriminant locus of the elliptic fibration. The representation  $\mathbf{R}$  is encoded in the structure of singular fibers over codimension-two points of the base corresponding to intersections of the components of the discriminant locus or other singularities of the discriminant locus [4, 18, 39, 45, 46]. Furthermore, the global structure of the group  $G$  depends on the Lie algebra  $\mathfrak{g}$  and the Mordell–Weil group of the elliptic fibration [22, 29].

The study of  $G$ -models in F-theory is a beautiful playground for both mathematicians and physicists that has evolved tremendously in the last few years [3, 16, 17, 21, 25, 26, 38, 47]. For example, a better understanding of  $G$ -models and the flops connecting them has emerged from the construction of explicit crepant resolutions of Weierstrass models and studies of the relative extended Kähler cone over Weierstrass models [18, 19, 23, 27, 30, 33, 36]. Additionally, the introduction of modern intersection theory techniques as a method to compute topological invariants and characteristic numbers of  $G$ -models has turned conjectures into theorems and replaced painful archaic computational methods with elegant algebraic techniques that not only apply to Calabi–Yau threefolds and fourfolds, but also provide results that apply to the broader setting of elliptic  $n$ -folds that are not necessarily Calabi–Yau [1, 2, 21, 25, 26].

Despite this progress, there are still many open questions to address regarding the geometry of  $G$ -models.  $G$ -models of small rank have been studied in detail with the exception of one that has fallen between the cracks of recent investigations, namely the  $\mathrm{USp}(4)$ -model, which will be the focus of this paper. Specifically, the  $G$ -models corresponding to  $\mathrm{Spin}(n)$  groups up to  $n = 8$  and all the semi-simple compact Lie groups of rank up to three (with the exception of  $\mathrm{USp}(4)$ ) have been studied in great detail (we recall that  $\mathrm{USp}(4)$  is isomorphic to  $\mathrm{Spin}(5)$  and has rank two<sup>1</sup>.)  $\mathrm{Spin}(8)$ ,  $G_2$ , and  $\mathrm{Spin}(7)$ -models are studied in [18],  $\mathrm{Spin}(6) \cong \mathrm{SU}(4)$ ,  $\mathrm{Spin}(3) \cong \mathrm{SU}(2)$ , and  $\mathrm{SU}(3)$  are studied in [33, 34], and a  $\mathrm{SU}(2) \times \mathrm{U}(1)$ -model is studied in [31]. The  $\mathrm{Spin}(4) \cong \mathrm{SU}(2) \times \mathrm{SU}(2)$  model is the only  $\mathrm{Spin}$ -model for which  $G$  is not simple but properly semi-simple; this model corresponds to a collision of two Kodaira fibers with dual graphs of type  $\tilde{A}_1$  and is studied in [28]. The  $\mathrm{SO}(3)$ ,  $\mathrm{SO}(5)$ , and  $\mathrm{SO}(6)$ -models are studied in [20]. The  $E_7$ -model is studied in [30], the  $\mathrm{SU}(5)$ -model in [35, 36], the  $\mathrm{SU}(2) \times \mathrm{SU}(3)$ -model in [19], the  $\mathrm{SU}(2) \times G_2$ -model in [27].

The  $\mathrm{USp}(4)$ -model has a long history dating back to the early days of F-theory as it was in-

---

<sup>1</sup>Spin groups of rank up to three are characterized by the following accidental isomorphisms:

$$\mathrm{Spin}(3) \cong \mathrm{SU}(2), \quad \mathrm{Spin}(4) \cong \mathrm{SU}(2) \times \mathrm{SU}(2), \quad \mathrm{Spin}(5) \cong \mathrm{USp}(4), \quad \mathrm{Spin}(6) \cong \mathrm{SU}(4).$$

There are only four semi-simple compact Lie groups of rank two, namely

$$\mathrm{Spin}(4) \cong \mathrm{SU}(2) \times \mathrm{SU}(2), \quad \mathrm{SU}(3), \quad \mathrm{Spin}(5) \cong \mathrm{USp}(4), \quad G_2.$$

The simply connected collisions of rank up to three are:

$$\mathrm{SU}(2) \times \mathrm{SU}(2), \quad \mathrm{SU}(2) \times \mathrm{SU}(3), \quad \mathrm{SU}(2) \times \mathrm{USp}(4), \quad \mathrm{SU}(2) \times G_2.$$

The group  $\mathrm{USp}(4)$  contains  $\mathrm{Spin}(4)$  as a maximal subgroup and thus also  $\mathrm{SU}(2) \times \mathrm{U}(1)$ :

$$\mathrm{SU}(2) \times \mathrm{U}(1) \subset \mathrm{SU}(2) \times \mathrm{SU}(2) \subset \mathrm{USp}(4).$$

strumental in identifying that the  $G$ -models corresponding to elliptic fibrations with a fiber of type  $I_{2n}^{\text{ns}}$  or  $I_{2n+1}^{\text{ns}}$  over the generic point of their discriminant locus were  $\text{USp}(2n)$ -models [5]. Note that a decorated Kodaira fiber of type  $I_{2n}^{\text{ns}}$  or  $I_{2n+1}^{\text{ns}}$  in both cases has a dual graph of type  $\tilde{C}_n^t$ ; however, the geometric fibers of these two cases differ—respectively, the geometric fibers are of type  $\tilde{A}_{2n-1}$  and  $\tilde{A}_{2n}$ . Since fibers of type  $I_{2n+1}^{\text{ns}}$  have  $\mathbb{Q}$ -factorial terminal singularities, in this paper we define a  $\text{USp}(4)$ -model by means of a type  $I_4^{\text{ns}}$  fiber.

Carefully studying the geometry of the  $\text{USp}(4)$ -model is a rewarding exercise as the  $\text{USp}(4)$ -model illustrates many of the subtleties of  $G$ -models while keeping the algebraic technicality at a minimum. In particular, the  $\text{USp}(4)$ -model exhibits the following features:

1. **Absence of flops.** The generic  $\text{USp}(4)$ -model does not have any flops over the Weierstrass model [16] as it is also the case for the  $G_2$ -model [18], the  $F_4$ -model [23], and the generic  $\text{USp}(2n)$ -model [16]. A smooth  $\text{USp}(4)$ -model can be obtained by a crepant resolution of a singular Weierstrass model by using just two blowups with smooth centers. It follows that the geometry of the  $\text{USp}(4)$ -model is particularly easy to study.
2. **Non-split fibers without terminal  $\mathbb{Q}$ -factorial singularities.**  $G$ -models with fibers of type  $I_{2n+1}^{\text{ns}}$  are known to have  $\mathbb{Q}$ -factorial terminal singularities. The  $\text{USp}(4)$ -model with a fiber of type  $I_4^{\text{ns}}$  is free of such problems and can therefore be defined as a flat fibration obtained by a crepant resolution of a singular Weierstrass model.
3. **Pseudo-real representations and half-hypermultiplets.** The fundamental representation of  $\text{USp}(2n)$  is pseudo-real and can be carried by half-hypermultiplets. Other models with pseudo-real representations are the  $E_7$ -models with matter in the representation **56** [30, 38] and  $\text{Spin}(n)$ -models for  $n = 3, 4, 5 \pmod{8}$  with matter in irreducible symplectic Majorana spinor representations.<sup>2</sup>  
We recall that  $\text{SU}(2)$  is isomorphic to  $\text{USp}(2)$  so that the fundamental representation of  $\text{SU}(2)$  is a pseudo-real representation as a particular case of the fundamental representation of  $\text{USp}(2n)$ .
4. **The simplest counter-example to the Katz–Vafa method.** The  $\text{USp}(4)$ -model is one of the simplest examples of a  $G$ -model for which the Katz–Vafa method [43] fails to correctly predict the matter representation associated to a  $G$ -model in F-theory. Other examples are the  $\text{Spin}(7)$ -model and the  $\text{SU}(2) \times G_2$ -model [27]. For more example, see [24].
5. **Counter-example to intersecting brane counting of matter multiplets in F-theory.** The  $\text{USp}(4)$ -model is an example of a  $G$ -model for which the counting of charged hypermultiplets does not follow the typical intersecting brane picture. In intersecting brane models, the number of charged matter at the intersection of two branes is given by the intersection number of the two branes.
6. **Frozen representations.** As a direct consequence of the previous point, we can have frozen representations [18, 23]: absence of hypermultiplets charged under a given representation while there are rational curves along the fiber that carry the weights of a representation for which there are no hypermultiplets charged.

They are other interesting questions that are not addressed here, such as the weak coupling limit of the theory and its tadpole cancellations [11, 15, 32].

---

<sup>2</sup>Symplectic Majorana spinors in Euclidean signature exist in dimension  $3, 4, 5 \pmod{8}$ ; in dimension  $4 \pmod{8}$ , a symplectic Majorana spinor is not irreducible as it can be decomposed into two irreducible symplectic Majorana–Weyl spinors [60, Table 2].

## 1.1 Definition

A  $\mathrm{USp}(2n)$ -model can be defined using a fiber of either type  $I_{2n}^{\mathrm{ns}}$  or  $I_{2n+1}^{\mathrm{ns}}$  as they both have the affine Dynkin diagram of type  $\widetilde{C}_n^t$  as a dual graph. However, since we care about the existence of a crepant resolution it is safer to consider only the  $I_{2n}^{\mathrm{ns}}$  case as models with  $I_{2n+1}^{\mathrm{ns}}$  fibers generically suffer from  $\mathbb{Q}$ -factorial terminal singularities, which are lethal for the existence of a crepant resolution. In this spirit, we use the following restricted definition.

**Definition 1.1.** A  $\mathrm{USp}(2n)$ -model is an elliptic fibration over a base  $B$  with a choice of a divisor  $S$  that is an irreducible component of the discriminant locus such that

1. The fiber over the generic point of  $S$  is of type  $I_{2n}^{\mathrm{ns}}$ .
2. The fiber over the generic point of any other components of the discriminant locus is of Kodaira type  $I_1$  or  $II$ .

A complete analysis of the Weierstrass model of a  $\mathrm{USp}(2n)$ -model should take into account the different options for the valuations of the coefficients of the Weierstrass equations:

$$a_1 = a_3 = 0, \quad \nu(a_2) = 0, \quad \nu(a_4) \geq n, \quad \nu(a_6) \geq 2n, \quad \nu(\Delta) = 2n. \quad (1.1)$$

One could think of such data as describing different types of complex structures for the elliptic fibration and their relevance can be appreciated by observing that they affect the fiber structure of the elliptic fibration in the manner summarized in Figures 2, 4, and 3. The fiber of type  $I_n^{\mathrm{ns}}$  is defined by Step 2 of Tate's algorithm, which characterizes fibers with multiplicative reduction. We use the original Tate's algorithm and not one of the tables usually presented in the F-theory literature as they miss several important subtleties. We define the  $\mathrm{USp}(4)$ -model by means of the following Weierstrass model<sup>3</sup>:

$$\mathcal{E}_0 : zy^2 - (x^3 + a_2x^2z + a_{4,2+\alpha}s^{2+\alpha}xz^2 + a_{6,4+\beta}s^{4+\beta}z^3) = 0, \quad \alpha\beta = 0, \quad \alpha, \beta \in \mathbb{Z}_{\geq 0}, \quad (1.2)$$

where we assume that the coefficients  $a_2$ ,  $a_{4,2+\alpha}$ ,  $a_{6,4+\beta}$  are generic. The condition  $\alpha\beta = 0$  is necessary for the valuation of the discriminant to be 4 as required for a fiber of type  $I_4$ . Since the coefficients are generic,  $a_2$  is not a perfect square modulo  $s$  and we have a fiber of type  $I_n^{\mathrm{ns}}$ . We distinguish three cases depending on the values of  $\alpha$ , and  $\beta$ :

$$(\alpha = 0, \beta = 0), \quad (\alpha = 0, \beta > 0), \quad (\alpha > 0, \beta = 0). \quad (1.3)$$

One can think of the first one as the most general one, and the two others as specializations obtained by increasing the valuation of  $a_4$  or  $a_6$  without changing the valuation of the discriminant. The valuation of  $a_4$  and  $a_6$  cannot increase simultaneously as otherwise it will force an increase in the valuation of the discriminant locus and the fiber will no longer be of type  $I_4$ . The previous statement explains why we have three cases to consider. These three cases have very different fiber structures as summarized in Figures 2, 4, and 3. The first case ( $\alpha = \beta = 0$ ) is the one usually presented in F-theory tables.

---

<sup>3</sup>Let  $\nu$  be the valuation defined by the smooth divisor  $S$  supporting the fiber  $I_n^{\mathrm{ns}}$ . After an appropriate translation, the Weierstrass coefficients are such that  $\nu(a_3)$ ,  $\nu(a_4)$ , and  $\nu(a_6) \geq 0$ ,  $\nu(b_2) = 0$ , and  $\nu(\Delta) = n$ . The non-split condition is the statement that  $b_2$  is not a perfect square modulo  $s$  (meaning in the residue field of the generic point of  $S$ ,  $b_2$  is not a perfect square). We complete the square in  $y$  to effectively have  $a_1 = a_3 = 0$ .

## 1.2 Matter representations

The Lie group  $\mathrm{USp}(4)$  is the unique compact, connected, and simply connected complex Lie group with Lie algebra of type  $C_2$ . It has rank two and real dimension ten. Its center is the cyclic group  $\mathbb{Z}/2\mathbb{Z}$  generated by minus the identity element of  $\mathrm{USp}(4)$ . The quotient of  $\mathrm{USp}(4)$  by its center is isomorphic to the orthogonal group  $\mathrm{SO}(5)$  since  $\mathrm{USp}(4)$  is isomorphic to  $\mathrm{Spin}(5)$ . Both  $\mathrm{USp}(4)$  and  $\mathrm{SO}(5)$  have the same Lie algebra since the Lie algebra of type  $C_2$  is isomorphic to the Lie algebra of type  $B_2$ . The two fundamental representations of  $C_2$  have respectively dimension 4 and 5 and correspond respectively to the spinor and vector representations of  $B_2$ .

When we look at  $\mathrm{USp}(4)$  as the group  $\mathrm{Spin}(5)$ , the relevant representations are the adjoint representation of dimension 10, the spinor representation of dimension 4, and the vector representation of dimension 5. The spinor and vector representations of  $\mathrm{Spin}(5)$  correspond respectively to the fundamental of  $\mathrm{USp}(4)$  and the traceless antisymmetric two-tensor representation of  $\mathrm{USp}(4)$ . We use the physics convention of labeling representations by their dimensions in bold characters, as this will be sufficient to distinguish the representations we deal with in this paper. Thus, we denote the fundamental, the traceless antisymmetric (the trace is defined with respect to the antisymmetric symplectic metric), and the adjoint representations of  $C_2$  by (respectively) **4**, **5**, and **10**. The representations **4**, **5**, and **10** of  $C_2$  correspond to (respectively) the spinor, vector, and adjoint representation of  $\mathfrak{so}_5$ . The representation **4** is minuscule and pseudo-real while the representation **5** is quasi-minuscule and real. The representation **10**, being the adjoint representation, is always real.

The matter representation **R** associated to a  $\mathrm{USp}(4)$ -model is the sum of the above three irreducible representations:

$$\mathbf{R} = \mathbf{4} \oplus \mathbf{5} \oplus \mathbf{10}. \quad (1.4)$$

The fiber  $I_4^{\mathrm{ns}}$  degenerates in codimension two producing vertical curves whose weights correspond to the representations **4**, **5**, and **10** of  $C_2$ . The representations **4** and **5** are the two fundamental representations of the Lie algebra  $C_2$  in the sense that their highest weights are the simple roots of  $C_2$ . Moreover, all the weights of the representations **4** and **5** are also weights of the adjoint representation **10**. This fact explains why the  $\mathrm{USp}(4)$ -model has a unique crepant resolution.

The first codimension-two degeneration is when one of the nodes of  $I_4$  splits into two rational curves, producing weights in the representation **4**. Although the corresponding fiber is geometrically of Kodaira type  $I_5$ , the arithmetic type of the fiber depends on the dimension of the base:

$$\begin{cases} I_4^{\mathrm{ns}} \rightarrow I_5^{\mathrm{ns}} & \text{if } \dim B \geq 3 \rightarrow \text{no matter,} \\ I_4^{\mathrm{ns}} \rightarrow I_0^{*\mathrm{ss}} & \text{if } \dim B \geq 2 \rightarrow \text{Representation } \mathbf{5}, \\ I_4^{\mathrm{ns}} \rightarrow I_5^{\mathrm{s}} & \text{if } \dim B = 2 \rightarrow \text{Representation } \mathbf{4}, \\ I_4^{\mathrm{ns}} \rightarrow I_0^* & \text{if } \dim B = 2 \rightarrow \text{Representation } \mathbf{5}, \end{cases} \quad (1.5)$$

The second codimension-two degeneration is when the non-split node of  $I_4^{\mathrm{ns}}$  collapses into a double node producing weights in the representation **5**. The fiber is an incomplete Kodaira fiber of type  $I_0^*$ :

$$I_4^{\mathrm{ns}} \rightarrow I_0^*. \quad (1.6)$$

## 1.3 Counting charged hypermultiplets in 5D and 6D

A compactification of M-theory on a smooth Calabi–Yau threefold yields a five-dimensional  $\mathcal{N} = 1$  supergravity theory. Such a theory has vector multiplets and hypermultiplets, and the kinetic terms of the vector fields as well as Chern–Simons terms are encoded in a cubic prepotential that corresponds to the triple intersection polynomial of the divisors of the Calabi–Yau manifold. The

prepotential can have a quantum contribution coming from integrating out massive charged hypermultiplets. It follows that the prepotential depends on the number of charged hypermultiplets and in the best case, a direct comparison with geometry provides a determination of the number of charged hypermultiplets using the intersection ring of the Calabi–Yau threefold.

In the case of a  $\mathrm{USp}(4)$ -model in which the fiber  $\mathbb{I}_4^{\mathrm{ns}}$  is over the generic point of a divisor  $S$  of self-intersection  $S^2$  in the base  $B$  and genus  $g$ , the number of hypermultiplets charged under the representations **10**, **5**, and **4** are respectively

$$n_{\mathbf{10}} = g, \quad n_{\mathbf{5}} = 1 - g + S^2, \quad n_{\mathbf{4}} = 16(1 - g) + 4S^2. \quad (1.7)$$

In Section 2.2, we present a resolution by a succession of two blowups with smooth centers. In Section 3.2, we compute the Euler characteristic and the triple intersection numbers of the fibral divisors using the method developed in [21]. In the Calabi-Yau case, we also compute the Hodge numbers of the  $\mathrm{USp}(4)$ -model as in [21]. We will specialize to the Calabi-Yau case and the compactification of M-theory on such a Calabi-Yau threefold to a five-dimensional supergravity theory. We determine the representation associated with a  $\mathrm{USp}(4)$ -model by computing the intersection of the rational curves appearing when the fiber degenerates over codimension-two points. While the representation **4** is always present for a base of dimension two or higher, the representation **5** appears only if the base is a surface. We also illustrate the phenomena of frozen representations in F-theory. A representation is said to be *frozen* when there are curves carrying the weights of the representation but no physical states are charged under that representation. By comparing the triple intersection numbers of the fibral divisors to the one-loop prepotential of the five dimensional minimal supergravity theory with the same matter content, we compute the multiplicity of each representation. We also check that these multiplicities match those of an anomaly free six-dimensional theory with a compatible spectrum of charged hypermultiplets.

## 2 Weierstrass model, crepant resolutions, and fiber degenerations

**Conventions.** Given a simple Lie algebra with Dynkin diagram  $\mathfrak{g}$ , we denote by  $\tilde{\mathfrak{g}}$  the untwisted affine Dynkin diagram which reduces to  $\mathfrak{g}$  after removing one of its node of multiplicity one. We denote by  $\tilde{\mathfrak{g}}^t$  the twisted affine Dynkin diagram obtained from  $\tilde{\mathfrak{g}}$  by reversing the direction of all the arrows of the Dynkin diagram of  $\tilde{\mathfrak{g}}$ . The Cartan matrix of  $\tilde{\mathfrak{g}}^t$  is the transpose of the Cartan matrix of  $\tilde{\mathfrak{g}}$  [18, 21, 23]; thus, the difference between  $\tilde{\mathfrak{g}}$  and  $\tilde{\mathfrak{g}}^t$  only matters when  $\mathfrak{g}$  is not simply laced. We denote by  $V(f_1, \dots, f_n)$  the vanishing locus  $f_1 = \dots = f_n = 0$ .

### 2.1 Weierstrass model

The following elliptic fibration is the generic Weierstrass model for a  $\mathrm{USp}(4)$  model with a fiber  $\mathbb{I}_4^{\mathrm{ns}}$  over the Cartier divisor  $S = V(s)$ :

$$\mathcal{E}_0 : zy^2 = x^3 + a_2x^2z + a_{4,2}s^2xz^2 + a_{6,4}s^4z^3. \quad (2.1)$$

The short Weierstrass equation and the discriminant are characterized by the invariants:

$$c_4 = 16(a_2^2 - 3a_{4,2}s^2), \quad (2.2)$$

$$c_6 = 32(2a_2^3 - 9a_2a_{4,2}s^2 + 27a_{6,4}s^4), \quad (2.3)$$

$$\Delta = -16s^4\Delta', \quad \Delta' = 4a_2^3a_{6,4} - a_2^2a_4^2 - 18a_2a_{4,2}a_{6,4}s^2 + 4a_{4,2}^3s^2 + 27a_{6,4}^2s^4. \quad (2.4)$$

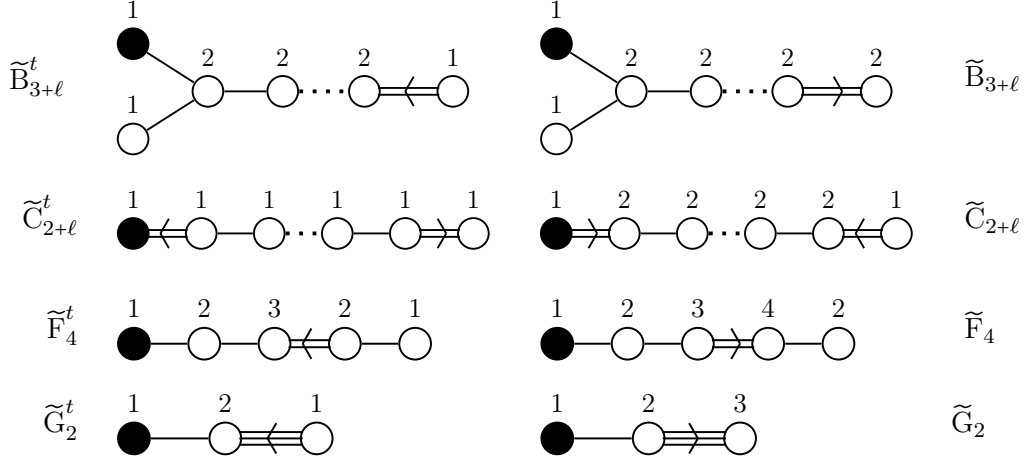

Figure 1: Twisted affine Lie algebras vs affine Lie algebras for non-simply laced cases. In each case, the colored node is the affine node and the number of non-colored node is given by the index. Only those on the left appear in the theory of elliptic fibrations as dual graphs of the fiber over the generic point of an irreducible component of the discriminant locus. In the notation of Kac [42],  $\tilde{B}_{3+l}^t$ ,  $\tilde{C}_{1+l}^t$ ,  $\tilde{F}_4^t$ , and  $\tilde{G}_2^t$  correspond respectively to  $A_{2\ell-1}^{(2)}$ ,  $D_{1+\ell}^{(2)}$ ,  $E_6^{(2)}$ , and  $D_4^{(3)}$ .

The fiber over  $S = V(s)$  is of type  $I_4^{\text{ns}}$  with valuation  $(0, 0, 4)$  over  $(c_4, c_6, \Delta)$  and  $b_2$  not a perfect square modulo  $s$ . Generically, the Mordell-Weil group is trivial. To ensure that the fiber is of type  $I_4^{\text{ns}}$ , we should have  $v(a_2) = 0$  and  $v(a_4) = 2$  or  $v(a_6) = 4$ . There are three cases to consider depending on the valuation of  $a_4$  and  $a_{6,4}$ :

$$v(a_4) = 2, v(a_6) = 4, \quad (2.5)$$

$$v(a_4) > 2, v(a_6) = 4, \quad (2.6)$$

$$v(a_4) = 2, v(a_6) > 4. \quad (2.7)$$

The reduced discriminant is composed of two irreducible components intersecting non-transversally along the reducible locus

$$s = 4a_2^2(4a_2a_6 - a_4^2) = 0. \quad (2.8)$$

This is the codimension-two locus over which the generic fiber over  $S$  degenerates; it consists of two irreducible components. In the generic case, these two loci are

$$S \cap V(a_2), \quad S \cap V(a_4^2 - a_2a_6). \quad (2.9)$$

The locus  $S \cap V(a_2)$  is the intersection of  $S$  with the cuspidal locus  $V(c_4, c_6)$  of the elliptic fibration. Taking into account the three possible cases of valuations for  $a_4$  and  $a_6$ , we have:

$$S \cap \Delta' : \begin{cases} v(a_4) = 2, v(a_6) = 4 & \implies s = a_2^2(4a_2a_{6,4} - a_{4,2}^2) = 0, \\ v(a_4) > 2, v(a_6) = 4 & \implies s = a_2^3a_{6,4} = 0, \\ v(a_4) = 2, v(a_6) > 4 & \implies s = a_2^2a_{4,2}^2 = 0. \end{cases} \quad (2.10)$$



Fiber Type	Dual graph	Dual graph of Geometric fiber
$I_3^{ns}, IV^{ns}$ $\tilde{A}_1$		
$I_{l-3}^{*ns}$ $\tilde{B}_l^t$ ( $l \geq 3$ )		
$I_{2l+2}^{ns}$ $\tilde{C}_{l+1}^t$ ( $l \geq 1$ )		
$I_{2l+3}^{ns}$ $\tilde{C}_{l+1}^t$ ( $l \geq 1$ )		
$IV^{*ns}$ $\tilde{F}_4^t$		
$I_0^{*ss}$ $\tilde{B}_3^t$		
$I_0^{*ns}$ $\tilde{G}_2^t$		

Table 1: Dual graphs for singular fibers elliptic fibrations with non-geometrically irreducible fiber components.

## 2.2 Crepant resolution

A Weierstrass model over a base  $B$  is defined in the ambient space

$$X_0 = \mathbb{P}(\mathcal{O}_B \oplus \mathcal{L}^{\otimes 2} \oplus \mathcal{L}^{\otimes 3}), \quad (2.11)$$

for a choice of a line bundle  $\mathcal{L}$  over  $B$  called the fundamental line bundle of the Weierstrass model. Each crepant resolution is an embedded resolution defined by a sequence of blowups with smooth centers. We denote the blowup  $X_{i+1} \rightarrow X_i$  along the ideal  $(f_1, f_2, \dots, f_n)$  with exceptional divisor  $E$  as:

$$X_i \xleftarrow{(f_1, \dots, f_n|E)} X_{i+1},$$

where  $X_0$  is the projective bundle in which the Weierstrass model is defined.

An important property of generic  $\mathrm{USp}(2n)$ -model is that they have at most one crepant resolution. A crepant resolution of the  $\mathrm{USp}(4)$ -model is given by the following sequence of blowups of  $X_0$  with smooth centers:

$$X_0 \xleftarrow{(x, y, s|e_1)} X_1 \xleftarrow{(x, y, e_1|e_2)} X_2 \quad (2.12)$$

where we abuse notation and write  $(x, y, s)$  for the proper transform of  $(x, y, s)$  after the first blowup and we write  $(x, y, e_1)$  for the proper transform of  $(x, y, e_1)$  after the second blowup. The proper transform of the elliptic fibration is:

$$Y: \quad zy^2 = e_1 e_2^2 x^3 + a_2 x^2 z + a_4 e_1 s^2 x z^2 + a_6 e_1^2 s^4 z^3. \quad (2.13)$$

The relative projective coordinates are:

$$[e_1 e_2^2 x : e_1 e_2^2 y : z][e_2 x : e_2 y : s][x : y : e_1]. \quad (2.14)$$

Working in patches, it is easy to check that the two blowups produce a smooth variety by the Jacobian criterion. The resolution is crepant because at each blowup we factor two exceptional divisors after blowing up an regular sequence of length three.

## 2.3 Fiber degenerations and the geometry of the fibral divisors

After the two blowups defining the crepant resolution, the total transform of  $S = V(s)$  is

$$f^* s = s e_1 e_2 \quad (2.15)$$

The corresponding fibral divisors are:

$$\begin{cases} D_0: & s = zy^2 - x^2(e_1 e_2^2 x - a_2 z) = 0, \\ D_1: & e_1 = y^2 - a_2 x^2 = 0, \\ D_2: & e_2 = y^2 - a_2 x^2 - a_4 e_1 s^2 x z - a_6 e_1^2 s^4 z^2 = 0. \end{cases} \quad (2.16)$$

We denote respectively by  $C_0$ ,  $C_1$ , and  $C_2$  the generic fiber of the fibral divisors  $D_0$ ,  $D_1$ , and  $D_2$ . By looking carefully at their defining equations, we see that the fibers of  $D_0$ ,  $D_1$ , and  $D_2$  are always rational curves and never jump in dimension. Thus, the elliptic fibration is equidimensional and this implies that the fibration is also flat since we work over an algebraically closed field.

We will now study carefully the geometry of the generic curves  $C_a$  and the fibral divisors  $D_a$  ( $a = 0, 1, 2$ ). The curve  $C_0$  is a rational curve that can be parametrized by  $y/x$ . More precisely,  $C_0$  is the normalization of a nodal curve. The divisor  $D_0$  is a  $\mathbb{P}^1$ -bundle over  $S$  since  $C_0$  does not degenerate. Thus, we have

$$D_0 \cong \mathbb{P}_S[\mathcal{O}_S \oplus \mathcal{L}]. \quad (2.17)$$

To understand the geometry of  $D_1$ , we use the Stein factorization as in [18, 23]. The fibral divisor  $D_1$  is a double cover of a variety  $\tilde{D}_1$  with branch locus  $V(a_2)$  such that  $\tilde{D}_1$  has connected fibers over  $S$ . More precisely,  $\tilde{D}_1$  is a  $\mathbb{P}^1$ -bundle  $\mathbb{P}_S[\mathcal{L} \oplus \mathcal{O}_S]$  over  $S$ :

$$D_1 \xrightarrow{2:1} \tilde{D}_1 \cong \mathbb{P}_S[\mathcal{L} \oplus \mathcal{O}_S] \longrightarrow S. \quad (2.18)$$

The fiber  $C_1$  is given by a conic that is geometrically degenerated. Geometrically, the curve  $C_1$  is composed of two distinct rational curves that coincide into a double curve over  $V(a_2) \cap S$ . Each of these rational curves defines a  $\mathbb{P}^1$ -bundle isomorphic to  $\mathbb{P}_S[\mathcal{L} \oplus \mathcal{O}_S]$ . The divisor  $D_1$  is obtained by gluing two such bundles along their fibers over  $V(a_2) \cap S$ . In the total space of the line bundle  $\mathcal{L}$  over  $S$ ,  $D_1$  can be written as the double cover  $V(t^2 - a_2)$  where  $t = y/x$  is a section of  $\mathcal{L}$  restricted on  $S$ .

The fibral divisor  $D_2$  is a conic bundle with matrix (with respect to the variables  $(y, x, e_1 s^2 z)$ ):

$$M = \begin{pmatrix} 1 & 0 & 0 \\ 0 & -a_2 & -\frac{a_{4,2}}{2} \\ 0 & -\frac{a_{4,2}}{2} & -a_{6,4} \end{pmatrix}, \quad (2.19)$$

whose discriminant locus is:

$$V(\det M) = V(a_4^2 - 4a_2a_6). \quad (2.20)$$

The degeneration of the generic fiber  $C_2$  of  $D_2$  is controlled by the branch locus of  $D_2$  and the rank of the matrix  $M$ . The curve  $C_2$  is a smooth conic if  $M$  has rank 3,  $C_2$  degenerates into two lines meeting transversally at a point when the rank of  $M$  is 2, and finally,  $C_2$  degenerates into a double line when the rank of  $M$  is one:

$$\text{rk } M = \begin{cases} 1 & \iff a_2 = a_{4,2} = a_{6,4} = 0, \\ 2 & \iff a_{4,2}^2 - 4a_2a_{6,4} = 0 \quad \text{and} \quad (a_2, a_{4,2}, a_{6,4}) \neq (0, 0, 0), \\ 3 & \iff a_{4,2}^2 - 4a_2a_{6,4} \neq 0. \end{cases} \quad (2.21)$$

These are also the irreducible components of the intersection of the two components of the discriminant locus. It follows that the generic fiber of  $D_2$  can only degenerate over  $V(S) \cap V(a_2)$ ,  $V(S) \cap V(a_4^2 - 4a_2a_6)$ , and  $V(S) \cap V(a_2, a_4)$ . The degeneration of  $C_1$  and  $C_2$  are described in section 3.1, see also Figure 2, Figure 3, and Figure 4.

### 3 Intersection numbers, topological and characteristic invariants

In this section we collect several important data from the intersection ring of a  $\text{USp}(4)$ -model. First, we compute the intersection numbers of vertical rational curves with the fibral divisors; these numbers are understood as the Dynkin labels of the weights of certain representations. We then compute the generating function for the Euler characteristic of a  $\text{USp}(4)$ -model.

### 3.1 Representations from intersection numbers

Over  $V(S) \cap V(a_2)$ , the component  $C_1$  of the fiber over the generic point of  $V(S)$  collapses into a double rational curve ( $C_1 \rightarrow 2C'_1$ ):

$$V(a_2) \implies \begin{cases} C_0 \rightarrow C_0 \\ C_1 \rightarrow 2C'_1 \\ C_2 \rightarrow C_2 \end{cases} \quad (3.1)$$

The fiber irreducible components of the fiber over the generic point of  $V(S) \cap V(a_2)$  are

$$\begin{cases} C_0: & s = zy^2 - e_1 e_2^2 x^3 - a_2 x^2 z = 0 \\ C'_1: & e_1 = y = 0 \\ C_2: & e_2 = y^2 - a_4 e_1 s^2 x z - a_6 e_1^2 s^4 z^2 = 0 \end{cases} \quad (3.2)$$

The weight of the new curve  $C'_1$  with respect to  $(D_0, D_1, D_2)$  is half of the weight of  $C_1$ , namely  $[0, -1, 2]$ . Ignoring the contribution from  $D_0$ , this weight is  $\boxed{-1, 2}$  and its Weyl orbit consists of the non-zero weights of the representation  $\mathbf{5}$  of  $C_2$ . The representation  $\mathbf{5}$  of  $C_2$  is quasi-minuscule and real.

$$a_2 = 0 \implies [0, -1, 2] \implies \boxed{-1, 2} \implies \mathbf{5}. \quad (3.3)$$

Over  $V(S) \cap V(a_4^2 - 4a_2 a_6)$ , the conic defining  $C_2$  degenerates to two intersecting lines.

$$V(a_4^2 - 4a_2 a_6) \implies \begin{cases} C_0 \rightarrow C_0 \\ C_1 \rightarrow C_1 \\ C_2 \rightarrow C_2^- + C_2^+ \end{cases} \quad (3.4)$$

But the two lines require to take the square root of  $a_2$ . That means that the two curves are non-split just as  $C_1$  and the singular fiber is of type  $I_5^{\text{ns}}$ . Both geometric irreducible components of  $C_2$  have weight  $[0, 1, -1]$  with respect to  $(D_0, D_1, D_2)$ .

The Weyl orbit of  $[1, -1]$  is the set of weights of the representation  $\mathbf{4}$  of  $C_2$ . The representation  $\mathbf{4}$  is minuscule and pseudo-real.

$$a_4^2 - 4a_2 a_6 = 0 \implies [0, 1, -1] \implies \boxed{1, -1} \implies \mathbf{4}. \quad (3.5)$$

Finally, over  $V(S) \cap V(a_2, a_4)$ ,  $C_1$  collapses to a double curve while the conic  $C_2$  splits geometrically into two curves. Again the components of  $C_2$  are only visible after a field extension, this time the field extension requires taking the square root of  $a_6$ .

**Remark 3.1.** If the base is a surface, the fibers over codimension two points are always geometric since we are over closed points. In particular, over  $V(a_4^2 - 4a_2 a_6)$ , the fiber is of type  $I_5$  and we can compute the weights of  $C_2^\pm$  individually. They produce the representation  $\mathbf{4}$ . If the base is three dimensional or higher, over  $V(a_4^2 - 4a_2 a_6)$ , the fiber is of type  $I_5^{\text{ns}}$ . While  $C_2$  geometrically splits into two curves  $C_2^\pm$ , these two curves are non-split and do not produce new weights. In particular, we do not get the representation  $\mathbf{4}$  when the base has dimension 3 or higher.

We have

$$\varphi_*(D_a \cdot C_b) = \begin{matrix} & C_0 & C_1 & C_2 \\ \begin{matrix} D_0 \\ D_1 \\ D_2 \end{matrix} & \begin{bmatrix} -2 & 2 & 0 \\ 2 & -4 & 2 \\ 0 & 2 & -2 \end{bmatrix} \end{matrix}, \quad (3.6)$$

which corresponds to the affine twisted Dynkin diagram  $\tilde{C}_2^t$ . The weights of all the curves are

	$C_0$	$C_1$	$C_2$	$C'_1$	$C_1^\pm$	$C_2^\pm$	$C'_2$
$D_0$	-2	2	0	1	1	0	0
$D_1$	2	-4	2	-2	-2	1	1
$D_2$	0	2	-2	1	1	-1	-1

(3.7)

### 3.2 Euler characteristic and Hodge numbers

**Theorem 3.2.** *The Euler characteristic of a  $USp(4)$  model over a base of dimension  $d$  is the component of degree  $d$  of the following rational function in the Chow ring of the base:*

$$\chi(Y) = 4 \int_B \frac{3L(1+2L) + 6L(1+2L)S - (5+8L)S^2}{(1+2L)(1+6L-4S)(1+S)} c(TB). \quad (3.8)$$

where  $c(TB)$  is the Chern class of the tangent bundle of  $B$ ,  $L = c_1(\mathcal{L})$ , and  $S$  is the class of the divisor  $V(s)$ .

*Proof.* See [21, Table 7]. □

**Remark 3.3.** This theorem generalizes results from [Grassi-Morrison] for Calabi-Yau threefolds while removing most of the conditions. In particular, we do not assume the Calabi-Yau condition, and we do not restrict the dimension of the base.

**Lemma 3.4.** *If the  $USp(4)$ -model  $Y \rightarrow B$  is a threefold and  $c_1 = c_1(TB)$  is the first Chern class of the base, we have*

$$\chi(Y) = 4(3c_1L - 18L^2 + 15LS - 5S^2). \quad (3.9)$$

*If  $Y$  is a Calabi-Yau threefold then the adjunction formula gives  $L = c_1(TB)$  and:*

$$\chi(Y) = -20(3c_1^2 - 3c_1S + S^2). \quad (3.10)$$

*For a smooth base with canonical class  $K$  and a smooth curve  $S$  of genus  $g$  and self-intersection  $S^2$ :*

$$\chi(Y) = -60K^2 + 40S^2 + 120(1-g) = -60K^2 + 60n(1-g) + 4(7-n)nS^2, \quad (3.11)$$

*A  $USp(4)$  model that is a Calabi-Yau threefold has Hodge numbers:*

$$h^{1,1}(Y) = 13 - K^2, \quad h^{1,2}(Y) = -47 + 60g + 29K^2 - 20S^2 \quad (3.12)$$

*Proof.* The Calabi-Yau condition is  $L = -K$  and the Hodge numbers follows from the Shioda-Tate-Wazir formula [61] as used in [21, Theorem 4.9]. □

**Conjecture 3.5.** *For a  $USp(2n)$ -model, we have*

$$\chi(Y) = 2 \int_B \frac{6L(1+2L) + 3L(1+2L)(2+n)S - n(1+4L+2n+2Ln)S^2}{(1+2L)(1+6L-2nS)(1+S)} c(TB). \quad (3.13)$$

*In the Calabi-Yau threefold case, we have*

$$h^{1,1}(Y) = 11 + n - K^2, \quad h^{1,2}(Y) = (29 - 30g)n - 11 - 29K^2 + 2n(7-n)S^2. \quad (3.14)$$

The conjecture has been checked up to  $n = 11$ . A complete proof will be presented elsewhere.

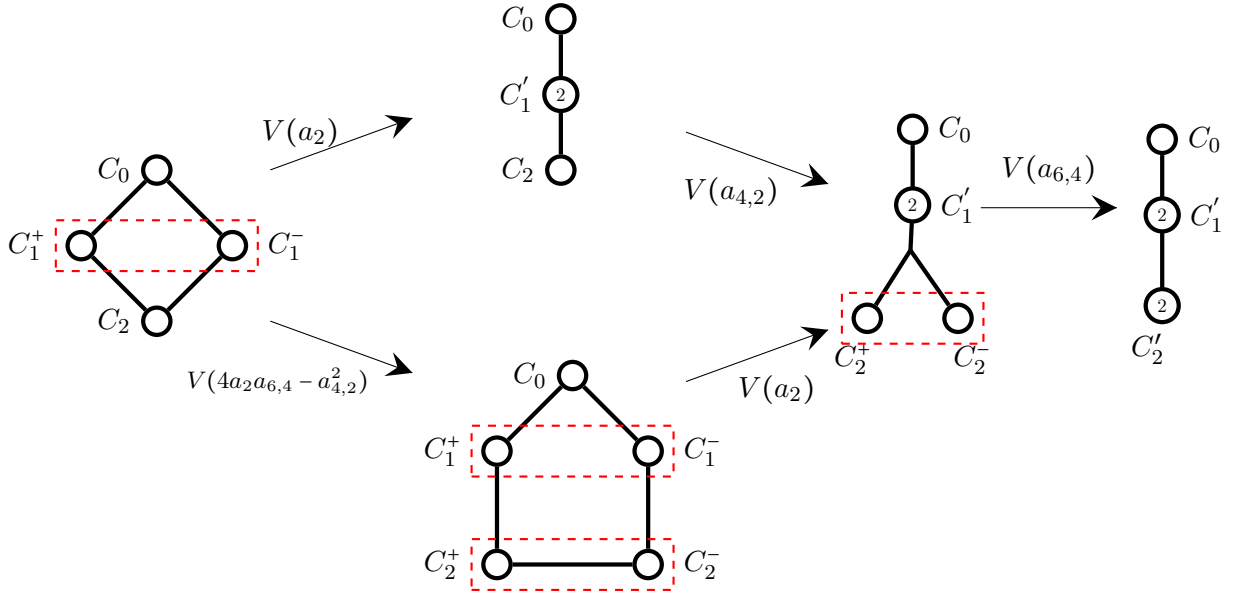

Figure 2: Fiber degeneration of a  $USp(4)$ -model with  $v(a_4) = 2$  and  $v(a_6) = 4$ .

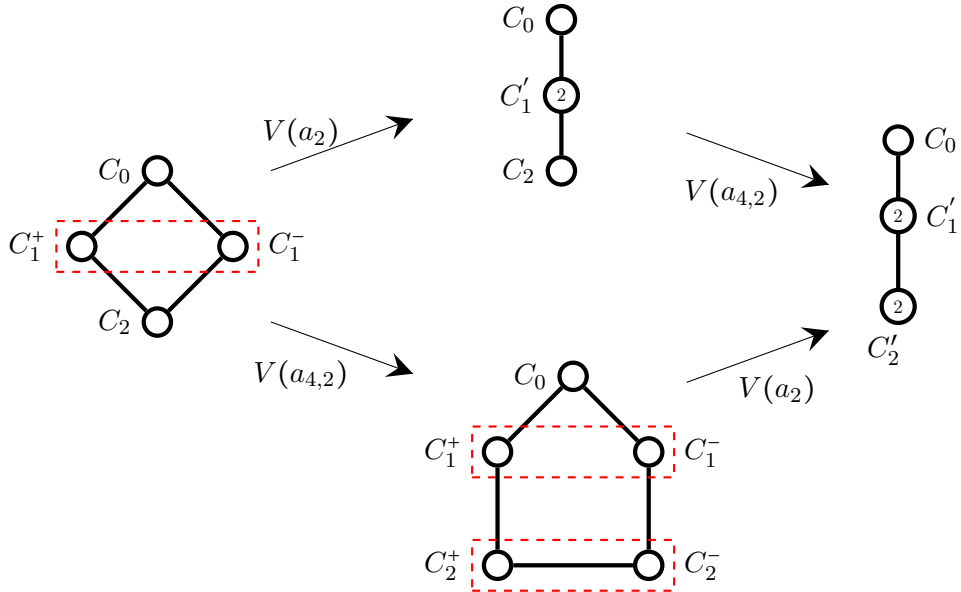

Figure 3: Fiber degeneration of a  $USp(4)$ -model with  $v(a_4) = 2$  and  $v(a_6) \geq 5$ .

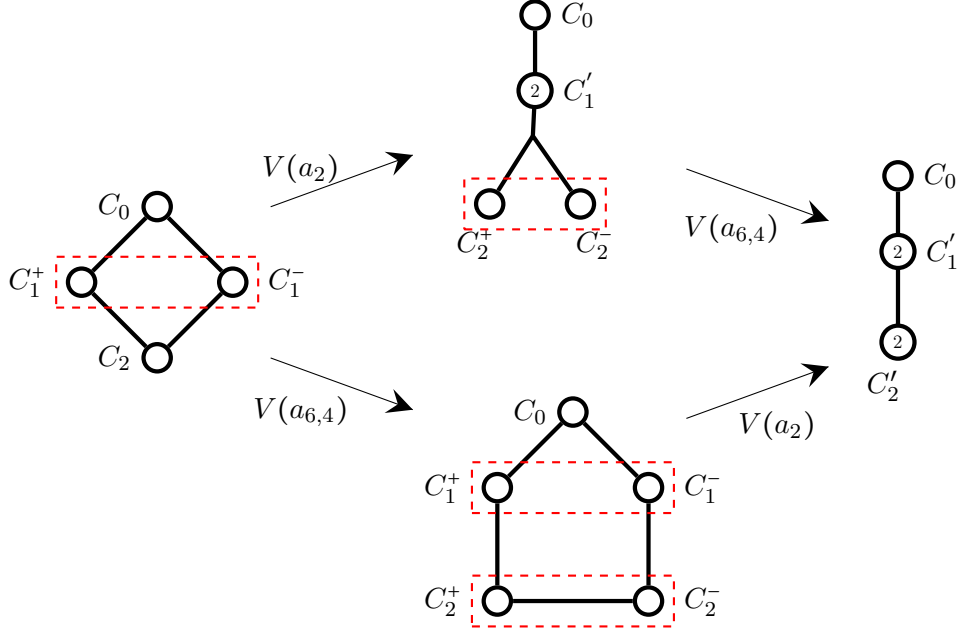

Figure 4: Fiber degeneration of a USp(4)-model with  $v(a_4) \geq 3$  and  $v(a_6) = 4$ .

### 3.3 Triple intersection numbers

**Theorem 3.6.** *The triple intersection polynomial of the fibral divisors is  $6\mathcal{F} = (D_0\alpha_0 + D_1\alpha_1 + D_2\alpha_2)^3$  with*

$$\begin{aligned}
6\mathcal{F} = & -4S(-L + S)\alpha_0^3 - 6(2L - S)S\alpha_0^2\alpha_1 + 12LS\alpha_0\alpha_1^2 \\
& - 8S^2\alpha_1^3 - 12(L - S)S\alpha_1^2\alpha_2 - 6S(-2L + S)\alpha_1\alpha_2^2 - 4LS\alpha_2^3
\end{aligned} \tag{3.15}$$

*Proof.* The classes of the three divisors are

$$[D_0] = f_2^* f_1^* \pi^* S - f_2^* E_1, \quad [D_1] = f_2^* E_1 - E_2, \quad [D_2] = E_2$$

where  $E_i$  is the class of the exceptional divisor of the  $i$ th blowup  $f_i$ . The class of the Weierstrass equation before the blowup is  $(3H + 6L)$  and after the two blowups it becomes  $(3H + 6L - 2E_1 - 2E_2)$ . The rest follows from the pushforward formula

$$6\mathcal{F} = \int_B \pi_* f_{1*} f_{2*} \left( ([D_0]\alpha_0 + [D_1]\alpha_1 + [D_2]\alpha_2)^3 (3f_2^* f_1^* H + 6f_2^* f_1^* \pi^* L - 2f_2^* E_1 - 2E_2) \right).$$

To perform the pushforward, we use the following data from the centers of the blowups:

$$\begin{aligned}
Z_1^{(1)} = H + 3\pi^* L & \quad , \quad Z_2^{(1)} = H + 2\pi^* L & \quad , \quad Z_3^{(1)} = \pi^* S, \\
Z_1^{(2)} = f_1^* H + 3f_1^* \pi^* L - E_1 & \quad , \quad Z_2^{(2)} = f_1^* H + 2f_1^* \pi^* L - E_1 & \quad , \quad Z_3^{(2)} = f_1^* E_1.
\end{aligned} \tag{3.16}$$

The triple intersection numbers involve at most quartic monomials. The pushforward after a blowup of the complete intersection  $(Z_1, Z_2, Z_3)$  with exceptional divisor  $E$  is [21]

$$f_* E = 0, \quad f_* E^2 = 0, \quad f_* E^3 = Z_1 Z_2 Z_3, \quad f_* E^4 = (Z_1 + Z_2 + Z_3) Z_1 Z_2 Z_3, \tag{3.17}$$

and the pull-push formula for any proper map  $g$ :

$$g_*(\alpha \cdot g^* \beta) = g_* \alpha \cdot \beta, \quad (3.18)$$

and

$$\pi_* H = 0, \quad \pi_* H^2 = 1, \quad \pi_* H^3 = -5L, \quad \pi^* H^4 = 19L^2. \quad (3.19)$$

The equations (3.17), (3.18), and (3.19) are enough to compute the triple intersection numbers.  $\square$

**Lemma 3.7.** *In the case where the resolved elliptic fibration  $Y$  is a Calabi-Yau threefold, with  $S$  a smooth curve of genus  $g$ :*

$$\begin{aligned} 6\mathcal{F} = & 8(1-g)\alpha_0^3 - 6(4-4g+S^2)\alpha_0^2\alpha_1 + 12(2-2g+S^2)\alpha_0\alpha_1^2 \\ & - 8S^2\alpha_1^3 - 24(1-g)\alpha_1^2\alpha_2 - 6(-4+4g-S^2)\alpha_1\alpha_2^2 - 4(2-2g+S^2)\alpha_2^3. \end{aligned} \quad (3.20)$$

*Proof.* The Calabi-Yau condition gives  $L = -K$  and the adjunction gives  $2-2g = -K \cdot S - S^2$ , which we can use to eliminate appearances of  $K \cdot S = -L \cdot S$ .  $\square$

## 4 Compactifications of M-theory to 5D on a $\mathrm{USp}(4)$ -model

M-theory compactified on a Calabi-Yau threefold results in a five-dimensional supersymmetric gauge theory with eight supercharges that we denote  $\mathcal{N} = 1$  five-dimensional supergravity [10, 37, 41] and its matter content consists of a gravitational multiplet,  $n_T$  tensor multiplets,  $n_V$  vector multiplets, and  $n_H$  hypermultiplets. In five dimensional spacetime, a massless tensor multiplet is dual to a massless vector. We assume that all tensors are massless and are dualized to vectors. Each vector multiplet contain a real scalar field  $\phi$  and each hypermultiplet contains four real fields forming a quaternion. The kinetic terms of all the vector multiplets and the graviphoton as well as the Chern-Simons terms are determined by a real function of the scalar fields called the prepotential.

In the Coulomb branch of an  $\mathcal{N} = 1$  supergravity theory in five dimension, the Lie group is completely broken to a Cartan subgroup. This implies that the charge of a hypermultiplet is simply a weight of the representation under which it transforms [41]. The Intriligator-Morrison-Seiberg (IMS) prepotential is the quantum contribution to the prepotential of a five-dimensional gauge theory after integrating out all massive fields.

Let  $\phi$  be in the Cartan subalgebra of a Lie algebra  $\mathfrak{g}$ . We denote by  $\mathbf{R}_i$  the representations under which the hypermultiplets transform. The weights are in the dual space of the Cartan subalgebra. We denote the evaluation of a weight on a coroot vector  $\phi$  as a scalar product  $\langle \mu, \phi \rangle$ . Denoting the roots by  $\alpha$  and the weights of  $\mathbf{R}_i$  by  $\varpi$  we have [41]

$$6\mathcal{F}_{\mathrm{IMS}}(\phi) = \frac{1}{2} \left( \sum_{\alpha} |\langle \alpha, \phi \rangle|^3 - \sum_i \sum_{\varpi \in \mathbf{R}_i} n_{\mathbf{R}_i} |\langle \varpi, \phi \rangle|^3 \right). \quad (4.1)$$

For all simple groups with the exception of  $\mathrm{SU}(N)$  with  $N \geq 3$ , this is the full purely cubic sector of the prepotential as there are no non-trivial third order Casimir invariants.



## 4.1 5D prepotential and counting charged hypermultiplets

**Theorem 4.1.** *The IMS prepotential for the Lie algebra  $USp(4)$  with  $n_4$  hypermultiplets in the fundamental representation,  $n_5$  in the traceless antisymmetric representation, and  $n_{10}$  in the adjoint representation is*

$$6\mathcal{F}_{IMS} = -(8n_{10} + n_4 - 8)\phi_2^3 - 8(n_{10} + n_5 - 1)\phi_1^3 - 3(4n_{10} + n_4 - 4n_5 - 4)\phi_1^2\phi_2 + 3(6n_{10} + n_4 - 2n_5 - 6)\phi_1\phi_2^2. \quad (4.2)$$

The simple roots are  $[2, -1]$  and  $[-2, 2]$  in the basis of fundamental weights. We take  $(\phi_1, \phi_2)$  in the basis of coroots. The dual open Weyl chamber is defined by

$$\varphi_2 - \varphi_1 > 0, \quad 2\varphi_1 - \varphi_2 > 0. \quad (4.3)$$

The two polynomial  $\mathcal{F}_{IMS}$  and  $\mathcal{F}$  match for  $\alpha_0 = 0, \alpha_1 \leftrightarrow \phi_2, \alpha_2 \leftrightarrow \phi_1$  and :

$$n_5 = S^2 + 1 - n_{10}, \quad n_4 = 4(S^2 + 4 - 2n_{10} - 2g). \quad (4.4)$$

We see in particular that  $n_{10}$  is not fixed by the matching of the cubic polynomials but is only restricted by inequalities:

$$0 \leq n_{10} \leq 2 - g + \frac{1}{2}S^2, \quad 0 \leq n_{10} \leq 1 + S^2, \quad (4.5)$$

The assumption  $n_{10} \geq 0$  and  $n_5 \geq 0$  gives a lower bound on the self-intersection  $S^2$ :

$$-1 \leq S^2. \quad (4.6)$$

Following Witten's quantization argument, the number of hypermultiplets transforming in the adjoint representation is given by the genus  $g$  of the curve  $S$ , and we have

$$n_{10} = g, \quad n_5 = S^2 + 1 - g, \quad n_4 = 4S^2 + 16(1 - g). \quad (4.7)$$

## 5 F-theory on a Calabi-Yau threefold and anomaly cancellation

In this section, we prove that the Calabi-Yau threefold  $USp(4)$ -model engineers anomaly free 6D  $\mathcal{N} = (1, 0)$  supergravity theories.

### 5.1 Generalized Green-Schwarz mechanism in F-theory

We assume that  $Y$  is a simply-connected elliptically fibered Calabi-Yau threefold with holonomy  $SU(3)$ . The  $SU(3)$  holonomy and the simply-connected condition forces  $B$  to be a rational surface. The low energy effective description of F-theory compactified on an elliptically fibered Calabi-Yau threefold  $Y$  with a base  $B$  is six-dimensional  $\mathcal{N} = (1, 0)$  supergravity coupled to  $n_T = h^{1,1}(B) - 1$  tensor multiplets,  $n_H^0 = h^{2,1}(Y) + 1$  neutral hypermultiplets, and  $n_V^{(6)}$  massless vector multiplets such that  $n_V^{(6)} + n_T = h^{1,1}(Y) - 2$  [49].

Consider a 6D  $\mathcal{N} = (1, 0)$  supergravity theory with  $n_T$  tensor multiplets,  $n_V^{(6)}$  vector multiplets, and  $n_H$  hypermultiplets. We assume that the gauge group is simple, so that

$$n_V^{(6)} = \dim G. \quad (5.1)$$

We distinguish between the numbers  $n_{\mathbf{H}}^0$  of neutral hypermultiplets and  $n_{\mathbf{R}_i}$  of both charged and neutral hypermultiplets transforming in the representation  $\mathbf{R}_i$  of the gauge group. CPT invariance requires that  $\mathbf{R}_i$  is a quaternionic representation [55]. When  $\mathbf{R}_i$  is pseudo-real, we can have half-hypermultiplets transforming under  $\mathbf{R}_i$ , which can give half-integer values for  $n_{\mathbf{R}_i}$ . We also count as neutral any hypermultiplet whose charge is given by the zero weight of a representation. We denote by  $\dim \mathbf{R}_{i,0}$  the number of zero weights in the representation  $\mathbf{R}_i$ . The total number of charged hypermultiplets is then [39]

$$n_{\mathbf{H}}^{\text{ch}} = \sum_i (\dim \mathbf{R}_i - \dim \mathbf{R}_{i,0}) n_{\mathbf{R}_i}. \quad (5.2)$$

The total number of hypermultiplets is  $n_{\mathbf{H}} = n_{\mathbf{H}}^0 + n_{\mathbf{H}}^{\text{ch}}$ . The pure gravitational anomaly is cancelled by the vanishing of the coefficient of  $\text{tr } R^4$  in the anomaly polynomial [54, Footnote 3]:

$$n_{\mathbf{H}} - n_{\mathbf{V}}^{(6)} + 29n_{\mathbf{T}} - 273 = 0. \quad (5.3)$$

Using the duality between F-theory on an elliptically fibered Calabi-Yau threefold with base  $B$  and type IIB on  $B$ , Noether's formula implies the following for the number of tensor multiplets [52]:

$$n_{\mathbf{T}} = h^{1,1}(B) - 1 = 9 - K^2. \quad (5.4)$$

The remaining part of the anomaly polynomial is [55]:

$$\mathcal{I}_8 = \frac{9 - n_{\mathbf{T}}}{8} (\text{tr } R^2)^2 + \frac{1}{6} X^{(2)} \text{tr } R^2 - \frac{2}{3} X^{(4)}, \quad (5.5)$$

where

$$X^{(n)} = \text{tr}_{\text{adj}} F^n - \sum_i n_{\mathbf{R}_i} \text{tr}_{\mathbf{R}_i} F^n. \quad (5.6)$$

For a reference representation  $\mathbf{F}$ , the trace identities for a representation  $\mathbf{R}_i$  of a simple group  $G$  are

$$\text{tr}_{\mathbf{R}_i} F^2 = A_{\mathbf{R}_i} \text{tr}_{\mathbf{F}} F^2, \quad \text{tr}_{\mathbf{R}_i} F^4 = B_{\mathbf{R}_i} \text{tr}_{\mathbf{F}} F^4 + C_{\mathbf{R}_i} (\text{tr}_{\mathbf{F}} F^2)^2 \quad (5.7)$$

with respect to a reference representation  $\mathbf{F}$  for each simple component  $G$  of the gauge group.<sup>4</sup> The coefficients  $A_{\mathbf{R}_i}$ ,  $B_{\mathbf{R}_i}$ , and  $C_{\mathbf{R}_i}$  depends on the gauge groups and are listed in [6, 14, 59]. We have

$$X^{(2)} = \left( A_{\text{adj}} - \sum_i n_{\mathbf{R}_i} A_{\mathbf{R}_i} \right) \text{tr}_{\mathbf{F}} F^2 \quad (5.8)$$

$$X^{(4)} = \left( B_{\text{adj}} - \sum_i n_{\mathbf{R}_i} B_{\mathbf{R}_i} \right) \text{tr}_{\mathbf{F}} F^4 + \left( C_{\text{adj}} - \sum_i n_{\mathbf{R}_i} C_{\mathbf{R}_i} \right) (\text{tr}_{\mathbf{F}} F^2)^2. \quad (5.9)$$

If  $G$  does not have two independent quartic Casimir invariants, we take  $B_{\mathbf{R}_i} = 0$  [52]. If the simple group  $G$  is supported on a divisor  $S$  and  $K$  is the canonical class of the base of the elliptic fibration, we can factor  $\mathcal{I}_8$  as a perfect square following Sadov's analysis [52, 53]:

$$\mathcal{I}_8 = \frac{1}{2} \left( \frac{1}{2} K \text{tr } R^2 - \frac{2}{\lambda} S \text{tr}_{\mathbf{F}} F \right)^2. \quad (5.10)$$

---

<sup>4</sup>We denote this representation by  $\mathbf{F}$  as we have chosen the fundamental representation(s) for convenience. However, any representation can be used as a reference representation.

Sadov showed this factorization matches the general expression of  $\mathcal{I}_8$  if and only the following anomaly cancellation conditions hold [52] (see also [39, 50]):

$$n_{\text{H}} - n_{\text{V}}^{(6)} + 29n_{\text{T}} - 273 = 0, \quad (5.11\text{a})$$

$$n_{\text{T}} = 9 - K^2, \quad (5.11\text{b})$$

$$\left( B_{\text{adj}} - \sum_i n_{\mathbf{R}_i} B_{\mathbf{R}_i} \right) = 0, \quad (5.11\text{c})$$

$$\lambda \left( A_{\text{adj}} - \sum_i n_{\mathbf{R}_i} A_{\mathbf{R}_i} \right) = 6KS, \quad (5.11\text{d})$$

$$\lambda^2 \left( C_{\text{adj}} - \sum_i n_{\mathbf{R}_i} C_{\mathbf{R}_i} \right) = -3S^2. \quad (5.11\text{e})$$

The coefficient  $\lambda$  is a normalization factor chosen such that the smallest topological charge of an embedded  $\text{SU}(2)$  instanton in  $G$  is one [7, 44, 50]. This forces  $\lambda$  to be the Dynkin index of the fundamental representation of  $G$  as summarized in Table 2 [50].

Using adjunction ( $KS + S^2 = 2g - 2$ ), the last two anomaly equations give an expression for the genus of  $S$ :

$$\lambda \left( A_{\text{adj}} - \sum_i n_{\mathbf{R}_i} A_{\mathbf{R}_i} \right) - 2\lambda^2 \left( C_{\text{adj}} - \sum_i n_{\mathbf{R}_i} C_{\mathbf{R}_i} \right) = 12(g - 1). \quad (5.12)$$

$\mathfrak{g}$	$A_n$ ( $n \geq 1$ )	$B_n$ ( $n \geq 3$ )	$C_n$ ( $n \geq 2$ )	$D_n$ ( $n \geq 4$ )	$E_8$	$E_7$	$E_6$	$F_4$	$G_2$
$\mathbf{F}$	$\mathbf{n} + 1$	$\mathbf{V} = 2\mathbf{n} + 1$	$\mathbf{V} = 2\mathbf{n}$	$\mathbf{V} = 2\mathbf{n}$	<b>248</b>	<b>56</b>	<b>27</b>	<b>26</b>	<b>7</b>
$\lambda = I_2(\mathbf{F})$	1	2	1	2	60	12	6	6	2

Table 2: The normalization factors for each simple Lie algebra used in the 6D anomaly equations [44, 50]. The second row identifies the defining representation  $\mathbf{F}$  for each algebra; the representation  $\mathbf{F}$  is the smallest non-trivial representation of the Lie algebra. The coefficient  $\lambda$  is the second Dynkin index of  $\mathbf{F}$ . The second Dynkin of fundamental representations of a simple Lie algebra were first computed in [13, Table 5].

## 5.2 Anomaly cancellation for $\text{USp}(2n)$ with matter in the adjoint, fundamental, and traceless antisymmetric representation

We now consider the specificity of the  $\text{USp}(2n)$ -model. We will need the following trace identities:

$\mathbf{R}$	$A_{\mathbf{R}}$	$B_{\mathbf{R}}$	$C_{\mathbf{R}}$	$\dim \mathbf{R}$	$\dim \mathbf{R}_0$	$\dim \mathbf{R} - \dim \mathbf{R}_0$
$\mathbf{F}$	1	1	0	$2n$	0	$2n$
$\mathbf{Adj}$	$2n + 2$	$2n + 8$	3	$n(2n + 1)$	$n$	$2n^2$
$\Lambda_0^2$	$2n - 2$	$2n - 8$	3	$(n - 1)(2n + 1)$	$n - 1$	$2n(n - 1)$

Table 3: Coefficients for the trace identities in the case of  $\text{USp}(2n)$ . The reference representation  $\mathbf{F}$  is the representation  $2\mathbf{n}$ . See [53, 55, 57].

We first ignore the condition for the cancellation of the gravitational anomaly, namely equation (5.11a). After fixing the conventions for the trace identities and the coefficient  $\lambda = 1$ , we are left

with three linear equations that have a unique solution:

$$n_{\mathbf{adj}} = g, \quad n_{\mathbf{F}} = 16(1 - g) + 2(4 - n)S^2, \quad n_{\Lambda_0^2} = 1 - g + S^2. \quad (5.13)$$

We are left with the pure gravitational anomaly, which requires checking equation (5.11a). Since we have explicit expressions for the number of charged hypermultiplets, this is a straightforward computation. We then see immediately that equation (5.11a) is also satisfied and  $\mathcal{I}_8$  factors as a perfect square:

$$\mathcal{I}_8 = \frac{9 - n_T}{8} (\text{tr } R^2)^2 + \frac{1}{6} X^{(2)} \text{tr } R^2 - \frac{2}{3} X^{(4)} \quad (5.14)$$

$$= \frac{1}{2} \left( \frac{1}{2} K \text{tr } R^2 + 2S \text{tr}_{\mathbf{F}} F^2 \right)^2 \quad (5.15)$$

### 5.3 Geometry of representation multiplicities

In this section, we study the geometric meaning of the number  $n_{\mathbf{10}}$ ,  $n_{\mathbf{5}}$ , and  $n_{\mathbf{4}}$  computed from triple intersection numbers and anomaly cancellation conditions. The matching of the triple intersection numbers with the prepotential does not restrict  $n_{\mathbf{10}}$ . We get  $n_{\mathbf{10}} = g$  by using Witten's quantization argument in 5D or by the anomaly cancellation conditions in the 6D theory.

In this subsection, we would like to give a geometric description of  $n_{\mathbf{5}}$  and  $n_{\mathbf{4}}$ . Using Riemann-Roch, we can express  $n_{\mathbf{5}}$  as a difference of homomorphic Euler characteristics.

We denote by  $\chi(M, \mathcal{F})$  the holomorphic Euler characteristic of the sheaf  $\mathcal{F}$  in the variety  $M$ . By definition

$$\chi(M, \mathcal{F}) = \sum_{i=0}^{\dim M} \dim H^i(M, \mathcal{F}). \quad (5.16)$$

**Theorem 5.1.** *For a  $USp(2n)$ -model with a gauge divisor  $S$  of genus  $g$  in a smooth compact rational surface  $B$ , we have*

$$n_{\Lambda_0^2} = \chi(B, \mathcal{O}_B(S)) - 1. \quad (5.17)$$

*Proof.* The Riemann-Roch theorem states that for a curve  $S$  in an algebraic surface  $B$ :

$$\chi(B, \mathcal{O}_S) = \frac{1}{2} S(S - K) + \chi(\mathcal{O}_B), \quad (5.18)$$

which can be rewritten as

$$\chi(B, \mathcal{O}_S) = S^2 - \frac{1}{2} S(S + K) + \chi(B, \mathcal{O}_B), \quad (5.19)$$

Since  $-S(S + K) = 2 - 2g$ , we have

$$\chi(B, \mathcal{O}_S) = S^2 + 1 - g + \chi(B, \mathcal{O}_B). \quad (5.20)$$

Hence

$$n_{\Lambda_0^2} = S^2 + 1 - g = \chi(B, \mathcal{O}_B(S)) - \chi(B, \mathcal{O}_B) = \chi(B, \mathcal{O}_B(S)) - 1. \quad (5.21)$$

In the last equality, we use that  $B$  is a rational surface and therefore has holomorphic Euler characteristic 1.  $\square$

**Remark 5.2.** If  $S'$  is the double cover of  $S$  branched at the points  $V(S, a_2)$ , then as can be seen by computing the topological Euler characteristic of  $S$ , we have<sup>5</sup>:

$$g(S') = 1 + S^2. \quad (5.22)$$

Hence we can also write  $n_{\mathfrak{5}}$  as the difference:

$$n_{\Lambda_0^2} = S^2 + 1 - g = g(S') - g(S). \quad (5.23)$$

The curve  $S'$  is defined by The divisor  $D_1$  which can be described as a conic bundle over  $S'$  with only double lines as singular fiber and a discriminant locus  $V(a_2)$ .

The number  $n_{\mathbf{V}}$  can be written as the intersection number between the curve  $S$  and the locus  $V(b_{8,2n})$  of class  $-(8K + 2nS)$ :

$$n_{\mathbf{V}} = -(8K + 2nS) \cdot S. \quad (5.24)$$

This is in line with the traditional wisdom from classical intersecting brane models. However, if  $v(a_4) > 2$  (resp.  $v(a_6) > 4$ ), the locus over which the representation  $\mathbf{V}$  is localized is  $V(a_{6,2n}) \cap S$  (resp.  $V(a_{4,n}) \cap S$ ) and the previous interpretation of  $n_{\mathbf{V}}$  losses its geometric meaning. But a new geometric matching emerges in each case.

1. When  $v(a_4) > n$ , the fiber over  $V(a_2)$  has the node  $C_2^\pm$  both of which has weight  $[1, -1]$ , which is a weight of the representation  $\mathbf{V}$ . That means that we have to add the intersection numbers  $-2S \cdot K$  to  $(-6K - 2nS) \cdot S$  and we retrieve again the interpretation in terms of intersecting brane literature:

$$n_{\mathbf{V}} = (-2K) \cdot S + (-6K - 2nS) \cdot S = (-8K - 2nS) \cdot S. \quad (5.25)$$

2. In the case of  $v(a_6) > 2n$ , the curve  $S$  intersects the other components of the discriminant locus over points of multiplicities 2. If each of these points is counted twice to take into account the scheme structure, we again retrieve the geometric meaning of  $n_{\mathbf{V}}$ :

$$n_{\mathbf{V}} = 2 \left( (-4K - nS) \cdot S \right) = -(8K + 2nS) \cdot S. \quad (5.26)$$

## 5.4 An heterotic sanity check

In the case of a  $\text{USp}(4)$ -model, we will check the counting on a model with a heterotic dual. If the curve  $S$  has genus  $g = 0$ , then:

$$g = 0 \implies n_{10} = 0, \quad n_{\mathfrak{5}} = S^2 + 1, \quad \text{and} \quad n_4 = 4(S^2 + 4). \quad (5.27)$$

These values match the matter content of a  $\text{Spin}(5)$  gauge theory in  $\mathcal{N} = 1$  six dimensional supergravity obtained by compactifying the  $\text{E}_8 \times \text{E}_8$  Heterotic string theory on a K3 surface with instanton numbers  $(12 + n, 12 - n)$  where  $n = n_{\mathfrak{5}} - 1 = S^2$ .

---

<sup>5</sup>To compute the genus of  $S'$ , one can first compute its topological Euler characteristic and use the formula  $2 - 2g(S') = \chi(S')$ . Since  $S'$  is a double cover, its topological Euler characteristic of  $S'$  is  $\chi(S') = 2\chi(S) - b$  where  $b = -2K \cdot S$  is the number of branched points. Using  $\chi(S) = -K \cdot S - S^2$ , it follows that  $\chi(S') = -2S^2$  and  $g(S') = S^2 + 1$ .

## 5.5 Frozen representations

In this section, we discuss geometric configurations which, despite containing curves corresponding to weights in a particular representation, are nonetheless forced by anomaly cancellation to have zero hypermultiplets charged under that representation.

For non-simply-laced Lie algebras, the numbers of representations are not given by the numbers of collision points supporting the singular fibers carrying the weights of these representations. It follows that it is possible to have a vanishing number of hypermultiplets carrying a representation despite the fact that the geometry has curves carrying the weights of that representation. In such a case, we say that the representation is frozen.

As an example, we consider a curve  $S$  reaching the lower bound for  $S^2$ , that is,  $S$  is a rational curve of self-intersection  $-1$ , so that

$$(g = 0 \quad \text{and} \quad S^2 = -1) \implies g = n_{\mathbf{10}} = n_{\mathbf{5}} = 0, \quad \text{and} \quad n_{\mathbf{4}} = 12. \quad (5.28)$$

It follows that when  $S$  is an exceptional rational curve, there is no matter in the adjoint nor in the traceless antisymmetric representation. In that case, the fundamental representation has multiplicity 12. Still, on the curve  $S$ , there are six points over which the  $I_4^{\text{ns}}$  fiber degenerates and the degenerated fibers contain vertical rational curves whose weights are in the representation  $\mathbf{5}$ . However, the anomaly cancellation gives  $n_{\mathbf{5}} = 0$ . We say that the representation  $\mathbf{5}$  is *frozen*.

More generally, the representation  $\mathbf{5}$  of a  $\text{USp}(4)$  model is frozen if and only if the following equivalent conditions holds:

$$S^2 = g - 1, \quad \chi(B, \mathcal{O}_B(S)) = 1, \quad \chi(S) = -2K \cdot S, \quad K \cdot S = g - 1, \quad K \cdot S = S^2. \quad (5.29)$$

**Remark 5.3.** If  $S$  is a smooth rational curve, the representation  $\mathbf{5}$  is frozen if and only if  $S^2 = -1$ . That means that the representations  $\mathbf{10}$  and  $\mathbf{5}$  are both frozen if and only if  $S$  is an exceptional divisor of the base and can be contracted to a point without introducing a singularity in the base.

**Remark 5.4.** For  $\text{USp}(4)$ , the only representations that can be frozen are the adjoint representation (when  $g = 0$ ) and the traceless antisymmetric representation  $\Lambda_0^2$  (the  $\mathbf{5}$ ) when  $S^2 = g - 1$ . The representation  $\mathbf{4}$  cannot be frozen since  $n_{\mathbf{4}}$  vanishes exactly when the locus over which the curves with weights in the representation  $\mathbf{4}$  are absent.

The  $\text{USp}(4)$ -model illustrates several surprising phenomena in F-theory such as the existence of frozen representations and the role of the dimension of the base when determining representations.

## 6 Katz–Vafa method and $\text{USp}(4)$ -models

The Katz–Vafa method is a heuristic technique to determine the matter representations appearing in presence of an enhancement of a Lie algebra  $\mathfrak{h}$  into a Lie algebra  $\mathfrak{g}$  using branching rules expressing the decomposition of the adjoint representation of  $\mathfrak{g}$  along irreducible representations of  $\mathfrak{h}$ . In F-theory,  $\mathfrak{h}$  is the Lie algebra determined by the fibers over codimension-one points while  $\mathfrak{g}$  is associated with the Dynkin diagram of a singularity enhancement over codimension-two points. A more systematic and reliable method is to compute the weights of the rational curves appearing in the fiber enhancement to determine the representations they correspond to by using the notion of *saturation of weights*. Nevertheless, it is instructive to know how and why the Katz–Vafa method fails.

## 6.1 Branching rules

*Branching rules* describe how an irreducible representation of a Lie algebra  $\mathfrak{g}$  decomposes into irreducible representations of one of a subalgebra  $\mathfrak{h}$ . A subalgebra  $\mathfrak{h}$  can be embedded in a Lie algebra  $\mathfrak{g}$  in more than one way, which might lead to inequivalent branching rules. Thus, identifying a subalgebras (up to isomorphisms)  $\mathfrak{h}$  of  $\mathfrak{g}$  is not enough to determine a branching rule, even if  $\mathfrak{h}$  is a maximal subalgebra of  $\mathfrak{g}$ . What is required to determine a branching rule is an embedding of  $\mathfrak{h}$  in  $\mathfrak{g}$ . For example, Dynkin’s classification of maximal subalgebras shows that the Lie algebra of type  $E_8$  has three types of maximal  $A_1$  subalgebras leading to distinct branching rules.

Branching rules were first introduced in the first part of the 20th century to answer questions in quantum mechanics such as the study of the degeneration levels of the hydrogen atom. Branching rules quickly imposed themselves as fundamental tools in nuclear physics, particle physics, and condensed matter physics. With the development of gauge theories, the paradigm of symmetry breaking, Grand Unified Theories, and the Kaluza–Klein dimensional reduction via compactification, branching rules became an irreplaceable instrument in the toolkit of theoretical and mathematical physicists.

The first examples of branching rules can be traced back to Hermann Weyl’s seminal book on quantum mechanics and representation theory. Weyl gave a beautiful complete branching theorem for the restriction of an irreducible representation of  $A_n$  to a sum of irreducible representations of  $A_{n-1}$ . Murnaghan described the branching rules for the restriction of the special orthogonal group  $SO(2n+1)$  to its subgroup  $SO(2n)$  and  $USp(2n+2)$  to  $USp(2n)$ . Littlewood and Murnaghan gave the branching rules for the restriction of  $U(2n)$  to  $USp(2n)$ . Many applications of branching rules are reviewed by Hamermesh. Branching rules are collected in tables such as in the book of McKay and Patera [51], the review of Slansky on Grand Unification [56] (see also [62]), and many can be also explored in computer packages such as Sage and LieArt.

## 6.2 Branching rules in F-theory

We denote by  $\mathfrak{g} \downarrow \mathfrak{h}$  the restriction of a Lie algebra  $\mathfrak{g}$  to a subalgebra  $\mathfrak{h}$ . If a gauge theory with gauge algebra  $\mathfrak{g}$  and matter (a Higgs field) transforming in the adjoint representation of  $\mathfrak{g}$  undergoes a symmetry breaking to a subalgebra  $\mathfrak{h}$ , Goldstone bosons will transform under irreducible representations  $\mathbf{R}_i$  appearing in the branching rule for the adjoint representation of  $\mathfrak{g}$  under the restriction of  $\mathfrak{g} \downarrow \mathfrak{h}$ :

$$\mathfrak{g} \downarrow \mathfrak{h} : \quad \text{adj}(\mathfrak{g}) = \text{adj}(\mathfrak{h}) \bigoplus_i \mathbf{R}_i. \quad (6.1)$$

In F-theory, codimension-one singular fibers determine a gauge algebra  $\mathfrak{h}$  and the codimension-two singularities would give a gauge algebra  $\mathfrak{g}$  if they were lifted to divisors by a blowup. In this situation, we say that  $\mathfrak{h}$  is enhanced to  $\mathfrak{g}$ . Typically,  $\mathfrak{h}$  is a subalgebra of  $\mathfrak{g}$ .

In this situation, the *Katz–Vafa method* proposes that the matter representation consists of the sum of the irreducible representations  $\mathbf{R}_i$  appearing in equation (6.1) for the branching rules for the adjoint representation when the Lie algebra  $\mathfrak{g}$  is reduced to the subalgebra  $\mathfrak{h}$ . The Katz–Vafa method was originally considered for the following ten types of rank-one enhancements between ADE Lie

algebras:

$$A_n \rightarrow A_{n-k} \oplus A_{k-1}, \quad (6.2)$$

$$D_n \rightarrow D_{n-1}, A_{n-1}, D_{n-k} \oplus A_{k-1}, \quad (6.3)$$

$$E_6 \rightarrow D_5, A_5, \quad (6.4)$$

$$E_7 \rightarrow E_6, D_6, A_6, \quad (6.5)$$

$$E_8 \rightarrow E_7. \quad (6.6)$$

A detailed analysis of these branching rules are presented in [24].

### 6.3 USp(4)-models as kryptonite for the Katz–Vafa method

The representations of Spin(5) of lowest dimensions are the trivial representation **1**, the spin representation **4**, the vector representation **5**, the adjoint representation **10**, and the traceless symmetric tensor representation **14**.

In this section, we assume that the base of the USp(4)-model is a surface. A direct consequence of that assumption is that all the fibers over codimension-two points are geometric and therefore split. A generic USp(4)-model has two codimension-two loci where the  $I_4^{\text{ns}}$  fiber degenerates (see Figure 2). Over  $S \cap V(4a_2a_{6,4} - a_{4,2}^2)$ , the fiber  $I_4^{\text{ns}}$  degenerates to a fiber of type  $I_5$  containing a rational curve carrying the weights of the representation **4**. Over  $S \cap V(a_2)$ , the fiber  $I_4^{\text{ns}}$  degenerates to an incomplete fiber of type  $I_0^*$  carrying the weights of the representation **5**. The fibers  $I_5$  and  $I_0^*$  correspond respectively to the affine Dynkin diagram for  $A_4$  and  $D_4$ .

We would like to know if the branching rules  $A_4 \downarrow C_2$  and  $D_4 \downarrow C_2$  for the adjoint representation will output the representations **5** and **4** that we see geometrically by computing the weights of vertical rational curves appearing over the codimension-two loci  $S \cap V(4a_2a_{6,4} - a_{4,2}^2)$  and  $S \cap V(a_2)$ :

$$(A_4 \downarrow C_2) \stackrel{?}{\Longrightarrow} \mathbf{4}, \quad (6.7)$$

$$(D_4 \downarrow C_2) \stackrel{?}{\Longrightarrow} \mathbf{5}. \quad (6.8)$$

If that is the case, we will say that the Katz–Vafa method predicts the matter content **4** or **5** of the USp(4)-model.

The Lie algebra  $A_4$  has three types of maximal subalgebras, namely  $A_3$  (obtained by removing the node  $\alpha_1$  or  $\alpha_4$ ),  $A_1 \times A_2$  (obtained by removing one of the two interior nodes  $\alpha_2$  or  $\alpha_4$ ), and  $C_2$ , which is an  $S$ -algebra.

$$A_4 : \quad A_3, \quad A_1 \times A_2, \quad C_2. \quad (6.9)$$

The algebra  $C_2$  can be embedded in different ways as a subalgebra of  $A_4$  since  $C_2$  is also maximal subalgebra of  $A_3$

Under the reduction  $A_4 \downarrow C_2$  for a maximal subalgebra  $C_2$ , we have the following branching rule for the adjoint representation:

$$A_4 \downarrow C_2 : \quad \mathbf{24} = \mathbf{10} \oplus \mathbf{14}. \quad (6.10)$$

The representation **14** is irreducible and corresponds to  $\Gamma_{0,2}$ . It is clear that this embedding does not produce the representation **5** that we see geometrically.

The Lie algebra of type  $A_4$  also contains  $C_2$  as a non-maximal subalgebra appearing in the sequence of reduction combination  $A_4 \downarrow A_3 \downarrow C_2$ . In that case, the branching rule for the adjoint



representation can be derived by steps and gives<sup>6</sup>

$$A_4 \downarrow A_3 \downarrow C_2 : \quad \mathbf{24} = \mathbf{10} \oplus \mathbf{5} \oplus \mathbf{4} \oplus \mathbf{4} \oplus \mathbf{1}. \quad (6.11)$$

Here, we get both the representations **4** and **5**. However, that is in contradiction with the geometry of the USp(4)-model as at no point of the base we see both the weights of the representation **5** and the representation **4**.

The Lie algebra  $C_2$  can be embedded in  $D_4$  along many inequivalent channels defined by sequences of maximal embeddings:

$$\begin{cases} D_4 \downarrow B_3 \downarrow (\mathbf{u}_1 \oplus C_2) \downarrow C_2, & D_4 \downarrow (A_1 \oplus C_2) \downarrow C_2, \\ D_4 \downarrow B_3 \downarrow A_3 \downarrow C_2, & D_4 \downarrow (A_3 \oplus \mathbf{u}_1) \downarrow A_3 \downarrow C_2 \end{cases} \quad (6.12)$$

We denote the adjoint of  $D_4$  as **24**. In each channel, we end up with the branching rule:

$$\mathbf{28} = \mathbf{10} \oplus \mathbf{5} \oplus \mathbf{5} \oplus \mathbf{5} \oplus \mathbf{1} \oplus \mathbf{1} \oplus \mathbf{1}. \quad (6.13)$$

This branching rule produces the representation **5** in accordance with the geometric analysis. It follows that in this case, the geometry is compatible with the Katz–Vafa method.

## 6.4 SO(5)-model

The group USp(4) is isomorphic to Spin(5), the double-cover of the orthogonal group SO(5). There are representations of USp(4) that are only projective representations of SO(5), that is particularly the case of the spin representation **4**. The SO(5)-model is studied in [20] and has the following matter representation:

$$\mathbf{R} = \mathbf{10} \oplus \mathbf{5}. \quad (6.14)$$

In contrast to USp(4)-models, there is no representation **4** in the SO(5)-model. It follows that while the generic USp(4)-model has a matter content that is inconsistent with the Katz–Vafa method, the matter content of an SO(5)-model is consistent with the Katz–Vafa method.

## 6.5 General USp(2n)-model

The matter content of a general USp(2n)-model consists of the defining representation  $\mathbf{V}$ , the adjoint representation  $\mathbf{Adj} = \text{Sym}_0^2 \mathbf{V}$ , and the traceless antisymmetric representation  $\mathbf{\Lambda}_0^2$ :

$$\mathbf{R} = \mathbf{Adj} \oplus \mathbf{V} \oplus \mathbf{\Lambda}_0^2. \quad (6.15)$$

In a generic USp(2n)-model we expect to see the weights of the representations  $\mathbf{V}$  and  $\mathbf{\Lambda}_0^2$  carried by rational curves components of singular fibers localized at different points in codimension-two.

---

<sup>6</sup>We can understand this branching rule as follows [24]. Under the reduction  $A_4 \downarrow A_3$ , the adjoint of  $A_4$  decomposes as follows

$$A_4 \downarrow A_3 : \quad \mathbf{24} = \mathbf{15} \oplus \mathbf{4} \oplus \bar{\mathbf{4}} \oplus \mathbf{1}.$$

Under the reduction  $A_3 \downarrow C_2$ , the adjoint, the fundamental, and the anti-fundamental of  $A_3$  decomposes as

$$A_3 \downarrow C_2 : \quad \mathbf{15} \rightarrow \mathbf{10} \oplus \mathbf{5}, \quad \mathbf{4} \rightarrow \mathbf{4}, \quad \bar{\mathbf{4}} \rightarrow \mathbf{4}.$$

Hence, under  $A_4 \downarrow A_3 \downarrow C_2$ , we have

$$A_4 \downarrow A_3 \downarrow C_2 : \quad \mathbf{24} = \mathbf{10} \oplus \mathbf{5} \oplus \mathbf{4} \oplus \mathbf{4} \oplus \mathbf{1}.$$

The group  $\mathrm{USp}(2n)$  can also be embedded in  $\mathrm{SU}(2n+1)$  as a non-maximal subgroup sitting in a sequence of two maximal embeddings for all  $n \geq 2$ . For  $n = 2$ , we also have in addition that  $C_2$  can also be a maximal subalgebra of  $A_4$ . And this gives the additional option that we discussed in equation (6.10). Thus, we have the following branching rules for  $n \geq 2$  [24]:

$$A_{2n-1} \downarrow C_n : \quad \mathbf{adj} \mathrm{SU}(2n) = \mathbf{adj} \mathrm{USp}(2n) \oplus \mathbf{\Lambda}_0^2, \quad (6.16)$$

$$A_{2n} \downarrow A_{2n-1} \downarrow C_n : \quad \mathbf{adj} \mathrm{SU}(2n+1) = \mathbf{adj} \mathrm{USp}(2n) \oplus \mathbf{\Lambda}_0^2 \oplus \mathbf{V} \oplus \mathbf{V} \oplus \mathbf{1}, \quad (6.17)$$

$$A_4 \downarrow C_2 : \quad \mathbf{adj} \mathrm{SU}(5) = \mathbf{adj} \mathrm{USp}(4) \oplus \mathbf{W}, \quad \mathbf{W} = \Gamma_{0,2} = \mathbf{14}. \quad (6.18)$$

If  $n = 2$ , we recall that  $\mathbf{\Lambda}_0^2 = \mathbf{5}$  and  $\mathbf{V} = \mathbf{4}$ , and we are in the situation analyzed in section 6.3.

The embedding  $A_{2n-1} \downarrow C_n$  can describes the localized matter in the representation  $\mathbf{\Lambda}_0^2$  and matches what we see in the geometry over  $S \cap V(a_2)$ . The sequence  $A_{2n} \downarrow A_{2n-1} \downarrow C_n$  produces both  $\mathbf{V}$  and  $\mathbf{\Lambda}_0^2$  and therefore cannot correspond to localized matter as there are no points containing both weights. The representation  $\mathbf{14}$  coming from the branching rule for the maximal embedding  $A_4 \downarrow C_2$  does not match the geometry anywhere.

Grassi and Morrison proposed using the branching rule of equation (6.17) to explain the matter content of  $\mathrm{USp}(2n)$ -models [39]. The motivation behind the branching rules advocated in [39] is exploit the description of the Dynkin diagram of  $C_n$  of  $\mathrm{USp}(2n)$  as the folding of the Dynkin diagram  $A_{2n}$  of  $\mathrm{SU}(2n+1)$  via the  $\mathbb{Z}/2\mathbb{Z}$  outer automorphism. However, we point out that at no point over the base, we get both the representation  $\mathbf{V}$  and  $\mathbf{\Lambda}_0^2$ . Thus, that would not explain the localized matter observed geometrically as illustrated in Figure 5. The same conflict between the branching rules advocated in [39] and fiber geometry appears for the  $G_2$ ,  $F_4$ , and  $\mathrm{Spin}(2n+1)$ -models. Besides, when we are the the branching point, We refer to [24] for more information.

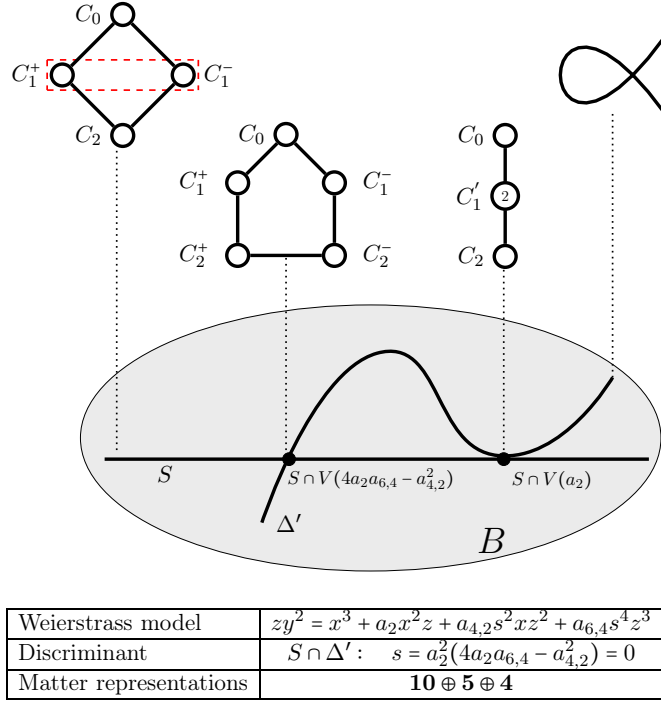

Figure 5: Geometry of the generic  $\text{USp}(4)$ -model for a two-dimensional base  $B$ .

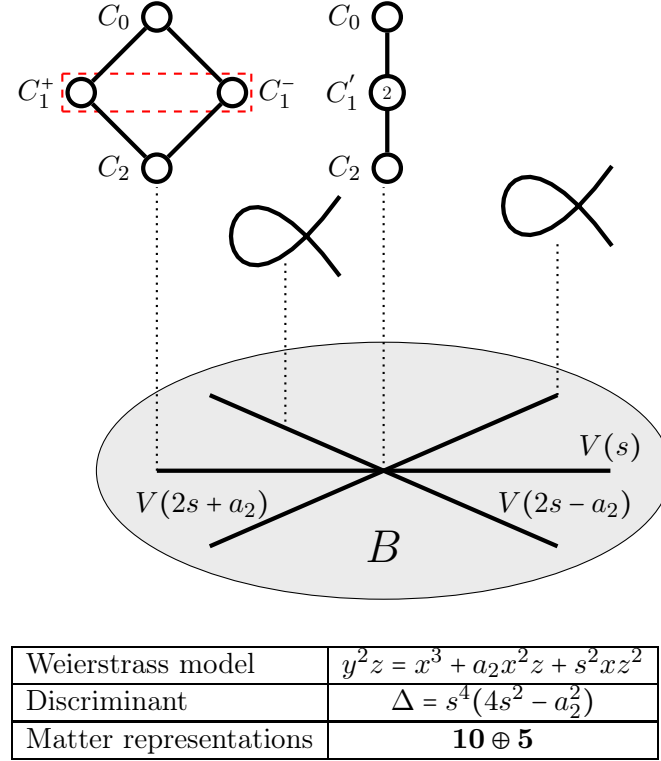

Figure 6: Summary of the geometry of the  $\text{SO}(5)$ -model as studied in [20].

## Acknowledgements

The authors are grateful to Ravi Jagadeesan, Monica Jinwoo Kang, Sabrina Pasterski, and Julian Salazar for discussions. M.E. is supported in part by the National Science Foundation (NSF) grant DMS-1406925 and DMS-1701635 ‘‘Elliptic Fibrations and String Theory’’. The research of P.J. is supported by the U.S. Department of Energy, Office of Science, Office of High Energy Physics of U.S. Department of Energy under grant Contract Numbers DE-SC0012567 and DE-SC0019127.

## A Weierstrass models and Deligne’s formulaire

In this section, we introduce the notation of Deligne [12]. Let  $\mathcal{L}$  be a line bundle over a normal quasi-projective variety  $B$ . We define the projective bundle of lines:

$$\pi : X_0 = \mathbb{P}_B[\mathcal{O}_B \oplus \mathcal{L}^{\otimes 2} \oplus \mathcal{L}^{\otimes 3}] \longrightarrow B. \quad (\text{A.1})$$

The relative projective coordinates of  $X_0$  over  $B$  are denoted  $[z : x : y]$ , where  $z$ ,  $x$ , and  $y$  are defined by the natural injection of  $\mathcal{O}_B$ ,  $\mathcal{L}^{\otimes 2}$ , and  $\mathcal{L}^{\otimes 3}$  into  $\mathcal{O}_B \oplus \mathcal{L}^{\otimes 2} \oplus \mathcal{L}^{\otimes 3}$ , respectively. Hence,  $z$  is a section of  $\mathcal{O}_{X_0}(1)$ ,  $x$  is a section of  $\mathcal{O}_{X_0}(1) \otimes \pi^* \mathcal{L}^{\otimes 2}$ , and  $y$  is a section of  $\mathcal{O}_{X_0}(1) \otimes \pi^* \mathcal{L}^{\otimes 3}$ .

**Definition A.1.** A Weierstrass model is an elliptic fibration  $\varphi : Y \rightarrow B$  cut out by the zero locus of a section of the line bundle  $\mathcal{O}_{X_0}(3) \otimes \pi^* \mathcal{L}^{\otimes 6}$  in  $X_0$ .

The most general Weierstrass equation is written in the notation of Tate as

$$y^2 z + a_1 x y z + a_3 y z^2 - (x^3 + a_2 x^2 z + a_4 x z^2 + a_6 z^3) = 0, \quad (\text{A.2})$$

where  $a_i$  is a section of  $\pi^* \mathcal{L}^{\otimes i}$ . The line bundle  $\mathcal{L}$  is called the *fundamental line bundle* of the Weierstrass model  $\varphi : Y \rightarrow B$ . It can be defined directly from  $Y$  as  $\mathcal{L} = R^1 \varphi_* Y$ . Following Tate and Deligne, we introduce the following quantities

$$\begin{cases} b_2 &= a_1^2 + 4a_2 \\ b_4 &= a_1 a_3 + 2a_4 \\ b_6 &= a_3^2 + 4a_6 \\ b_8 &= a_1^2 a_6 - a_1 a_3 a_4 + 4a_2 a_6 + a_2 a_3^2 - a_4^2 \\ c_4 &= b_2^2 - 24b_4 \\ c_6 &= -b_2^3 + 36b_2 b_4 - 216b_6 \\ \Delta &= -b_2^2 b_8 - 8b_4^3 - 27b_6^2 + 9b_2 b_4 b_6 \\ j &= c_4^3 / \Delta \end{cases} \quad (\text{A.3})$$

The  $b_i$  ( $i = 2, 3, 4, 6$ ) and  $c_i$  ( $i = 4, 6$ ) are sections of  $\pi^* \mathcal{L}^{\otimes i}$ . The discriminant  $\Delta$  is a section of  $\pi^* \mathcal{L}^{\otimes 12}$ . They satisfy the two relations

$$1728\Delta = c_4^3 - c_6^2, \quad 4b_8 = b_2 b_6 - b_4^2. \quad (\text{A.4})$$

Completing the square in  $y$  gives

$$zy^2 = x^3 + \frac{1}{4}b_2 x^2 + \frac{1}{2}b_4 x + \frac{1}{4}b_6. \quad (\text{A.5})$$

Completing the cube in  $x$  gives the short form of the Weierstrass equation

$$zy^2 = x^3 - \frac{1}{48}c_4 x z^2 - \frac{1}{864}c_6 z^3. \quad (\text{A.6})$$

## B Representations of $\mathrm{USp}(2n)$

The Lie algebra  $C_\ell$  is studied in Planche III of [9]. The Lie algebra  $C_\ell$  has rank  $\ell$ , Coxeter number  $2\ell$ , dimension  $\ell(2\ell + 1)$ , and  $\mathbb{Z}/2\mathbb{Z}$  center. Its root system consists of  $2\ell^2$  roots,  $2\ell$  of which are short roots. The Weyl group  $W(C_\ell)$  of  $C_\ell$  is the semi-direct product of the symmetric group  $\mathfrak{S}_\ell$  with the group  $(\mathbb{Z}/2\mathbb{Z})^\ell$ , hence, it has dimension  $2^\ell \ell!$

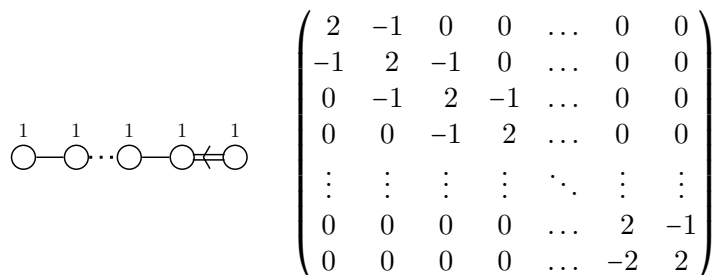

Figure 7: Dynkin diagram and Cartan matrix of  $C_\ell$ .

Reps	Tableau	Highest weight	Dimension	Properties
$\mathbf{V}$	$\square$	$(1, 0, 0, \dots, 0)$	$2n$	Pseudo-real, minuscule
$\Lambda_0^2$	$\square \square$	$(0, 1, 0, \dots, 0)$	$(n-1)(2n+1)$	Real
$\mathrm{Sym}_0^2 \mathbf{V} = \mathbf{adj}$	$\begin{array}{ c } \hline \square \\ \hline \end{array}$	$(2, 0, 0, \dots, 0)$	$n(2n+1)$	Real
$\mathbf{W} = \Gamma_{0,2,0,\dots,0}$	$\begin{array}{ c c } \hline \square & \square \\ \hline \end{array}$	$(0, 2, 0, \dots, 0)$	$n(2n+3)$	Real

Table 4: Some representations of  $\mathrm{USp}(2n)$  identified by their highest weight (in a base of fundamental weights), their Young tableaux, and their dimensions. The last row indicates if the representation is complex, real, or pseudo-real.

The group  $\mathrm{USp}(2n)$  is a maximal subgroup of  $\mathrm{SU}(2n)$  for all  $n \geq 2$ . The group  $\mathrm{USp}(4)$  is a special case as it is a maximal subgroup of both  $\mathrm{SU}(4)$  and  $\mathrm{SU}(5)$ . In general, the group  $\mathrm{USp}(2n)$  can also be embedded in  $\mathrm{SU}(2n+1)$  as a non-maximal subgroup sitting in a sequence of two maximal embeddings. Thus, we have the following two branching rules for  $n \geq 2$  [24]:

$$A_{2n-1} \downarrow C_n : \quad \mathbf{adj} \mathrm{SU}(2k) = \mathbf{adj} \mathrm{USp}(2k) \oplus \Lambda_0^2, \quad (\text{B.1})$$

$$A_{2n} \downarrow A_{2n-1} \downarrow C_n : \quad \mathbf{adj} \mathrm{SU}(2k+1) = \mathbf{adj} \mathrm{USp}(2k) \oplus \Lambda_0^2 \oplus \mathbf{V} \oplus \mathbf{V} \oplus \mathbf{1}. \quad (\text{B.2})$$

For  $n = 2$ , we also have in addition the maximal embedding

$$A_4 \downarrow C_2 : \quad \mathbf{adj} \mathrm{SU}(5) = \mathbf{adj} \mathrm{USp}(4) \oplus \mathbf{W}, \quad \mathbf{W} = \Gamma_{0,2}. \quad (\text{B.3})$$

The matter content of a  $\mathrm{USp}(2n)$ -model consists of the defining representation  $\mathbf{V}$ , the adjoint representation  $\mathbf{Adj} = \mathrm{Sym}_0^2 \mathbf{V}$ , and the traceless antisymmetric representation  $\mathbf{\Lambda}_0^2$ :

$$\mathbf{R} = \mathbf{Adj} \oplus \mathbf{V} \oplus \mathbf{\Lambda}_0^2. \quad (\text{B.4})$$

In a generic  $\mathrm{USp}(2n)$ -model we expect to see the weights of the representations  $\mathbf{V}$  and  $\mathbf{\Lambda}_0^2$  carried by rational curves components of singular fibers localized at different points. The sequence  $A_{2n} \downarrow A_{2n-1} \downarrow C_n$  produces both  $\mathbf{V}$  and  $\mathbf{\Lambda}_0^2$  and therefore cannot correspond to localized matter. The embedding  $A_{2n-1} \downarrow C_n$  can describe the localized matter in the representation  $\mathbf{\Lambda}_0^2$ .

The defining representation  $\mathbf{V}$  of  $C_n$  is also its shortest non-trivial representation; the representation  $\mathbf{V}$  is minuscule, pseudo-real, and of dimension  $2n$ . The traceless symmetric square  $\mathrm{Sym}_0^2 \mathbf{V}$  is irreducible, of dimension  $n(2n+1)$ , and corresponds to the adjoint representation. The second antisymmetric tensor product of  $\mathbf{V}$  is denoted  $\mathbf{\Lambda}^2$  and is not irreducible, but rather decomposes into a direct sum of the trivial representation and an irreducible representation of dimension  $(n-1)(2n+1)$  that we denote by  $\mathbf{\Lambda}_0^2$ . The trivial representation is given by the trace of the antisymmetric tensor (note that the trace is defined with respect to the antisymmetric symplectic metric) and the representation  $\mathbf{\Lambda}_0^2$  is the traceless antisymmetric projection of  $\mathbf{\Lambda}^2$ . The representation  $\mathbf{\Lambda}_0^2$  is irreducible, quasi-minuscule, and real. The representation  $\Gamma_{0,2,0,\dots,0}$  is irreducible of dimension  $n(2n+3)$ —see Table 4.

A Young tableau is a finite left-justified array of boxes with weakly decreasing row lengths. A Young tableau is uniquely identified by the list of the lengths of its rows. All the symmetric tensor products  $\mathbf{V}^{(k)} = \mathrm{Sym}^k \mathbf{V}$  are irreducible, but the exterior tensor products  $\mathbf{\Lambda}^k$  are not. However, the kernel of the contraction map  $\mathbf{\Lambda}^k \rightarrow \mathbf{\Lambda}^{k-2}$  induced by the invariant two-form of  $\mathrm{USp}(2n)$  is also an irreducible representation that we denote by  $\mathbf{\Lambda}_0^k$ . Irreducible representations of  $\mathrm{USp}(2n)$  are in one-to-one correspondence with traceless tensors satisfying the symmetries of a Young tableau with no more than  $n$  rows. The irreducible representations of  $\mathrm{USp}(2n)$  with highest weight  $\boxed{a_1 \cdots a_n}$  in the basis of fundamental weights is denoted by  $\Gamma_{a_1, a_2, \dots, a_n}$ . We have the restriction that all  $a_i \geq 0$ . The irreducible representation  $\Gamma_{a_1, a_2, \dots, a_n}$  corresponds to the Young tableau with rows of lengths  $(\ell_1, \dots, \ell_n)$  such that  $\ell_k = \sum_{i=k}^n a_i$  for  $k = 1, \dots, n$ .

## References

- [1] P. Aluffi and M. Esole, Chern class identities from tadpole matching in type IIB and F-theory. *JHEP*, 03:032, 2009.
- [2] P. Aluffi and M. Esole, New Orientifold Weak Coupling Limits in F-theory. *JHEP*, 02:020, 2010.
- [3] L. B. Anderson, M. Esole, L. Fredrickson and L. P. Schaposnik, Singular Geometry and Higgs Bundles in String Theory, *SIGMA* **14** (2018) 037. doi:10.3842/SIGMA.2018.037 [arXiv:1710.08453 [math.DG]].
- [4] P. S. Aspinwall and M. Gross, The  $\mathrm{SO}(32)$  heterotic string on a K3 surface, *Phys. Lett. B* **387**, 735 (1996)
- [5] P. S. Aspinwall, S. H. Katz and D. R. Morrison, Lie groups, Calabi-Yau threefolds, and F theory, *Adv. Theor. Math. Phys.* **4**, 95 (2000)
- [6] S. D. Avramis and A. Kehagias, A Systematic search for anomaly-free supergravities in six dimensions, *JHEP* **0510**, 052 (2005).

- [7] C. W. Bernard, N. H. Christ, A. H. Guth and E. J. Weinberg, Instanton Parameters for Arbitrary Gauge Groups, *Phys. Rev. D* **16**, 2967 (1977).
- [8] M. Bershadsky, K. A. Intriligator, S. Kachru, D. R. Morrison, V. Sadov, and C. Vafa, Geometric singularities and enhanced gauge symmetries. *Nucl. Phys.*, B481:215–252, 1996.
- [9] N. Bourbaki, *Groups and Lie Algebras. Chap. 4–6*, Translated from the 1968 French original. Elements of Mathematics (Berlin). Springer-Verlag, Berlin Heidelberg, 2002.
- [10] A. C. Cadavid, A. Ceresole, R. D’Auria and S. Ferrara, Eleven-dimensional supergravity compactified on Calabi-Yau threefolds, *Phys. Lett. B* **357**, 76 (1995)
- [11] A. Collinucci, F. Denef, and M. Esole. D-brane Deconstructions in IIB Orientifolds. *JHEP*, 02:005, 2009.
- [12] P. Deligne, Courbes élliptiques: formulaire d’après J. Tate. (French) *Modular functions of one variable, IV (Proc. Internat. Summer School, Univ. Antwerp, Antwerp, 1972)*, pp. 53–73. Lecture Notes in Math., Vol. 476, Springer, Berlin, 1975.
- [13] E. B. Dynkin, Semi-simple subalgebras of semi-simple Lie algebras, *Mat. Sb. (N.S.)*, 30 (72) (1952), pp. 349–462; English translation in: *Amer. Math. Soc. Transl.*, 6 (1957), pp. 111–244.
- [14] J. Erler, Anomaly cancellation in six-dimensions, *J. Math. Phys.* **35**, 1819 (1994)
- [15] M. Esole, J. Fullwood, and S.-T. Yau.  $D_5$  elliptic fibrations: non-Kodaira fibers and new orientifold limits of F-theory. *Commun. Num. Theor. Phys.* **09**, no. 3, 583 (2015).
- [16] M. Esole, S. G. Jackson, R. Jagadeesan, and A. G. Noël. Incidence Geometry in a Weyl Chamber I:  $GL_n$ , arXiv:1508.03038 [math.RT].
- [17] M. Esole, S. G. Jackson, R. Jagadeesan and A. G. Noël, Incidence Geometry in a Weyl Chamber II:  $SL_n$ , arXiv:1601.05070 [math.RT].
- [18] M. Esole, R. Jagadeesan and M. J. Kang, The Geometry of  $G_2$ ,  $Spin(7)$ , and  $Spin(8)$ -models, arXiv:1709.04913 [hep-th].
- [19] M. Esole, R. Jagadeesan and M. J. Kang, 48 Crepant Paths to  $SU(2) \times SU(3)$ , arXiv:1905.05174 [hep-th].
- [20] M. Esole and P. Jefferson, The Geometry of  $SO(3)$ ,  $SO(5)$ , and  $SO(6)$  models, arXiv:1905.12620 [hep-th].
- [21] M. Esole, P. Jefferson and M. J. Kang, Euler Characteristics of Crepant Resolutions of Weierstrass Models, arXiv:1703.00905 [math.AG].
- [22] M. Esole, M. J. Kang and S. T. Yau, A New Model for Elliptic Fibrations with a Rank One Mordell–Weil Group: I. Singular Fibers and Semi-Stable Degenerations, arXiv:1410.0003 [hep-th].
- [23] M. Esole, P. Jefferson and M. J. Kang, The Geometry of  $F_4$ -Models, arXiv:1704.08251 [hep-th].
- [24] M. Esole and M. J. Kang, to appear

- [25] M. Esole and M. J. Kang, Characteristic numbers of elliptic fibrations with non-trivial Mordell–Weil groups, arXiv:1808.07054 [hep-th].
- [26] M. Esole and M. J. Kang, Characteristic numbers of crepant resolutions of Weierstrass models, arXiv:1807.08755 [hep-th].
- [27] M. Esole and M. J. Kang, The Geometry of the  $SU(2) \times G_2$ -model, JHEP **1902** (2019) 091 doi:10.1007/JHEP02(2019)091 [arXiv:1805.03214 [hep-th]].
- [28] M. Esole and M. J. Kang, Flopping and Slicing:  $SO(4)$  and  $Spin(4)$ -models, arXiv:1802.04802 [hep-th].
- [29] M. Esole, M. J. Kang and S. T. Yau, Mordell–Weil Torsion, Anomalies, and Phase Transitions, arXiv:1712.02337 [hep-th].
- [30] M. Esole and S. Pasterski,  $D_4$ -flops of the  $E_7$ -model, arXiv:1901.00093 [hep-th].
- [31] M. Esole and S. Pasterski, The suspended pinch point and  $SU(2) \times U(1)$  gauge theories, arXiv:1906.07157 [hep-th].
- [32] M. Esole and R. Savelli, ‘Tate Form and Weak Coupling Limits in F-theory, JHEP **1306**, 027 (2013)
- [33] M. Esole and S. H. Shao, ‘M-theory on Elliptic Calabi-Yau Threefolds and 6d Anomalies,’ arXiv:1504.01387 [hep-th].
- [34] M. Esole, S.-H. Shao, and S.-T. Yau. Singularities and Gauge Theory Phases. *Adv. Theor. Math. Phys.*, 19:1183–1247, 2015.
- [35] M. Esole, S. H. Shao and S. T. Yau, Singularities and Gauge Theory Phases II, Adv. Theor. Math. Phys. 20, 683 (2016)
- [36] M. Esole and S. T. Yau, Small resolutions of  $SU(5)$ -models in F-theory, Adv. Theor. Math. Phys. 17, no. 6, 1195 (2013)
- [37] S. Ferrara, R. Minasian and A. Sagnotti, Low-energy analysis of M and F theories on Calabi-Yau threefolds, Nucl. Phys. B **474**, 323 (1996)
- [38] H. Hayashi, C. Lawrie, D. R. Morrison, and S. Schafer-Nameki. Box Graphs and Singular Fibers. *JHEP*, 1405:048, 2014.
- [39] A. Grassi and D. R. Morrison. Group representations and the Euler characteristic of elliptically fibered Calabi-Yau threefolds. *J. Algebraic Geom.*, 12(2):321–356, 2003.
- [40] J. J. Heckman and T. Rudelius, Top Down Approach to 6D SCFTs, J. Phys. A **52**, no. 9, 093001 (2019)
- [41] K. A. Intriligator, D. R. Morrison, and N. Seiberg. Five-dimensional supersymmetric gauge theories and degenerations of Calabi-Yau spaces. *Nucl.Phys.*, B497:56–100, 1997.
- [42] V. G. Kac. *Infinite-Dimensional Lie Algebras*, Third Edition. Cambridge University Press, Cambridge, 1990.



- [43] S. H. Katz and C. Vafa, “Matter from geometry,” Nucl. Phys. B **497**, 146 (1997) [hep-th/9606086].
- [44] V. Kumar, D. R. Morrison and W. Taylor, Global aspects of the space of 6D  $N = 1$  supergravities, JHEP **1011**, 118 (2010).
- [45] J. Marsano and S. Schafer-Nameki. Yukawas, G-flux, and Spectral Covers from Resolved Calabi-Yau’s. *JHEP*, 11:098, 2011.
- [46] D. R. Morrison and W. Taylor, Matter and singularities, JHEP **1201**, 022 (2012)
- [47] D. R. Morrison and W. Taylor, Classifying bases for 6D F-theory models, Central Eur. J. Phys. **10**, 1072 (2012)
- [48] D. R. Morrison and C. Vafa. Compactifications of F theory on Calabi-Yau threefolds. 1. *Nucl. Phys.*, B473:74–92, 1996.
- [49] D. R. Morrison and C. Vafa. Compactifications of F theory on Calabi-Yau threefolds. 2. *Nucl. Phys.*, B476:437–469, 1996.
- [50] D. S. Park, Anomaly Equations and Intersection Theory, JHEP **1201**, 093 (2012)
- [51] W. G. McKay and J. Patera. Tables of dimensions, indices, and branching rules for representations of simple Lie algebras. Marcel Dekker Inc., New York, 1981.
- [52] V. Sadov, Generalized Green-Schwarz mechanism in F theory, Phys. Lett. B **388**, 45 (1996).
- [53] A. Sagnotti, A Note on the Green-Schwarz mechanism in open string theories, Phys. Lett. B **294**, 196 (1992)
- [54] S. Randjbar-Daemi, A. Salam, E. Sezgin and J. A. Strathdee, An Anomaly Free Model in Six-Dimensions, Phys. Lett. **151B**, 351 (1985).
- [55] J. H. Schwarz, Anomaly - free supersymmetric models in six-dimensions, Phys. Lett. B **371**, 223 (1996)
- [56] R. Slansky, “Group Theory for Unified Model Building,” Phys. Rept. **79**, 1 (1981).
- [57] P. van Nieuwenhuizen, Anomalies in Quantum Field Theory: Cancellation of Anomalies in  $d=10$  Supergravity, Leuven University Press, Leuven (1988).
- [58] C. Vafa. Evidence for F theory. *Nucl. Phys.*, B469:403–418, 1996.
- [59] T. van Ritbergen, A. N. Schellekens and J. A. M. Vermaseren, Group theory factors for Feynman diagrams, Int. J. Mod. Phys. A **14**, 41 (1999)
- [60] A. Van Proeyen, Tools for supersymmetry, Ann. U. Craiova Phys. **9**, no. I, 1 (1999) [hep-th/9910030].
- [61] R. Wazir. Arithmetic on elliptic threefolds. *Compositio Mathematica*, 140(03):567–580, 2004.
- [62] N. Yamatsu, Finite-Dimensional Lie Algebras and Their Representations for Unified Model Building, arXiv:1511.08771 [hep-ph].