

# Entanglement-Breaking Superchannels

Senrui Chen<sup>1,2,\*</sup> and Eric Chitambar<sup>3,†</sup>

<sup>1</sup>*Department of Electronic Engineering,  
Tsinghua University, Beijing 100084, China*

<sup>2</sup>*Center for Quantum Information, Institute for Interdisciplinary Information Sciences,  
Tsinghua University, Beijing 100084, China*

<sup>3</sup>*Department of Electrical and Computer Engineering, Coordinated Science Laboratory,  
University of Illinois at Urbana-Champaign, Urbana, IL 61801*

(Dated: October 11, 2019)

## Abstract

In this paper we initiate the study of entanglement-breaking superchannels. These are processes that always yield separable maps when acting on one side of a bipartite completely positive (CP) map. Entanglement-breaking superchannels are a generalization of the well-known entanglement-breaking channels. Unlike its channel counterpart, we find that not every entanglement-breaking superchannel can be implemented as a measure-and-prepare superchannel. We also demonstrate that many entanglement-breaking superchannels can be superactivated, in the sense that they can output non-separable channels when wired in series.

We then introduce the notions of CPTP- and CP-complete images of a superchannel, which capture deterministic and probabilistic channel convertibility, respectively. This allows us to characterize the power of entanglement-breaking superchannels for generating CP maps in different scenarios, and it reveals some fundamental differences between channels and superchannels. Finally, we relax the definition of separable channels to include  $(p, q)$ -non-entangling channels, which are bipartite channels that cannot generate entanglement using  $p$ - and  $q$ -dimensional ancillary systems. By introducing and investigating  $k$ -entanglement breaking maps, we construct examples of  $(p, q)$ -entanglement-breaking superchannels that are not fully entanglement breaking. Partial results on the characterization of  $(p, q)$ -entanglement-breaking superchannels are also provided.

---

\* csenrui@gmail.com

† echitamb@illinois.edu

## I. INTRODUCTION

Suppose that Alice and Rachel have access to some bipartite quantum channel  $\mathcal{E}^{A_0 R_0 \rightarrow A_1 R_1}$ . They are interested in using this channel to generate entangled states across their spatially separated laboratories. As shown in Fig. 1, the most general method for doing so would involve using local quantum memories. Alice prepares a locally entangled state  $\rho^{A_0 A_E}$ , with  $A_E$  being her memory register, and Rachel does likewise with the state  $\omega^{R_0 R_E}$ . Sending systems  $A_0$  and  $R_0$  through the channel leads to the state

$$\sigma^{A_E A_1 : R_E R_1} = \text{id}^{A_E R_E} \otimes \mathcal{E}^{A_0 R_0 \rightarrow A_1 R_1} \left( \rho^{A_0 A_E} \otimes \omega^{R_0 R_E} \right),$$

which they hope is entangled. It is known that such a procedure can be used to generate entanglement if and only if  $\mathcal{E}^{A_0 R_0 \rightarrow A_1 R_1}$  does not have the form of a so-called *separable* channel [1]. Hence for Alice and Rachel's goal of obtaining bipartite entangled states, separable channels are completely useless.

Frustrated with the situation, Alice naively wonders if manipulating her part of the channel could improve their prospects of obtaining entanglement. Any physical procedure she attempts can be described as in Fig. 2; it involves her first applying some pre-processing map that couples her input system  $A_0$  to the memory register  $A_E$ , and then applying a post-processing map to system  $A_E$  and her channel output  $A_1$  [2]. Such a process is known as a superchannel, and specifically here it is a local superchannel since it is being implemented only in Alice's laboratory. Unfortunately for Alice, local superchan-

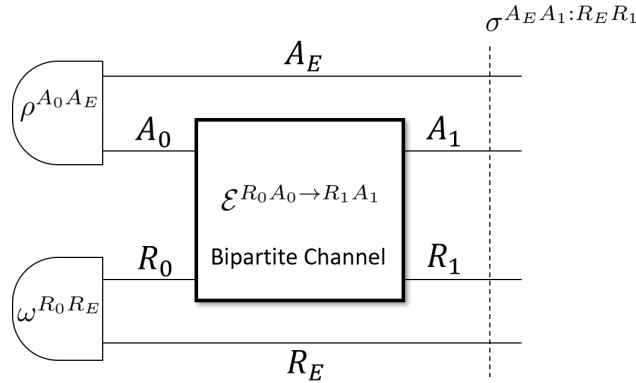

Figure 1. Alice and Rachel can use their bipartite channel  $\mathcal{E}$  with local quantum memories to generate entanglement in  $\sigma^{A_E A_1 : R_E R_1}$  if and only if  $\mathcal{E}$  is not a separable channel.

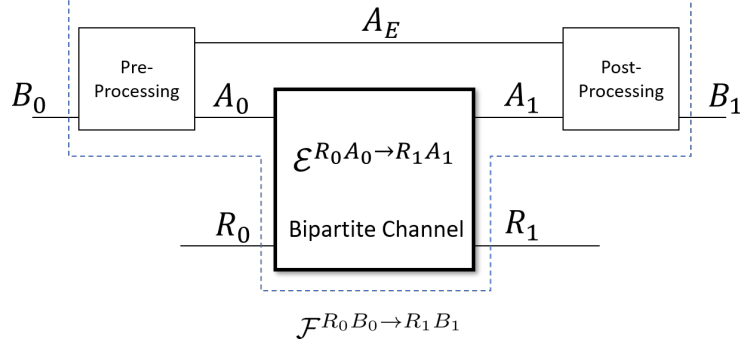

Figure 2. A local superchannel transforms  $\mathcal{E}^{R_0 A_0 \rightarrow R_1 A_1}$  into  $\mathcal{F}^{R_0 B_0 \rightarrow R_1 B_1}$ . An entanglement-breaking superchannel will output a separable channel for every initial channel.

nels are not able to transform a separable channel into a non-separable one. Consequently, if  $\mathcal{E}^{A_0 R_0 \rightarrow A_1 R_1}$  is useless for entanglement generation before Alice’s manipulation, it will be useless after. On the other hand, it is quite possible that a local superchannel converts a non-separable channel into a separable one. This begs the question of whether there exists certain local superchannels for Alice that convert *every* bipartite channel into a separable channel. We refer to such processes as *entanglement-breaking superchannels* since they completely eliminate any channel’s ability to distribute entanglement, and they are the focus of this paper.

Entanglement-breaking superchannels (EBSCs) generalize the class of entanglement-breaking channels (EBCs), a well-studied object within quantum information theory [3]. A channel  $\mathcal{N}^{A_1 \rightarrow B_1}$  is called entanglement breaking (EB) if  $\text{id}^{R_1} \otimes \mathcal{N}^{A_1 \rightarrow B_1}(\rho^{R_1 A_1})$  is separable for every  $\rho^{R_1 A_1}$  and all systems  $R_1$ . That an EBC is a special case of an EBSC comes from the fact that every quantum state can be regarded as a quantum channel with a one-dimensional input. An EBC  $\mathcal{N}^{A_1 \rightarrow B_1}$  can then be seen as an EBSC that locally transforms quantum channels with trivial input (see Fig. 3).

A central theorem is that every EBC can be realized by a measure-and-prepare protocol. That is,  $\mathcal{N}^{A_1 \rightarrow B_1}$  is EB if and only if there exists a measurement described by positive operator-valued measure (POVM)  $\{F_k^{A_1}\}_k$  along with a family of states  $\{\omega_k^{B_1}\}_k$  such that

$$\mathcal{N}^{A_1 \rightarrow B_1}(\rho^{A_1}) = \sum_k \text{Tr}[F_k^{A_1} \rho^{A_1}] \omega_k^{B_1} \quad (1)$$

for all states  $\rho^{A_1}$  of system  $A_1$ . The interpretation is that the EBC  $\mathcal{N}^{A_1 \rightarrow B_1}$  can be imple-

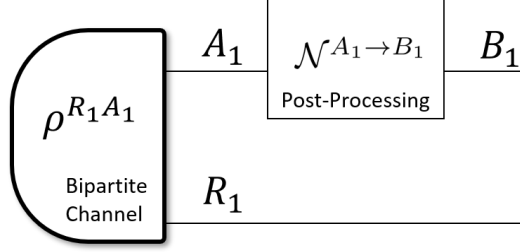

Figure 3. A state  $\rho^{R_1 A_1}$  represents a special type of bipartite channel, and a standard EBC can be seen as an EBSC post-processing map.

mented simply by first measuring system  $A_1$  with POVM  $\{F_k^{A_1}\}_k$  and then preparing the state  $\omega_k^{B_1}$  contingent on outcome  $k$ . A chief question of interest in this paper is whether there exists a similar type of implementation for EBSCs. We find that obvious forms of EBSC implementation fail to capture the entire class of EBSCs, including the generalization of measure-and-prepare channels to superchannels.

The study of EBSCs falls within the broader research program of understanding dynamical quantum resources. A quantum resource theory (QRT) describes a generic framework for isolating some particular feature of a quantum system, like entanglement or coherence, and analyzing how that feature, or “resource”, behaves under a restricted set of operations [4]. Most attention has been previously devoted to studying static resources, that is features that arise in particular states of a quantum system. However, recently, significant progress has been made in developing the theory of *dynamical* quantum resources, which refer to certain properties of quantum channels that are of interest for quantum information processing [5–9]. For example, in the QRT of entanglement for bipartite channels [10, 11], a channel’s ability to distribute entanglement is a resource, and when separable processing is taken as free, an EBSC can be interpreted as a one-sided resource-erasing map.

The paper is organized as follows. In Section II we fix notations and provide necessary preliminaries. In Section III we formally define entanglement-breaking superchannels and give several equivalent characterizations. We also characterize a subset of EBSCs which allows for intuitive pre/post-processing realizations. In Section IV we show how two copies of an EBSC can be combined to no longer be an EBSC, thereby demonstrating a type of superactivation. In Section V we introduce the notion of CPTP and CP-complete

image and consider what is the largest set of CPTP (CP) maps that can be generated through the action of EBSC, as well as two important subsets of EBSC. In Section VI, we generalize EBSCs to superchannels that output  $k$ -non-entangling maps, and we connect these superchannels to the family of  $k$ -entanglement-breaking maps, the latter being a type of map that we introduce and thoroughly discuss. We summarize our results and conclude with some discussion in Sec. VII.

## II. PRELIMINARIES

### A. Notations

Throughout this paper we adopt most of the notation used by Gour in Ref. [10]. We use capital Latin letters  $A, B, C$ , etc. to denote physical systems, and  $\mathcal{H}^A, \mathcal{H}^B, \mathcal{H}^C$ , etc. to denote their corresponding Hilbert space. Sometimes we also use capital letters to denote Hilbert spaces for simplicity. The collection of all bounded operators on system  $A$  will be denoted by  $\mathcal{B}(A)$ , all hermitian operators by  $\text{Herm}(A)$ , all positive operators by  $\mathcal{P}(A)$ , and all density matrices by  $\mathcal{D}(A)$ . The set of all linear maps from  $\mathcal{B}(A)$  to  $\mathcal{B}(B)$  will be denoted as  $\mathcal{L}(A \rightarrow B)$ , among which all completely-positive maps (CP) and all completely-positive and trace-preserving maps (CPTP) are denoted as  $\text{CP}(A \rightarrow B)$  and  $\text{CPTP}(A \rightarrow B)$ , respectively. A CPTP map is also called a quantum channel.

Since we are considering here dynamical resources, we will always assume that a system  $A$  has an associated input and an output system, denoted by  $A_0, A_1$ , respectively. Therefore, we can use the shorthand notation  $\mathcal{L}(A) := \mathcal{L}(A_0 \rightarrow A_1)$ ,  $\text{CP}(A) := \text{CP}(A_0 \rightarrow A_1)$ , etc. A linear map from  $\mathcal{L}(A)$  to  $\mathcal{L}(B)$  is called a supermap, and the set of all such supermaps will be denoted by  $\mathbb{L}(A \rightarrow B)$ . The action of a supermap will be written as a square bracket, like  $\Phi[\mathcal{E}]$ , whereas the action of quantum channel will usually denoted by round brackets, like  $\mathcal{E}(\rho)$ .

Finally, we use  $\tilde{A}$  to denote a system with the same dimension of  $A$ , and  $\phi_+^{\tilde{A}A} = \sum_{i,j=1}^{d_A} |ii\rangle\langle jj|$  is the unnormalized maximally entangled state on space  $\tilde{A}A$ . If  $\mathcal{E}^{A_0 \rightarrow A_1}$

is a quantum channel, then its Choi matrix is the operator defined by

$$J_{\mathcal{E}}^{A_0 A_1} := \text{id}^{A_0} \otimes \mathcal{E}^{\tilde{A}_0 \rightarrow A_1}(\phi_+^{A_0 \tilde{A}_0}). \quad (2)$$

## B. Separable and Entanglement-Breaking Maps

We next review the meaning of separable and entanglement-breaking maps.

**Definition II.1.** A CP map  $\mathcal{E} \in \text{CP}(A_0 R_0 \rightarrow A_1 R_1)$  is called  $A_0 A_1 : R_0 R_1$  *separable* if it can be written as  $\mathcal{E} = \sum_k \Phi_k \otimes \Psi_k$  for some  $\Phi_k \in \text{CP}(A_0 \rightarrow A_1)$  and  $\Psi_k \in \text{CP}(R_0 \rightarrow R_1)$ .

It is not difficult to see that  $\mathcal{E}^{A_0 R_0 \rightarrow A_1 R_1}$  is separable iff its Choi matrix

$$J_{\mathcal{E}}^{A_0 R_0 A_1 R_1} := \text{id}^{A_0 R_0} \otimes \mathcal{E}^{\tilde{A}_0 \tilde{R}_0 \rightarrow A_1 R_1}(\phi_+^{A_0 \tilde{A}_0} \otimes \phi_+^{R_0 \tilde{R}_0}) \quad (3)$$

is  $A_0 A_1 : R_0 R_1$  separable [1]. This means that we can write  $J_{\mathcal{E}}^{A_0 A_1 : R_0 R_1} = \sum_k M_k \otimes N_k$  for some  $M_k \in \mathcal{P}(A_0 A_1)$  and  $N_k \in \mathcal{P}(R_0 R_1)$ . As alluded to in the introduction, separability of  $\mathcal{E}^{A_0 R_0 \rightarrow A_1 R_1}$  means that it cannot be used for distributing entanglement between Alice and Rachel, and this fact can be most easily established by examining its Choi matrix and using the identity  $\mathcal{E}(\rho) = \text{Tr}_{A_0 A_1}[(\rho^{A_0 R_0})^T \otimes I^{A_1 R_1} J_{\mathcal{E}}^{A_0 R_0 A_1 R_1}]$ .

A close cousin to the separable maps are those that are entanglement breaking.

**Definition II.2.** [3] A CP map  $\mathcal{N} \in \text{CP}(A_1 \rightarrow B_1)$  is called *entanglement breaking* (EB) if  $\text{id}^{R_1} \otimes \mathcal{N}^{A_1 \rightarrow B_1}(\rho^{R_1 A_1})$  is separable for any  $\rho^{R_1 A_1}$  and any system  $R_1$ . An EB map  $\mathcal{N}$  is called an *entanglement breaking channel* (EBC) if it is also trace-preserving.

The following provides different characterizations of EB maps and clarifies the relationship between EB and separable maps.

**Proposition 1.** For a CP map  $\mathcal{N}^{A_1 \rightarrow B_1}$ , the following are equivalent.

- (A)  $\mathcal{N}^{A_1 \rightarrow B_1}$  is EB.
- (B) Its Choi matrix  $J_{\mathcal{N}}^{A_1 B_1}$  is  $A_1 : B_1$  separable.
- (C)  $\mathcal{N}^{A_1 \rightarrow B_1}$  has an implementation given by Eq. (1) for  $\sum_k F_k \leq I$ , with equality holding when  $\mathcal{N}^{A_1 \rightarrow B_1}$  is trace-preserving.

(D) For any system  $R$  and any bipartite channel  $\mathcal{E}^{R_0 B_1 \rightarrow R_1 A_1}$ , the composition  $\mathcal{F}^{R_0 A_1 \rightarrow R_1 B_1} = \mathcal{N}^{A_1 \rightarrow B_1} \circ \mathcal{E}^{R_0 B_1 \rightarrow R_1 A_1} \circ \mathcal{N}^{A_1 \rightarrow B_1}$  is a separable map.

*Proof.* Items (A)–(C) are standard results found in Ref. [3]. From the form of Eq. (1), it is easy to see that  $J_{\mathcal{F}}^{R_0 A_1 R_1 B_1}$  is  $R_0 R_1 : A_1 B_1$  separable whenever  $\mathcal{N}$  is EB, and so (A)  $\Rightarrow$  (D). Conversely, if (D) holds for all bipartite channels  $\mathcal{E}^{R_0 B_1 \rightarrow R_1 A_1}$ , then by considering the discard-and-prepare channel  $\mathcal{E}(X^{R_0 B_1}) = \text{Tr}[X] \frac{1}{d_{A_1}} \phi_+^{R_1 A_1}$  for  $R_1 \cong A_1$ , we see that  $\mathcal{F}^{R_0 A_1 \rightarrow R_1 B_1}$  is proportional to  $J_{\mathcal{N}}$ . Separability of  $\mathcal{F}$  then implies that  $\mathcal{N}$  is EB; hence (D)  $\Rightarrow$  (A).  $\square$

**Remark:** In Section III C, we will see that the channel  $\mathcal{F}^{R_0 A_1 \rightarrow R_1 B_1}$  constructed in (D) of this proposition is the output of a conditional prepare-and-measure superchannel  $\mathcal{E} \mapsto \mathcal{N} \circ \mathcal{E} \circ \mathcal{N}$ .

### C. Superchannels

We next review the basic structure of superchannels. The following definitions and theorems can be found in [12].

**Definition II.3.** [2, 12] A supermap  $\Theta \in \mathcal{L}(A \rightarrow B)$  is called a **superchannel** if both of the following are satisfied:

1.  $\Theta$  is completely CP preserving:  $\mathbb{1}^R \otimes \Theta[\mathcal{E}^{R A}]$  is completely positive for any CP map  $\mathcal{E}$  and arbitrarily large system  $R$ .
2.  $\Theta$  is TP preserving:  $\Theta[\mathcal{E}]$  is trace preserving for every TP map  $\mathcal{E}$ .

The Choi matrix of a supermap  $\Theta^{A \rightarrow B}$  is defined as

$$\mathcal{J}_{\Theta}^{AB} = \sum_{a_0, a_1} J_{\mathcal{E}_{a_0 a_1}}^A \otimes J_{\Theta[\mathcal{E}_{a_0 a_1}]}^B, \quad (4)$$

where  $J_{\mathcal{E}_{a_0 a_1}}^A$  and  $J_{\Theta[\mathcal{E}_{a_0 a_1}]}^B$  are Choi matrix of  $\mathcal{E}_{a_0 a_1} \in \mathcal{L}(A)$  and  $\Theta[\mathcal{E}_{a_0 a_1}] \in \mathcal{L}(B)$  respectively, and  $\{\mathcal{E}_{a_0 a_1}\}_{a_0, a_1}$  is a complete orthogonal basis of  $\mathcal{L}(A)$  whose action in the computational basis is given by

$$\mathcal{E}_{ijkl}(\rho^{A_0}) = \langle i | \rho^{A_0} | j \rangle | k \rangle \langle l |^{A_1}. \quad (5)$$

Alternatively,  $\mathcal{J}_{\Theta}^{AB}$  equals the Choi matrix of  $(\mathbb{1}^A \otimes \Theta^{\tilde{A} \rightarrow B})[\Phi_+^{A\tilde{A}}]$ , where

$$\Phi_+^{A\tilde{A}} \equiv \sum_{a_0, a_1} \mathcal{E}_{a_0 a_1}^A \otimes \mathcal{E}_{a_0 a_1}^{\tilde{A}}. \quad (6)$$

The action of  $\Phi_+^{A\tilde{A}}$  can be expressed as

$$\Phi_+^{A\tilde{A}}(\rho^{A_0 \tilde{A}_0}) = \text{Tr}(\rho \phi_+^{A_0 \tilde{A}_0}) \phi_+^{A_1 \tilde{A}_1}, \quad (7)$$

and hence it can be viewed as a maximally entangled map, in analog with  $\phi_+$ . But notice that  $\Phi_+$  is not trace-preserving and hence not a quantum channel.

Similar to the channel-state duality, there is a one-to-one correspondence between supermaps and their Choi matrix. For  $\Theta \in \mathcal{L}(A \rightarrow B)$  and  $\mathcal{E} \in \mathcal{L}(A)$ , we have

$$J_{\Theta[\mathcal{E}]}^B = \text{Tr}_A \left( \mathcal{J}_{\Theta}^{AB} \left( (J_{\mathcal{E}}^A)^T \otimes I^B \right) \right). \quad (8)$$

Define  $\Delta_{\Theta} \in \mathcal{L}(A \rightarrow B)$  to be the unique map that satisfies  $J_{\Delta_{\Theta}} = \mathcal{J}_{\Theta}^{AB}$ , and so  $\Delta_{\Theta}(J_{\mathcal{E}}^A) = J_{\Theta[\mathcal{E}]}^B$ .

**Lemma II.1.** [2, 12] *Let  $\Theta \in \mathcal{L}(A \rightarrow B)$ . The following are equivalent.*

1.  $\Theta$  is a superchannel.
2. The Choi matrix  $\mathcal{J}_{\Theta}^{AB} \geq 0$  with marginals

$$\mathcal{J}_{\Theta}^{A_1 B_0} = I^{A_1 B_0}; \quad \mathcal{J}_{\Theta}^{A B_0} = \mathcal{J}^{A_0 B_0} \otimes u^{A_1} \quad (9)$$

where  $u^{A_1} \equiv \frac{1}{d_{A_1}} I^{A_1}$  is the normalized maximally mixed state on  $A_1$ .

3. There exists a Hilbert space  $\mathcal{H}_E$  with  $d_E \leq d_{A_0} d_{B_0}$ , and two CPTP maps  $\Gamma_{pre}^{B_0 \rightarrow A_0 E}$  and  $\Gamma_{post}^{A_1 E \rightarrow B_1}$  such that for all linear map  $\mathcal{E}^A$ ,

$$\Theta[\mathcal{E}^A] = \Gamma_{post}^{A_1 E \rightarrow B_1} \circ \left( \mathcal{E}^A \otimes \mathbb{1}^E \right) \circ \Gamma_{pre}^{B_0 \rightarrow A_0 E} \quad (10)$$

Furthermore, if we define  $\Gamma_{\Theta}^{A_1 B_0 \rightarrow A_0 B_1} = \Gamma_{post}^{A_1 E \rightarrow B_1} \circ \Gamma_{pre}^{B_0 \rightarrow A_0 E}$ , then it has been shown that



$J_{\Gamma_{\Theta}} = \mathcal{J}_{\Theta}^{AB}$ . To summarize, the Choi matrix of the superchannel  $\Theta$  is equal to the Choi matrix of three different CP maps:  $\Theta^{\tilde{A} \rightarrow B}[\Phi_{+}^{A\tilde{A}}]$ ,  $\Delta_{\Theta}^{A \rightarrow B}$ , and  $\Gamma_{\Theta}^{A_1 B_0 \rightarrow A_0 B_1}$ , as defined above.

### III. CHARACTERIZATION AND REALIZATIONS OF EBSCS

#### A. Characterization of EBSCs

With the background concepts in place from the previous section, we are now able to introduce the notion of an entanglement-breaking superchannel.

**Definition III.1.** *A superchannel  $\Theta^{A \rightarrow B}$  is called **entanglement-breaking superchannel (EBSC)** if  $\mathbb{1}^R \otimes \Theta[\mathcal{E}^{RA}]$  is a separable map for every  $\mathcal{E} \in CP(RA)$ , with  $R$  being an arbitrary finite-dimensional system.*

Our first result provides several equivalent characterizations of EBSCs, in analogy to Proposition 1 for EBCs. However, despite the similarity between the following theorem and Proposition 1, we will see that there are some fundamental differences between EBSCs and EBCs. In particular, there is evidently no simple implementation result for EBSCs like statement (C) in Proposition 1.

**Theorem 1.** *For a superchannel  $\Theta^{A \rightarrow B}$ , the followings are equivalent.*

- (A)  $\Theta^{A \rightarrow B}$  is EBSC.
- (B)  $\mathbb{1}^A \otimes \Theta^{\tilde{A} \rightarrow B}[\Phi_{+}^{A\tilde{A}}]$  is separable for  $\Phi_{+}^{A\tilde{A}}(\rho) = \text{Tr}(\rho \phi_{+}^{A_0 \tilde{A}_0}) \phi_{+}^{A_1 \tilde{A}_1}$ .
- (C)  $\mathcal{J}_{\Theta}^{AB}$  is separable with respect to  $A : B$ .
- (D)  $\Theta$  can be realized with pre/post-processing CPTP maps  $\Gamma_{pre}^{B_0 \rightarrow A_0 E}$  and  $\Gamma_{post}^{A_1 E \rightarrow B_1}$  such that  $\Gamma_{\Theta}^{A_1 B_0 \rightarrow A_0 B_1} := \Gamma_{post}^{A_1 E \rightarrow B_1} \circ \Gamma_{pre}^{B_0 \rightarrow A_0 E}$  is a separable map (with respect to  $A_1 A_0 : B_0 B_1$ ).
- (E)  $\Delta_{\Theta} \in \mathcal{L}(A \rightarrow B)$  defined as the unique map with Choi matrix  $J_{\Theta}^{AB}$  is an entanglement breaking map.

Sketch of the proof of theorem 1: (B), (D), (E) correspond to three different CP maps that has the same choi matrix as  $\Theta$ , as discussed in Sec. II, so it's easy to show they are equivalent to (C). (A)  $\Rightarrow$  (B) is by definition of EBSC. (C)  $\Rightarrow$  (A) can be shown by considering the Choi matrix of  $\mathbb{1} \otimes \Theta[\mathcal{E}]$  for any bipartite CP map  $\mathcal{E}$ .

*Proof.* (A)  $\Rightarrow$  (B) is by Def. III.1 of EBSC.  $\mathbb{1}^A \otimes \Theta^{\tilde{A} \rightarrow B}[\Phi_+^{A\tilde{A}}]$  is separable if and only if its Choi matrix  $J_{\mathbb{1} \otimes \Theta[\Phi_+^{A\tilde{A}}]}$  is separable with respect to  $A : B$ . Since  $\mathcal{J}_\Theta^{AB} = J_{\mathbb{1} \otimes \Theta[\Phi_+^{A\tilde{A}}]}$  by definition, we see that (B)  $\Leftrightarrow$  (C).

We now prove (C)  $\Rightarrow$  (A). For any bipartite map  $\mathcal{E}^{RA} \in \text{CP}(R_0A_0 \rightarrow R_1A_1)$ , according to Eq. (8), we have

$$J_{\mathbb{1} \otimes \Theta[\mathcal{E}]}^{\tilde{R}B} = \text{Tr}_{RA} \left( \mathcal{J}_{\mathbb{1} \otimes \Theta}^{RA\tilde{R}B} \left( (J_{\mathcal{E}}^{RA})^T \otimes I^{\tilde{R}B} \right) \right) \quad (11)$$

$$= \text{Tr}_{RA} \left( \left( \phi_+^{R_0\tilde{R}_0} \otimes \phi_+^{R_1\tilde{R}_1} \otimes \mathcal{J}_\Theta^{AB} \right) \left( (J_{\mathcal{E}}^{RA})^T \otimes I^{\tilde{R}B} \right) \right) \quad (12)$$

$$= \text{Tr}_B \left( \mathcal{J}_\Theta^{AB} \left( (J_{\mathcal{E}}^{\tilde{R}A})^{\Gamma_A} \otimes I^B \right) \right), \quad (13)$$

where the superscript  $\Gamma_A$  denotes partial transpose on system A. Since system R is actually unchanged, let  $\tilde{R} = R$  and rewrite this equation as

$$J_{\mathbb{1} \otimes \Theta[\mathcal{E}]}^{RB} = \text{Tr}_A \left( \mathcal{J}_\Theta^{AB} \left( J_{\mathcal{E}}^{RA} \right)^{\Gamma_A} \right), \quad (14)$$

where we omit the identity operator. Now that  $\mathcal{J}_\Theta^{AB}$  is separable, which means it can be written as

$$\mathcal{J}_\Theta^{AB} = \sum_{k=1}^K M_k^A \otimes N_k^B \quad (15)$$

for some  $M_k^A \in \mathcal{P}(A)$ ,  $N_k^B \in \mathcal{P}(B)$ , and positive integer  $K$ . Substitute into Eq. (14), we get

$$J_{\mathbb{1} \otimes \Theta[\mathcal{E}]}^{RB} = \sum_k \text{Tr}_A \left( M_k^A \left( J_{\mathcal{E}}^{RA} \right)^{\Gamma_A} \right) \otimes N_k^B, \quad (16)$$

which means  $J_{\mathbb{1} \otimes \Theta[\mathcal{E}]}^{RB}$  is separable, hence  $\mathbb{1}^R \otimes \Theta^{A \rightarrow B}[\mathcal{E}^{RA}]$  is separable. Since  $\mathcal{E}^{RA}$  is an arbitrary bipartite CP map, we conclude that  $\Theta$  is EBSC, which completes the proof of (C)  $\Rightarrow$  (A).

This has established the equivalence (A)  $\Leftrightarrow$  (B)  $\Leftrightarrow$  (C). As for the equivalence of (C), (D), (E), we know that the Choi matrix of  $\Gamma_\Theta^{A_1B_0 \rightarrow A_0B_1}$  and  $\Delta_\Theta^{A \rightarrow B}$  are both  $\mathcal{J}_\Theta^{AB}$ , as shown in the last section. Therefore, the separability of  $\mathcal{J}_\Theta^{AB}$  with respect to  $A : B$  is equivalent to the separability of  $\Gamma_\Theta^{A_1B_0 \rightarrow A_0B_1}$  with respect to  $A_1A_0 : B_0B_1$ , which is also equivalent to the fact that  $\Delta^{A \rightarrow B}$  is entanglement breaking. This completes the proof of

theorem 1. □

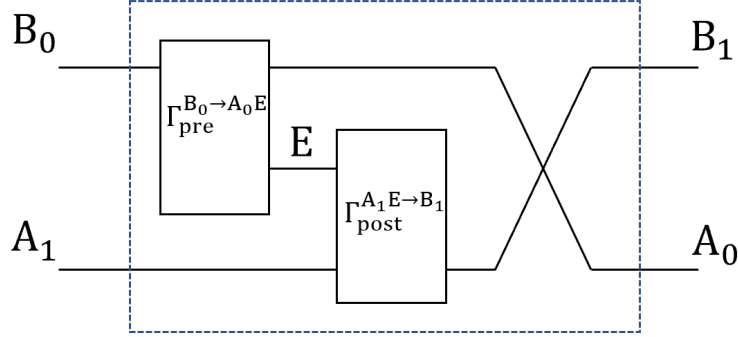

Figure 4. The map  $\Gamma_{\Theta}^{A_1 B_0 \rightarrow A_0 B_1} = \Gamma_{\text{post}}^{A_1 E \rightarrow B_1} \circ \Gamma_{\text{pre}}^{B_0 \rightarrow A_0 E}$ . For any EBSC  $\Theta^{A \rightarrow B}$ , Theorem 1 (D) requires this map to be  $A_0 A_1 : B_0 B_1$  separable.

### B. EBSCs realized by EB pre/post-processing channels

Theorem 1 (D) provides a structural requirement for the pre/post-processing maps of an EBSC. However, the separability on  $\Gamma_{\Theta}$  only characterizes the *concatenation* of the pre/post-processing maps, as depicted in Fig. 4. Since the decomposition of a given superchannel into pre/post-processing channels is not unique, it remains unclear what constraints are placed on the pre/post-processing maps individually in order for the resulting superchannel to be entanglement-breaking. For instance, if both  $\Gamma_{\text{pre}}$  and  $\Gamma_{\text{post}}$  are entanglement-breaking between the channel input/outputs and the memory, then they will generate an EBSC. But can every EBSC be decomposed into EB pre/post-processing channels? Here we explore this question and find that in general, such a realization is not always possible.

We begin by generalizing the definition of entanglement-breaking for channels that have bipartite input or output.

**Definition III.2.** A quantum channel  $\mathcal{E}^{B_0 \rightarrow A_0 E}$  is called *partly entanglement breaking for output*  $A_0$  if  $\mathbb{1}^R \otimes \mathcal{E}^{B_0 \rightarrow A_0 E}(\rho^{RB_0})$  is separable with respect to  $A_0 : RE$  for any  $\rho \in \mathcal{D}(RB_0)$  and any system  $R$  with finite dimension.

**Definition III.3.** A quantum channel  $\mathcal{E}^{EA_1 \rightarrow B_1}$  is called *partly entanglement breaking for input  $A_1$*  if  $\mathbb{1}^{RS} \otimes \mathcal{E}^{EA_1 \rightarrow B}(\sigma^{RE} \otimes \omega^{SA_1})$  is separable with respect to  $S : RB_1$  for any  $\sigma^{RE} \in \mathcal{D}(RE)$  and  $\omega^{SA_1} \in \mathcal{D}(SA_1)$  for any system  $R, S$  with finite dimension.

The following lemmas offer alternative characterizations of partly EB channels. Note the similarity to the structure of EBCs stated in Proposition 1.

**Lemma III.1.** For a quantum channel  $\mathcal{E}^{B_0 \rightarrow A_0 E}$ , the following are equivalent:

- (a)  $\mathcal{E}^{B_0 \rightarrow A_0 E}$  is partly EB for output system  $A_0$ .
- (b)  $\mathbb{1}^{B_0} \otimes \mathcal{E}^{\tilde{B}_0 \rightarrow A_0 E}(\phi_+^{B_0 \tilde{B}_0})$  is separable with respect to  $A_0 : B_0 E$ .
- (c)  $\mathcal{E}^{B_0 \rightarrow A_0 E}$  can be written as

$$\mathcal{E}^{B_0 \rightarrow A_0 E}(\rho^{B_0}) = \sum_k \mathcal{E}_k^{B_0 \rightarrow E}(\rho^{B_0}) \otimes \sigma_k^{A_0}, \quad (17)$$

for some quantum instrument  $\{\mathcal{E}_k^{B_0 \rightarrow E}\}_k$ , i.e.  $\mathcal{E}_k^{B_0 \rightarrow E} \in CP(B_0 \rightarrow E)$  such that  $\sum_k \mathcal{E}_k$  is trace-preserving, and  $\sigma_k^{A_0} \in \mathcal{D}(A_0)$  are fixed states independent of the input.

*Proof.* (a)  $\Rightarrow$  (b) is by definition and (c)  $\Rightarrow$  (a) is trivial. It remains to prove (b)  $\Rightarrow$  (c). Note (b) says that the Choi matrix  $J_{\mathcal{E}}^{B_0 A_0 E}$  is separable with respect to  $A_0 : B_0 E$ . Hence we can write

$$J_{\mathcal{E}}^{B_0 A_0 E} = \sum_k M_k^{B_0 E} \otimes \sigma_k^{A_0} \quad (18)$$

for positive operators  $M_k^{B_0 E}$ ,  $\sigma_k^{A_0}$ , and without loss of generality,  $\text{Tr}(\sigma_k^{A_0}) = 1$  for all  $k$ . Since  $\mathcal{E}$  is CPTP, we have  $I^{B_0} = J_{\mathcal{E}}^{B_0} = \sum_k M_k^{B_0}$ . Hence, each  $M_k^{B_0}$  is the Choi matrix for a CP map  $\mathcal{E}_k^{B_0 \rightarrow E}$  and their sum is trace-preserving. This completes the proof.  $\square$

A similar set of conclusions hold for partly EB channels with a bipartite input.

**Lemma III.2.** For a quantum channel  $\mathcal{E}^{EA_1 \rightarrow B_1}$ , the following are equivalent.

- (a)  $\mathcal{E}^{EA_1 \rightarrow B_1}$  is partly EB for input system  $A_1$ .
- (b)  $\mathbb{1}^{A_1 E} \otimes \mathcal{E}^{\tilde{A}_1 \rightarrow B_1}(\phi_+^{A_1 \tilde{A}_1} \otimes \phi_+^{E \tilde{E}})$  is separable with respect to  $A_1 : EB_1$ .

(c)  $\mathcal{E}^{EA_1 \rightarrow B_1}$  can be written as

$$\mathcal{E}^{EA_1 \rightarrow B_1}(\rho^{EA_1}) = \sum_k \mathcal{E}_k^{E \rightarrow B_1} \left( \text{Tr}_{A_1} (F_k^{A_1} \rho^{EA_1}) \right). \quad (19)$$

for some instrument  $\{\mathcal{E}_k^{B_0 \rightarrow E}\}_k$  and POVM  $\{F_k^{A_1}\}$ .

*Proof.* The proof is very similar to the previous lemma. We only need to show (b)  $\Rightarrow$  (c).

For any  $\rho \in \mathcal{D}(EA_1)$ ,

$$\mathcal{E}^{EA_1 \rightarrow B_1}(\rho^{EA_1}) = \text{Tr}_{EA_1} (J_{\mathcal{E}}^{EA_1 B_1} (\rho^{EA_1})^T) \quad (20)$$

$$= \sum_k \text{Tr}_{EA_1} \left( (F_k^{A_1})^T \otimes N_k^{EB_1} (\rho^{EA_1})^T \right). \quad (21)$$

Since  $\mathcal{E}$  is CPTP, we have that  $I^{EA_1} = J_{\mathcal{E}}^{EA_1} = \sum_k (F_k^{A_1})^T \otimes N_k^E$ . Hence  $\{F_k\}_k$  defines a POVM, and the  $\{N_k^{EB_1}\}_k$  are Choi matrices for an instrument.  $\square$

**Remark.** Note that partly-EB channels are equivalent to bipartite separable channels with one trivial input/output system. That is,  $\mathcal{E}^{B_0 \rightarrow A_0 E}$  is partly EB for output  $A_0$  iff it is a separable map w.r.t.  $A_0 : B_0 E$ . Similarly,  $\mathcal{E}^{EA_1 \rightarrow B_1}$  is partly EB for input  $A_1$  iff  $\mathcal{E}^{EA_1 \rightarrow B_1}$  is separable w.r.t.  $A_1 : EB_1$ . This can be seen from item (b) in Lemmas III.1 and III.2. As a special case (with  $E$  being trivial), both types of partly EB channels reduce to standard EBCs, with Choi matrices that are separable across input and output systems.

Clearly the use of partly EB pre/post-processing channels yields a superchannel that is EB. A natural question is whether *all* EBSCs can be realized in this manner. To prove this is not the case, we first make a simple observation.

**Proposition 2.** *Suppose that  $\Theta$  is a superchannel realized by a partly EB pre-processing map  $\Gamma_{pre}^{B_0 \rightarrow A_0 E}$ . Then for any  $\rho^{RB_0}$  and  $\omega^{SA_1}$ , the output state*

$$\mathbb{1}^{RS} \otimes \Gamma_{post}^{EA_1 \rightarrow B_1} \circ \Gamma_{pre}^{B_0 \rightarrow A_0 E} \left( \rho^{RB_0} \otimes \omega^{SA_1} \right) \quad (22)$$

*is separable across  $A_0 : RB_1 S$ . Similarly, if  $\Theta$  is realized by a partly EB post-processing map, then this output state is separable across  $A_0 RB_1 : S$ .*

*Proof.* By definition,  $\sigma^{A_0:RE} = \mathbb{1}^R \otimes \Gamma_{\text{pre}}^{B_0 \rightarrow A_0 E}(\rho^{RB_0})$  is separable across  $A_0 : RE$ . Then  $\mathbb{1}^S \otimes \Gamma_{\text{post}}^{EA_1 \rightarrow B_1}(\sigma^{A_0:RE} \otimes \omega^{SA_1})$  will also be separable across  $A_0 : RB_1 S$ . An analogous argument proves the second statement when the post-processing map is partly EB.  $\square$

From this proposition, it follows that if  $\Theta^{A \rightarrow B}$  is an EBSC that can be realized by a partly EB pre-processing (resp. post-processing) map, then we must have that  $\mathcal{J}_{\Theta}^{AB}$  is both  $A_0 A_1 : B_0 B_1$  separable as well as  $A_0 : A_1 B_0 B_1$  (resp.  $A_1 : A_0 B_0 B_1$ ) separable. It is not difficult to construct superchannels that fail to have this separability structure.

**Theorem 2.** *There exists EBSCs that cannot be realized using either a pre- or post-processing channel that partly EB.*

*Proof.* By the previous proposition, it suffices to construct pre/post-processing maps  $\Gamma_{\text{pre}}^{B_0 \rightarrow A_0 E}$  and  $\Gamma_{\text{post}}^{EA_1 \rightarrow B_1}$  such that

$$\mathcal{J}_{\Theta}^{AB} = \mathbb{1}^{B_0 A_1} \otimes \Gamma_{\text{post}}^{E\tilde{A}_1 \rightarrow B_1} \circ \Gamma_{\text{pre}}^{\tilde{B}_0 \rightarrow A_0 E} \left( \phi^{+A_1 \tilde{A}_1} \otimes \phi^{+B_0 \tilde{B}_0} \right)$$

is  $A_0 A_1 : B_0 B_1$  separable, but neither  $A_0 : A_1 B_0 B_1$  nor  $A_1 : A_0 B_0 B_1$  is separable. Let  $d_{B_0} = d_{A_0} = d_{A_1} = 2$  and  $d_{B_1} = d_E = 3$ . Define the isometry  $\Gamma_{\text{pre}}^{\tilde{B}_0 \rightarrow A_0 E}$  by

$$|0\rangle^{\tilde{B}_0} \rightarrow \frac{1}{\sqrt{2}}(|00\rangle + |11\rangle)^{A_0 E}, \quad |1\rangle^{\tilde{B}_0} \rightarrow |02\rangle^{A_0 E}. \quad (23)$$

Hence  $\mathbb{1}^{B_0} \otimes \Gamma_{\text{pre}}^{\tilde{B}_0 \rightarrow A_0 E}(\phi^{+B_0 \tilde{B}_0}) = |\tau\rangle\langle\tau|$ , where  $|\tau\rangle = \frac{1}{\sqrt{2}}(|00\rangle + |11\rangle)^{A_0 E} |0\rangle^{B_0} + |02\rangle^{A_0 E} |1\rangle^{B_0}$ . The post-processing map  $\Gamma_{\text{post}}^{E\tilde{A}_1 \rightarrow B_1}$  is then a POVM with elements

$$\begin{aligned} \Pi_0 &= \frac{1}{2} \phi^{+E\tilde{A}_1}, \\ \Pi_1 &= (I - |2\rangle\langle 2|)^E \otimes I^{\tilde{A}_1} - \frac{1}{2} \phi^{+E\tilde{A}_1} \\ \Pi_2 &= |2\rangle\langle 2|^E \otimes I^{\tilde{A}_1}. \end{aligned} \quad (24)$$

This leads to the Choi matrix

$$\begin{aligned} \mathcal{J}_{\Theta}^{AB} &= \frac{1}{4} \phi^{+A_0 A_1} \otimes |00\rangle\langle 00|^{B_0 B_1} + \frac{1}{2} \left( I^{A_0 A_1} - \frac{1}{2} \phi^{+A_0 A_1} \right) \otimes |01\rangle\langle 01|^{B_0 B_1} \\ &\quad + |0\rangle\langle 0|^{A_0} \otimes I^{A_1} \otimes |12\rangle\langle 12|^{B_0 B_1}. \end{aligned} \quad (25)$$

Clearly it  $A : B$  separable, and yet it is entangled for both parts  $A_0$  and  $A_1$  since projecting onto  $|00\rangle^{B_0B_1}$  leads to the maximally entangled state  $\frac{1}{4}\phi^{+A_0A_1}$ .  $\square$

**Remark:** One interpretation of this result is that there exists EBSCs that must entangle their memory system  $E$  with the channel input  $A_0$  for some inputs to  $B_0$ . Likewise, the channel output  $A_1$  must couple with the memory  $E$  nonlocally.

One may consider a more general way to apply partly-EB channels as pre/post-processing maps. As shown in Fig. 5, one can split the side-channel in half,  $\mathcal{H}_E = \mathcal{H}_{E_A} \otimes \mathcal{H}_{E_B}$ , and require the pre-processing channel to be partly-EB for output system  $E_A A_0$  (i.e. separable w.r.t.  $B_0 E_B : E_A A_0$ ), the post-processing channel partly-EB for input system  $E_A A_1$  (i.e. separable w.r.t.  $B_1 E_B : E_A A_1$ ). It's easy to verify that this kind of superchannels is EBSC. A question is whether every EBSC can be realized in this way. Note that the Choi matrix of this EBSC can have  $A_0 A_1$  entangled, so the argument in Thm. 2 does not apply here. This question is left open for future work.

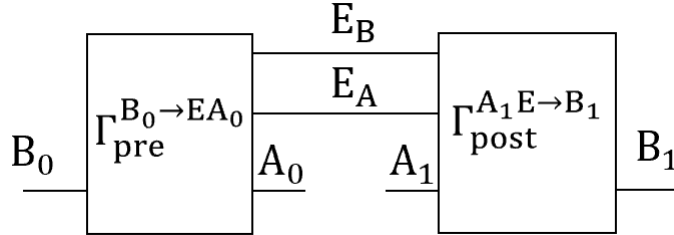

Figure 5. A more general way of implementing EBSC with partly-EB pre/post-processing channels.  $\Gamma_{\text{pre}}^{B_0 \rightarrow E_A E_B A_0}$  is partly EB for output system  $E_A A_0$ .  $\Gamma_{\text{post}}^{A_1 E_A E_B \rightarrow B}$  is partly-EB for input system  $E_A A_1$ . This EBSC becomes what we discussed in Thm. 2 if  $E_A$  is taken to be trivial.

### C. EBSCs realized by measure-and-prepare superchannels

On the level of channels, entanglement-breaking is equivalent to measuring and preparing, as described in Eq. (1). A natural question is whether the same holds for EBSCs. To this end, we first need a generalized notion of measurement that also applies to dynamical resources. In Ref. [13], the authors introduce the concept of a *quantum super-instrument*, which is a set of c-CPTNI (completely CP preserving and trace-non-increasing preserving) supermaps  $\{\Theta_x\}$  such that  $\sum_x \Theta_x$  is a superchannel. A quantum

super-instrument therefore describes in one sense how a quantum channel can be measured. It is proven in [13] that every super-instrument can be realized with a CPTP pre-processing channel and a post-processing quantum instrument, as shown on the left side of Fig. 6. We are also interested in a special kind of super-instrument with trivial output channel, which we call a POVM of quantum channels, as shown on the right side of Fig. 6.

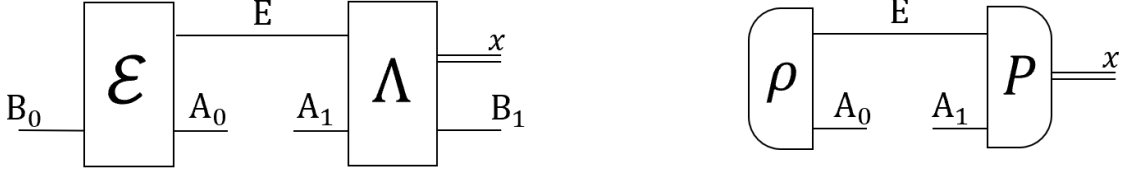

Figure 6. (Left) Implementation of a quantum super-instrument. A CPTP map  $\mathcal{E}$  is performed as pre-processing while a quantum instrument  $\Lambda = \sum_x \Lambda_x \otimes |x\rangle\langle x|$  encompasses the post-processing. (Right) A POVM of quantum channels. The pre-processing is a quantum state  $\rho$  and the post processing is a bipartite measurement channel  $P = \sum_x \text{Tr}_x(\cdot P_x) \otimes |x\rangle\langle x|$  for POVM  $\{P_x\}_x$ .

With the concept of a channel POVM in place, we next combine it with a channel preparation step to obtain a measure-and-prepare superchannel. This is depicted in Fig. 7 where the channel  $\mathcal{F}_x^B$  is prepared contingent on the outcome  $x$  of the preceding channel POVM.

**Definition III.4.** A superchannel  $\Theta^{A \rightarrow B}$  is called a *measure-and-prepare superchannel (MPSC)* if it can be realized as

$$\Theta^{A \rightarrow B}[\mathcal{E}^A] = \sum_x \text{Tr} \left( \text{id}^E \otimes \mathcal{E}^A(\rho^{A_0 E}) P_x^{A_1 E} \right) \mathcal{F}_x^B, \quad (26)$$

where  $\rho^{A_0 E}$  is some quantum state,  $\{P_x^{A_1 E}\}$  is some POVM, and  $\{\mathcal{F}_x^B\}$  is a collection of CPTP maps.

In short, an MPSC conducts a measurement of the original channel and then prepares a new channel conditioned on the measurement outcome. This seems like a reasonable superchannel analogy for a measure-and-prepare channel. However, notice that in the superchannel case, the choice of pre-processing state  $\rho^{E_1 A_0}$  provides an extra degree of freedom that is not present in the channel case. In the definition of an MPSC, the pre-processing state  $\rho^{E_1 A_0}$  is independent of the input system  $B_0$ . One may also want to apply





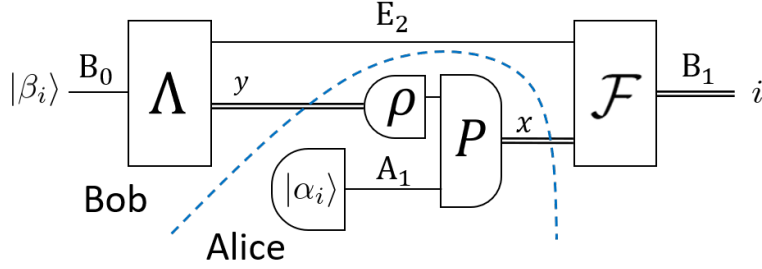

Figure 9. When  $A_0$  is one-dimensional, a CMPSC reduces to a 2-way LOCC map on product states. Since there are separable maps that cannot be implemented by 2-way LOCC, there exists EBSCs that are not CMPSCs.

*Proof.* The construction uses the fact that there exists channels  $\mathcal{E}^{E_2 A_1 \rightarrow B_1}$  that are partly EB for  $A_1$ , yet they are not implementable by local operations and classical communication (LOCC). From the remark following Lemma III.1, a partly EB channel for input  $A_1$  is an  $A_1 : E_2 B_1$  separable channel. Let  $\mathcal{E}^{E_2 A_1 \rightarrow B_1}$  be any such channel whose action on a collection of product states  $\{|\alpha_i\rangle^{A_1} \otimes |\beta_i\rangle^{E_2}\}$  cannot be simulated by LOCC. Such maps arise, for instance, when considering orthogonal product bases that can be distinguished by separable operations but not LOCC, a phenomenon famously known as i.e. *nonlocality without entanglement* [14]. Hence,  $\mathcal{E}^{E_2 A_1 \rightarrow B_1}$  is a non-LOCC channel whose action is

$$\mathcal{E}^{E_2 A_1 \rightarrow B_1} : |\beta_i\rangle^{E_2} |\alpha_i\rangle^{A_1} \mapsto |i\rangle^{B_1}$$

for all  $i$ . We can regard this as a post-processing map for a superchannel that converts states  $|\alpha_i\rangle$  into QC channels  $|\beta_i\rangle \rightarrow i$ . Since  $\mathcal{E}^{E_2 A_1 \rightarrow B_1}$  is separable, it is clearly an EBSC. However, with system  $A_0$  being one-dimensional, the possible implementation by a CMPSC reduces to two-way LOCC, as shown in Fig. 9, which is not possible by construction. Therefore the superchannel is not CMPSC. □

#### IV. SUPERACTIVATION OF EBSC

Entanglement-breaking channels have the property that they are closed under tensor product. That is, if  $\mathcal{E}^{A_0 \rightarrow A_1}$  and  $\mathcal{N}^{R_0 \rightarrow R_1}$  are both EB channels, then so is their tensor prod-

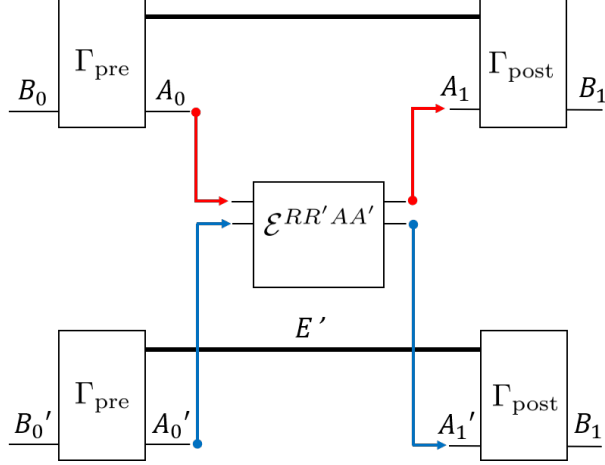

Figure 10. A parallel implementation of two EBSCs is still an EBSC.

uct,  $[\mathcal{E} \otimes \mathcal{N}]^{A_0 R_0 \rightarrow A_1 R_1}$ . In this section we consider whether an analogous result holds for EBSCs. The problem has an added level of complexity when dealing with superchannels since the dynamic nature of channels allows them to be processed in different ways. On the one hand, two copies of a superchannel can be used for parallel processing, which means that their pre/post-processing occurs simultaneously, as shown in Fig. 10. Alternatively, the two superchannels can implement a processing of channels in series, such that the output of one superchannel can be used as the input for the other. While the full theory of sequential processing can be described using the formalism of quantum combs [15, 16], here we do not need to invoke the latter to demonstrate the generic superactivation of EBSC.

**Theorem 4.** *Suppose  $\Theta^{A \rightarrow B}$  is an EBSC. Then two copies of  $\Theta^{A \rightarrow B}$  will be an EBSC when used in parallel. However, if  $\mathcal{J}_{\Theta}^{A_1 B_0 B_1}$  is entangled across  $A_1 B_0 : B_1$  and  $d_{A_1} \geq d_{B_0}$ , then two copies of  $\Theta^{A \rightarrow B}$  is no longer an EBSC when used in series.*

*Proof.* When two copies of  $\Theta^{A \rightarrow B}$  are used in parallel, they become a single superchannel  $\Theta^{AA' \rightarrow BB'}$ . Its Choi matrix satisfies  $\mathcal{J}_{\Theta}^{AA'BB'} = \mathcal{J}_{\Theta}^{AB} \otimes \mathcal{J}_{\Theta}^{A'B'}$ , and since two copies of a separable operator is separable, it follows that  $\mathcal{J}_{\Theta}^{AA'BB'}$  represents an EBSC. On the other hand, suppose that each copy of  $\Theta^{A \rightarrow B}$  can be used in series. Let  $d_{R_0} = d_{A_0}$ ,  $d_{R_1} = d_{A_1}$ , and define the channel  $\mathcal{E}_0^{R_0 A}$  that discards its input and prepares the state  $\frac{1}{d_{B_0}} \phi_+^{R_1 B_0'}$ . Likewise, let  $\mathcal{E}_1^{R_1 A'}$  be the channel that discards and prepares  $\frac{1}{d_{A_0}} \phi_+^{R_1' A_1}$ . Then with the

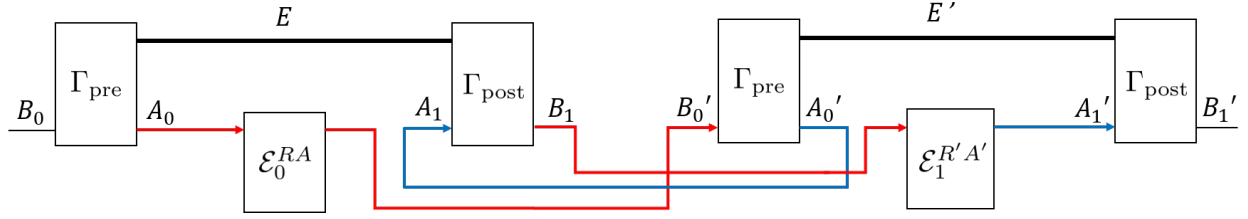

Figure 11. A series implementation of two EBSCs that can yield a non-separable channel. The channels  $\mathcal{E}_0^{RA}$  and  $\mathcal{E}_1^{R'A'}$  discard their inputs and prepare maximally entangled states.

wiring shown in Fig. 11, it follows that the resulting channel will be the state

$$\Omega^{R_1 R'_1 B'_1} = d_{B_0}^{-1} d_{A_1}^{-1} \text{Tr}_{A'_0} \left( \text{id}^{R'_1} \otimes \Gamma_{\text{post}}^{EA'_1 \rightarrow B'_1} \circ \text{id}^{R_1} \otimes \Gamma_{\text{pre}}^{B'_0 \rightarrow A'_0 E} \left( \phi_+^{R_1 B'_0} \otimes \phi_+^{R'_1 A'_1} \right) \right). \quad (28)$$

However, this is proportional to  $\mathcal{J}_{\Theta}^{A'_1 B'_0 B'_1}$  with  $A'_1$  replaced by  $R'_1$  and  $B'_0$  replaced by  $R_1$ . The  $A'_1 B'_0 : B'_1$  entanglement implies that  $\Omega^{R_1 R'_1 B'_1}$  is entangled between Rachel and Bob. Hence  $\mathcal{E}_0^{RA}$  and  $\mathcal{E}_1^{R'A'}$  is transformed into an entangled channel by two copies of the EBSC  $\Theta^{A \rightarrow B}$ .  $\square$

## V. IMAGE OF EBSC

In Section III we introduced EBSC and its two subsets MPSC and CMPSC. Here, we investigate the comparative powers of these operational classes. In particular, we consider whether every bipartite separable channel can be generated by applying an EBSC on one part of some bipartite channel, and whether MPSC/CMPSC has the same channel-generation power as EBSC. For this purpose, we introduce the notion of *CPTP-complete image*.

**Definition V.1.** Given a superchannel  $\Theta^{A \rightarrow B}$ , the *CPTP image* of  $\Theta^{A \rightarrow B}$  is defined as

$$\text{Im}_{\Theta} = \left\{ \mathcal{G}^B \in \text{CPTP}(B) \mid \mathcal{G}^B = \Theta^{A \rightarrow B}[\mathcal{E}^A], \mathcal{E}^A \in \text{CPTP}(A) \right\}. \quad (29)$$

The *CPTP-complete image* of  $\Theta^{A \rightarrow B}$  is defined as

$$\mathcal{C}_{\Theta} = \bigcup_R \text{Im}_{\mathbb{1}^R \otimes \Theta}, \quad (30)$$

which is the union of CPTP images  $\mathbb{1}^R \otimes \Theta^{A \rightarrow B}$  for all systems  $R$ . The **CPTP-complete image** of a set of superchannels  $\mathcal{S}$  is defined as  $C_{\mathcal{S}} = \bigcup_{\Theta \in \mathcal{S}} C_{\Theta}$ .

Similarly, we introduce the **CP-complete image** as follows.

**Definition V.2.** Given a superchannel  $\Theta^{A \rightarrow B}$ , the **CP image** of  $\Theta^{A \rightarrow B}$  is defined as

$$\text{Im}_{\Theta}^* = \left\{ \mathcal{G}^B \in \text{CP}(B) \mid \mathcal{G}^B = \Theta^{A \rightarrow B}[\mathcal{E}^A], \mathcal{E}^A \in \text{CP}(A) \right\}. \quad (31)$$

The **CP-complete image** of  $\Theta^{A \rightarrow B}$  is defined as

$$C_{\Theta}^* = \bigcup_R \text{Im}_{\mathbb{1}^R \otimes \Theta}^* \quad (32)$$

which is the union of CP images  $\mathbb{1}^R \otimes \Theta^{A \rightarrow B}$  for all systems  $R$ . The **CP-complete image** of a set of superchannels  $\mathcal{S}$  is defined as  $C_{\mathcal{S}}^* = \bigcup_{\Theta \in \mathcal{S}} C_{\Theta}^*$ .

Alternatively, we can say that the CPTP image of  $\Theta^{A \rightarrow B}$  is its image when the domain is restricted to CPTP maps, and likewise the CP image of  $\Theta^{A \rightarrow B}$  is its image when the domain is restricted to CP maps.

With these definitions in place, a superchannel  $\Theta^{A \rightarrow B}$  is an EBSC if and only if  $C_{\Theta}^* \subseteq \text{SEP}^*$ . Here we use  $\text{SEP}^*$  to denote the set of separable CP maps while  $\text{SEP}$  will denote the set of all separable CPTP maps. An interesting question is whether  $C_{\text{EBSC}} = \text{SEP}$  and  $C_{\text{EBSC}}^* = \text{SEP}^*$  hold, which will be the main concern of this section.

Let us first consider this question for EBCs. Note that our definition of CPTP (CP) complete image also applies for channels since they are a special case of superchannels. Specifically, for a channel  $\mathcal{E}$ , the set  $\text{Im}_{\mathcal{E}}$  (resp.  $\text{Im}_{\mathcal{E}}^*$ ) is the image of  $\mathcal{E}$  when the domain is restricted to density operators (resp. positive operators). In this case, it is easy to see that both  $C_{\text{EBC}} = \text{SEP}$  and  $C_{\text{EBC}}^* = \text{SEP}^*$  hold. Indeed for an arbitrary separable positive operator  $\rho^{RB} = \sum_i p_i |\psi_i\rangle\langle\psi_i|^R \otimes |\alpha_i\rangle\langle\alpha_i|^B$ , one need only consider the action of the EBC  $\mathcal{E}^{A \rightarrow B}$  on the positive operator  $\sigma^{RA} = \sum_i p_i |\psi_i\rangle\langle\psi_i|^R \otimes |i\rangle\langle i|^A$ , where  $\mathcal{E}^A(X) = \langle i|X|i\rangle^A |\alpha_i\rangle\langle\alpha_i|^B$ , and  $\sigma^{RA}$  is a density matrix if and only if  $\rho^{RB}$  is.

In following part of this section, we set out to study the image of general EBSC. Regarding the CPTP-complete image, while we are unable to precisely characterize  $C_{\text{EBSC}}$ ,

we relate  $C_{\text{MPSC}}$  and  $C_{\text{CMPSC}}$  to LOCC channels of certain communication rounds. As for the CP-complete image, we show that  $C_{\text{EBSC}}^* = \text{SEP}^*$  holds exactly. These results reveal some fundamental differences between channels and superchannels of physical significance, and we discuss this further at the end of this section.

### A. CPTP-complete Image of EBSC

As noted above, one of our primary interests is determining whether  $C_{\text{EBSC}} = \text{SEP}$ . We consider here a special subset of the separable channels that can be generated by LOCC. While LOCC is a notoriously difficult class of operations to analyze, here it will be sufficient to just consider one-round and two-round LOCC. A precise definition of these operational classes is as follows.

**Definition V.3.** [17] *A channel  $\mathcal{E} \in \text{CPTP}(R_0 B_0 \rightarrow R_1 B_1)$  is called a  $(B \rightarrow R \rightarrow B)$  two-round LOCC channel if it can be written as*

$$\mathcal{E}^{RB} = \sum_{ij} \Gamma_{j|i}^{R_0 \rightarrow R_1} \otimes (\mathcal{F}_{ij}^{B_2 \rightarrow B_1} \circ \Lambda_i^{B_0 \rightarrow B_2}) \quad (33)$$

for some quantum instrument  $\{\Lambda_i^{B_0 \rightarrow B_2}\}_i$  and family of channels  $\{\mathcal{F}_{ij}^{B_2 \rightarrow B_1}\}_{ij}$  for Bob, and a family of instruments  $\{\Gamma_{j|i}^{R_0 \rightarrow R_1}\}_{i,j}$  for Rachel. An  $(R \rightarrow B)$  one-way LOCC channel is defined similarly except with the added condition that all the  $\Lambda_i$  are trivial; i.e.  $\mathcal{E}^{RB} = \sum_j \Gamma_j^R \otimes \mathcal{F}_j^B$ .

**Proposition 3.** *The CPTP-complete images of EBSC, MPSC and CMPSC satisfy the following relation.*

$$C_{\text{MPSC}} = \text{LOCC}_1 \subsetneq \text{LOCC}_2 = C_{\text{CMPSC}} \subsetneq C_{\text{EBSC}} \subseteq \text{SEP}, \quad (34)$$

where  $\text{LOCC}_1$  denotes the set of all  $(R \rightarrow B)$  one-round LOCC channels,  $\text{LOCC}_2$  denotes the set of all  $(B \rightarrow R \rightarrow B)$  two-round LOCC channels, and  $\text{SEP}$  denotes the set of all bipartite separable channels.

*Proof.* The only non-trivial part is the two equal signs. For the second equality, first notice that if  $\Theta$  is CMPSC, then  $\mathbb{1} \otimes \Theta[\mathcal{E}]$  is a two-round LOCC channel for every quantum channel  $\mathcal{E}^{RA}$ , as can be seen from Fig. 12. This establishes  $C_{\text{CMPSC}} \subseteq \text{LOCC}_2$ . On the other

hand, consider an arbitrary  $(B \rightarrow R \rightarrow B)$  two-round LOCC channel  $\mathcal{G}$ . By definition V.3, it can be written as

$$\mathcal{G}^{RB} = \sum_{ij} \Gamma_{j|i}^R \otimes (\mathcal{F}_{ij}^{B_2 \rightarrow B_1} \circ \Lambda_i^{B_0 \rightarrow B_2}) \quad (35)$$

for some CPTP maps  $\mathcal{F}_{ij}^B$  and deterministic quantum instruments  $\{\Lambda_i^B\}, \{\Gamma_{j|i}^R\}$ . Set  $B_2 = E_2$  and construct a superchannel  $\Theta$  with the following realization:

$$\Gamma_{\text{pre}}^{B_0 \rightarrow A_0 \hat{E}_2 E_2}(\cdot) = \sum_i |i\rangle\langle i|^{A_0} \otimes |i\rangle\langle i|^{\hat{E}_2} \otimes \Lambda_i^{B_0 \rightarrow E_2}(\cdot), \quad (36)$$

$$\Gamma_{\text{post}}^{A_1 \hat{E}_2 E_2 \rightarrow B_1}(\cdot) = \sum_{ij} \langle j| \cdot |j\rangle^{A_1} \langle i| \cdot |i\rangle^{\hat{E}_2} \mathcal{F}_{ij}^{E_2 \rightarrow B_1}(\cdot). \quad (37)$$

Here, system  $E_1$  is taken to be trivial. It's easy to see that  $\Theta$  is a CMPSC by Def. III.5. Then consider the quantum channel

$$\mathcal{E}^{RA}(\cdot) = \sum_{ij} \Gamma_{j|i}^R(\cdot) \otimes \langle i| \cdot |i\rangle^{A_0} \otimes |j\rangle\langle j|^{A_1}. \quad (38)$$

One can immediately verify that  $\mathcal{G}^{RB} = \mathbb{1}^R \otimes \Theta^{A \rightarrow B}[\mathcal{E}^{RA}]$ , which means  $\mathcal{G}^{RB} \in \mathcal{C}_{\text{CMPSC}}$ . By the arbitrariness of  $\mathcal{G}$  we have  $\text{LOCC}_2 \subseteq \mathcal{C}_{\text{CMPSC}}$ , hence  $\text{LOCC}_2 = \mathcal{C}_{\text{CMPSC}}$ .

For the first equality in Eq. (34), we can similarly verify that  $\mathcal{C}_{\text{MPSC}} \subseteq \text{LOCC}_1$  from Fig. 12 when the classical channel from Bob to Rachel is removed. For an arbitrary

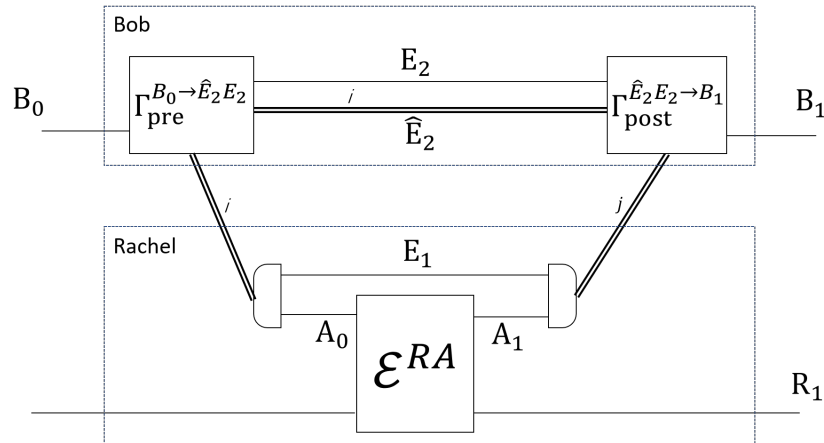

Figure 12. A CMPSC superchannel transforms any  $\mathcal{E}^{RA}$  into a channel  $\mathcal{F}^{RB}$  that can implemented by a two-round LOCC channel from Bob to Rachel.

( $R \rightarrow B$ ) one-way LOCC channel  $\mathcal{G}^{RB} = \sum_i \Gamma_i^R \otimes \mathcal{F}_i^B$  with CPTP maps  $\mathcal{F}_i$  and quantum instrument  $\{\Gamma_i\}_i$ , construct a superchannel  $\Theta^{A_1 \rightarrow B}$  with trivial  $A_0$  system as

$$\Theta^{A_1 \rightarrow B}[\cdot] = \sum_i \langle i | \cdot | i \rangle^{A_1} \otimes \mathcal{F}_i^B, \quad (39)$$

and further define a quantum channel  $\mathcal{E}^{R_0 \rightarrow R_1 A_1} = \sum_i \Gamma_i^R \otimes |i\rangle\langle i|^{A_1}$ . Then we have  $\mathbb{1}^R \otimes \Theta^{A_1 \rightarrow B}[\mathcal{E}] = \mathcal{G}^{RB}$ . It is obvious that  $\Theta^{A_1 \rightarrow B}$  is an MPSC, and so  $\mathcal{G} \in \mathcal{C}_{\text{MPSC}}$ . Combining the above results we get  $\mathcal{C}_{\text{MPSC}} = \text{LOCC}_1$ .

As for  $\mathcal{C}_{\text{CMPSC}} \subsetneq \mathcal{C}_{\text{EBSC}}$ , recall the EBSC we constructed to prove theorem 3. By applying that EBSC at an input noiseless channel  $\text{id}^{R_0 \rightarrow A_1}$ , we obtain a separable channel that cannot be implemented by LOCC. This complete the proof of proposition 3.  $\square$

The above proposition precisely characterizes the CPTP-complete image of MPSC and CMPSC. Also, it tells us  $\mathcal{C}_{\text{EBSC}}$  contains all ( $B \rightarrow R \rightarrow B$ ) two-round LOCC channels and some non-LOCC separable channels. It remains an open problem whether  $\mathcal{C}_{\text{EBSC}} = \text{SEP}$ . We next turn to the CP-complete image.

## B. CP-complete Image of EBSC

Interestingly, we can easily prove  $\mathcal{C}_{\text{EBSC}}^* = \text{SEP}^*$ . We first present a proof by direct construction, and then later discuss how this result is related to the notion of stochastic LOCC (SLOCC) strategy.

**Proposition 4.** *The CP-complete image of EBSC and CMPSC satisfy*

$$\mathcal{C}_{\text{CMPSC}}^* = \mathcal{C}_{\text{EBSC}}^* = \text{SEP}^*, \quad (40)$$

where  $\text{SEP}^*$  is the set of all bipartite separable CP maps.

*Proof.* By definition,  $\mathcal{C}_{\text{EBSC}}^* \subseteq \text{SEP}^*$ . We only need to prove that  $\mathcal{C}_{\text{EBSC}}^* \supseteq \text{SEP}^*$ . It is enough to show that  $\mathcal{C}_{\text{EBSC}}^*$  contains all CPTNI separable maps, because every CP map can be normalized to be CPTNI by dividing a positive factor, and we can always multiply this factor to the input CP map.



For any bipartite separable CPTNI map  $\mathcal{G}^{RB}$ , its Choi matrix can be written as  $J_{\mathcal{G}}^{RB} = \sum_{k=1}^r P_k^{R_0 R_1} \otimes Q_k^{B_0 B_1}$  such that  $P_k, Q_k$  are positive operators. Without loss of generality we take  $\text{Tr}(P_k) = 1$ . Since  $\mathcal{G}^{RB}$  is CPTNI, we have  $\sum_k P_k^{R_0} \otimes Q_k^{B_0} \leq I^{R_0 B_0}$ , and so  $\sum_k Q_k^{B_0} \leq I^{B_0}$ . Let  $F^{B_0 B_1}$  be a positive operator satisfying  $F^{B_0} = I^{B_0} - \sum_k Q_k^{B_0}$ . Then for an  $(r+1)$ -dimensional system  $A_0$  and system  $A_1$  being one-dimensional, construct a supermap  $\Theta$  whose Choi matrix is as follows.

$$\mathcal{J}_{\Theta}^{AB} = \sum_{k=1}^r |k\rangle\langle k|^{A_0} \otimes Q_k^{B_0 B_1} + |r+1\rangle\langle r+1|^{A_0} \otimes F^{B_0 B_1}. \quad (41)$$

Since  $A_1$  is one-dimensional, it holds trivially that  $\mathcal{J}_{\Theta}^{AB_0} = \mathcal{J}_{\Theta}^{A_0 B_0} \otimes u^{A_1}$  and  $\mathcal{J}_{\Theta}^{A_1 B_0} = I^{A_1 B_0}$ , and hence  $\Theta$  is a superchannel. Furthermore, since  $\mathcal{J}_{\Theta}^{AB}$  is separable with respect to  $A : B$ , it is also an EBSC, by theorem 1. Define a CP map  $\mathcal{E}$  whose Choi matrix is given by

$$J_{\mathcal{E}}^{RA} = \sum_{k=1}^r P_k^R \otimes |k\rangle\langle k|^{A_0}. \quad (42)$$

Note the condition  $\sum_k P_k^{R_0} = \mathbb{I}$  need not be enforced here since we allow  $\mathcal{E}$  to be non-trace-preserving. Then,

$$J_{\mathbb{1} \otimes \Theta[\mathcal{E}]}^{RB} = \text{Tr}_A \left( \mathcal{J}_{\Theta}^{AB} \left( J_{\mathcal{E}}^{RA} \right)^{\Gamma_A} \right) \quad (43)$$

$$= \sum_k P_k^R \otimes Q_k^B = J_{\mathcal{G}}^{RB}, \quad (44)$$

hence  $\mathcal{G} = \mathbb{1} \otimes \Theta[\mathcal{E}]$ . By the arbitrariness of  $\mathcal{G}$  and the argument before, we have  $\text{SEP}^* \subseteq \text{C}_{\text{EBSC}}^*$ , hence  $\text{C}_{\text{EBSC}}^* = \text{SEP}^*$ .

Notice that the EBSC  $\Theta$  in the above proof is actually a CMPSC. To see this, take the pre/post-processing map to be

$$\Gamma_{\text{pre}}^{B_0 \rightarrow A_0 E} = \sum_{k=1}^r \Lambda_k^{B_0 \rightarrow E} \otimes |k\rangle\langle k|^{A_0} + \mathcal{F}^{B_0 \rightarrow E} \otimes |r+1\rangle\langle r+1|^{A_0}, \quad (45)$$

$$\Gamma_{\text{post}}^{A_1 E \rightarrow B_1} = \text{id}^{E \rightarrow B_1} \otimes \text{Tr}_{A_1}, \quad (46)$$

where  $\Lambda_k^{B_0 \rightarrow E}$  (resp.  $\mathcal{F}^{B_0 \rightarrow E}$ ) is the unique map with Choi matrix  $Q_k^{B_0 E}$  (resp.  $F^{B_0 E}$ ). It is

easy to check  $\Gamma_{\text{pre}}^{B_0 \rightarrow A_0 E}$  is CPTP. Therefore, we have  $C_{\text{CMPSC}}^* = C_{\text{EBSC}}^* = \text{SEP}^*$ . This completes the proof of Proposition 4.  $\square$

It is interesting to consider the physical interpretation of the superchannel and input CP used in the previous proof. In order to implement the CPTNI map  $\mathcal{G}^{RB} = \sum_{k=1}^r P_k^R \otimes Q_k^B$ , Bob first performs a quantum instrument  $\{\Lambda_1, \dots, \Lambda_r, \mathcal{F}\}$  and sends the outcome (stored as classical information in system  $A_0$ ) to Rachel. Rachel then acts as follows. If Bob's action is  $\Lambda_k$ , Rachel implements the CPTNI with Choi matrix  $P_k$  to complete the procedure. If Bob's action is  $\mathcal{F}$ , the protocol aborts. Of course, it may only be possible for Rachel to implement the CPTNI map  $P_k$  with some nonzero probability. In this case, Rachel needs an extra round of classical communication to let Bob know whether her implementation is successful. Bob's final CPTP map would then be the identity in the case that she succeeds, and some other fixed "failure" channel in the case that she does not.

The above procedure describes a general stochastic LOCC (SLOCC) protocol. It is shown in [18] that every separable map can be implemented by an SLOCC protocol, which provides a rough explanation for why Proposition 4 holds. It also helps shed light on the physical significance of CP image, as defined in Definition V.2. This is related to stochastic quantum processes, which we discuss further in the next subsection.

### C. Discussion on CP Image

Suppose that, for superchannel  $\Theta^{A \rightarrow B}$  and CP maps  $\mathcal{G}^B$  and  $\mathcal{E}^A$  one has

$$\mathcal{G}^B = \Theta^{A \rightarrow B}[\mathcal{E}^A]. \quad (47)$$

If both  $\mathcal{G}$  and  $\mathcal{E}$  are CPTP, the physical interpretation of this equation is clearly deterministic channel conversion. What if they are not trace-preserving? Let's consider the case when  $\mathcal{G}^B$  is CPTNI and  $\mathcal{E}^A$  is a general CP map. We can always find a positive number  $p \leq 1$  such that  $p\mathcal{E}$  is a CPTNI map, hence we can find another CPTNI map  $\mathcal{T}$  to make up a quantum instrument  $\{p\mathcal{E}, \mathcal{T}\}^A$ . By applying  $\Theta^{A \rightarrow B}$  to this instrument (see Fig.13) we get a new instrument  $\{p\mathcal{G}, \Theta[\mathcal{T}]\}^B$ . This provides an implementation of the CPTNI map  $\mathcal{G}$  with success probability  $p$ . Therefore, the physical interpretation of the above equation

is probabilistic channel conversion. Hence the CPTP (resp. CP) image describes the channels (resp. CP maps) that can be deterministically (resp. probabilistically) generated by a superchannel.

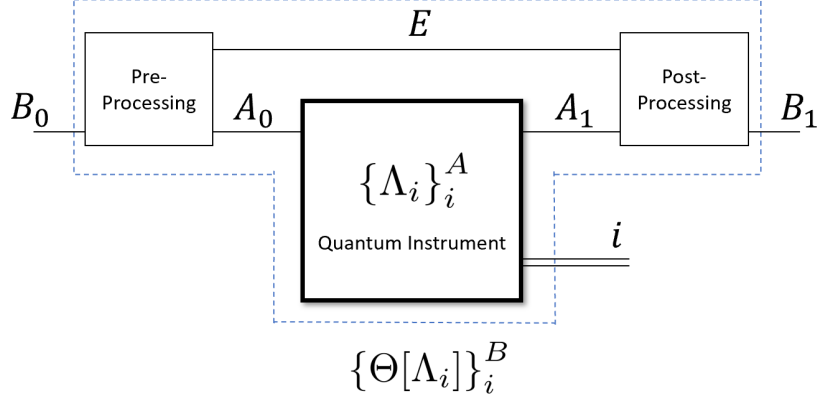

Figure 13. A quantum instrument  $\{\Theta[\Lambda_i]\}_i^B$  resulting from applying superchannel  $\Theta^{A \rightarrow B}$  at a bipartite quantum instrument  $\{\Lambda_i\}_i^A$ .

Comparing Propositions 3 and 4, which say that  $C_{\text{CMPSC}} = \text{LOCC}_2$  but  $C_{\text{CMPSC}}^* = \text{SEP}^*$ , we see there are CPTP maps that can be probabilistically implemented by CMPSC but not deterministically, since there are non-LOCC CPTP maps in  $\text{SEP} \subset \text{SEP}^*$  that are not in  $\text{LOCC}_2$ . Hence, there are separable channels  $\mathcal{G}^{RB}$  and valid superchannels  $\Theta^{A \rightarrow B}$  for which  $\mathcal{G}^{RB} = \mathbb{1}^R \otimes \Theta^{A \rightarrow B}[\mathcal{E}^{RA}]$  holds only for some CP non-TP map  $\mathcal{E}^{RA}$ . Such a phenomenon does not exist at the level of channels and states because we cannot transform an unnormalized state into a normalized one by a quantum channel. This result shows that the structure of unnormalized maps is much more complex than the structure of unnormalized states, which is one of the reasons why QRTs of channels are often harder than QRTs of states (see also Ref. [13] for a related discussion on this point).

## VI. ALTERNATIVE DEFINITIONS OF ENTANGLEMENT BREAKING

In the final section, we examine certain relaxations to the definition of entanglement breaking. To this end, we first consider relaxations to separable channels. Recall that a bipartite channel  $\mathcal{E} \in \text{CP}(A_0 R_0 \rightarrow A_1 R_1)$  is separable if  $\sigma^{R' A' R_1 A_1} = \text{id}^{R' A'} \otimes \mathcal{E}^{A_0 R_0 \rightarrow A_1 R_1}(\rho^{R' R_0} \otimes \omega^{A' A_0})$  is  $R' R_1 : A' A_1$  separable for all  $\rho^{R' R_0} \otimes \omega^{A' A_0}$  and all systems

$R'$  and  $A'$ . In fact, it suffices to consider systems  $R'$  and  $A'$  of dimension  $d_{R_0}$  and  $d_{A_0}$ , respectively. A relaxation would be to require that  $\sigma^{R'A'R_1A_1}$  is separable only for systems  $R'$  and  $A'$  of smaller dimension.

**Definition VI.1.** A bipartite channel  $\mathcal{E} \in \text{CP}(A_0R_0 \rightarrow A_1R_1)$  is called  $(p, q)$ -non-entangling if  $\text{id}^{R'A'} \otimes \mathcal{E}^{A_0R_0 \rightarrow A_1R_1}(\rho^{R'R_0} \otimes \omega^{A'A_0})$  is  $R'R_1 : A'A_1$  separable for all  $\rho^{R'R_0} \otimes \omega^{A'A_0}$  and all systems  $R'$  and  $A'$  with dimensions  $d_{A'} = p$  and  $d_{R'} = q$ .

A  $(k, k)$ -non-entangling channel is also called  $k$ -non-entangling in previous literature [19]. We call a channel  $(p, \text{complete})$ -non-entangling if it's  $(p, q)$ -non-entangling for every positive integer  $q$ . A separable channel is then a  $(\text{complete}, \text{complete})$ -non-entangling channel.

**Definition VI.2.** A superchannel  $\Theta^{A \rightarrow B}$  is called a  $(p, q)$ -EBSC if  $\mathbb{1}^R \otimes \Theta^{A \rightarrow B}[\mathcal{E}^{RA}]$  is a  $(p, q)$ -non-entangling map ( $p$  with  $B$  and  $q$  with  $R$ ) for every  $\mathcal{E} \in \text{CP}(RA)$ , with  $R$  being an arbitrary finite-dimensional system.

As the general structure of  $(p, q)$ -EBSCs is rather complicated, we will only consider superchannels that have an implementation without using a side-channel, and only  $(k, \text{complete})$ -EBSCs. Before doing that, we first introduce  $k$ -entanglement breaking channels in the following subsection.

### A. $k$ -Entanglement Breaking Channel

**Definition VI.3.** A quantum channel  $\Lambda \in \text{CPTP}(B_0 \rightarrow B_1)$  is called a  $k$ -entanglement breaking channel ( $k$ -EBC) if  $\text{id}^R \otimes \Lambda(\rho)$  is separable for any  $\rho \in \mathcal{D}(R \otimes B_0)$ , where  $R$  is any  $k$ -dimensional Hilbert space.

For simplicity, in the following we only consider channels with the same input and output dimension,  $d \geq 2$ . As noted above, a  $k$ -EBC is completely-EBC whenever  $k \geq d$ . For  $1 \leq k < d$ , the set of  $k$ -EBC is clearly a subset of  $(k+1)$ -EBC, and the set of all 1-EBCs trivially equals  $\text{CPTP}(B_0 \rightarrow B_1)$ . To summarize, we have

$$\text{completely-EBC} = d\text{-EBC} \subseteq (d-1)\text{-EBC} \subseteq \dots \subseteq 1\text{-EBC} = \text{CPTP}. \quad (48)$$

In Theorem 5 below, we show that each of the above inclusion is strict. That is, there exists  $k$ -EBC which is not  $(k+1)$ -EBC for all  $1 \leq k < d$ .

Note that our definition of  $k$ -EBC differs from the type of channels studied in Ref. [20]. That paper defines a  $k$  entanglement-breaking channel  $\Lambda^{B_0 \rightarrow B_1}$  to be one that satisfies  $\text{SN}(\text{id}^R \otimes \Lambda(\rho)) \leq k$  for any  $\rho \in \mathcal{D}(R \otimes B_0)$  with arbitrarily large system  $R$ , where  $\text{SN}$  denotes the Schmidt number. Despite the mismatch in terminology, we will still use our definition of a  $k$ -EBC since the name accurately conveys a correspondence with  $k$ -non-entangling maps, as we will clarify later.

The main result of this subsection is the following theorem, which shows that there exists a non-trivial structure of  $k$ -EBC.

**Theorem 5.** *For all integers  $k$  and  $d$  with  $1 \leq k < d$ , there exists a  $k$ -EBC  $\Lambda \in \text{CPTP}(\mathbb{C}^d \rightarrow \mathbb{C}^d)$  that is not  $(k+1)$ -EBC.*

The proof of this theorem is inspired by Theorem 20 in [19], which establishes the existence of  $k$ -non-entangling map that is not  $(k+1)$ -non-entangling. Interestingly, theorem 20 in [19] turns out to be a corollary of Theorem 5 presented here.

**Corollary 1.** ([19]) *For all integers  $k$  and  $d$  with  $1 \leq k < d$ , there exists a  $k$ -non-entangling map  $\Lambda : \mathcal{L}(\mathbb{C}^d \otimes \mathbb{C}^d) \rightarrow \mathcal{L}(\mathbb{C}^d \otimes \mathbb{C}^d)$  that is not  $(k+1)$ -non-entangling.*

*Proof.* The channel  $\text{SWAP} \circ (\Lambda \otimes \Lambda)$  with  $k$ -EBC but not  $(k+1)$ -EBC  $\Lambda$  is by definition  $k$ -non-entangling but not  $(k+1)$ -non-entangling map, for all  $1 \leq k < d$ .  $\square$

Now we set out to prove Theorem 5. In the following, we assume  $\mathcal{H}_R = \mathbb{C}^k$  and  $\mathcal{H}_{B_0} = \mathcal{H}_{B_1} = \mathbb{C}^d$  and  $\Lambda \in \text{CPTP}(B_0 \rightarrow B_1)$ . First notice that, in order to prove a channel  $\Lambda$  is  $k$ -EBC, it suffices to show  $\mathbb{1}_R \otimes \Lambda(\varphi)$  is separable for all pure states  $|\varphi\rangle \in \mathcal{H}_R \otimes \mathcal{H}_{B_0}$ , since we can then apply convexity to cover mixed states. Any such pure state can be written as

$$|\varphi\rangle = X \otimes \mathbb{1}_d |\phi_d^+\rangle \quad (49)$$

for some operator  $X \in \mathcal{L}(\mathbb{C}^d \rightarrow \mathbb{C}^k)$ . Let  $X = \sum_{i=1}^r \lambda_i |\alpha_i\rangle\langle\beta_i|$  denote a singular value decomposition of  $X$ , and define  $X^{-1} := \sum_{i=1}^r \lambda_i^{-1} |\beta_i\rangle\langle\alpha_i|$  (with  $\lambda_i > 0$  for  $i = 1, \dots, r$ ). Then  $X^{-1}X = P = \sum_{i=1}^r |\beta_i\rangle\langle\beta_i|$  is a projector of rank  $r \leq k$ . Then since local operators

preserve separability, we have that

$$\text{id} \circ \Lambda[|\phi\rangle\langle\phi|] = \text{id} \circ \Lambda[(X \otimes \mathbb{I}_d)\phi_d^+(X \otimes \mathbb{I}_d)^\dagger]$$

is separable if and only if

$$(X^{-1} \otimes \mathbb{I})\text{id} \circ \Lambda[(X \otimes \mathbb{I}_d)\phi_d^+(X \otimes \mathbb{I}_d)^\dagger](X^{-1} \otimes \mathbb{I})^\dagger = (P \otimes \mathbb{1}_d)J_\Lambda(P^\dagger \otimes \mathbb{1}_d) \quad (50)$$

is separable. We summarize this observation in the following lemma.

**Lemma VI.1.** *A channel  $\Lambda \in \text{CPTP}(B_0 \rightarrow B_1)$  is  $k$ -EBC if and only if the operator*

$$(P \otimes \mathbb{I}_d)J_\Lambda(P^\dagger \otimes \mathbb{I}_d) \quad (51)$$

*is separable for all projectors  $P$  with dimension no larger than  $k$ .*

Now we introduce the Werner states [21] which will play an important role in our construction of  $k$ -EBC. The Werner states are a family of states on  $\mathbb{C}^d \otimes \mathbb{C}^d$  which takes the following form,

$$\rho_d^{\mathcal{W}}(\beta) = \frac{1}{d^2 - (\beta + 1)} \left( \mathbb{I}_{d^2} - \frac{\beta + 1}{d} F_d \right), \quad (52)$$

for  $-(d + 1) \leq \beta \leq d - 1$ , where  $F_d = \sum_{ij} |i\rangle\langle j| \otimes |j\rangle\langle i|$  is the swap operator (or the partial transpose of  $\phi_d^+$ ). A crucial observation is that the partial trace of a Werner state is  $\frac{1}{d}\mathbb{I}_d$ , which means it is a valid Choi matrix of some CPTP quantum channel (with some normalization). Specifically, consider the following map,

$$\Lambda_\beta(\rho_{B_0}) := d \text{Tr}_{B_0}[\rho_d^{\mathcal{W}}(\beta)(\rho_{B_0}^T \otimes \mathbb{I}_{B_1})]. \quad (53)$$

This map is clearly completely positive, and it is also trace-preserving since

$$\begin{aligned} \text{Tr}(\Lambda_\beta(\rho_{B_0})) &= \text{Tr}[d \text{Tr}_{B_1}(\rho_d^{\mathcal{W}}(\beta)) \rho_{B_0}] \\ &= \text{Tr}(\mathbb{I}_d \rho_{B_0}) \\ &= \text{Tr}(\rho_{B_0}), \end{aligned} \quad (54)$$

where the second equation is from our observation on the partial trace of Werner states. We conclude that  $\Lambda_\beta \in \text{CPTP}(B_0 \rightarrow B_1)$ .

Since  $\rho_d^{\mathcal{W}}(\beta)$  is the Choi matrix of  $\Lambda_\beta$  up to normalization, we can apply Lemma VI.1 by studying the separability properties of  $\rho_d^{\mathcal{W}}(\beta)$ . The following lemma is modified from Lemma 19 in [19].

**Lemma VI.2.** *Let  $k$  and  $d$  be integers such that  $1 \leq k < d$  and let  $-(d+1) \leq \beta \leq d-1$ . The operator*

$$\rho_{RB_1}^{\text{proj}} := (P \otimes \mathbb{I}_d) \rho_d^{\mathcal{W}}(\beta) (P \otimes \mathbb{I}_d)$$

*is separable for all projectors  $P$  with dimension no greater than  $k$  if and only if  $\beta \leq (d-k)/k$ .*

*Proof.* (Proof of lemma VI.2) We first require  $P$  to be a  $k$ -dimensional projector in  $\mathcal{L}(B_0 \rightarrow B_1)$ . By direct calculation, we have

$$\rho_{RB_1}^{\text{proj}} \propto \mathbb{I}_{kd} - \frac{\beta+1}{d} \left( (P \otimes \mathbb{I}_d) F_d (P^\dagger \otimes \mathbb{I}_d) \right) \quad (55)$$

$$= \mathbb{I}_{kd} - \frac{\beta+1}{d} \left( (P^* \otimes \mathbb{I}_d) \phi_d^+ (P^\Gamma \otimes \mathbb{I}_d) \right)^\Gamma \quad (56)$$

$$= \mathbb{I}_{kd} - \frac{\beta+1}{d} c \psi^\Gamma, \quad (57)$$

for some normalized pure state  $|\psi\rangle = (P^* \otimes \mathbb{I}_d) |\phi_d^+\rangle / \sqrt{c}$ , with normalizing factor

$$c = \text{Tr} \left( (P^* \otimes \mathbb{I}_d) \phi_d^+ (P^\Gamma \otimes \mathbb{I}_d) \right) \quad (58)$$

$$= \text{Tr} \left( \bar{P} P^\Gamma \right) = \text{Tr} \left( P P^\dagger \right) = k. \quad (59)$$

If  $\beta > (d-k)/k$ , then  $\frac{\beta+1}{d} k > 1$  and so

$$\left( \rho_{RB_1}^{\text{proj}} \right)^\Gamma = \mathbb{I}_{kd} - \frac{\beta+1}{d} k \psi \quad (60)$$

is obviously not positive. A non-positive partial transpose implies that  $\rho_{RB_1}^{\text{proj}}$  is entangled. On the other hand, if  $\beta \leq (d-k)/k$ , we apply Theorem 1 from [22] which states that the operator  $\mathbb{1} + A$  is separable for all Hermitian  $A$  with  $\|A\|_2 \leq 1$ , where  $\|A\|_2 = \sqrt{\text{Tr} A^\dagger A}$

is the Frobenius norm. Here, we have

$$\left\| \frac{\beta + 1}{d} k \psi^\Gamma \right\|_2 \leq \|\psi^\Gamma\|_2 = \|\psi\|_2 = 1, \quad (61)$$

since  $\psi$  is a normalized pure state. We therefore conclude that  $\rho_{RB_1}^{\text{proj}}$  is separable. This establishes that  $\rho_{RB_1}^{\text{proj}}$  is separable for all  $k$ -dimensional projectors  $P$  if and only if  $\beta \leq (d - k)/k$ . Since any projector of dimension strictly less than  $k$  can be implemented by first performing a  $k$ -dimensional projector and then projecting into a smaller subspace, it immediately follows that  $\rho_{RB_1}^{\text{proj}}$  is separable for all projectors  $P$  of dimension no greater than  $k$  if and only if  $\beta \leq (d - k)/k$ . This completes the proof of Lemma VI.2.  $\square$

As a direct result of Lemma VI.1 and Lemma VI.2, the channel  $\Lambda_\beta$  constructed in Eq. (53) is  $k$ -EBC if and only if  $\beta \leq (d - k)/k$ , for  $1 \leq k < d$ . This completes the proof of Theorem 5.

## B. Interplay between $k$ -EBC and $(k, \text{complete})$ -EBSC

In this subsection, we discuss the interplay between generalized EBC and generalized EBSC. For simplicity, the systems  $A, B$ , we consider are both required to have  $d$ -dimensional input and output systems. We will also restrict attention to the special class of superchannels that allow for a realization without the side-channel  $E$ .

**Definition VI.4.** A superchannel  $\Theta$  is said to be *without side-channel*, if it can be realized as

$$\Theta^{A \rightarrow B}[\mathcal{E}^A] = \Gamma_{\text{post}}^{A_1 \rightarrow B_1} \circ \mathcal{E}^A \circ \Gamma_{\text{pre}}^{B_0 \rightarrow A_0} \quad (62)$$

for some CPTP maps  $\Gamma_{\text{pre}}$  and  $\Gamma_{\text{post}}$ .

**Corollary 2.** If an EBSC  $\Theta^{A \rightarrow B}$  has a realization without side-channel as in Eq. 62, then both  $\Gamma_{\text{pre}}^{B_0 \rightarrow A_0}$  and  $\Gamma_{\text{post}}^{A_1 \rightarrow B_1}$  must be entanglement breaking channels.

*Proof.* This simply follows from Thm. 1. (D) and the definition of EB channels.  $\square$

The following proposition discusses the relation between  $k$ -EBC and  $(k, \text{complete})$ -EBSC, for any positive integer  $k \leq d$ .



**Proposition 5.** For a superchannel  $\Theta^{A \rightarrow B}$  without side-channel as in Eq. 62, the following are equivalent.

1.  $\Theta^{A \rightarrow B}$  is a  $(k, \text{complete})$ -EBSC.
2.  $\Gamma_{\text{pre}}^{B_0 \rightarrow A_0}$  is a  $k$ -EBC, and  $\Gamma_{\text{post}}^{A_1 \rightarrow B_1}$  is a completely-EBC.

As a result, the realization of a  $(k, \text{complete})$ -EBSC without side-channel is shown in Fig. 14.

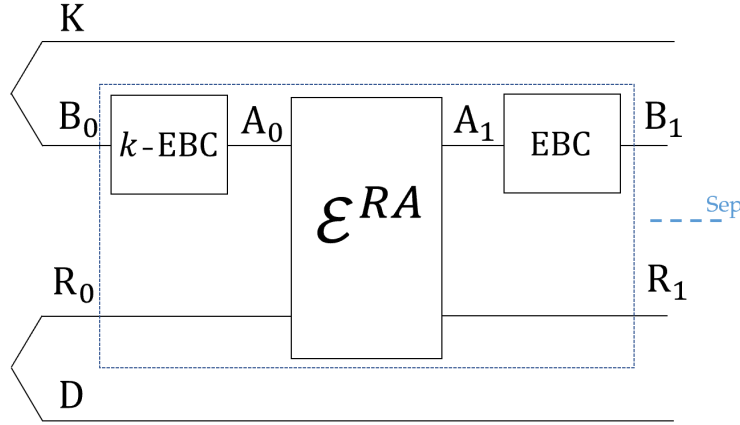

Figure 14. Realization of a  $(k, \text{complete})$ -EBSC without side-channel (in the blue dash box).

*Proof.*  $1 \Rightarrow 2$ : Choose system  $R$  to have  $d_{R_0} = d_{R_1} = d$ , Let  $D$  be a  $d$ -dimensional system,  $K$  be a  $k$ -dimensional system. Consider the CP map  $\Phi_+^{RA}(\cdot) = \text{Tr}((\cdot)\phi_+^{R_0 A_0})\phi_+^{R_1 A_1}$ , the maximally entangled state  $\phi_+^{R_0 D}$ , and an arbitrary quantum state  $\rho \in \mathcal{D}(B_0 K)$ . We have

$$\left( \text{id}^{KD} \otimes (\mathbb{1}^R \otimes \Theta^{A \rightarrow B}[\Phi_+^{RA}]) \right) (\rho^{B_0 K} \otimes \phi_+^{R_0 D}) \quad (63)$$

$$= \Gamma_{\text{pre}}^{B_0 \rightarrow D}(\rho^{B_0 K}) \otimes \Gamma_{\text{post}}^{A_1 \rightarrow B_1}(\phi_+^{R_1 A_1}). \quad (64)$$

Since  $\Theta$  is  $(k, \text{complete})$ -EBSC, the above state must be separable with respect to  $KB_1 : DR_1$ , which means both  $\Gamma_{\text{pre}}^{B_0 \rightarrow D}(\rho^{B_0 K})$  and  $\Gamma_{\text{post}}^{A_1 \rightarrow B_1}(\phi_+^{R_1 A_1})$  are separable. The former implies  $\Gamma_{\text{pre}}$  is  $k$ -EBC since  $\rho$  is an arbitrary state on  $B_0 K$ . The latter implies  $\Gamma_{\text{post}}$  is (completely) EBC by Proposition. 1 [3]. This complete the proof of  $1 \Rightarrow 2$ .

$2 \Rightarrow 1$ : Consider the circuit in Fig. 14. For any separable input  $\rho^{B_0 K} \otimes \phi_+^{R_0 D}$ , it's easy to see the output state is  $K : B_1 : R_1 D$  separable, which means  $\Theta^{A \rightarrow B}$  is indeed  $(k, d)$ -EBSC.  $\square$

Since the hierarchy of  $k$ -EBC is non-trivial, there is also a non-trivial hierarchy of  $(k, \text{complete})$ -EBSC, for  $1 \leq k \leq d$ .

## VII. CONCLUSION AND DISCUSSION

In this paper, we introduce and thoroughly study the notion of entanglement-breaking superchannels (EBSCs). These are objects that generalize and extend the standard notion of entanglement-breaking channels (EBCs) to “higher-order” quantum maps. On the one hand, EBSCs allow for relatively simple characterization via the Choi matrix, just like its channel counterpart. On the other hand, they can also exhibit some interesting properties, which make them much more complex than EBCs in many aspects. Firstly, we show that not all EBSCs can be decomposed into partly-EB pre/post-processing channels. Secondly, we show that EBSC is more general than measure-and-prepare superchannels (MPSCs), and even control-measure-and-prepare superchannels (CMPSCs), while for EBC these three classes coincide. Finally, we illustrate a super-activation phenomenon of EBSCs.

We further investigate which quantum channels can be generated using EBSCs, as well as the smaller classes of MPSCs and CMPSCs. We show that the CPTP-complete image of MPSC/CMPSC equals one/two-round LOCC maps, respectively. Although we are not able to precisely characterize the CPTP-complete image of EBSC, we show that its CP-complete image equals the collection of all separable maps. We argue that the notion of CP image captures some fundamental difference between channels and superchannels, and we hope these results might inspire new lines of investigation into probabilistic channel conversion.

In the final section of this paper, we establish a relationship between  $k$ -EBC,  $k$ -non-entangling channel and  $(k, \text{complete})$ -EBSC without side-channel. By generalizing the method of [19], we show that all these three objects have a non-trivial hierarchy for  $1 \leq k \leq d$ . We remark that other alternative definitions of EBSC are also possible. One can require the output of EBSC to be not only separable, but also LOCC, or even LOSR (local operations and shared randomness). In this sense, our definition of MPSC (CMPSC) is just an example of one-round (two-round) LOCC-EBSC, but it remains unclear whether every one-round (two-round) LOCC-EBSC can be realized this way. In other words, whether

$\text{MPSC} \subseteq \text{LOCC}_1\text{-EBSC}$  and  $\text{CMPSC} \subseteq \text{LOCC}_2\text{-EBSC}$  are strict inclusions needs further investigation.

Our work provides a useful tool for the dynamical resource theory of quantum entanglement. Many results in entanglement theory based on EBCs can possibly be generalized to the dynamical resource theory with EBSC. For example, inspired by the resource theory of quantum memory where EBCs are a free resource [23], one can consider the ability to faithfully store a quantum operation, perhaps call it a "super-memory", where EBSC may serve as free resource. We leave this for future work. Also, since we have characterized the Choi matrix of an EBSC, it is straightforward to calculate a robustness-type quantity with respect to it, similar to what has been done in [24]. We anticipate there being other applications of EBSC within the quantum the study of dynamical quantum resource theories.

There are some problems left open in our work. The first is whether the deterministic image of EBSC equals the set of all separable channels, namely whether  $C_{\text{EBSC}} = \text{SEP}$  or not. Currently we only know that all two-round LOCC and some non-LOCC separable channels are in  $C_{\text{EBSC}}$ . The second is whether every EBSC can be realized as in Fig. 5. Answering these questions will help us better understand the intricate structure of EBSCs.

## ACKNOWLEDGMENTS

SC acknowledges the support from the Tsinghua Scholarship for Undergraduate Oversea Studies. EC is supported by the National Science Foundation (NSF) Award No. 1914440.

- 
- [1] J. I. Cirac, W. Dür, B. Kraus, and M. Lewenstein, *Phys. Rev. Lett.* **86**, 544 (2001).
  - [2] G. Chiribella, G. M. D'Ariano, and P. Perinotti, *EPL (Europhysics Letters)* **83**, 30004 (2008).
  - [3] M. Horodecki, P. W. Shor, and M. B. Ruskai, *Reviews in Mathematical Physics* **15**, 629 (2003).
  - [4] E. Chitambar and G. Gour, *Rev. Mod. Phys.* **91**, 025001 (2019).
  - [5] T. Theurer, D. Egloff, L. Zhang, and M. B. Plenio, *Phys. Rev. Lett.* **122**, 190405 (2019).

- [6] G. D. Berk, A. J. P. G. nad Benjamin Yadin, K. Modi, and F. A. Pollock, "Resource theories of multi-time processes: A window into quantum non-markovianity," (2019), arXiv:1907.07003.
- [7] Y. Liu and X. Yuan, "Operational resource theory of quantum channels," (2019), arXiv:1904.02680.
- [8] Z.-W. Liu and A. Winter, "Resource theories of quantum channels and the universal role of resource erasure," (2019), arXiv:1904.04201.
- [9] G. Gour and A. Winter, "How to quantify a dynamical resource?" (2019), arXiv:1906.03517.
- [10] G. Gour and C. M. Scandolo, "The entanglement of a bipartite channel," (2019), arXiv:1907.02552.
- [11] S. Bäuml, S. Das, X. Wang, and M. M. Wilde, "Resource theory of entanglement for bipartite quantum channels," (2019), arXiv:1907.04181.
- [12] G. Gour, *IEEE Transactions on Information Theory*, 1 (2019).
- [13] J. Burniston, M. Grabowecky, C. M. Scandolo, G. Chiribella, and G. Gour, "Necessary and sufficient conditions on measurements of quantum channels," (2019), arXiv:1904.09161.
- [14] C. H. Bennett, D. P. DiVincenzo, C. A. Fuchs, T. Mor, E. Rains, P. W. Shor, J. A. Smolin, and W. K. Wootters, *Phys. Rev. A* **59**, 1070 (1999).
- [15] G. Chiribella, G. M. D'Ariano, and P. Perinotti, *Phys. Rev. Lett.* **101**, 060401 (2008).
- [16] G. Chiribella, G. M. D'Ariano, and P. Perinotti, *Phys. Rev. A* **80**, 022339 (2009).
- [17] E. Chitambar, D. Leung, L. Mančinska, M. Ozols, and A. Winter, *Communications in Mathematical Physics* **328**, 303 (2014).
- [18] W. Dür, G. Vidal, and J. I. Cirac, *Phys. Rev. A* **62**, 062314 (2000).
- [19] E. Chitambar, J. I. de Vicente, M. W. Girard, and G. Gour, "Entanglement manipulation and distillability beyond locc," (2017), arXiv:1711.03835.
- [20] D. Chruściński and A. Kossakowski, *Open Systems & Information Dynamics* **13**, 17 (2006).
- [21] R. F. Werner, *Phys. Rev. A* **40**, 4277 (1989).
- [22] L. Gurvits and H. Barnum, *Phys. Rev. A* **66**, 062311 (2002).
- [23] D. Rosset, F. Buscemi, and Y.-C. Liang, *Phys. Rev. X* **8**, 021033 (2018).
- [24] X. Yuan, Y. Liu, Q. Zhao, B. Regula, J. Thompson, and M. Gu, "Robustness of quantum memories: An operational resource-theoretic approach," (2019), arXiv:1907.02521.