

Motzkin path on RNA abstract shapes

Sang Kwan Choi¹

*Center for Theoretical Physics, College of Physical Science and Technology
Sichuan University, Chengdu 610064, China*

Abstract

We consider a certain abstract of RNA secondary structures, which is closely related to RNA shapes. The generating function counting the number of the abstract structures is obtained by means of Narayana numbers and 2-Motzkin paths, through which we provide an identity related to Narayana numbers and Motzkin polynomials. Furthermore, we show that a combinatorial interpretation on 2-Motzkin paths leads to the correspondence between 1-Motzkin paths and RNA shapes, which facilitates probing further classifications or abstractions of the shapes. In this paper, we classify the shapes with respect to the number of components and calculate their asymptotic distributions.

Keywords: *RNA shape; Motzkin path; Narayana number; Asymptotics*

1 Introduction

Ribonucleic acid (RNA) is a single stranded molecule with a backbone of nucleotides, each of which has one of the four bases, adenine (A), cytosine (C), guanine (G) and uracil (U). Base pairs are formed intra-molecularly between A-U, G-C or G-U, leading the sequence of bases to form helical regions. The primary structure of an RNA is merely the sequence of bases and its three-dimensional conformation by base pairs is called the tertiary structure. As an intermediate structure between the primary and the tertiary, the secondary structure is a planar structure allowing only nested base pairs. This is easy to see in its diagrammatic representation, see Fig.1. A sequence of n bases is that of labeled vertices $(1, 2, \dots, n)$ in a horizontal line and base pairs are drawn as arcs in the upper half-plane. The condition of nested base pairs means non-crossing arcs: for two arcs (i, j) and (k, l) where $i < j$, $k < l$ and $i < k$, either $i < j < k < l$ or $i < k < l < j$. Since the functional role of an RNA depends mainly on its 3D conformation, prediction of RNA folding from the primary structure has long been an important problem in molecular biology. The most common approach for the prediction is free energy minimization and many algorithms to compute the structures with minimum free energy have been developed (see for instance, [1, 2, 3, 4]).

On the other hand, RNA structures are often considered as combinatorial objects in terms of representations such as strings over finite alphabets, linear trees or the diagrams. Combinatorial approaches enumerate the number of possible structures under various kinds of constraints and observe its statistics to compare with experimental findings [5, 6, 7, 8, 9]. They also provide classifications of structures to advance prediction algorithms [10, 11, 12, 13].

In this paper, we consider a certain abstract of secondary structures under a combinatorial point of view regardless of primary structures. The abstract structure is, in fact, closely related to so-called RNA shapes [11, 14, 15], see section 3. Although we will consider it apart from prediction algorithms, let us briefly review the background to RNA shapes in the context of

¹email: hermit1231@sogang.ac.kr; skchoi@scu.edu.cn

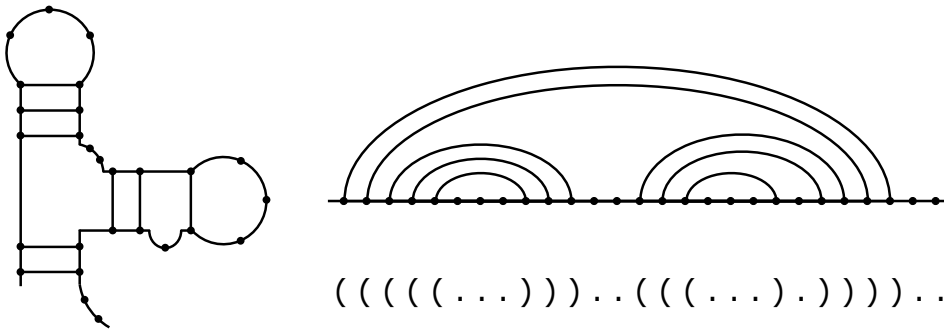

Figure 1: Representations of secondary structures. The RNA structure on the left hand side is represented as the diagram (top right) and the dot-bracket string (bottom right).

prediction problem. In free energy minimization scheme, the lowest free energy structures are not necessarily native structures. One needs to search suboptimal foldings in a certain energy bandwidth and, in general, obtains a huge set of suboptimal foldings. RNA shapes classify the foldings according to their structural similarities and provide so-called shape representatives such that native structures can be found among those shape representatives. Consequently, it can greatly narrow down the huge set of suboptimal foldings to probe in order to find native structures.

In the following preliminary, we introduce our combinatorial object, what we call island diagram and present basic definitions needed to describe the diagram. In section 2, we find the generating function counting the number of island diagrams in two different ways and through which, one may see the relation between Narayana numbers and 2-Motzkin paths. In particular, we find a combinatorial identity, see equation (2.6), which generalizes the following two identities that Coker provided [16] (see also [17] for a combinatorial interpretation):

$$\sum_{k=1}^n \frac{1}{n} \binom{n}{k} \binom{n}{k-1} x^{k-1} = \sum_{k=0}^{\lfloor \frac{n-1}{2} \rfloor} C_k \binom{n-1}{2k} x^k (1+x)^{n-2k-1} \quad (1.1)$$

$$\sum_{k=1}^n \frac{1}{n} \binom{n}{k} \binom{n}{k-1} x^{2(k-1)} (1+x)^{2(n-k)} = \sum_{k=1}^n C_k \binom{n-1}{k-1} x^{k-1} (1+x)^{k-1} \quad (1.2)$$

where C_k is the Catalan number defined by $C_k = \frac{1}{k+1} \binom{2k}{k}$ for $k \geq 0$. A combinatorial interpretation on 2-Motzkin paths is given in accordance with island diagrams. The interpretation implies the bijection between π -shapes and 1-Motzkin paths which was shown in [18, 19]. The refined bijection map facilitates exploring further classifications or abstractions of π -shapes. As one immediate attempt, in section 3, we classify π -shapes according to the number of components, of which the generating function is calculated. Asymptotic distributions of the number of π -shapes are presented as a function of the number of components. Section 1 and Section 2 overlap in part with [20].

Preliminary

A formal definition of secondary structures is given as follows:

Definition 1.1 (Waterman [10]). A secondary structure is a vertex-labeled graph on n vertices with an adjacency matrix $A = (a_{ij})$ (whose element $a_{ij} = 1$ if i and j are adjacent, and $a_{ij} = 0$

otherwise with $a_{ii} = 0$) fulfilling the following three conditions:

1. $a_{i,i+1} = 1$ for $1 \leq i \leq n - 1$.
2. For each fixed i , there is at most one $a_{ij} = 1$ where $j \neq i \pm 1$
3. If $a_{ij} = a_{kl} = 1$, where $i < k < j$, then $i \leq l \leq j$.

An edge (i, j) with $|i - j| \neq 1$ is said to be a base pair and a vertex i connected only to $i - 1$ and $i + 1$ is called unpaired. We will call an edge $(i, i + 1)$, $1 \leq i \leq n - 1$, a backbone edge. Note that a base pair between adjacent two vertices is not allowed by definition and the second condition implies non-existence of base triples.

There are many other representations of secondary structures than the diagrammatic representation. In this paper, we often use the so-called dot-bracket representation, see figure 1. A secondary structure can be represented as a string \mathbf{S} over the alphabet set $\{(,), \cdot\}$ by the following rules [6]:

1. If vertex i is unpaired then $\mathbf{S}_i = \cdot$.
2. If (i, j) is a base pair and $i < j$ then $\mathbf{S}_i = ($ and $\mathbf{S}_j =)$.

In the following, we present the basic definitions of structure elements needed for our investigations.

Definition 1.2. A secondary structure on $(1, 2, \dots, n)$ consists of the following structure elements (cf. Fig.2). By a base pair (i, j) , we always assume $i < j$.

1. The sequence of unpaired vertices $(i + 1, i + 2, \dots, j - 1)$ is a *hairpin* if (i, j) is a base pair. The pair (i, j) is said to be the *foundation of the hairpin*.
2. The sequence of unpaired vertices $(i + 1, i + 2, \dots, j - 1)$ is a *bulge* if either (k, j) , $(k + 1, i)$ or $(i, k + 1)$, (j, k) are base pairs.
3. A *tail* is a sequence of unpaired vertices $(1, 2, \dots, i - 1)$, resp. $(j + 1, j + 2, \dots, n)$ such that i , resp. j is paired.
4. An *interior loop* is two sequences of unpaired vertices $(i + 1, i + 2, \dots, j - 1)$ and $(k + 1, k + 2, \dots, l - 1)$ such that (i, l) and (j, k) are pairs, where $i < j < k < l$.
5. For any $k \geq 3$ and $0 \leq l, m \leq k$ with $l + m = k$, a *multi loop* is l sequences of unpaired vertices and m empty sequences $(i_1 + 1, \dots, j_1 - 1), (i_2 + 1, \dots, j_2 - 1), \dots, (i_k + 1, \dots, j_k - 1)$ such that $(i_1, j_k), (j_1, i_2), \dots, (j_{k-1}, i_k)$ are base pairs. A sequence $(i + 1, \dots, j - 1)$ is an empty sequence if $i + 1 = j$.
6. For any $k \geq 2$ and $0 \leq l, m \leq k$ with $l + m = k$, an *external loop* is l sequences of unpaired vertices and m empty sequences $(1, \dots, j_1 - 1), (i_2 + 1, \dots, j_2 - 1), \dots, (i_k + 1, \dots, n)$ such that $(j_1, i_2), \dots, (j_{k-1}, i_k)$ are base pairs. The number of *components* is $k - 1$.
7. A *stack (or stem)* consists of uninterrupted base pairs $(i + 1, j - 1), (i + 2, j - 2), \dots, (i + k, j - k)$ such that neither (i, j) nor $(i + k + 1, j - k - 1)$ is a base pair. Here the *length* of the stack is k .

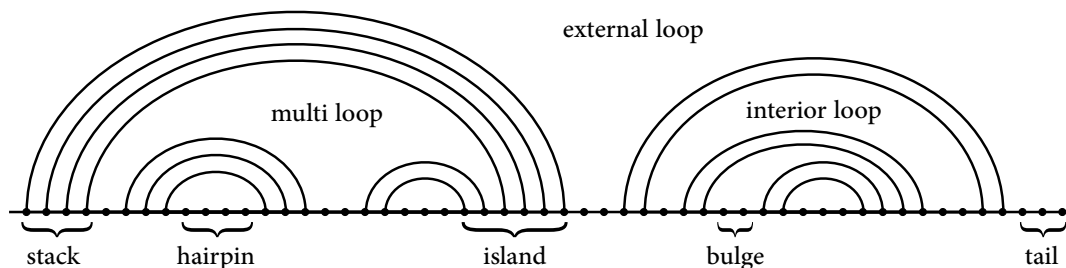

Figure 2: Structure elements of secondary structures.

Note that, while other structure elements consist of at least one vertex, a multiloop and an external loop do not necessarily have a vertex. In the diagrammatic representation, a multiloop is a structure bounded by three or more base pairs and backbone edges.

In addition to the structure elements, we define an auxiliary element indicating a sequence of maximally consecutive paired vertices:

Definition 1.3. An *island* is a sequence of paired vertices $(i, i + 1, \dots, j)$ such that

1. $i - 1$ and $j + 1$ are both unpaired, where $1 < i \leq j < n$.
2. $j + 1$ is unpaired, where $i = 1$ and $1 \leq j < n$.
3. $i - 1$ is unpaired, where $1 < i \leq n$ and $j = n$.

Now we introduce the abstract structures to consider in the next section. From here on, we will call the structures *island diagrams* for convenience. An island diagram (cf. Fig.3) is obtained from secondary structures by

1. Removing tails.
2. Representing a sequence of consecutive unpaired vertices between two islands by a single blank.

Accordingly, we retain unpaired regions except for tails but do not account for the number of unpaired vertices. In terms of the dot-bracket representation, we shall use the underscore “_” for the blank: for example, the island diagram “((_)_)” abstracts the secondary structure “((...)....)”. Since the abstraction preserves all the structure elements (except for tails) in the definition 1.2, we will use them to describe island diagrams in such a way that, for instance, the blank is a hairpin if its left and right vertices are paired to each other.

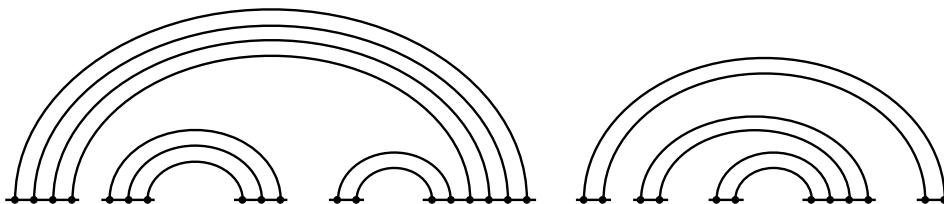

Figure 3: An example of island diagrams. This island diagram is the abstract structure of the secondary structure given in the figure 2.

2 Generating function for island diagram

We enumerate the number of island diagrams $g(h, I, \ell)$, filtered by the number of hairpins(h), islands(I) and basepairs(ℓ). Let $G(x, y, z) = \sum_{h, I, \ell} g(h, I, \ell) x^h y^I z^\ell$ denote the corresponding generating function. We obtain the generating function in two different ways, by means of Narayana numbers and 2-Motzkin paths. In particular, we provide a bijection map between 2-Motzkin paths and sequences of matching brackets.

2.1 Narayana number

The easiest way to obtain the generating function $G(x, y, z)$ is to use a combinatorial interpretation of the Narayana numbers, which are defined by

$$N(n, k) = \frac{1}{n} \binom{n}{k} \binom{n}{k-1}, \quad 1 \leq k \leq n. \quad (2.1)$$

The Narayana number $N(n, k)$ counts the number of ways arranging n pairs of brackets to be correctly matched and contain k pairs as “()”. For instance, the bracket representations for $N(4, 2) = 6$ are given as follows:

$$((()())) \quad ((()())) \quad ((())()) \quad ()((())) \quad (())(()) \quad (((())))()$$

It is easy to recover island diagrams from this representation.

Proposition 2.1. *The generating function has the form*

$$G(x, y, z) = \sum_{\ell, h} N(\ell, h) x^\ell y^{h+1} (1+y)^{2\ell-1-h} z^\ell. \quad (2.2)$$

Its closed form is

$$G(x, y, z) = \left(\frac{y}{1+y} \right) \frac{1 - A(1+B) - \sqrt{1 - 2A(1+B) + A^2(1-B)^2}}{2A} \quad (2.3)$$

where $A = z(1+y)^2$ and $B = xy/(1+y)$.

Proof. One may immediately associate bracket representations of the Narayana numbers with island diagrams. Without regard to underscores, the pair of brackets is associated with the basepair and the sub-pattern “()” corresponds to the foundation of the hairpin. It clearly explains the factor $N(\ell, h)x^\ell y^{h+1}$. Now we consider the insertions of underscores to recover the string representation of island diagrams. Recall that, in secondary structures, a hairpin consists of at least one unpaired vertices. Therefore, the foundation of the hairpin “()” must contain an underscore “()”. The number h of underscores are so inserted that we have the factor y^{h+1} . After the insertion of hairpin underscores, there are $(2\ell - 1 - h)$ places left to possibly insert underscores. The numbers of all possible insertions are summarized by the factor $(1+y)^{2\ell-1-h}$. Therefore, one obtains the form (2.2). The generating function of the Narayana numbers is well-known (see for instance [21]) so that one writes the closed form (2.3). \square

2.2 2-Motzkin path

The generating function $G(x, y, z)$ can also be written in terms of Motzkin polynomial coefficients. The Motzkin numbers M_n and the Motzkin polynomial coefficients $M(n, k)$ are defined as

$$M_n = \sum_{k=0}^{\lfloor n/2 \rfloor} M(n, k) \quad \text{where} \quad M(n, k) = \binom{n}{2k} C_k. \quad (2.4)$$

Let us consider the combinatorial identity in the following theorem. It is easy to prove using the generating function of the Motzkin polynomials:

$$m(v, w) := \sum_{n \geq 0} \sum_{k=0}^{\lfloor n/2 \rfloor} M(n, k) w^n v^k = \frac{1 - w - \sqrt{(1-w)^2 - 4vw^2}}{2vw^2}. \quad (2.5)$$

Theorem 2.1. *For any integer $\ell \geq 1$, there holds*

$$\begin{aligned} & \frac{y}{1+y} \sum_{h=1}^{\ell} N(\ell, h) (xy)^h (1+y)^{2\ell-h} \\ &= x y^2 \sum_{p=0}^{\lfloor \frac{\ell-1}{2} \rfloor} M(\ell-1, p) (xy(1+y)^3)^p ((1+y)(1+y+xy))^{\ell-2p-1}. \end{aligned} \quad (2.6)$$

Proof. The left hand side is $[z^\ell]G(x, y, z)$ given in (2.2). Multiplying z^ℓ and taking the summation over ℓ at each side, one can check that the right hand side is indeed the generating function $G(x, y, z)$. \square

Note that the identity (2.6) reproduces the Coker's two identities. When we substitute x/y for x and then put $y = 0$, we get the identity (1.1). Furthermore, the substitution $x \rightarrow y/(1+y)$ leads to the identity (1.2).¹

We will investigate how the right hand side in (2.6) represents island diagrams. In order to do that, we need a combinatorial interpretation of 2-Motkzin paths. Let us first introduce the Motkzin paths, that can also be called 1-Motkzin paths. A Motkzin path of size n is a lattice path starting at $(0, 0)$ and ending at $(n, 0)$ in the integer plane $\mathbb{Z} \times \mathbb{Z}$, which satisfies two conditions: (i) It never passes below the x -axis. (ii) Its allowed steps are the up step $(1, 1)$, the down step $(1, -1)$ and the horizontal step $(1, 0)$. We denote by U , D and H an up step, a down step and a horizontal step, respectively. The Motkzin polynomial coefficient $M(n, k)$ is the number of Motkzin paths of size n with k up steps. Since the Motkzin number M_n is given by the sum of $M(n, k)$ over the number of up steps, M_n is the number of Motkzin paths of size n . See for instance, the following figure depicting a Motkzin path of $M(7, 2)$:

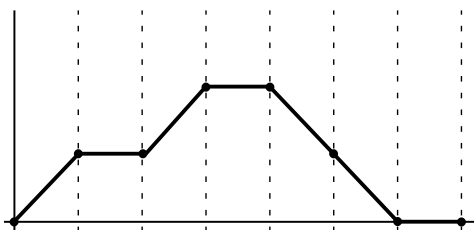

Figure 4: Motkzin path of $UHUHDDH$.

On the other hand, 2-Motkzin paths allow two kinds of horizontal steps, which often distinguish one from another by a color, let us say, R and B denoting a red and a blue step, respectively. We provide a bijection map between 2-Motkzin paths and strings of matching brackets.² Suppose we have a 2-Motkzin path of size n given by a string $q_1 q_2 \cdots q_n$ over the set $\{U, D, R, B\}$. The corresponding string of brackets S_n can be obtained by the following rules:

- (i) We begin with “()” : Let $S_0 = ()$.
- (ii) For any $1 \leq k \leq n$, suppose there exist a string of brackets S' and a string of matching brackets S'' which are possibly empty such that S_{k-1} has the form $S'(S'')$. Then S_k is given by

$$\begin{aligned} S'((S'')()) & \text{ if } q_k = U, & S'(S'') & \text{ if } q_k = D, \\ S'(S'')() & \text{ if } q_k = R, & S'((S'')) & \text{ if } q_k = B. \end{aligned}$$

For example, the string of matching brackets corresponding to the 2-Motkzin path $UBURDD$ is obtained as follows:

$$() \xrightarrow{U} (() \xrightarrow{B} (()() \xrightarrow{U} (()((() \xrightarrow{R} (()((()() \xrightarrow{D} (()((()() \xrightarrow{D} (()((()()())$$

¹ In order to deduce the identity, one may need the Touchard's identity [22]: $C_n = \sum_k C_k \binom{n-1}{2k} 2^{n-2k-1}$, which can also be derived from (1.1) when $x = 1$.

² Sequences of matching brackets are only Dyck paths. A bijection map between Dyck paths and 2-Motkzin paths was introduced by Delest and Viennot [23]. But here we present a different way of mapping than the well-known one.

We remark here that only blue steps can make a stack. In other words, directly nested structures such as “ $(())$ ” never occur without blue steps. Therefore, a 1-Motzkin path can be translated into a string of matching brackets without directly nested brackets. This is one of the 14 interpretations of Motzkin numbers provided by Donaghey and Shapiro in [18]. Later, in [19], it was also shown using context-free grammars in the context of RNA shapes. We also remark that the Motzkin polynomial coefficient $M(\ell - 1, u)$ is the number of ways arranging ℓ pairs of brackets to be correctly matched and contain $\ell - u$ pairs as “ $()$ ” with no occurrence of directly nested bracket.

Now we go back to the generating function on the right hand side in (2.6) and rewrite it as

$$G(x, y, z) = \sum_{\ell, u} M(\ell - 1, u) (xy^2z) ((1 + y)\sqrt{z})^u (xy(1 + y)z)^u \times ((1 + y)\sqrt{z})^d ((1 + y)^2z + xy(1 + y)z)^s \quad (2.7)$$

where u , d and s stand for the number of up, down and horizontal steps, respectively ($u = d$, $u + d + s = \ell - 1$). Let us explain each factor in detail by means of the above rules. The term xy^2z is merely the starting hairpin “ $(-)$ ” (recall that the exponent of x , y and z are the number of hairpins, islands and basepairs, resp.). At each up step, one has a left bracket and a hairpin to add. For a given non-empty string S of island diagrams, suppose that we add a left bracket then there are the two possibilities, “ (S) ” and “ $(-S)$ ” corresponding to \sqrt{z} and $y\sqrt{z}$, respectively. Thus, we get the factor $(1 + y)\sqrt{z}$ at every up step and, in the same manner, at every down step. Likewise, adding a hairpin introduces the factor $xy(1 + y)z$ since “ $S(-)$ ” and “ $S_-(-)$ ” corresponds to xyz and xy^2z , respectively. On the other hand, a horizontal step can be either R or B . A red step is to add a hairpin and corresponds to $xy(1 + y)z$. A blue step is to add one basepair nesting the string “ (S) ” and there are three possibilities: the stack “ $((S))$ ” for z , the two bulges “ $(-(S))$ ” and “ $((S)_-)$ ” for yz and the interior loop “ $(-(S)_-)$ ” for y^2z . Therefore, we get $((1 + y)^2z + xy(1 + y)z)$ at each horizontal step.

3 Motzkin path and RNA shape

The bijection map given in the previous section reduces to the correspondence between 1-Motzkin paths and RNA shapes, which is called π -shape. In this section, we exploit 1-Motzkin paths to classify π -shapes, and their generating functions are given to calculate asymptotics. By Motzkin paths, from here on, we mean 1-Motzkin paths.

3.1 Motzkin path and π -shape

The Motzkin path is closely related to the π -shape (or type 5), which is one of the five RNA abstract shapes provided in [11] classifying secondary structures according to their structural similarities. In order to describe π -shape, let us first consider π' -shape (or type 1). π' -shape is an abstraction of secondary structures preserving their loop configurations and unpaired regions. A stem is represented as one basepair and a sequence of maximally consecutive unpaired vertices is considered as an unpaired region regardless of the number of unpaired vertices in it. In terms of the dot-bracket representation, a length k stem “ $(^k \dots)^k$ ” is represented by a pair of squared brackets “[$\cdot \cdot \cdot$]” and an unpaired region is depicted by an underscore. For instance, the π' -shape “ $-[[[-]-[-]]-]$ ” abstracts the secondary structure “ $\dots((((\dots)((\dots))))\dots)$ ”.

In addition to the abstraction of π' -shape, π -shape ignores unpaired regions. Removing unpaired vertices, two base pairs encircling a bulge or an interior loop become consecutive

base pairs which then merge into a square bracket according to the abstraction of a stem. For example, the π' -shape “ $_{-}[[[-]_{-}[-]_{-}]_{-}$ ” results in the π -shape “ $[[[]]]$ ”. Consequently, π -shapes retain only hairpin and multiloop configurations. One may immediately notice that the string representations of π -shapes are nothing but the sequences of matching brackets without directly nested brackets. Therefore, as is remarked in the previous section, we establish the bijection map between π -shapes and 1-Motzkin paths. Recalling that a red step adds a hairpin and an up step creates a multiloop and a hairpin, the Motzkin polynomial coefficient $M(\ell-1, u)$ is the number of π -shapes with u multiloops and $\ell - u$ hairpins.

It is obvious that π -shapes can be classified with respect to the number of multiloops and hairpins through the bijection map to Motzkin paths. The significance of π -shapes, on the other hand, is that the abstraction enables us to focus on the branching pattern of folding. Although each π -shape has different branching patterns, one may still group them according to a branching pattern similarity. As one attempt to take account of such similarities, we consider here the number of components. Namely, we classify π -shapes by the number of branches of the external loop. Note that the number of components is equivalent to $(r_0 - 1)$ in Motzkin path where r_0 denotes the number of horizontal steps at level 0. Therefore, in other words, we classify Motzkin paths by r_0 .

1-Motzkin path		π -shape
u	\longleftrightarrow	number of multi loops
$u + r + 1$	\longleftrightarrow	number of hairpin loops
$r_0 + 1$	\longleftrightarrow	number of components

Table 1: Relation between Motzkin path and π -shape. u , r and r_0 denote the number of up steps, horizontal steps and horizontal steps at level 0, respectively.

Proposition 3.1. *The number of Motzkin paths of size n with r_0 horizontal steps at level 0 is given by*

$$M(r_0; n) = \sum_{u=1}^{\lfloor \frac{n-r_0}{2} \rfloor} M(r_0; n, u) \quad \text{if } n \neq r_0 \quad (3.1)$$

with $M(n; n) = 1$ where

$$M(r_0; n, u) = \frac{r_0 + 1}{n + 1} \binom{n + 1}{u} F(n - r_0 - 1, u - 1) \quad (3.2)$$

and $F(a, b) = \binom{a-b-1}{b}$ is Fibonacci polynomial coefficient.

Proof. See Appendix A. □

With a fixed size n , one may plot the distribution of $M(r_0; n)$ as a function of r_0 to find that the number of Motzkin paths decreases as r_0 increases for $r_0 \geq 1$. See Figure 5. One interesting feature is that $M(0; n)$ and $M(1; n)$ differ by $(-1)^n$, which is not straightforward to derive for arbitrary n using the explicit form (3.1). In order to prove the feature as well as to investigate the asymptotic distribution at large n , one needs to find its generating function.

Let R_0 stand for a horizontal step at level 0. A brief description of the method is as follows: first we construct the generating function for the Motzkin paths without R_0 and then, put those paths together with R_0 steps to obtain the desired generating function. For convenience, let us denote by $\{\epsilon\}$, \mathcal{M} and \mathcal{A} a path with size zero which means identity, the class of all

Motzkin paths and the class of the Motzkin paths without R_0 , respectively. We begin with the generating function $m(v, w)$ of \mathcal{M} given in (2.5). By adding an up step(U) and a down step(D) at each end of \mathcal{M} , one obtains the class $\widehat{\mathcal{M}}$ of the Motzkin paths that never touch the level 0 apart from the starting and ending points. In terms of the symbolic enumeration methods, this can be written as $\widehat{\mathcal{M}} = U \times \mathcal{M} \times D$. Recalling that v and w in $m(v, w)$ are the expansion variables for up-step and size, $U \times \mathcal{M} \times D$ translates into the generating function $vw^2m(v, w)$. The paths in \mathcal{A} can then be achieved by concatenating the paths in $\widehat{\mathcal{M}}$ that is symbolically represented as

$$\mathcal{A} = SEQ(\widehat{\mathcal{M}}) := \{\epsilon\} + \widehat{\mathcal{M}} + (\widehat{\mathcal{M}} \times \widehat{\mathcal{M}}) + (\widehat{\mathcal{M}} \times \widehat{\mathcal{M}} \times \widehat{\mathcal{M}}) + \dots \quad (3.3)$$

such that one obtains the generating function $A(v, w)$ of \mathcal{A} as

$$A(v, w) = \frac{1}{1 - vw^2m(v, w)}. \quad (3.4)$$

Now we glue the paths in \mathcal{A} together with R_0 steps. With a given number k of R_0 steps, there are $(k + 1)$ empty slots to be filled with either $\{\epsilon\}$ or $(\mathcal{A} \setminus \{\epsilon\})$. For instance, the Motzkin paths with $r_0 = 1$ is represented by

$$(\{\epsilon\} \times R_0 \times \{\epsilon\}) + (\{\epsilon\} \times R_0 \times \mathcal{B}) + (\mathcal{B} \times R_0 \times \{\epsilon\}) + (\mathcal{B} \times R_0 \times \mathcal{B}) \quad (3.5)$$

where $\mathcal{B} = (\mathcal{A} \setminus \{\epsilon\})$ that yields $twA(v, w)^2$ when we employ t as the expansion variable for r_0 . Likewise, when $r_0 = k$, one finds $t^k w^k A(v, w)^{k+1}$. Therefore, the desired generating function is

$$m(t; v, w) := \sum_{r_0, n, u} M(r_0; n, u) t^{r_0} v^u w^n = \frac{A(v, w)}{1 - twA(v, w)}. \quad (3.6)$$

It is now straightforward to prove the relation

$$M(0; n) - M(1; n) = (-1)^n \quad \text{for } n \geq 1 \quad (3.7)$$

since $M(0; n) - M(1; n) = [w^n](A(1, w) - wA(1, w)^2)$ and $A(1, w) - wA(1, w)^2 = 1/(1 + z)$. Furthermore, one can exploit the generating function $m(t; 1, w)$ to find the following asymptotics. See Appendix B.1 for its proof.

Theorem 3.1. *Let r_0 be a non-negative integer. For $r_0 \ll n$, the distribution of $M(r_0; n)$ holds*

$$\lim_{n \rightarrow \infty} \frac{M(r_0; n)}{M_n} = \frac{r_0 + 1}{2^{r_0+2}} \quad (3.8)$$

and at large n limit, the expected number of horizontal steps at level 0 is 2:

$$\lim_{n \rightarrow \infty} \frac{\sum_{r_0} r_0 M(r_0; n)}{M_n} = 2. \quad (3.9)$$

We plot the asymptotic distribution of (3.8) as a function of r_0 in Figure 5. At the limit of large size, the number of Motzkin paths exponentially decreases as r_0 increases when $r_0 \geq 1$, and the half of them is the ones with $r_0 = 0$ and 1.

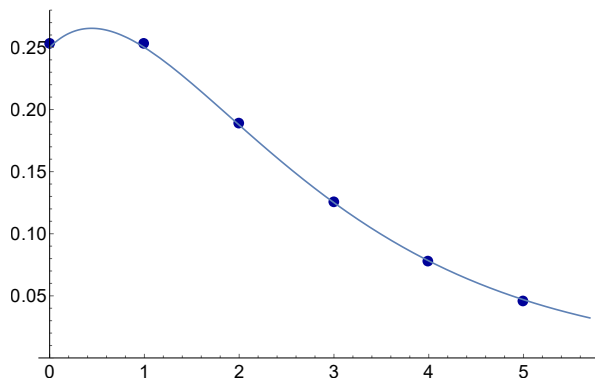

Figure 5: Normalized distribution $M(r_0; n)/M_n$ of Motzkin paths as a function of r_0 . The dots are given for $n = 100$. The line is the asymptotic distribution as $n \rightarrow \infty$.

3.2 π -shapes compatible with secondary structures

In the previous subsection, we considered Motzkin paths of size n , or equivalently, π -shapes of length $2n + 2$. On the other hand, instead of π -shapes with their own length fixed, one may regard π -shapes to which secondary structures of a given length are reducible [19]. Namely, in this subsection, we consider the class of π -shapes compatible with secondary structures of length ν , and classify it according to the number of components. The class of compatible π -shapes is merely the collection of π -shapes of length less than or equal to ν . However, we shall impose an additional constraint on it so-called minimum arc-length which was introduced to reflect the rigidity of the backbone of RNA [5]. The minimum arc-length λ indicates the condition on secondary structures that each hairpin loop consists of at least $\lambda - 1$ unpaired vertices. Therefore, we first construct π -shapes with $\lambda - 1$ unpaired vertices assigned in each hairpin loop and collect such π -shapes of length less than or equal to ν .

Let $\pi_\lambda(r_0; \nu)$ denotes the number of π -shapes compatible with secondary structures of minimum arc-length λ , components $r_0 + 1$ and length ν , and we define $\pi_\lambda(\nu) := \sum_{r_0} \pi_\lambda(r_0; \nu)$. One may obtain its generating function by simply manipulating the expansion variables of $m(t; v, w)$ as follows: first, since $h = n - u + 1$ from Table 1, x is the expansion parameter for h by the change of variables $v \rightarrow v/x$ and $w \rightarrow xw$ with the multiplication of the overall factor x . Second, the change of variables $x \rightarrow xz^{\lambda-1}$ and $w \rightarrow wz^2$ with the overall multiplication z^2 leads to the expansion parameter z to count the number of vertices including unpaired ones in hairpin loops. Third, since only the number of vertices and components are of interest here, taking irrelevant variables as unity, $x = v = w = 1$ results in $z^{\lambda+1}m(t; z^{1-\lambda}, z^{\lambda+1})$ which enumerates the number of π -shapes with $\lambda - 1$ unpaired vertices in each hairpin loop. Finally, multiplying $1/(1 - z)$, one finds the generating function of $\pi_\lambda(r_0; \nu)$

$$\sum_{r_0, \nu} \pi_\lambda(r_0; \nu) t^{r_0} z^\nu = \frac{z^{\lambda+1}}{1-z} m(t; z^{1-\lambda}, z^{\lambda+1}). \quad (3.10)$$

Using the generating function, one can evaluate the following asymptotics. Its proof is given in Appendix B.2.

Theorem 3.2. *Let λ be a positive integer. Suppose that ζ_λ is the smallest root among the positive real roots of the polynomial $z^{2\lambda+2} - 4z^{\lambda+3} - 2z^{\lambda+1} + 1$. For $r_0 \ll \nu$, the asymptotic distribution of compatible π -shapes $\pi_\lambda(\nu)$ with respect to the number $r_0 + 1$ of components is*

given as

$$\lim_{\nu \rightarrow \infty} \frac{\pi_\lambda(r_0; \nu)}{\pi_\lambda(\nu)} = (r_0 + 1) \left(\frac{\zeta_\lambda^2}{1 + \zeta_\lambda^2} \right) \left(\frac{1 + \zeta_\lambda^{\lambda+1}}{2(1 + \zeta_\lambda^2)} \right)^{r_0} \quad (3.11)$$

and the expected number of r_0 satisfies

$$\lim_{\nu \rightarrow \infty} \frac{\sum_{r_0} r_0 \pi_\lambda(r_0; \nu)}{\pi_\lambda(\nu)} = \frac{1 - \zeta_\lambda^{\lambda+1}}{\zeta_\lambda^2}. \quad (3.12)$$

The expected number of components in the collection of compatible π -shapes is then $(1 - \zeta_\lambda^{\lambda+1})/\zeta_\lambda^2 + 1$ at large ν limit. The case of $\lambda = 4$, that is, the minimum of 3 unpaired vertices in each hairpin is often regarded as the most realistic one. As an example, therefore, we plot the distribution for $\lambda = 4$ in Figure 6, in which case, $\zeta_4 \approx 0.7563$ and the asymptotic distribution of (3.11) is given by $(r_0 + 1) \times 0.3639 \times 0.3968^{r_0}$. The number of compatible π -shapes exponentially decreases as the number of components increases. The expected number of r_0 is approximately 1.316 and hence the expected number of components is approximately 2.316.

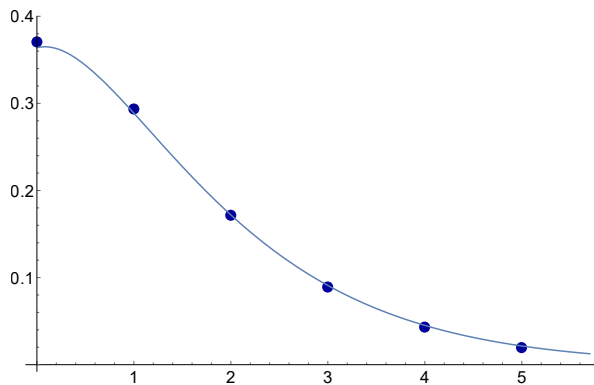

Figure 6: Normalized distribution $\pi_4(r_0; \nu)/\pi_4(\nu)$ as a function of r_0 . The dots are given for $\nu = 200$. The line is the asymptotic distribution at the limit of $\nu \rightarrow \infty$.

4 Conclusion

In this paper, we established the combinatorial interpretation of 2-Motzkin paths to describe the island diagrams. The generating function of island diagrams was calculated using both 2-Motzkin paths and Narayana numbers, from which we found the identity (2.6) generalizing the Coker's identities. The correspondence between 2-Motzkin paths and strings of matching brackets reduces to the bijection map between 1-Motzkin paths and π -shapes. Subsequently, we classified π -shapes by the number of components and calculated the asymptotic distributions and the expected number of components. We observed that the number of compatible π -shapes exponentially decreases as the number of components increases. In the case of $\lambda = 4$, for instance, the asymptotic distribution is given by $(r_0 + 1) \times 0.3639 \times 0.3968^{r_0}$ and the expected number of components is approximately 2.316.

The bijection map between Motzkin paths and π -shapes provides an additional combinatorial tool to explore classifications and abstractions of secondary structures. As one intuitive

and immediate attempt concerning branching pattern similarities, the number of components was taken into account. We will furthermore study on possible abstractions of RNA shapes, which may greatly reduce the number of structures while retaining structural similarities to some extent.

Acknowledgements

This work was supported by the National Science Foundation of China (Grant No. 11575119).

A Proof of Proposition 3.1

In order to classify Motzkin paths according to the number of horizontal steps at level 0, one may begin with Dyck paths. A Dyck path is a lattice path that never passes below the x -axis and allows only the up step and the down step, in other words, a Motzkin path without a horizontal step. The Catalan number C_u is the number of Dyck paths of length $2u$ (*i.e.*, of u up steps), for instance, the number $C_3 = 5$ of paths is shown in Figure 7. Furthermore, it is also known that the number of Dyck paths composed of the number p of irreducible paths, where by irreducible paths, we mean Dyck paths that never touch the x -axis between the starting and ending point. The number is often referred to as Catalan p -fold convolution formula [24, 25]:

$$C(u; p) = \frac{p}{u} \binom{2u - p - 1}{u - 1}. \quad (\text{A.1})$$

For example, $C(3, 1) = 2$, $C(3, 2) = 2$ and $C(3, 3) = 1$.

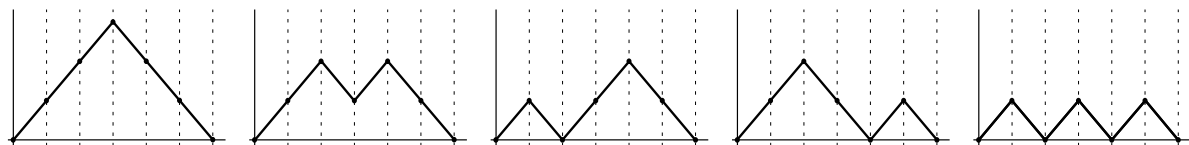

Figure 7: Dyck paths of C_3 . From the left side, the first two are of $C(3, 1)$, the next two are of $C(3, 2)$ and the last one is of $C(3, 3)$.

For given Dyck paths of $C(u; p)$, one adds $n - 2u$ horizontal steps to obtain Motzkin paths of length n . There are $2u + 1$ places into which one possibly inserts horizontal steps, and of which $p + 1$ places are at x -axis. We first put r_0 horizontal steps into the $p + 1$ places and then put the remains into other places. Summing over p , one finds

$$M(r_0; n, u) = \sum_{p=1}^u \binom{r_0 + p}{r_0} \binom{n - r_0 - p - 1}{n - 2u - r_0} C(u; p). \quad (\text{A.2})$$

Note here that when $p = 0$ or equivalently $u = 0$, we still have one Motzkin path consisting of only horizontal steps and thus, $M(n; n, 0) = 1$. One may manipulate (A.2) with the help of the identity analogous to Chu-Vandermonde's identity,

$$\binom{m + n + 1}{n} = \sum_{\alpha=0}^n \binom{m + n - (t + \alpha)}{n - \alpha} \binom{t + \alpha}{\alpha} \quad (\text{A.3})$$

where $0 \leq t \leq m$ and arrive at the final form

$$M(r_0; n, u) = \frac{r_0 + 1}{n + 1} \binom{n + 1}{u} \binom{n - r_0 - u - 1}{u - 1}. \quad (\text{A.4})$$

B Asymptotics

In this section, we briefly demonstrate the procedure calculating the asymptotics needed in Theorem 3.1 and Theorem 3.2. We shall first present theorems exploited to obtain the asymptotics without proof. For their proof and also for more rigorous and complete discussions, one can refer to the book by Flajolet and Sedgewick [26] and the paper by Flajolet and Odlyzko [27].

Theorem B.1. (Exponential Growth Formula). *If $f(z)$ is analytic at 0 and R is the modulus of a singularity nearest to the origin in the sense that*

$$R := \sup \{r \geq 0 \mid f \text{ is analytic in } |z| < r\}, \quad (\text{B.1})$$

then the coefficient $f_n = [z^n]f(z)$ satisfies

$$f_n = R^{-n} \theta(n) \quad (\text{B.2})$$

where θ is a subexponential factor:

$$\limsup |\theta(n)|^{1/n} = 1. \quad (\text{B.3})$$

When $f_n = R^{-n} \theta(n)$, we say that f_n is of exponential order R^{-n} . The singularities which lie on the boundary of the disc of convergence are called dominant singularities. The following theorem guarantees that counting generating functions have positive real numbers as their dominant singularities.

Theorem B.2. (Pringsheim's theorem). *If $f(z)$ is representable at the origin by a series expansion that has non-negative coefficients and radius of convergence R , then the point $z = R$ is a singularity of $f(z)$.*

If a generating function $f(z)$ has its dominant singularity at $z = \zeta$, the rescaled function $f(\zeta z)$ is analytic within the disc $|z| < 1$. Then, one may apply the following theorem to obtain the most dominant contribution of the asymptotic.

Definition B.1. Given two numbers ϕ , R with $R > 1$ and $0 < \phi < \frac{\pi}{2}$, the open domain $\Delta_1(\phi, R)$ is defined as (Fig. 8)

$$\Delta_1(\phi, R) = \{z \mid |z| < R, z \neq 1, |\arg(z - 1)| > \phi\}. \quad (\text{B.4})$$

A function is Δ_1 -analytic if it is analytic in $\Delta_1(\phi, R)$ for some ϕ and R .

Theorem B.3. (Flajolet and Odlyzko). *Assume that $f(z)$ is Δ_1 -analytic and*

$$f(z) \sim (1 - z)^{-\alpha} \quad \text{as } z \rightarrow 1, \quad z \in \Delta_1 \quad (\text{B.5})$$

with $\alpha \notin \{0, -1, -2, \dots\}$. Then, the coefficients of f satisfy

$$[z^n]f(z) \sim \frac{n^{\alpha-1}}{\Gamma(\alpha)}. \quad (\text{B.6})$$

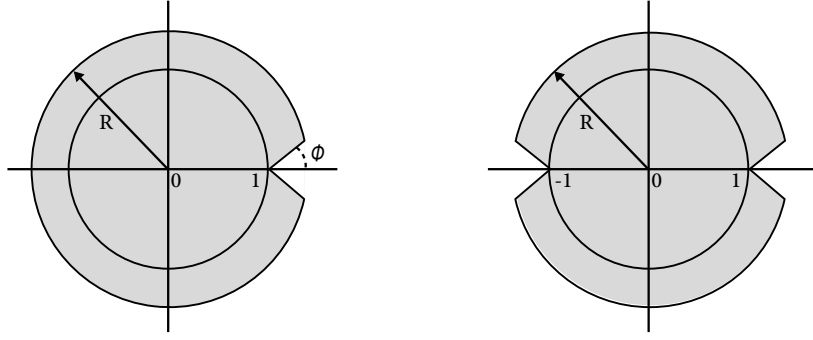

Figure 8: The shaded region is Δ_1 domain (left). When there are two dominant singularities at $z = \pm 1$, the generating function is required to be analytic in the domain on the right.

B.1 Proof of Theorem 3.1

We need to find the asymptotics of M_n , $M(r_0; n)$ and $\sum_{r_0} r_0 M(r_0; n)$. Among the three, the asymptotic of M_n is already well-known: $M_n \sim 3^{n+\frac{3}{2}} / (2\sqrt{\pi} n^{3/2})$. We will not derive it here, nevertheless, one may easily find it as well using the method given below. Then, let us first consider $\sum_{r_0} r_0 M(r_0; n)$. From (3.6), one knows

$$\sum_{r_0} r_0 M(r_0; n) = [w^n] t \frac{\partial}{\partial t} m(t; 1, w) \Big|_{t=1} = [w^n] w m(1, w)^2 \quad (\text{B.7})$$

where the generating function is explicitly given as

$$w m(1, w)^2 = -\frac{w^2 + 2w - 1}{2w^3} - \frac{(1-w)\sqrt{(1+w)(1-3w)}}{2w^3}. \quad (\text{B.8})$$

The former term in the right hand side of (B.8) is just to cancel singular terms in the expansion of w and has no contributions in the coefficient of w^n as $n \rightarrow \infty$. Thus, we consider only the latter part in the singular expansion below. Since the dominant singularity is at $\zeta := 1/3$, by the rescaling $w \rightarrow \zeta w$, the function $\zeta w m(1, \zeta w)^2$ is Δ_1 -analytic. Around the point 1, the expansion of the rescaled function is given by

$$-6\sqrt{3}(1-w)^{1/2} - \frac{81}{4}\sqrt{3}(1-w)^{3/2} + \mathcal{O}((1-w)^{5/2}). \quad (\text{B.9})$$

Then Theorem B.3 applies to yield³

$$[w^n] \zeta w m(1, \zeta w)^2 \sim -6\sqrt{3} \frac{n^{-3/2}}{\Gamma(-\frac{1}{2})} + \mathcal{O}(n^{-5/2}). \quad (\text{B.10})$$

Noting that $[w^n] w m(1, w)^2 = \zeta^{-n} [w^n] \zeta w m(1, \zeta w)^2$, one obtains the dominant contribution in the asymptotic expression as

$$\sum_{r_0} r_0 M(r_0; n) = [w^n] w m(1, w)^2 \sim \frac{3^{n+\frac{3}{2}}}{\sqrt{\pi} n^{3/2}}. \quad (\text{B.11})$$

³ In order to determine the next order contribution, one should take account of the subdominant contribution coming from the term of $(1-w)^{1/2}$ as well as the dominant one from the term of $(1-w)^{3/2}$. Refer to Theorem VI.1 on page 381 of [26]

Therefore, with the asymptotic of Motzkin number, we prove (3.9) in Theorem 3.1 that the expected number of r_0 is 2 at large n limit. In brief, we summarize our procedure to find the asymptotics as follows: given a generating function $f(z)$ with its dominant singularity being at $z = \zeta$, if $f(\zeta z)$ is Δ_1 -analytic and is written as $f(\zeta z) = Q(\zeta z)(1 - z)^{-\alpha}$ with $\alpha \notin \{0, -1, \dots\}$, then $[z^n]f(z) \sim \zeta^{-n} Q(\zeta) \frac{n^{\alpha-1}}{\Gamma(\alpha)}$.

Let us now apply the procedure to demonstrate the asymptotic distribution (3.8) in Theorem 3.1. From (3.6), one knows

$$M(r_0; n) = [w^n] w^{r_0} A(1, w)^{r_0+1}. \quad (\text{B.12})$$

We evaluate the asymptotic of the coefficient of w^n as $n \rightarrow \infty$ for some fixed r_0 , and thus we assume $r_0 \ll n$. Putting $r_0 = k - 1$ for notational simplicity, the function is explicitly written as

$$w^{k-1} A(1, w)^k = A_f^k(w) + A_s^k(w) \quad (\text{B.13})$$

where

$$A_f^k(w) = \frac{1}{2^k w} \sum_{b=0}^{\lfloor \frac{k}{2} \rfloor} \binom{k}{2b} \left(\frac{1-3w}{1+w} \right)^b, \quad A_s^k(w) = -\frac{1}{2^k w} \sum_{b=0}^{\lfloor \frac{k-1}{2} \rfloor} \binom{k}{2b+1} \left(\frac{1-3w}{1+w} \right)^{b+\frac{1}{2}}. \quad (\text{B.14})$$

Since $w A_f^k(w)$ is analytic at 0 with the dominant singularity at $w = -1$, by Theorem B.1, the coefficient of w^n in $A_f^k(w)$ is of exponential order $(-1)^{-n+1}$ whereas the one in $A_s^k(w)$ is of exponential order 3^n . Therefore, for $k \ll n$, the contributions of $A_f^k(w)$ in the coefficients of w^n is negligible. Furthermore, regarding Theorem B.3, one may anticipate that the most dominant contribution in $A_s^k(w)$ comes from the term of $b = 0$. Thus, as far as the most dominant asymptotic is only concerned, we can simply apply the procedure given above to the function,

$$f(w) := -\frac{k}{2^k} \sqrt{\frac{1}{1+w}} (1-3w)^{1/2}. \quad (\text{B.15})$$

Observing that $[w^{n+1}]f(w) \sim [w^n]A_s^k(w)$, one arrives at

$$[w^n] w^{k-1} A(1, w)^k \sim 3^{n+1} \left(-\frac{k}{2^k} \sqrt{\frac{3}{4}} \right) \frac{n^{-3/2}}{\Gamma(-\frac{1}{2})} \quad (\text{B.16})$$

and therefore,

$$M(r_0; n) \sim \frac{(r_0 + 1) 3^{n+\frac{3}{2}}}{2^{r_0+3} \sqrt{\pi} n^{3/2}}. \quad (\text{B.17})$$

The asymptotics in (B.11) and (B.17) together with $M_n \sim 3^{n+\frac{3}{2}} / (2\sqrt{\pi} n^{3/2})$, one obtains the formulae in Theorem 3.1.

B.2 Proof of Theorem 3.2

One can basically follow the procedure given above to find the asymptotics in Theorem 3.2, although there is one more thing to consider: multiple dominant singularities. Let us first consider $\pi_\lambda(\nu)$. From the equation (3.10),

$$\pi_\lambda(\nu) = [z^\nu] \frac{z^{\lambda+1}}{1-z} m(z^{1-\lambda}, z^{\lambda+1}) \quad (\text{B.18})$$

where

$$\frac{z^{\lambda+1}}{1-z} m(z^{1-\lambda}, z^{\lambda+1}) = \frac{1 - z^{\lambda+1} - \sqrt{z^{2\lambda+2} - 4z^{\lambda+3} - 2z^{\lambda+1} + 1}}{2z^2(1-z)}. \quad (\text{B.19})$$

We write the polynomial in the square root as

$$z^{2\lambda+2} - 4z^{\lambda+3} - 2z^{\lambda+1} + 1 = Q_\lambda(z) (1 - z/\zeta_\lambda) \quad (\text{B.20})$$

where ζ_λ is the dominant singularity. The fact that ζ_λ is a positive real number is guaranteed by Pringsheim's theorem (Theorem B.2). Following the procedure in the proof of Theorem 3.1, one may simply obtain

$$\pi_\lambda(\nu) \sim \left(\frac{1}{\zeta_\lambda}\right)^{\nu+2} \left(-\frac{\sqrt{Q_\lambda(\zeta_\lambda)}}{2(1-\zeta_\lambda)}\right) \frac{\nu^{-3/2}}{\Gamma(-\frac{1}{2})}. \quad (\text{B.21})$$

Note that, however, this formula holds for even numbers of λ .

When λ is an odd number, we have two dominant singularities, which are $+\zeta_\lambda$ and $-\zeta_\lambda$. The generating function is then analytic in the domain depicted in Figure 8 after the rescaling. In this case, the two contributions from each of the singularities are added up to give the asymptotic (for rigorous and complete arguments, refer to Theorem VI.5 on page 398 of [26]). The presence of the two dominant singularities reflects the fact that the coefficient of z^ν with the odd $\nu = 2k + 1$ equals to the one with the even $\nu = 2k$: An odd number of λ means assigning an even number of vertices in each hairpin and hence, there is no compatible π -shape with ν odd. This feature can be shown from the explicit calculation. Let us write the polynomial for λ odd as

$$z^{2\lambda+2} - 4z^{\lambda+3} - 2z^{\lambda+1} + 1 = R_\lambda(z) (1 - z/\zeta_\lambda) (1 + z/\zeta_\lambda). \quad (\text{B.22})$$

Then the two contributions are added up and give

$$\pi_\lambda(\nu) \sim \left(\frac{1}{\zeta_\lambda}\right)^{\nu+2} \left(-\frac{\sqrt{2R_\lambda(\zeta_\lambda)}}{2(1-\zeta_\lambda)}\right) \frac{\nu^{-3/2}}{\Gamma(-\frac{1}{2})} + \left(\frac{1}{-\zeta_\lambda}\right)^{\nu+2} \left(-\frac{\sqrt{2R_\lambda(\zeta_\lambda)}}{2(1+\zeta_\lambda)}\right) \frac{\nu^{-3/2}}{\Gamma(-\frac{1}{2})}. \quad (\text{B.23})$$

For both the even $\nu = 2k$ and the odd $\nu = 2k + 1$, one finds

$$\pi_\lambda(2k) = \pi_\lambda(2k + 1) \sim \left(\frac{1}{\zeta_\lambda}\right)^{2k+2} \left(-\frac{\sqrt{2R_\lambda(\zeta_\lambda)}}{(1-\zeta_\lambda)^2}\right) \frac{(2k)^{-3/2}}{\Gamma(-\frac{1}{2})}. \quad (\text{B.24})$$

Let us now consider the asymptotic of $\sum_{r_0} r_0 \pi_\lambda(r_0; \nu)$. Its generating function is given as

$$\sum_{r_0} r_0 \pi_\lambda(r_0; \nu) = [z^\nu] \frac{z^{\lambda+1}}{1-z} \frac{\partial}{\partial t} m(t; z^{1-\lambda}, z^{\lambda+1}) \Big|_{t=1} = [z^\nu] \frac{z^{2\lambda+2}}{1-z} \left(m(z^{1-\lambda}, z^{\lambda+1})\right)^2. \quad (\text{B.25})$$

The significant part of the generating function is

$$-\frac{(1 - z^{\lambda+1})\sqrt{z^{2\lambda+2} - 4z^{\lambda+3} - 2z^{\lambda+1} + 1}}{2z^4(1-z)}. \quad (\text{B.26})$$

It is now straightforward to find its asymptotic. For an even number of λ ,

$$\sum_{r_0} r_0 \pi_\lambda(r_0; \nu) \sim \left(\frac{1}{\zeta_\lambda}\right)^{\nu+4} \left(-\frac{(1 - \zeta_\lambda^{\lambda+1})\sqrt{Q_\lambda(\zeta_\lambda)}}{2(1 - \zeta_\lambda)}\right) \frac{\nu^{-3/2}}{\Gamma(-\frac{1}{2})} \quad (\text{B.27})$$

and for an odd number of λ ,

$$\sum_{r_0} r_0 \pi_\lambda(r_0; \nu) \sim \left(\frac{1}{\zeta_\lambda}\right)^{\nu+4} \left(\frac{1}{1-\zeta_\lambda} + \frac{(-1)^\nu}{1+\zeta_\lambda}\right) \left(-\frac{(1-\zeta_\lambda^{\lambda+1})\sqrt{2R_\lambda(\zeta_\lambda)}}{2}\right) \frac{\nu^{-3/2}}{\Gamma(-\frac{1}{2})}. \quad (\text{B.28})$$

In the same manner, one may easily find the asymptotic of $\pi_\lambda(r_0; \nu)$. From (3.10) and (3.6), we know

$$\pi_\lambda(r_0; \nu) = [z^\nu] \frac{1}{1-z} \left(z^{\lambda+1} A(z^{1-\lambda}, z^{\lambda+1})\right)^{r_0+1}. \quad (\text{B.29})$$

The most dominant contribution comes from the term,

$$-\frac{(r_0+1)(1+z^{\lambda+1})^{r_0} \sqrt{z^{2\lambda+2} - 4z^{\lambda+3} - 2z^{\lambda+1} + 1}}{2^{r_0+1}(1-z)(1+z^2)^{r_0+1}}. \quad (\text{B.30})$$

Therefore, for an even number of λ ,

$$\pi_\lambda(r_0; \nu) \sim \left(\frac{1}{\zeta_\lambda}\right)^\nu \left(-\frac{(r_0+1)(1+\zeta_\lambda^{\lambda+1})^{r_0} \sqrt{Q_\lambda(\zeta_\lambda)}}{2^{r_0+1}(1-\zeta_\lambda)(1+\zeta_\lambda^2)^{r_0+1}}\right) \frac{\nu^{-3/2}}{\Gamma(-\frac{1}{2})} \quad (\text{B.31})$$

and for an odd number of λ ,

$$\pi_\lambda(r_0; \nu) \sim \left(\frac{1}{\zeta_\lambda}\right)^\nu \left(\frac{1}{1-\zeta_\lambda} + \frac{(-1)^\nu}{1+\zeta_\lambda}\right) \left(-\frac{(r_0+1)(1+\zeta_\lambda^{\lambda+1})^{r_0} \sqrt{2R_\lambda(\zeta_\lambda)}}{2^{r_0+1}(1+\zeta_\lambda^2)^{r_0+1}}\right) \frac{\nu^{-3/2}}{\Gamma(-\frac{1}{2})}. \quad (\text{B.32})$$

The asymptotics given in (B.21), (B.23), (B.27), (B.28), (B.31) and (B.32) prove Theorem 3.2.

References

- [1] R. Nussinov and A. B. Jacobson, "Fast algorithm for predicting the secondary structure of single-stranded RNA.," *Proceedings of the National Academy of Sciences of the United States of America*, vol. 77, no. 11, pp. 6309–13, 1980.
- [2] M. Zuker and P. Stiegler, "Optimal computer folding of large RNA sequences using thermodynamics and auxiliary information," *Nucleic Acids Research*, vol. 9, no. 1, pp. 133–148, 1981.
- [3] M. Zuker and D. Sankoff, "Rna secondary structures and their prediction," *Bulletin of Mathematical Biology*, vol. 46, no. 4, pp. 591 – 621, 1984.
- [4] P. Schuster, P. F. Stadler, and A. Renner, "Rna structures and folding: from conventional to new issues in structure predictions," *Current Opinion in Structural Biology*, vol. 7, no. 2, pp. 229 – 235, 1997.
- [5] P. Stein and M. Waterman, "On some new sequences generalizing the catalan and motzkin numbers," *Discrete Mathematics*, vol. 26, no. 3, pp. 261 – 272, 1979.
- [6] I. L. Hofacker, P. Schuster, and P. F. Stadler, "Combinatorics of RNA secondary structures," *Discrete Applied Mathematics*, vol. 88, no. 1-3, pp. 207–237, 1998.

- [7] W. R. Schmitt and M. S. Waterman, “Linear trees and rna secondary structure,” *Discrete Applied Mathematics*, vol. 51, no. 3, pp. 317 – 323, 1994.
- [8] C. L. Barrett, T. J. Li, and C. M. Reidys, “RNA Secondary Structures Having a Compatible Sequence of Certain Nucleotide Ratios,” *Journal of Computational Biology*, vol. 23, pp. 857–873, 2016.
- [9] S. K. Choi, C. Rim, and H. Um, “RNA substructure as a random matrix ensemble,” 2016.
- [10] M. S. Waterman, “Secondary structure of single-stranded nucleic acids,” *Adv. math. suppl. studies*, vol. 1, pp. 167–212, 1978.
- [11] R. Giegerich, B. Voss, and M. Rehmsmeier, “Abstract shapes of rna,” *Nucleic Acids Research*, vol. 32, no. 16, pp. 4843–4851, 2004.
- [12] H. Orland and A. Zee, “RNA folding and large n matrix theory,” *Nucl. Phys.*, vol. B620, pp. 456–476, 2002.
- [13] C. M. Reidys, F. W. D. Huang, J. E. Andersen, R. C. Penner, P. F. Stadler, and M. E. Nebel, “Topology and prediction of RNA pseudoknots,” *Bioinformatics*, vol. 27, pp. 1076–1085, apr 2011.
- [14] S. Janssen, J. Reeder, and R. Giegerich, “Shape based indexing for faster search of rna family databases,” *BMC Bioinformatics*, vol. 9, p. 131, Feb 2008.
- [15] M. E. Nebel and A. Scheid, “On quantitative effects of RNA shape abstraction,” *Theory in Biosciences*, vol. 128, no. 4, pp. 211–225, 2009.
- [16] C. Coker, “Enumerating a class of lattice paths,” *Discrete Mathematics*, vol. 271, no. 1, pp. 13 – 28, 2003.
- [17] W. Y. Chen, S. H. Yan, and L. L. Yang, “Identities from weighted motzkin paths,” *Advances in Applied Mathematics*, vol. 41, no. 3, pp. 329 – 334, 2008.
- [18] R. Donaghey and L. W. Shapiro, “Motzkin numbers,” *Journal of Combinatorial Theory, Series A*, vol. 23, no. 3, pp. 291 – 301, 1977.
- [19] W. A. Lorenz, Y. Ponty, and P. Clote, “Asymptotics of rna shapes,” *Journal of Computational Biology*, vol. 15, no. 1, pp. 31–63, 2008.
- [20] S. K. Choi, C. Rim, and H. Um, “Narayana number, chebyshev polynomial and motzkin path on rna abstract shapes,” in *2017 MATRIX Annals* (D. R. Wood, J. de Gier, C. E. Praeger, and T. Tao, eds.), pp. 153–156, Springer, 2019.
- [21] P. Barry and A. Hennessy, “A note on narayana triangles and related polynomials, Riordan arrays, and MIMO capacity calculations,” *Journal of Integer Sequences*, vol. 14, no. 3, pp. 1–26, 2011.
- [22] J. Touchard, “Sur certaines équations fonctionnelles,” *Proceedings of the International Congress on Mathematics, Toronto (1924)*, vol. 1, pp. 465 – 472, 1928.
- [23] M.-P. Delest and G. Viennot, “Algebraic languages and polyominoes enumeration,” *Theoretical Computer Science*, vol. 34, no. 1, pp. 169 – 206, 1984.

- [24] M. E. Catalan, “Sur les nombres de segner,” *Rendiconti del Circolo Matematico di Palermo (1884-1940)*, vol. 1, pp. 190–201, Dec 1887.
- [25] P. Larcombe, “A forgotten convolution type identity of catalan,” *Utilitas Mathematica*, vol. 57, 05 2000.
- [26] P. Flajolet and R. Sedgewick, *Analytic Combinatorics*. New York, NY, USA: Cambridge University Press, 1 ed., 2009.
- [27] P. Flajolet and A. Odlyzko, “Singularity analysis of generating functions,” *SIAM Journal on Discrete Mathematics*, vol. 3, no. 2, pp. 216–240, 1990.