

Graphical Requirements for Multistationarity in Reaction Networks and their Verification in BioModels

Adrien Baudier, François Fages, Sylvain Soliman

Inria Saclay Île-de-France, Palaiseau, France

Abstract

Thomas's necessary conditions for the existence of multiple steady states in gene networks have been proved by Soulé with high generality for dynamical systems defined by differential equations. When applied to (protein) reaction networks however, those conditions do not provide information since they are trivially satisfied as soon as there is a bimolecular or a reversible reaction. Refined graphical requirements have been proposed to deal with such cases. In this paper, we present for the first time a graph rewriting algorithm for checking the refined conditions given by Soliman, and evaluate its practical performance by applying it systematically to the curated branch of the BioModels repository. This algorithm analyzes all reaction networks (of size up to 430 species) in less than 0.05 second per network, and permits to conclude to the absence of multistationarity in 160 networks over 506. The short computation times obtained in this graphical approach are in sharp contrast to the Jacobian-based symbolic computation approach. We also discuss the case of one extra graphical condition by arc rewiring that allows us to conclude on 20 more networks of this benchmark but with a high computational cost. Finally, we study with some details the case of phosphorylation cycles and MAPK signalling models which show the importance of modelling the intermediate complexations with the enzymes in order to correctly analyze the multistationarity capabilities of such biochemical reaction networks.

Keywords:

Multistability, Reaction networks, Influence networks, Positive circuits,

Email addresses: francois.fages@inria.fr (François Fages),
sylvain.soliman@inria.fr (Sylvain Soliman)

Article submitted to a special issue *in memoriam* of René Thomas.

1. Introduction

The wide variety of cells in a multicellular organism show that cells with identical copies of DNA may differentiate in different cell types. In the late 40's, Max Delbruck at Caltech suggested that each type of cell could correspond to a distinct steady state in the dynamics of their shared gene expression network. In order to analyze such large networks, René Thomas conjectured in 1980 that the existence of a positive (resp. negative) feedback loop was a necessary condition for multistationarity (resp. sustained oscillations) [32]. Those conjectures were later proved in various formalisms (Boolean or discrete transition systems, differential equations) with various degrees of generality. In 2003, Christophe Soulé finally proved Thomas's necessary condition for multistationarity with full generality for dynamical systems defined by differential equations [30].

In his mathematical formalization of the conjecture, Soulé considers a differentiable mapping F from a finite dimensional real vector space to itself, and for each point a , the directed graph $G(a)$ where the arcs are the non-zero entries of the Jacobian matrix of F , labeled by their sign. He shows that if F has at least two non-degenerate zeroes, there exists a such that $G(a)$ has a positive circuit.

When applied to (protein) reaction networks however, Thomas's necessary condition for multistationarity fails short since it is trivially satisfied as soon as there exists either a bimolecular or a reversible reaction. Indeed, a bimolecular reaction such as a complexation reaction immediately creates a mutual inhibition between the two reactants, i.e. a positive circuit, and a reversible reaction produces a mutual activation, i.e. again a positive circuit, making Thomas's necessary condition always true in those networks.

Nevertheless, reaction models are widespread in computational systems biology and it would be very desirable to be able to predict the absence of multistationarity by systematically checking such conditions with efficient algorithms. For instance, the BioModels database² [4] is a repository of more than 600 hand-curated models written in the Systems Biology Markup Language (SBML) [16] mostly with reaction rules, over several tenths or

²<http://biomodels.net/>

hundred of molecular species. There are hundreds more models in the non-curated branch, and thousands of models imported from metabolic networks databases with even larger numbers of reactions and species.

Soulé’s proof, as most preceding and following proofs, uses the fact that the existence of multiple steady states implies a non-injectivity property which is shown to be equivalent to a determinant being zero for some values of reaction rate constants. One approach, called the Jacobian approach, is thus to use symbolic computation methods to directly compute the roots of that determinant. If it is non-zero, one can conclude to the absence of multistationarity. This is the approach taken by Feliu and Wiuf in [13]. Interestingly, they evaluated their algorithm, implemented in Maple 16, on the curated branch of BioModels (323 networks in their case), showing that 31,6% were injective and that only 8,3% of the networks of this benchmark caused memory overflow by that method. On the sequences of r phosphorylation cycles of [34], they could check non-injectivity up to $r = 17$ cycles in 1200 seconds.

In this paper, we follow the alternative graphical approach to multistationarity analyses. We describe a graph rewriting algorithm which deals with sequences of $r = 1000$ phosphorylation cycles in a second, and analyzes the curated branch of BioModels (506 networks in our case) with a maximum computation time of 50 milliseconds per network (including large networks of size up to 430 species), while concluding to the non existence of multiple steady states in 160 networks of size up to 54 species in that benchmark, i.e. with a similar ratio of 31.6% of results concluding to non-multistationarity.

This algorithm is based on a refinement of the graphical requirements of Soulé [30] given by the third author in [29] as a necessary condition for the existence of multiple steady states in (biochemical) reaction networks. Similar graphical requirements have also been given in [2] without restriction to mass-action law kinetics, but to our knowledge, it is the first time that they are implemented and evaluated systematically in model repositories. For instance, we are not aware of similar evaluations obtained with the Chemical Reaction Network Toolbox³ for systematically checking the graphical conditions for multistationarity of Feinberg’s Chemical Reaction Network Theory (CRNT) [12, 5].

³<https://crnt.osu.edu/toolbox-history-and-explanation>

More specifically, we present a series of graph rewriting algorithms for checking the different graphical requirements of [29], and analyze their practical performance in the curated models of BioModels, in order to:

- evaluate when the original condition of Thomas allows us to rule out multistationarity;
- evaluate when the following three extra conditions given in [29] become conclusive, namely:
 1. the positive circuit must not come from twice the same reaction;
 2. the positive circuit must not come from a reaction and its reverse reaction;
 3. the positive circuit must not involve all species of a conservation law;
- evaluate when even stronger conditions based on the rewirings detailed in [30, 29] are necessary to conclude, namely
 1. by sign change of incoming arcs on a set of species,
 2. or by permuting the arcs to a set of target species.

For this study, we used our software modelling environment BIOCHAM⁴ [9, 3] to load all models from the curated branch of BioModels, improve their writing in SBML with well-formed reactions using the algorithm described in [6], compute the conservation laws [28], compute their influence multigraph labelled by the reactions [8, 11] and export the labelled multigraph in the Lemon library format⁵. Then we used an implementation in C++ of the algorithm presented in this paper to search for positive circuits with the different refined conditions on the labelled influence multigraph, and evaluate their respective contributions for the analysis of multistationarity in BioModels. All the computation times obtained with this algorithm given in this paper were obtained on a standalone desktop Linux machine with an Intel Xeon 3.6 GHz processor⁶.

⁴<http://lifeware.inria.fr/biocham4>

⁵<http://lemon.cs.elte.hu/>

⁶For the sake of reproducibility, our programs and data are available at <https://lifeware.inria.fr/wiki/Main/Software#JTB18>

The rest of this article is organized as follows. The next section presents the refined necessary conditions for multistationarity in reaction networks described in [29] and detailed here with five levels of conditions. The following section presents a graph rewriting algorithm for checking those conditions, and evaluates its computational complexity. Section 4 shows the remarkable performance of this algorithm by applying it systematically to the curated part of the model repository BioModels, including models out of reach of Jacobian-based symbolic computation methods, and details the effect of the five levels of refined conditions in this benchmark. Section 5.1 considers the models of double phosphorylation cycles of Wang and Sontag [34] and shows a very low quadratic empirical complexity of the graphical algorithm, again in sharp contrast to symbolic computation methods. Section 5.2 focusses on model 270 of ERK signalling that contains 33 species and 42 reactions resulting in an influence multigraph of 126 arcs with many positive and negative feedback loops, yet for which our graphical algorithm demonstrates the absence of multistationarity. These examples illustrate the importance of modelling the intermediate complexes in enzymatic reactions to obtain multiple steady states, and show the sensitivity of both the dynamical properties of the models and of our graphical conditions to the writing of enzymatic reactions with or without intermediate complexes. We conclude on the remarkable performance of the graphical approach to analyze multistationarity in reaction models of large size, and on some perspectives to further improve our algorithm and generalize this approach.

2. Necessary Condition for Multistationarity in Reaction Networks

Let us consider a biochemical reaction system with n species S_1, \dots, S_n and m reactions R_1, \dots, R_m . Using notations from [19] we write:

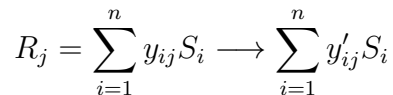

The y and y' represent the stoichiometric coefficients of the reactants and products of the reaction. The rate law associated with reaction R_j will be written v_j . This defines a dynamical system, in the form of an Ordinary Differential Equation (ODE): $\dot{x} = F(x)$ where x_i is the concentration of species S_i and

$$f_i(x) = \sum_j v_j(x) \cdot (y'_{ij} - y_{ij})$$

This kind of reaction-based system encompasses most of the systems biology models developed nowadays and made available in model repositories like BioModels. In particular, SBML reaction models can be translated with our notations, basically by splitting reversible reactions into forward and backward reactions, and by including modifiers on both sides of the reaction.

Reaction systems are often graphically represented as a Petri-net, i.e., a bipartite graph for species and reactions [17, 18]. Using the same bipartite vertices but different arcs and labels, it is possible to represent the Directed Species-Reaction (DSR) graph of Kaltenchbach [19]. This graph is a variant of the DSR graph of [1, 2] with different labels and no sign. Here the arcs of the DSR graph are defined and identified by their label λ as follows:

$$\lambda(S_i, R_j) = \frac{\partial v_j}{\partial x_i} \quad \lambda(R_j, S_i) = y'_{ij} - y_{ij}$$

If λ is zero, then there is no arc. λ is extended to paths (resp. subgraphs) as the product of the labels of all arcs in the path (resp. subgraph). For a path P , we shall write $\lambda_{SR}(P)$ (resp. $\lambda_{RS}(P)$) for the product of labels considering only species to reaction (resp. reaction to species) arcs.

Intuitively, λ_{SR} represents the contribution of species to each reaction rate, whereas λ_{RS} describes the stoichiometric effect of reactions on each species. Fig. 1 shows the DSR graph for the chemical reaction network corresponding to the enzymatic reaction $S + E \rightleftharpoons ES \rightarrow E + P$.

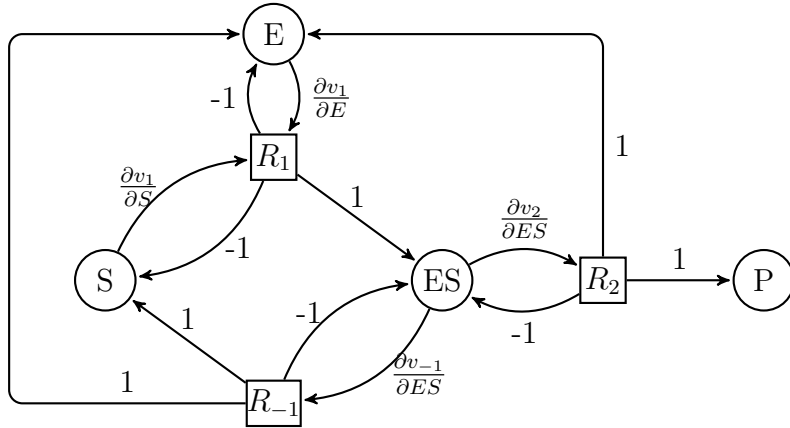

Figure 1: DSR graph of the enzymatic reaction: $S + E \rightleftharpoons ES \rightarrow E + P$.

Definition 1. [19] *A species hamiltonian hooping of the DSR graph is a collection of cycles covering each of the species nodes exactly once.*

The set of all species hamiltonian hoopings will be denoted by \mathcal{H} . Thanks to the fact that $\lambda(H) = \lambda_{SR}(H)\lambda_{RS}(H)$, Kaltenbach [19] proposed to group all species hamiltonian hoopings having the same species-to-reaction arcs using an equivalence relation noted \sim , writing $[H] = \{H' \in \mathcal{H} \mid H' \sim H\}$ for the equivalence class of a hooping H , and \mathcal{H}/\sim for the quotient set.

Theorem 2.1 ([19]).

$$\det(J) = \sum_{[H] \in \mathcal{H}/\sim} \Lambda([H])\lambda_{SR}(H) \quad \text{with} \quad \Lambda([H]) = \sum_{H' \in [H]} \sigma(H')\lambda_{RS}(H')$$

Considering Soulé’s proof of Thomas’s conjecture for dynamical systems [30] and applying Thm. 2.1 to each sub-DSR-graph corresponding to a principal minor of $-J$, [29] notes that a necessary condition for multistationarity is that some term of the sum is negative. This again states the usual condition about the existence of a positive cycle in the influence graph of J .

Now, the usual labelling of the arcs of the influence graph between molecular species by the sign of the Jacobian matrix coefficient can be augmented to contain not only the sign but also the reaction used for each arc. There is thus an arc in this reaction-labelled influence multigraph for each species-to-species path of length two in the DSR graph. This leads to a one-to-one correspondence between hamiltonian hoopings of the reaction-labelled influence multigraph and species hamiltonian hoopings of the DSR graph. Fig. 2 illustrates this on the example of Fig. 1.

Let us denote by $|_H$ the restriction of the reaction system to a species hooping H , i.e. the system where reactions $\{R_i \mid i \in I\}$ not appearing in H are omitted.

Theorem 2.2 ([29]). *Let F be any differentiable map from Ω to \mathbb{R}^n corresponding to a biochemical reaction system. If Ω is open and F has two nondegenerate zeroes in Ω then there exists some a in Ω such that:*

1. *The reaction-labelled influence graph G of F at point a contains a positive circuit C ;*
2. *There exists a hooping H in G , such that C is subcycle of H with $(Y' - Y)|_H$ of full rank.*

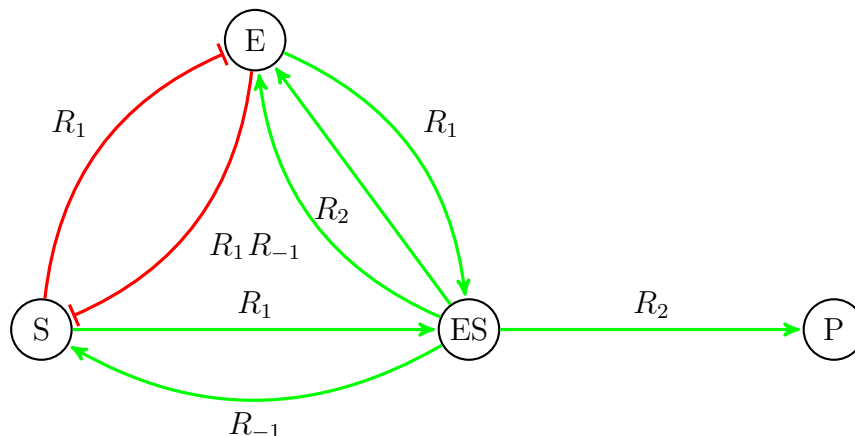

Figure 2: Influence multigraph associated to the Michaelis-Menten reaction system of the three reactions $S + E \rightleftharpoons ES \rightarrow E + P$. The influence arcs are labelled both by their sign, as usual and by the unique reaction from which they originate. Note for instance that there are two positive arcs from ES to E. Negative self-loops are omitted for clarity

This theorem gives several graphical requirements for multistationarity.

Corollary 2.3. *A necessary condition for the multistationarity of a biochemical reaction system is that there exists a positive cycle in its influence multigraph, using at most once each reaction.*

This condition actually only requires the reaction-labelled influence multigraph. It is immediate to check that the mutual inhibition resulting from bimolecular reactions—like that between E and S in our running example—cannot fulfill these necessary conditions, since the same reaction— R_1 in Fig. 2—will be repeated twice.

Corollary 2.4. *A necessary condition for the multistationarity of a biochemical reaction system is that there exists a positive cycle in its influence multigraph, not using both forward and backward directions of any reversible reaction.*

The mutual activation resulting from reversible reactions—like that between ES and S through R_1 and R_{-1} in our running example—cannot thus fulfill these necessary conditions. That condition is also a corollary of the conditions given in [2] since, in their setting, reversible reactions give rise to a unique undirected edge.

Another information that can be extracted from the stoichiometry is the (structural) conservation laws, i.e., P-invariants of the underlying Petri net, or more simply the left kernel of the stoichiometry matrix. Finding all the conservation laws of a biochemical model might be computationally expensive, though in practice that does not seem to be the case [28].

Corollary 2.5. *A necessary condition for the multistationarity of a biochemical reaction system is that there exists a positive cycle in its influence multigraph, not using all species involved in a conservation law.*

In our running example, the species E and ES, mutually activated through R_1 and R_2 , form a conservation law, which violates the necessary conditions for multistationarity. The three Corollaries 2.3, 2.4 and 2.5 thus rule out all the cases for which Thomas’s condition was satisfied in this example.

Furthermore, in [30] and later in [29], the two following corollaries relying on some particular graph rewirings were also mentioned without much clue to check them:

Corollary 2.6. *A necessary condition for the multistationarity of a biochemical reaction system is that there exist positive cycles fulfilling condition 2 of Theorem 2.2 in the influence multigraph corresponding to its Jacobian, **and** in any graph obtained from it choosing a set of species and by reversing the sign of all arcs that have as target some species belonging to that set.*

Corollary 2.7. *A necessary condition for the multistationarity of a biochemical reaction system is that there exist positive cycles fulfilling condition 2 of Theorem 2.2 in the influence multigraph corresponding to its Jacobian, **and** in any graph obtained from it by choosing a permutation of the species and by rewiring the arcs’ target according to the permutation.*

3. Graph-Theoretic Algorithm for Proving Non-Multistationarity

3.1. Computing the Labelled Influence Multigraph of a Reaction Model written in SBML

The signs of the arcs in the reaction-labelled influence multigraph of a reaction system, are given by the sign of $\partial v_i / \partial x_j$ instead of that of $\partial f_i / \partial x_j$. Even without precise kinetic values, this can be easily computed under the general condition of well-formedness of the reactions [8, 10]. This condition is

satisfied by the commonly used kinetics such as mass action law, Michaelis-Menten and Hill kinetics, and provides a sanity check for the writing in SBML of ODE models [6].

In the following, and to ensure in a simple and systematic way that the structure of the reactions, and of the computed influence multigraph, do correspond to the continuous dynamics of the model, all SBML models considered here are first automatically *sanitized* as explained in [6], by exporting the system of ordinary differential equations, and reimporting it as a well-formed reaction system. Algorithm 1 summarizes the main steps of this procedure.

Algorithm 1 Algorithm for computing the labelled influence multigraph of a reaction model written in SBML [6].

```

function EXTRACT_LABELLED_INFLUENCE_GRAPH(sbmlModel)
  Model  $\leftarrow$  LOAD_SBML_MODEL(sbmlModel)
  System  $\leftarrow$  COMPUTE_ODES(Model)
  Model  $\leftarrow$  INFER_REACTION_MODEL_FROM_ODES(System)
  ▷ as explained in [6]
  Graph  $\leftarrow$  INFER_INFLUENCE_GRAPH(Model)
  ▷ as explained in [11] but adding reactions as labels on the edges
  return Graph
end function

```

This algorithm needs to determine the sign of a partial derivative. In our implementation this is done by a simple symbolic derivation algorithm and a heuristic to determine the sign of the expressions. In case of indeterminacy, both signs are assumed. In general, the result that is computed is thus an over-approximation of the real influence multigraph.

3.2. Absence of Positive Circuit with the Conditions of Cor. 2.3 2.4 2.5

Tarjan's depth-first tree traversal of a graph provides a classical algorithm for testing the existence of a circuit, by just checking the existence of a back edge during this traversal [31]. Generalizing this algorithm to check the absence of circuits satisfying the previous conditions on the signs and on the reactions at the origin of the arcs is however non obvious. This may explain why the previous refined graphical requirements had not been implemented before.

In this section, we present an algorithm which proceeds by graph rewriting. This algorithm will generalize the following graph simplification rules which show that a graph is acyclic if and only if it reduces to the empty graph by using them [21, 24, 7]:

- **IN0**(v): Remove vertex v and all associated edges if v has no incoming edge.
- **OUT0**(v): Remove vertex v and all associated edges if v has no outgoing edge.
- **IN1**(v): Remove vertex v if v has exactly one incoming edge and connect this edge to all the outgoing edges of v .
- **OUT1**(v): Remove vertex v if v has exactly one outgoing edge and connect all incoming edges to it.

In order to check the conditions of Cor. 2.3 2.4 2.5, we consider here labelled multigraphs, where each arc is labelled by a couple: its sign and the reaction from which it originates. Instead of stopping when the previous rules do not apply, and conclude to the cyclicity of the graph if it is not empty, we extend this set of rules to any number of incoming or outgoing edges and add a restriction on the created edges that must satisfy the conditions of the corollaries. This is described by the following single graph rewriting rule which subsumes the four previous ones:

- **INOUT i** (v): Remove vertex v if v has exactly i incoming or outgoing edges, and create the incoming-outcoming edges labeled by the product of the signs and the union of the reactions if, and only if, those labels satisfy the conditions of the corollaries.

This generic rewriting rule removes one vertex and all the attached edges and creates a new edge for every pair of *incoming-outgoing* edge of the vertex satisfying the conditions. When creating such arcs, the reactions and species involved in the process are memorized in order to check the conditions given by the previous corollaries and to eliminate the edges, now representing paths, that do not respect them. In this way, this rewriting rule preserves all circuits satisfying the conditions of the corollaries.

This rule is applied successively to the nodes of the graph by choosing a vertex of minimum degree i at each step. This is done with a simple

data structure that maintains the degree of each vertex. This algorithm terminates when the first positive self-loop is found, denoting that a positive circuit satisfying the conditions of the three Corollaries 2.3, 2.4 and 2.5 has been found in the original graph, or when the graph is empty, proving that no such circuit exists. The main steps of the decision procedure are summarized in Alg. 2 and 3.

Algorithm 2 Acyclicity check.

```

function CHECKACYCLICITY( $G$ )
  while COUNTVERTICES( $G$ ) > 0 do
     $v \leftarrow$  vertex with the least number of incoming or outgoing arcs
    REMOVEVERTEX( $v$ )
5:   for  $L \in \text{SelfLoops}$  do
     if  $L$  is positive then
       return False
     else
       Delete  $L$ 
10:   end if
     end for
   end while
  return True
end function

```

Proposition 3.1. *The time complexity of Alg. 2 is $\mathcal{O}(k^{2^n})$ where n the number of nodes and k is the maximum degree of the graph.*

Proof. Let us write k_i the maximum indegree or outdegree of the graph after the i^{th} loop of Alg. 2 ($k_0 = k$). The call to remove a vertex (Alg 3) is done in at most k_i^2 steps and creates at most the same number of edges, we then have the relation: $k_{i+1} = k_i^2$ which gives: $k_i = k^{2^i}$.

Alg. 2 goes through at most n loops, therefore, the number of steps to complete the algorithm is at most given by:

$$C(k, n) = \sum_{i=1}^n k^{2^i} \leq \sum_{j=1}^{2^n-1} k^{2^j} = \mathcal{O}(k^{2^n})$$

□

Algorithm 3 Graph reduction preserving acyclicity.

```
procedure REMOVEVERTEX( $v$ )  
  for  $w \rightarrow_l v \in IncomingEdges(v)$  do  
    for  $v \rightarrow_m x \in OutgoingEdges(v)$  do  
      Create a new label  $n \leftarrow l \cdot v \cdot m$   
      if  $n$  does not contain twice the same reaction, a reaction and its  
      inverse or all species of a conservation then  
        Create  $w \rightarrow_n x$   
      else  
        Discard  $n$   
      end if  
      Delete  $v \rightarrow_m x$   
    end for  
  Delete  $w \rightarrow_l v$   
end for  
Delete  $v$   
end procedure
```

We do not know whether this doubly exponential complexity can be reached in some networks. It is worth noting that this bound does not take into account the fact that the number of edges strictly decreases when the rule INOUT i is applied to vertices of degree $i \leq 1$, nor that the edges that do not satisfy the conditions of the corollaries are not created. Furthermore the degree of the nodes in the initial graph is also a limiting factor as it is generally low in the context of biochemical networks [23]. These considerations explain the much better practical complexity reported in Sections 4, and 5.1, where we will show for instance that the time taken to analyze one model of BioModels is empirically $\mathcal{O}(e \log(n))$ where e is the number of edges.

3.3. Sign Changes

We show here that the condition given by Corollary 2.6 can be done by solving a linear system in Galois field $GF(2)$, i.e. $\mathbb{Z}/2\mathbb{Z}$, in which each species is a variable (valued to 1 if the sign of the incoming arcs needs to be reversed). Each simple loop satisfying Corollaries 2.3, 2.4 and 2.5 in the graph is then modelled by an equation on the sum of all the species involved in the loop, equal to 0 if the loop is negative and 1 otherwise.

As an example, let us consider the influence graph shown in Fig. 3. This

graph contains two positive circuits which satisfy the three Corollaries 2.3, 2.4 and 2.5 ($K \xrightarrow{R_1} MK \xrightarrow{R_2} K$ and $K \xrightarrow{R_3} MpK \xrightarrow{R_4} K$) and only one negative circuit satisfying the same Corollaries ($K \xrightarrow{R_1} MK \xrightarrow{R_2} Mp \xrightarrow{R_3} K$). The system associated to these three loops is therefore:

$$\begin{cases} x_K + x_{MK} & = 1 \\ x_K & + x_{MpK} = 1 \\ x_K + x_{MK} & + x_{Mp} = 0 \end{cases}$$

If this system has a solution, then the reaction graph for which we reverse the sign of every arc that has as target any species which variable evaluates to 1 in the solution, does not contain any positive loop satisfying the three Corollaries 2.3, 2.4 and 2.5.

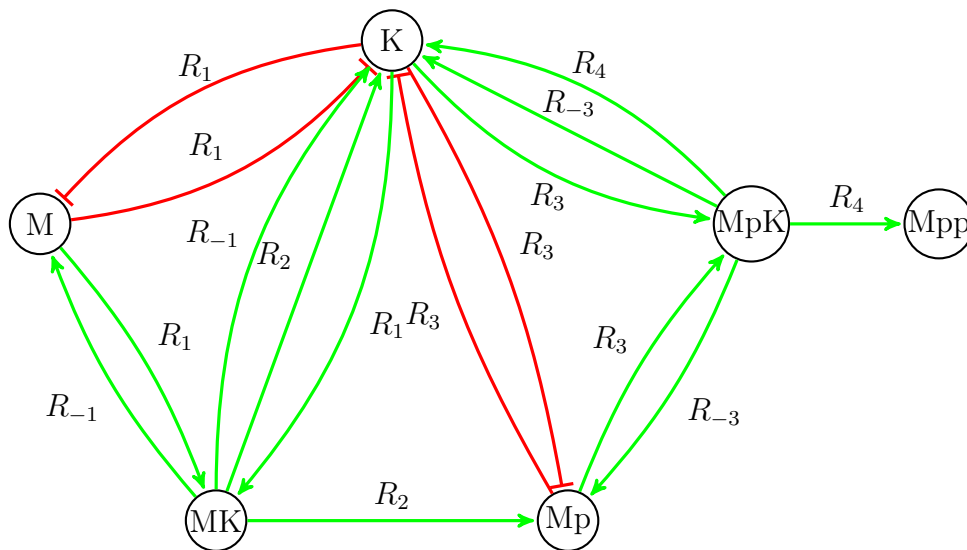

Figure 3: influence multigraph of $M + K \rightleftharpoons MK \rightarrow K + Mp \rightleftharpoons MpK \rightarrow K + Mpp$. Negative self-loops are omitted for clarity

Solving such system can be done by using a simple Gaussian elimination. This process is applied every time a new loop is found by adding the corresponding equation in the system and checking the new equation does not yield a contradiction (which can only be the equation $0 = 1$). This process allows us not to compute every possible loop in the graph if a contradiction emerges.

The previous system obtained from Fig. 3 has two solutions, one of which is $x_K = x_{Mp} = 1$ and the over variables are put to zero. Therefore, the influence graph for which the sign of the incoming arcs for nodes K and Mp are reversed (Fig. 4) does not contain any positive circuit satisfying Corollaries 2.3, 2.4 and 2.5. The biochemical system cannot display any multistationarity.

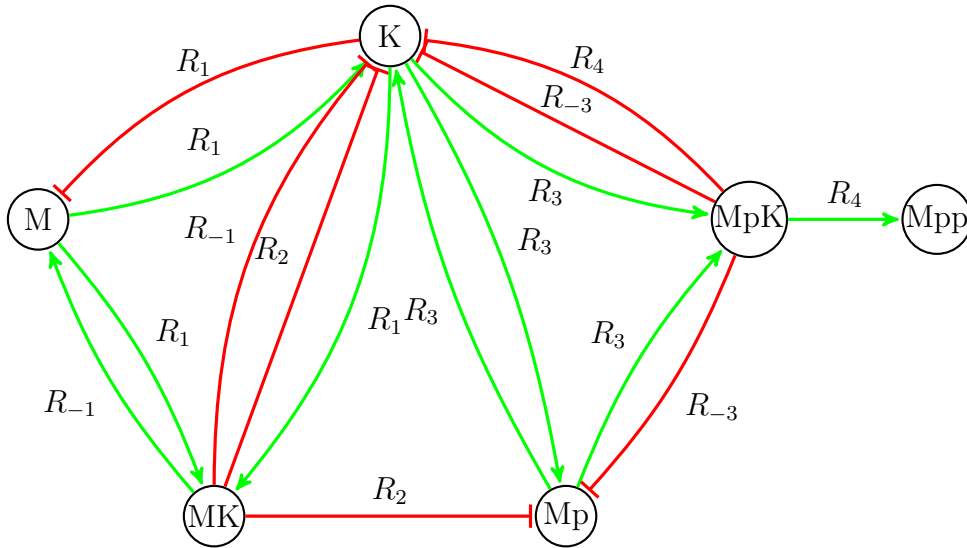

Figure 4: influence multigraph of $M + K \rightleftharpoons MK \rightarrow K + Mp \rightleftharpoons MpK \rightarrow K + Mpp$ for which arcs ending in K and Mp have changed sign. Self-loops are omitted for clarity

Gaussian elimination can be done directly on the species involved in the loop by noticing that adding two equations of the system in $GF(2)$ corresponds to taking the symmetric difference between the list of species of the two loops involved and changing the sign accordingly. This last process is described in Alg. 4. This function is to be incorporated in Alg. 2 by replacing the body of the **for** loop starting on line 5, stopping on False and continuing on True.

3.4. Permutations

Checking the condition given by Corollary 2.7 requires more computation as we do not know beforehand the effects of applying a permutation on the circuits of the graph.

Algorithm 4 Gaussian Elimination

```
function ADDTOLOOPSYSTEM( $l$ )  
  for  $m \in LoopSystem$  do  
    Let  $P \leftarrow Pivot(m)$   
    if  $P \in l$  then  
       $species(l) \leftarrow species(l) \Delta species(m)$   
       $Sign(l) \leftarrow Sign(l) + Sign(m)$   
    end if  
  end for  
  if  $l$  is positive and  $Species(l) = \emptyset$  then  
    return False  
  else  
    Add  $l$  to  $LoopSystem$   
     $Pivot(l) \leftarrow FirstSpecies(l)$   
    return True  
  end if  
end function
```

As an example, if we apply a swapping between K and MpK in the previous case of Fig. 3, i.e. changing the target of every edge that points to K to MpK (including self-loops) and vice-versa, we obtain the graph shown in Fig 5 for which there are 4 positive loops ($K \xrightarrow{R_1} MpK \xrightarrow{R_4} K$, $K \xrightarrow{R_1} MpK \xrightarrow{R_3} K$, $K \xrightarrow{R_3} MpK \xrightarrow{R_4} K$ and $K \xrightarrow{R_1} MK \xrightarrow{R_2} Mp \xrightarrow{R_3} K$). Changing the sign of K would then transform those positive circuits into negative ones and once again rule out the possibility for multistationarity. Note that because of the conditions of the original theorems of [30] on the diagonal of the Jacobian, only the vertices that have at least one incoming and one outgoing arc are considered for rewiring. In other words **INO** and **OUTO** are performed before permutations.

Because we did not find any efficient algorithm to propagate target permutation constraints, we restricted ourselves to simple permutations made of *one single swapping* between tow molecular species not eliminated by **INO** and **OUTO**, and systematically tried beforehand in a generate-and-test manner.

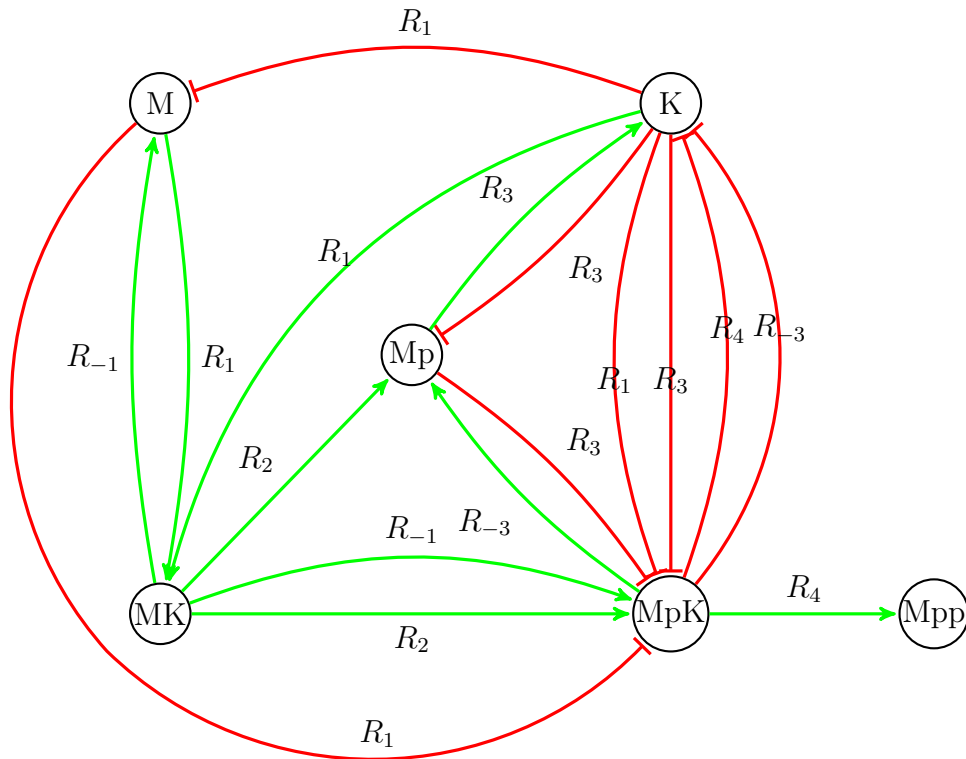

Figure 5: influence multigraph of $M + K \rightleftharpoons MK \rightarrow K + Mp \rightleftharpoons MpK \rightarrow K + Mpp$ for which arcs ending in K and MpK have been swapped. Self-loops are omitted for clarity

4. Evaluation on the BioModels Repository

4.1. Reaction Networks from BioModels

To evaluate the information brought by the previous graphical requirements for multistationarity and the performance of our graph rewriting algorithms, we downloaded the latest release of the BioModels database⁷ [4] and applied our method in a systematic way. First, a labelled influence multigraph is extracted as per Alg. 1. Out of the 640 curated models, the extraction led to 506 models with a non-trivial influence multigraph. The other models rely on events, assignment-rules, etc. to enforce their dynamics, or

⁷<http://biomodels.net/>, 31st release, dated 26th of June, 2017

simply do not contain reaction but flux-balance constraints, gene-regulations, etc. even after re-import of their ODE dynamics [6].

4.2. Results of the Graphical Algorithm

Conditions verified	Number of graphs	Nb of species		Computation time	
		avg.	max.	avg. (s)	max (s)
All graphs	506	21.24	430		
No negative circuit	70	6.87	57	< 0.01	0.05
No positive circuit	48	3.42	18	< 0.01	< 0.01
Cor. 2.3 2.4 2.5	105	6.22	46	< 0.01	< 0.01
Cor. 2.3 2.4 2.5 2.6	160	8.23	54	< 0.01	0.05
Cor. 2.3 2.4 2.5 2.6 2.7	180	8.38	54	5.90	980.1

Table 1: Analysis of the 506 sanitized reaction models from the curated branch of the BioModels repository. The table reports the proportion of models, and their size, for which the non-existence of multiple steady states is proved using Thomas’s positive circuit condition and using the refined conditions expressed in the corollaries described above. The computation times are given for the whole set of models. The maximum computation time is obtained for checking the last condition on model number 574.

Table 1 summarizes the results of our experiments. It is worth noting that the maximum running time of 50ms for checking our main graphical requirements is remarkably low. It concerns all models of the benchmark, including the largest model number 235 that contains 430 species and an influence multigraph of 1875 arcs.

Another observation is that not only the number of models for which the absence of multistationarity is proved more than doubles when using Corollaries 2.3 2.4 2.5 on top of Thomas’s simple condition, the models that are added are of much larger size than the one dealt with the original conditions. Indeed with the simple condition, only very small models with less than 18 species and linear reactions were shown to have no multistationarity, whereas the stronger conditions allow us to prove the absence of multistationarity in models of size up to 46 species and including non-linear reactions. This is far below the size of the biggest models of the BioModels repository (for which the existence of multiple steady states is generally unknown) but shows that the supplementary conditions do change the scope of use of the method.

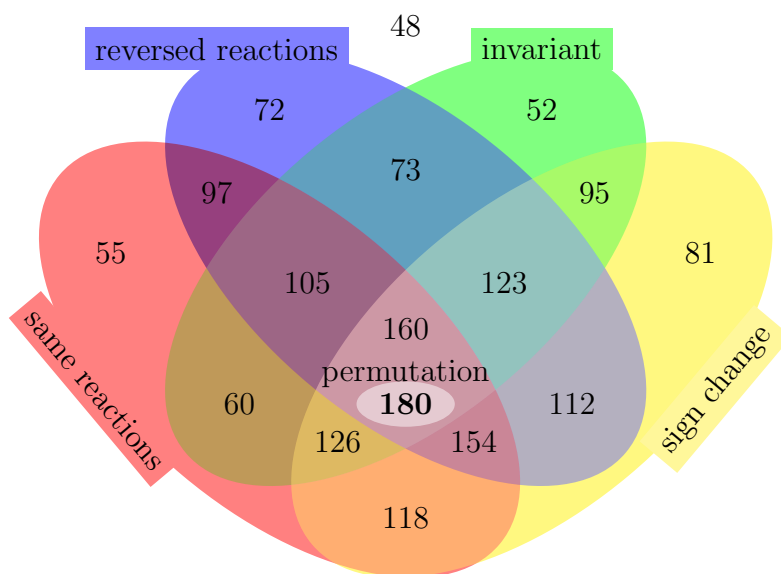

Figure 6: Number of models among the 506 curated reaction models of BioModels for which multistationarity can be ruled out by using respectively original Thomas’s positive circuit condition, Cor. 2.3 (no same reactions), 2.4 (no reversed reactions), 2.5 (no invariant) and 2.6 (sign change), plus 2.7 (permutation).

Fig. 6 shows a Venn diagram which details the contribution of the different graphical conditions. One can note that Cor. 2.5 was in fact useful in only eight of the new models found with the other two corollaries combined. The condition of Cor. 2.6 (sign change of all incoming edges to a set of vertices) is responsible for concluding to the absence of multistationarity in 55 more models, of size up to 54 species.

Corollary 2.7 allows us to rule out multistationarity in 20 new models, but with the same maximum size. Even with the restriction to single transpositions as explained above, the maximum running time on the whole benchmark becomes much higher than for the simpler conditions, by five orders of magnitude. However, the increase in the number of models for which multistationarity is proved not to be possible with this restricted strategy is relatively high (20) and thus encouraging for further improvements. Indeed, better heuristics or more efficient propagation of the permutation constraint, might lead to even more conclusive results on even larger size problems.

4.3. Practical Complexity

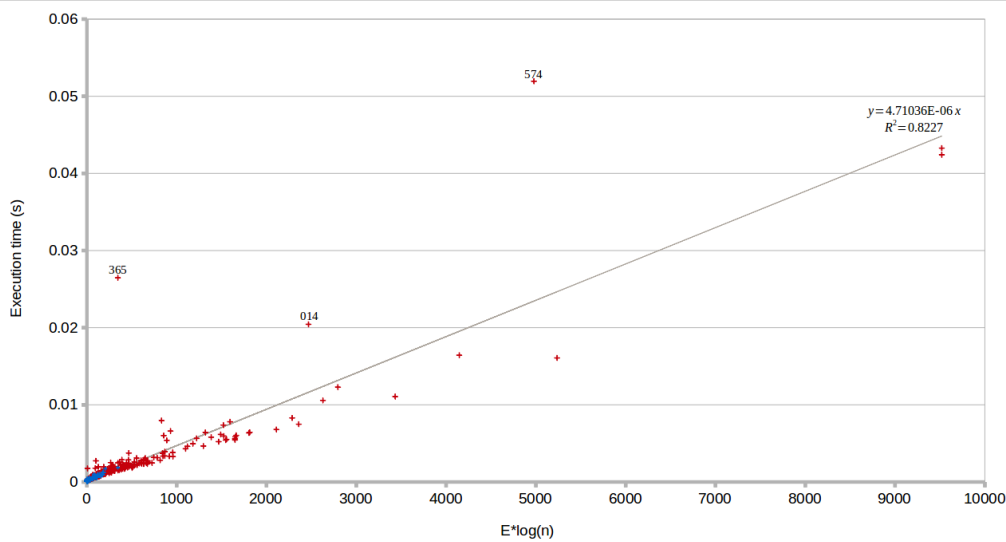

Figure 7: Execution time of the 506 models of BioModels tested with Alg. 2 and 4 with the conditions of Cor.2.3 2.4 2.5 2.6, relatively to the value of $e \log(n)$. The points in blue represent the models for which multistationarity is proved impossible, and the ones in red, those for which the algorithm exhibits a circuit that satisfies the conditions of the Corollaries.

The computation times presented in Table 1 with the use of the first four corollaries are far better than the theoretical complexity bound given in Prop 3.1. It is known that reducing the graph with only the 4 original rules IN0, IN1, OUT0 and OUT1 can be done with a time complexity in $\mathcal{O}(e \log(n))$ [21] where e is the number of edges in the graph. In Alg. 2, these simplification rules are in fact used with a higher priority than the rule INOUT $_i$ which are taken with the increasing order on i . Fig. 7 plots the computation time for each model relatively to the value of $e \log(n)$. The linear shape of the curve suggests that the empirical time complexity on BioModels is close to $\mathcal{O}(e \log(n))$, i.e. the complexity of the 4 original rules, and that the extra rules INOUT $_i$ with $i \geq 2$ (although used to conclude on non multistationarity in 65 over the 160 models) do not significantly increase the computation time apart from very few cases (models 014, 365 and 574) up to 50ms.

More precisely, the rule INOUT i is used with an average maximum value of $i = 3.5$ and 139 models do not use more than $i = 1$ which explains why it does not add much to the computation time. Models 014 and 365 use the rule INOUT i with $i = 36$ and $i = 98$ respectively which explains their higher computation time. Model 574 uses the rule INOUT i with $i = 8$ which is not uncommon but this graph is dense and each node has at least a degree of 3. In this case, the simple rules with $i = 0$ or $i = 1$ that give a complexity in $\mathcal{O}(e \log(n))$ are never used which basically explains why this model is the longest to check.

4.4. Comparison to the Jacobian-based Symbolic Computation Method

In [13], Feliu and Wiuf have presented a symbolic computation algorithm implemented in Maple 16 to directly check the existence of roots of some matrix determinant which is equivalent to a non-injectivity property implied by the existence of multiple steady states. That condition is in principle stronger than the graphical requirements we consider. Interestingly, they evaluated their algorithm on BioModels, with a version at that time of 365 curated models. Their method showed that 31.6% of the networks do not have multiple steady states, i.e. the same proportion as us (160 out of 506 networks) when checking the first four corollaries, but their Maple program failed by memory overflow on 8% of the networks whereas our maximum computation time is 0.05s.

Furthermore, the proportion of conclusive analyses raises in our case to 35,5% (180 out of 506) by using the last corollary but currently with a high computational cost and a restricted implementation of that condition.

5. Analysis of Multiple Phosphorylation Cycles and MAPK Signalling Models

5.1. Wang and Sontag's Futile Phosphorylation Cycles

In [13], Feliu and Wiuf also evaluated their method on the the r -site phosphorylation cycles of Wang and Sontag who showed the existence of multiple steady states in those networks for $r \geq 2$ [34]. The case $r = 2$, schematized in Fig. 8, was extensively studied by Markevich et al. in [22] in a series of models, numbered from 26 to 31 in the BioModels repository (see [15] for the model reduction relationships between these models found by subgraph epimorphisms), showing in all cases the existence of multiple steady states.

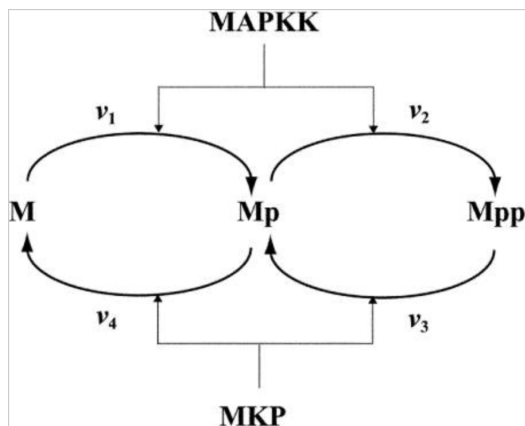
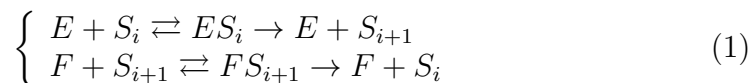

Figure 8: Fig. 1 of [22] displaying the general double-phosphorylation cycle involved in all the models studied by Markevich et al. and by Wang and Sontag [34].

The symbolic computation method used by Feliu and Wiuf grew rapidly in time as a function of the number r of phosphorylations, and became impractical after $r = 17$ for which it needed 1200 seconds. Our graphical method has a very low computational complexity on these networks, taking only 1.2s for $r = 1000$. It is worth noting that our method checks necessary conditions for the non-injectivity of the system whereas the symbolic method of Feliu and Wiuf directly determines that property. In both cases, though, one cannot conclude that the system does have multiple stationary states since the non-injectivity property is itself a necessary not sufficient condition.

Table 2 summarizes our results. The first two computation time columns refer to the original model of Wang and Sontag in which each phosphorylation and dephosphorylation transformation is modelled by three reactions with mass action law kinetics with an explicit representation of the intermediary complexes, by repeating the following pattern:



This gives the following differential equations:

$$\begin{aligned}
\frac{dS_0}{dt} &= -k_{\text{on}_0}S_0E + k_{\text{off}_0}ES_0 + l_{\text{cat}_0}FS_1 \\
\frac{dS_i}{dt} &= -k_{\text{on}_i}S_iE + k_{\text{off}_i}ES_i + k_{\text{cat}_{i-1}}ES_{i-1} \\
&\quad -l_{\text{on}_{i-1}}S_i f + l_{\text{off}_{i-1}}FS_i + l_{\text{cat}_i}FS_{i+1} \quad , i = 1, \dots, n-1 \\
\frac{dES_j}{dt} &= k_{\text{on}_j}S_jE - (k_{\text{off}_j} + k_{\text{cat}_j})ES_j \quad , j = 0, \dots, n-1 \\
\frac{dFS_k}{dt} &= l_{\text{on}_{k-1}}S_k f - (l_{\text{off}_{k-1}} + l_{\text{cat}_{k-1}})FS_k \quad , k = 1, \dots, n
\end{aligned}$$

The computation times given in Table 2 indicate that, on these networks, our method has an empirical complexity of the order of $10^{-3}r^2$.

The third computation time column refers to the writing of the dephosphorylations with two intermediate complexes, as follows:

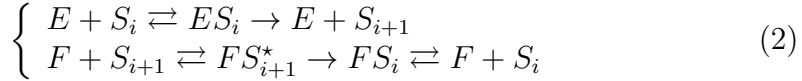

This writing of the dephosphorylations corresponds to the first model of Markevich et al. [22]. On this reaction pattern (2), our graph algorithm has execution times similar to those obtained on reaction pattern (1). This is due to the resemblance of their influence multigraphs. Nevertheless, the rule INOUT_i is used here with $i \leq 12$, while on model pattern (1) it is used with value at most 9. This is responsible for a slight difference in response time.

The second model of Markevitch et al. [22] is a reduction of the previous model using Michaelian kinetics. The intermediary complexes are eliminated but the writing of the kinetics for the dephosphorylation of Mp by phosphatase MKP3, named v_4 in the original article [22], is not a naive Michaelis-Menten kinetics but the following one:

$$v_4 = \frac{k_4^{\text{cat}} \cdot [MKP3]_{\text{tot}} \cdot [Mp]/K_{m3}}{(1 + [Mpp]/K_{m3} + [Mp]/K_{m4} + [M]/K_{m5})}$$

Mpp appears as inhibitor in this kinetic expression to represent the sequestration of the phosphatase in the reversible last step of dephosphorylation, Such a sequestration results in a negative influence of Mpp on M and a positive influence of Mpp on Mp (i.e., a positive term in $\frac{\partial Mp}{\partial Mpp}$) as this reaction

r	Jacobian Method [13]	Graphical Method (Alg 2 & 4)		
	model (1)	(1)	(2)	(3)
1	4	0.3	1.6	0.6
2	75	0.5	2	1
3	44	1	2	1
4	81	1	3	1
5	191	1	4	1
6	256	1	4	1
7	444	1	5	1
8	795	2	5	1
9	1169	2	6	2
10	2195	2	6	2
11	3998	2	6	2
12	7696	2	7	2
13	15180	2	7	2
14	32180	3	7	2
15	67740	3	7	2
16	171700	3	8	2
17	1199000	4	8	2
50	×	12	17	4
100	×	26	40	6
500	×	343	549	34
1000	×	1200	1874	98

Table 2: Execution times given in milliseconds for the analysis of the r -site phosphorylation system of [34], first as reported in [13] for the Jacobian method using symbolic computation, then obtained with our graphical algorithm on the same model and on two variants concerning the writing of the dephosphorylation and phosphorylation reactions.

consumes Mp to produce M. Intuitively the fact that Mpp can actively sequester the phosphatase MKP3 makes it inhibit the dephosphorylation of Mp and therefore stabilizes Mp. Therefore, while the positive circuit between Mp and Mpp by v_2 and v_3 that can be easily seen from Fig. 8 is immediately rule out since v_2 and v_3 are opposite reactions, the complex Michaelian kinetics of [22] gives rise to a completely different positive circuit between those two species (with kinetics v_4 and v_2). This circuit cannot be removed by

sign-changes or any single swap and is indeed responsible for the appearance of bistability in those models.

The fourth computation time column refers to that model structure, with catalytic reactions instead of intermediary complexes, but using mass action law (or simple Michaelis-Menten) kinetics, with the following pattern:

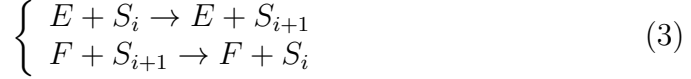

The differential equations for this pattern with simple Michaelis-Menten kinetics are as follows :

$$\begin{aligned} \frac{dS_0}{dt} &= -\frac{V_0 E S_0}{K_0 + S_0} + \frac{V_0^* f S_1}{K_0^* + S_1} \\ \frac{dS_i}{dt} &= -\frac{V_i E S_i}{K_i + S_i} + \frac{V_{i-1} f S_{i-1}}{K_{i-1} + S_{i-1}} \\ &\quad + \frac{V_i^* f S_{i+1}}{K_i^* + S_{i+1}} - \frac{V_{i-1}^* f S_i}{K_{i-1}^* + S_i} \quad , i = 1, \dots, n-1 \\ \frac{dS_n}{dt} &= \frac{V_{n-1} E S_{n-1}}{K_{n-1} + S_{n-1}} - \frac{V_{n-1}^* f S_n}{K_{n-1}^* + S_n} \end{aligned}$$

In this modelling of the system, the possibilities of multistationarity disappear, and this is shown by the result of our graphical algorithm. On large instances, the computation time is also significantly lower. This is because the graph does not contain any positive cycle satisfying our conditions, and the graph algorithm has only to remove nodes using the rule INOUT_i with $i \leq 1$.

5.2. MAPK Signalling Models

Double phosphorylation cycles are integral parts of MAPK signalling cascades and one might expect to observe multistationarity in MAPK models. However, as shown in the previous section, this depends on the way the phosphorylation and dephosphorylation reactions are modeled.

Model 270 of the BioModels database describes a complete Epo-induced ERK signalling cascade, from receptor binding to cell fate decision, corresponding to the *distributive* model of [26], schematized in Fig. 9. It includes four reversible double-phosphorylation stages (MEK2, MEK1, ERK1 and ERK2) and many dummy variables introduced at the beginning of the cascade to encode delay ordinary equations into simple ODEs. The resulting reaction model has 33 species and 42 reactions, and leads to a labelled

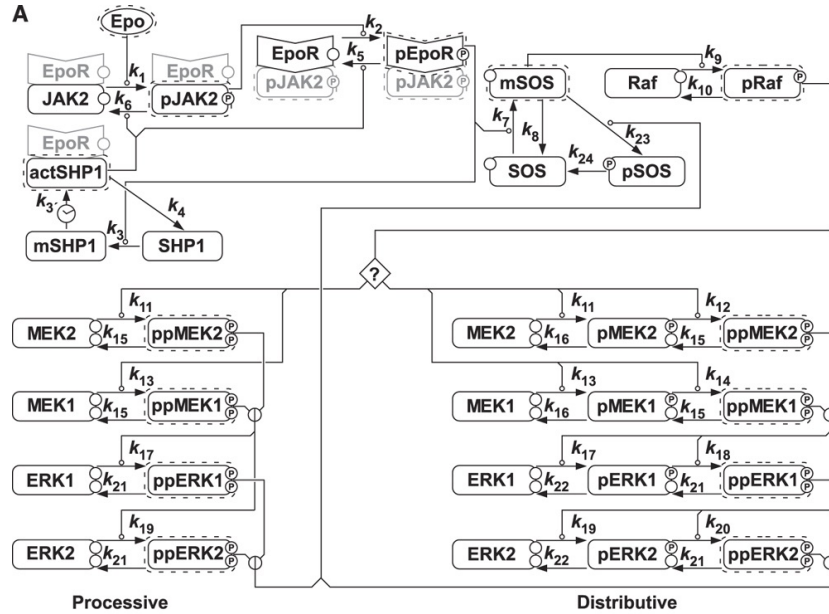

Figure 9: Figure 1A of [26], on the right is the distributive model encoded as model 270 in the BioModels repository. Several other variables appear in the model because of the encoding with ODEs of Delay Differential Equations involved close to the receptor.

influence multigraph containing 126 arcs with many positive and negative feedback loops.

During the run of Alg. 2, only 2 paths are removed thanks to one of the 9 conservation laws (Cor. 2.5), but 58 are removed thanks to Cor. 2.3 and 2.4, resulting in no single positive feedback loop satisfying the conditions of our theorem.

The fact that multistationarity is not possible for such a model is consistent with the data shown by the authors in the article, i.e. functional dose-response diagrams without hystereses. This is however not evident, nor perhaps expected, from the model itself since memory effects resulting in hysteresis might have been possible at many different places in the network due to the dephosphorylation loops. However, as explained in the previous section with model 3 this is not the case when simple Michaelis-Menten kinetics are used.

These examples show that the existence of multiple steady states in reaction networks is sensitive to the explicit representation of the intermediate

complexes in enzymatic reactions, or at least to the explicit inclusion of their inhibitors (by sequestration) in the kinetics. Interestingly, our refined conditions are similarly sensitive to these subtle modelling choices and allow us to conclude differently according to the impact of the writing of the reactions on the multistationarity properties of the system. The role of intermediate complexes in multistationarity was analysed in detail in [14]. In particular, it was shown that if the network does not have conservation laws, then multistationarity cannot arise after the introduction of intermediate complexes.

These remarks also go in the same direction to what has been observed for oscillations in the MAPK cascade again, where the absence of complexation removes the negative feedbacks going upwards in the cascade and therefore the negative feedback loops and the corresponding possibility of oscillations [33]. If the intermediary complexes are explicitly represented, then oscillations can be found [25], without any external negative feedback reaction such as receptor desensitization [20]. In many other networks in BioModels, Alg. 2 actually shows as side-effect the existence of numerous negative feedback loops.

6. Conclusion

This experiment is, to our knowledge, the first systematic evaluation of graphical requirements for multistationarity in the reaction networks of model repositories in large scale. We have shown that Thomas’s necessary condition for multistationarity, and its refinement for reaction models given in [29], can be implemented with a graph rewriting algorithm that brings useful information for many models in BioModels, by proving the non-existence of multiple steady states independently of the parameter values and of the precise form of the rate functions. Though the original Thomas’s conditions show the absence of multistationarity in some small models, the refined conditions are conclusive in many more cases: 180 vs 48, including much bigger models: up to 54 vertices vs 18. Furthermore this is achieved at a remarkably low computational cost, below 0.05 second per network for the main conditions, even on models with several hundreds of molecular species and thousands of influence arcs, currently out of reach of symbolic computation methods.

It is worth noting that our graph-theoretic algorithm is not limited to reaction systems with mass action law kinetics, but relies on a simple symbolic derivation algorithm for computing an over-approximation of the signs

of the partial derivatives in the Jacobian matrix. In case of indeterminacy of the sign, both signs are assumed which may lead to the existence of circuits that would have been ruled out by a more accurate determination of the sign. Our graphical algorithm could also be improved by a more efficient and complete use of the condition dealing with target species permutations, for instance by recourse to constraint propagation algorithms [7] instead of the current generate-and-test procedure for single swappings. This might further increase the number of conclusive cases. Another way would be to use the condition noted (*) in [1] to rule out the positive circuits that do not intersect another positive circuit on a species-to-reaction path, which is necessary for multistationarity.

Since our procedure, and more precisely Alg. 1, goes through an import of the ODE system and infers a reaction network, it can be readily used on dynamical systems that do not stem from reaction networks but may exhibit similar symmetries. Such use of the refined conditions in general ODE systems would probably benefit much less from the structural conditions added on top of Thomas's rules, but by identifying similar terms in the ODEs, our algorithm should be able to automatically prove the absence of multistationarity in interesting cases, as also suggested in [1].

A comparison to Feinberg's CRNT-based approaches would also be interesting, by considering the different approaches summarized for instance in Table 3 of [13]. In particular, our circuit conditions on the influence multigraph depend on the signs of the entries of the Jacobian matrix but are independent of not only the values of the kinetic parameters, but also of the form of the reaction rate functions which can be any partially differentiable function, i.e. without any monotonicity, non-autocatalytic, or such restriction.

Finally, this study focussed on multistationarity, but we saw that most models of the benchmark also have negative circuits. A systematic study of the oscillation conditions in reaction model repositories, possibly using a similar theoretical refinement of Thomas-Snoussi's necessary conditions for sustained oscillations [27], would be worth investigating as natural systems indeed provide many oscillators and even models not conceived to oscillate have been shown capable of exhibiting unexpected sustained oscillations in non-standard conditions [25].

Acknowledgments.

This work has been supported by the bilateral project ANR-17-CE40-0036 SYMBIONT (<https://www.symbiont-project.org>). We are also grateful to the reviewers for their useful comments for improving the presentation of our results.

References

References

- [1] Banaji, M., Craciun, G., 2009. Graph-theoretic approaches to injectivity and multiple equilibria in systems of interacting elements. *Communications in Mathematical Sciences* 7, 867–900.
- [2] Banaji, M., Craciun, G., 2010. Graph-theoretic criteria for injectivity and unique equilibria in general chemical reaction systems. *Advances in Applied Mathematics* 44, 168–184.
- [3] Calzone, L., Fages, F., Soliman, S., 2006. BIOCHAM: An environment for modeling biological systems and formalizing experimental knowledge. *Bioinformatics* 22, 1805–1807. doi:10.1093/bioinformatics/btl1172.
- [4] Chelliah, V., Laibe, C., Novère, N., 2013. Biomodels database: A repository of mathematical models of biological processes, in: Schneider, M.V. (Ed.), *In Silico Systems Biology*. Humana Press. volume 1021 of *Methods in Molecular Biology*, pp. 189–199. doi:10.1007/978-1-62703-450-0_10.
- [5] Craciun, G., Feinberg, M., 2006. Multiple equilibria in complex chemical reaction networks: II. the species-reaction graph. *SIAM Journal on Applied Mathematics* 66, 1321–1338.
- [6] Fages, F., Gay, S., Soliman, S., 2015. Inferring reaction systems from ordinary differential equations. *Theoretical Computer Science* 599, 64–78. doi:10.1016/j.tcs.2014.07.032.
- [7] Fages, F., Lal, A., 2006. A constraint programming approach to cutset problems. *Journal Computers and Operations Research* 33:10, 2852–2865.

- [8] Fages, F., Martinez, T., Rosenblueth, D., Soliman, S., 2018. Influence networks compared with reaction networks: Semantics, expressivity and attractors. *IEEE/ACM Transactions on Computational Biology and Bioinformatics* doi:10.1109/TCBB.2018.2805686.
- [9] Fages, F., Martinez, T., Soliman, S., 2017. *BIOCHAM v4.0 User's Manual*. Inria. URL: <http://lifeware.inria.fr/biocham4/>.
- [10] Fages, F., Soliman, S., 2008a. Abstract interpretation and types for systems biology. *Theoretical Computer Science* 403, 52–70. doi:10.1016/j.tcs.2008.04.024.
- [11] Fages, F., Soliman, S., 2008b. From reaction models to influence graphs and back: a theorem, in: *Proceedings of Formal Methods in Systems Biology FMSB'08*, Springer-Verlag. doi:10.1007/978-3-540-68413-8_7.
- [12] Feinberg, M., 1977. Mathematical aspects of mass action kinetics, in: *Lapidus, L., Amundson, N.R. (Eds.), Chemical Reactor Theory: A Review*. Prentice-Hall. chapter 1, pp. 1–78.
- [13] Feliu, E., Wiuf, C., 2013a. A computational method to preclude multi-stationarity in networks of interacting species. *Bioinformatics* 29, 2327–2334.
- [14] Feliu, E., Wiuf, C., 2013b. Simplifying biochemical models with intermediate species. *Journal of The Royal Society Interface* 10.
- [15] Gay, S., Soliman, S., Fages, F., 2010. A graphical method for reducing and relating models in systems biology. *Bioinformatics* 26, i575–i581. doi:10.1093/bioinformatics/btq388. special issue ECCB'10.
- [16] Hucka, M., Hoops, S., Keating, S.M., Nicolas, L.N., Sahle, S., Wilkinson, D., 2008. Systems biology markup language (SBML) level 2: Structures and facilities for model definitions. *Nature Precedings* doi:10.1038/npre.2008.2715.1.
- [17] Ivanova, A.N., 1979. Conditions for the uniqueness of the stationary states of kinetic systems, connected with the structures of their reaction mechanisms. *Kinet. Katal.* 20, 1019–1023.

- [18] Ivanova, A.N., Tarnopolskii, B.L., 1979. One approach to the determination of a number of qualitative features in the behavior of kinetic systems, and realization of this approach in a computer (critical conditions, autooscillations). *Kinet. Katal.* 20, 1541–1548.
- [19] Kaltenbach, H.M., 2012. A unified view on bipartite species-reaction and interaction graphs for chemical reaction networks. [arXiv:1210.0320](https://arxiv.org/abs/1210.0320). [arXiv:1210.0320](https://arxiv.org/abs/1210.0320).
- [20] Kholodenko, B.N., 2000. Negative feedback and ultrasensitivity can bring about oscillations in the mitogen-activated protein kinase cascades. *European Journal of Biochemistry* 267, 1583–1588. doi:10.1046/j.1432-1327.2000.01197.x.
- [21] Levy, H., Low, D.W., 1988. A contraction algorithm for finding small cycle cutsets. *Journal of algorithms* 9, 470–493.
- [22] Markevich, N.I., Hoek, J.B., Kholodenko, B.N., 2004. Signaling switches and bistability arising from multisite phosphorylation in protein kinase cascades. *Journal of Cell Biology* 164, 353–359. doi:10.1083/jcb.200308060.
- [23] Nabli, F., Martinez, T., Fages, F., Soliman, S., 2016. On enumerating minimal siphons in petri nets using CLP and SAT solvers: Theoretical and practical complexity. *Constraints* 21, 251–276. doi:10.1007/s10601-015-9190-1.
- [24] Pardalos, P.M., Qian, T., Resende, M.G., 1999. A greedy randomized adaptive search procedure for the feedback vertex set problem. *Journal of Combinatorial Optimization* 2, 399–412.
- [25] Qiao, L., Nachbar, R.B., Kevrekidis, I.G., Shvartsman, S.Y., 2007. Bistability and oscillations in the huang-ferrell model of mapk signaling. *PLoS Computational Biology* 3, 1819–1826.
- [26] Schilling, M., Maiwald, T., Hengl, S., Winter, D., Kreutz, C., Kolch, W., Lehmann, W.D., Timmer, J., Klingmüller, U., 2009. Theoretical and experimental analysis links isoform-specific erk signalling to cell fate decisions. *Molecular Systems Biology* 5. doi:10.1038/msb.2009.91, [arXiv:http://msb.embopress.org/content/5/1/334.full.pdf](http://msb.embopress.org/content/5/1/334.full.pdf).

- [27] Snoussi, E.H., 1998. Necessary conditions for multistationarity and stable periodicity. *Journal of Biological Systems* 6, 3–9. doi:10.1142/S0218339098000042.
- [28] Soliman, S., 2012. Invariants and other structural properties of biochemical models as a constraint satisfaction problem. *Algorithms for Molecular Biology* 7. doi:10.1186/1748-7188-7-15.
- [29] Soliman, S., 2013. A stronger necessary condition for the multistationarity of chemical reaction networks. *Bulletin of Mathematical Biology* 75, 2289–2303. doi:10.1007/s11538-013-9893-7.
- [30] Soulé, C., 2003. Graphic requirements for multistationarity. *ComplexUs* 1, 123–133.
- [31] Tarjan, R., 1972. Depth-first search and linear graph algorithms. *SIAM Journal on Computing* 1, 146–160. doi:10.1137/0201010.
- [32] Thomas, R., 1981. On the relation between the logical structure of systems and their ability to generate multiple steady states or sustained oscillations. *Springer Ser. Synergetics* 9, 180–193.
- [33] Ventura, A.C., Sepulchre, J.A., Merajver, S.D., 2008. A hidden feedback in signaling cascades is revealed. *PLoS Computational Biology* 4, e1000041. doi:10.1371/journal.pcbi.1000041.
- [34] Wang, L., Sontag, E., 2008. On the number of steady states in a multiple futile cycle. *Journal of Mathematical Biology* 57, 29–52.

Afterword in memoriam of René Thomas

It was under the sun of the University of Marseille, at the CIRM in 2008, that the second author met René Thomas and his wife, in the friendly atmosphere of a summer school where René participated to all talks giving advices with extreme modesty and continuing providing deep insights during the traditional walk to the Callanques. In his talk, he mentioned that the gene interactions he had always been considering were in fact influences, and that such regulatory networks should be called influence networks. At that time, we were more interested in biochemical reaction networks for which Thomas’s conditions generally provide no information. That was the starting point of an adventure that led the third author to refine Thomas’s conditions

for reaction networks, and the first author to implement and successfully apply them in large scale, showing the richness of René Thomas's intuitions across so many decades of active research in mathematical biology.